

**VM Series
Video Measurement System
Quick Start User Manual**

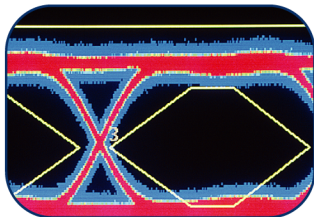

071-2091-01

Tektronix

**VM Series
Video Measurement System
Quick Start User Manual**

Copyright © Tektronix. All rights reserved. Licensed software products are owned by Tektronix or its subsidiaries or suppliers, and are protected by national copyright laws and international treaty provisions.

Tektronix products are covered by U.S. and foreign patents, issued and pending. Information in this publication supersedes that in all previously published material. Specifications and price change privileges reserved.

TEKTRONIX and TEK are registered trademarks of Tektronix, Inc.

Contacting Tektronix

Tektronix, Inc.
14200 SW Karl Braun Drive
P.O. Box 500
Beaverton, OR 97077
USA

For product information, sales, service, and technical support:

- In North America, call 1-800-833-9200.
- Worldwide, visit www.tektronix.com to find contacts in your area.

Warranty 2

Tektronix warrants that this product will be free from defects in materials and workmanship for a period of one (1) year from the date of shipment. If any such product proves defective during this warranty period, Tektronix, at its option, either will repair the defective product without charge for parts and labor, or will provide a replacement in exchange for the defective product. Parts, modules and replacement products used by Tektronix for warranty work may be new or reconditioned to like new performance. All replaced parts, modules and products become the property of Tektronix.

In order to obtain service under this warranty, Customer must notify Tektronix of the defect before the expiration of the warranty period and make suitable arrangements for the performance of service. Customer shall be responsible for packaging and shipping the defective product to the service center designated by Tektronix, with shipping charges prepaid. Tektronix shall pay for the return of the product to Customer if the shipment is to a location within the country in which the Tektronix service center is located. Customer shall be responsible for paying all shipping charges, duties, taxes, and any other charges for products returned to any other locations.

This warranty shall not apply to any defect, failure or damage caused by improper use or improper or inadequate maintenance and care. Tektronix shall not be obligated to furnish service under this warranty a) to repair damage resulting from attempts by personnel other than Tektronix representatives to install, repair or service the product; b) to repair damage resulting from improper use or connection to incompatible equipment; c) to repair any damage or malfunction caused by the use of non-Tektronix supplies; or d) to service a product that has been modified or integrated with other products when the effect of such modification or integration increases the time or difficulty of servicing the product.

THIS WARRANTY IS GIVEN BY TEKTRONIX WITH RESPECT TO THE PRODUCT IN LIEU OF ANY OTHER WARRANTIES, EXPRESS OR IMPLIED. TEKTRONIX AND ITS VENDORS DISCLAIM ANY IMPLIED WARRANTIES OF MERCHANTABILITY OR FITNESS FOR A PARTICULAR PURPOSE. TEKTRONIX' RESPONSIBILITY TO REPAIR OR REPLACE DEFECTIVE PRODUCTS IS THE SOLE AND EXCLUSIVE REMEDY PROVIDED TO THE CUSTOMER FOR BREACH OF THIS WARRANTY. TEKTRONIX AND ITS VENDORS WILL NOT BE LIABLE FOR ANY INDIRECT, SPECIAL, INCIDENTAL, OR CONSEQUENTIAL DAMAGES IRRESPECTIVE OF WHETHER TEKTRONIX OR THE VENDOR HAS ADVANCE NOTICE OF THE POSSIBILITY OF SUCH DAMAGES.

Table of Contents

General Safety Summary	iii
Preface	v
Key Features	v
Supported Products	v
Documentation	vi
Software Upgrades	vi
Conventions Used in this Manual	vii
Installing Your Instrument	1
Standard Accessories	1
Recommended Accessories	3
Operating Requirements	4
Powering On the Instrument	4
Powering Off the Instrument	5
Removing the Power	5
Connecting to a Network	5
Getting Acquainted with Your Instrument	6
Front Panel	6
Side and Rear Panels	7
Input Connection Requirements – Options SD/HD	8
Input Connection Requirements – Option VGA	8
Connecting Input Signals	9
Signal Path Compensation	20
Sync Pickoff Compensation – VM6000 and DPO7000 Series, Options SD/HD Only	20
Sync Pickoff Compensation – VM5000 and TDS5000 Series, Options SD/HD Only	21
About the Matrix Test Signal	24
Starting the VM Series system Software	26
The VM Series System Software User Interface	28
Procedure for Taking Measurements	30
Configuring the DUT — Option VGA	30
Setting the Input Signal Format – Options SD/HD	32
Setting the Input Signal Format – Option VGA	34
Selecting Measurements	37
Setting the Measurement Run Operations	38
Taking and Viewing Measurements	41
Using the Oscilloscope	42
Troubleshooting Signal Problems	44
Applications	48
Simple Color Bars Measurement – Options SD/HD	48
Simple Color Bars Measurement – Option VGA	50
Displaying Relative to Reference Color Bar Measurements	54
Displaying Color Bar Measurements with Limit Testing	59
Performing Limit Testing with Two Measurements	64

Table of Contents

Taking Measurements Across Multiple Lines	70
Displaying the Input Signal as a Picture	75
Displaying the Input Signal in a Vectorscope Window – Options SD/HD Only	77
Index	

General Safety Summary

Review the following safety precautions to avoid injury and prevent damage to this product or any products connected to it.

To avoid potential hazards, use this product only as specified.

Only qualified personnel should perform service procedures.

While using this product, you may need to access other parts of a larger system. Read the safety sections of the other component manuals for warnings and cautions related to operating the system.

To Avoid Fire or Personal Injury

Use Proper Power Cord. Use only the power cord specified for this product and certified for the country of use.

Connect and Disconnect Properly. Do not connect or disconnect probes or test leads while they are connected to a voltage source.

Connect and Disconnect Properly. De-energize the circuit under test before connecting or disconnecting the current probe.

Ground the Product. This product is grounded through the grounding conductor of the power cord. To avoid electric shock, the grounding conductor must be connected to earth ground. Before making connections to the input or output terminals of the product, ensure that the product is properly grounded.

Observe All Terminal Ratings. To avoid fire or shock hazard, observe all ratings and markings on the product. Consult the product manual for further ratings information before making connections to the product.

The inputs are not rated for connection to mains or Category II, III, or IV circuits.

Do not connect a current probe to any wire that carries voltages above the current probe voltage rating.

Power Disconnect. The power switch disconnects the product from the power source. See instructions for the location. Do not block the power switch; it must remain accessible to the user at all times.

Do Not Operate Without Covers. Do not operate this product with covers or panels removed.

Do Not Operate With Suspected Failures. If you suspect that there is damage to this product, have it inspected by qualified service personnel.

Avoid Exposed Circuitry. Do not touch exposed connections and components when power is present.

Use Proper Fuse. Use only the fuse type and rating specified for this product.

Do Not Operate in Wet/Damp Conditions.

Do Not Operate in an Explosive Atmosphere.

Keep Product Surfaces Clean and Dry.

Provide Proper Ventilation. Refer to the manual's installation instructions for details on installing the product so it has proper ventilation.

Terms in this Manual

These terms may appear in this manual:



WARNING. Warning statements identify conditions or practices that could result in injury or loss of life.



CAUTION. Caution statements identify conditions or practices that could result in damage to this product or other property.

Symbols and Terms on the Product

These terms may appear on the product:

- DANGER indicates an injury hazard immediately accessible as you read the marking.
- WARNING indicates an injury hazard not immediately accessible as you read the marking.
- CAUTION indicates a hazard to property including the product.

The following symbol(s) may appear on the product:

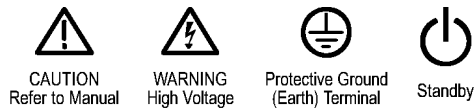

Preface

This manual describes the installation and basic operation of the VM Series Video Measurement System. For more detailed information, see the online help on your instrument and the *VM Series Video Measurement System User Manual*.

Key Features

The VM Series Video Measurement System is a high-performance automated video measurement system based on an oscilloscope platform. Key features include:

- Fast, accurate, and reliable video measurements
- Comprehensive component analog signal analysis
- Automated testing of PC and DTV consumer video devices
- Automated VESA compliance testing for PC graphics devices
- Support for SD, HDTV, and RGBHV component analog video formats via options
- Picture, Vector, and Waveform displays
- Integrated Pass-Fail limit testing
- Companion Test Signal packages
- GPIB remote control and LAN connectivity
- Complete oscilloscope functionality

Supported Products

The VM Series Video Measurement System can be purchased as a software and hardware package. You can install the package on Tektronix oscilloscopes you already own, or to upgrade VM5000HD or VM5000 systems. The products supported by the VM Series Video Measurement System are listed in the following table. Note that some products do not support Option VGA.

Instrument	Supported options
VM5000HD	SD, HD, and VGA
VM5000	SD, HD, and VGA
TDS5104	SD, HD, and VGA
TDS5104B	SD, HD, and VGA
TDS5054	SD and HD
TDS5054B	SD and HD
DPO7254	SD, HD, and VGA
DPO7104	SD, HD, and VGA
DPO7054	SD and HD
DPO7354	SD, HD, and VGA

Documentation

To read about	Use these documents
Installation and operation (overviews)	<i>VM Series Video Measurement System Quick Start User Manual</i> . The quick start user manual contains general information about how to put your instrument into service, guides to user interface controls, and application examples.
In-depth operation and user interface help	<i>VM Series Video Measurement System User Manual</i> . The user manual contains detailed information about how to operate the instrument, including how measurements are calculated, and specifications. <i>VM Series Video Measurement System Online Help</i> . Access the online help from the software Help menu for information on controls and elements on the display.
Programming Commands	<i>VM Series Video Measurement System Programmer Manual</i> . The programming commands that apply specifically to the VM Series Video Measurement System are located in a PDF file located on the VM Series Video Measurement System product software CD. The programmer manual for the oscilloscope is a PDF file on the oscilloscope product software CD.
Oscilloscope Usage	Refer to the oscilloscope documentation for full information on using the oscilloscope features of the oscilloscope.
User Service and Performance Verification	Refer to the service manual for the oscilloscope.

Software Upgrades

Periodic software upgrades may become available. The software is only operational if you have a valid option key for the specific oscilloscope model and serial number.







To check for upgrades:

1. Go to www.tektronix.com/software on the Tektronix Web site.
2. Enter the product name (VM Series) to find available software upgrades.

Conventions Used in this Manual

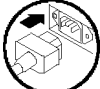
This manual describes how to operate VM Series Video Measurement System Options SD, HD, and VGA. Although the methods of operation are identical in all three options, there are some differences in features; most notably the available measurements. Additionally, the VM Series Video Measurement System software and accessories can be purchased for installation on select Tektronix oscilloscopes. Where there are differences in configuration or application, they are identified in the text by the option to which they apply or by the oscilloscope platform where appropriate. Where there are differences in the screen display, both versions are shown (Option SD/HD and Option VGA).

The following icons are used throughout this manual.

Sequence Step	Front panel power	Connect power	Network	PS2	SVGA	USB
						

Installing Your Instrument

This section contains information on installing your instrument. Unpack the instrument and check that you received all items listed as Standard Accessories. Check that you also received any of the listed Recommended Accessories that you ordered with your instrument. Check the Tektronix Web site (www.tektronix.com) for the most current information.

Standard Accessories

VM Series Video Measurement System Standard Accessories

Accessory	Tektronix part number
<i>VM Series Video Measurement System Quick Start User Manual</i> in English, and French, German, Spanish, Traditional Chinese, Simplified Chinese, or Japanese translation if a language option was ordered	071-2091-XX
<i>VM Series Video Measurement System User Manual</i>	071-2103-XX
<i>VM Series Video Measurement System Programmer Manual</i> in PDF format on VM Series Video Measurement System Product Software CD	071-2104-XX
DPO7000, DSA70000 and DPO70000 Digital Phosphor Oscilloscopes Quick Start User Manual	071-1733-XX
<i>VM Series Video Measurement System Product Software</i> CD-ROM that includes VM Series Video Measurement System product software with online help, VM Series Video Measurement System User Manual PDF, VM Series Video Measurement System Quick Start User Manual PDF, and release notes	020-2767-XX
DPO7000, DSA70000 and DPO70000 Product Software CD	020-2693-XX
DPO7000, DSA70000 and DPO70000 Operating System Restore CD	020-2659-XX
Tek Restore Software License for Recovery Media/OS Restore	—
Optional Applications Software CD and Documentation Kit	020-2700-XX
Getting Started with OpenChoice Solutions Kit	020-2513-XX
DPO7000, DSA70000 and DPO70000 Online Help (part of the product software)	—
DPO7000, DSA70000 and DPO70000 Performance Verification (a pdf file on the Product Software CD)	—
DPO7000, DSA70000 and DPO70000 Programmer Online Guide (files on the Product Software CD)	—
NIST, Z540-1, and ISO9000 Calibration Certificate	—
Mouse, optical	119-7054-XX
Mini-keyboard, USB with 2-port Hub	118-7083-XX
Front Cover	200-4963-XX
Accessory Pouch	016-1966-XX
Probe Calibration and Deskew Fixture, with instructions	067-0405-XX
Nero OEM Software CD	063-3781-XX
TPA-BNC Service Replacement Adapter Option SD & HD — 1 adapter Option VGA — 4 adapters	013-0355-02
Precision 75 Ω terminations (4)	011-0102-XX

VM Series Video Measurement System Standard Accessories (cont.)

Accessory	Tektronix part number
BNC "T" connectors (4)	103-0030-XX
Sync pickoff cable (Option SD/HD only)	012-1680-XX
VGA to 5X BNC cable (6 in. long) (Option VGA only)	174-5147-XX
VGA to 5X BNC cable (3 ft. long) (Option VGA only)	174-5216-XX
RGBHV Measurement Interface Unit (Option VGA only)	012-1685-XX
RS-232 RGBHV MIU Control Cable (Option VGA only)	012-1692-XX
BNC-to-Binding Post Adapters (2) (Option VGA Only)	011-0183-00
2.21 k Ω resistor	322-3226-00
301 Ω resistor	322-3143-00
VGA Sync Combiner cable	012-1664-XX
Power Cord	
North America (Option A0)	161-0104-00
Universal Euro (Option A1)	161-0104-06
United Kingdom (Option A2)	161-0104-07
Australia (Option A3)	161-0104-05
Switzerland (Option A5)	161-0167-00
Japan (Option A6)	161-A005-00
China (Option A10)	161-0306-00
India (Option A11)	161-0324-00
No power cord or AC adapter (Option A99)	—

Recommended Accessories

Your instrument may also include optional recommended accessories. Verify that the optional accessories you ordered are included with your instrument.

VM Series Video Measurement System Recommended Accessories ¹

Accessory	Tektronix Part number
VM Series Signal Sources, 480 Line DVD and 580 Line DVD	020-2770-XX
VM Series Signal Sources, Standard Definition Elementary Streams	020-2771-XX
VM Series Signal Sources, Advanced TV Elementary Streams	020-2772-XX
VM Series Signal Sources, ATSC Transport Streams	020-2773-XX
VM Series Signal Sources, Baseband Test Signals	020-2774-XX
VM Series Signal Sources, PC Bitmap Graphics Test Signal Files	020-2775-XX
VM Series Signal Sources, H.264 SD & HD Streams	020-2776-XX
<i>DPO70000 Series Digital Phosphor Oscilloscopes Service Manual</i>	071-1174-XX
Transit case	016-1942-00
Probe calibration, compensation, and deskew adapter	067-0405-XX
Power deskew fixture	067-1478-00
Video display clamp	013-0278-XX
P5050 500 MHz 10x passive probe	P5050
GPIB cable (3.3 ft. or 1 m)	012-0991-01
GPIB cable (6.6 ft. or 2 m)	012-0991-00
Centronics (printer) cable	012-1214-00

¹ For the current list of accessories, upgrades, and options, including service options, available for your VM Series Video Measurement System, visit the Tektronix Web site, www.tektronix.com.

Operating Requirements

- Place the instrument on a cart or bench, observing clearance requirements:
 - Top, Rear, Front, and Right Side: 0 in (0 mm)
 - Left Side: 3 in (76 mm)
 - Bottom: 0.75 in (19 mm) minimum or 0 in (0 mm) standing on feet, flip stand down
- Before operating, ensure that the ambient temperature is between +41 °F and +113 °F (+5 °C to +45 °C).

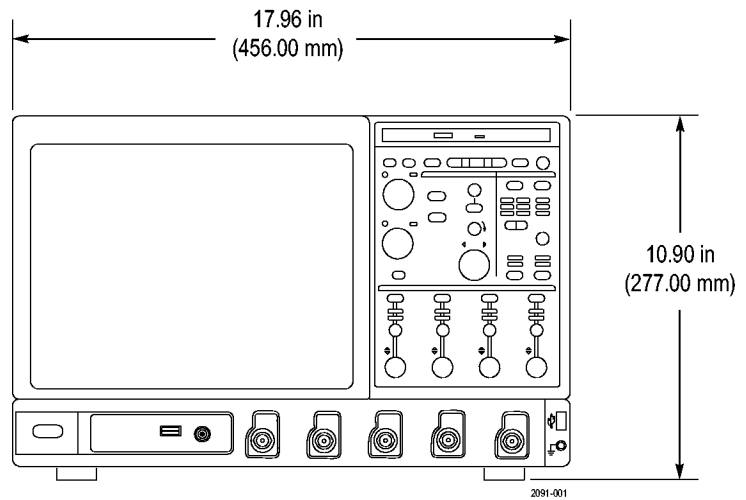

CAUTION. To ensure proper cooling, keep the bottom and sides of the instrument clear of obstructions.

Powering On the Instrument

Power Supply Requirements

Source voltage and frequency

100-240 V_{RMS} ±10%, 47-63 Hz or 115 V_{RMS} ±10%, 400 Hz

Power consumption

550 watts maximum

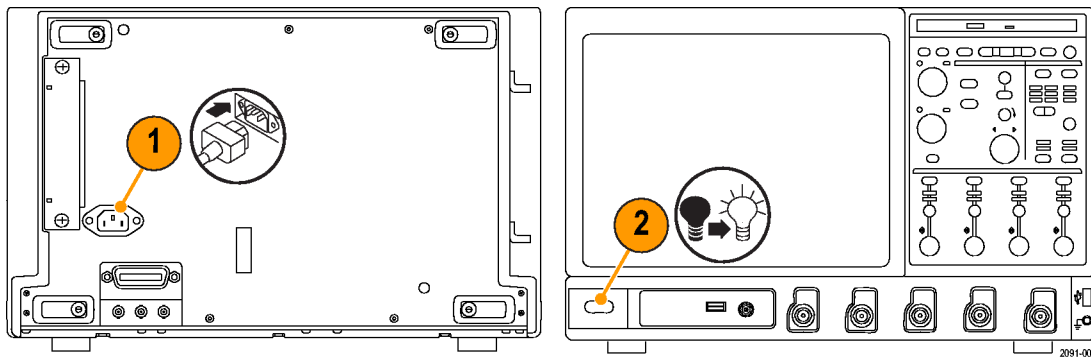

Powering Off the Instrument

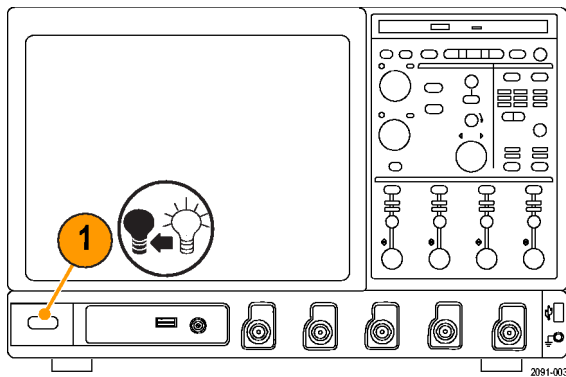

Removing the Power

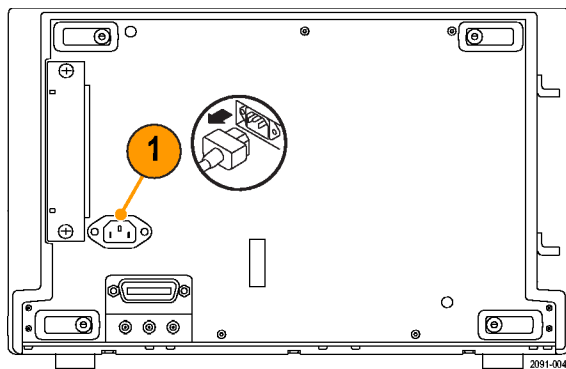

Connecting to a Network

You can connect your instrument to a network for printing, file sharing, internet access, and other functions. Consult with your network administrator and use the standard Windows utilities to configure the instrument for your network.

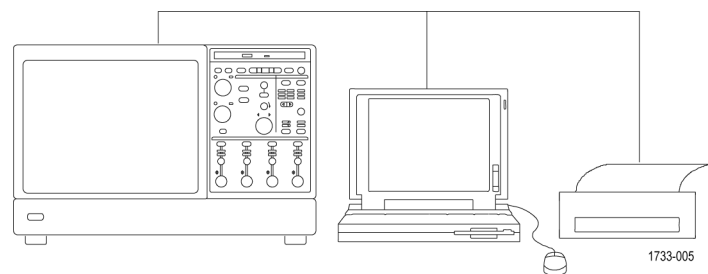

Getting Acquainted with Your Instrument

Front Panel

1. DVD/CD-RW drive
2. Front panel controls
3. USB port
4. Ground terminal
5. Auxiliary Trigger Input
6. Channel 1–4 inputs
7. Probe calibration output
8. Probe compensation output

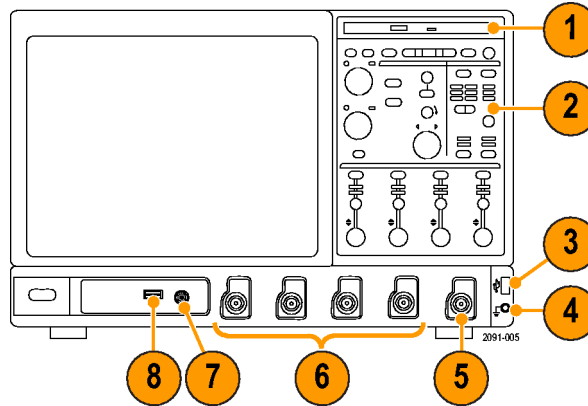

Side and Rear Panels

1. USB ports
2. Video port to connect a monitor for side-by-side display
3. Mic connector for microphone
4. Line Out connector for speaker
5. Scope Only XGA Out video port to connect a monitor
6. Printer connection
7. Line In connector
8. RJ-45 LAN connector to connect to a network
9. Centronics parallel port
10. COM 1 serial port
11. PS-2 connector for mouse
12. PS-2 connector for keyboard
13. TekLink connector for future use
14. Removable hard disk drive
15. GPIB port to connect to controller
16. Auxiliary output
17. Channel 3 output
18. External reference input

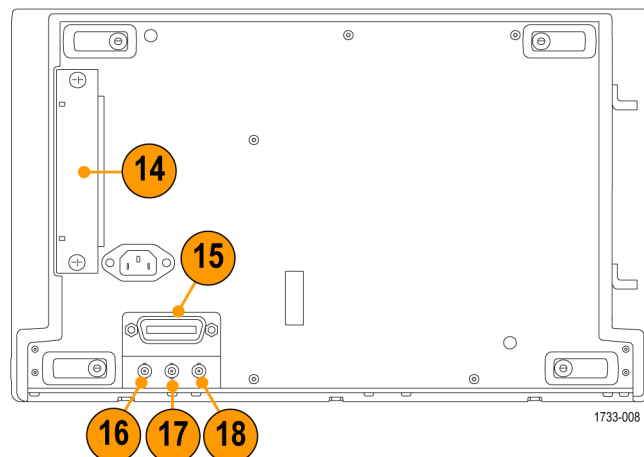
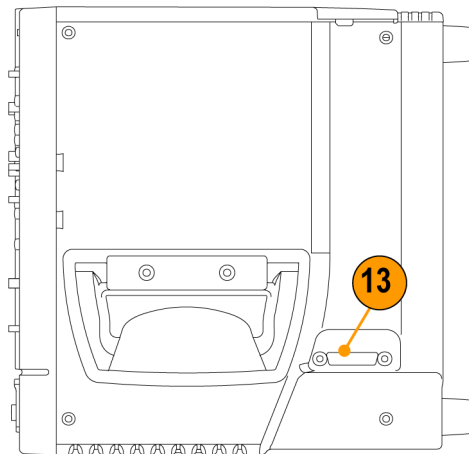
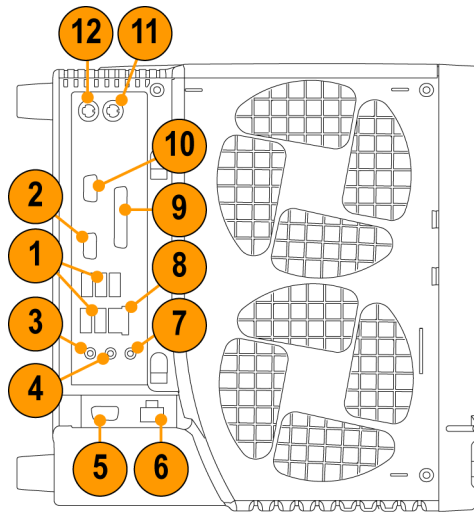

Input Connection Requirements – Options SD/HD

Use only 75 Ω coaxial cables to connect the video device under test to the instrument.

Install the included 75 Ω terminations between the end of the coaxial cables and the instrument input channels, using the included BNC T connectors. To achieve accurate frequency response measurements, it is important to attach the T connectors directly to the input channel BNCs.

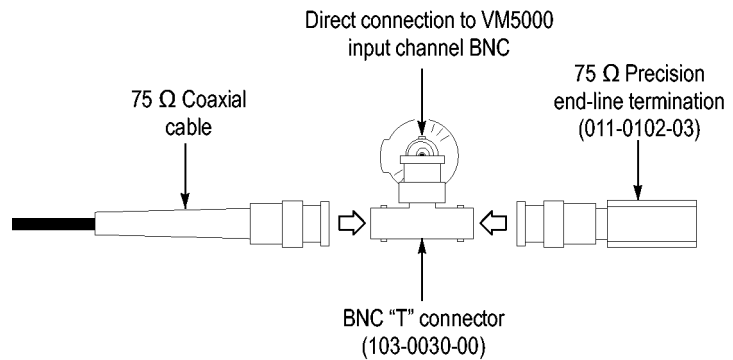

Input Connection Requirements – Option VGA

The preferred method of connecting the video device under test to the instrument is to use the RGBHV Measurement Interface Unit. The Measurement Interface Unit contains an impedance-matching circuit to ensure accurate measurement results. For some measurements, a low-frequency path is used and for other measurements a wideband path is used. The VM Series system selects which path is used through an RS-232 connection to the Measurement Interface Unit.

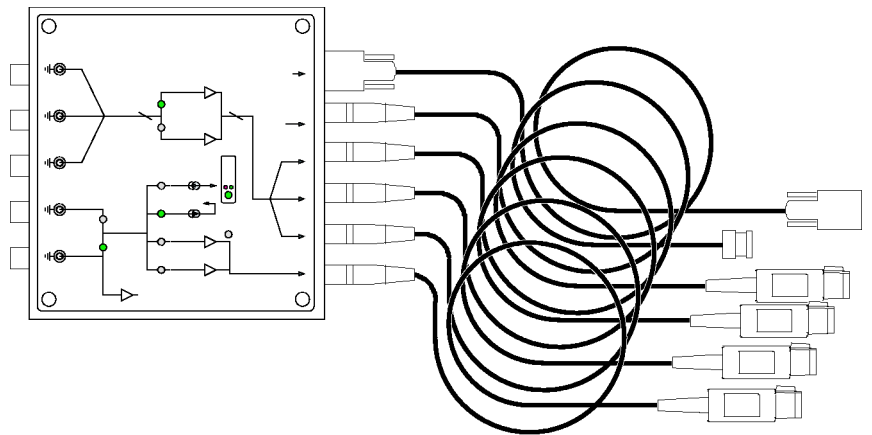

You can also connect the video device under test to the VM Series system by using the supplied VGA connector to 5X cable. If you use this method, you will need to connect the cable to the VM Series system using the supplied precision terminations and you may need to manually change terminations while taking measurements, depending on which measurements you take.

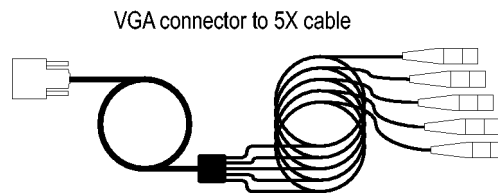

Connecting Input Signals

Option SD/HD Setup 1

Setups 1A and 1B are the preferred setups for testing 3-wire component analog video signals (Y/G, Pb/B, Pr/R) with the composite sync signal on Y/G. These setups use the Sync Pickoff accessory to derive the trigger signal from the Y/G signal on CH1. The triggering source is set to Channel 4. This configuration provides more accurate low-level noise measurements (below -60 dB at 30 MHz bandwidth) than setup 2.

This type of connection allows you to take more accurate noise measurements on CH1 while triggering on CH4, without adding additional cabling between CH1 and CH4. The additional cabling could adversely impact frequency response and multiburst measurements.

To achieve the best frequency response and multiburst measurements, the 75 Ω termination should be connected as close to the input connector as possible, as shown in the setup illustration.

There are two ways to connect the Sync Pickoff to the VM Series system. One way connects the Sync Pickoff directly to the input and the other way connects through a T-connector attached to a 75 Ω termination. Which method you use depends on the Sync Pickoff version you are using.

Setup 1A - Three-Wire Analog Video with Composite Sync for Sync Pickoff 012-1680-01. If you are using a 012-1680-01 Sync Pickoff (contains internal 75 Ω termination), connect the Sync Pickoff directly to the VM Series system CH1 input (using a TPA-BNC adapter for VM6000 and DPO7000 Series instruments) as shown in the following illustration. If you are using a 012-1680-00 Sync Pickoff (requires external 75 Ω termination), use the illustration shown in Setup 1B.

Connecting to a VM6000 / DPO7000 Series Instrument.

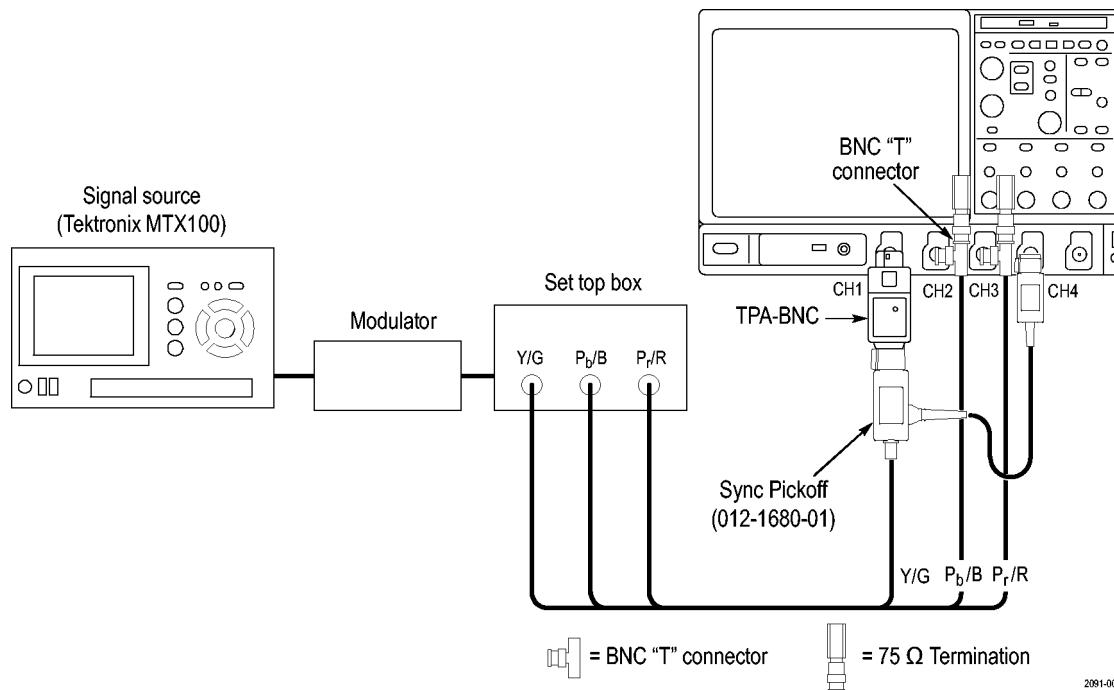

Connecting to a VM5000 / TDS5000 Series Instrument.

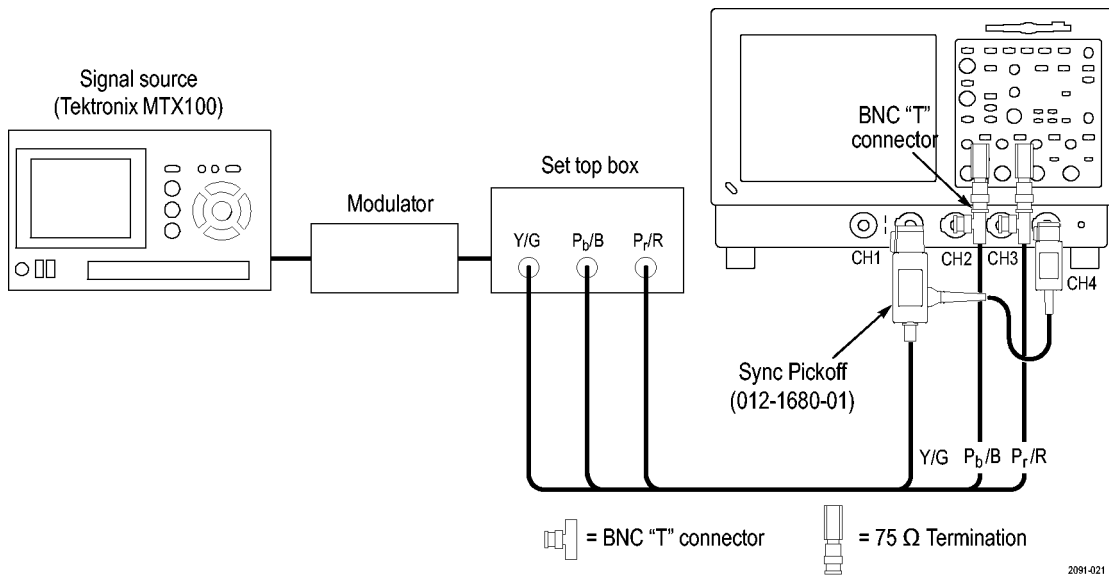

Setup 1B - Three-Wire Analog Video with Composite Sync for Sync Pickoff 012-1680-00. If you are using a 012-1680-00 Sync Pickoff (the part number is located on the label of the larger module), connect the Sync Pickoff to the VM Series system CH1 input as shown in the following illustration. If you are using a 012-1680-01 Sync Pickoff, use the illustration shown in Setup 1A.

Connecting to a VM6000 / DPO7000 Series Instrument.

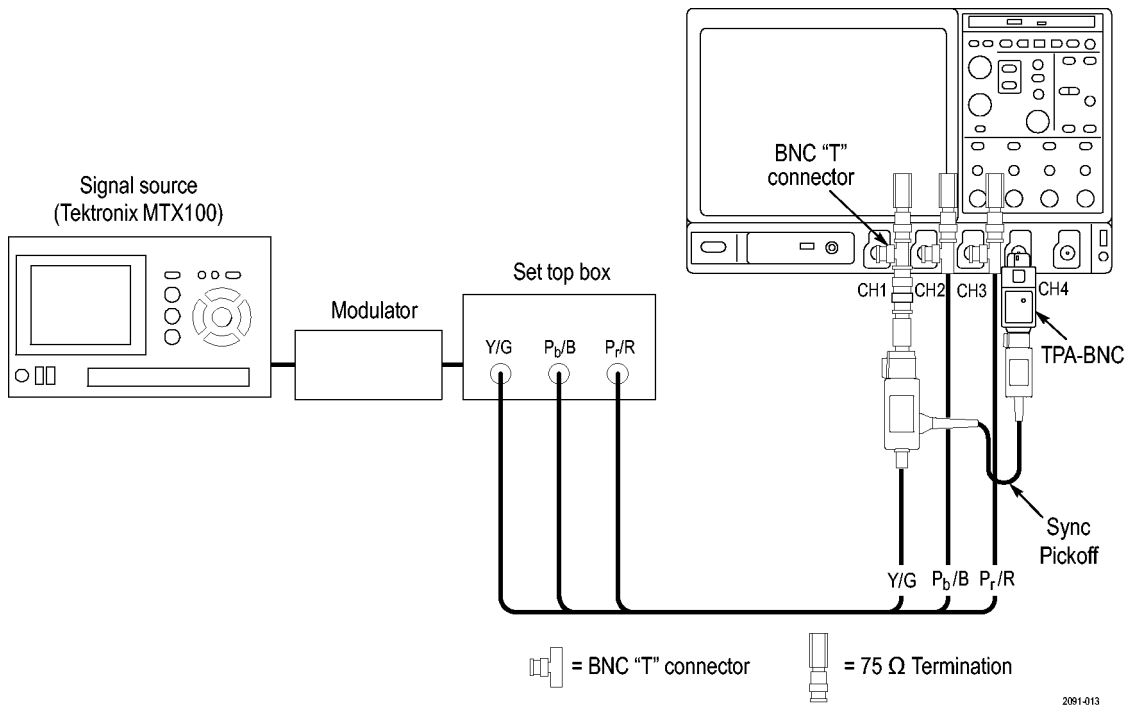

Connecting to a VM5000 / TDS5000 Series Instrument.

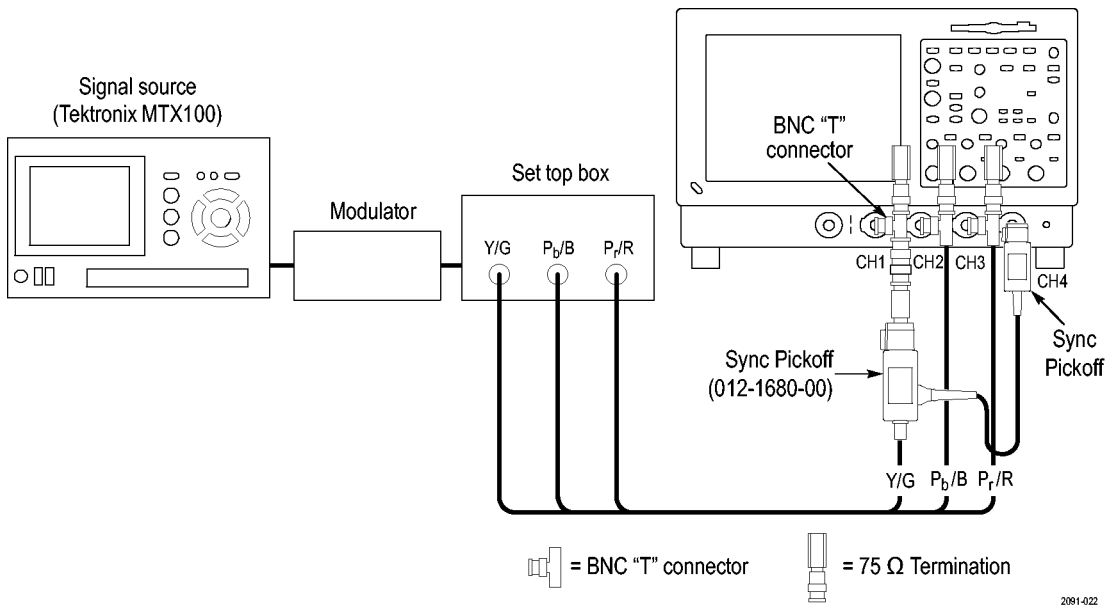

The following illustration shows how to connect the 012-1680-00 Sync Pickoff to the CH1 input.

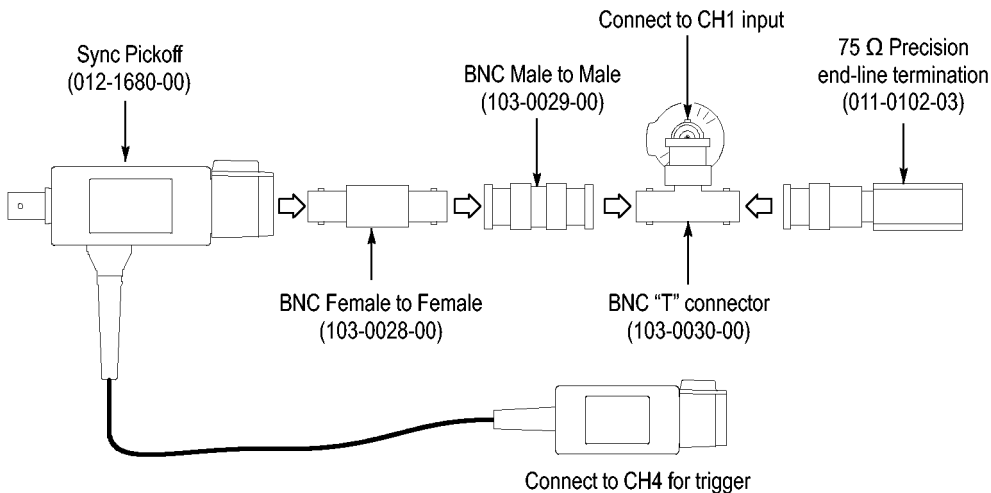

NOTE. Verify that the trigger channel is set to channel 4 (the default setting). If the trigger setting (Configuration > Operation) is not set to CH4, you will see signal warning messages and be unable to take measurements.

Option SD/HD Setup 2 - Three-Wire Analog Video with Composite Sync

Use this setup for testing 3-wire component analog video signals (Y/G, Pb/B, Pr/R) with the composite sync signal on Y/G. Set the triggering on the instrument to CH1 (the default trigger setting is CH4). This setup is simpler than the others mentioned in this section, but limits noise measurement on Y/G to -65 dB (30 MHz noise bandwidth).

Connecting to a VM6000 / DPO7000 Series Instrument.

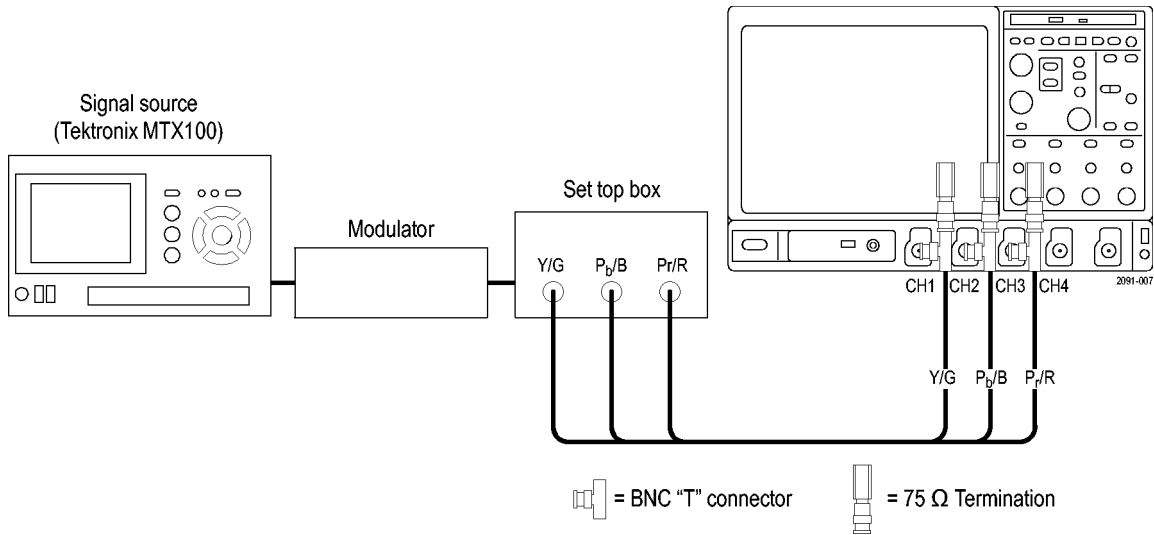

Connecting to a VM5000 / TDS5000 Series Instrument.

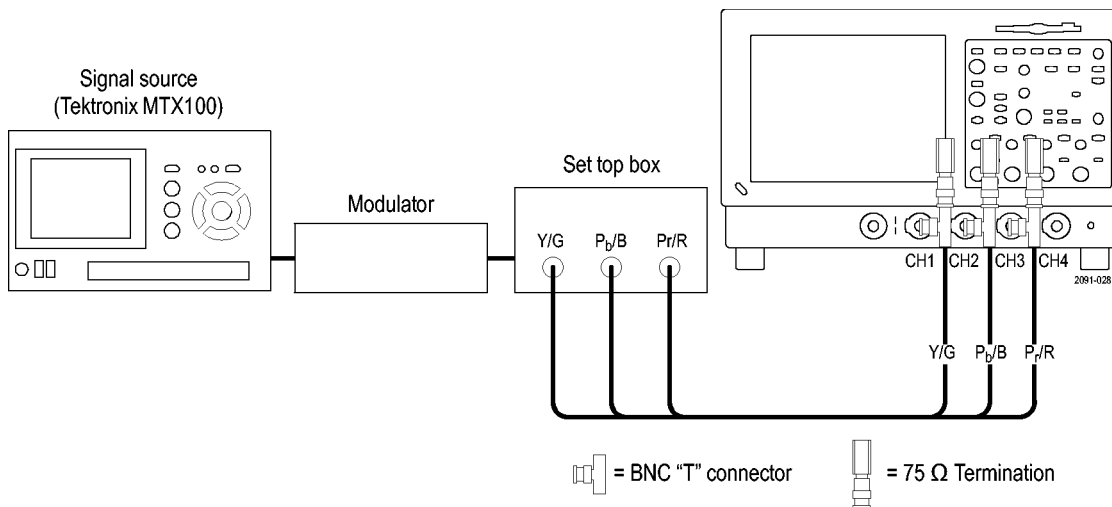

Option SD/HD Setup 3 - Four-Wire Analog Video with Separate Composite Sync

Use this setup for testing 4-wire component analog video signals (Y/G, Pb/B, Pr/R) with the composite sync signal on a separate output line. For CH4 only, you can connect the signal without using a termination or you can use a 75 Ω termination of lower accuracy than the 75 Ω terminations that are provided with the instrument.

Connecting to a VM6000 / DPO7000 Series Instrument.

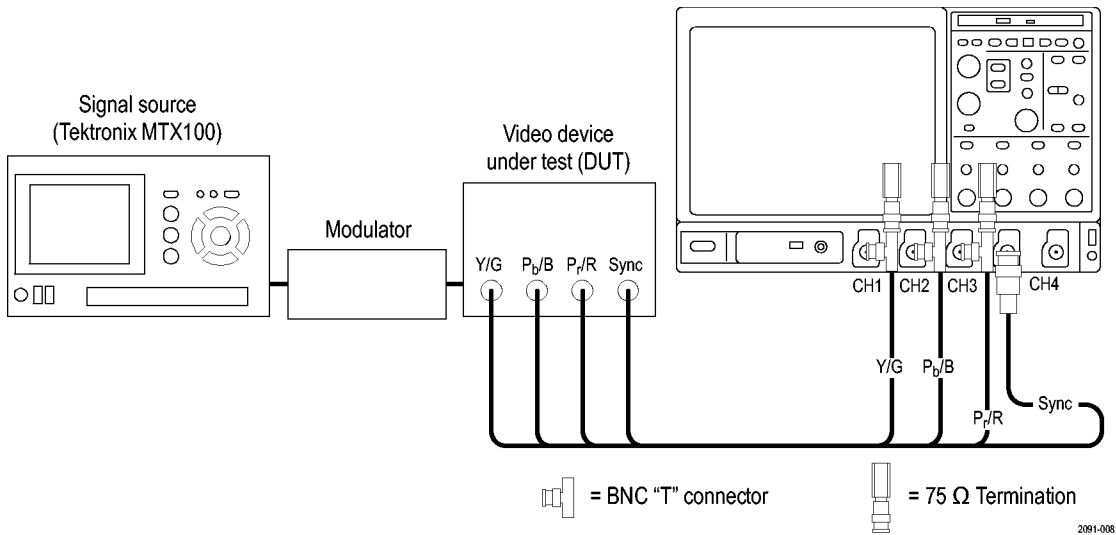

Connecting to a VM5000 / TDS5000 Series Instrument.

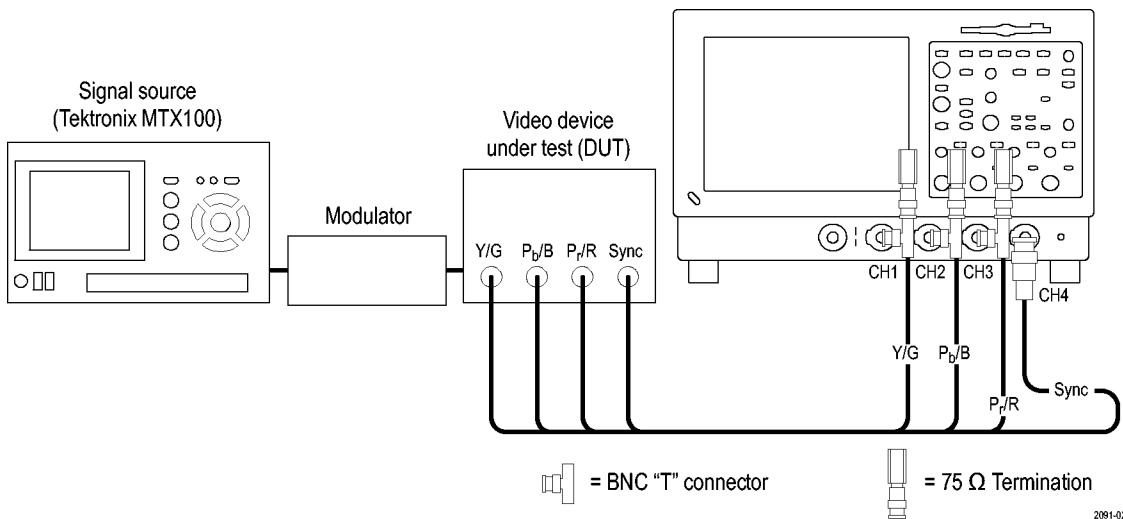

NOTE. Verify that the trigger channel is set to channel 4 (the default trigger channel). If the trigger setting is not set to CH4 (Configuration > Operation), you will see signal warning messages and be unable to take measurements.

Option VGA Setup 1 - RGBHV Measurement Interface Unit

This is the preferred setup for testing PC and play-out device video. Use the RGBHV Measurement Interface Unit to connect the PC video card to the VM Series system. Using the RGBHV MIU provides the most accurate measurement results.

Connecting to a VM6000 / DPO7000 Series Instrument.

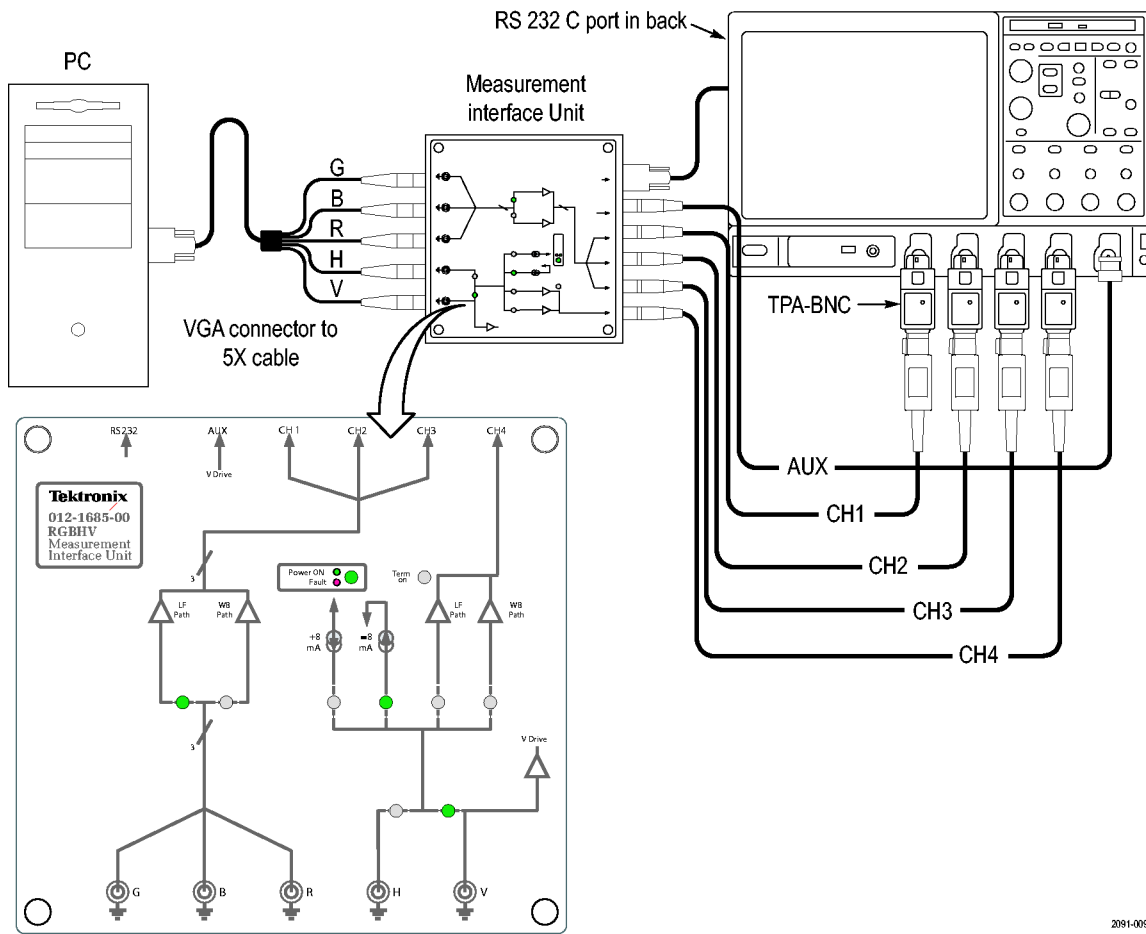

Connecting to a VM5000 / TDS5000 Series Instrument.

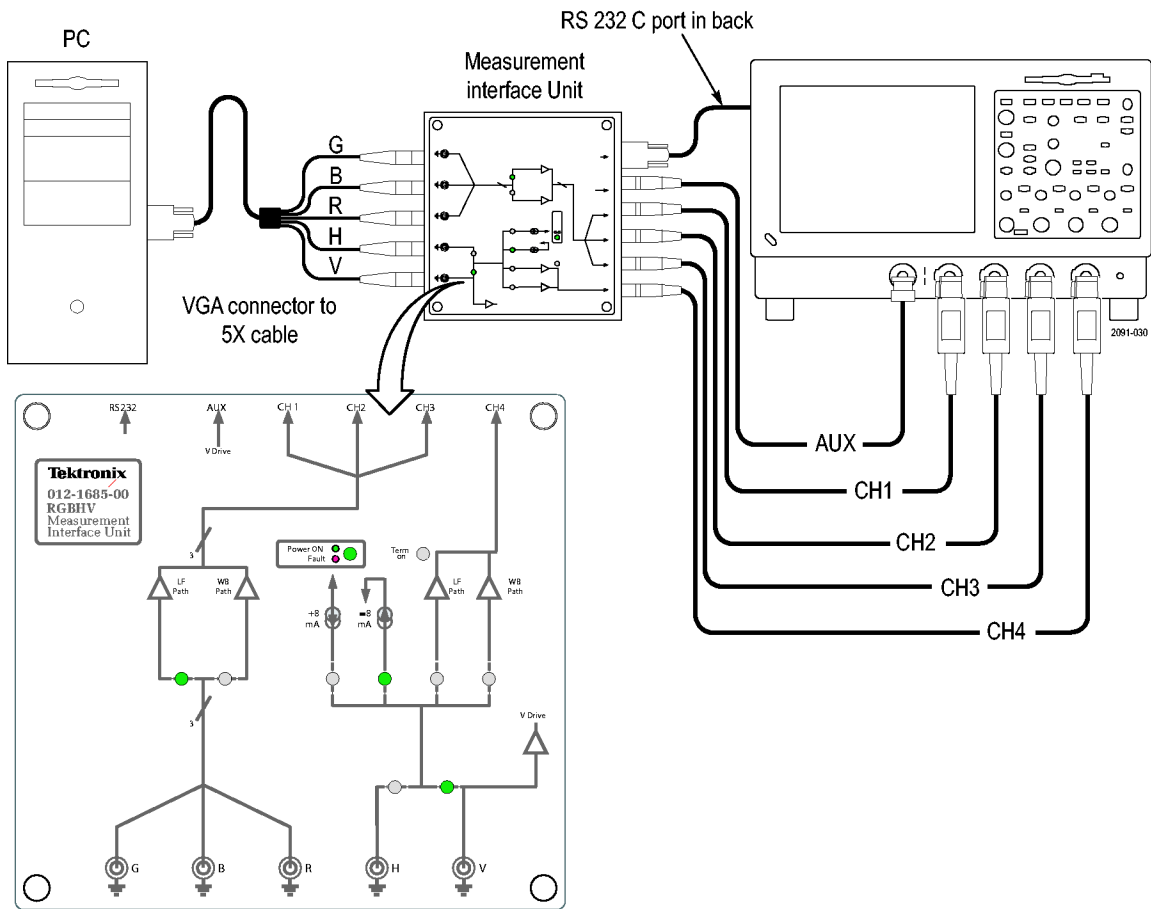

To connect the RGBHV Measurement Interface Unit:

1. Connect the Device Under Test (DUT) to the input side of the RGBHV Measurement Interface Unit using one of the VGA-to-BNC adapter cables supplied with your VM Series system.

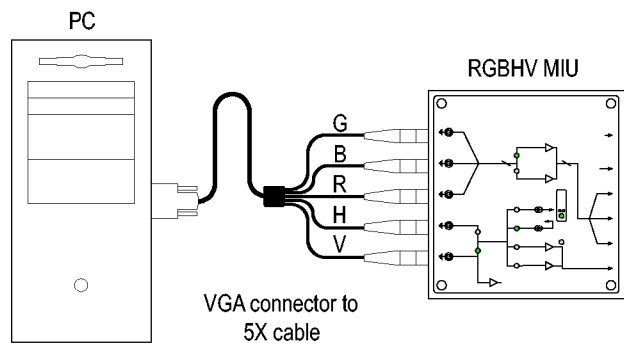

2. Connect the outputs (Aux, CH1–CH4) of the RGBHV Measurement Interface Unit to same inputs on the VM Series system (that is, connect the CH1 output to the CH1 input).

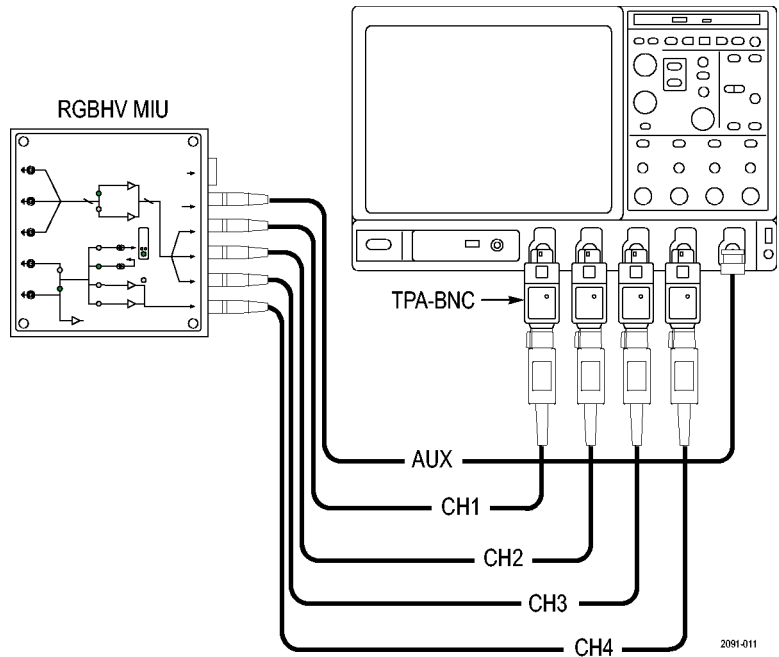

VM6000 / DPO7000 Series Instrument

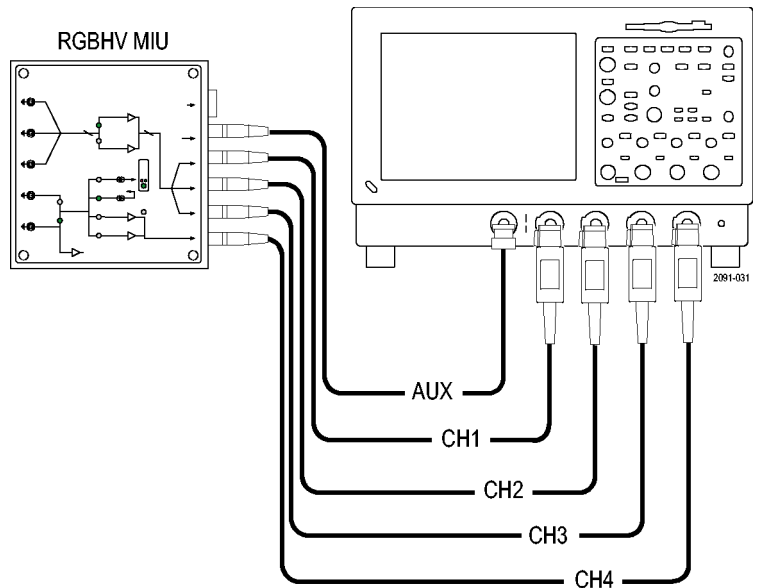

VM5000 / TDS5000 Series

3. Connect the RS-232 cable between the RGBHV Measurement Interface Unit and the COM1 port on the VM Series system.

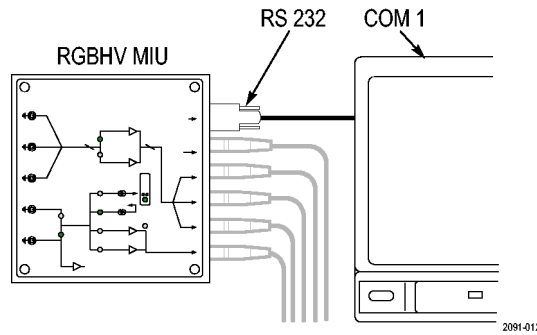

4. Verify that the **Use MIU** checkbox on the Configuration > Operation tab is selected.

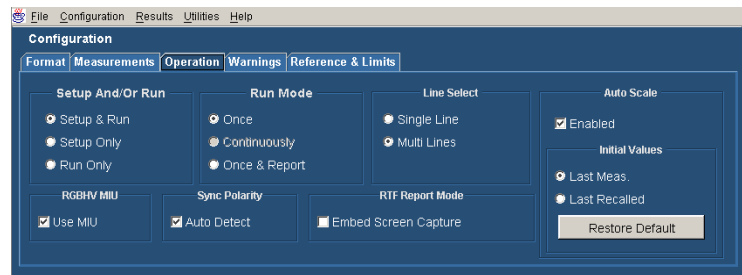

Option VGA Setup 2 - VGA Connector to 5X Cable

Use this setup for testing PC and play-out device video when it is not convenient to use the RGBHV Measurement Interface Unit. To ensure accurate measurements, connect the signals to the VM Series system using the T-connectors and precision terminations on CH1-CH4. You must use 75 Ω terminations on CH1-CH3 (used for GBR) and 2.21 k Ω and 301 Ω terminations on CH4 (used for H Sync and V Sync measurements). This method requires you to change the signal and termination connections on CH4 for certain horizontal and vertical measurements. The VM Series system displays a dialog box prompting you to make these changes when necessary (the RGBHV Measurement Interface Unit performs these connection and termination changes internally).

To connect the DUT to the VM Series system using a VGA to 5X cable:

1. Install the included 75 Ω terminations between the end of the BNC cables and the instrument input channels 1 through 3, using the included BNC T-connectors. To achieve accurate measurements, it is important to attach the T-connectors directly to the input channel BNCs.

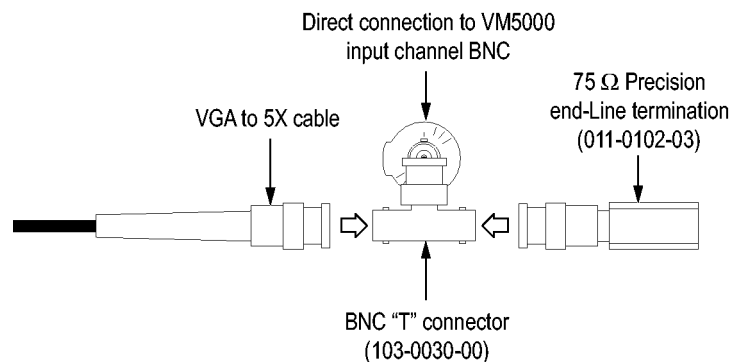

2. If you will be making H Sync, V Sync, or V Timing measurements, you will need to make 2.21 k Ω and 301 Ω terminations using the BNC-to-Binding Post adapters and resistors supplied as standard accessories. Attach each resistor to an adapter as shown.

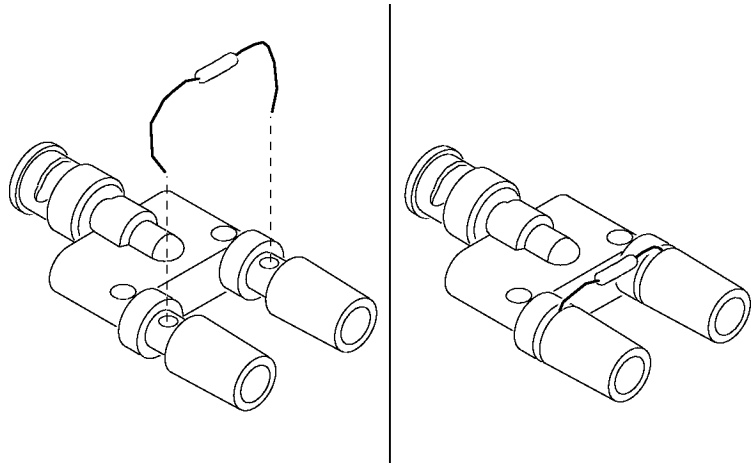

3. Connect the VGA signals to the VM Series system as shown. Connect the H Sync signal using the 2.21 k Ω termination to begin with. The VM Series system will prompt you to change it to the 301 Ω termination as necessary.

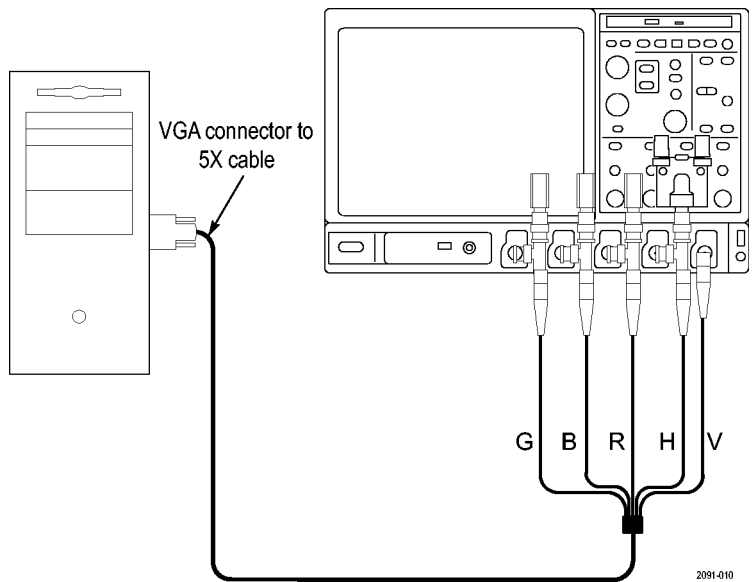

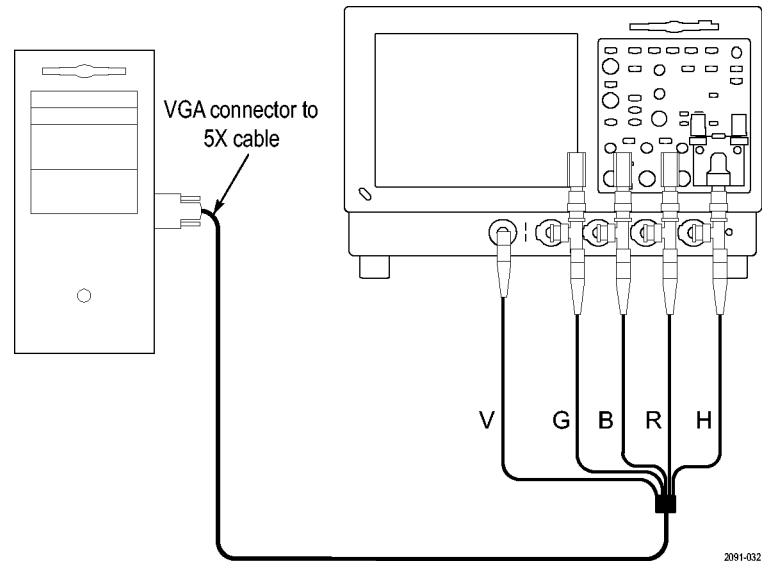

VM5000 / TDS5000 Series Instrument

A pop-up warning prompts you to change signal termination on CH4 when making an H Sync measurement.

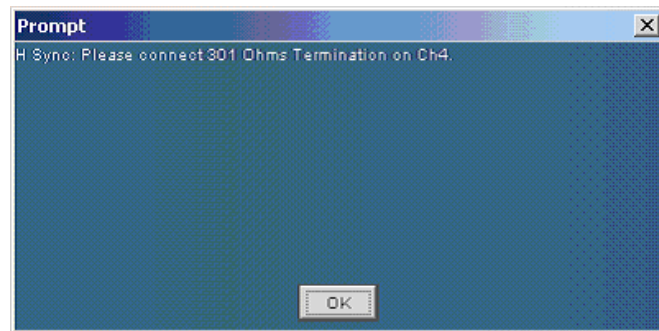

The following table identifies which signal from the DUT should be connected to which input connector on the VM Series system and which termination should be used for each signal.

VGA signal	VM Series system input connector	Termination
Green	CH 1	75 Ω
Blue	CH 2	75 Ω
Red	CH 3	75 Ω
H Sync	CH 4 ¹	2.21 k Ω and 301 Ω
V Sync	AUX	None

¹ V Sync signal is connected to this channel when making a V Timing or V Sync measurement. The VM Series system will prompt you for this connection change if necessary.

Signal Path Compensation

To optimize measurement accuracy, see the oscilloscope online help to perform the instrument signal path compensation procedure. Use the procedure if the temperature has changed more than 5 °C since the last signal path compensation. Perform the signal path compensation once a week. Failure to do so may result in the instrument not meeting warranted performance levels at those volts/div settings.

Sync Pickoff Compensation – VM6000 and DPO7000 Series, Options SD/HD Only

To properly compensate the Sync Pickoff:

1. Connect the Sync Pickoff small housing (marked “Connect to Trigger Channel”) to CH4. Leave the large housing unconnected from the instrument.

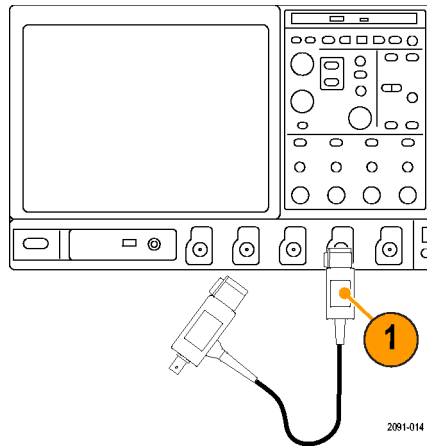

2. Attach the Sync Pickoff BNC connector to a BNC-to-minigrabbers connector (Pomona Electronics model number 3789).
3. Connect the minigrabbers to the PROBE COMP connector.

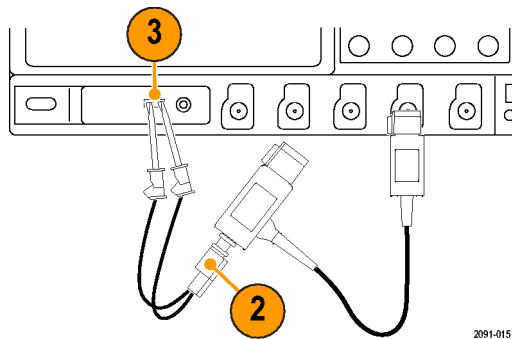

4. Push **AUTOSET**.

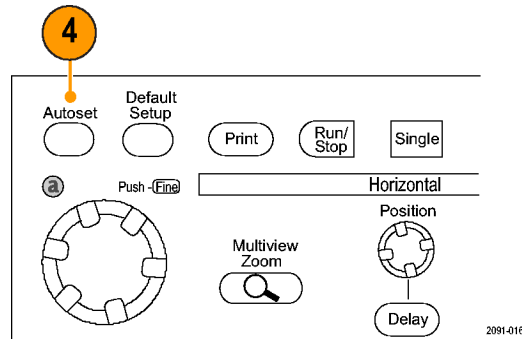

5. Check the shape of the displayed waveform to determine if the Sync Pickoff is compensated correctly.



6. If necessary, adjust the Sync Pickoff. Repeat as needed.

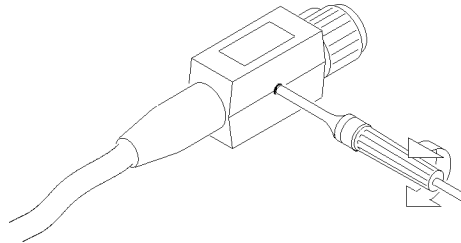

Sync Pickoff Compensation – VM5000 and TDS5000 Series, Options SD/HD Only

To properly compensate the Sync Pickoff:

1. Connect the Sync Pickoff cable to CH1 and CH4. The small housing, labeled “Connect to Trigger Channel”, should be connected to CH4.

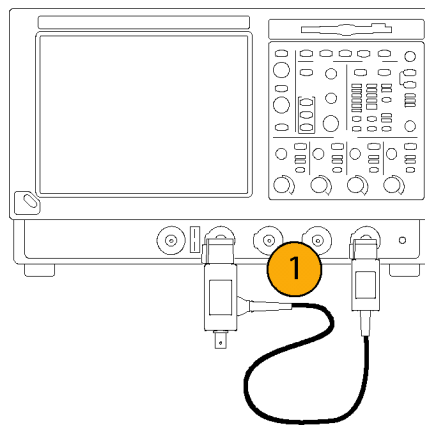

2. Attach the Sync Pickoff BNC connector to a BNC-to-minigrabbers connector (Pomona Electronics model number 3789).
3. Connect the minigrabbers to the PROBE COMP connector.

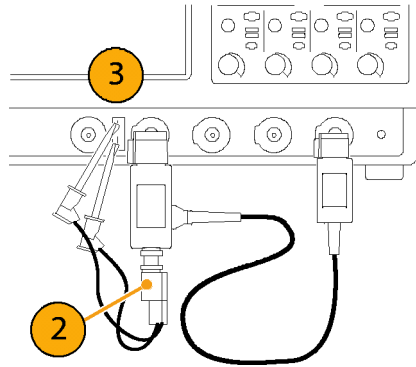

4. Select CH1 and CH4. Push **FastAcq.** Push **AUTOSET**. Both the CH1 and CH4 waveforms should be displayed. It is normal for the waveform to show tilt, caused by the 75 Ω Sync Pickoff termination loading the PROBE COMP output signal.

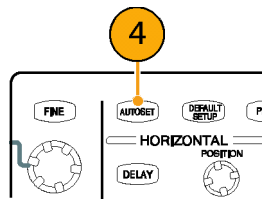

5. Compare the Channel 1 and 4 waveforms. If they do not have the same shape, adjust the Sync Pickoff compensation (the adjustment is accessed through the side of the small housing).

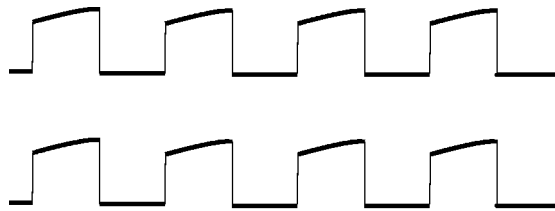

2091-026

Properly compensated

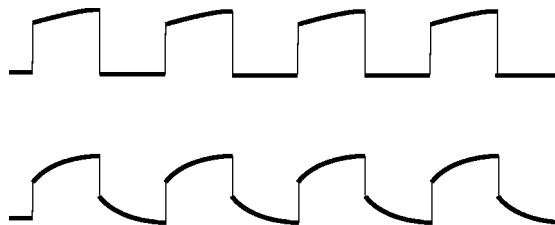

2091-024

Under compensated

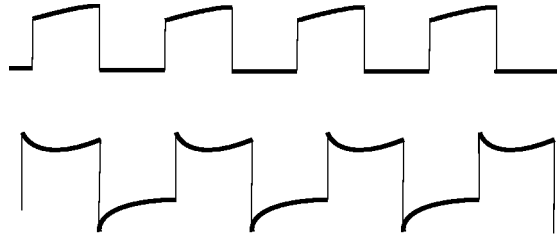

2091-025

Over compensated

6. If necessary, adjust the Sync Pickoff.
Repeat as needed.

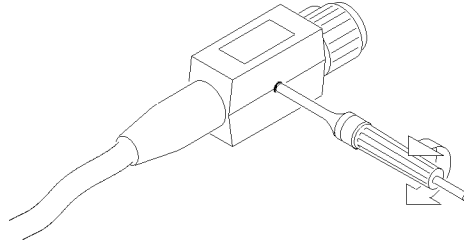

About the Matrix Test Signal

The Matrix test signal is supplied on the accessory signal source disks included with this product. There is a Matrix signal for Options SD and HD and a Matrix signal for Option VGA. The Matrix signal incorporates all analog video signal requirements into different line numbers within one test pattern field. Using a single test pattern eliminates the need to change test signals when doing different measurements. All you need to do is specify line numbers on which measurements are taken. Use the setup file (.vmset) that matches the format of the Matrix test signal you are using; this provides appropriate line numbers as default settings for each measurement type. See the *VM Series Video Measurement System User Manual* for a full description of the files on the signal source disks.

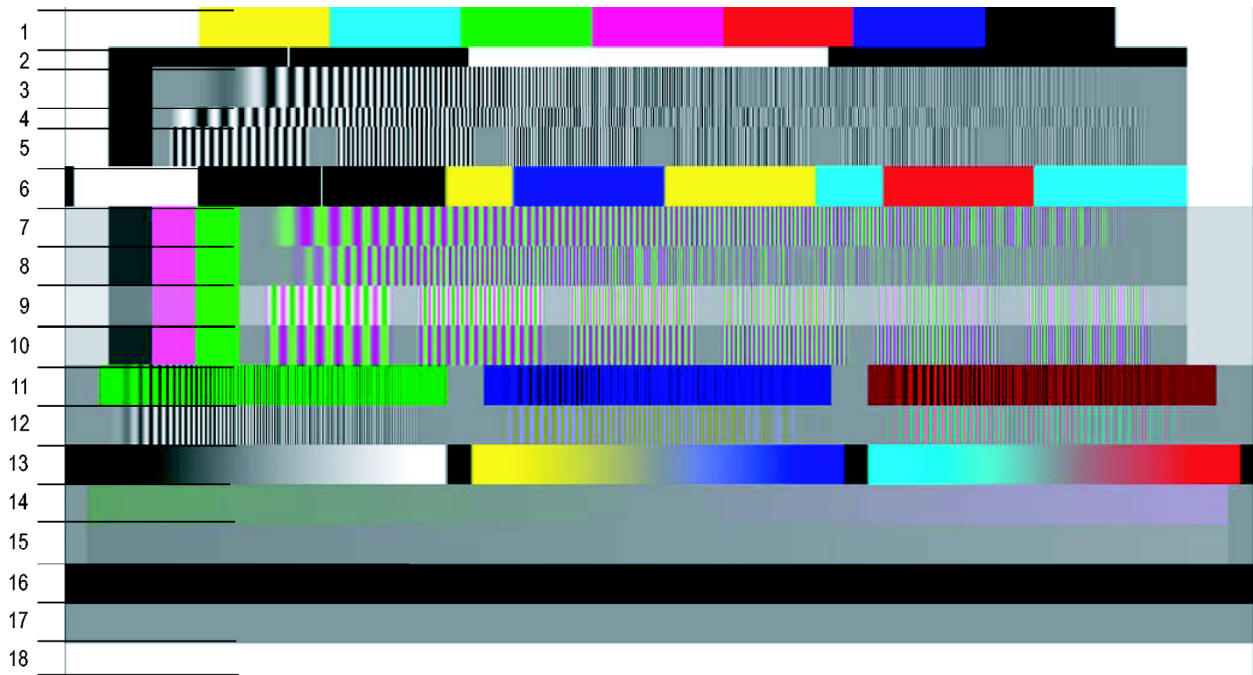

Option SD/HD Matrix signal

Elements of Option SD/HD Matrix signal

Signal name	Format	Signal name	Format	Signal name	Format
1. Color bars	All	7. YPbPr sweep time	YPbPr	13. Valid ramp	All
2. RGB pulse bars	RGB	8. YPbPr sweep Frequency	YPbPr	14. YPbPr shallow ramp	YPbPr
3. RGB frequency sweep	RGB	9. YPbPr multiburst	YPbPr	15. RGB shallow ramp	RGB
4. RGB time sweep	RGB	10. YPbPr multiburst	YPbPr	16. Flat field 7.5%	All
5. RGB multiburst	YPbPr	11. RGB crosstalk	RGB	17. Flat field 50%	All
6. YPbPr pulse bars	YPbPr	12. YPbPr crosstalk	YPbPr	18. Flat field 100%	All



Option VGA Matrix Signal

Elements of Option VGA Matrix signal

Signal name	Signal name
1. Half white and half black	5. Black / white / black
2. Nine colorbars	6. Full white
3. 32 steps	7. Ramp
4. Alternate white and black	8. Half white and half black

Starting the VM Series system Software

1. Power on the instrument.

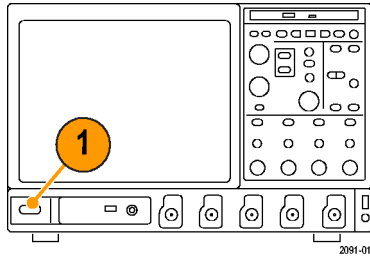

2. Select **Analyze > VM HD and SD Video V3.2** or **VM VGA Video V3.2**.

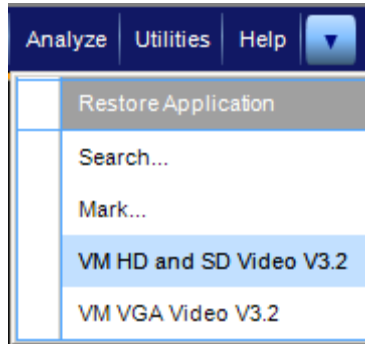

Option SD/HD

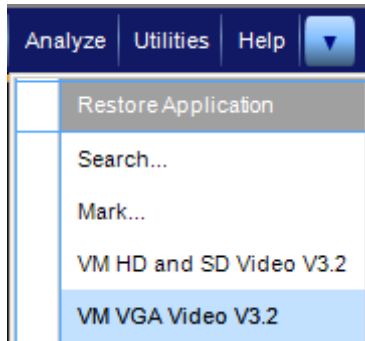

Option VGA

The instrument reduces the waveform area to the upper half of the display and opens the VM Series system application in the lower half of the display.

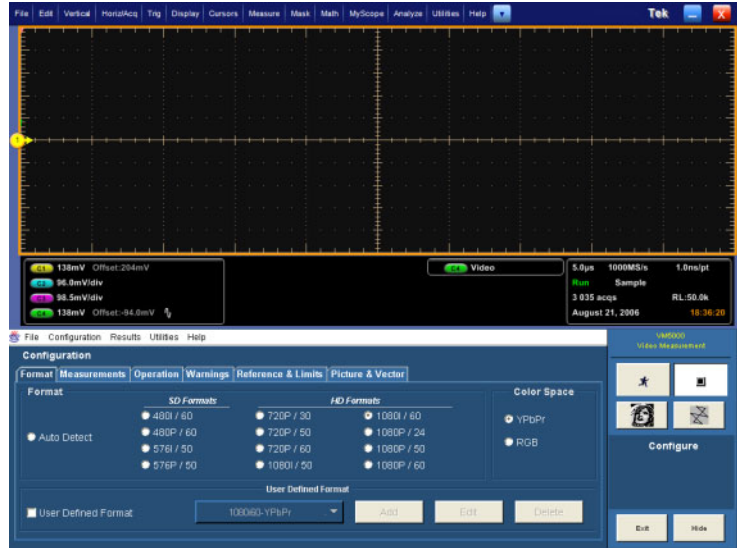

Option SD/HD

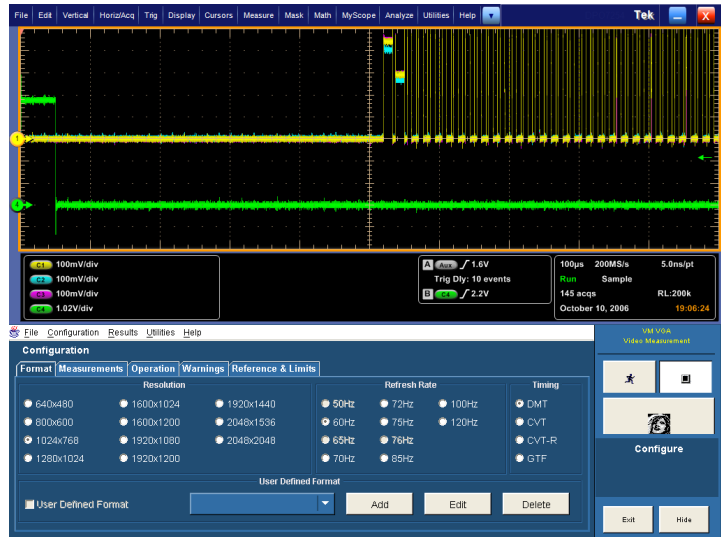

Option VGA

The VM Series System Software User Interface

1. Menu bar: Selects setting controls and results information to display in the Application view.
2. Application view: Displays configuration controls and measurements results.

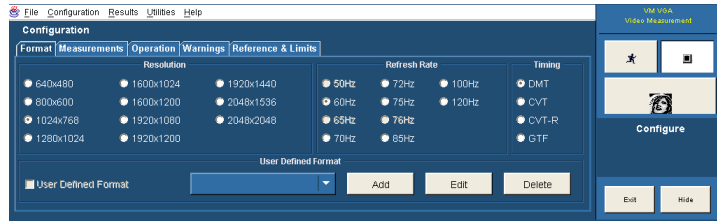

3. Run button: Initiates set up, starts taking measurements, and displays results. The button displayed depends on the Run Mode and Line Select settings.

Run button when Run Mode is set to Once or Once and Report, and Line Select is set to Single Line.



Run button when Line Select is set to Multi Lines.



Run button when Run Mode is set to Continuous.



4. Stop button: Halts measurements.



5. Picture button: Displays the signal as a picture.



6. Vectorscope button: Displays the signal in vectorscope format. (Option SD/HD only).

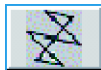

7. Hide button: Restores the main display to full-screen and hides the application window behind the main display.



To access the Windows desktop (for viewing reports), select **Hide**. In the main display, select **File > Minimize**, and then select the application **Hide** button again.

8. To restore a hidden application: Select the **Restore Application** item in the Analyze menu (VM60000 / DPO7000) or click the App button (VM5000 / TDS5000).

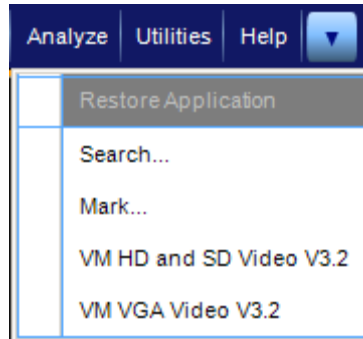

VM6000 / DPO7000



VM5000 / TDS5000

9. Exit button: Exits the VM Series system application and returns the instrument to the default main display.



Procedure for Taking Measurements

1. Set the input signal format parameters using **Configuration > Format**.
2. Select one or more measurements to take using **Configuration > Measurements**.
3. Set the measurement run operations using **Configuration > Operation**.
4. Select the Run button to take and view the measurements.
5. Save measurement results using **Utilities > Generate Report**.

Configuring the DUT — Option VGA

To perform measurements on the DUT, you must provide an appropriate video signal to the VM Series system. You accomplish this by displaying a bitmap file on the PC in which the DUT is operating. The preferred bitmap file, when taking multiple measurements, is the Matrix signal. If you need to take only one measurement, you can use a full-field test pattern rather than the Matrix signal. All the necessary Matrix signal and full-field test pattern bitmaps required to test for compliance to the VESA Test Procedure – Evaluation of Display Graphics Subsystems (Version 1 Rev. 1), are located on the *PC Bitmap Graphics Test Signal Files* CD-ROM.

1. Set the resolution and refresh rate of the DUT to the required values.
2. On the PC containing the DUT, display the contents of the *PC Bitmap Graphics Test Signal Files* CD-ROM.
3. Display the contents of either the Matrix or Full Field folder.
 - If you plan to take multiple measurements, open the Matrix folder.
 - If you plan to take only one measurement, open the Full Field folder and select the appropriate test pattern using the following table.

Matching measurements to the appropriate Full Field test pattern

Measurement	Appropriate test pattern(s)
Ch-Ch Mismatch	32 Step Staircase
Ch-Ch Skew	Alternate White and Black
Color Bars	Nine Color Bars
H Sync	Any pattern
H Sync Jitter	Any pattern
H Timing	Black / White / Black
Linearity	Staircase
Luma Levels	Alternate White and Black
Noise Inj. Ratio	Full White
Video Transient	Alternate White and Black
V Sync	Any pattern
V Timing	Half White and Half Black

Whether you choose a single test pattern or take multiple measurements, you must select the bitmap file that you will display to generate the video test signal. The file you select depends on the format you want to test. Suppose you want to test a 1280X1024 resolution format (the refresh rate is not considered when selecting a bitmap file) . Within the appropriate folder, look for a filename that matches the format of the test you want to perform. If you want to test Linearity, you would need to choose either full-field Staircase test pattern or use the Matrix test pattern. Within the Staircase folder, you would look for a file named STEP1280X1024.bmp . Within the Matrix folder, look for a file named MAT1280X1024.bmp.

- Select the bitmap file that fits your requirements and open the file with a program such as Paint Shop Pro.
If you set up the DUT to drive a second display, you can set the background of the second display to the bitmap file rather than opening the file with a bitmap editor.

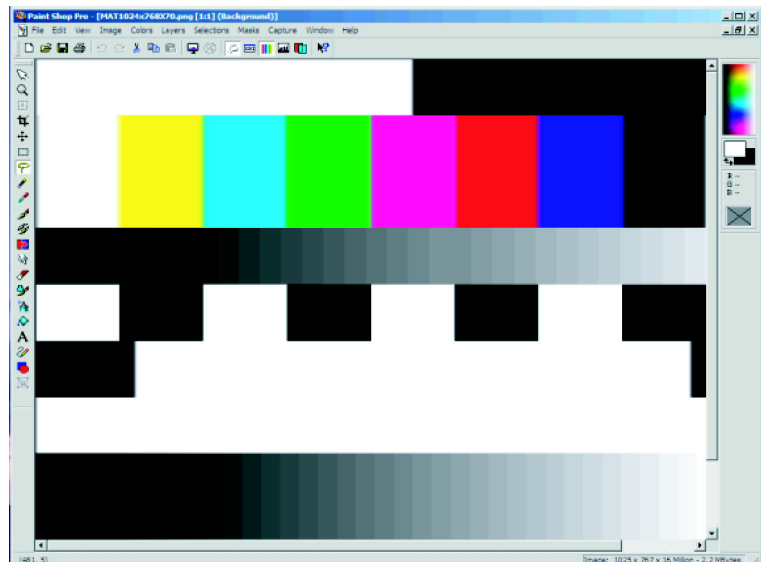

- From the View menu, select **View > Full Screen Preview**.

This displays the bmp file in full screen mode without any borders.



- Disconnect the output of the DUT from the monitor and connect the output of the DUT to the VM Series system.

Setting the Input Signal Format – Options SD/HD

- Select **Configuration > Format**.

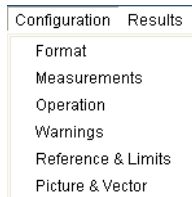

The application displays the Format view.

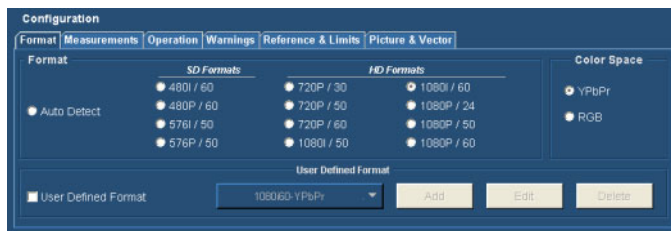

2. Select the appropriate video format for the signal you are measuring.



3. Select the appropriate color space for the signal you are measuring.



Creating a Custom Format

If you need to test a format that is not listed on the Format tab, you can create a User-Defined Format.

1. Select **Configuration > Format**.

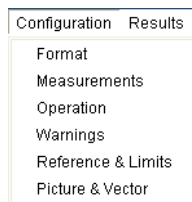

The application displays the Format tab view.

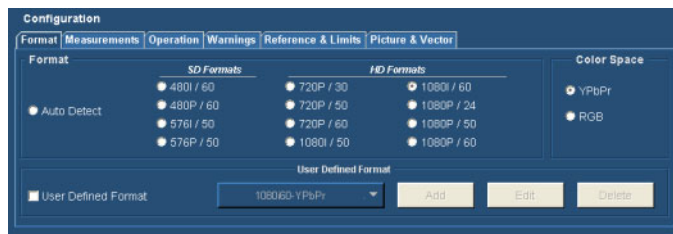

2. To add a new format, select **Add**. This displays the Create User Defined Format window.

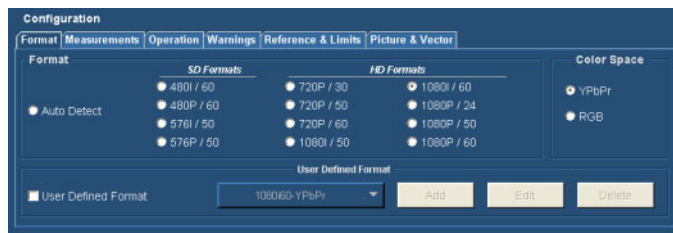

- Enter values for both the horizontal and vertical parameters that specify your format.

- Set the Scan Type.
- Set the Sync Type.
- Enter a value for the Frame Rate.

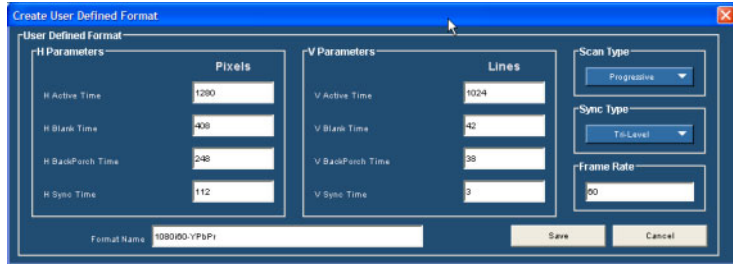

- Enter a format name and select **Save** to save the new format.

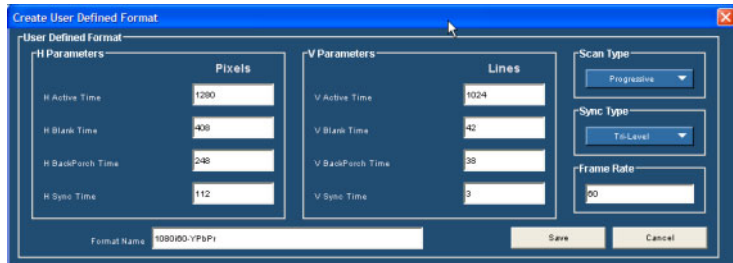

- To use a User Defined Format, check the User Defined Format checkbox on the Format tab. Select the desired format from the list box.

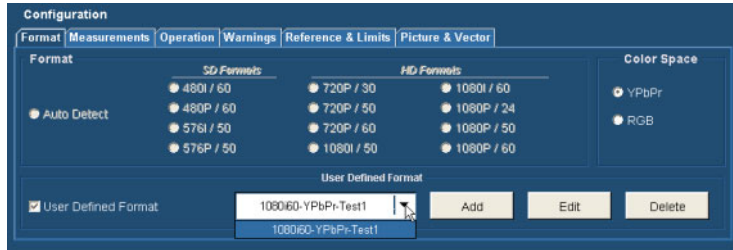

Setting the Input Signal Format – Option VGA

- Select **Configuration > Format**.

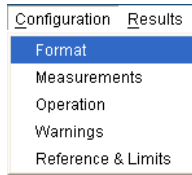

The application displays the Format tab view.

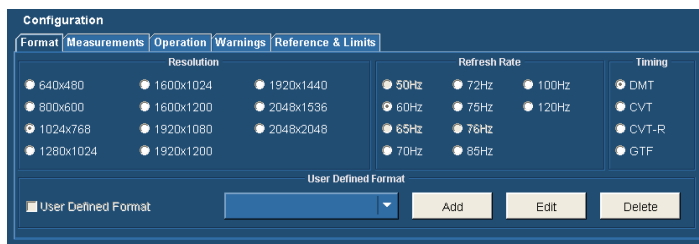

2. Select the appropriate resolution for the signal you are measuring.



3. Select the refresh rate for the signal you are measuring. Depending on the Resolution selected, some refresh rates will not be selectable.



4. Select the Timing standard for your signal.



Creating a Custom Format

If you need to test a format that is not listed on the Format tab, you can create a User-Defined Format.

1. Select **Configuration > Format**.

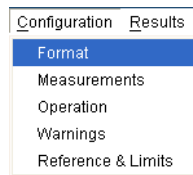

The application displays the Format tab view.

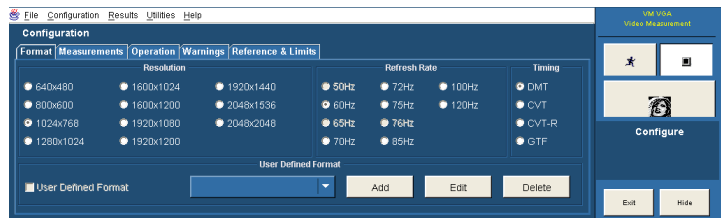

2. To add a new format, select the User Defined Format checkbox.

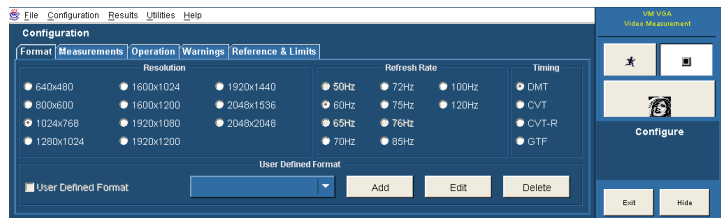

- To define the parameters of the new format, select **Add**.

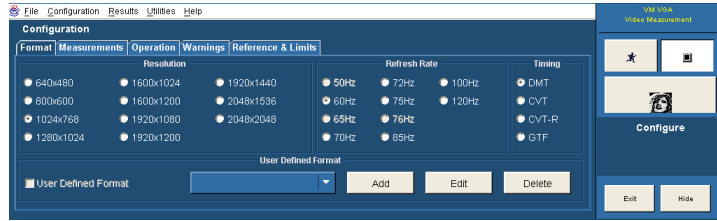

- Enter values for both the horizontal and vertical parameters that specify your format.

- Set the Sync Polarity.
- Enter a value for the Refresh Rate.

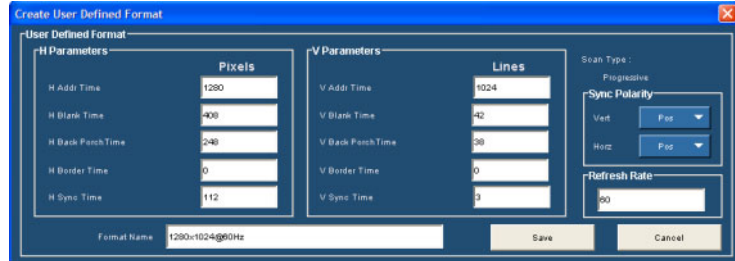

- Enter a format name and select **Save** to save the new format.

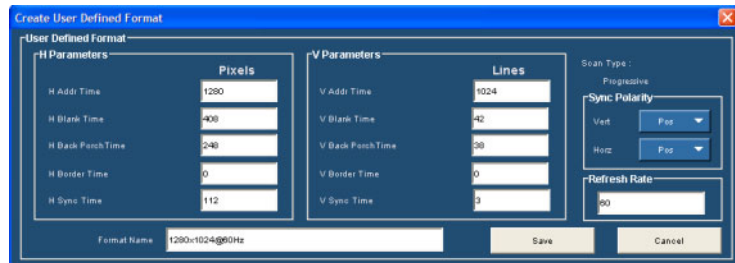

- To use a User Defined Format, check the User Defined Format checkbox on the Format tab. Select the desired format from the list box.

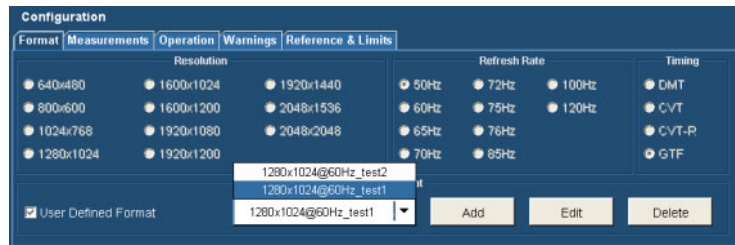

Selecting Measurements

1. Select **Configuration > Measurements**.

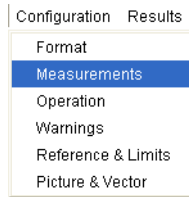

2. Select the desired measurements on the Measurements tab. You can select one measurement or any combination of measurements.

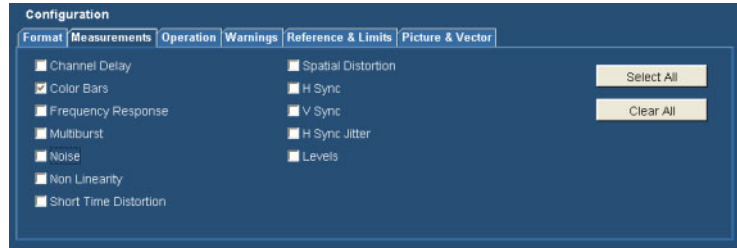

Option SD/HD

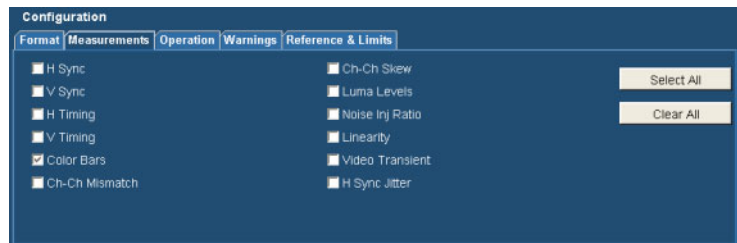

Option VGA

Setting the Measurement Run Operations

1. Select **Configuration > Operation**.

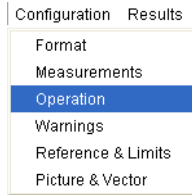

Option SD/HD

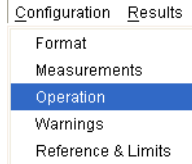

Option VGA

The instrument displays the Operation view. These settings control how the instrument sets up and acquires measurements when you select the Run button.

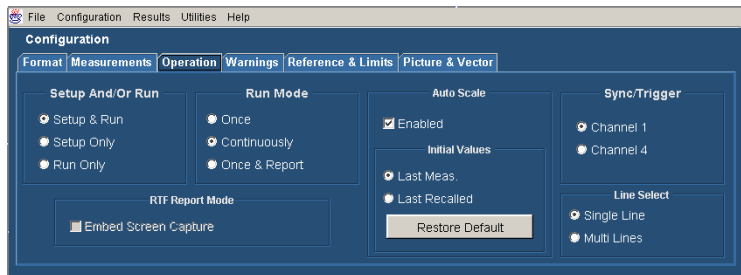

Option SD/HD

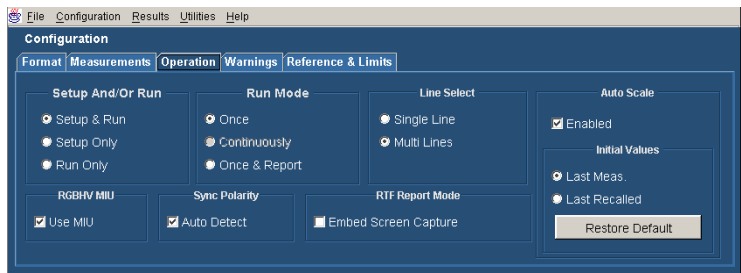

Option VGA

2. Select how the instrument sets up and runs measurements.

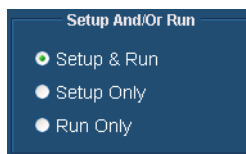

- **Setup & Run** configures the instrument settings and takes a measurement for each selected measurement and for each measurement acquisition. Use this when taking multiple measurements that require different instrument setups.
 - **Setup Only** configures the instrument for a measurement but does not take the measurement. Use this to set up customized settings. Try out your settings by pressing the Run button, make adjustments as needed (for example, change the horizontal scale), and then select the Run button again. Once you are satisfied with your customization, use the Run Only setting to collect results.
 - **Run Only** takes a measurement using the existing instrument configuration. Use this setting for taking measurements with custom settings (see Setup Only description above).
3. Select how the application acquires measurements (run mode).

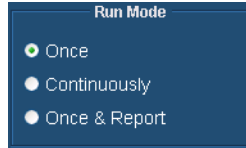

- **Once** takes each selected measurement the number of times determined by the averaging setting, then stops taking measurements. This is the default setting.
- **Continuously** continually takes measurements. You must select the Stop button to stop measurements.
- **Once & Report** takes each selected measurement the number of times determined by the averaging setting, then stops taking measurements and generates a report.

4. Enable or disable waveform Auto Scale. Auto Scale adjusts the vertical scale units so that the input signals fill the graticule as much as possible. Auto Scale occurs once for each selected measurement.

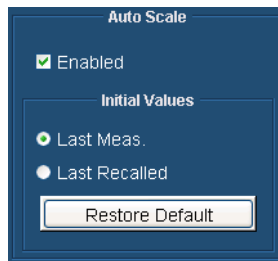

5. Option SD/HD: Select which instrument channel has the sync signal for triggering. If you use the wrong trigger channel, you will get a signal warning (if Signal Warnings is on). (See page 9, *Connecting Input Signals*.)



Option SD/HD

6. Choose the Line Select setting as appropriate. In Single Line mode, each measurement is made on a single line (for example, line 153). In Multiple Lines mode, measurements are made across a range of lines (for example, lines 153–185).

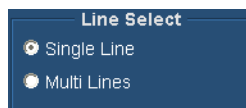

When you select Multiple Lines, a report is automatically saved to a file.

7. Option VGA: If you are using the RGBHV Measurement Interface, you must select the **Use MIU** checkbox.

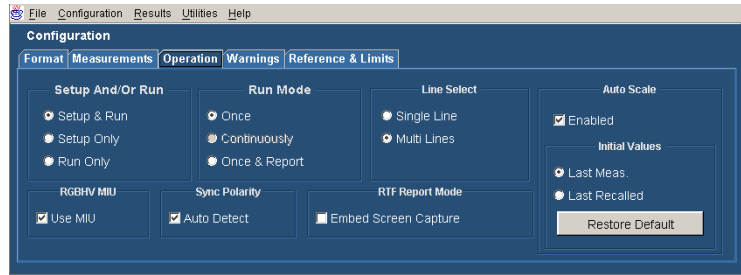

Option VGA

8. Option VGA: If you are using the MIU, you can ignore the Sync Polarity setting.

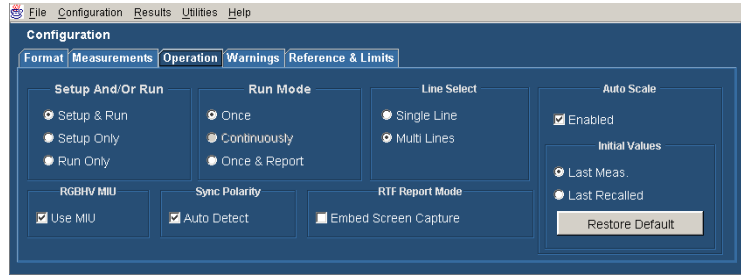

Because the specified polarities for the H Sync and V Sync signals vary between the timing standards, the VM Series system will prompt you to connect the H and V Sync signals to automatically determine their polarities. Once the sync signal polarities are determined, the measurement cycle begins. This “polarity test” is performed at the beginning of every measurement cycle. To prevent this test from running at the beginning of every measurement cycle, take any measurement once with Auto Detect selected. Once a measurement cycle has been completed with Auto Detect selected, you can deselect Auto Detect and you will not be prompted to change signals for the polarity test again (the VM Series system will remember the polarity of the sync signals). Of course, any time you change the format set-up for the device-under-test, you should complete a measurement cycle with Auto Detect selected.

9. Select which warning messages to display.
See the *VM Series Video Measurement System User Manual* for more information on warnings.

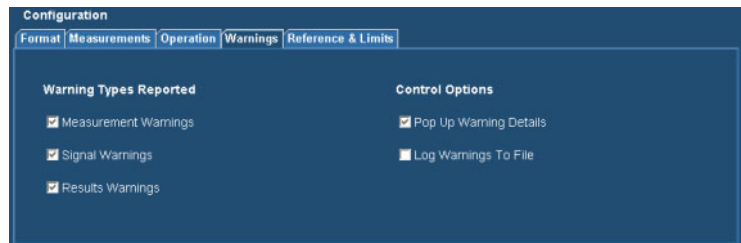

Taking and Viewing Measurements

Before taking a measurement, remember to select a signal format, select the desired measurements, and configure the run options.

1. Select the Run button. The instrument begins taking measurements and displays the measurement results view for the most recently-selected measurement result.

Color	Measured		
	Y / G	Pb / B	Pr / R
White	677.53	0.02	0.05
Yellow	624.69	-336.49	29.82
Cyan	531.33	78.91	-336.4
Green	482.26	-259.43	-304.27
Magenta	192.0	261.41	308.02
Red	145.66	-76.22	337.15
Blue	48.8	339.84	-30.91
Black	0.71	-0.41	0.0

Option SD/HD

Color	Measured		
	G	B	R
White	642.647	645.614	642.383
Yellow	641.009	-2.927	640.277
Cyan	640.919	645.458	-2.664
Green	641.622	-2.452	-0.559
Magenta	-1.851	645.465	642.329
Red	-0.283	-2.672	640.978
Blue	0.085	646.05	-2.311
Black	0.173	-1.767	0.0

Option VGA

2. To view the results of other measurements, select the measurement from the Results menu. For example, to view the Sync measurement results (Option SD/HD only), select **Results > Sync**.

Results	Utilities	Help
◆ Summary		
Channel Delay		Short Time Distortion
Color Bars		Spatial Distortion
Frequency Response		H Sync
Multiburst		V Sync
Noise		H Sync Jitter
Non Linearity		Levels

Option SD/HD

Results	Utilities	Help
◆ Summary		Ch-Ch Skew
H Sync		Luma Levels
V Sync		Noise Inj Ratio
H Timing		Linearity
V Timing		Video Transient
Color Bars		H Sync Jitter
Ch-Ch Mismatch		

Option VGA

3. If you set the run operation to Continuously, press the Stop button to stop taking measurements.



Using the Oscilloscope

To use the standard oscilloscope capabilities of the VM Series system to take measurements or view features of a signal, just hide the VM Series system software. You do not have to quit the VM Series system software.

1. To hide the VM Series system software, select **Hide**.

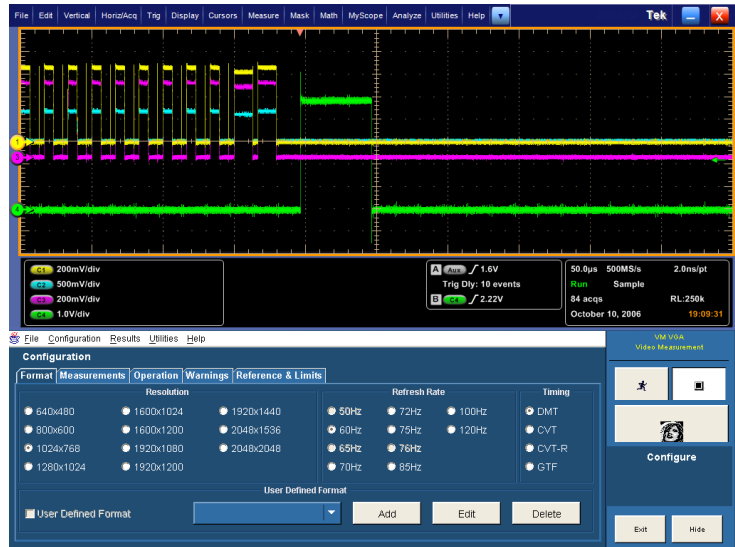

When the VM Series system software is hidden, the oscilloscope display appears full screen. There is no on-screen indication that the VM Series system software is hidden.

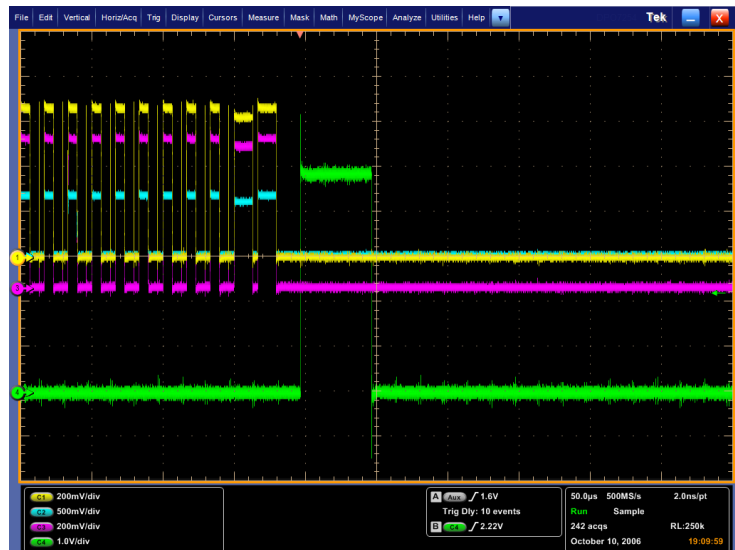

2. To return to the VM Series system software, select **Restore Application** from the Analyze menu.

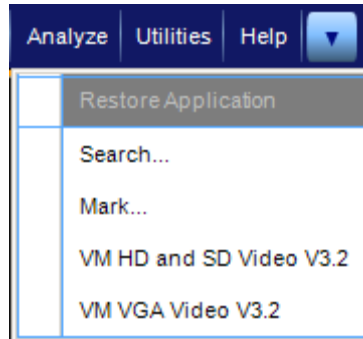

Troubleshooting Signal Problems

If you have problems taking measurements, you may receive warning or error messages that can help you determine the source of the problem. The following tables describe the messages and the possible causes.

Option SD/HD Warning messages

Number	Text	Possible causes	Operation where it may occur
1	Acquisition Problem	The instrument cannot trigger or the signal levels are out of range.	All measurements
2	Bar Measurements Inconclusive	The instrument cannot find a proper sync, the wrong format is selected, or the signal is distorted.	Measuring Short Time Distortion
3	Channel Delay: Channel <x> & <y>, Correlation Too Low	The line number is set incorrectly, a distorted signal, or an inappropriate input signal with too few transitions.	Measuring Channel Delay
4	Channel Delay: Disjoint Correlations Among Channels...	There is a group delay mismatch among channels or an inappropriate signal source.	Measuring Channel Delay
5	Color Bars: <Color> Bar Not Found	The line number is set incorrectly, a distorted signal, an incorrect format is specified, channels connected are in the wrong order, the wrong colorimetry, or excessive cropping of the signal.	Measuring Color Bars
6	Color Bars: Back Porch Reference Questionable	The signal is distorted.	Measuring Color Bars
7	Frequency Response: Signal Change: <freq1> ³ <freq2> MHz	Signal level is too low, an incorrect signal, or a change in the signal.	Measuring Frequency Response
8	Frequency Response Individual Channel Errors: Channel <x>	The signal is distorted or a flag is missing in the signal.	Measuring Frequency Response
9	Frequency Response: Invalid results for all channels	The line number is set incorrectly, an inappropriate input signal, or an incorrect configuration.	Measuring Frequency Response
10	Multiburst: Signal Change: <freq1> ³ <freq2> MHz	Signal level is too low, an incorrect signal, or a change in the signal.	Measuring Multiburst
11	Multiburst: Individual Channel Errors: Channel <x>: Flag <= 0 mV	The signal is distorted or a flag is missing in the signal.	Measuring Multiburst
12	Multiburst: Individual Channel Errors: Channel <x>: burst <n>: not detected	Signal level is too low, distorted signals, an input signal with less than six frequency packets, or excessive cropping of the signal.	Measuring Multiburst
13	Multiburst: Invalid results for all channels	The line number is set incorrectly, an inappropriate input signal, or an incorrect configuration.	Measuring Multiburst
14	Noise: Signal Change: Chan <x>	The signal changed during measurement.	Measuring Noise

Option SD/HD Warning messages (cont.)

Number	Text	Possible causes	Operation where it may occur
15	Noise: Invalid results for all channels.	The line number is set incorrectly, inappropriate input signal, or incorrect configuration.	Measuring Noise
16	Nonlinearity: Invalid Results: Channel <x>: No ramp or step signal found	The line number is set incorrectly or inappropriate input signal.	Measuring NonLinearity
17	Nonlinearity: Signal Change: Channel <x>:	The signal changed during measurement.	Measuring NonLinearity
18	Short Time Distortion: Bar Start Not Found	The line number is set incorrectly, distorted signal, or incorrect format selected.	Measuring Short Time Distortion
19	Short Time Distortion: Bar End Not Found	The line number is set incorrectly, distorted signal, or incorrect format selected.	Measuring Short Time Distortion
20	Short Time Distortion: Invalid results for Channel<x>.	The line number is set incorrectly, inappropriate input signal, or incorrect configuration.	Measuring Short Time Distortion
21	Sync Measurements Inconclusive	The instrument cannot find a proper sync, the wrong format is selected, or the signal is distorted.	Measuring Sync
22	Sync Measurement: <n> Not Found	The instrument cannot find a proper sync.	Measuring Sync
23	2T pulse not found in luminance component of signal	The line number is set incorrectly, inappropriate input signal, or incorrect configuration.	Measuring Short Time Distortion
24	Writing over file <filename>	The instrument is writing over an existing file.	Recalling settings; Generating a report
25	Sync Acquisition Problem: Either cannot trigger or the signal levels are out of range.		Triggering

Option VGA Warning messages

Number	Text	Possible causes	Operation where it may occur
1	Sync edge locations questionable. Make sure that the selected format is correct.	The format is set incorrectly.	Measuring H Sync, V Sync, and V Timing
2	H Timing: Incorrect signal in Channel <1-3>. Use Black-White-Black signal. Sync edge locations questionable. Make sure that the selected format is correct.	The format is set incorrectly.	Measuring H Timing
3	H Timing: Incorrect signal in Channel <1-3>. Use Black-White-Black signal.	Black-White-Black signal is not being used.	Measuring H Timing

Option VGA Warning messages (cont.)

Number	Text	Possible causes	Operation where it may occur
4	Invalid Results: Acquisition Problem: Either cannot trigger or the signal levels are out of range or acquired less than the requested samples.	Acquisition failed: Trigger missing, format wrong or other cause of failure to acquire signal.	All measurements
5	Linearity: Signal Change: Channel <x>:	Stability problem while running continuously: ramp went away or number of steps changed.	Measuring Linearity
6	Linearity: Signal Fidelity Problem: Channel <x> Resolution mismatch: Line A<x> bits, Line B <y> bits: Steps not found	For two-line ramps (lower portion of ramp on one line and upper portion of ramp on second line), the bit resolution of the LSB staircase ramps does not match or the total number steps is not equal to $(2^n - 1)$.	Measuring Linearity
7	Linearity: Error occurred in switch accessory	The RGBHV Measurement Interface Unit is not responding properly.	Measuring Linearity
8	Sync edge locations questionable. Make sure that the selected format is correct.	The format is set incorrectly.	Measuring Color Bars, Video Channel Mismatch, Ch-Ch Skew, Luma Levels, Video Channel Mismatch, V Sync, V Timing, and Video Transient.
9	Color Bars: Yellow/Cyan/Green/Magenta/Red/Blue/Black Bar not found.	Color Bars signal is not being used.	Measuring Color Bars.
10	Ch-Ch Skew: Incorrect signal in Channel <1-3>. Use the Alternate White and Black bar signal.	The format is set incorrectly.	Measuring Ch-Ch Skew.
11	Luma Levels: Incorrect signal in Channel <1-3>. Use the Alternate White and Black bar signal.	Alternate White and Black signal is not being used.	Measuring Luma Levels.
12	Video Transient: Incorrect signal in Channel <1-3>. Use the Alternate White & Black signal.	Alternate White and Black signal is not being used.	Measuring Video Transient.
13	H Sync Jitter: Sync edge locations questionable. Make sure the selected format is correct.	The format is set incorrectly.	Measuring H Sync Jitter.
14	Noise: Invalid results for some channels.	The line number is set incorrectly, inappropriate input signal, or incorrect configuration.	Measuring Noise.
15	Ch-Ch Mismatch: Incorrect signal in Channel <1-3>. Use the 32-step Staircase signal in true color mode.	32-step Staircase signal not being used.	Measuring Ch-Ch Mismatch.

Error messages

Number	Text	Possible causes	Operation where it may occur
1	File Name Error: File doesn't exist: <filename>	The selected .vmset file does not exist. (You need to specify the full path if the file is not in the folder C:\VMApps\)	Recalling settings.
2	Cannot write file: file already exists: <filename>	You need to rename <filename> so that the file can be written.	Saving settings; Generating a report.
3	File Name Error. Invalid character(s) in file name	Invalid characters in the filename. Invalid characters are: " ", ".", "/", " ", "<", ">", "*", "\", and "?".	Saving settings; Generating a report.
4	No Measurement Selected	No measurements selected in the Configuration > Measurements menu.	Executing a measurement; Generating a report.
5	Cannot create Report. Not all selected measures have been Run	Need to run a measurement and wait until it completes before generating a report.	Generating a report.
6	Invalid Filename	The file doesn't exist or the path is incorrect. You need to specify the full path if the file is not in the folder C:\VMApps.	RecallSettings; SaveSettings; ReportGenerate (only when called via GPIB).
7	Invalid Argument	Inappropriate argument used for the particular GPIB command.	All GPIB commands.
8	Command Overflow	GPIB commands were sent too rapidly. Increase the delay time between commands to prevent this problem (100 milliseconds interval recommended), or use handshaking with OPComplete.	When GPIB commands are sent too rapidly.
9	Command Missed	This error indicates that a command sent in the last second may not have been processed, so you should return to a recent (known) configuration and resend the most recent commands.	Sending a GPIB command.
10	Error occurred in configuring MIU	Improper serial connection to MIU or one of the CH1/CH2/CH3/CH4 connector cables are disconnected from the VM Series system.	Running any measurement using the MIU.

Applications

Simple Color Bars Measurement – Options SD/HD

Amplitude measurements are typically performed using the color bars test signal, which switches the R'G'B' components on and off to produce all eight possible color combinations (White, Yellow, Cyan, Green, Magenta, Red, Blue, and Black). There are a variety of different forms of the color bar test signal, typically either using a maximum dynamic range of 700 mV = 100% or at 75% with an R'G'B' amplitude of 525 mV. In the following tables, the amplitude ranges for the component Y'P'bP'r are given for the various standards of 100% and 75% color bars.

Amplitude ranges for various 100% color bar signal formats

Color bar	R' (mV)	G' (mV)	B' (mV)	480p/576p			1080/720		
				Y' (mV)	P'b (mV)	P'r (mV)	Y' (mV)	P'b (mV)	P'r (mV)
White	700	700	700	700.0	0.0	0.0	700.0	0.0	0.0
Yellow	700	700	0	620.2	-349.8	56.9	649.5	-350.0	32.1
Cyan	0	700	700	490.7	118.0	-349.9	551.2	80.2	-350.0
Green	0	700	0	410.9	-231.7	-293.0	500.6	-269.8	-317.9
Magenta	700	0	700	289.1	231.7	293.0	199.4	269.8	317.9
Red	700	0	0	209.3	-118.0	349.9	148.8	-80.2	350.0
Blue	0	0	700	79.8	349.8	-56.9	50.5	350.0	-32.1
Black	0	0	0	0.0	0.0	0.0	0.0	0.0	0.0

Amplitude ranges for various 75% color bar signal formats

Color bar	R' (mV)	G' (mV)	B' (mV)	480p/576p			1080/720		
				Y' (mV)	P'b (mV)	P'r (mV)	Y' (mV)	P'b (mV)	P'r (mV)
White	700	700	700	700.0	0.0	0.0	700.0	0.0	0.0
Yellow	525	525	0	465.2	-262.3	42.7	487.1	-262.5	24.1
Cyan	0	525	525	368.0	88.5	-262.4	413.4	60.2	-262.5
Green	0	525	0	308.2	-173.8	-219.7	375.5	-202.3	-238.4
Magenta	525	0	525	216.8	173.8	219.7	149.5	202.3	238.4
Red	525	0	0	157.0	-88.5	262.4	111.6	-60.2	262.5
Blue	0	0	525	59.9	262.3	-42.7	37.9	262.5	-24.1
Black	0	0	0	0.0	0.0	0.0	0.0	0.0	0.0

Depending on the type of equipment being tested, a variance in the actual values is allowed. For example, the progressive outputs of DVD players can introduce setup to their outputs that can vary the overall measured results. Variations in the level of the components can introduce different hue and saturation in the displayed picture. The color bar test signal lets you check for gain inequalities between the channels and to ensure that the signal is not distorted, which could produce severe clipping of the signal.

The Tektronix Matrix pattern uses a 100% color bar signal to test the full dynamic range of each component. The color bar pattern is located at or near the top of the matrix pattern; the line numbers at which it occurs are different for each standard. The line numbers specified are the default values used to generate the test matrix but some systems under test may shift lines in the image to a different location.

Format	1080i	720p	480p	576p
Line	21 - 84	26 - 153	43 - 106	45 - 108
Location	584 - 647			

The VM Series system performs the color bar measurements by first identifying the relative amplitudes of each of the three channels. Eight amplitude measurements are made on each channel, giving a total of 24 measurements in less than half a second; the following steps show the typical measurement results performed on a 1080i signal. The amplitude level of each of the bar levels is measured relative to the back porch. Amplitudes are calculated using waveform averaged values within each identified bar. Therefore, it is important to ensure that the full video is displayed in the capture window of the instrument if manual setup has been performed on the unit.

1. Power on the instrument.

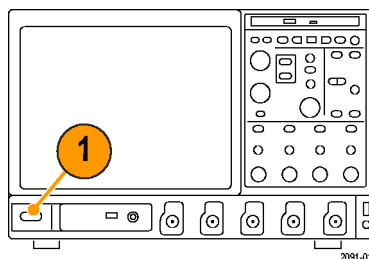

2. Select **Analyze > VM HD and SD Video V3.2**.

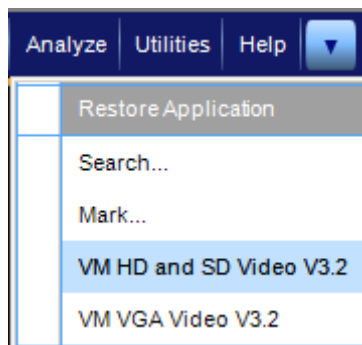

3. In the VM Series system application, select **File > Recall Default Setup** to return all settings to the factory default values.

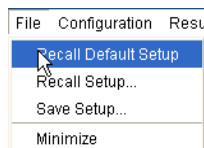

4. Connect a signal to the inputs. (See page 9, *Connecting Input Signals*.)
5. Set the input signal format. (See page 32, *Setting the Input Signal Format – Options SD/HD*.)

6. Select **Configuration > Measurements**.

Note that Color Bars is selected by default.

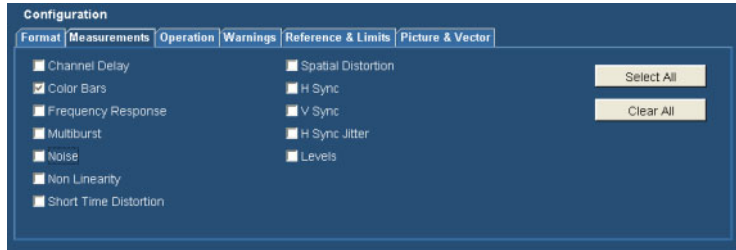

7. Click the Run button.

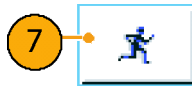

When the measurements are complete, the results screen is displayed.

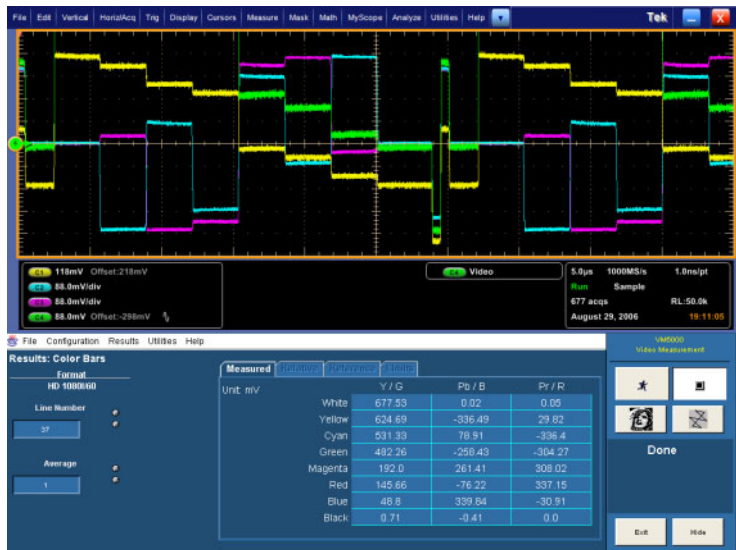

Simple Color Bars Measurement – Option VGA

Amplitude measurements are typically performed using the color bars test signal, which switches the RGB components on and off to produce all eight possible color combinations (White, Yellow, Cyan, Green, Magenta, Red, Blue, and Black). There are a variety of different forms for the color bar test signal, typically either using a maximum dynamic range of 700 mV = 100% or at 75% with an RGB amplitude of 525 mV. The following table shows the amplitude for the RGB signal at 100% and 75%.

Amplitude for 100% color bar signal

Color bar	R (mV)	G (mV)	B (mV)
White	700	700	700
Yellow	700	700	0
Cyan	0	700	700
Green	0	700	0
Magenta	700	0	700
Red	700	0	0
Blue	0	0	700
Black	0	0	0

Amplitude for 75% color bar signal formats

Color bar	R (mV)	G (mV)	B (mV)
White	700	700	700
Yellow	525	525	0
Cyan	0	525	525
Green	0	525	0
Magenta	525	0	525
Red	525	0	0
Blue	0	0	525
Black	0	0	0

The Tektronix Matrix pattern uses a 100% color bar signal to test the full dynamic range of each component. The color bar pattern is located near the top of the matrix pattern; the line numbers at which it occurs are different for each format. The following tables show the line numbers on which the different patterns in the Matrix signal are located for a 60 Hz refresh rate. For other refresh rates, the actual starting line number can be noticeably different than the 60 Hz rate. To view the active video line number location for a specific pattern at another refresh rate, locate the Microsoft Excel file, Matrix.xls, located on the VM Series system software CD. This file lists the actual Active Video line numbers for all supported refresh rates.

Active Video Line Number Location of Patterns at 60 Hz Refresh Rate (640x480 to 1280x1024)

Pattern	640x480	800x600	1024x768	1280x1024
Half White and Half Black	36 – 83	28 – 87	36 – 112	42 – 143
Nine Colorbars	84 – 179	88 – 207	113 – 265	144 – 348
32 Steps	180 – 227	208 – 267	266 – 342	349 – 450
Alternate White and Black	228 – 275	268 – 327	343 – 419	451 – 552
Black White Black	276 – 323	328 – 387	420 – 496	553 – 654
Full White	324 – 371	388 – 447	497 – 572	655 – 756

Active Video Line Number Location of Patterns at 60 Hz Refresh Rate (640x480 to 1280x1024) (cont.)

Pattern	640x480	800x600	1024x768	1280x1024
Ramp	372 – 467	448 – 567	573 – 726	757 – 962
Half White and Half Black	468 – 515	568 – 627	727 – 803	963 – 1065

Active Video Line Number Location of Patterns at 60 Hz Refresh Rate (1600x1024 to 1900x1200)

Pattern	1600x1024	1600x1200	1920x1080	1920x1200
Half White and Half Black	36 – 132	50 – 169	38 – 140	43 – 162
Nine Colorbars	143 – 337	170 – 409	150 – 356	163 – 402
Staircase	347 – 439	410 – 529	366 – 464	403 – 522
Alternate White and Black	450 – 542	530 – 649	474 – 572	523 – 642
Black White Black	552 – 644	650 – 769	582 – 680	643–762
Full White	655 – 747	770 – 889	690 – 788	763 – 882
Ramp	757 – 951	890 – 1129	798 – 1004	883 – 1122
Half White and Half Black	962 – 1059	1130 – 1249	1014 – 1117	1123 – 1242

Active Video Line Number Location of Patterns at 60 Hz Refresh Rate (1920x1440 to 2048x2048)

Pattern	1920x1440	2048x1536	2048x2048
Half White and Half Black	50 – 193	53 – 198	71 – 265
Nine Colorbars	194 – 481	213 – 505	285 – 674
Staircase	482 – 625	520 – 659	695 – 879
Alternate White and Black	626 – 769	674 – 812	899 – 1084
Black White Black	770 – 913	828 – 966	1104 – 1289
Full White	914 – 1057	981 – 1120	1309 – 1493
Ramp	1058 – 1345	1135 – 1427	1514 – 1903
Half White and Half Black	1346 – 1489	1442 – 1588	1923 – 2118

The VM Series system performs the color bars measurements by first identifying the relative amplitudes of each of the three channels. Eight amplitude measurements are made on each channel, giving a total of 24 measurements in less than half a second; the following steps show the typical measurement results performed on a 1024x768 signal. The amplitude level of each of the bar levels is measured relative to the back porch. Amplitudes are calculated using waveform averaged values within each identified bar. Therefore, it is important to ensure that the full video is displayed in the capture window of the instrument if manual setup has been performed on the unit.

1. Power on the instrument.

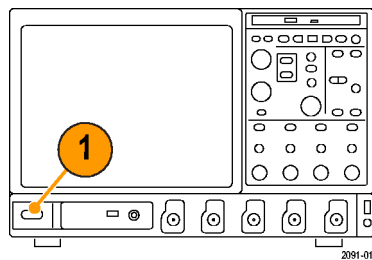

2. Select **Analyze > VM VGA Video V3.2**.

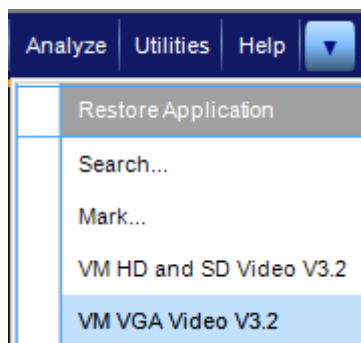

3. In the VM Series system application, select **File > Recall Default Setup** to return all settings to the factory default values.

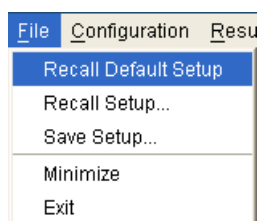

4. Connect a signal to the inputs. (See page 9, *Connecting Input Signals*.)
5. Select the input signal format. (See page 34, *Setting the Input Signal Format – Option VGA*.)
6. Select **Configuration > Measurements**. Note that Color Bars is selected by default.



7. Click the Run button.



When the measurements are complete, the results screen is displayed.

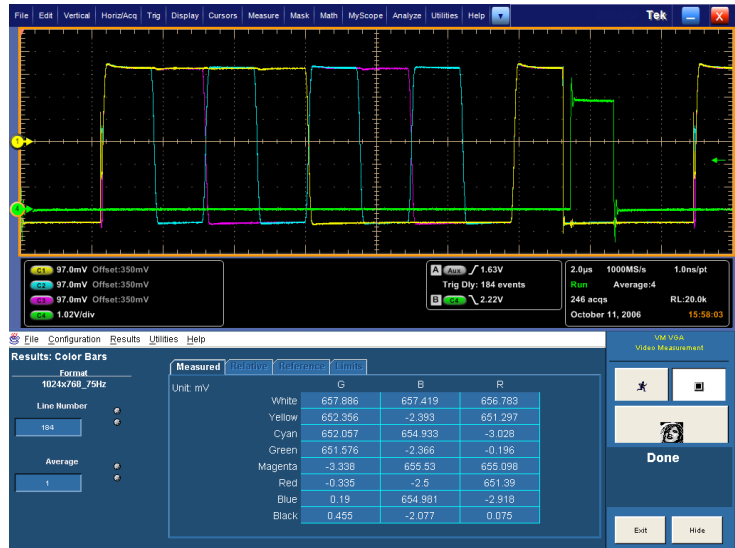

Displaying Relative to Reference Color Bar Measurements

The VM Series system displays measurement results two ways: as measured and relative to a reference value. The relative value is calculated by subtracting the measured value from a reference value. To display measurement results relative to a reference, you must select **Enable Relative Results** in the **Reference & Limits** tab of the Configuration screen. Reference values are specified in special comma-separated-value (CSV) text files. The VM Series system includes a set of template files that you can edit, so that you can specify the reference values appropriate to your application.

1. Power on the instrument.

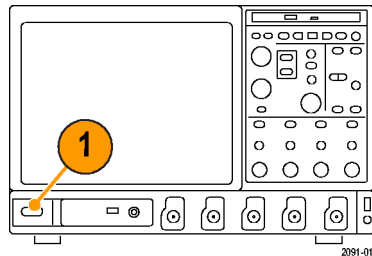

2. Select **Analyze > VM HD and SD Video V3.2** or **VM VGA Video V3.2**.

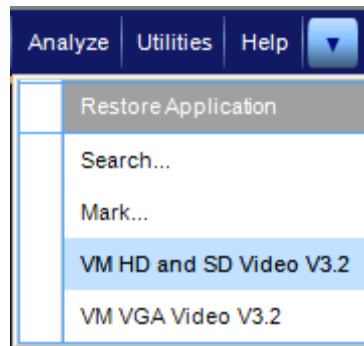

- In the VM Series system application, select **File > Recall Default Setup** to return all settings to the factory default values.

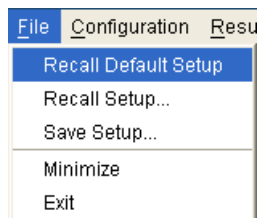

- Connect a signal to the inputs. (See page 9, *Connecting Input Signals*.)
- Select the input signal format. (See page 32, *Setting the Input Signal Format – Options SD/HD*.) (See page 34, *Setting the Input Signal Format – Option VGA*.)
- Select **Configuration > Reference & Limits**.

- Check **Enable Relative Result Display**.
By default, the VM Series system application automatically selects a reference file from a set of supplied templates, matched to the selected signal format.

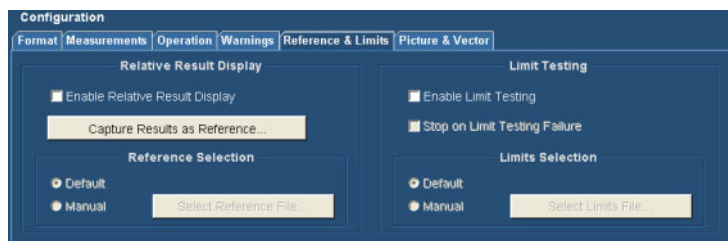

- Click the Run button.



When the measurements are complete, the results screen is displayed. Note that the Relative and Reference tabs are now selectable.



Option SD/HD

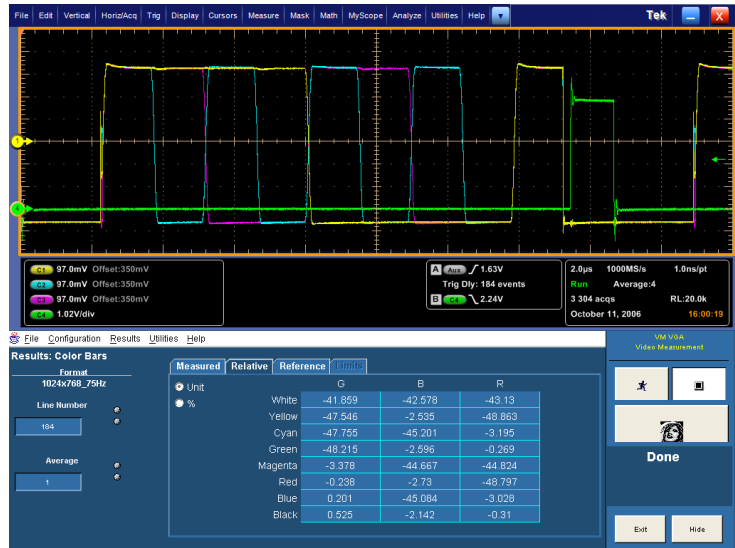

Option VGA

- Select the **Reference** tab to display the Reference values used to calculate the Relative values.



Option SD/HD

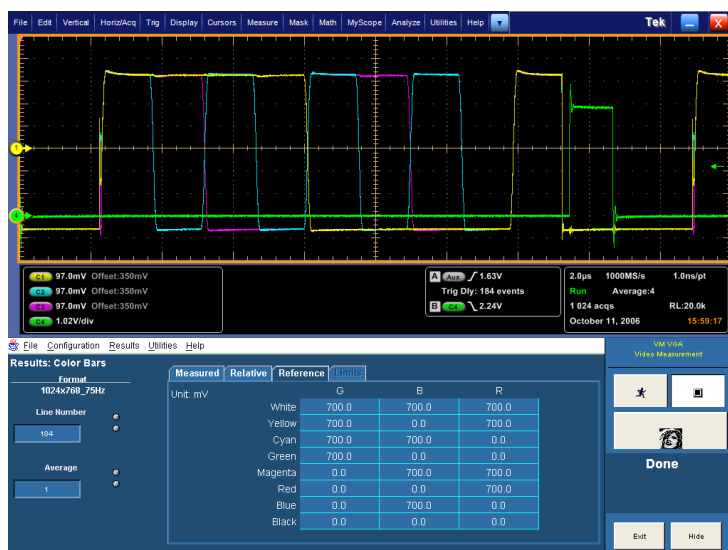

Option VGA

- Select the **Relative** tab to display the calculated Relative values.



- Select the % option button to display the percent difference between the measured value and the reference value.



Option SD/HD

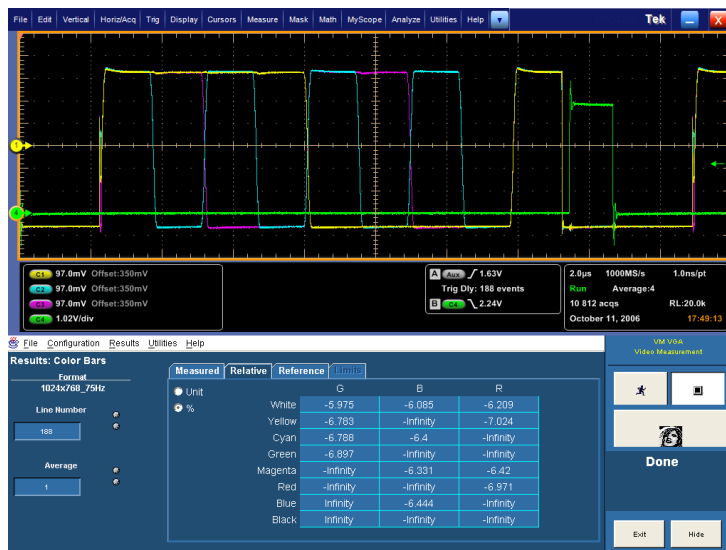

Option VGA

Displaying Color Bar Measurements with Limit Testing

The VM Series system can display measurement results compared to a limit value and with a pass/fail indication. As with the relative measurements, the limit value is specified in a CSV-format text file. The VM Series system includes a set of template files that you can edit, so that you can specify the limit values appropriate to your application. Limit values consist of a maximum and minimum. Measured values that fall between the maximum and minimum limit values are considered to have passed the limit test. Measured values that fall outside the maximum and minimum limit values are considered to have failed the limit test.

1. Power on the instrument.

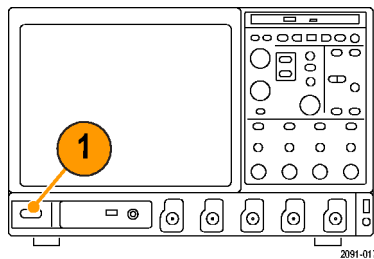

2. Select **Analyze > VM HD and SD Video V3.2** or **VM VGA Video V3.2**.

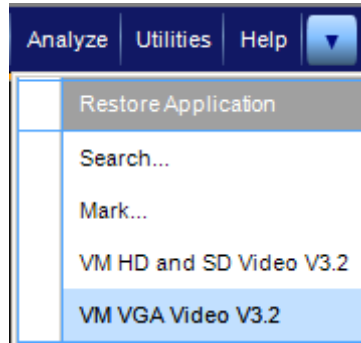

3. Select **File > Recall Default Setup** to return all settings to the factory default values.

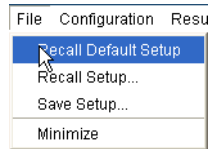

Option SD/HD

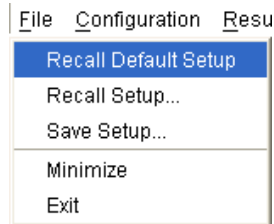

Option VGA

4. Connect a signal to the inputs. (See page 9, *Connecting Input Signals*.)
5. Select the input signal format. (See page 8, *Input Connection Requirements – Options SD/HD*.) (See page 8, *Input Connection Requirements – Option VGA*.)

6. Select Configuration > Reference & Limits.

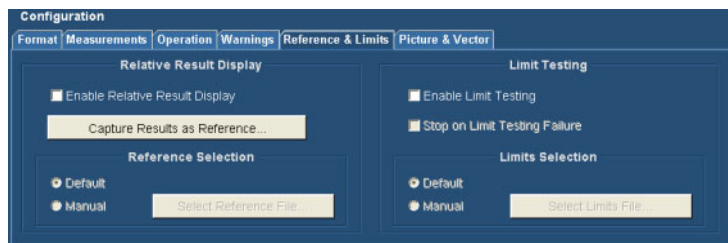

Option SD/HD

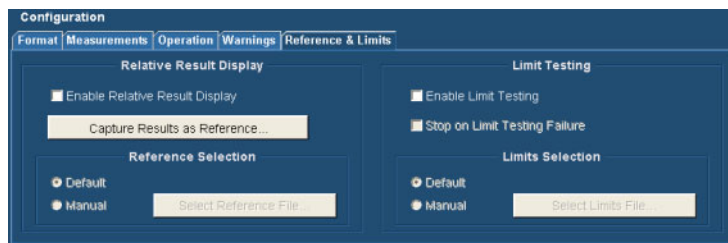

Option VGA

7. Select Enable Limit Testing.

By default, the VM Series system application automatically selects a limit file from a set of supplied templates, matched to the selected signal format.

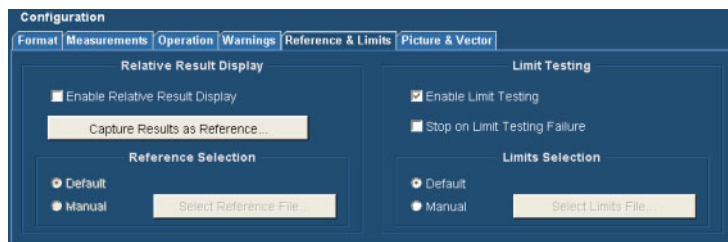

Option SD/HD

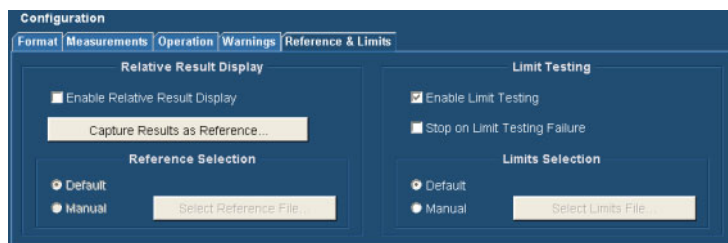

Option VGA

8. Click the Run button.



When the measurements are complete, the results screen is displayed. Note that the Limits tab is now selectable.

When limit testing is enabled, results are displayed in either green or red text. Green text indicates pass (the measured value did not exceed the limit values). Red text indicates failure (the measured value exceeded the max or min limit value).



Option SD/HD

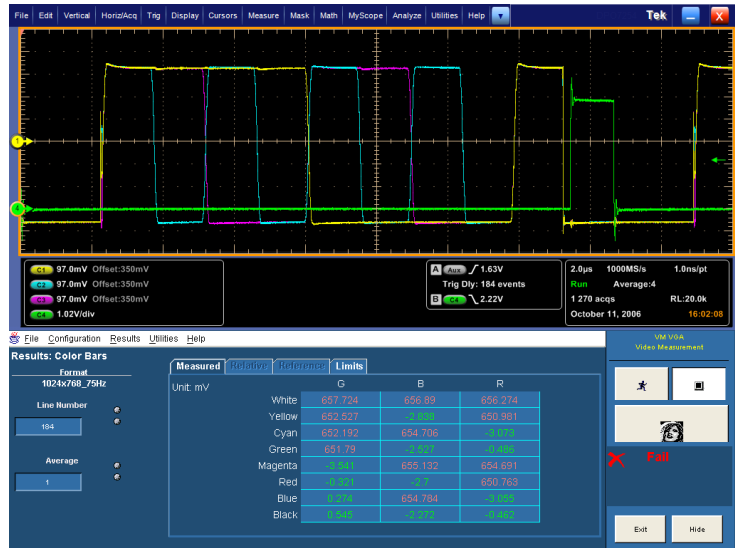

Option VGA

- Select the **Limits** tab to display the Limit values used.

Select either **min** or **max** to see the limits specified for the minimum and maximum acceptable values.



Option SD/HD

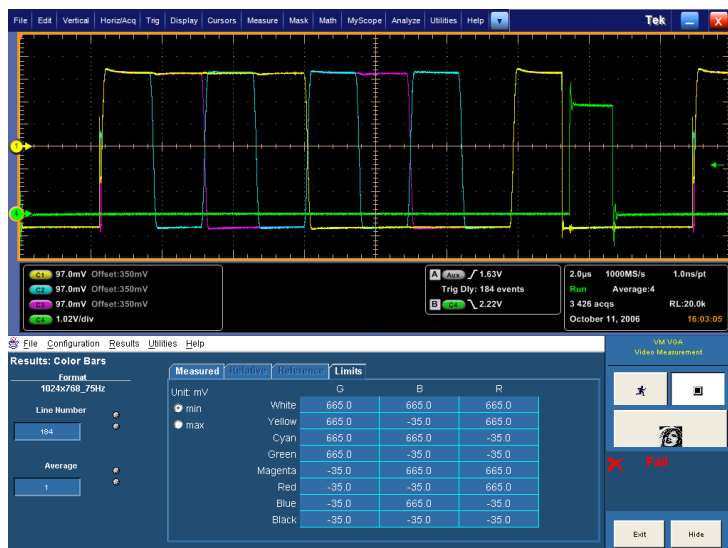

Option VGA

Performing Limit Testing with Two Measurements

The VM Series system can perform limit testing with more than one measurement at a time.

1. Power on the instrument.

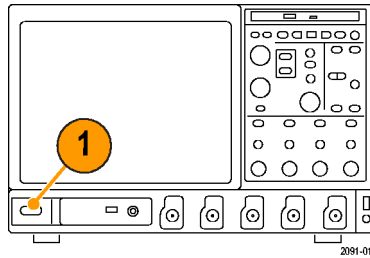

2. Select **Analyze > VM HD and SD Video V3.2** or **VM VGA Video V3.2**.

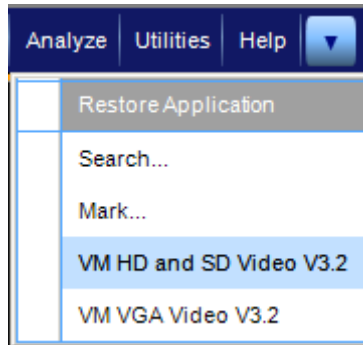

Option SD/HD

3. Select **File > Recall Default Setup** to return all settings to the factory default values.

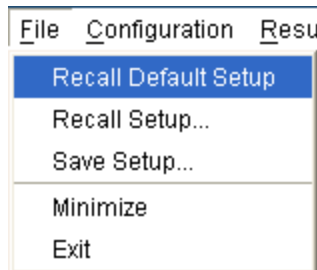

4. Connect a signal to the inputs. (See page 9, *Connecting Input Signals*.)
5. Select the input signal format. (See page 32, *Setting the Input Signal Format – Options SD/HD*.) (See page 34, *Setting the Input Signal Format – Option VGA*.)

6. Select **Configuration > Reference & Limits**.

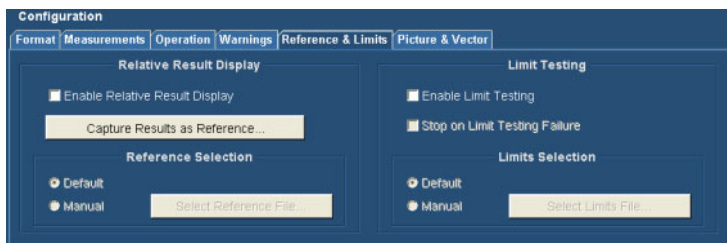

Option SD/HD

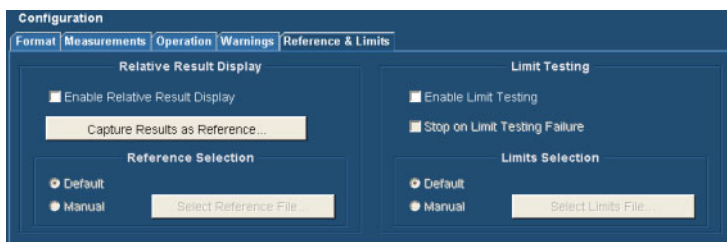

Option VGA

7. Select **Enable Limit Testing**.

By default, the VM Series system application automatically selects a limit file from a set of supplied templates, matched to the selected signal format.

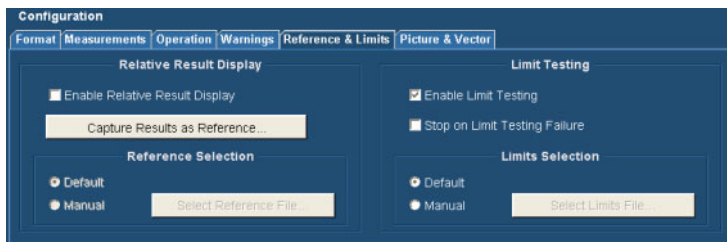

Option SD/HD

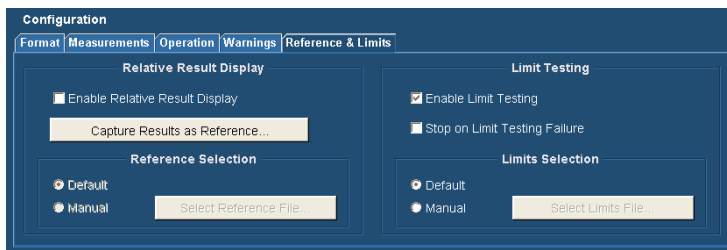

Option VGA

8. Click the **Measurements** tab to select the measurement to be performed.

9. Select two measurements:

- Option SD/HD: Select **Color Bars** and **H Sync**.



2091-072

Option SD/HD

- Option VGA: Select **Color Bars** and **Luma Levels**.

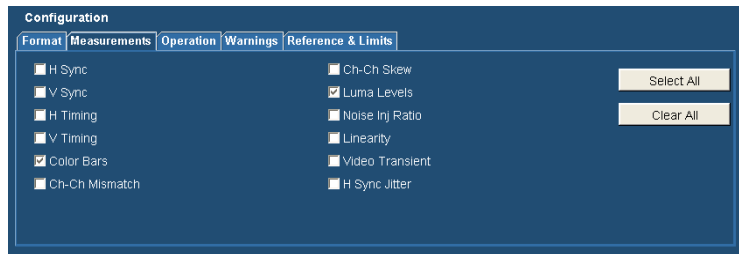

Option VGA

10. Click the Run button.



When the measurements start, the measurement status screen appears. As the measurements are completed, Pass (or Fail) is displayed for the selected measurements.



Option SD/HD



Option VGA

- To display the results of each selected measurement, select the **Results** menu and select one of the selected measurements.

The results screen for the selected measurement is displayed.



Option SD/HD



Option VGA

- To display the results of the other selected measurement, select the **Results** menu and select the other measurement.



Option SD/HD



Option VGA

Taking Measurements Across Multiple Lines

When the VM Series system takes a measurement, where the measurement is taken (you could also say when the measurement is taken) is specified by the line number. (If you want to measure the Luma Level, you need to make sure the measurement is taken within the active video portion of the signal.) Sometimes you will need to take a measurement across more than one line. (For example, you might need to verify that the Levels are consistent from the top to the bottom of the display.) To do this, use the Multi Lines setting under Line Select on the Operation tab. Each measurement requires an appropriate signal pattern to be present on a specified line of the input video signal. This line number setup parameter is configured via the "Line Number" input box in the measurement's results panel. The signal pattern is generally available on multiples lines of the input signal. The measurement can be performed by specifying any of those individual lines.

NOTE. Some measurements are not available in Multiple Lines mode. The Setup Only, Run Only and Continuously settings (Operation panel) are not selectable in Multiple Lines mode.

When the instrument is in Multiple lines mode, measurements are performed sequentially on each of the line numbers in the range specified for the selected measurement(s). The results for the individual lines are averaged and then displayed in the measurement's results panel. The specified line numbers for the selected measurement is displayed in the Line Number field in the corresponding results panel. When the Run Mode is set to Once & Report, the instrument generates a report file in the selected format (RTF, PDF or CSV), that contains the results for all of the individual line numbers in the selected range, followed by the averaged results calculated for the whole range.

1. Power on the instrument.

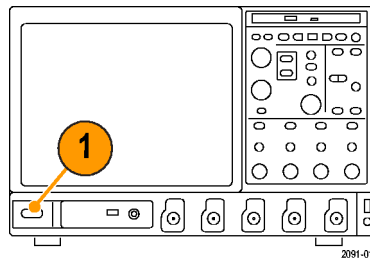

2. Select **Analyze > VM HD and SD Video V3.2** or **VM VGA Video V3.2**.

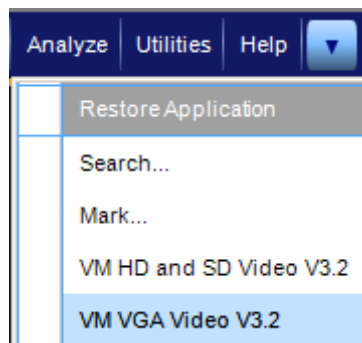

3. In the VM Series system application, select **File > Recall Default Setup** to return all settings to the factory default values.

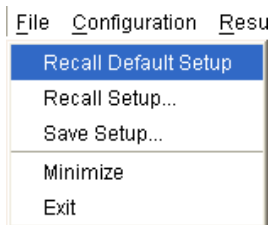

4. Connect a signal to the inputs. (See page 9, *Connecting Input Signals*.)
5. Select **Configuration > Format** and select the format settings as necessary.
6. Select **Configuration > Operation**.

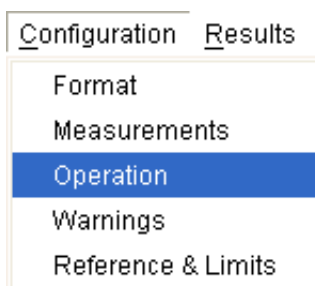

Option VGA

7. Click **Multi Lines** in the Line Select section.

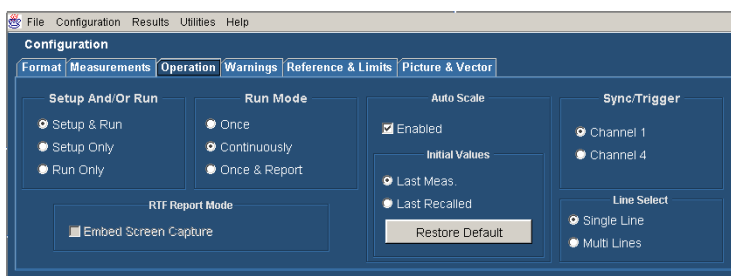

Option SD/HD

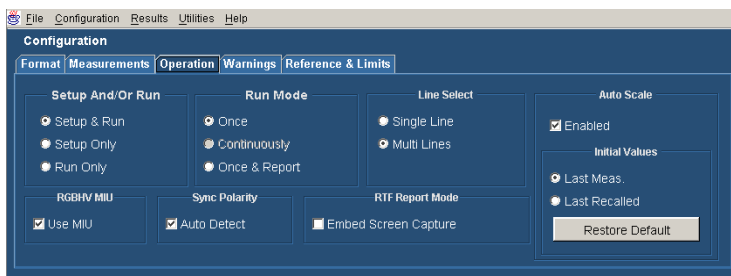

Option VGA

- To specify the measurements and the lines on which measurements are taken, select the Measurements tab.

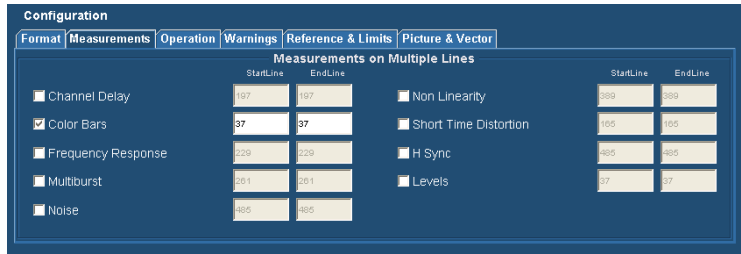

Option SD/HD

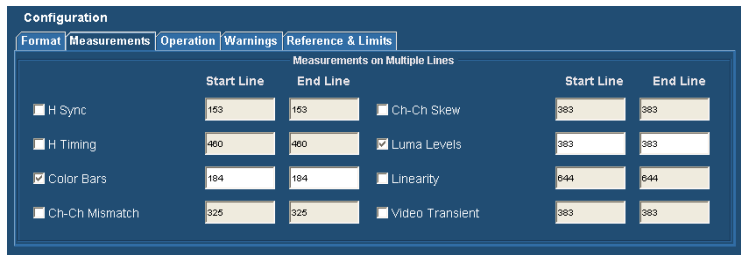

Option VGA

For each measurement there are two entry boxes: Start Line and End Line. Use these two boxes to specify the range of lines across which you want the measurement taken.

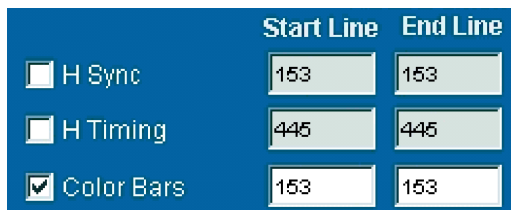

- To select a measurement to be taken, click the checkbox next to the measurement name.

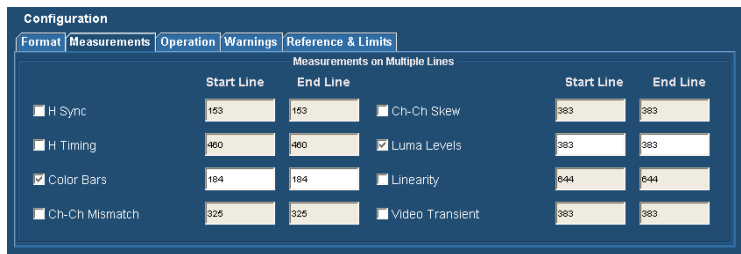

Option VGA

- Enter line numbers in the Start Line and End Line boxes.

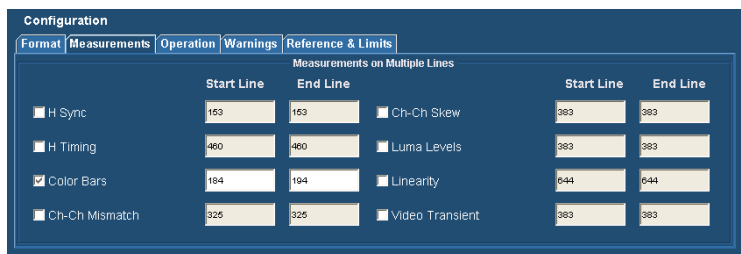

Option VGA

When the Run Mode is set to Once & Report, the instrument will generate a report after completing the measurements. By default, the instrument automatically generates a unique file name for the report file. However, you can specify a file name and save location.

11. To specify the parameters of the file in which the results will be saved:

- Click **Utilities > Generate Report**.
This displays the Generate Report panel.

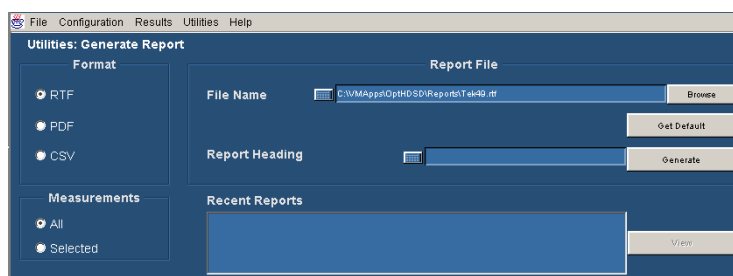

12. To change the filename and save location, click **Browse**. This displays the **Save** dialog.

13. Enter the filename or navigate to the desired location to save the file.

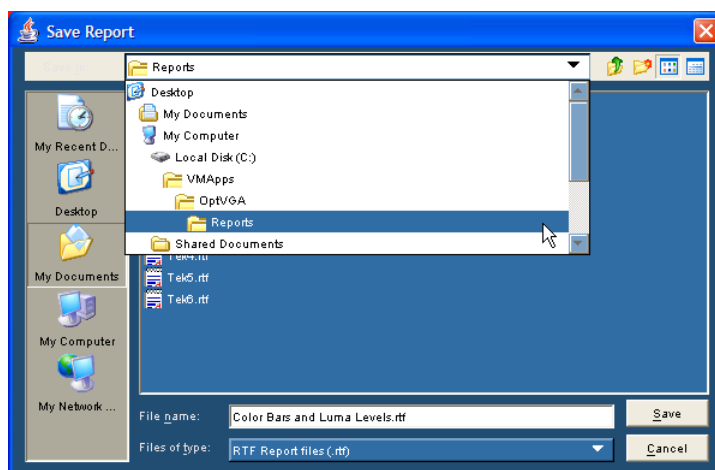

14. Select the format of the report from the options listed under **Files of type**.

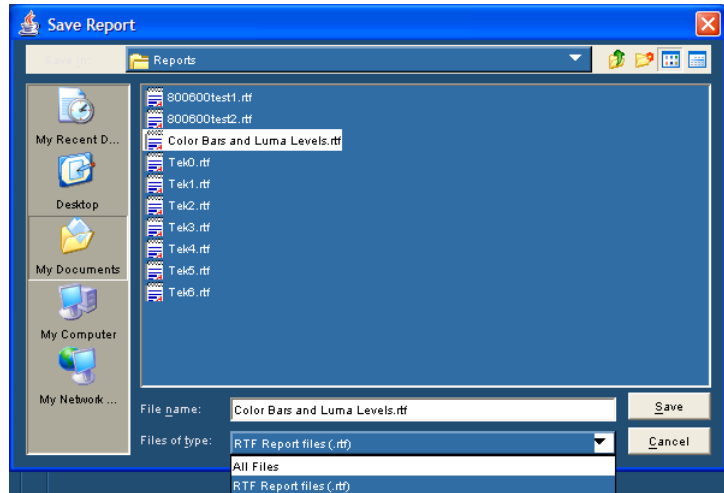

15. Click **Save**.
16. If you want to save a screen capture of the signal in the report, select **Configuration > Operation** to display the Operations panel. Select **Embed Screen Capture** under **RTF Report Mode**.

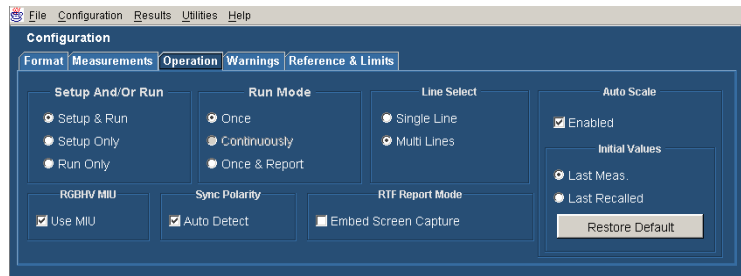

Option VGA

17. Select the **Run** button to take the measurements.
 After you select Run, the VM Series system displays the results page for the first of the selected measurements and begins taking measurements. The displayed Line Number increments after each measurement is taken until the measurement for each of the specified lines has been taken. The process repeats for each selected measurement.

- To view the results of the measurements, open the report file using the appropriate application.

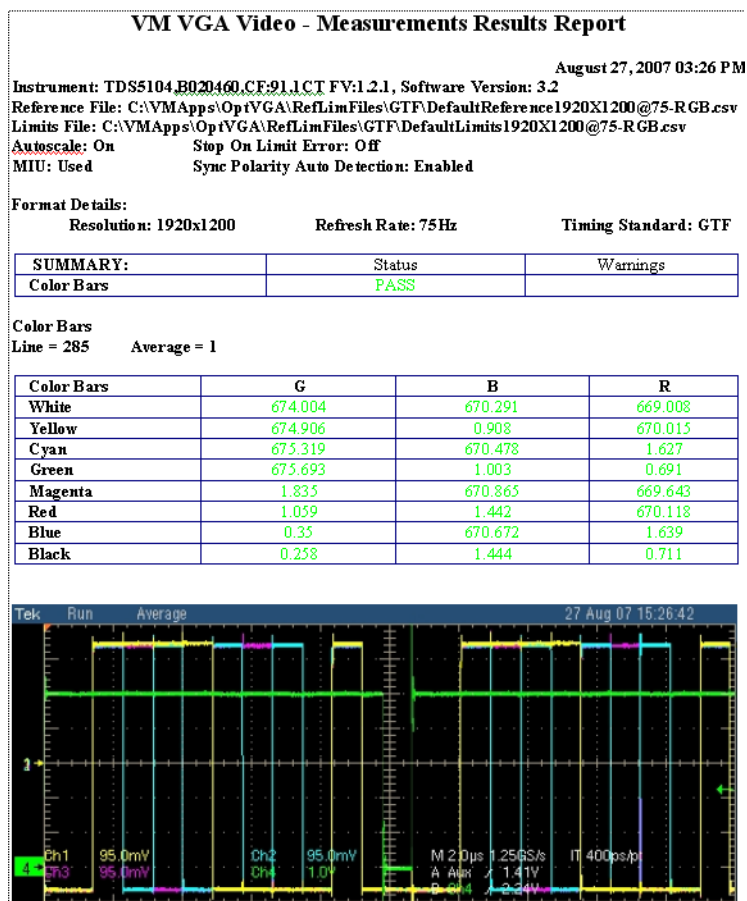

Displaying the Input Signal as a Picture

The VM Series system can display the input signal as a picture.

- Power on the instrument.

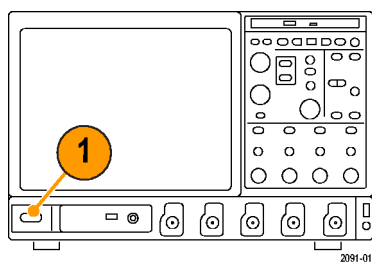

2. Select **Analyze > VM HD and SD Video V3.2** or **VM VGA Video V3.2**.

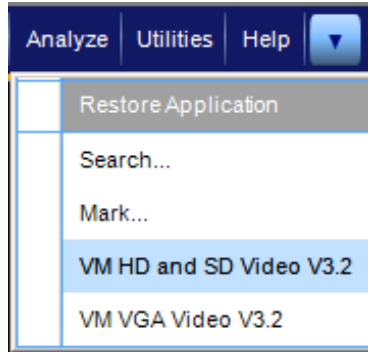

3. Connect a signal to the inputs. (See page 9, *Connecting Input Signals*.)

4. Select the picture button. This launches the video monitor window.



5. Click the maximize button to expand the picture to full screen.

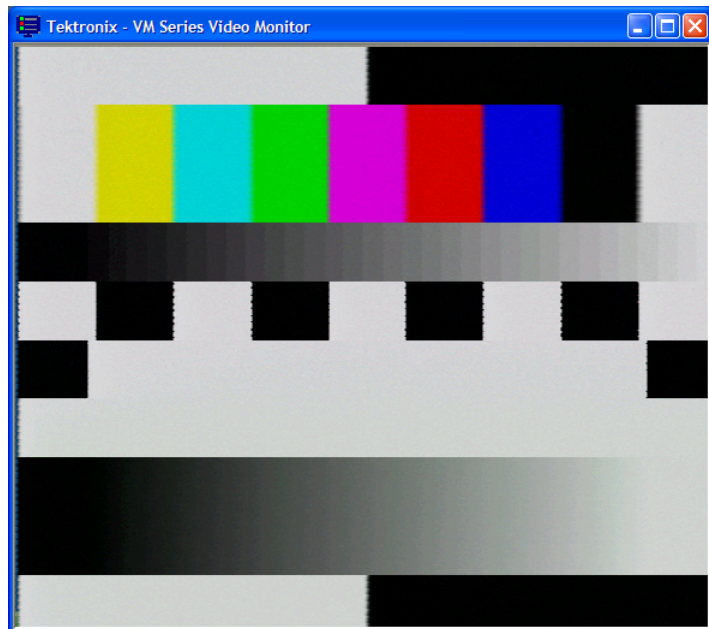

Displaying the Input Signal in a Vectorscope Window – Options SD/HD Only

The VM Series system can display the input signal in a vectorscope window so that you can quickly see the color range of the signal.

1. Power on the instrument.

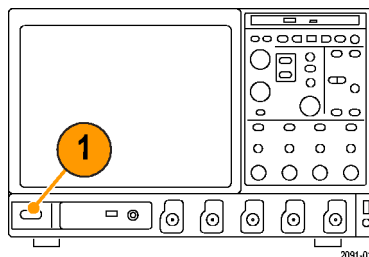

2. Select **Analyze > VM HD and SD Video V3.2**.

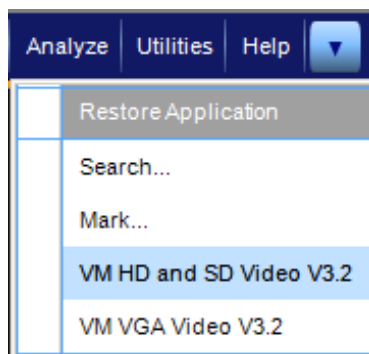

3. Connect a signal to the inputs. (See page 9, *Connecting Input Signals*.)

4. Select the Vectorscope button.
This launches the video monitor display window.



5. Click the maximize button to expand the vectorscope display to full screen.

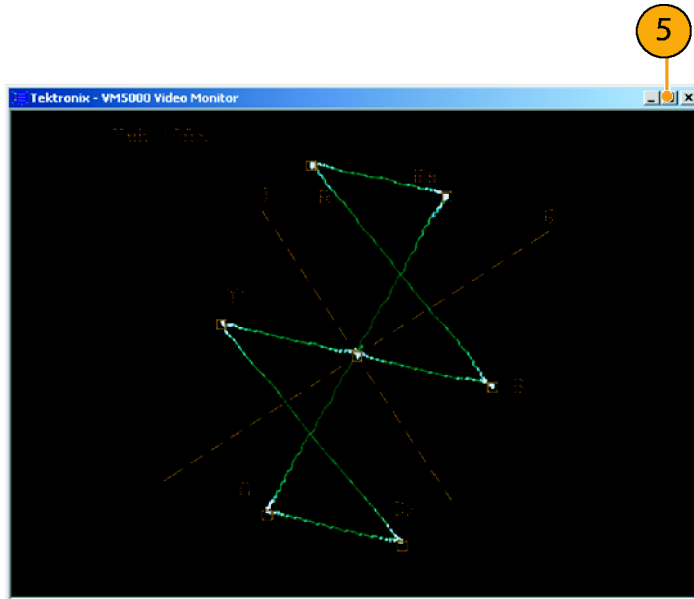

Index

A

accessories
 standard, 3
 Accessories, 1
 Auto Scale
 buttons, 39

B

Buttons
 App, 29
 Exit, 29
 Hide, 28
 Picture, 28
 Run, 28
 Stop, 28
 Vectorscope, 28

C

calibration, 20
 Channel 1/4 option buttons, 39
 compensating sync pickoff, 20
 connecting signals, 9
 Continuously option button, 39
 control panel, 6

D

documentation, vi

E

error and warning messages, 44

F

front panel map, 6

I

input requirements, 8
 input signal format
 setting, 32, 34
 instruments supported, v

L

Limit Testing, 59, 64

line number
 starting, 51

M

Matrix signal
 description, 24
 Matrix signal pattern
 starting line, 51
 measurements
 selecting, 37
 taking, 30
 messages, 44
 Multiple Lines, 70

N

network connection, 5

O

Once & Report option button, 39
 operating specifications, 4
 operations
 setting, 38
 Option buttons
 Auto Scale Enabled, 39
 Channel 4, 39
 Continuously, 39
 Once, 39
 Once & Report, 39
 Run Mode, 39
 Run Only, 39
 Setup & Run, 39
 Setup Only, 39
 oscilloscope
 using the, 42
 oscilloscopes supported, v

P

Pass / Fail testing, 59
 Picture display, 75
 power supply
 requirements, 4

R

rear panel map, 7

related documentation, vi
 Relative to Reference
 measurements, 54
 RGBHV Measurement Interface Unit
 connecting, 13
 Run Only option button, 39

S

Safety Summary, iii
 selecting measurements, 37
 setting
 input signal format, 32, 34
 measurement run
 operations, 38
 warnings, 40
 Setup & Run option button, 39
 Setup Only option button, 39
 side panel map, 7
 signals
 connecting, 9
 software upgrades, vi
 specifications
 operating, 4
 power supply, 4
 standard accessories, 3
 starting line number
 Matrix signal, 51
 supported instruments, v
 switch accessory, 40
 sync pickoff
 compensation, 20
 connecting, 9

T

taking a measurement, 41

U

User-Defined Format
 creating, 33, 35
 using the oscilloscope, 42

V

Vectorscope display, 77
 VESA test procedure
 version, 30

viewing measurement results, 41

W

warning and error messages, 44

Warning Types Reported, 40