

Printed Help Document



TDSET3 Ethernet Compliance Test Software

Adapted from the TDSET3 Ethernet Compliance Test Software Online Help
077000501, Version 1.3.0, 2005

This document supports software version 1.3.0
and above.

Warning

The servicing instructions are for use by
qualified personnel only. To avoid personal
injury, do not perform any servicing unless you
are qualified to do so. Refer to all safety
summaries prior to performing service.

Copyright © Tektronix, 2005, Inc. All rights reserved. Licensed software products are owned by Tektronix or its suppliers and are protected by United States copyright laws and international treaty provisions.

Use, duplication, or disclosure by the Government is subject to restrictions as set forth in subparagraph (c)(1)(ii) of the Rights in Technical Data and Computer Software clause at DFARS 252.227-7013, or subparagraphs (c)(1) and (2) of the Commercial Computer Software – Restricted Rights clause at FAR 52.227-19, as applicable.

Tektronix products are covered by U.S. and foreign patents, issued and pending. Information in this documentation supercedes that in all previously published material. Specifications and price change privileges reserved.

Tektronix, Inc., P.O. Box 500, Beaverton, OR 97077

TEKTRONIX, TEK and TEKPROBE are registered trademarks of Tektronix, Inc.
TDSET3 077000501, Version 1.3.0, 2005.

Table of Contents

About TDSET3	1-1
Using Online Help	1-2
Printing from the Online Help	1-3
Conventions	1-3
Contacting Tektronix	1-4
Feedback.....	1-5
Information through the Web site	1-5
Getting Started.....	2-1
Compatibility	2-1
Recommended Accessories	2-2
Requirements and Restrictions.....	2-3
About the Test Fixture.....	2-4
Starting the Application	2-5
Minimizing and Maximizing the Application	2-6
Returning to the Application.....	2-6
Exiting the Application	2-7
Application Directories and File Names	2-7
Application Software Default Layouts and Templates.....	2-8
Application Software Default Settings.....	2-10
Operating Basics	3-1
TDSET3 Application Window.....	3-1
TDSET3 Application Interface Controls.....	3-1
Menu bar	3-2
File Menu.....	3-2

Tests Menu	3-3
Results Menu	3-4
Utilities Menu	3-4
Help Menu	3-5
Selection pane	3-5
Speed pane	3-6
Client pane	3-6
1000BASE-T Client pane.....	3-7
100BASE-TX Client pane.....	3-7
10BASE-T Client pane.....	3-7
Execution pane	3-8
Status bar	3-8
Result pane	3-9
Result Summary pane.....	3-10
Report Configuration pane.....	3-11
Dialog Boxes	3-11
Preferences dialog box.....	3-11
Advanced Report Configuration dialog box.....	3-15
Result Details dialog box.....	3-16
Locate Hits dialog box.....	3-17
Flash Hits dialog box.....	3-17
Show Segments dialog box.....	3-18
Manual Fit dialog box.....	3-18
Jig match dialog box.....	3-19
Virtual Keyboard dialog box.....	3-24
Virtual Keypad dialog box.....	3-24
Mask Setup dialog box.....	3-25

Smooth dialog box.....	3-26
Exit dialog box.....	3-27
How To Select Test Parameters	4-1
Selecting 1000BASE-T Test Parameters	4-1
Selecting 100BASE-TX Test Parameters	4-1
Selecting 10BASE-T Test Parameters	4-2
How To Configure Parameters	5-1
Configuring 1000BASE-T	5-1
Configuring 100BASE-TX.....	5-5
Configuring 10BASE-T	5-7
Making Connections	6-1
1000BASE-T Connections.....	6-1
Template, Peak Volt, Droop, and Distortion	6-1
Jitter Master Filtered.....	6-5
Jitter Master Unfiltered.....	6-8
Jitter Slave Filtered.....	6-11
Jitter Slave Unfiltered.....	6-15
Return Loss.....	6-17
Return Loss Calibration.....	6-19
CM Voltage	6-20
100BASE-TX Connections	6-22
All Tests except Return Loss.....	6-22
Return Loss.....	6-23
Return Loss Calibration.....	6-24
10BASE-T Connections.....	6-25
Link Pulse.....	6-25
MAU.....	6-28

TP_IDL	6-29
Jitter with cable	6-31
Jitter without cable	6-33
Differential Voltage	6-35
Harmonic	6-36
Return Loss	6-37
Return Loss Calibration	6-38
CM Voltage	6-40
Set up the Signal.....	7-1
1000BASE-T	7-1
100BASE-TX.....	7-1
10BASE-T	7-2
How To Test 1000BASE-T	8-1
Template.....	8-1
Peak Volt	8-3
Droop.....	8-5
Jitter Master Filtered	8-7
Jitter Master Unfiltered	8-11
Jitter Slave Filtered	8-16
Jitter Slave Unfiltered	8-20
Distortion	8-26
Return Loss	8-29
CM Voltage.....	8-31
How To Test 100BASE-TX.....	9-1
Template.....	9-1
Differential Output Voltage.....	9-3
Signal Amplitude Symmetry	9-5

Rise Time	9-6
Fall Time.....	9-8
Rise/Fall Time Symmetry	9-11
Waveform Overshoot.....	9-12
Jitter	9-14
Duty Cycle Distortion	9-16
Return Loss	9-17
How To Test 10BASE-T	10-1
MAU	10-1
Link Pulse	10-4
TP_IDL.....	10-7
Differential Voltage	10-10
Harmonic.....	10-12
Jitter with cable.....	10-13
Jitter without cable	10-16
Return Loss	10-19
CM Voltage.....	10-21
View Waveform for 1000BASE-T	11-1
Template, Peak Volt, Droop	11-1
Jitter Master.....	11-2
Jitter Slave	11-3
Distortion	11-5
Return Loss	11-6
CM Voltage.....	11-6
View Waveform for 100BASE-TX.....	12-1
All 100BASE-TX Tests except Return Loss.....	12-1
Return Loss	12-1

View Waveform for 10BASE-T	13-1
Link Pulse	13-1
MAU	13-1
TP_IDL	13-2
Jitter with or without cable.....	13-2
Differential Voltage	13-3
Harmonic.....	13-4
Return Loss	13-4
CM Voltage.....	13-5
Generate Reports.....	14-1
About Report Generator.....	14-2
Automating AWG	15-1
Automate AWG	15-1
Connect the Equipment and Verify the Connections	15-2
Reference to Standards	16-1
1000BASE-T	16-1
Template	16-1
Peak Voltage.....	16-2
Droop	16-2
Jitter (with TX_TCLK ACCESS).....	16-3
Jitter (without TX_TCLK ACCESS).....	16-4
Distortion	16-5
CM Voltage	16-5
Return Loss.....	16-6
100BASE-TX.....	16-6
Template	16-6
Differential Output Voltage.....	16-6

Signal Amplitude Symmetry	16-7
Rise and Fall Time.....	16-7
Waveform Overshoot	16-8
Jitter	16-8
Duty Cycle Distortion.....	16-8
Return Loss.....	16-9
10BASE-T	16-9
MAU Ext	16-9
MAU Int	16-10
TP_IDL.....	16-10
Link Pulse.....	16-10
Differential Voltage.....	16-11
Harmonic	16-11
Jitter	16-12
CM Voltage	16-12
Return Loss.....	16-13
Remote GPIB	17-1
About Remote GPIB.....	17-1
Starting and Setting Up the Application Using GPIB.....	17-1
GPIB Command Syntax.....	17-2
TDSET3 Application Command Arguments and Queries	17-2
GPIB Commands for 1000BASE-T	17-6
GPIB Commands for 100BASE-TX.....	17-8
GPIB Commands for 10BASE-T	17-9
GPIB Commands for AWG Automation.....	17-11
Program Example	17-11
Guidelines to GPIB Programming.....	17-23

Calibration for Return Loss	18-1
1000BASE-T Return Loss.....	18-1
100BASE-TX Return Loss Transmitter	18-4
100BASE-TX Return Loss Receiver	18-7
10BASE-T Return Loss Transmitter.....	18-10
10BASE-T Return Loss Receiver.....	18-13
Appendix A: Specification Range	A-1
1000BASE-T.....	A-1
100BASE-TX.....	A-2
10BASE-T.....	A-3
Appendix B: Error Messages.....	B-1
TDSET3 Error Messages	B-1
Remote GPIB Error Messages	B-3

List of Figures

Figure 1-1: TDSET3 Splash Screen.....	1-1
Figure 2-1: Run Application	2-5
Figure 2-2: Application Interface.....	2-6
Figure 3-1: Application Window	3-1
Figure 3-2: File Menu	3-2
Figure 3-3: Tests menu	3-3
Figure 3-4: Results menu	3-4
Figure 3-5: Utilities menu.....	3-4
Figure 3-6: Help menu.....	3-5
Figure 3-7: Selection pane	3-5
Figure 3-8: Speed pane	3-6
Figure 3-9: 1000BASE-T Client pane	3-7
Figure 3-10: 100BASE-TX Client pane.....	3-7
Figure 3-11: 10BASE-T Client pane	3-7
Figure 3-12: Execution pane	3-8
Figure 3-13: Status bar.....	3-8
Figure 3-14: Result pane for all tests	3-9
Figure 3-15: Result pane for Return Loss tests.....	3-9
Figure 3-16: Result Summary pane	3-10
Figure 3-17: Report Configuration pane.....	3-11
Figure 3-18: Preferences dialog box	3-12
Figure 3-19: Advanced Report Configuration dialog box.....	3-15
Figure 3-20: Result Details dialog box	3-16
Figure 3-21: Mask Segments dialog box	3-17

List of Figures

Figure 3-22: Flash Hits message box.....	3-17
Figure 3-23: Show Segments dialog box.....	3-18
Figure 3-24: 1000BASE-T Manual Fit dialog box.....	3-18
Figure 3-25: 100BASE-TX/10BASE-T Manual Fit dialog box.....	3-19
Figure 3-26: Jig Match dialog box.....	3-20
Figure 3-27: Connections for Disturber Compensation.....	3-21
Figure 3-28: Step 1 Connections of Test Fixture Compensation.....	3-22
Figure 3-29: Step 2 Connections of Test Fixture Compensation.....	3-23
Figure 3-30: Virtual Keyboard.....	3-24
Figure 3-31: Virtual Keypad.....	3-24
Figure 3-32: 100BASE-TX Mask Setup dialog box.....	3-25
Figure 3-33: 10BASE-T Mask Setup dialog box.....	3-26
Figure 3-34: Smooth dialog box.....	3-26
Figure 3-35: Exit dialog box.....	3-27
Figure 5-1: 1000BASE-T Configure pane.....	5-1
Figure 5-2: 100BASE-TX Configure pane.....	5-5
Figure 5-3: 10BASE-T Configure pane.....	5-7
Figure 6-1: 1000BASE-T Connections with disturbing signal for Template, Peak Volt, Droop, and Distortion.....	6-1
Figure 6-2: 1000BASE-T Connections without disturbing signal for Template, Peak Volt, Droop, and Distortion.....	6-3
Figure 6-3: 1000BASE-T Step 1 Connections for Jitter Master Filtered.....	6-5
Figure 6-4: 1000BASE-T Step 2 Connections for Jitter Master Filtered.....	6-6
Figure 6-5: 1000BASE-T Connections for Jitter Master Filtered.....	6-7
Figure 6-6: 1000BASE-T Connections for Jitter Master Unfiltered.....	6-8
Figure 6-7: 1000BASE-T Connections for Jitter Master Unfiltered.....	6-9
Figure 6-8: 1000BASE-T Step 1 Connections for Jitter Slave Filtered.....	6-11
Figure 6-9: 1000BASE-T Step 2 Connections for Jitter Slave Filtered.....	6-12
Figure 6-10: 1000BASE-T Connections for Jitter Slave Filtered.....	6-13

Figure 6-11: 1000BASE-T Connections for Jitter Slave Unfiltered	6-15
Figure 6-12: 1000BASE-T Connections for Jitter Slave Unfiltered	6-16
Figure 6-13: 1000BASE-T Connections for Return Loss	6-17
Figure 6-14: 1000BASE-T Connections for Return Loss Calibration	6-19
Figure 6-15: 1000BASE-T Connections for CM Voltage	6-20
Figure 6-16: All 100BASE-TX Connections except Return Loss	6-22
Figure 6-17: 100BASE-TX Connections for Return Loss	6-23
Figure 6-18: 100BASE-TX Connections for Return Loss Calibration	6-24
Figure 6-19: 10BASE-T Connections for Link Pulse without Twisted-pair model.....	6-26
Figure 6-20: 10BASE-T Connections for Link Pulse with Twisted-pair model.....	6-27
Figure 6-21: 10BASE-T Connections for MAU	6-28
Figure 6-22: 10BASE-T Connections for TP_IDL without Twisted-pair model.....	6-29
Figure 6-23: 10BASE-T Connections for TP_IDL with Twisted-pair model.....	6-30
Figure 6-24: 10BASE-T Connections for Jitter with cable.....	6-31
Figure 6-25: 10BASE-T Connections for Jitter without cable.....	6-33
Figure 6-26: 10BASE-T Connections for Differential Voltage	6-35
Figure 6-27: 10BASE-T Connections for Harmonic	6-36
Figure 6-28: 10BASE-T Connections for Return Loss.....	6-37
Figure 6-29: 10BASE-T Connections for Return Loss Calibration	6-38
Figure 6-30: 10BASE-T Connections for CM Voltage	6-40
Figure 8-1: Waveform for 1000BASE-T Template Points A, B, C, and D.....	8-2
Figure 8-2: Waveform for 1000BASE-T Template Points F and H	8-3
Figure 8-3: Waveform for 1000BASE-T Peak Volt Points A, B, C, and D.....	8-5
Figure 8-4: Waveform for 1000BASE-T Droop Points F and G	8-7
Figure 8-5: 1000BASE-T Jitter Master Filtered Step 1	8-8
Figure 8-6: 1000BASE-T Jitter Master Filtered Step 2	8-9
Figure 8-7: Waveform for 1000BASE-T Jitter Master Filtered.....	8-9

List of Figures

Figure 8-8: 1000BASE-T Jitter Master Filtered (without TX_TCLK).....	8-10
Figure 8-9: TIE Waveform for 1000BASE-T Jitter Master Unfiltered	8-13
Figure 8-10: Histogram Waveform for 1000BASE-T Jitter Master Unfiltered.....	8-13
Figure 8-11: TIE Waveform for 1000BASE-T Jitter Master Unfiltered	8-15
Figure 8-12: Histogram Waveform for 1000BASE-T Jitter Master Unfiltered.....	8-15
Figure 8-13: 1000BASE-T Jitter Slave Filtered Step 1	8-17
Figure 8-14: 1000BASE-T Jitter Slave Filtered Step 2	8-18
Figure 8-15: Waveform for 1000BASE-T Jitter Slave Filtered.....	8-18
Figure 8-16: Waveform for 1000BASE-T Jitter Slave Filtered.....	8-20
Figure 8-17: TIE Waveform for 1000BASE-T Jitter Slave Unfiltered.....	8-22
Figure 8-18: Histogram Waveform for 1000BASE-T Jitter Slave Unfiltered	8-23
Figure 8-19: TIE Waveform for 1000BASE-T Jitter Slave Unfiltered.....	8-25
Figure 8-20: Histogram Waveform for 1000BASE-T Jitter Slave Unfiltered	8-25
Figure 8-21: 1000BASE-T Distortion user control	8-27
Figure 8-22: Waveform for 1000BASE-T Distortion.....	8-28
Figure 8-23: Waveform for 1000BASE-T Return Loss.....	8-30
Figure 8-24: Waveform for 1000BASE-T Common mode Voltage.....	8-32
Figure 9-1: Waveform for 100BASE-TX Template for Positive polarity	9-2
Figure 9-2: Waveform for 100BASE-TX Template for Negative polarity.....	9-2
Figure 9-3: Waveform for 100BASE-TX Differential Output Voltage for Positive polarity	9-4
Figure 9-4: Waveform for 100BASE-TX Differential Output Voltage for Negative polarity.....	9-4
Figure 9-5: Waveform for 100BASE-TX Amplitude Symmetry for Positive polarity.....	9-6
Figure 9-6: Waveform for 100BASE-TX Amplitude Symmetry for Negative polarity	9-6
Figure 9-7: Waveform for 100BASE-TX Rise Time for Positive polarity	9-8
Figure 9-8: Waveform for 100BASE-TX Rise Time for Negative polarity	9-8
Figure 9-9: Waveform for 100BASE-TX Fall Time for Positive polarity.....	9-10
Figure 9-10: Waveform for 100BASE-TX Fall Time for Negative polarity	9-10

Figure 9-11: Waveform for 100BASE-TX Rise/Fall Time Symmetry for Positive polarity	9-12
Figure 9-12: Waveform for 100BASE-TX Rise/Fall Time Symmetry for Negative polarity	9-12
Figure 9-13: Waveform for 100BASE-TX Waveform Overshoot for Positive polarity	9-14
Figure 9-14: Waveform for 100BASE-TX Waveform Overshoot for Negative polarity	9-14
Figure 9-15: Waveform for 100BASE-TX Jitter for Positive polarity.....	9-15
Figure 9-16: Waveform for 100BASE-TX Jitter for Negative polarity	9-16
Figure 9-17: Waveform for 100BASE-TX Distortion	9-17
Figure 9-18: Waveform for 100BASE-TX Return Loss Transmitter	9-19
Figure 9-19: Waveform for 100BASE-TX Return Loss Receiver	9-19
Figure 10-1: 10BASE-T Template user control dialog box	10-2
Figure 10-2: Waveform for 10BASE-T MAU Ext	10-2
Figure 10-3: Waveform for 10BASE-T MAU Ext Inv	10-3
Figure 10-4: Waveform for 10BASE-T MAU Int	10-3
Figure 10-5: Waveform for 10BASE-T MAU Int Inv	10-3
Figure 10-6: 10BASE-T Template user control dialog box	10-5
Figure 10-7: Waveform for 10BASE-T Link Pulse Timing	10-6
Figure 10-8: Waveform for 10BASE-T Link Pulse Head.....	10-6
Figure 10-9: Waveform for 10BASE-T Link Pulse Tail.....	10-7
Figure 10-10: 10BASE-T Template user control dialog box	10-9
Figure 10-11: Waveform for 10BASE-T TP_IDL Head.....	10-10
Figure 10-12: Waveform for 10BASE-T TP_IDL Tail	10-10
Figure 10-13: Waveform for 10BASE-T Differential Voltage	10-11
Figure 10-14: Waveform for 10BASE-T Harmonic	10-13
Figure 10-15: 10BASE-T Jitter with cable user control	10-14
Figure 10-16: Waveform for 10BASE-T Jitter with Cable for Normal output timing jitter	10-15
Figure 10-17: Waveform for 10BASE-T Jitter with Cable for 8 BT output timing jitter	10-15
Figure 10-18: Waveform for 10BASE-T Jitter with Cable for 8.5 BT output timing jitter	10-16

List of Figures

Figure 10-19: 10BASE-T Jitter without cable user control	10-17
Figure 10-20: Waveform for 10BASE-T Jitter without Cable for Normal output timing jitter	10-18
Figure 10-21: Waveform for 10BASE-T Jitter without Cable for 8 BT output timing jitter	10-18
Figure 10-22: Waveform for 10BASE-T Jitter without Cable for 8.5 BT output timing jitter	10-19
Figure 10-23: Waveform for 10BASE-T Return Loss Transmitter	10-21
Figure 10-24: Waveform for 10BASE-T Return Loss Receiver	10-21
Figure 10-25: Waveform for 10BASE-T Common mode Voltage.....	10-22
Figure 11-1: 1000BASE-T View Waveform for Template, Peak Volt, and Droop with disturbing signal	11-1
Figure 11-2: 1000BASE-T View Waveform for Template, Peak Volt, and Droop without disturbing signal	11-1
Figure 11-3: 1000BASE-T View Waveform for Jitter Master Filtered (with TX_TCLK access).....	11-2
Figure 11-4: 1000BASE-T View Waveform for Jitter Master Filtered (without TX_TCLK access)	11-2
Figure 11-5: 1000BASE-T View Waveform for Jitter Master Unfiltered (with TX_TCLK access).....	11-2
Figure 11-6: 1000BASE-T View Waveform for Jitter Master Filtered (without TX_TCLK access)	11-3
Figure 11-7: 1000BASE-T View Waveform for Jitter Slave Filtered (with TX_TCLK access).....	11-3
Figure 11-8: 1000BASE-T View Waveform for Jitter Master Filtered (without TX_TCLK access)	11-4
Figure 11-9: 1000BASE-T View Waveform for Jitter Slave Unfiltered (with TX_TCLK access).....	11-4
Figure 11-10: 1000BASE-T View Waveform for Jitter Master Filtered (without TX_TCLK access)	11-4
Figure 11-7: 1000BASE-T View Waveform for Distortion	11-5
Figure 11-8: 1000BASE-T View Waveform for Return Loss	11-6
Figure 11-9: 1000BASE-T View Waveform for CM Voltage.....	11-6
Figure 12-1: 100BASE-TX View Waveform for all tests except Return Loss.....	12-1
Figure 12-2: 100BASE-TX View Waveform for Return Loss Transmitter.....	12-1
Figure 12-3: 100BASE-TX View Waveform for Return Loss Receiver	12-2
Figure 13-1: 10BASE-T View Waveform for Link Pulse	13-1
Figure 13-2: 10BASE-T View Waveform for MAU	13-1
Figure 13-3: 10BASE-T View Waveform for TP_IDL.....	13-2
Figure 13-4: 10BASE-T View Waveform for Jitter with cable.....	13-2

Figure 13-5: 10BASE-T View Waveform for Jitter with cable	13-3
Figure 13-6: 10BASE-T View Waveform for Differential Voltage	13-3
Figure 13-7: 10BASE-T View Waveform for Harmonic.....	13-4
Figure 13-8: 10BASE-T View Waveform for Return Loss	13-4
Figure 13-9: 10BASE-T View Waveform for CM Voltage.....	13-5
Figure 15-1: AWG Automation Setup	15-1
Figure 15-2: Connecting the AWG and the Oscilloscope.....	15-3
Figure 15-3: Verifying the instrument connections	15-4
Figure 15-4: TekVISA Resource Manager Configuration.....	15-5
Figure 18-1: Calibration for 1000BASE-T Return Loss.....	18-1
Figure 18-2: Connect pane of 1000BASE-T Return Loss	18-2
Figure 18-3: Waveform of 1000BASE-T Return Loss Open Calibration.....	18-2
Figure 18-4: Waveform of 1000BASE-T Return Loss Short Calibration.....	18-3
Figure 18-5: Waveform of 1000BASE-T Return Loss Load Calibration	18-3
Figure 18-6: Calibration for 100BASE-TX Return Loss	18-4
Figure 18-7: Waveform of 100BASE-TX Return Loss Open Calibration.....	18-5
Figure 18-8: Waveform of 100BASE-TX Return Loss Short Calibration.....	18-5
Figure 18-9: Waveform of 100BASE-TX Return Loss Load Calibration	18-6
Figure 18-10: Calibration for 100BASE-TX Return Loss	18-7
Figure 18-11: Waveform of 100BASE-TX Return Loss Open Calibration.....	18-8
Figure 18-12: Waveform of 100BASE-TX Return Loss Short Calibration.....	18-8
Figure 18-13: Waveform of 100BASE-TX Return Loss Load Calibration	18-9
Figure 18-14: Calibration for 10BASE-T Return Loss.....	18-10
Figure 18-15: Waveform of 10BASE-T Return Loss Open Calibration.....	18-11
Figure 18-16: Waveform of 10BASE-T Return Loss Short Calibration.....	18-11
Figure 18-17: Waveform of 10BASE-T Return Loss Load Calibration	18-12
Figure 18-18: Calibration for 10BASE-T Return Loss.....	18-13

List of Figures

Figure 18-19: Waveform of 10BASE-T Return Loss Open Calibration	18-14
Figure 18-20: Waveform of 10BASE-T Return Loss Short Calibration	18-14
Figure 18-21: Waveform of 10BASE-T Return Loss Load Calibration.....	18-15

List of Tables

Table 2-1: Application Default Directories.....	2-7
Table 2-2: 1000BASE-T Default Layouts and Templates	2-8
Table 2-3: 100BASE-TX Default Layouts and Templates	2-9
Table 2-4: 10BASE-T Default Layouts and Templates	2-9
Table 2-5: Default Settings	2-10
Table 3-1: Application Interface Controls	3-1
Table 3-2: File menu	3-3
Table 3-3: Tests menu.....	3-3
Table 3-4: Results menu	3-4
Table 3-5: Utilities menu	3-4
Table 3-6: Help menu	3-5
Table 3-7: Selection pane buttons	3-5
Table 3-8: Execution pane	3-8
Table 3-9: Result Summary pane buttons	3-10
Table 3-10: Report Configuration fields	3-11
Table 3-11: Preferences	3-12
Table 3-12: Advanced Report Configuration.....	3-15
Table 3-13: Result Details Categorization	3-16
Table 4-1: Select 1000BASE-T Test Parameters.....	4-1
Table 4-2: Select 100BASE-TX Test Parameters	4-1
Table 4-3: Select 10BASE-T Test Parameters.....	4-2
Table 5-1: 1000BASE-T Configure parameters.....	5-1
Table 5-2: 1000BASE-T Configure parameter description	5-2
Table 5-3: 1000BASE-T Configuration Default Settings	5-4

List of Tables

Table 5-4: 100BASE-TX Configure parameters	5-5
Table 5-5: 100BASE-TX Configure parameter description	5-6
Table 5-6: 100BASE-TX Configuration Default Settings.....	5-7
Table 5-7: 10BASE-T Configure parameters	5-8
Table 5-8: 10BASE-T Configure parameter description	5-8
Table 5-9: 10BASE-T Configuration Default Settings.....	5-10
Table 7-1: Test and Pattern description	7-1
Table 7-2: Test and Pattern description	7-1
Table 7-3: Test and Pattern description	7-2
Table 8-1: 1000BASE-T Template Configuration Options.....	8-1
Table 8-2: 1000BASE-T Peak Volt Configuration Options	8-4
Table 8-3: 1000BASE-T Droop Configuration Options.....	8-6
Table 8-4: 1000BASE-T Jitter Master Filtered Configuration Options.....	8-7
Table 8-5: 1000BASE-T Jitter Master Unfiltered Configuration Options.....	8-11
Table 8-6: 1000BASE-T Jitter Slave Filtered Configuration Options.....	8-16
Table 8-7: 1000BASE-T Jitter Master Unfiltered Configuration Options.....	8-21
Table 8-8: 1000BASE-T Distortion Configuration Options.....	8-26
Table 8-9: 1000BASE-T Return Loss Configuration Options.....	8-29
Table 8-10: 1000BASE-T CM Voltage Configuration Options	8-31
Table 9-1: 100BASE-TX Template Configuration Options	9-1
Table 9-2: 100BASE-TX Differential Output Voltage Configuration Options	9-3
Table 9-3: 100BASE-TX Amplitude Symmetry Configuration Options.....	9-5
Table 9-4: 100BASE-TX Rise Time Configuration Options.....	9-7
Table 9-5: 100BASE-TX Fall Time Configuration Options	9-9
Table 9-6: 100BASE-TX Rise/Fall Time Symmetry Configuration Options.....	9-11
Table 9-7: 100BASE-TX Waveform Overshoot Configuration Options.....	9-13
Table 9-8: 100BASE-TX Jitter Configuration Options	9-15

Table 9-9: 100BASE-TX Distortion Configuration Options	9-16
Table 9-10: 100BASE-TX Return Loss Configuration Options	9-18
Table 10-1: 10BASE-T MAU Configuration Options	10-1
Table 10-2: 10BASE-T Link Pulse Configuration Options	10-4
Table 10-3: 10BASE-T TP_IDL Configuration Options	10-8
Table 10-4: 10BASE-T Differential Voltage Configuration Options	10-11
Table 10-5: 10BASE-T Harmonic Configuration Options	10-12
Table 10-6: 10BASE-T Jitter with cable Configuration Options	10-13
Table 10-7: 10BASE-T Jitter without cable Configuration Options	10-16
Table 10-8: 10BASE-T Return Loss Configuration Options	10-19
Table 10-9: 10BASE-T CM Voltage Configuration Options	10-22
Table 15-1: AWG Configuration Parameters and Descriptions	15-1
Table 15-2: AWG Configuration Parameters and Defaults	15-2
Table 17-1: Command Arguments and Queries	17-2
Table 17-2: 1000BASE-T GPIB Commands	17-6
Table 17-3: 100BASE-TX GPIB Commands	17-8
Table 17-4: 10BASE-T GPIB Commands	17-9
Table 17-5: AWG Automation GPIB Commands	17-11
Table A-0-1: 1000BASE-T Specification Range	A-1
Table A-0-2: 100BASE-TX Specification Range	A-2
Table A-0-3: 10BASE-T Specification Range	A-3
Table B-0-1: TDSET3 Error Messages	B-1
Table B-0-2: Remote GPIB Error Messages	B-3

About TDSET3

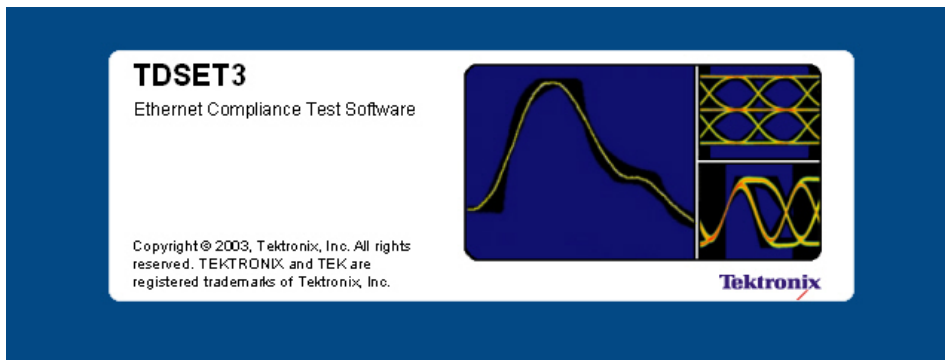

Figure 1-1: TDSET3 Splash Screen

The TDSET3 Ethernet Compliance Test Software tests the Ethernet's physical layer for — 1000BASE-T, 100BASE-TX, and 10BASE-T in compliance with IEEE 802.3-2000 and ANSI X3.263-1995 standards. This version allows you to test each speed for various fields such as:

1000BASE-T

- Template
- Peak Voltage
- Droop
- Jitter Master Filtered
- Jitter Master Unfiltered
- Jitter Slave Filtered
- Jitter Slave Unfiltered
- Distortion
- Return Loss
- Common mode Voltage

100BASE-TX

- Template
- Differential Output Voltage
- Signal Amplitude Symmetry
- Rise Time
- Fall Time
- Rise / Fall Time Symmetry
- Waveform Overshoot
- Jitter
- Duty Cycle Distortion
- Return Loss

10BASE-T

Template MAU Ext
Template MAU Ext Inv
Template MAU Int
Template MAU Int Inv
Template Link Pulse
Template TP_IDL
Differential Voltage
Harmonic
Jitter with cable
Jitter without cable
Return Loss
Common mode Voltage

TDSET3 has a Report Generator tool that helps you create and print custom reports.

TDSET3 also supports Remote GPIB commands.

Note: *Use the Select All button to test all the parameters of the selected speed.*

Using Online Help

The TDSET3 online help serves as a reference for using the TDSET3 Ethernet Compliance Test Software.

Contents: The Contents tab displays books and pages that represent the categories of information in the online Help system.

Index: The Index tab displays a multi-level list of keywords and keyword phrases. These terms are associated with topics in the Help system and direct you to specific topics.

Search: The Search tab enables you to search for keywords in the Help system and to locate topics containing those words. When the search is completed, a list of topics is displayed so you can select a specific topic to view.

Back and Forward: The Back and Forward buttons allow you to browse through topics.

To print a topic: Select the Print button from the Help Topics menu bar.

Printing from the Online Help

While using the online help, you can print topics and information from the HTML Help viewer.

To print a single topic:

1. Find the topic in the Contents pane. Click Print.
2. Click Print the selected topic and click OK.

To print all topics in a selected TOC book:

1. Find the TOC book in the Contents pane. Click Print.
2. Click Print the selected heading and all subtopics and click OK.

Note: If topics include expanding or drop-down hotspots, click the hotspots to display the information before you.

Hotspot is a clickable text that displays additional information below the link. Click on the hotspot text to show or hide the hotspot content

Some online help topics have color in the examples of the displayed application. If you want to print this type of topic on a monochrome printer, some information may not print because of certain colors. Instead, you should print the topic from the PDF (portable document format) file that corresponds to the online help. You can find the file in the Documents directory on the *Optional Applications Software on Windows-Based Oscilloscopes CD-ROM*. The application menus in the PDF file are gray scale and all the information can be printed.

Conventions

Online help uses the following conventions:

- When steps require a sequence of selections using the application interface, the ">" delimiter marks each transition between a menu and an option. For example, **File > Minimize**.
- DUT refers to the transmitter transmitting the required signal to be tested.
- Two or more adjacent hyperlinks are separated with "|".
- Hotspot is a clickable text that displays additional information below the link. Click on the hotspot link to show or hide the hotspot content.

The application uses this convention:

- Three dots "..." next to any menu item means that the dialog box that pops up requires user input.

Contacting Tektronix

Phone	1-800-833-9200*
Address	Tektronix, Inc. 14200 SW Karl Braun Drive P.O. Box 500 Beaverton, OR 97077 USA
Web site	www.tektronix.com
Sales support	1-800-833-9200, select option 1*
Service support	1-800-833-9200, select option 2*
Technical support	Email: techsupport@tektronix.com 1-800-833-9200, select option 3* 6:00 a.m. - 5:00 p.m. Pacific time

*** This phone number is toll free in North America. After office hours, please leave a voice mail message. Outside North America, contact a Tektronix sales office or distributor; see the Tektronix Web site for a list of offices.**

Feedback

Tektronix values your feedback on our products. To help us serve you better, please send us your suggestions, ideas, or comments on the application.

Direct your feedback via email to **techsupport@tektronix.com** or FAX at **(503) 627-5695** and include the following information. Please be as specific as possible.

General information:

- Instrument model number and hardware options, if any
- Probes used
- Your name, company, mailing address, phone number, FAX number, email id
- Please indicate if you would like to be contacted by Tektronix about your suggestion or comments

Application specific information:

- Software version number
- Description of the problem such that technical support can duplicate the problem
- The instrument setup file of the oscilloscope and the application is also required to identify the problem
- If possible, save the waveform on which you are performing the measurement as a .wfm file

*Note: To know the Software version number, click **Help** > **About** in the application.*

Information through the Web site

You can find information about this and other applications at the Tektronix Inc. Web site, www.tektronix.com. Check this site for firmware updates and other information about our application. You can download a free trial version of the TDSET3 application that allows you a five-time trial.

Getting Started

Compatibility

The application is compatible with the following TDS5000, TDS6000, TDS7000 or CSA7000 series oscilloscopes:

TDS5000 series oscilloscopes:

- TDS5032B
- TDS5034B
- TDS5052B
- TDS5054B
- TDS5104B

Note: The two-channel oscilloscopes are TDS5052B and TDS5032B.

TDS6000 series oscilloscopes:

- TDS6404
- TDS6604
- TDS6604B
- TDS6804B
- TDS6124C
- TDS6154C

TDS7000 series oscilloscopes:

- TDS7054
- TDS7104
- TDS7154
- TDS7254
- TDS7404

- TDS7704B
- TDS7404B
- TDS7254B
- TDS7154B

CSA7000 series oscilloscopes:

- CSA7154
- CSA7404
- CSA7404B

Other oscilloscope:

- VMS5000HD

Recommended Accessories

Differential Probes

- P6247 — 1.0 GHz Differential Probe
- P6248 — 1.5 GHz Differential Probe
- P6330 — 3.5 GHz Differential Probe
- P7330 — 3.5 GHz Differential Probe
- P7350 — 5.0 GHz Differential Probe

Active Probes

- P6243, and P6245 1 GHz or above depending on the Oscilloscope (for 1000BASE-T Jitter tests)

Arbitrary Waveform Generator

- AWG410 — 200 MS/s, 16-Bit Arbitrary Waveform Generator
- AWG420 — 200 MS/s, 16-Bit Arbitrary Waveform Generator
- AWG430 — 200 MS/s, 16-Bit Arbitrary Waveform Generator
- AWG510 — 1 GS/s, 10-Bit Arbitrary Waveform Generator
- AWG520 — 1 GS/s, 10-Bit Arbitrary Waveform Generator

- AWG610 — 2.6 GS/s, 8-Bit Arbitrary Waveform Generator
- AWG710 — 4.0 GS/s, 8-Bit Arbitrary Waveform Generator
- AWG2021 — 250 MS/s, 12-Bit Arbitrary Waveform Generator (for Disturbing Signal Generator)

Note: In the case of AWG 400 series, the 1000Base-T return loss test values after 98.5 MHz are extrapolated.

Probe Positioner

- PPM100 Flexible Arm Probe Positioner

Differential Input Voltage of Differential Probes

- P6247 — ± 8.5 V
- P6248 — ± 8.5 V
- P6330 — ± 2 V
- P7330 — ± 2 V
- P7350 — ± 2.5 V

Requirements and Restrictions

Do not change the oscilloscope settings when the test is running. If you change the settings when the test is running, the application may give abnormal test results.

Prerequisites

- TekVisa must be installed in the oscilloscope
- A TDS7000/CSA7000/TDS6000 series oscilloscope with Firmware version 2.2.0 or later
- A TDS7000B/CSA7000B oscilloscope with Firmware version 3.0.0 or later.
- A TDS5000B series oscilloscope with Firmware version 2.0.0 or later.
- A TDS6000B series oscilloscope with Firmware version 4.0.1 or later.
- A TDS6000C series oscilloscope with Firmware version 5.0.0 or later.

For better and reliable results

- Prior to running any test, calibrate the probes, and oscilloscope for Signal Path Compensation¹
- Cable length between the DUT and the test fixture should not be more than two inches
- Use 500 waveforms for averaging 1000BASE-T
- Use 64 waveforms for averaging, and 200000 samples for mask testing 10BASE-T or 100BASE-TX wherever applicable
- Use 48 waveforms for averaging 10BASE-T harmonics
- If the signal is not connected and the noise level is below 50 mV, the application detects and gives a message as invalid signal

¹ To calibrate an oscilloscope, select **Utilities > Instrument Calibration** in the oscilloscope menu bar and select the **Calibrate** button.

Note: *If you do not install the latest version (Version 2.2.0 or above) of TDS7000 or CSA7000 Firmware, the application will not test the mask related parameters.*

Remember

- TDS5032B and TDS5052B are two-channel oscilloscopes. The drop-down list for any Data, Ref, or Math sources displays only two channels.
- For 1000BASE-T Template test, the TDS5000B series oscilloscope displays the horizontal scale in 4 ns.
- The two-channel oscilloscopes do not support the 1000BASE-T Jitter Slave Filtered test.
- The TDS6000B and TDS7000B series oscilloscope do not support Flash Hits.

About the Test Fixture

The TF-GBE test fixture, designed by Tektronix and manufactured and distributed by Crescent Heart Software, facilitates 1000BASE-T, 100BASE-TX and 10BASE-T Ethernet compliance testing when used with an appropriate TDS5000, TDS6000, TDS7000 or CSA7000 Series oscilloscope and Tektronix TDSSET3 Ethernet Compliance Test Software.

For more information, visit Crescent Heart Software Web site www.c-h-s.com.

Starting the Application

1. From the oscilloscope menu, select File > Run Application > Ethernet Compliance Test Software.

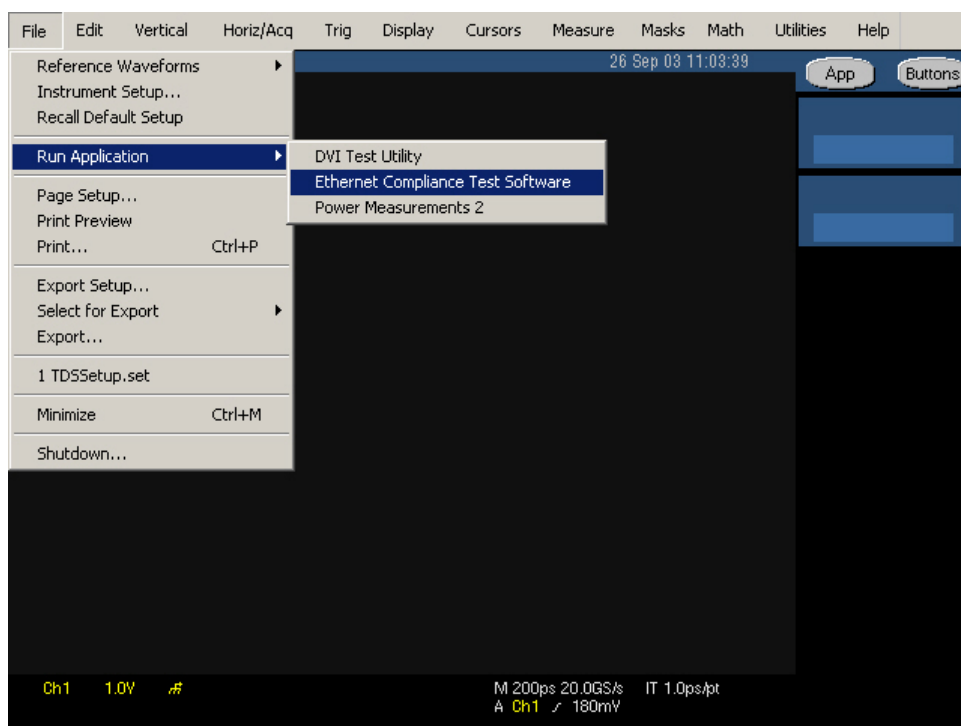

Figure 2-1: Run Application

2. The splash screen appears. The oscilloscope display resizes to fit the upper half of the screen and the lower half of the oscilloscope screen displays the TDSET3 application.

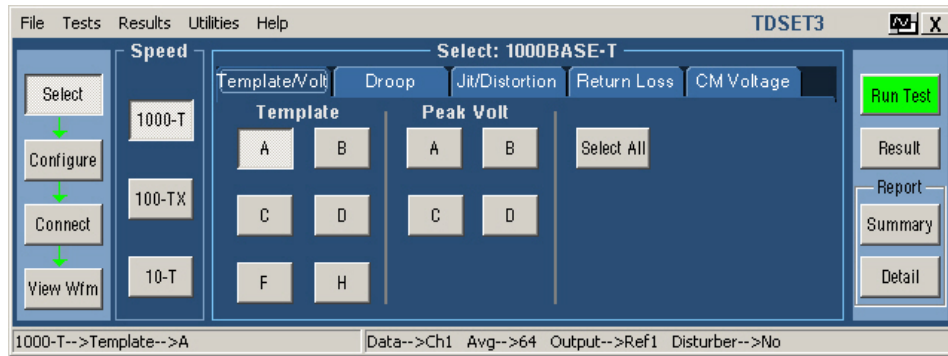



Figure 2-2: Application Interface

3. The application is automatically set to its default settings.
4. If you access oscilloscope functions, the oscilloscope display appears in full screen and the TDSET3 application recedes to the background.
5. To return to the TDSET3 application, select the APP button in the oscilloscope display.

Minimizing and Maximizing the Application

The application appears even when you minimize the oscilloscope.

- To minimize the application, select **File > Minimize**. The TDSET3 window minimizes to the Windows taskbar and upper half screen has the oscilloscope display and lower half of the screen has the desktop
- To maximize the application, select Ethernet Compliance Test Software in the Windows taskbar.
- To hide the application, select the **Hide** button  or select **File > Hide**.

The Report Generator module windows are independent of the TDSET3 application. Select the **Minimize** button on the right hand corner of the relevant report generator window to minimize it.

***Note:** If you select **Hide** button, the TDSET3 window goes to the background and the Oscilloscope display resizes to the whole screen.*

Returning to the Application

When you access oscilloscope functions, the oscilloscope fills the display. You can access oscilloscope functions in the following ways:

- Choose the Menu bar or the Toolbar mode on the oscilloscope and access the menus.
- Press front-panel buttons.
- To return to the application, select the **APP** button on the top right of the oscilloscope display.

Exiting the Application

To exit the application, do the following:

- Select **File > Exit** or select the **Exit** button .
- On exiting the application a message box "**Do you want to restore the oscilloscope settings to their state prior to starting this application?**" appears.
- Select **Yes**, **No**, or **Cancel**. **Yes** is selected by default.

Note: Using other methods to exit the application results in abnormal termination of the application.

Application Directories and File Names

The TDSET3 application uses directories to save and recall setup files and uses file name extensions to identify the file type. The next table lists the default directory names.

Table 2-1: Application Default Directories

Directory	Action
C:\TekApplications\TDSET3\Setup	Stores the application settings to setup files
C:\TekApplications\TDSET3\ReportGenerator\Templates	Stores the default templates of report generator
C:\TekApplications\TDSET3\ReportGenerator\Reports	Stores the Reports for 10BASE-T, 100BASE-TX, and 1000BASE-T
C:\TekApplications\TDSET3\ReportGenerator\Layouts	Stores the Report Layouts for 10BASE-T, 100BASE-TX, and 1000BASE-T
C:\TekApplications\TDSET3\AWGWaveforms	Stores the AWG waveforms.
C:\TekApplications\TDSET3\Images	Stores all the images.

Application Software Default Layouts and Templates

Table 2-2: 1000BASE-T Default Layouts and Templates

Test	Default template
1000BASE-T (Default layout — 1000T.rpl)	
Coversheet	Coversheet for 1000BaseT.rgt Coversheet for 1000BaseT_2.rgt
Template	1000T-TemplateA.rgt 1000T-TemplateB.rgt 1000T-TemplateC.rgt 1000T-TemplateD.rgt 1000T-TemplateF.rgt 1000T-TemplateH.rgt
Peak Volt	1000T-PeakVoltA.rgt 1000T-PeakVoltB.rgt 1000T-PeakVoltC.rgt 1000T-PeakVoltD.rgt
Droop	1000T-DroopG.rgt 1000T-DroopJ.rgt
Jitter	1000 Jitter Master filtered.rgt 1000 Jitter Master Unfiltered[TIE].rgt 1000 Jitter Master Unfiltered[HIS].rgt 1000 Jitter Slave filtered.rgt 1000 Jitter Slave Unfiltered[TIE].rgt 1000 Jitter Slave Unfiltered[HIS].rgt 1000T- Jitter master filtered_NOCLK.rgt 1000T- Jitter master unfiltered[HIS]_NOCLK.rgt 1000T- Jitter master unfiltered[TIE]_NOCLK.rgt 1000T- Jitter slave filtered_NOCLK.rgt 1000T- Jitter slave unfiltered[HIS]_NOCLK.rgt 1000T- Jitter slave unfiltered[TIE]_NOCLK.rgt
Distortion	1000T-Distortion.rgt
Common mode Voltage	1000T-Common mode Voltage.rgt
Return Loss	1000T-Return Loss.rgt

Table 2-3: 100BASE-TX Default Layouts and Templates

Test	Default template
100BASE-TX (Default layout — 100TX.rpl)	
Coversheet	Coversheet for 100BaseTX.rgt
Template	100-AOI Template.rgt
Differential Output Voltage	100-Differential Output Voltage.rgt
Signal Amplitude Symmetry	100-Signal Amplitude Symmetry.rgt
Rise Time	100-Rise Time.rgt
Fall Time	100-Fall Time.rgt
Rise/Fall Time Symmetry	100-Rise Fall Time Symmetry.rgt
Waveform Overshoot	100-Waveform Overshoot.rgt
Jitter	100-Transmit Jitter.rgt
Duty Cycle Distortion	100-Duty Cycle Distortion.rgt
Return Loss	100-Tx Return Loss.rgt 100-Rx Return Loss.rgt

Table 2-4: 10BASE-T Default Layouts and Templates

Test	Default template
10BASE-T (Default layout — 10T.rpl)	
Coversheet	Coversheet for 10BaseT.rgt
MAU Ext Template	10 MAU ext template.rgt
MAU Ext Inv Template	10 mau ext inv template.rgt
MAU Int Template	10 mau int template.rgt
MAU Int Inv Template	10 mau int inv template.rgt
Link Pulse Template Load with TPM	10 Link Pulse Load1 with TPM template.rgt 10 Link Pulse Load2 with TPM template.rgt 10 Link Pulse 100 with TPM template.rgt
Link Pulse Template Load without TPM	10 Link Pulse Load1 without TPM template.rgt 10 Link Pulse Load2 without TPM template.rgt 10 Link Pulse 100 without TPM template.rgt
Link Pulse Timing	10 Link Pulse Timing.rgt
TP_IDL Template Load with TPM	10 TP_IDL Load1 with TPM template.rgt 10 TP_IDL Load2 with TPM template.rgt 10 TP_IDL 100 with TPM template.rgt
TP_IDL Template Load without TPM	10 TP_IDL Load1 without TPM template.rgt 10 TP_IDL Load2 without TPM template.rgt 10 TP_IDL 100 without TPM template.rgt
Differential Output Voltage	10 differential output voltage.rpt

Table 2-4: 10BASE-T Default Layouts and Templates

Harmonic	10 harmonic of all ones.rgt
Jitter with cable Normal output timing	10 output timing jitter with cable.rgt
Jitter with cable 8.0 output timing	10 8.0 output timing jitter with cable.rgt
Jitter with cable 8.5 output timing	10 8.5 output timing jitter with cable.rgt
Jitter without cable Normal output timing	10 output timing jitter without cable.rgt
Jitter without cable 8.0 output timing	10 8.0 output timing jitter without cable.rgt
Jitter without cable 8.5 output timing	10 8.5 output timing jitter without cable.rgt
Return Loss	10 Tx Return Loss.rgt 10 Rx Return Loss.rgt
Common mode Voltage	10 Common mode Voltage.rgt

Application Software Default Settings

The TDSET3 application is automatically set to the default settings. The next table lists the default settings with which the TDSET3 application starts.

Table 2-5: Default Settings

Parameter	Selection	Default Setting
Speed		1000-T
Select > 1000-T		Template/Volt tab
	Template/Volt tab	A
	Droop tab	G
	Jit/Distortion tab	Master Unfiltered
	Return Loss tab	Return Loss
	CM Voltage tab	CM Voltage
Select > 100-TX		Parametric tab
	Parametric tab	Template (Both Polarity)
	Return Loss tab	Transmitter
Configure > 1000-T	Data	CH1
	Master CLK	CH2
	Slave CLK	CH3
	Data (TM2)	CH1
	Data (TM3)	CH2
	TX_TCLK	CH1
	# Averages	64
	Clock Edge	Rising
	Hi Resolution	64
	Output	Ref1
	Disturbing Signal	No
	Filter	Int
	TX_TCLK	No

Table 2-5: Default Settings

	LP Filter	Yes
	Meas Type	TIE
	Probe:P1	CH1
	Probe:P2	CH2
	Pair ID	A
	Load	85, 100, 115 ohm
	Smooth	7
	Record Length	Varies depending on the Memory option available on the Oscilloscope.
	Hysteresis	5.00 %
Configure > 100-TX	Data	CH1
	Mask Setup Samples Fail Threshold	50K 1
	Mask Scale	Normal
	Acquisition	Sample/Average (depends on the parameter selected) Average is the default mode # Waveforms = 16
	Pulse Width	16 ns
	Probe:P1 / Probe:P3	CH1
	Probe:P2 / Probe:P4	CH2
	Load	85, 100, 115 ohm
	Smooth	7
	# Averages	100 for Return Loss and 48 for other tests
Configure > 10-T	Data	CH1
	Acquisition	Sample/Average (depends on the parameter selected) Average is the default mode # Waveforms = 16
	Section	Both
	MAU Type	Internal
	MAU Scale	Normal
	Mask Setup Samples Fail Threshold	50K 1
	Harmonic Ones Output # Averages Time/Scale	Math1 48 10 microseconds
	Sequence	Normal (NLP)
	Probe: P1 / Probe: P3	CH1
	Probe: P2 / Probe: P4	CH2

Table 2-5: Default Settings

	Load	85, 100, 111 ohm
	Smooth	7
Report > Report Generator		Generate Report tab

Operating Basics

TDSET3 Application Window

The TDSET3 application is a Windows-based application. The application window comprises Menu bar, Selection pane, Speed pane, Client pane, Execution pane, and Status bar. The Client pane changes between Configuration pane, Parameter Selection pane, Connection pane, and View Waveform pane depending on what you have selected in the Selection pane. The Client pane changes to Result pane automatically after you run the test.

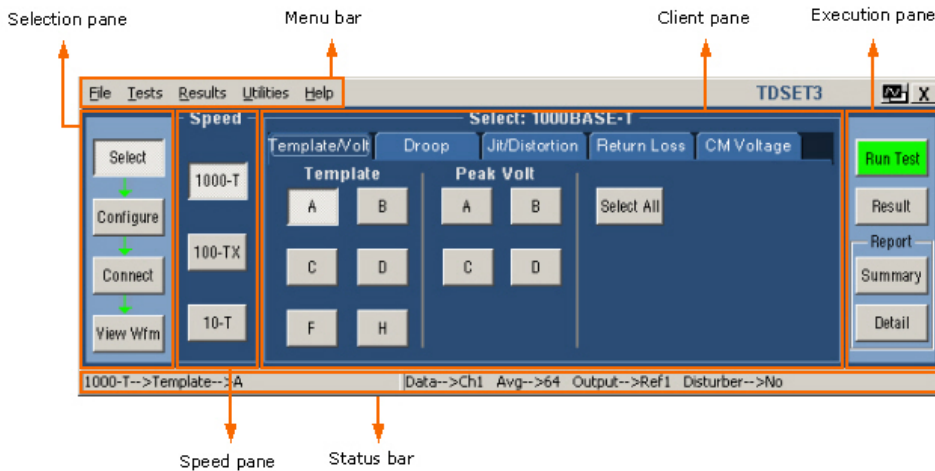

Figure 3-1: Application Window

TDSET3 Application Interface Controls

The TDSET3 application interface uses the following controls:

Table 3-1: Application Interface Controls

Controls	Description
Menu bar	Located at the top of the application and has the TDSET3 menus.
Tab	Labeled group of options with similar items.
Pane	Enclosed visual frame with a set of related options.
Option button	Defines a particular command or task.
Drop-down list box	Lists the items from which you can select one item.
Field	Box that you can use to type in text or to enter a value with the keypad or a multipurpose knob.

Table 3-1: Application Interface Controls

Check Boxes	Square box that you can use to select or clear preferences.
Scroll bar	Vertical or horizontal bar at the side or bottom of a display area used to move around that area.
Browse	Displays a window where you can look through a list of directories and files.
Command button	Initiates an immediate action.
Keypad	Appears when you select the box and enter a value.
MP/GP knob	Displays a line between the knob and the box. You can turn the knob on the oscilloscope to select a value.

Menu bar

The menu bar of TDSET3 has the following menus.

- File menu
- Tests menu
- Results menu
- Utilities menu
- Help menu

File Menu

The File menu appears as shown by the next figure:

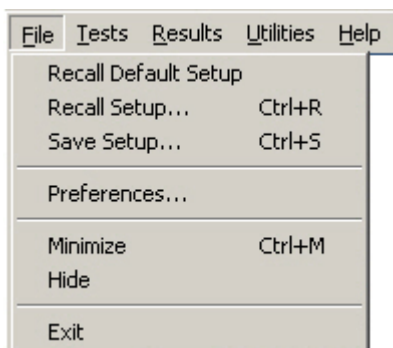

Figure 3-2: File Menu

The next table lists the menu selection and description for the File menu.

Table 3-2: File menu

Menu selection	Description
Recall Default Setup	Recalls the default settings for the application.
Recall Setup	Recalls the application settings from a setup file.
Save Setup	Saves the application settings to a setup file.
Preferences	Shows/Hides the message boxes displayed while running the test.
Minimize	Minimizes the Application window.
Hide	Hides the Application window.
Exit	Displays the Restore Settings dialog box and closes the Application.

Tests Menu

The Tests menu appears as shown by the next figure:

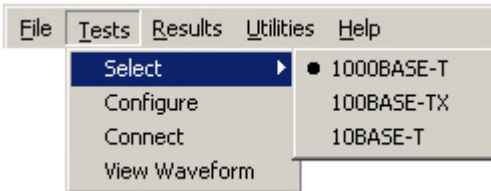

Figure 3-3: Tests menu

The next table lists the menu selection and description for the Tests menu.

Table 3-3: Tests menu

Menu selection	Description
Select	
1000BASE-T	Displays the point and test parameter selections for 1000BASE-T in the Client pane.
100BASE-TX	Displays the parameters for 100BASE-TX in the Client pane.
10BASE-T	Displays the parameters for 10BASE-T in the Client pane.
Configure	Displays the configuration details for the selected speed and test.
Connect	Displays the connection instructions for the selected speed.
View Waveform	Displays the waveform based on the settings.

Results Menu

The Results menu appears as shown by the next figure:

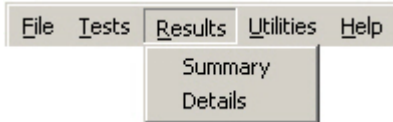

Figure 3-4: Results menu

The next table lists the menu selection and description for the Results menu.

Table 3-4: Results menu

Menu selection	Description
Summary	Displays the results summary of last test conducted.
Details	Displays the detailed results of last test conducted.

Utilities Menu

The Utilities menu appears as shown by the next figure:



Figure 3-5: Utilities menu

The next table lists the menu selection and description for the Utilities menu.

Table 3-5: Utilities menu

Menu selection	Description
Report Generator	Displays the Report Generator window.
Enable Remote GPIB	Enables you to use remote GPIB commands to control the application.
Automate AWG	Enables you to automate file transfer and waveform setup on an Arbitrary Waveform Generator.

Help Menu

The Help menu appears as shown by the next figure:

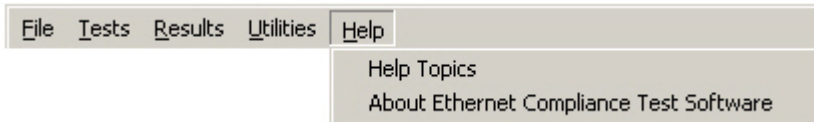

Figure 3-6: Help menu

The next table lists the menu selection and description for the Help menu.

Table 3-6: Help menu

Menu selection	Description
Help Topics	Displays the help file for the TDSET3 application.
About Ethernet Compliance Test Software	Displays a dialog box with information about the current TDSET3 application.

Selection pane

The Selection pane located to the left of the Application window allows you to navigate through the application.

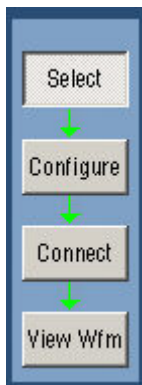

Figure 3-7: Selection pane

The next table lists the button and the task description.

Table 3-7: Selection pane buttons

Button	Description
Select	Displays the test selection parameters in the Client pane for the selected speed.

Table 3-7: Selection pane buttons

Configure	Displays the configuration parameters in the Client pane for the selected test parameter.
Connect	Displays the connection details in the Client pane for the selected test parameter.
View Wfm	Displays the waveform in the Client pane for the selected test parameter.

Speed pane

The Speed pane located to the left of the Application window displays the speed to be selected.



Figure 3-8: Speed pane

Select **1000-T** to test 1000BASE-T, **100-TX** to test 100BASE-TX and **10-T** to test 10BASE-T.

The Client pane displays the parameters of the selected speed.

Client pane

The Client pane located adjacent to the Speed pane displays the test parameters, configuration parameters, connections, view waveforms or results. Clicking on each tab changes the Client pane to display the relevant test parameters.

1000BASE-T Client pane

The following figure shows the Client pane of 1000BASE-T Template.

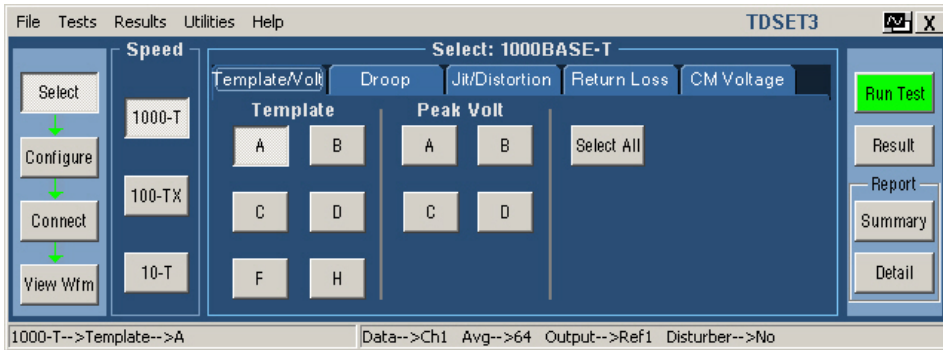

Figure 3-9: 1000BASE-T Client pane

100BASE-TX Client pane

The following figure shows the Client pane of 100BASE-TX Template.

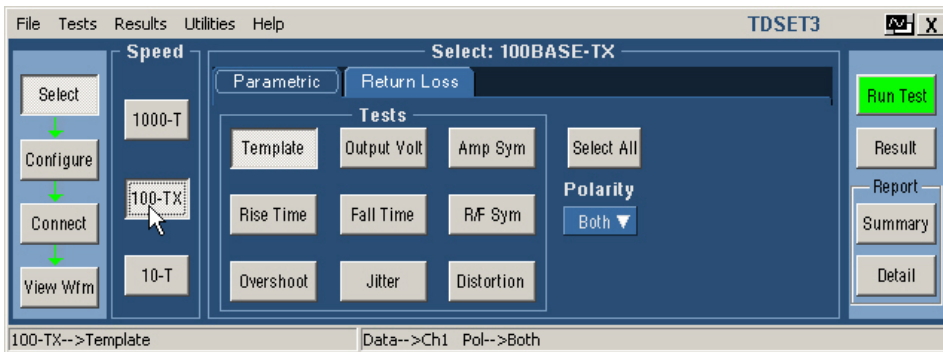

Figure 3-10: 100BASE-TX Client pane

10BASE-T Client pane

The following figure shows the Client pane of 10BASE-T Template.

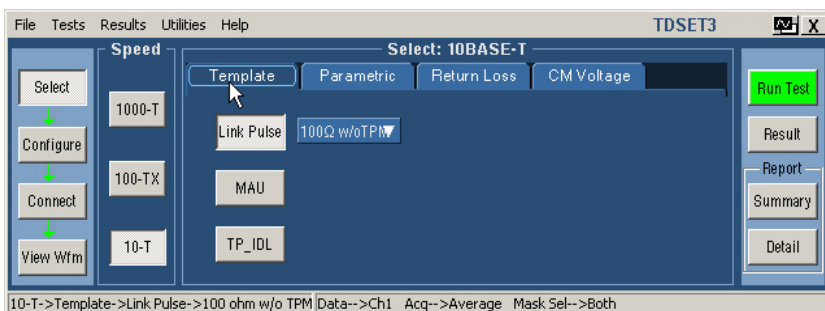

Figure 3-11: 10BASE-T Client pane

Execution pane

The Execution pane located to the right of the Application window displays the buttons Run Test and Result.



Figure 3-12: Execution pane

Clicking on each button performs a particular task. The following table lists the button and the task description.

Table 3-8: Execution pane

Button	Button Name	Description
	Run Test	Runs the selected test or tests.
	Result	Displays the Result pane that shows the test results.
	Report Summary	Displays the location to which the report summary is saved. Click OK to store the result details in a .csv file.
	Report Detail	Displays the location to which the detailed report is saved. Click OK to store the result details in a .rpt file depending on the layout selected in Report Configuration pane.

***Note:** The report details are real time and no history is maintained. Ensure that you save the report details before you run another test.*

Status bar

At the bottom of the application window is the status bar that displays the selected test and the important configuration parameters.

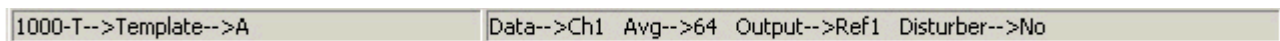

Figure 3-13: Status bar

Result pane

After you run a test, the Result pane automatically appears as shown by the following figure.

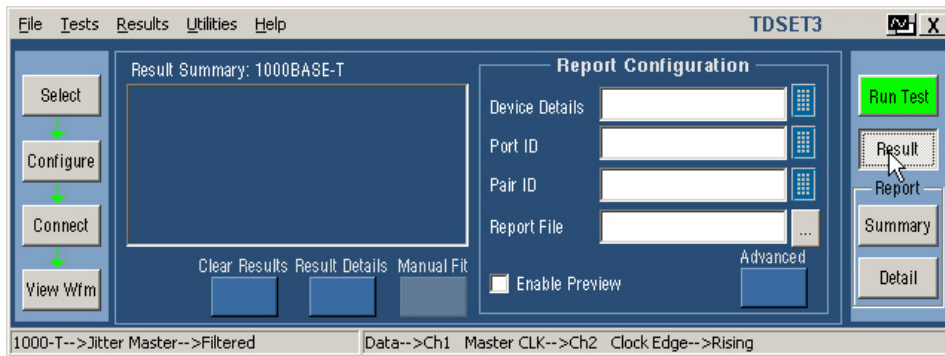

Figure 3-14: Result pane for all tests

After you run a Return Loss test, the Result pane automatically appears as shown by the following figure.

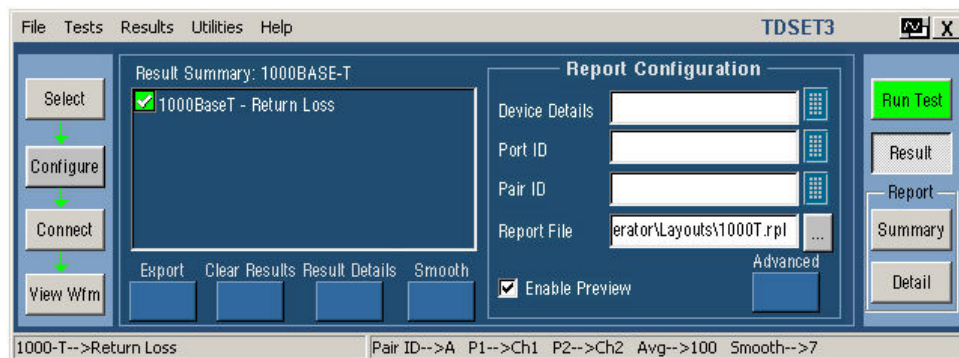

Figure 3-15: Result pane for Return Loss tests

The Result pane comprises Result Summary pane and Report Configuration pane.

Result Summary pane The Result Summary pane displays the test results as Pass/Fail/Inconclusive.

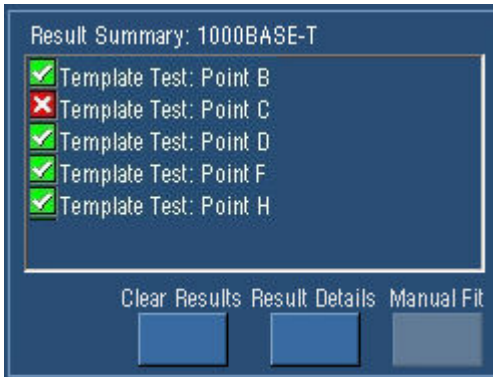





Figure 3-16: Result Summary pane

-  Indicates that the test has passed.
-  Indicates that the test has failed.
-  Indicates that the test is inconclusive.

The next table lists the button and the task description.

Table 3-9: Result Summary pane buttons

Button	Description
Export	Exports the return loss values in a .csv file.
Clear Results	Clears the results in the Result Summary pane.
Result Details	Displays the Result Details dialog box that shows the details of test results categorized as Description, Specification range, Measured Value, Pass/Fail/Inconclusive, and Remarks.
Manual Fit	Displays the Manual Fit dialog box that allows you to adjust the waveform to fit into the Mask. This button is enabled only when you test 1000BASE-T Template, 100BASE-TX Template or 10BASE-T Template.
Smooth	Displays the Smooth dialog box that allows you to smoothen the return loss waveform. This button is enabled only when you test Return Loss.

Report Configuration pane

You can set the report details to identify and automatically generate the report. You can set a default report file.

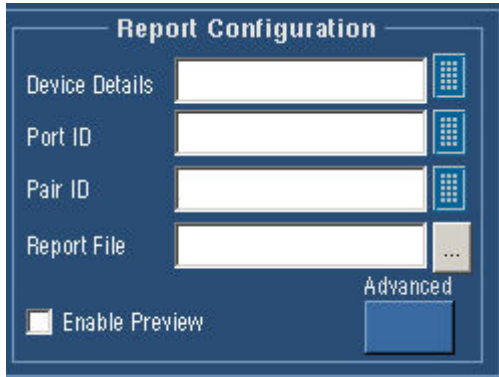

Figure 3-17: Report Configuration pane

The next table lists the report configuration fields and description.

Table 3-10: Report Configuration fields

Field	Description
Device ID	To identify on which DUT the test was conducted by printing the Device ID on the generated report.
Device description	To identify on which DUT the test was conducted by printing the Device Description on the generated report.
Pair ID	To identify the unique pairs by printing the Device Description on the generated report. This field is enabled only for 1000BASE-T.
Report File	To specify the path and the file in which the generated report will be saved. A default file name and path displayed for the selected speed.
Enable Preview	To automatically preview the report after generation.
Advanced button	Displays the Advanced Report Configuration dialog box.

Dialog Boxes

Preferences dialog box

Use this dialog box to set the user preferences such as, show or hide the Overwrite Reference message box, Overwrite Math message box, 10Base-T user intervention for Template, 10Base-T user intervention for Jitter tests and 1000Base-T user intervention for Distortion test.

Click **File > Preferences** to display the Preferences dialog box.



Figure 3-18: Preferences dialog box

The next table lists the preferences and task description.

Table 3-11: Preferences

Preference	Task Description
<p>Show or Hide the Overwrite Reference message box</p>	<p>In Preference dialog box, select or clear the Show Ref overwrite check box.</p> <p>If you select Show Ref overwrite check box, the application displays the following warning every time you run 1000BASE-T Template, Peak Volt, Distortion, and Jitter tests. This dialog box also appears for Return Loss tests. This dialog box appears for 1000BASE-T Droop test only if Disturbing Signal is selected as Yes.</p> 
<p>Show or Hide the Overwrite Math message box</p>	<p>In Preference dialog box, select or clear the Show Math overwrite check box.</p> <p>If you select Show Math overwrite check box, the application displays the following warning box every time you run 10BASE-T Harmonic Test.</p> 

Table 3-11: Preferences

<p>Show or hide 1000Base-T user intervention for Distortion test</p>	<p>In Preference dialog box, select or clear the Show 1000Base-T Distortion user control check box.</p> <p>If you select the check box, the application displays the following warning box every time you run 1000BASE-T Distortion Test.</p> 
<p>Show or hide 10Base-T user intervention for Template tests</p>	<p>In Preference dialog box, select or clear the Show 10Base-T Template user control check box.</p> <p>If you select the check box, the application displays the following warning box every time you run 10BASE-T Template Test.</p>  <p>Toggle Lock Mask to Wfm between ON and OFF to lock or unlock the mask to waveform when you zoom in or zoom out.</p> <p>Toggle Mask Autofit between ON and OFF to allow the oscilloscope to automatically fit the waveform to mask.</p>

Table 3-11: Preferences

Show or hide 10Base-T user intervention for Jitter tests

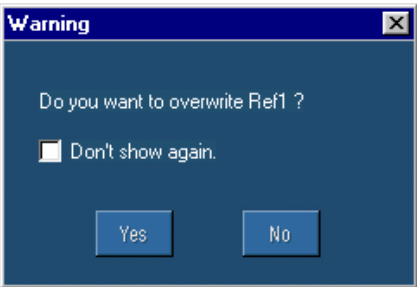
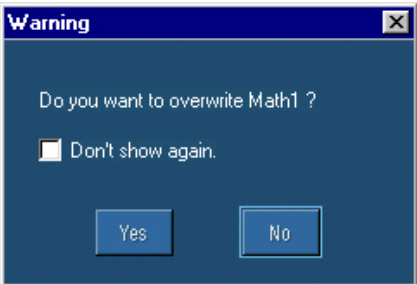
In Preference dialog box, select or clear the **Show 10Base-T Jitter user control** check box.
If you select the check box, the application displays the following warning box every time you run **10BASE-T Jitter with cable Test**.

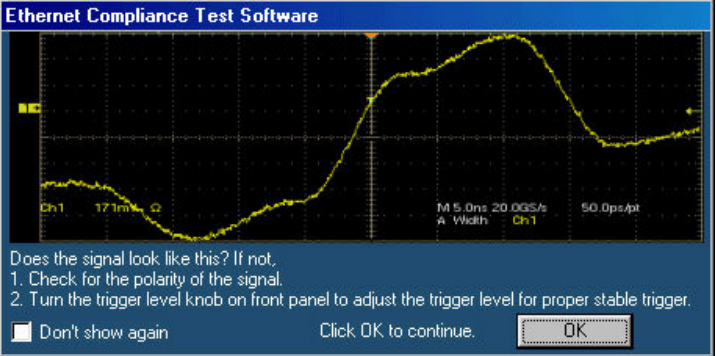
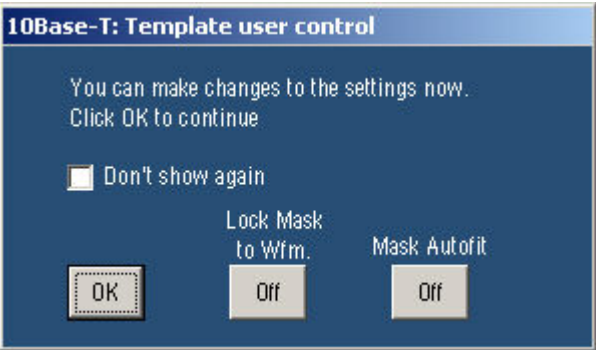
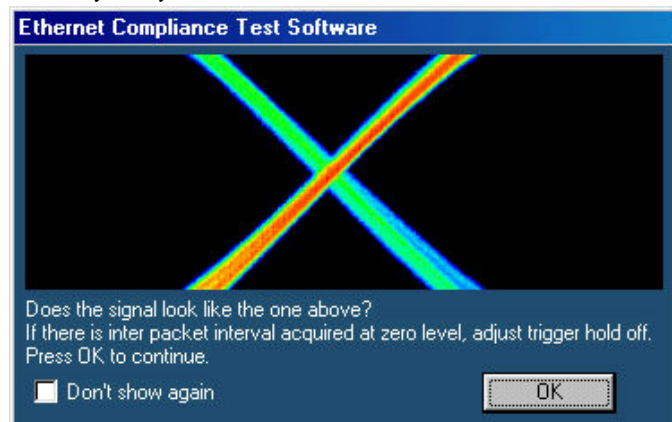

If you select the check box, the application displays the following warning box every time you run **10BASE-T Jitter without cable Test**.

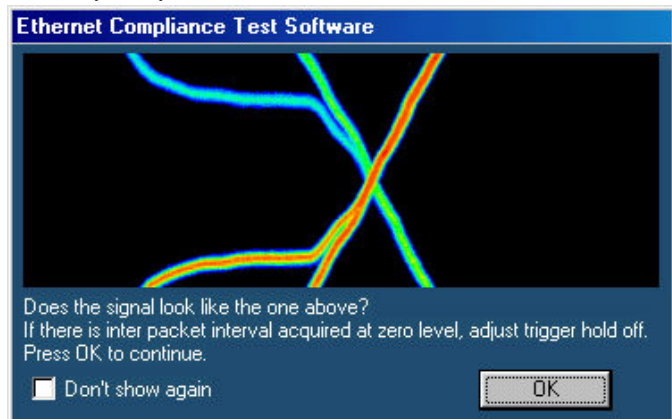

Click **OK** to set the preferences.

Click **Cancel** to exit the Preference dialog box.

Advanced Report Configuration dialog box

Select **Results** in the Execution pane, and **Advanced** in the Report Configuration pane of the Result pane. The Advanced Report Configuration dialog box appears as shown in the next figure.

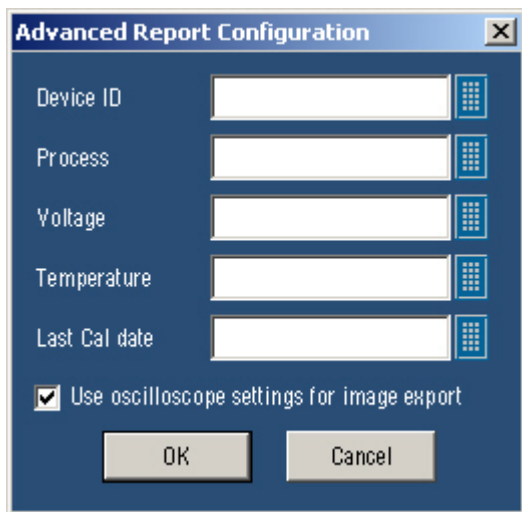

Figure 3-19: Advanced Report Configuration dialog box

The table lists the options that you can configure in the advanced report configuration dialog box.

Table 3-12: Advanced Report Configuration

Field	Description
Device ID	Prints the Device Id on the generated report to help you identify on which DUT the test was conducted.
Process	Prints the Process on the generated report to help you identify the process used for DUT.
Voltage	Prints the Voltage on the generated report to help you identify the voltage values used while testing the DUT.
Temperature	Prints the Temperature on the generated report to help you identify the temperature values used while making the DUT.
Last Cal date	Prints the Last Cal date on the generated report to help you identify the date on which the Oscilloscope was last calibrated.
Use oscilloscope settings for image report	Select this check box to use the oscilloscope settings for exporting images.

Click **OK** to configure the report.

Click **Cancel** to exit the report setup.

Result Details dialog box Select **Result Details** button in Result pane to display the Result Details dialog box.

After you have completed the test and you want to see the result details, click on the **Result Details** button in Result pane. The Result Details dialog box appears as shown by the following figure. The title bar displays the selected speed.

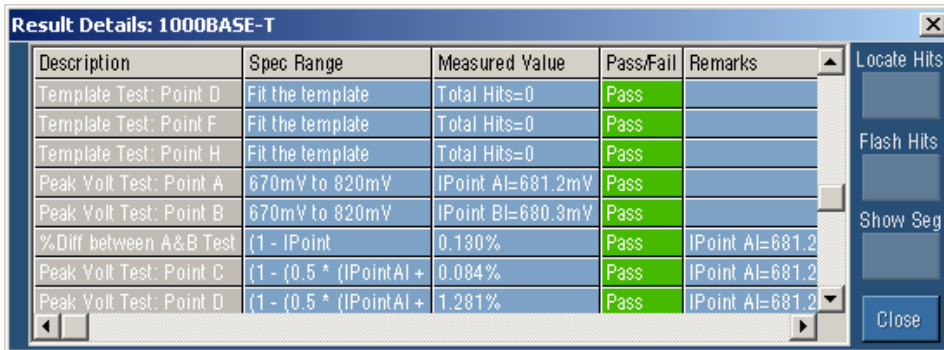

Figure 3-20: Result Details dialog box

The results are categorized as listed in the next table.

Table 3-13: Result Details Categorization

Category	Description
Description	Displays the selected test.
Spec Range	Displays the specification range.
Measured Value	Measured value of the selected test.
Pass/Fail	Test passed or failed or inconclusive as Pass , Fail , or Inconclusive .
Remarks	Additional information about the test.

Note: *Locate Hits, and Flash Hits are enabled only if a template test fails. The TDS5000B series oscilloscopes do not support Flash Hits.*

Select **Locate Hits** to view and change the mask color and hit color

Select **Flash Hits** to flash the hits on the oscilloscope display

Select **Show Seg** to display the mask segments.

Select **Close** to close the dialog box.

Note: *If you run all the tests together using **Select All**, the Locate Hits, Flash Hits, and Show Seg is disabled.*

Locate Hits dialog box Select **Result Details** button in Result pane to display the Result Details dialog box. In the Result Details dialog box, select **Locate Hits** to display the Mask Hit Locator dialog box as shown below.

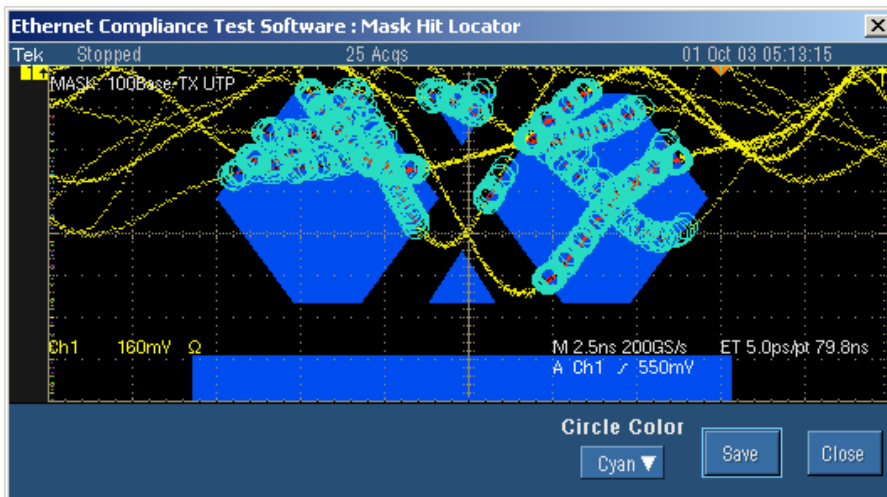

Figure 3-21: Mask Segments dialog box

1. Selecting Locate Hits changes the mask color and hit color. Closing the Locate Hits dialog box will set the Mask color to default.
2. In the **Circle Color** drop-down list, select the color in which you want to see the mask hits circled.
3. Select **Save** to save the mask-hit image as a jpg or a bmp file. The default directory is C:\TekApplications\TDSET3\Images.
4. Select **Close** to close the dialog box.

Flash Hits dialog box Select **Result Details** button in Result pane to display the Result Details dialog box. In the Result Details dialog box, select **Flash Hits** to flash the hits on the oscilloscope display. The Flash Hits message box appears as shown below.

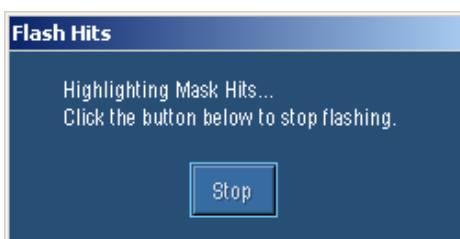

Figure 3-22: Flash Hits message box

Select **Stop** in the Flash Hits message box to stop flashing the mask hits.

Show Segments dialog box Select **Result Details** button in Result pane to display the Result Details dialog box. In the Result Details dialog box, select **Show Seg** to display the mask segments. The Show Segments dialog box appears as shown below.

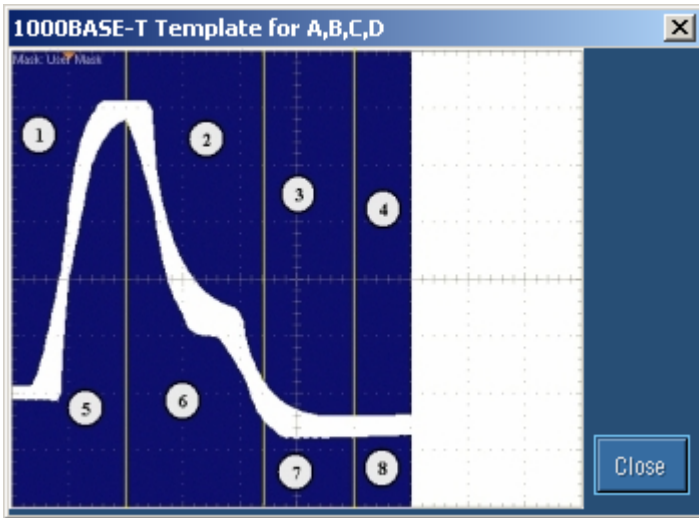

Figure 3-23: Show Segments dialog box

The Show Seg is enabled only if you run the template test.

Select **Close** to close the dialog box.

Manual Fit dialog box Select **Result Details** button in Result pane to display the Result Details dialog box. In the Result Details dialog box, select **Manual Fit** to display the manual fit dialog box.

Note: *If you select the Select All button, the Manual Fit is not enabled.*

If you are running 1000BASE-T Template test, the Manual Fit dialog box appears as shown by the next figure.

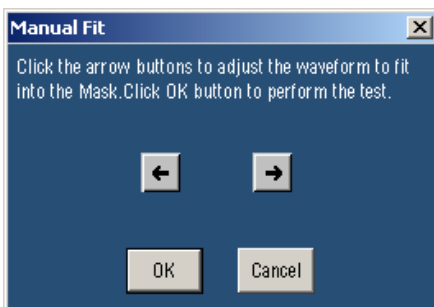

Figure 3-24: 1000BASE-T Manual Fit dialog box

When you test Template in 1000BASE-T, you can manually fit the waveform into the mask.

If the processed waveform does not lie within the mask, use **Manual Fit** to manually fit the waveform into the mask as described below:

Click the arrow buttons to adjust the waveform to fit into the Mask.

Click **OK** to perform the mask pass/fail test again.

Click **Cancel** to exit the Manual Fit dialog box without performing the mask pass/fail test.

If you are running 100BASE-TX or 10BASE-T Template tests, the Manual Fit dialog box appears as shown by the next figure.

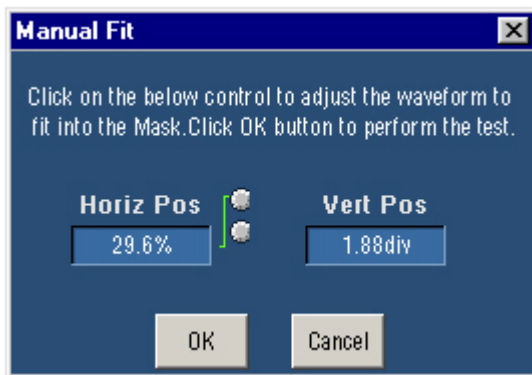

Figure 3-25: 100BASE-TX/10BASE-T Manual Fit dialog box

When you test Template in 100BASE-TX, and 10BASE-T, you can manually fit the waveform into the mask.

If the processed waveform does not lie within the mask, use **Manual Fit** to manually fit the waveform into the mask as described below:

To adjust the waveform to fit into the Mask, change the horizontal position and vertical position using the general purpose knobs or Virtual Keyboard.

Click **OK** to perform the mask pass/fail test again.

Jig match dialog box

If you are running 1000BASE-T Template test, the Jig Match button appears in the Connect pane. Click **Jig Match** to display the Jig Match dialog box.

Note: Jig Match is enabled only if you select Disturbing Signal as Yes.

Use Jig Match to effectively remove the disturbing signal and compensate for non-linearities in the disturber and the test fixture. You can measure the

disturbing signal's Amplitude, and Frequency. You can also set the default values. The application measures and displays the values in Measured Value fields. You can validate the disturbing signal by comparing the Measured Value with the Expected Value.

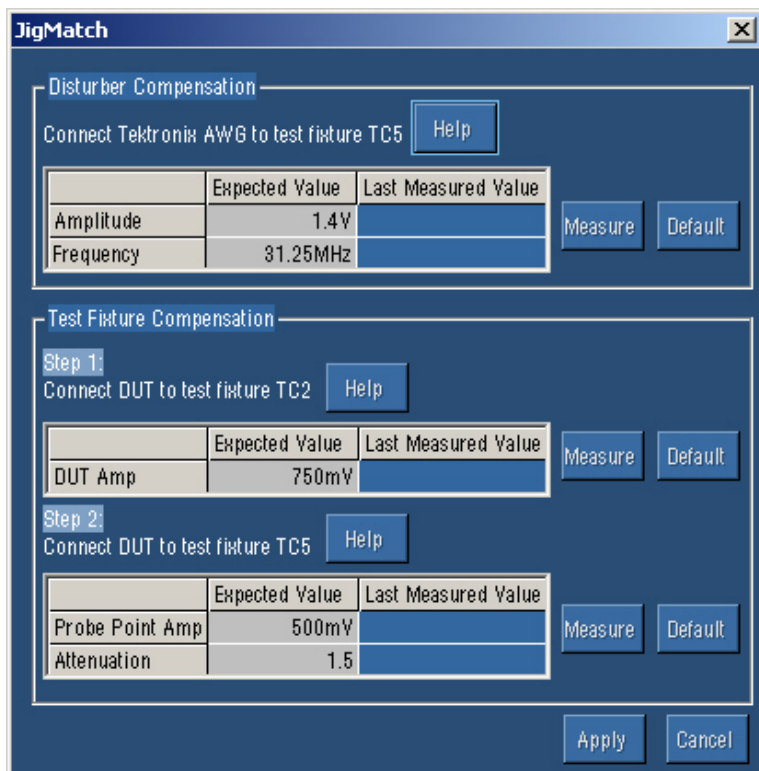

Figure 3-26: Jig Match dialog box

To compensate for the Disturbing Signal, do the following:

1. Use TC5 of the test fixture for Disturber Compensation.

2. Make the connections as shown by the following figure.

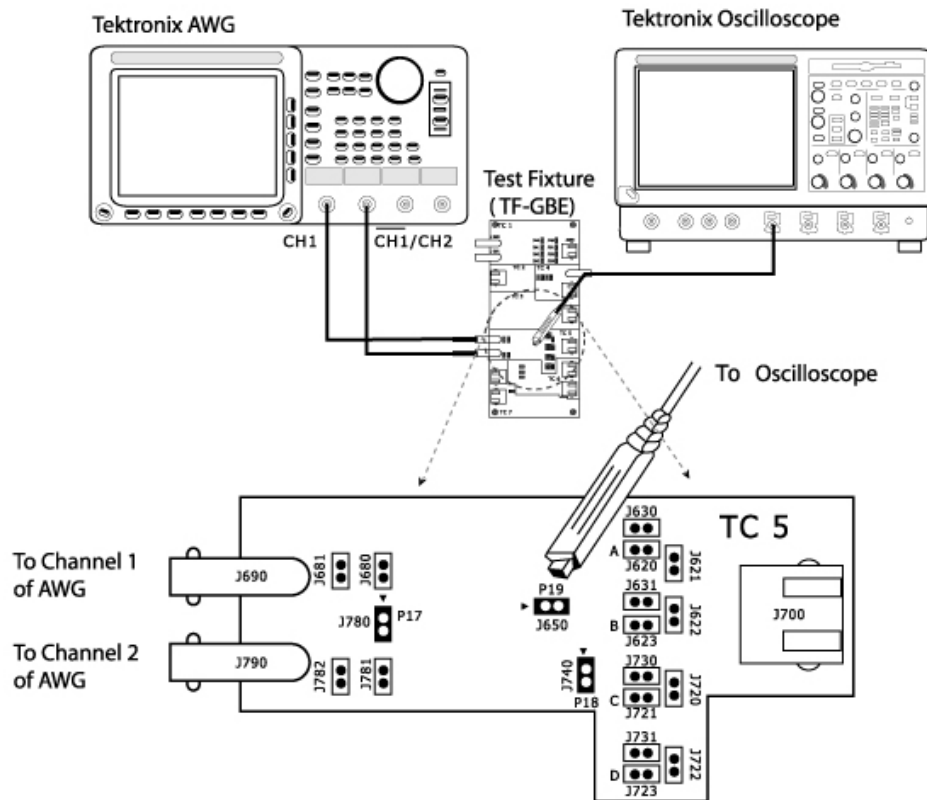

Figure 3-27: Connections for Disturber Compensation

3. Do not connect the Ethernet cable to J700 and the test port of the DUT.
4. Connect a BNC Cable to AWG+ and Channel 1 of Arbitrary Waveform Generator.
5. Connect a BNC Cable to AWG- and Channel 2 ($\overline{\text{CH1}}$) of Arbitrary Waveform Generator.
6. Short the jumpers J621, J630, J620, J623, J721, J723, J680, and J781.
7. Connect the Differential Probe to P19 and configured channel of the oscilloscope.
8. In the Jig Match dialog box, select Measure button in the Disturber Compensation pane.
9. Compare the Measured Value with the Expected Value.
10. If the Measured Value is not approximately equal to the Expected Value, modify the amplitude and clock frequency settings of the Arbitrary

Waveform Generator. Then click Measure and compare the values to be approximately equal. To compensate for the Test Fixture, do the following:

1. Use TC2 and TC5 of the test fixture for Test Fixture Compensation.
2. Make the connections as shown by the following figure.

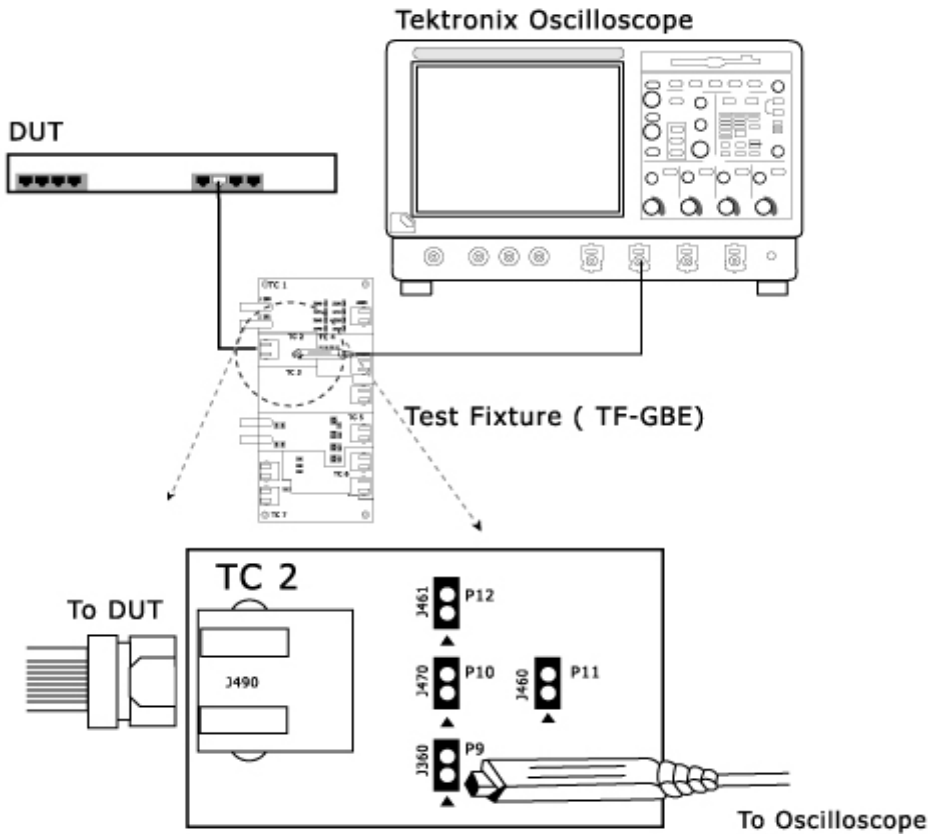

Figure 3-28: Step 1 Connections of Test Fixture Compensation

3. For Template, Droop, and Peak Voltage tests, set the DUT to generate Test Mode 1 signal.
For Distortion test, set the DUT to generate Test Mode 4 signal.
4. Connect the Ethernet cable to J490 and the test port of the DUT.
5. Connect the Differential Probe to P9 and configured channel of the oscilloscope.
6. In the Jig Match dialog box, select Measure button in Step 1 in the Test Fixture Compensation pane.
7. Make the connections as shown by the following figure.

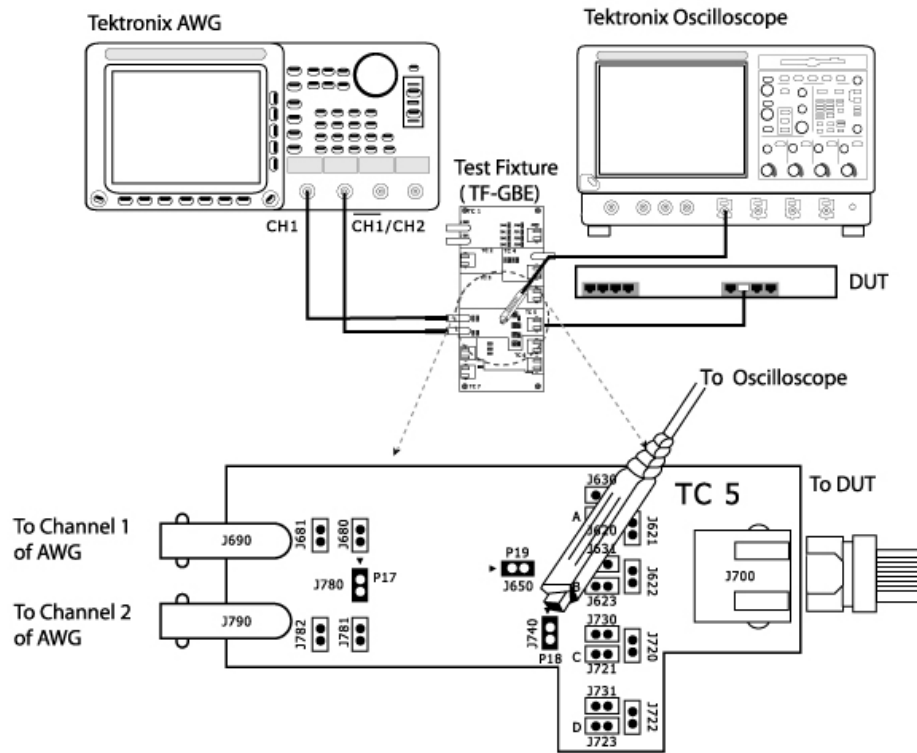

Figure 3-29: Step 2 Connections of Test Fixture Compensation

8. For Template, Droop, and Peak Voltage tests, set the DUT to generate Test Mode 1 signal.
For Distortion test, set the DUT to generate Test Mode 4 signal.
9. Connect the Ethernet cable to J700 and test port of the DUT.
10. Connect a BNC Cable to AWG+ and Channel 1 of Arbitrary Waveform Generator.
11. Connect a BNC Cable to AWG- and Channel 2 ($\overline{\text{CH1}}$) of Arbitrary Waveform Generator.
12. Switch OFF the Arbitrary Waveform Generator.
13. Short the jumpers J621, J630, J623, J721, J723, J680, and J781.
14. Connect the Differential Probe to P18 and configured channel of the oscilloscope.
15. In the Jig Match dialog box, select Measure button in Step 2 in the Test Fixture Compensation pane.

Virtual Keyboard dialog box Selecting  adjacent to any number field displays the Virtual Keyboard.



Figure 3-30: Virtual Keyboard

The field on the top displays what you have selected. After you have selected the required number, select **Enter**.

- Selecting **Space** inserts a space.
- Selecting **Enter** enters the value for the selected field.
- Selecting **Backspace** deletes the value entered.
- Selecting **Esc** exits the Virtual Keyboard.

Virtual Keypad dialog box Select the knob or the keypad icon adjacent to any text field to display the Virtual Keypad dialog box.

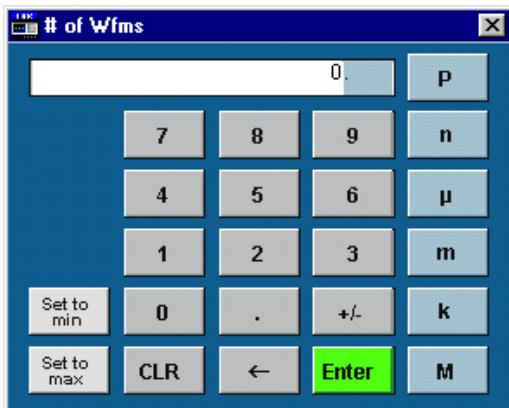

Figure 3-31: Virtual Keypad

Use this dialog box to enter custom values.

- Selecting **Set to min** to automatically display the minimum value of the selected field.
- Selecting **Set to max** to automatically display the maximum value of the selected field.
- Selecting **CLR** to clear the value for the field selected and returns to zero value.
- Selecting **Enter** to enters the value for the selected field.

Mask Setup dialog box

The **Mask Setup** button is available in the Configure pane and is enabled only when you run template tests.

If you are configuring 100BASE-TX Template test, click on Mask Setup button in the Configure pane to display the Mask Setup dialog box.



Figure 3-32: 100BASE-TX Mask Setup dialog box

In the Samples text box, enter the number of samples to use in the test. Entering the number of samples stops the test when that number has been reached.

The accepted range of samples is between 5000 and 2,147,400,000. The default number of samples is 16,000.

In the Fail Thresh text box, enter the minimum number of samples that must fail for the test to fail.

The accepted range of samples is between 1 and 2,147,483,647. The default fail threshold is 1.

Note: You can use the Virtual Keyboard or the General Purpose knobs to enter the values in the Samples and Fail Thresh fields.

If you are configuring 10BASE-T Template test, click on Mask Setup button in the Configure pane to display the Mask Setup dialog box.

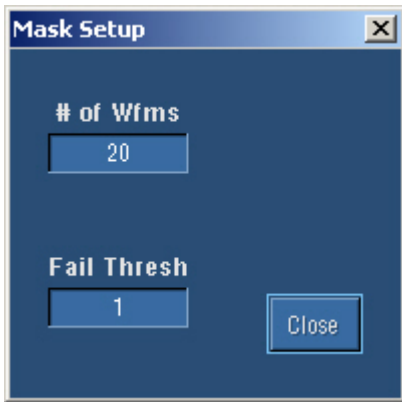

Figure 3-33: 10BASE-T Mask Setup dialog box

In the # of Wfms text box, enter the number of waveforms to use in the test. Entering the number of waveforms stops the test when that number has been reached.

The accepted range of samples is between 1 and 2,147,483,647. The default number of samples is 16.

In the Fail Thresh text box, enter the minimum number of samples that must fail for the test to fail.

The accepted range of samples is between 1 and 2,147,483,647. The default fail threshold is 1.

Smooth dialog box

Select **Result Details** button in Result pane to display the Result Details dialog box. In the Result Details dialog box, select **Smooth** to smoothen the return loss waveform. This button is enabled only when you test Return Loss for all speeds.

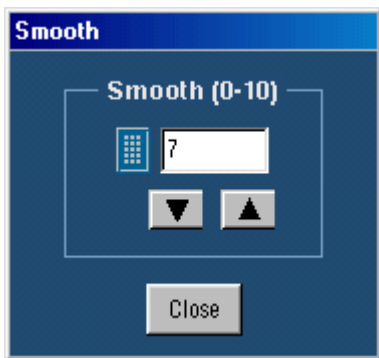

Figure 3-34: Smooth dialog box

After you test Return Loss, you can change the smoothness of the waveform. The accepted range is within 0 to 10. The default is 7.

Click the arrow buttons to increase or decrease the value and view the smoothness of the waveform. The waveform is automatically updated as you change the value.

Click **Close** to perform the pass/fail test again.

Exit dialog box

Select **File > Exit** to display the following message box:

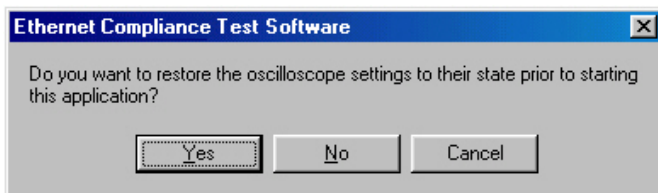

Figure 3-35: Exit dialog box

You can exit the application by restoring the oscilloscope settings to the previous state prior to starting the application or retaining the present oscilloscope settings.

- Select **File> Exit**.
- Select **Yes** to restore the oscilloscope settings to their original state prior to starting the application and exit the application.
or
Select **No** to retain the present oscilloscope settings and exit the application.
or
Select **Cancel** to cancel the operation and return to the application.

Note: Clicking **X** displays the Exit dialog box.

How To Select Test Parameters

Selecting 1000BASE-T Test Parameters

The following table lists how to select the 1000BASE-T test parameters.

Table 4-1: Select 1000BASE-T Test Parameters

Test Parameter	Selection
1000BASE-T	Click Tests > Select > 1000BASE-T or select 1000-T in the Speed pane.
Template	In the Template/Volt tab, select a point in the <i>Template</i> group.
Peak Voltage	In the Template/Volt tab, select a point in the <i>Peak Volt</i> group.
Droop	In the Droop tab, select a point.
Jitter Master Filtered	In the Jit/Distortion tab, select Master Filtered.
Jitter Master Unfiltered	In the Jit/Distortion tab, select Master Unfiltered.
Jitter Slave Filtered	In the Jit/Distortion tab, select Slave Filtered.
Jitter Slave Unfiltered	In the Jit/Distortion tab, select Slave Unfiltered.
Distortion	In the Jit/Distortion tab, select Distortion.
Return Loss	In the Return Loss tab, select Return Loss.
CM Voltage	In the CM Voltage tab, select CM Voltage.

Note: The TDS5000B series oscilloscopes do not support Jitter Slave Filtered test.

Selecting 100BASE-TX Test Parameters

The following table lists how to select the 100BASE-TX test parameters.

Table 4-2: Select 100BASE-TX Test Parameters

Test Parameter	Selection
100BASE-TX	Click Tests > Select > 100BASE-TX or select 100-TX in the Speed pane.
Template	In the <i>Parametric</i> tab, select Template. In the Polarity drop-down list, select Pos for positive, Neg for negative, or Both. For Positive polarity, the application tests segments 1, 2, 3, 6, and 7. For Negative polarity, the application tests segments 4, 5, 8, 9, and 10. For Both, the application tests all the segments.
Differential Output Voltage	In the <i>Parametric</i> tab, select Output Volt. In the Polarity drop-down list, select Pos for positive, Neg for negative, or Both.

Signal Amplitude Symmetry	In the <i>Parametric</i> tab, select Amp Sym. In the Polarity drop-down list, select Pos for positive, Neg for negative, or Both.
Rise Time	In the <i>Parametric</i> tab, select Rise Time. In the Polarity drop-down list, select Pos for positive, Neg for negative, or Both.
Fall Time	In the <i>Parametric</i> tab, select Fall Time. In the Polarity drop-down list, select Pos for positive, Neg for negative, or Both.
Rise/Fall Time Symmetry	In the <i>Parametric</i> tab, select R/F Sym. In the Polarity drop-down list, select Pos for positive, Neg for negative, or Both.
Waveform Overshoot	In the <i>Parametric</i> tab, select Overshoot. In the Polarity drop-down list, select Pos for positive, Neg for negative, or Both.
Jitter	In the <i>Parametric</i> tab, select Jitter. In the Polarity drop-down list, select Pos for positive, Neg for negative, or Both.
Duty Cycle Distortion	In the <i>Parametric</i> tab, select Distortion. Select Random or 010101 in the Pattern drop-down list.
Return Loss	In the <i>Return Loss</i> tab, select either Transmitter or Receiver.

Selecting 10BASE-T Test Parameters

The following table lists how to select the 10BASE-T test parameters.

Table 4-3: Select 10BASE-T Test Parameters

Test Parameter	Selection
10BASE-T	Click Tests > Select > 10BASE-T or select 100-T in the Speed pane.
Template MAU	In the Template tab, select MAU and select Normal, Inverted or Both in the adjacent drop-down list. Select Configure in the Selection pane and select the MAU Type as External or Internal.
Template Link Pulse	In the Template tab, select Link Pulse. In the adjacent drop-down list, select the load with or without TPM — Load1 w/o TPM, Load2 w/o TPM, 100 ohm w/o TPM, Load1 with TPM, Load2 with TPM, or 100 ohm with TPM.
Template TP_IDL	In the Template tab, select TP_IDL. In the adjacent drop-down list, select the load with or without TPM — Load1 w/o TPM, Load2 w/o TPM, 100 ohm w/o TPM, Load1 with TPM, Load2 with TPM, or 100 ohm with TPM.
Differential Voltage	In the Parametric tab, select Diff Volt. From the Peak drop-down list, select the peak value as Max or MinMax.
Harmonic	In the Parametric tab, select Harmonic.
Jitter with cable	In the Parametric tab, select With Cable in the <i>Jitter</i> group. Select Normal, 8BT, 8.5BT, or All in the adjacent drop-down list.
Jitter without cable	In the Parametric tab, select w/o Cable in <i>Jitter</i> group. Select Normal, 8BT, 8.5BT, or All in the adjacent drop-down list.
Return Loss	In the <i>Return Loss</i> tab, select either Transmitter or Receiver.
CM Voltage	In the CM Voltage tab, select CM Voltage.

How To Configure Parameters

Configuring 1000BASE-T

Use this dialog box to configure 1000BASE-T for Source, # Averages, Output, Disturbing Signal, and Filter.

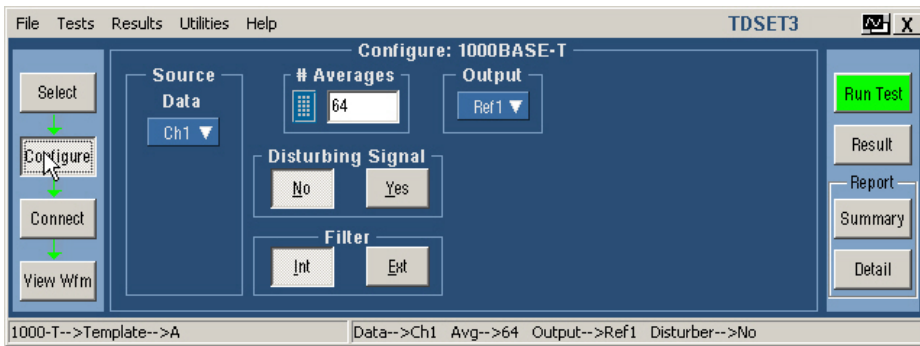

Figure 5-1: 1000BASE-T Configure pane

The following table shows the 1000BASE-T tests parameters you can configure.

Table 5-1: 1000BASE-T Configure parameters

	Data	Master CLK	Slave CLK	TX_TCLK	Data (TM2)	Data (TM3)	# Averages	Clock Edge (Rising / Falling)	Disturbing Signal (Yes / No)	Filter (Int or Ext)	Hi Resolution	TX_TCLK (No / Yes)	Output	Meas Type (Histogram/ TIE)	Probe: P1	Probe: P2	Pair ID	Load	Smooth	Record Length	Low Pass Filter	Hysteresis
Template	✓						✓		✓	✓			✓									
Peak Volt	✓						✓		✓	✓			✓									
Droop	✓						✓		✓	✓			✓									
Jitter Master Filtered	✓	✓			✓			✓				✓									✓	✓
Jitter Master Unfiltered		✓			✓			✓				✓		✓							✓	✓
Jitter Slave Filtered	✓	✓	✓		✓	✓		✓				✓		✓							✓	✓
Jitter Slave Unfiltered		✓	✓		✓	✓		✓				✓		✓							✓	✓
Distortion	✓			✓			✓		✓		✓	✓	✓									✓
Return Loss							✓								✓	✓	✓	✓	✓			
CM Voltage	✓						✓															

The following table describes the 1000BASE-T configuration parameters.

Table 5-2: 1000BASE-T Configure parameter description













Configure parameters	Description
<p>Source</p> 	<p>The Data source and CLK source should be mutually exclusive. The Data source, Master CLK source and Slave clock source should be mutually exclusive.</p> <p>Data — Select the channel to which the DUT signal is connected.</p> <p>Master CLK — Select the channel to which the master clock is connected.</p> <p>Slave CLK — Select the channel to which the slave clock is connected.</p> <p>TX_TCLK — Select the channel to which the TX_TCLK is connected.</p> <p>Data (TM2) — Select the channel to which data in Test Mode 2 is connected.</p> <p>Data (TM3) — Select the channel to which data in Test Mode 3 is connected.</p> <p>Note: TX_TCLK drop-down list appears only for Distortion test and if you have selected TX_TCLK as Yes.</p> <p>Data (TM2) and Data (TM3) drop-down list appears only for Jitter tests if you have selected the TX_TCLK as No.</p> <p>Master CLK and Slave CLK drop-down list appears only for Jitter tests if you have selected the TX_TCLK as Yes.</p>
<p># of Averages</p> 	<p>Enter the number of averages between 64 and 10000 depending on the noise present in the acquired waveform.</p>
<p>Clock Edge</p> 	<p>Select the clock edge on which the oscilloscope finds the trigger point.</p>
<p>Disturbing Signal</p> 	<p>Select Yes or No depending on whether the disturbing signal is added to the test mode signal.</p>
<p>Filter</p> 	<p>Select Int or Ext depending on whether the filter is applied internally or externally.</p>
<p>TX_TCLK</p> 	<p>Select Yes or No to perform the Distortion test with TX_TCLK.</p>
<p>Output</p> 	<p>Select the reference waveform on which the processed waveform will be stored.</p>

Table 5-2: 1000BASE-T Configure parameter description

Configure parameters	Description
<p>Meas Type</p> 	<p>Select the measurement type as either Time Interval Error (TIE) or Histogram.</p>
<p>Hi Resolution</p> 	<p>Enter the number of averages to be done in the vertical domain.</p>
<p>Return Loss</p> 	<p>Probe:P1 and Probe:P2 — Select the channels to which the probes are connected. Note: Depending on the Pair ID selected, the sources will change from P1/P3/P5/P7 and P2/P4/P6/P8. Load — Select the load as 85, 100, 111 ohm or 100 ohm. Pair ID — Select the Pair ID as A, B, C, or D. Depending on the Pair ID selected the sources will change from P1/P3/P5/P7 and P2/P4/P6/P8. Return Loss — Select the reference waveform on which the output waveform will be stored. 0dB Marker — Select the reference waveform on which you want the 0dB Marker to be indicated. Note: Return Loss and 0dB Marker fields appear only if you set Load as 100 ohm. # Averages — Enter the number of waveforms you want to average. Smooth — Enter the smoothing factor.</p>
<p>Record Length</p> 	<p>Varies depending on the Memory option available on the Oscilloscope.</p>
<p>Low Pass Filter</p> 	<p>Select Yes or No. The Low Pass Filter has a cutoff frequency of 150 MHz and when applied, eliminates high frequency noise.</p>
<p>Hysteresis</p> 	<p>Enter the hysteresis percent value.</p>

The following table lists the configuration parameters and default settings.

Table 5-3: 1000BASE-T Configuration Default Settings

Parameter	Options	Default
Data	CH1, CH2, CH3, CH4	CH1
Master CLK	CH1, CH2, CH3, CH4	CH2
Slave CLK	CH1, CH2, CH3, CH4	CH3
Data (TM2)	CH1, CH2, CH3, CH4	CH1
Data (TM3)	CH1, CH2, CH3, CH4	CH2
# Averages	64 to 10000	64
Clock Edge	Rising, Falling	Rising
Disturbing Signal	Yes, No	No
Filter	Int, Ext	Int
TX_TCLK	No, Yes	No
TX_TCLK	CH1, CH2, CH3, CH4	CH2
Output	Ref1, Ref2, Ref3, Ref4	Ref1
Meas Type	Histogram, TIE	TIE
Hi Resolution	02 to 75	64
Probe:P1/P3/P5/P7	CH1, CH2, CH3, CH4	CH1
Probe:P2/P4/P6/P8	CH1, CH2, CH3, CH4	CH2
Pair ID	A, B, C, D	A
Load	85, 100, 115 or 100 ohm	85, 100, 115 ohm

Note: The TDS5052B oscilloscope displays the graticule only for 100 ohm Load.

Smooth	0 - 10	7
Record Length		Varies depending on the Memory option available on the Oscilloscope.
Low Pass Filter	Yes, No	Yes
Hysteresis	5.00% to 30.00%	5.00%

Configuring 100BASE-TX

Use this dialog box to configure 100BASE-TX for Data source, Acquisition, Rise/Fall Time Test, and Mask Setup.

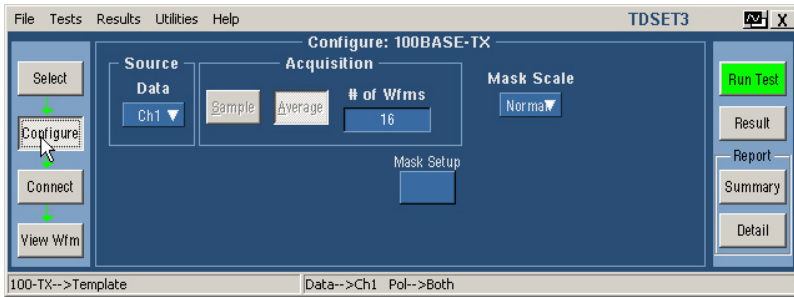

Figure 5-2: 100BASE-TX Configure pane







The following table shows parameters of 100BASE-TX that you can configure.

Table 5-4: 100BASE-TX Configure parameters

	Data	Acquisition	Mask Scale	Mask Setup	Pulse Width	Probe:P1	Probe:P2	Probe:P3	Probe:P4	AWG Series	Load	# Averages	Smooth
Template	✓		✓	✓									
Differential Output Voltage	✓	✓											
Amplitude Symmetry	✓	✓											
Rise Time	✓	✓			✓								
Fall Time	✓	✓			✓								
Rise or Fall Time Symmetry	✓	✓			✓								
Waveform Overshoot	✓	✓											
Jitter	✓												
Duty Cycle Distortion	✓	✓											
Return Loss Transmitter						✓	✓			✓	✓	✓	✓
Return Loss Receiver								✓	✓	✓	✓	✓	✓

The following table describes the 100BASE-TX configuration parameters.

Table 5-5: 100BASE-TX Configure parameter description

Configure parameters	Description
<p>Source</p> 	<p>Select the channel to which the Device Under Test (DUT) is connected.</p>
<p>Acquisition</p> 	<p>Select Sample or Average depending on the acquisition mode. The Acquisition is only enabled for some tests.</p> <p>If you select Average, enter the number of waveforms in # of <i>Wfms</i> field.</p> <p>If you select Sample, the application assumes the number of waveforms as 1.</p> <p>You can use the virtual keyboard or the general-purpose knobs to enter the values in the samples and fail thresh text boxes.</p>
<p>Rise/Fall Time Test</p> 	<p>Select Pulse Width as 16ns or 80ns.</p> <p>You can only configure this parameter for Rise/Fall Time Symmetry, Rise Time, and Fall Time tests.</p>
<p>Mask Scale</p> 	<p>Select <i>Mask Scale</i> as Normal, 0.95, or 1.05 depending on the Mask scale factor.</p> <p>You can configure <i>Mask Scale</i> only for Template test.</p>
<p>Mask Setup</p> 	<p>You can configure the Samples and Fail Thresh. You can only configure these parameters for the template tests.</p>
<p>Return Loss</p> 	<p>Probe:P1 and Probe:P2 — Select the channels to which the probes are connected on the fixture.</p> <p>Note: Depending on whether the Transmitter or Receiver is selected, the sources will change from P1/P3 and P2/P4.</p> <p>Return Loss — Select the reference waveform on which the output waveform will be stored.</p> <p>0dB Marker — Select the reference waveform on which you want the OdB Marker to be indicated.</p> <p>Note: Return Loss and 0dB Marker fields appear only if you set Load as 100 ohm.</p> <p>AWG Series — Select the AWG Series to use. If you select the default value—Select—then the application considers all AWGs other than the AWG 4xx series.</p> <p>Load — Select the load as 85, 100, 111 ohm or 100 ohm.</p> <p># Averages — Enter the number of waveforms you want to average.</p> <p>Smooth — Enter the smoothing factor.</p>

The following table lists the configuration parameters and default settings.

Table 5-6: 100BASE-TX Configuration Default Settings

Parameter	Options	Default
Data	CH1, CH2, CH3, CH4	CH1
Acquisition	Sample, Average	If you select Sample, the default value is 1. If you select Average, the default # of Wfms is 16.
Mask Scale	Normal, 0.95, 1.05	Normal
Mask Setup		See Mask Setup for information on default Sample and Fail Thresh.
Pulse Width	16 ns, 80 ns	80 ns
Probe:P1/P3	CH1, CH2, CH3, CH4	CH1
Probe:P2/P4	CH1, CH2, CH3, CH4	CH2
AWG Series	Select, AWG 4xx, AWG 2021, AWG 5xx, AWG 6xx, AWG 7xx	Select
Load	85, 100, 115 ohm or 100 ohm	85, 100, 115 ohm
Smooth	0 - 10	7

Note: The two-channel oscilloscopes display the graticule only for 100 ohm Load.

Configuring 10BASE-T

Use this dialog box to configure 10BASE-T for Data source, Acquisition, Harmonic Ones, and Mask Setup.

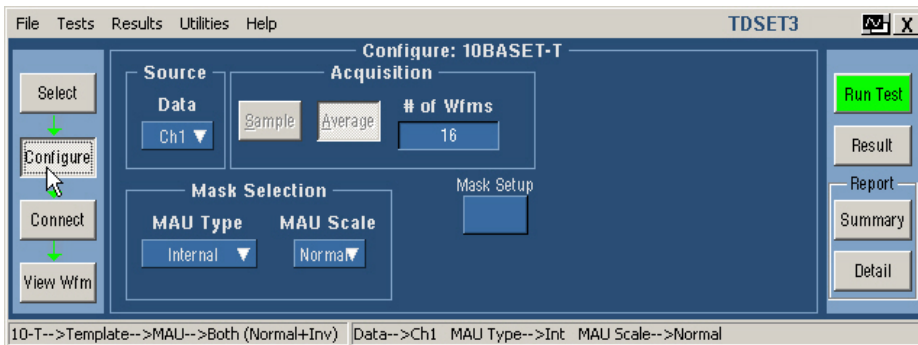

Figure 5-3: 10BASE-T Configure pane

The following table shows parameters of 10BASE-T that you can configure.

Table 5-7: 10BASE-T Configure parameters

	Data	Acquisition	Mask Selection			Mask Setup	Sequence	Harmonic Ones			Probe:P1	Probe:P2	Probe:P3	Probe:P4	AWG Series	Load	# Averages	Smooth	Test Options
			Section	MAU Type	MAU Scale			Output	# Averages	Time/ Scale									
Template Link Pulse	✓	✓	✓			✓	✓												✓
Template MAU	✓			✓	✓	✓													
Template TP_IDL	✓	✓	✓			✓													
Jitter with Cable	✓			✓															
Jitter without Cable	✓			✓															
Differential Voltage	✓																		
Harmonic	✓							✓	✓	✓									
Return Loss Transmitter										✓	✓			✓	✓	✓	✓		
Return Loss Receiver												✓	✓	✓	✓	✓	✓		
CM Voltage	✓																		

The following table describes the 10BASE-T configuration parameters.

Table 5-8: 10BASE-T Configure parameter description



Configure parameters	Description
Source 	Select the channel to which the Device Under Test (DUT) is connected.
Acquisition 	Select Sample or Average depending on the acquisition mode. The Acquisition is only enabled for some tests. If you select Average, enter the number of waveforms in # of Wfms field. If you select Sample, the application assumes the number of samples as 1. You can use the virtual keyboard or the general-purpose knobs to enter the values in the samples and fail thresh text boxes.

Table 5-8: 10BASE-T Configure parameter description



Configure parameters	Description
<p>Mask Selection</p> 	<p>Select <i>MAU Type</i> as Internal or External. Select <i>MAU Scale</i> as Normal, 0.9, or 1.1 depending on the MAU scale factor. Select <i>Section</i> as Both, Head or Tail depending on the section of mask to test. You can configure <i>MAU Type</i> and <i>MAU Scale</i> only for Template MAU tests. You can configure <i>Section</i> only for Template TP_IDL and Link Pulse tests.</p>
<p>Mask Setup</p> 	<p>You can configure the Samples and Fail Thresh. You can only configure these parameters for the template tests.</p>
<p>Harmonic all of ones</p> 	<p>Select the math waveform on which the processed waveform will be displayed. Enter the number of math waveforms to be averaged. Enter the time or scale depending on the packet length being transmitted.</p>
<p>Sequence</p> 	<p>You can set the sequence to Normal (NLP) or Fast (FLP). You can only configure this parameter for the Template Link Pulse test.</p>
<p>Test Options</p> 	<p>Select Both to perform Template and Timing tests, Template Only to perform Template tests, and Timing Only to perform Timing tests. Timing tests are available for normal link pulse.</p>
<p>Return Loss</p> 	<p>Probe:P1 and Probe:P2 — Select the channels to which the probes are connected on the fixture. Note: Depending on whether the Transmitter or Receiver is selected, the sources will change from P1/P3 and P2/P4. Return Loss — Select the reference waveform on which the output waveform will be stored. 0dB Marker — Select the reference waveform on which you want the 0dB Marker to be indicated. Note: Return Loss and 0dB Marker fields appear only if you set Load as 100 ohm. AWG Series — Select the AWG Series to use. If you select the default value—Select—then the application considers all AWGs other than the AWG 4xx series. Load — Select the load as 85, 100, 111 ohm or 100 ohm.</p>

Table 5-8: 10BASE-T Configure parameter description

Configure parameters	Description
	# Averages — Enter the number of waveforms you want to average. Smooth — Enter the smoothing factor.

The following table lists the configuration parameters and default settings.

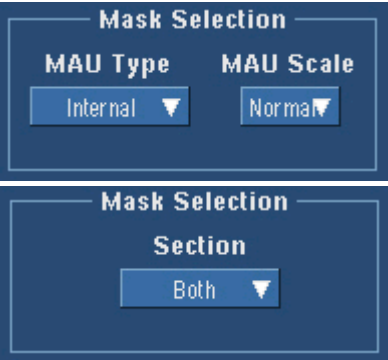
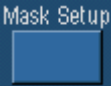
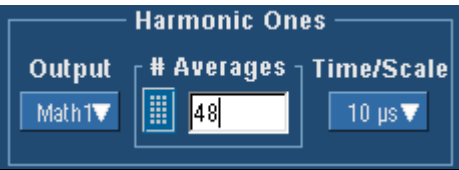
Table 5-9: 10BASE-T Configuration Default Settings

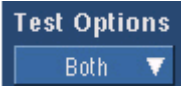
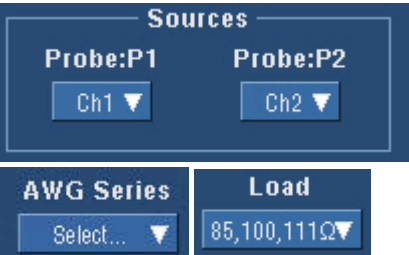
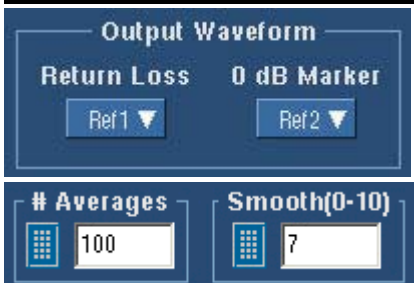
Parameter	Options	Default
Data	CH1, CH2, CH3, CH4	CH1
Acquisition	Sample, Average	If you select Sample, the default value is 1. If you select Average, the default # of Wfms is 16.
Section	Both, Head, Tail	Both
MAU Type	Internal, External	Internal
MAU Scale	Normal, 0.9, 1.1	Normal
Mask Setup		See Mask Setup for information on default Sample and Fail Thresh.
Sequence	Normal (NLP), Fast (FLP)	Normal (NLP)
Test Options	Both, Template Only, Timing Only	Both
Output	Math1, Math2, Math3, Math4	Math1
Time/Scale	10 micro seconds, 1micro seconds	10 micro seconds
# Averages		48 for other tests and 100 for Return Loss
Probe:P1/P3	CH1, CH2, CH3, CH4	CH1
Probe:P2/P4	CH1, CH2, CH3, CH4	CH2
AWG Series	Select, AWG 4xx, AWG 2021, AWG 5xx, AWG 6xx, AWG 7xx	Select
Load	85, 100, 111 ohm or 100 ohm	85, 100, 111 ohm
Smooth	0 - 10	7

Note: The TDS5052B oscilloscope displays the graticule only for 100 ohm Load.

Making Connections

1000BASE-T Connections

Template, Peak Volt, Droop, and Distortion

Use TC5 of the test fixture for these tests with disturbing signal and TC2 of the test fixture for these tests without disturbing signal.

With Disturbing Signal

Make the connections as shown by the following figure.

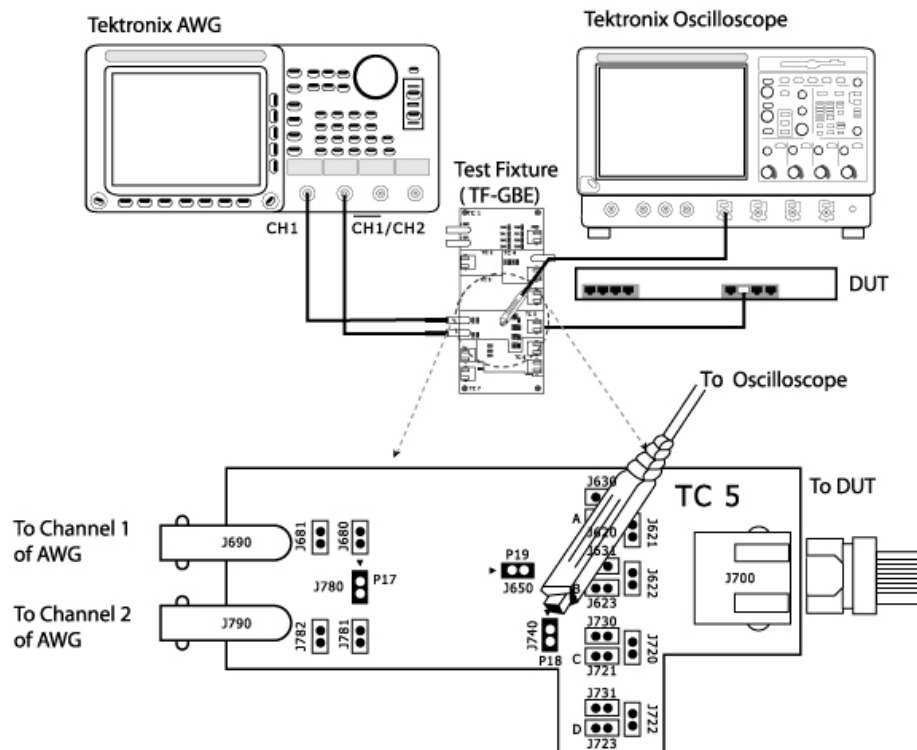

Figure 6-1: 1000BASE-T Connections with disturbing signal for Template, Peak Volt, Droop, and Distortion

For Template, Peak Volt, and Droop tests, set the DUT to generate Test Mode 1 signal. For Distortion test, set the DUT to generate Test Mode 4 signal.

1. Connect the Ethernet cable to J700 and test port of the DUT.

2. Connect a BNC Cable to AWG+ and Channel 1 of Arbitrary Waveform Generator.
3. Connect a BNC Cable to AWG– and Channel 2 ($\overline{\text{CH1}}$) of Arbitrary Waveform Generator.

Note: The AWG waveforms are available in *C:\TekApplications\TDSET3\AWGWaveforms*. You can use relevant waveform files to generate the disturbing signal. Some of the AWG models do not support the .set file for automatic settings. Referto the ReadMe.txt file for instructions to make those settings manually. **In particular, ensure that the AWG clock frequency is set to 250 MHz.** This file is available in the corresponding AWG waveform file folder. You can automate the AWG to transfer files and settings as described in *Automate AWG*.

4. To test Pair A, do the following:
 - Short the jumpers J621, J630, J623, J721, J723, J680, and J781.
 - Ensure that the other jumpers are open.
 - Connect the Differential Probe to P18 and configured channel of the oscilloscope.
5. To test Pair B, do the following:
 - Short the jumpers J620, J622, J631, J721, J723, J680, and J781.
 - Ensure that the other jumpers are open.
 - Connect the Differential Probe to P18 and configured channel of the oscilloscope.
6. To test Pair C, do the following:
 - Short the jumpers J620, J623, J720, J730, J723, J680, and J781.
 - Ensure that the other jumpers are open.
 - Connect the Differential Probe to P18 and configured channel of the oscilloscope.
7. To test Pair D, do the following:
 - Short the jumpers J620, J623, J721, J722, J731, J680, and J781.
 - Ensure that the other jumpers are open.

- Connect the Differential Probe to P18 and configured channel of the oscilloscope.

Without Disturbing Signal

Make the connections as shown by the following figure.

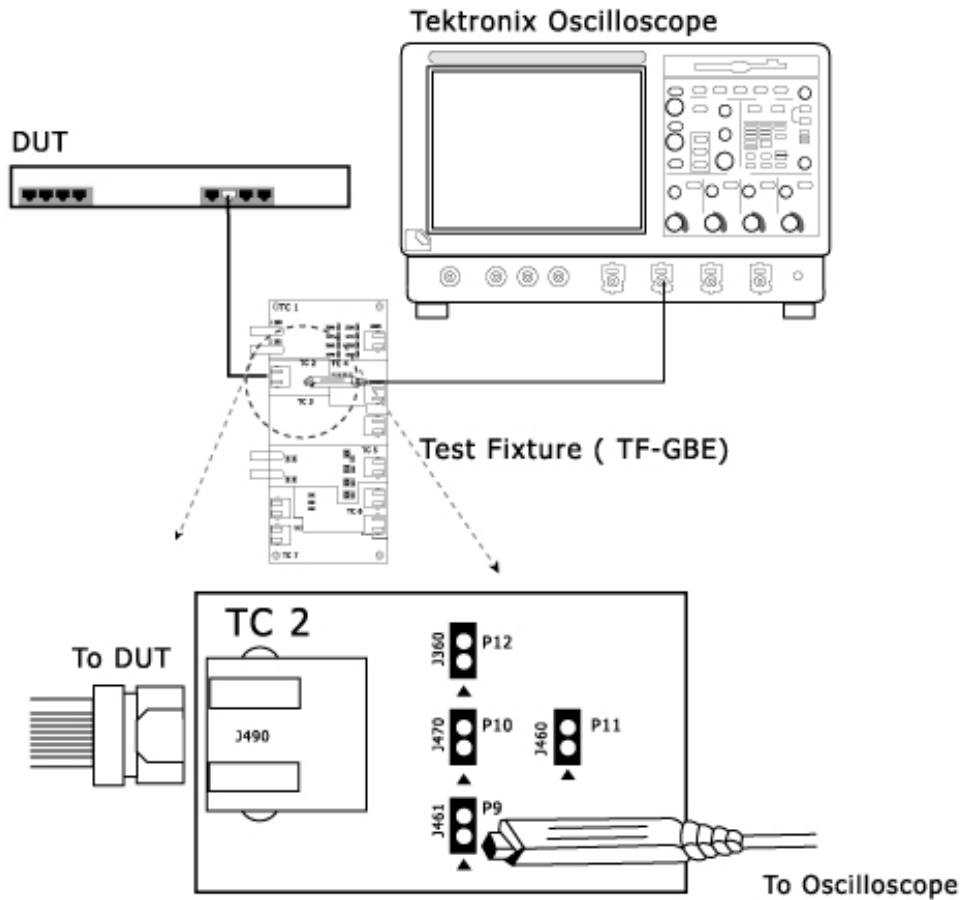

Figure 6-2: 1000BASE-T Connections without disturbing signal for Template, Peak Volt, Droop, and Distortion

1. For Template, Peak Volt, and Droop tests, set the DUT to generate Test Mode 1 signal.
For Distortion test, set the DUT to generate Test Mode 4 signal.
2. Connect the Ethernet cable to J490 and test port of the DUT.
3. To test Pair A, connect the Differential Probe to P9 and configured channel of the oscilloscope.

4. To test Pair B, connect the Differential Probe to P10 and configured channel of the oscilloscope.
5. To test Pair C, connect the Differential Probe to P11 and configured channel of the oscilloscope.
6. To test Pair D, connect the Differential Probe to P12 and configured channel of the oscilloscope.

***Note:** Align the positive (+) probe-tip of the differential probe with the notch marked on the test fixture.*

Jitter Master Filtered **If you have access to TX_TCLK**

Step 1

Use TC3 of the test fixture to calculate master clock jitter. Make the connections as shown by the following figure.

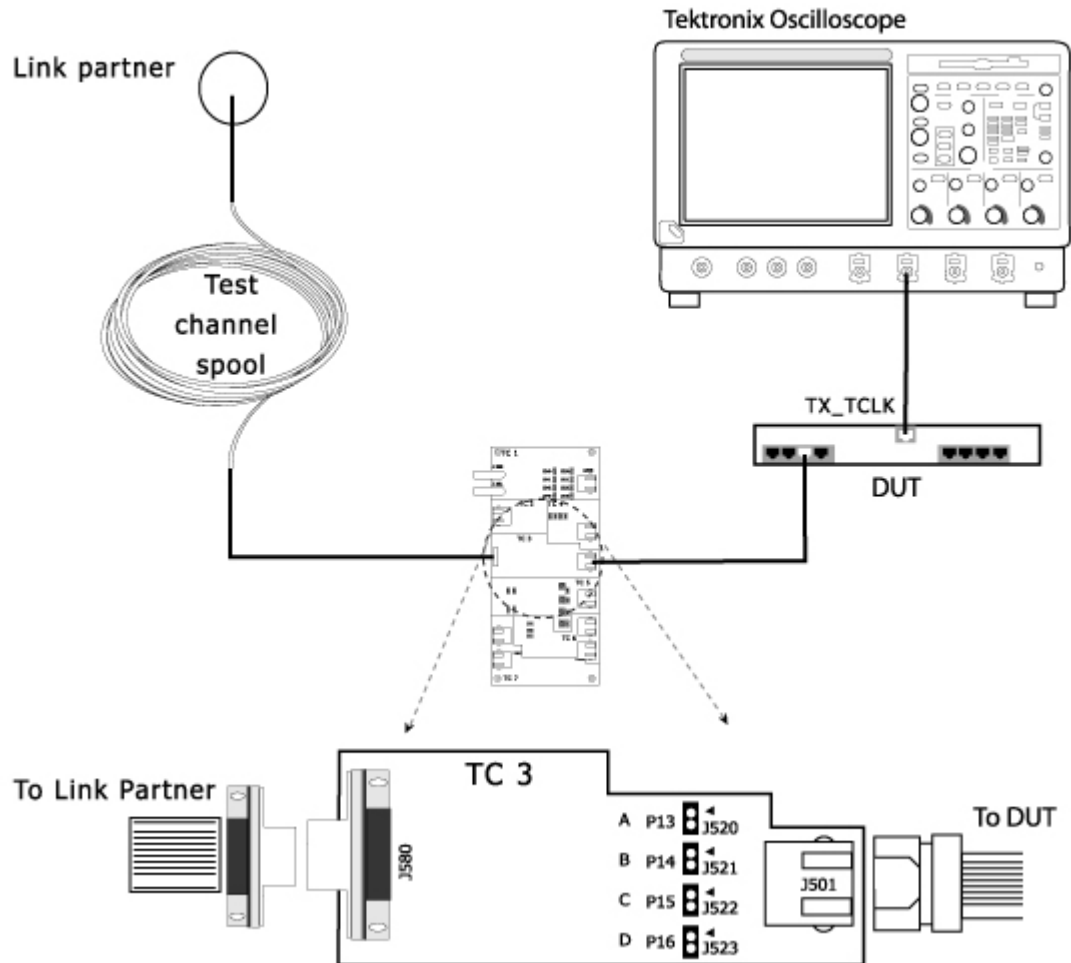

Figure 6-3: 1000BASE-T Step 1 Connections for Jitter Master Filtered

1. Set the DUT in Normal mode as master.
2. Connect the Ethernet cable to J501 and test port of the DUT.
3. Connect the Test Channel spool to J580 and Link partner.
4. Connect the active probe from TX_TCLK of the DUT to the configured channel of the oscilloscope.

Step 2

Use TC2 of the test fixture to calculate data jitter with respect to master clock. Make the connections as shown by the following figure.

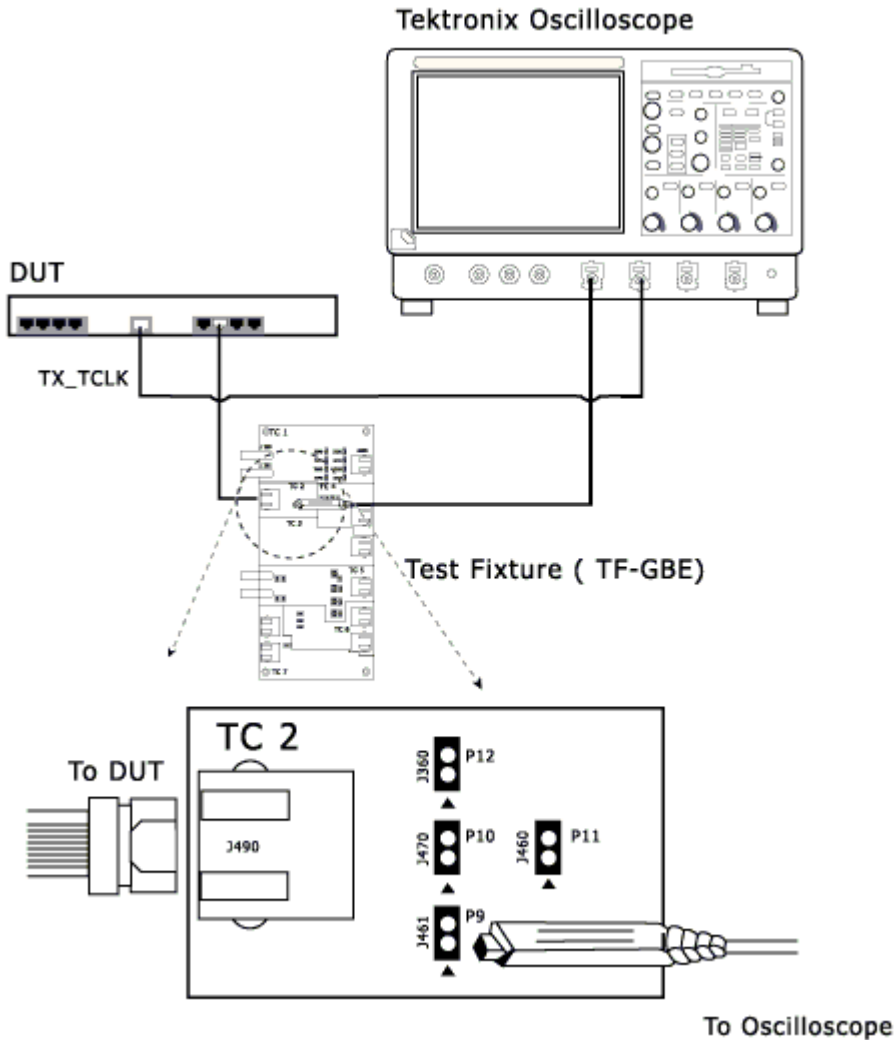

Figure 6-4: 1000BASE-T Step 2 Connections for Jitter Master Filtered

1. Set the DUT to generate Test Mode 2 signal.
2. Connect the Ethernet cable to J490 and test port of the DUT.
3. Connect the active probe from TX_TCLK of the DUT to the configured channel of the oscilloscope.
4. To test Pair A, connect the Differential Probe to P9 and configured channel of the oscilloscope.

5. To test Pair B, connect the Differential Probe to P10 and configured channel of the oscilloscope.
6. To test Pair C, connect the Differential Probe to P11 and configured channel of the oscilloscope.
7. To test Pair D, connect the Differential Probe to P12 and configured channel of the oscilloscope.

If you do not have access to TX_TCLK

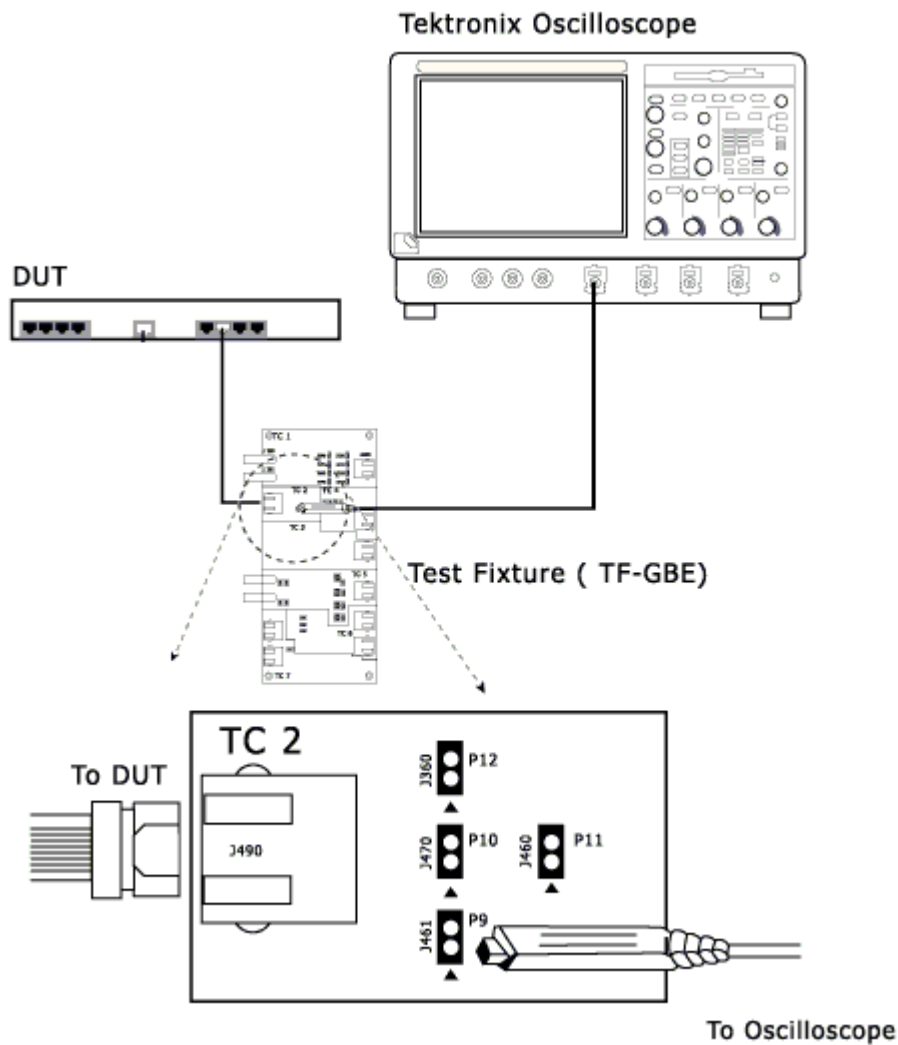

Figure 6-5: 1000BASE-T Connections for Jitter Master Filtered

- Set the DUT to generate Test Mode 2 signal.
- Connect the Ethernet cable to J490 and test port of the DUT.

- To test Pair A, connect the Differential Probe to P9 and configured channel of the oscilloscope.
- To test Pair B, connect the Differential Probe to P10 and configured channel of the oscilloscope.
- To test Pair C, connect the Differential Probe to P11 and configured channel of the oscilloscope.
- To test Pair D, connect the Differential Probe to P12 and configured channel of the oscilloscope.

Jitter Master Unfiltered If you have access to TX_TCLK

Use TC3 of the test fixture to calculate master clock jitter. Make the connections as shown by the following figure.

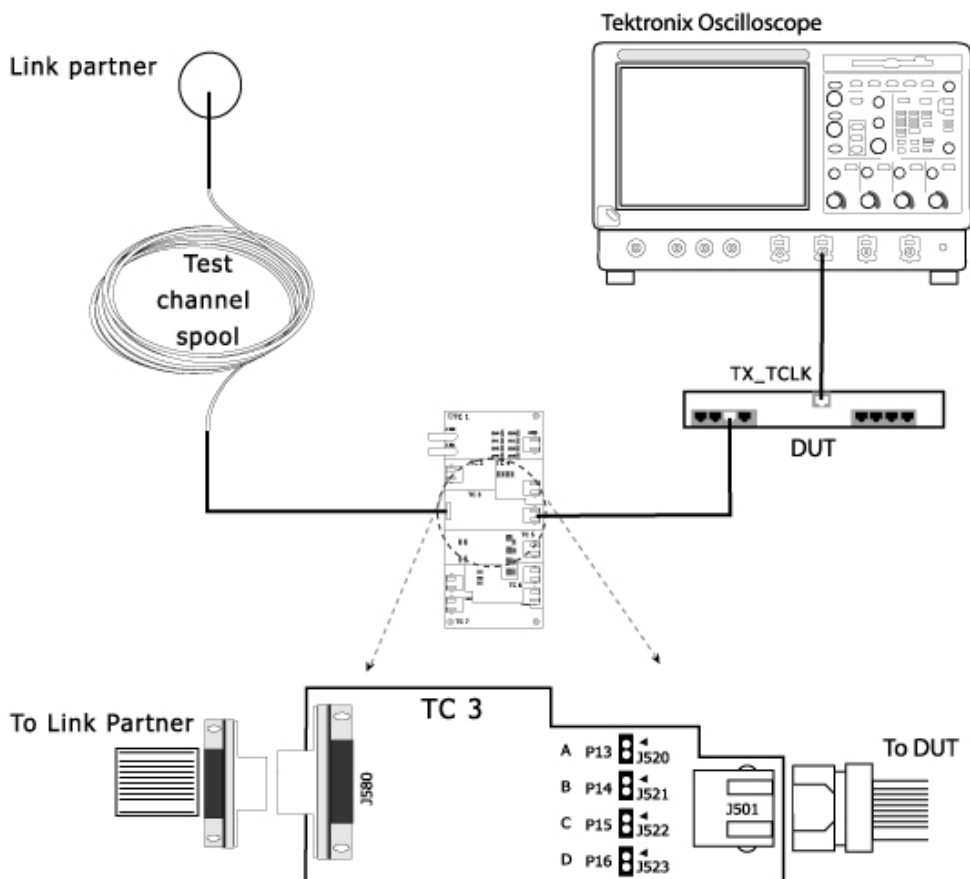

Figure 6-6: 1000BASE-T Connections for Jitter Master Unfiltered

1. Set the DUT to generate Test Mode 2 signal.

2. Connect the Ethernet cable to J501 and test port of the DUT.
3. Connect the Test Channel spool to J580 and Link partner.
4. Connect the active probe from TX_TCLK of the DUT to the configured channel of the oscilloscope.

If you do not have access to TX_TCLK

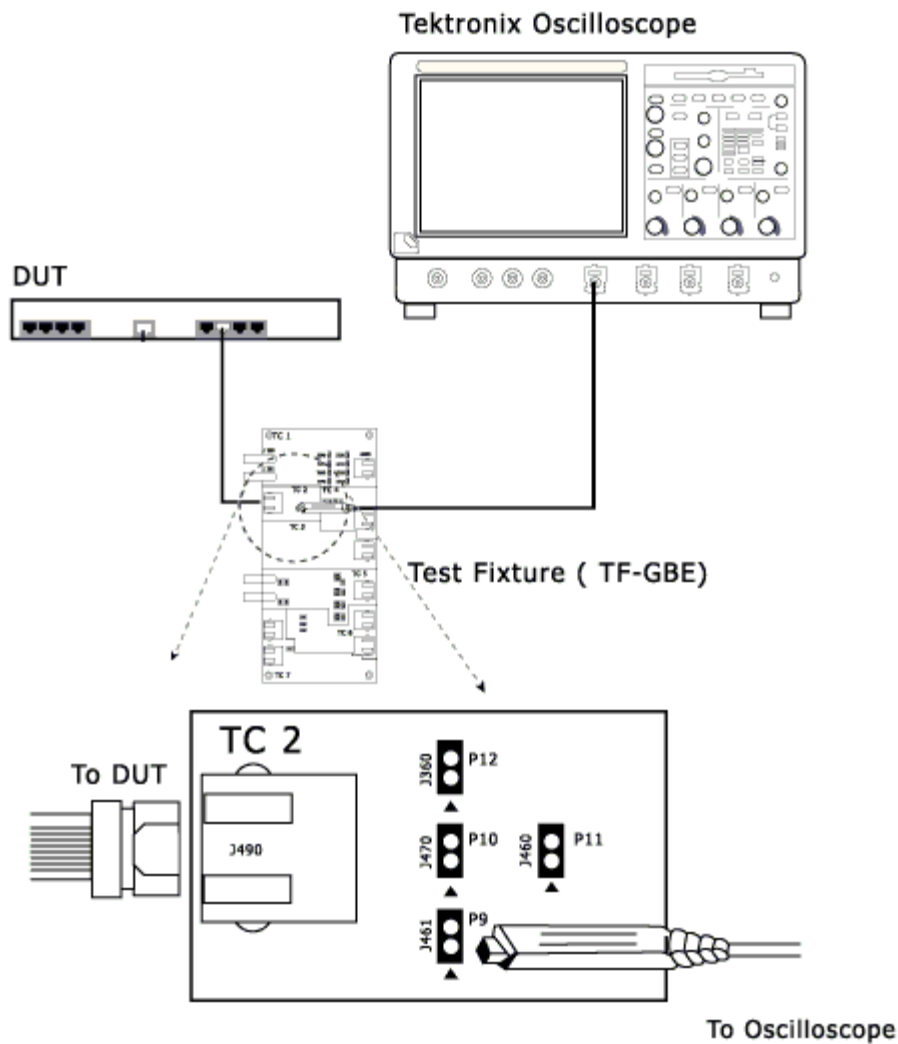

Figure 6-7: 1000BASE-T Connections for Jitter Master Unfiltered

- Set the DUT to generate Test Mode 2 signal.
- Connect the Ethernet cable to J490 and test port of the DUT.

- To test Pair A, connect the Differential Probe to P9 and configured channel of the oscilloscope.
- To test Pair B, connect the Differential Probe to P10 and configured channel of the oscilloscope.
- To test Pair C, connect the Differential Probe to P11 and configured channel of the oscilloscope.
- To test Pair D, connect the Differential Probe to P12 and configured channel of the oscilloscope.

Jitter Slave Filtered If you have access to TX_TCLK

Step 1

Use TC3 of the test fixture to calculate master and slave clock jitter. Make the connections as shown by the following figure.

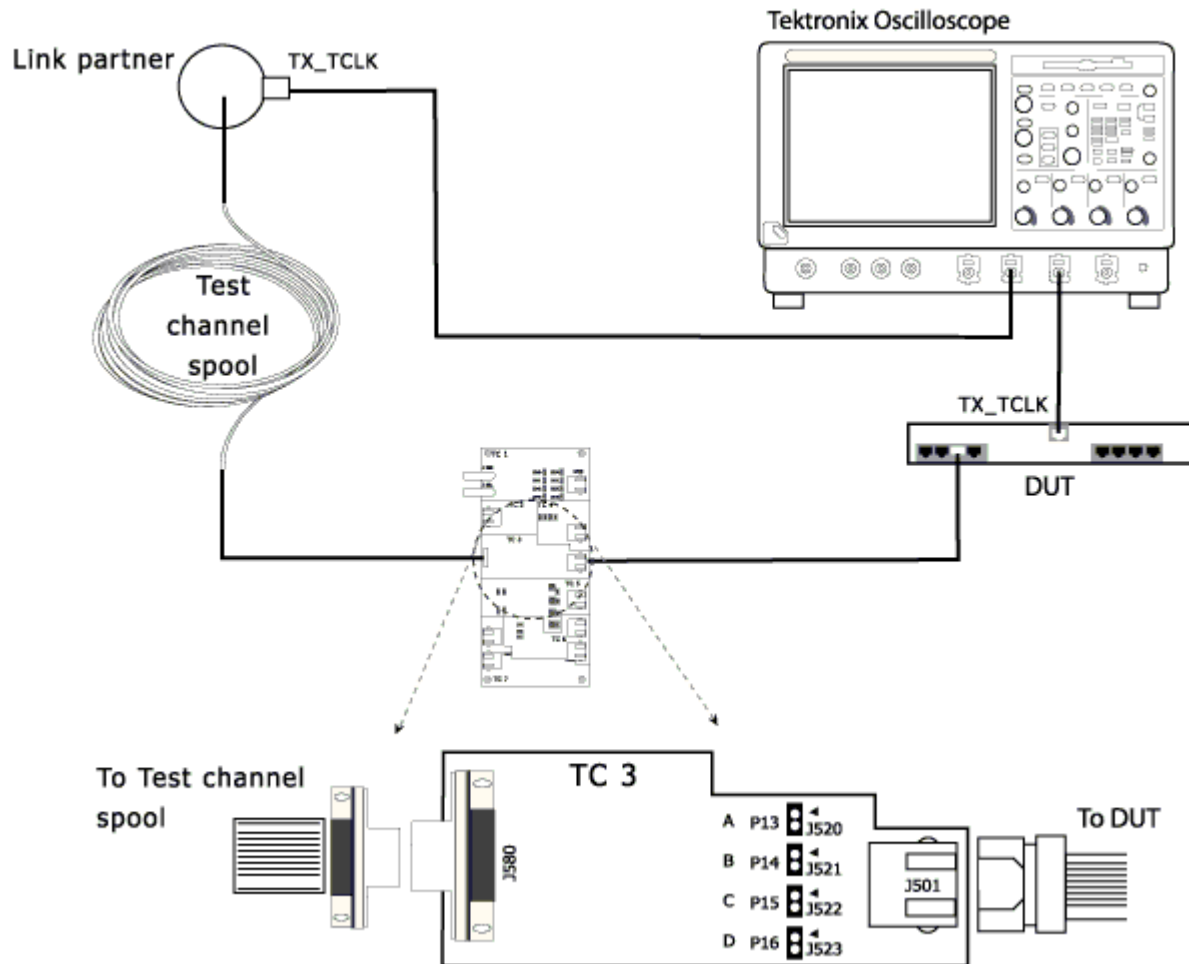

Figure 6-8: 1000BASE-T Step 1 Connections for Jitter Slave Filtered

1. Set the DUT in Normal mode as Slave.
2. Connect the Ethernet cable to J501 and test port of the DUT.
3. Connect the Test Channel spool to J580 and Link partner.
4. Connect the active probe from TX_TCLK of the DUT to the configured channel of the oscilloscope.

5. Connect the active probe from TX_TCLK of the Link Partner to the configured channel of the oscilloscope.

Step 2

Use TC2 of the test fixture to calculate data jitter with respect to slave clock. Make the connections as shown by the following figure.

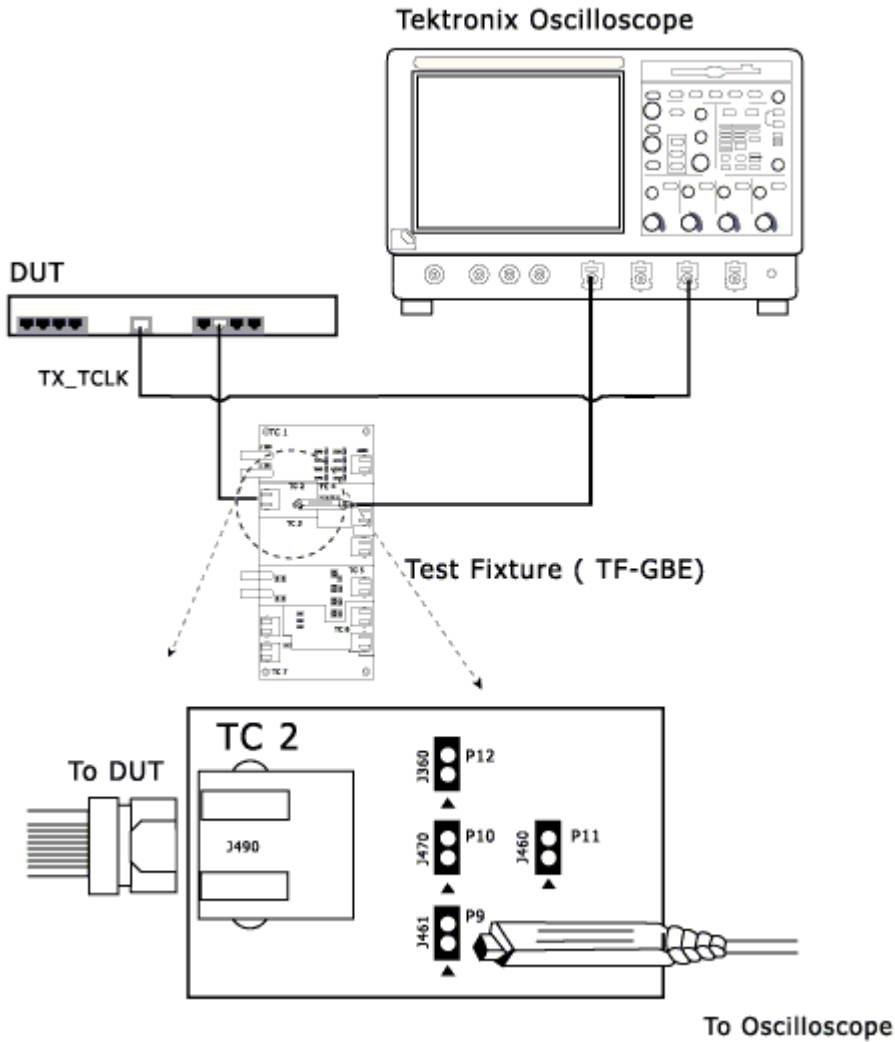

Figure 6-9: 1000BASE-T Step 2 Connections for Jitter Slave Filtered

1. Set the DUT to generate Test Mode 3 signal.
2. Connect the Ethernet cable to J490 and test port of the DUT.
3. Connect the active probe from TX_TCLK of the DUT to the configured channel of the oscilloscope.

4. To test Pair A, connect the Differential Probe to P9 and configured channel of the oscilloscope.
5. To test Pair B, connect the Differential Probe to P10 and configured channel of the oscilloscope.
6. To test Pair C, connect the Differential Probe to P11 and configured channel of the oscilloscope.
7. To test Pair D, connect the Differential Probe to P12 and configured channel of the oscilloscope.

If you do not have access to TX_TCLK

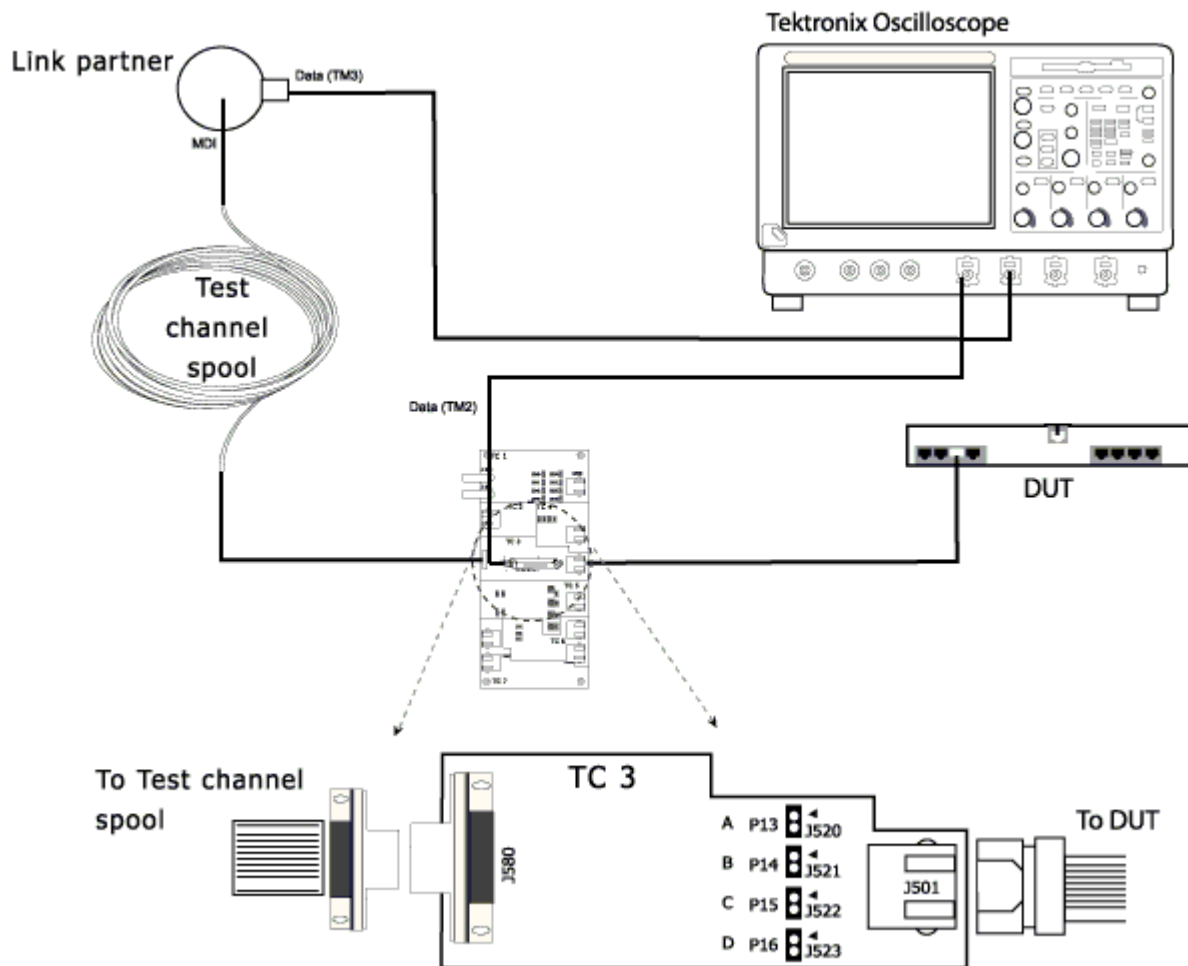

Figure 6-10: 1000BASE-T Connections for Jitter Slave Filtered

- Set the DUT in Normal mode as Master.

- Connect the Ethernet cable to J501 and test port of the DUT.
- Connect the Test Channel spool to J580 and Link partner.
- Set the Link partner to generate Test Mode 3 signal.
- Connect the active probe from Data (TM3) of the Link partner to the configured channel of the oscilloscope.
- To test Pair A, connect the Differential Probe to P13 and configured channel of the oscilloscope.
- To test Pair B, connect the Differential Probe to P14 and configured channel of the oscilloscope.
- To test Pair C, connect the Differential Probe to P15 and configured channel of the oscilloscope.
- To test Pair D, connect the Differential Probe to P16 and configured channel of the oscilloscope.

Jitter Slave Unfiltered **If you have access to TX_TCLK**

Use TC3 of the test fixture to calculate slave clock jitter. Make the connections as shown by the following figure.

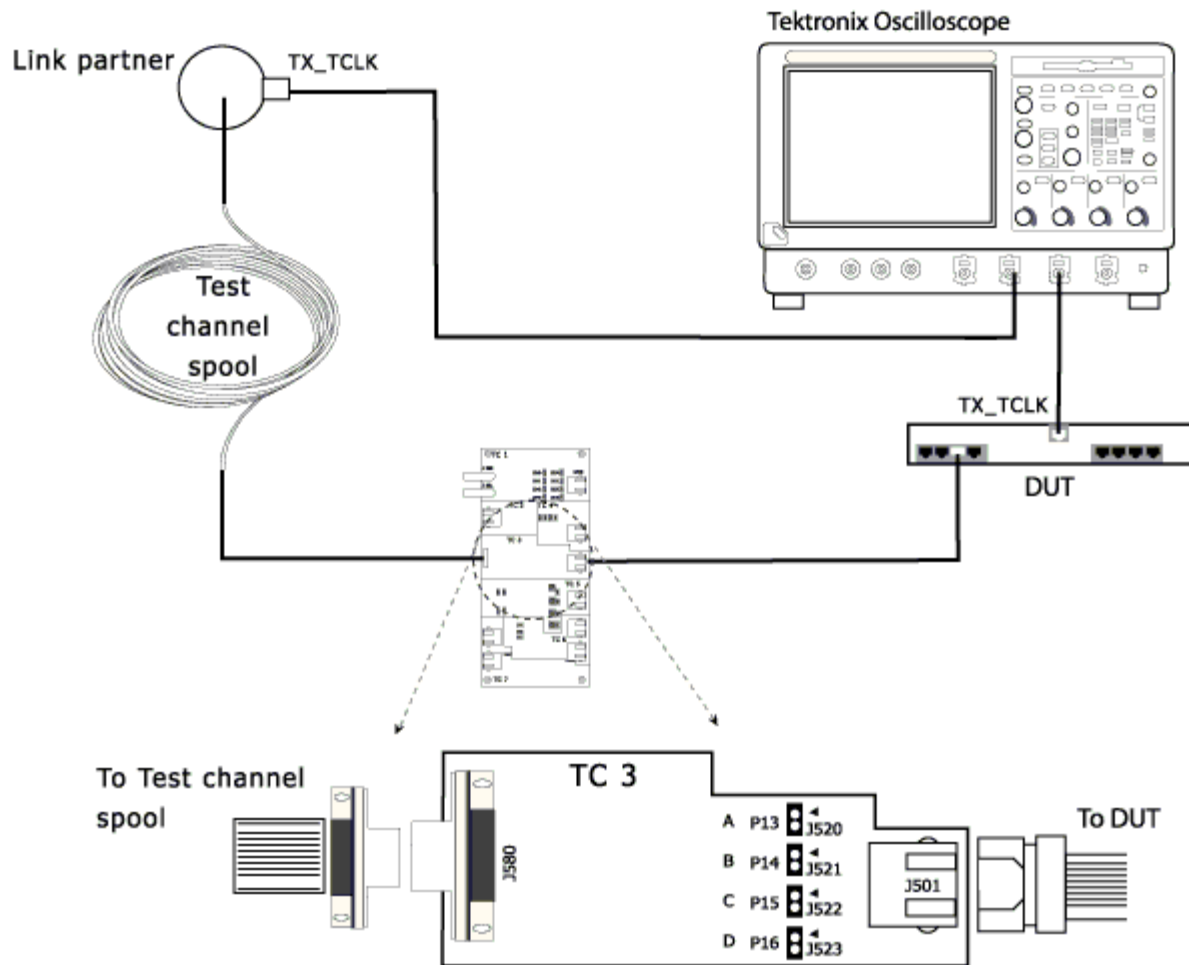

Figure 6-11: 1000BASE-T Connections for Jitter Slave Unfiltered

1. Set the DUT in Normal mode as Slave.
2. Connect the Ethernet cable to J501 and test port of the DUT.
3. Connect the Test Channel spool to J580 and Link partner.
4. Connect the active probe from TX_TCLK of the DUT to the configured channel of the oscilloscope.

5. Connect the active probe from TX_TCLK of the Link Partner to the configured channel of the oscilloscope.

If you do not have access to TX_TCLK

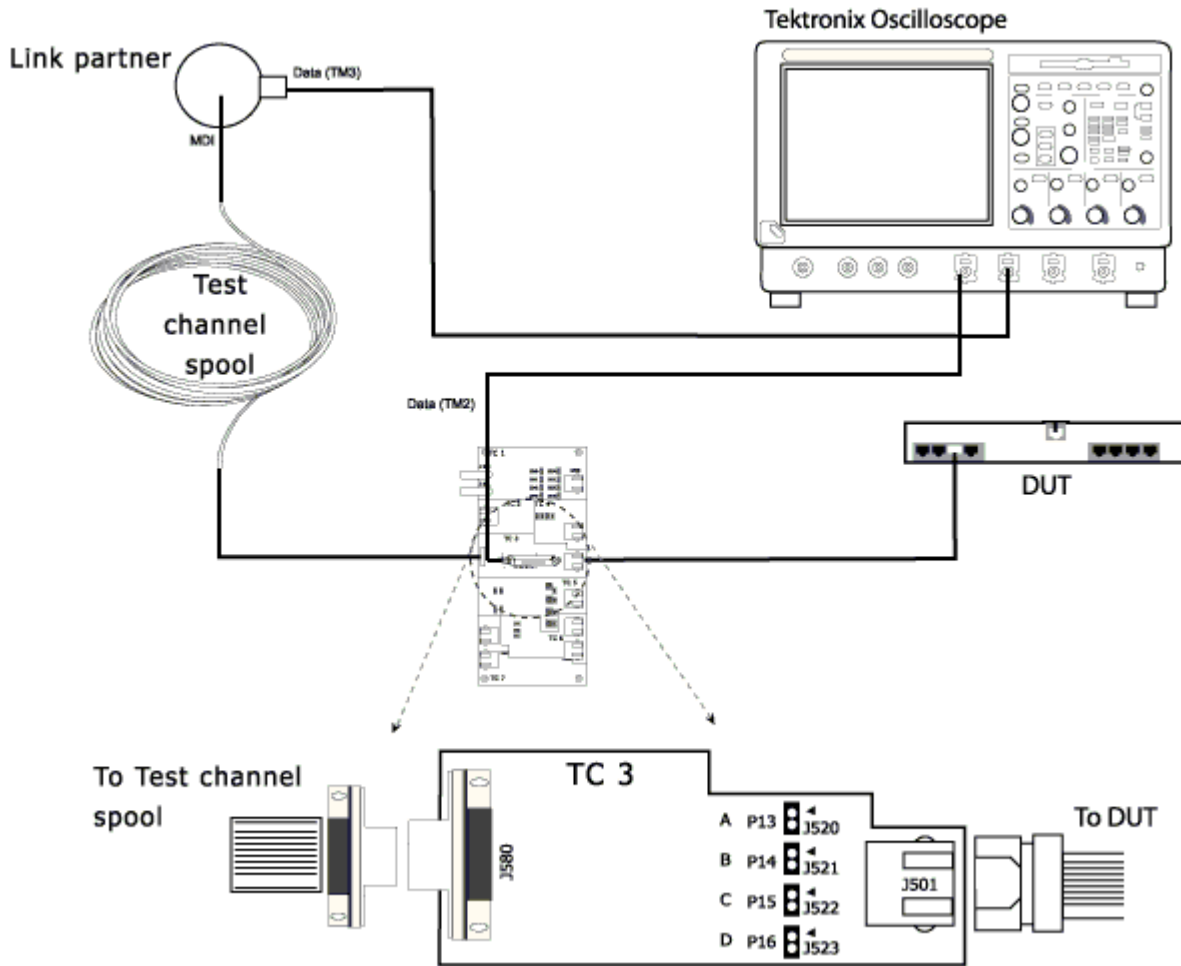

Figure 6-12: 1000BASE-T Connections for Jitter Slave Unfiltered

- Set the DUT in Normal mode as Master.
- Connect the Ethernet cable to J501 and test port of the DUT.
- Connect the Test Channel spool to J580 and Link partner.
- Set the Link partner to generate Test Mode 3 signal.
- Connect the active probe from Data (TM3) of the Link partner to the configured channel of the oscilloscope.

- To test Pair A, connect the Differential Probe to P13 and configured channel of the oscilloscope.
- To test Pair B, connect the Differential Probe to P14 and configured channel of the oscilloscope.
- To test Pair C, connect the Differential Probe to P15 and configured channel of the oscilloscope.
- To test Pair D, connect the Differential Probe to P16 and configured channel of the oscilloscope.

Return Loss Use TC1 of the test fixture for calibration.

Make the connections as shown by the following figure.

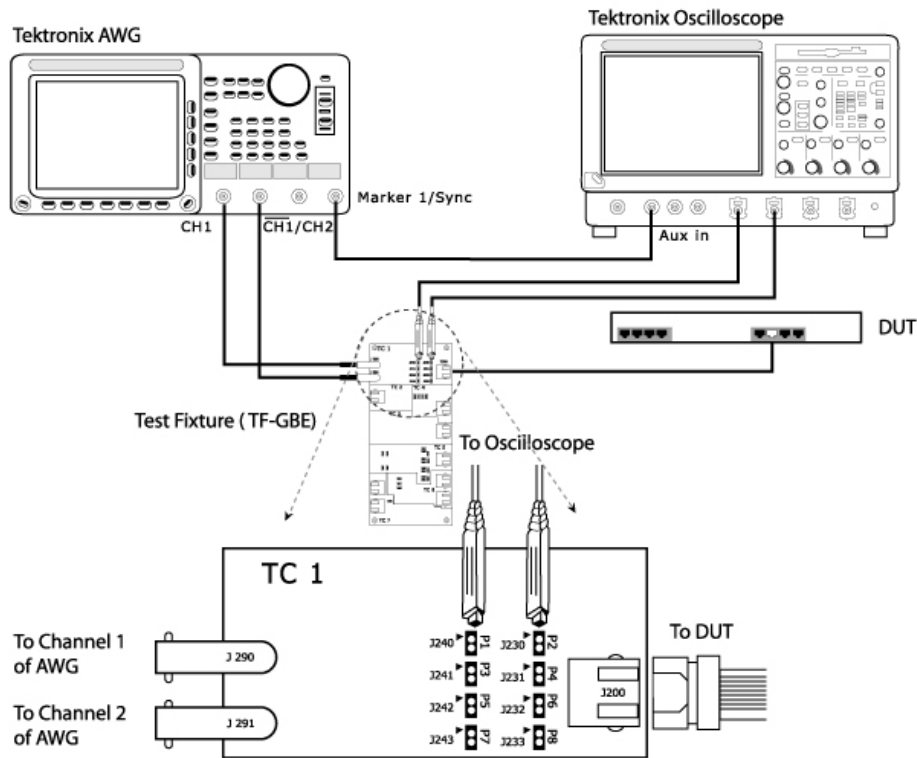

Figure 6-13: 1000BASE-T Connections for Return Loss

1. Set the DUT to generate Test Mode 4 signal.
2. Connect the Ethernet cable to J200 and test port of the DUT.

3. Connect a BNC Cable to AWG+ and Channel 1 of Arbitrary Waveform Generator.
4. Connect a BNC Cable to AWG- and Channel 2 ($\overline{\text{CH1}}$) of Arbitrary Waveform Generator.

Note: The AWG waveforms are available in *C:\TekApplications\TDSET3\AWGWaveforms*. Some of the AWG models do not support the .set file for automatic settings. Refer to the ReadMe.txt file for instructions to make those settings manually. **In particular, ensure that the AWG clock frequency is set to 250 MHz.** This file is available in the corresponding AWG waveform file folder. You can automate the AWG to transfer files and settings as described in *Automate AWG*.

5. To test Pair A, connect the Differential Probes to P1(J240) and P2(J230), and configured channels of the oscilloscope.
6. To test Pair B, connect the Differential Probe to P3(J241) and P4(J231), and configured channels of the oscilloscope.
7. To test Pair C, connect the Differential Probe to P5(J242) and P6(J232), and configured channels of the oscilloscope.
8. To test Pair D, connect the Differential Probe to P7(J243) and P8(J233), and configured channels of the oscilloscope.

Return Loss Calibration Use TC1 of the test fixture for calibration. Make the connections as shown by the following figure.

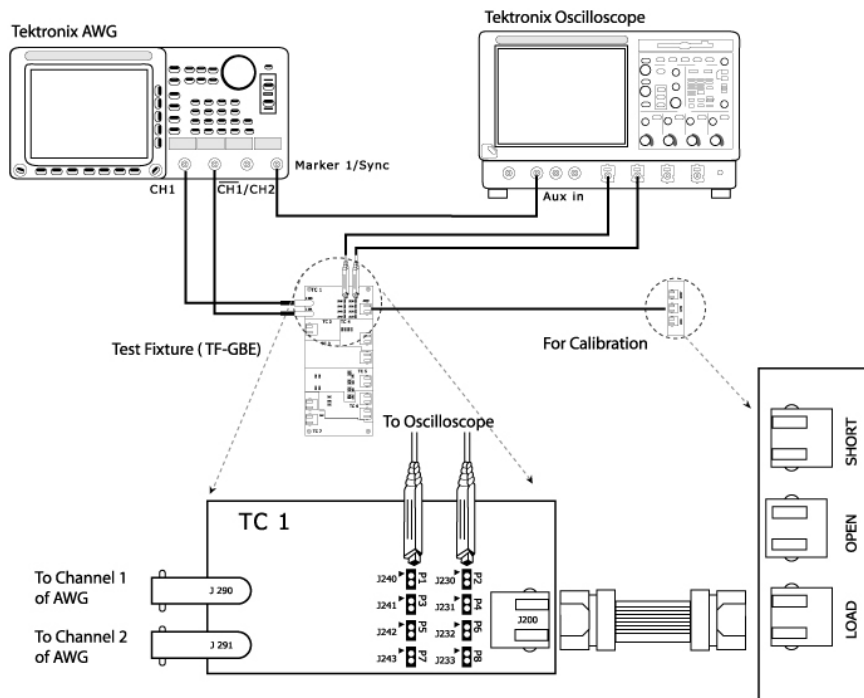

Figure 6-14: 1000BASE-T Connections for Return Loss Calibration

1. Connect the Ethernet cable to J200 and test port of the DUT.
2. Connect a BNC Cable to AWG+ and Channel 1 of Arbitrary Waveform Generator.
3. Connect a BNC Cable to AWG- and Channel 2 ($\overline{\text{CH1}}$) of Arbitrary Waveform Generator.

*Note: The AWG waveforms are available in
C:\TekApplications\TDSET3\AWGWaveforms.*

4. To test Pair A, connect the Differential Probes to P1(J240) and P2(J230), and configured channels of the oscilloscope.
5. To test Pair B, connect the Differential Probe to P3(J241) and P4(J231), and configured channels of the oscilloscope.

6. To test Pair C, connect the Differential Probe to P5(J242) and P6(J232), and configured channels of the oscilloscope.
7. To test Pair D, connect the Differential Probe to P7(J243) and P8(J233), and configured channels of the oscilloscope.
8. Connect CAT5 cable to J200 of TC1 and J702 for OPEN calibration.
9. Connect CAT5 cable to J200 of TC1 and J703 for SHORT calibration.
10. Connect CAT5 cable to J200 of TC1 and J704 for LOAD calibration.

CM Voltage Use TC4 of the test fixture for this test. Make the connections as shown by the following figure.

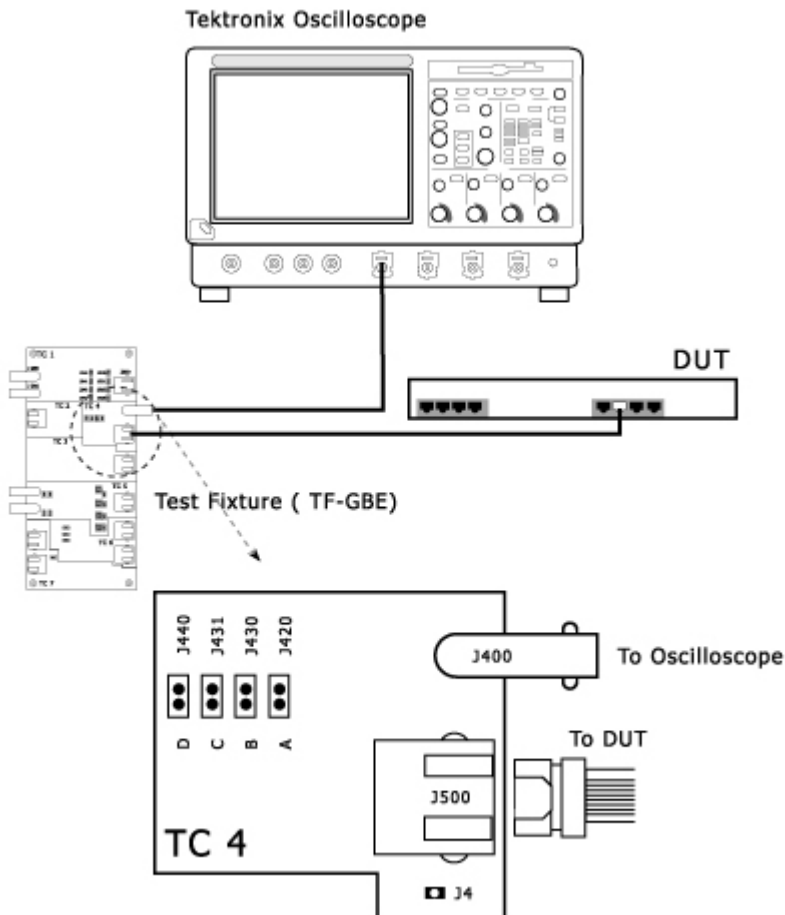

Figure 6-15: 1000BASE-T Connections for CM Voltage

1. Set the DUT to generate Test Mode 4 signal.

2. Connect the Ethernet cable to J500 and test port of the DUT.
3. Connect a BNC Cable to J400 and configured channel of the oscilloscope.
4. To test Pair A, short J420 using a jumper.
5. To test Pair B, short J430 using a jumper.
6. To test Pair C, short J431 using a jumper.
7. To test Pair D, short J440 using a jumper.

100BASE-TX Connections

All Tests except Return Loss Template, Differential Output Voltage, Amplitude Symmetry, Rise Time, Fall Time, Rise/Fall Time Symmetry, Waveform Overshoot, Jitter, Duty Cycle Distortion

Use TC2 of the test fixture for this test. Make the connections as shown by the following figure.

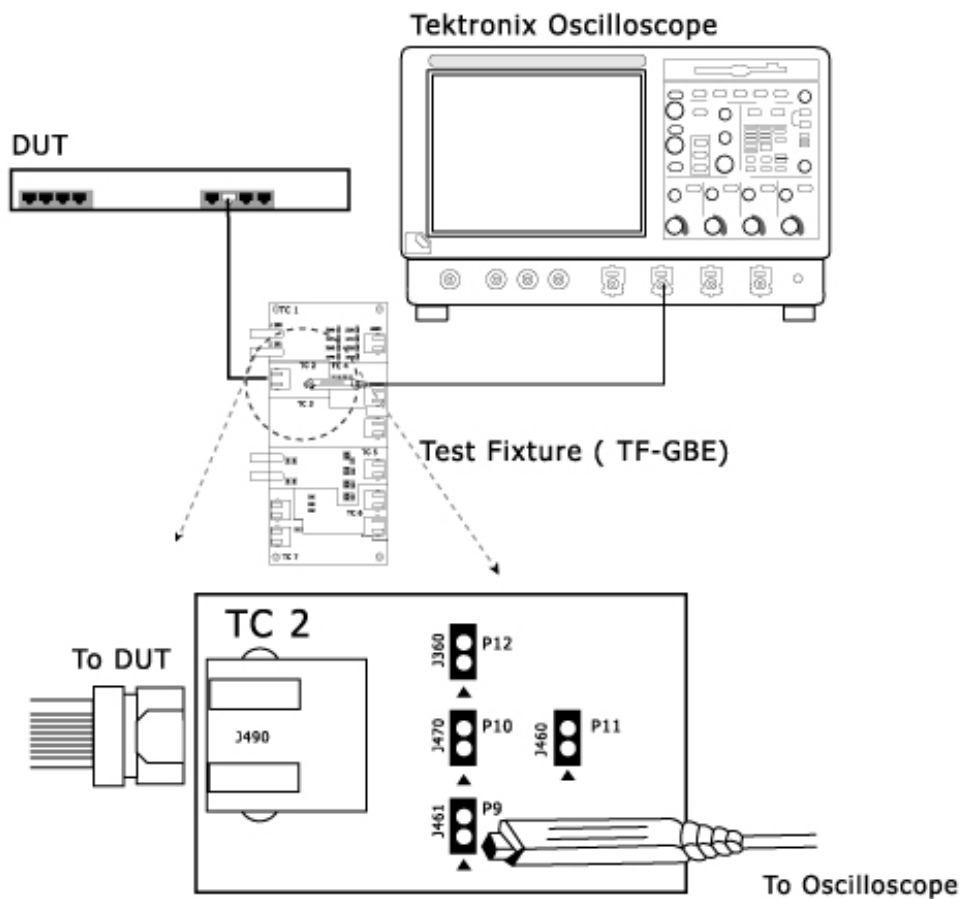

Figure 6-16: All 100BASE-TX Connections except Return Loss

1. Set the DUT to transmit scrambled idles.
2. Connect the Ethernet cable to J490 and test port of the DUT.
3. Connect the Differential Probe to P9 and configured channel of the oscilloscope.

Return Loss Use TC1 of the test fixture for this test. Make the connections as shown by the following figure.

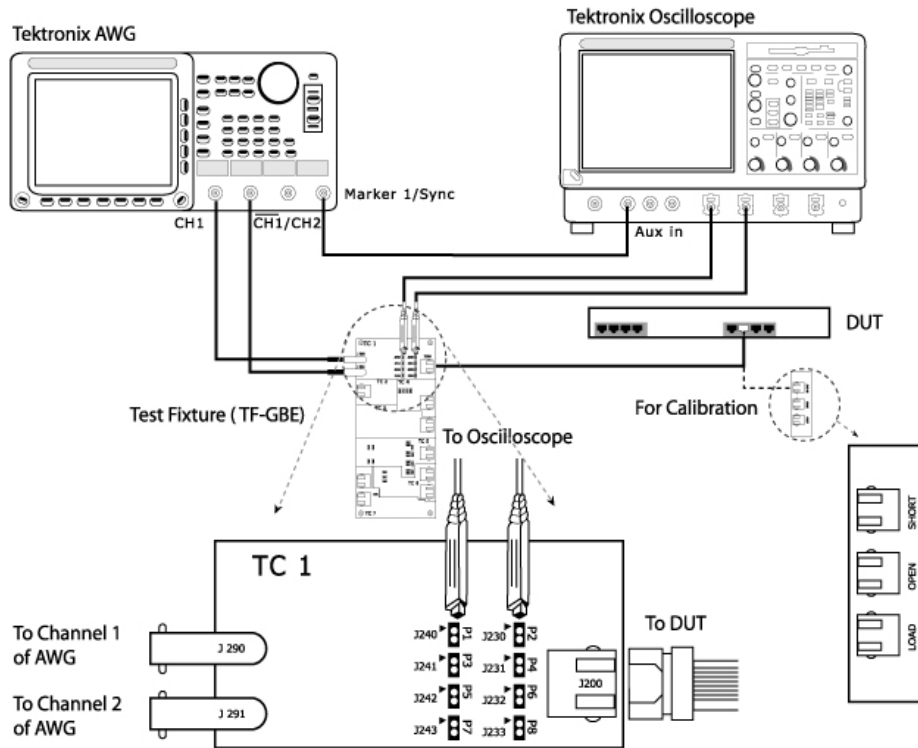

Figure 6-17: 100BASE-TX Connections for Return Loss

1. Set the DUT to generate scrambled idles.
2. Connect the Ethernet cable to J200 and test port of the DUT.
3. Connect a BNC Cable to AWG+ and Channel 1 of Arbitrary Waveform Generator.
4. Connect a BNC Cable to AWG- and Channel 2 ($\overline{\text{CH1}}$) of Arbitrary Waveform Generator.

***Note:** The AWG waveforms are available in C:\TekApplications\TDSET3\AWGWaveforms. Some of the AWG models do not support the .set file for automatic settings. Refer to the ReadMe.txt file for instructions to make those settings manually. **In particular, ensure that the AWG clock frequency is set to 250 MHz.** This file is available in the corresponding AWG waveform file folder. You can automate the AWG to transfer files and settings as described in Automate AWG.*

5. To test Transmitter, connect the Differential Probes to P1(J240) and P2(J230), and configured channels of the oscilloscope.
6. To test Receiver, connect the Differential Probe to P3(J241) and P4(J231), and configured channels of the oscilloscope.

Return Loss Calibration Use TC1 of the test fixture for this test. Make the connections as shown by the following figure.

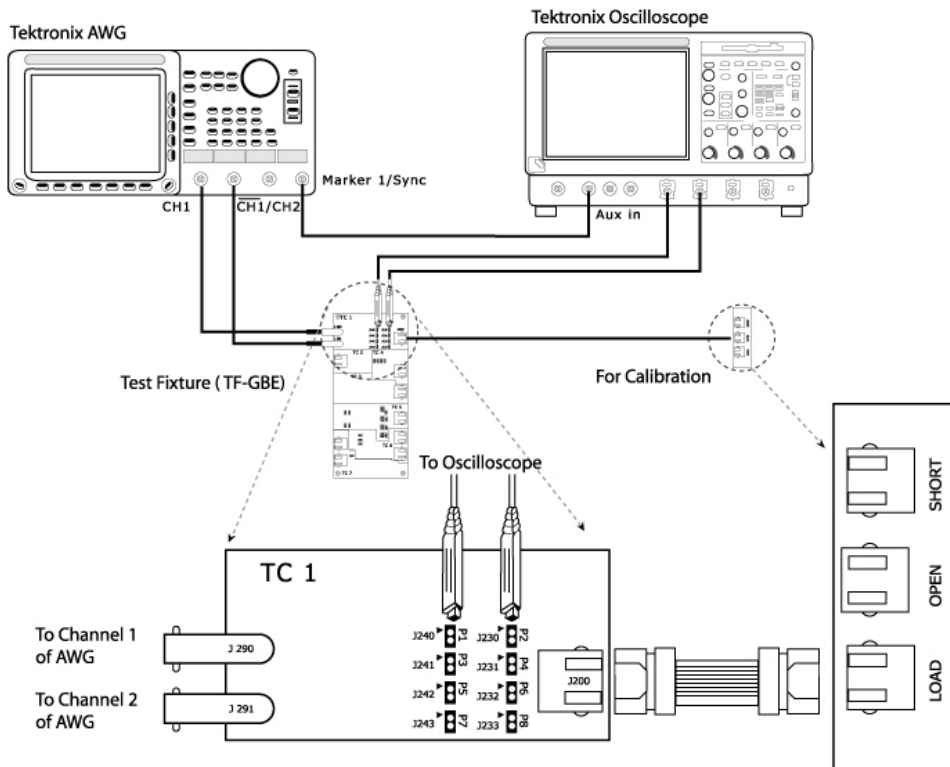

Figure 6-18: 100BASE-TX Connections for Return Loss Calibration

1. Connect the Ethernet cable to J200 and test port of the DUT.
2. Connect a BNC Cable to AWG+ and Channel 1 of Arbitrary Waveform Generator.
3. Connect a BNC Cable to AWG- and Channel 2 ($\overline{\text{CH1}}$) of Arbitrary Waveform Generator.

Note: The AWG waveforms are available in *C:\TekApplications\TDSET3\AWGWaveforms*.

4. To test Transmitter, connect the Differential Probes to P1(J240) and P2(J230), and configured channels of the oscilloscope.
5. To test Receiver, connect the Differential Probe to P3(J241) and P4(J231), and configured channels of the oscilloscope.
6. Connect CAT5 cable to J200 of TC1 and J702 for OPEN calibration.
7. Connect CAT5 cable to J200 of TC1 and J703 for SHORT calibration.
8. Connect CAT5 cable to J200 of TC1 and J704 for LOAD calibration.

10BASE-T Connections

Link Pulse Use TC6 of the test fixture for this test without twisted-pair model and use TC7 of the test fixture for this test with twisted-pair model.

Without Twisted-pair model

Make the connections as shown by the following figure.

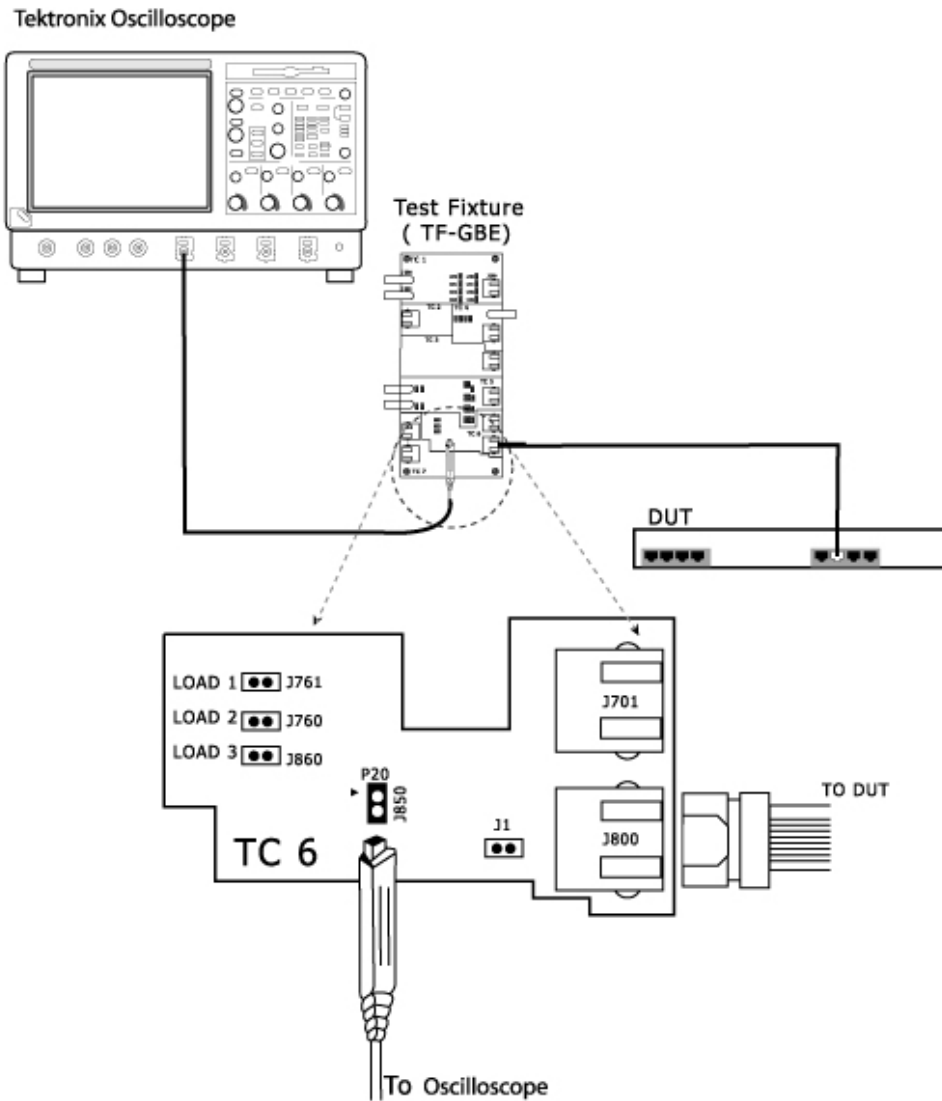

Figure 6-19: 10BASE-T Connections for Link Pulse without Twisted-pair model

1. Set the DUT to generate link pulse signal.
2. Connect the Ethernet Cable to J800 and test port of the DUT.
3. Connect the differential probe to P20 and configured channel of the oscilloscope.

- Using the jumpers, short the LOAD1, LOAD2 or LOAD3 (100 Ohm). Ensure that the jumper you have short and the LOAD you have selected in the application are the same.

With Twisted-pair model

Make the connections as shown by the following figure.

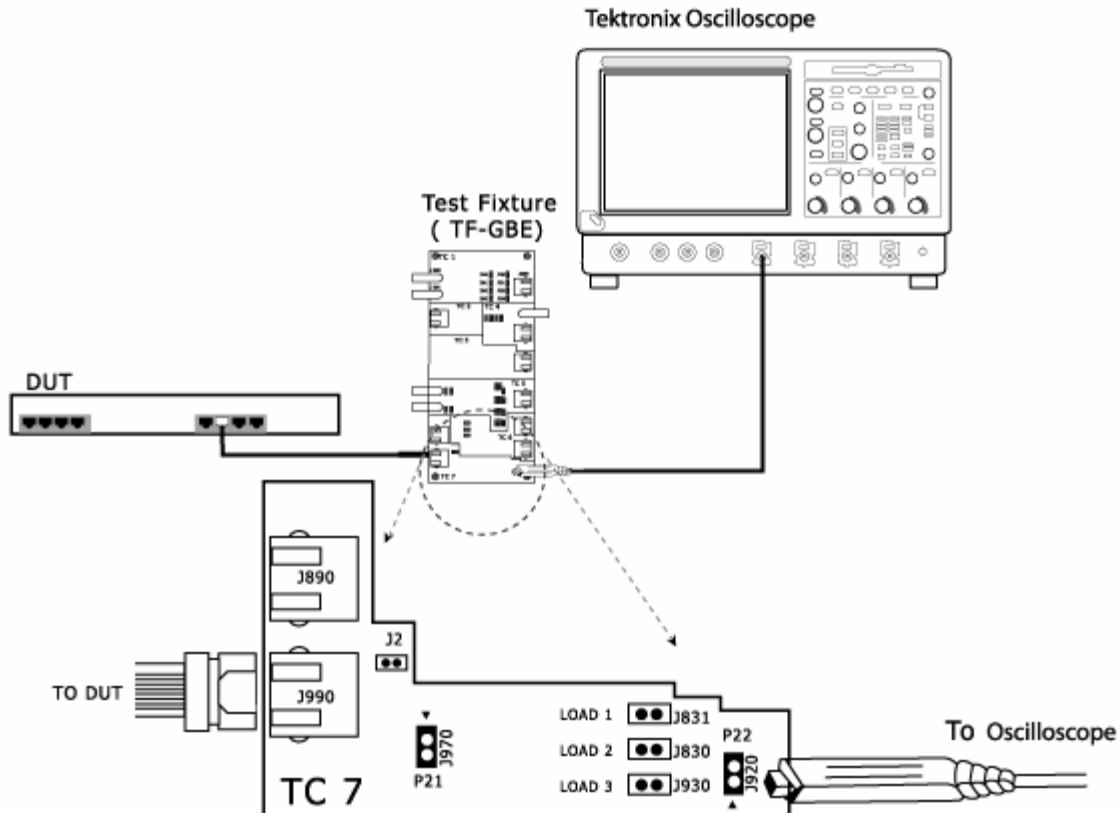

Figure 6-20: 10BASE-T Connections for Link Pulse with Twisted-pair model

- Set the DUT to generate link pulse signal.
- Connect the Ethernet cable to J990 and the test port of the DUT.
- Connect the differential probe to P22 and the configured channel of the oscilloscope.
- Using the jumpers, short the LOAD1, LOAD2 or LOAD3 (100 Ohm). Ensure that the jumper you have short and the LOAD you have selected in the application are the same.

MAU Use TC7 of the test fixture for this test. Make the connections as shown by the following figure.

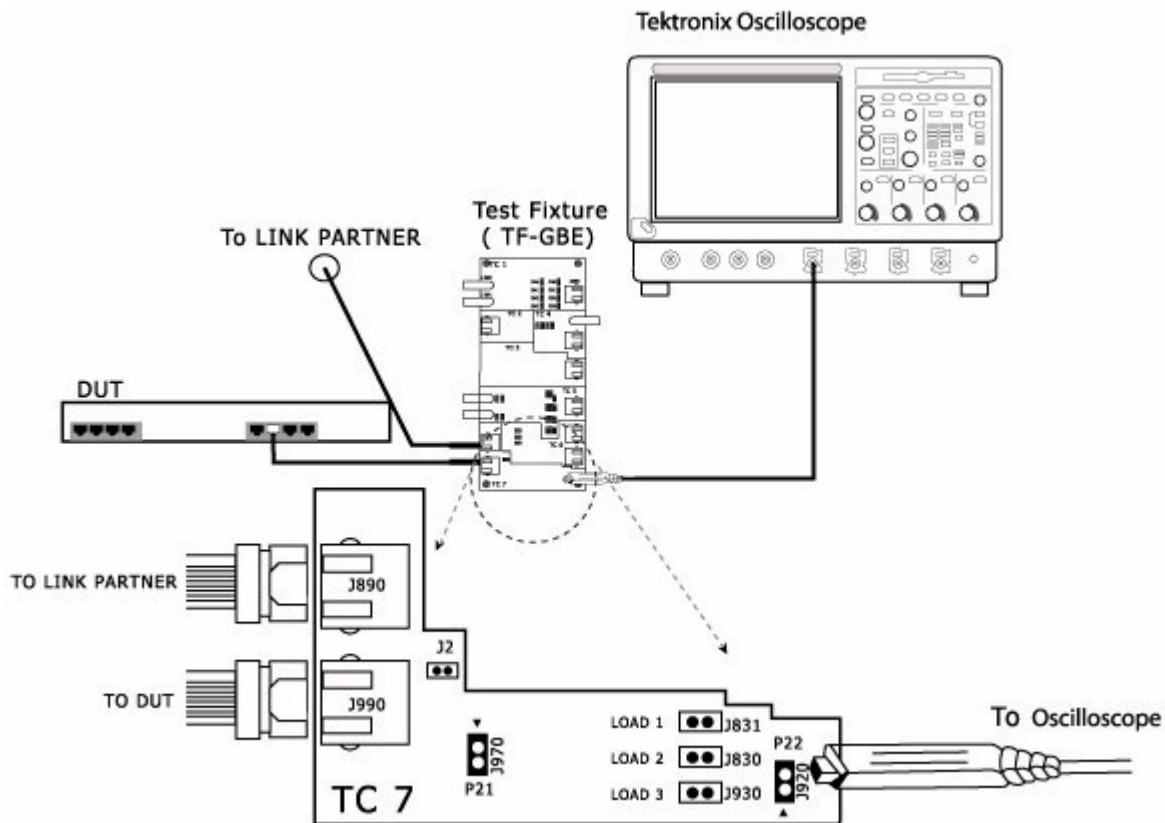

Figure 6-21: 10BASE-T Connections for MAU

1. Set the DUT to generate pseudo-random sequence signal.
2. Connect the Ethernet Cable to J990 and test port of the DUT.
3. If you have a Link Partner, do the following:
 - Connect the Ethernet Cable to J890 and link partner.

If you do not have a link partner, short J2 using a jumper. If J2 is not present, go to the next step.

4. Connect the differential probe to P22 and configured channel of the oscilloscope.
5. Short LOAD3 (100 Ohm) using a jumper.

TP_IDL Use TC6 of the test fixture for this test without Twisted-pair model and use TC7 of the test fixture for this test with Twisted-pair model.

Without Twisted-pair model

Make the connections as shown by the following figure.

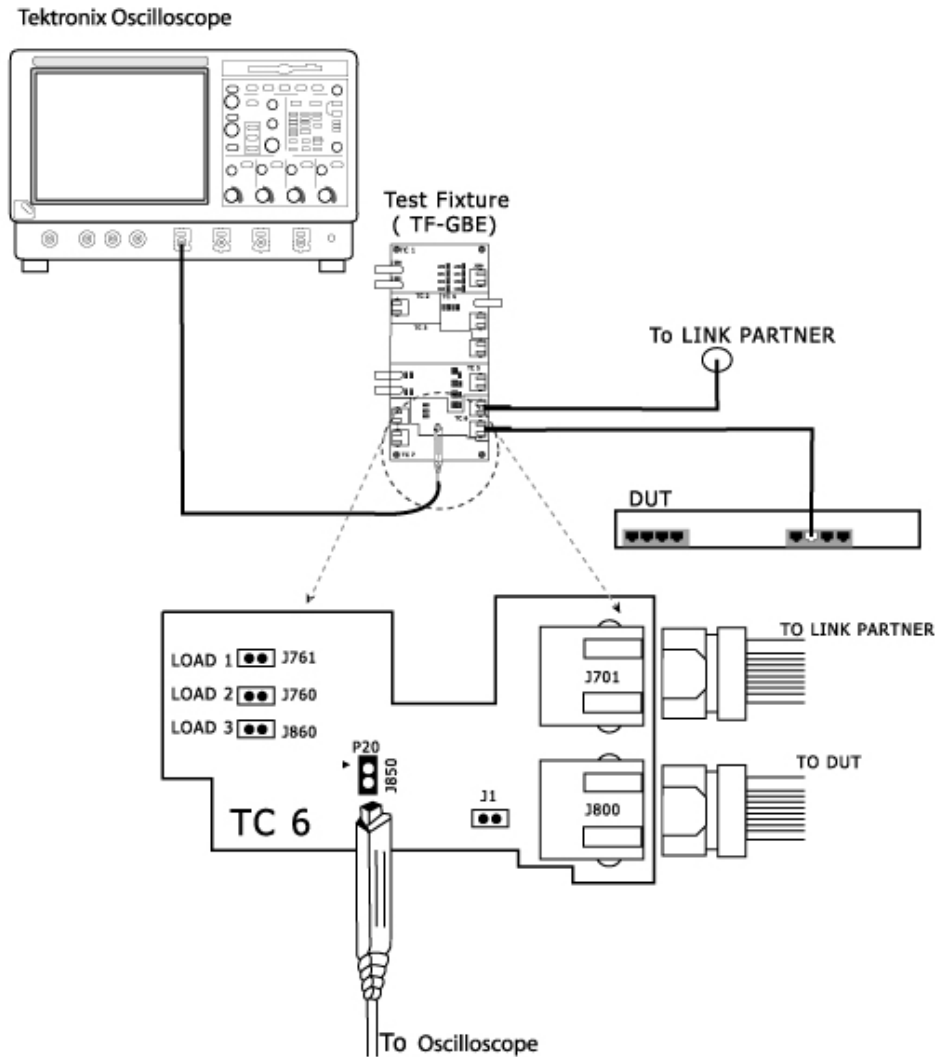

Figure 6-22: 10BASE-T Connections for TP_IDL without Twisted-pair model

1. Set the DUT to generate pseudo-random sequence signal.
2. Connect the Ethernet cable to J800 and test port of the DUT.

3. If you have a Link Partner, do the following:
 - Connect the Ethernet cable to J701 and link partner.

If you do not have a link partner, short J1 using a jumper. If J1 is not present, go to the next step.

4. Connect the Differential Probe to P20 and configured channel of the oscilloscope.
5. Using the jumpers, short the LOAD1, LOAD2 or LOAD3 (100 Ohm). Ensure that the jumper you have short and the LOAD you have selected in the application are the same.

With Twisted-pair model

Make the connections as shown by the following figure.

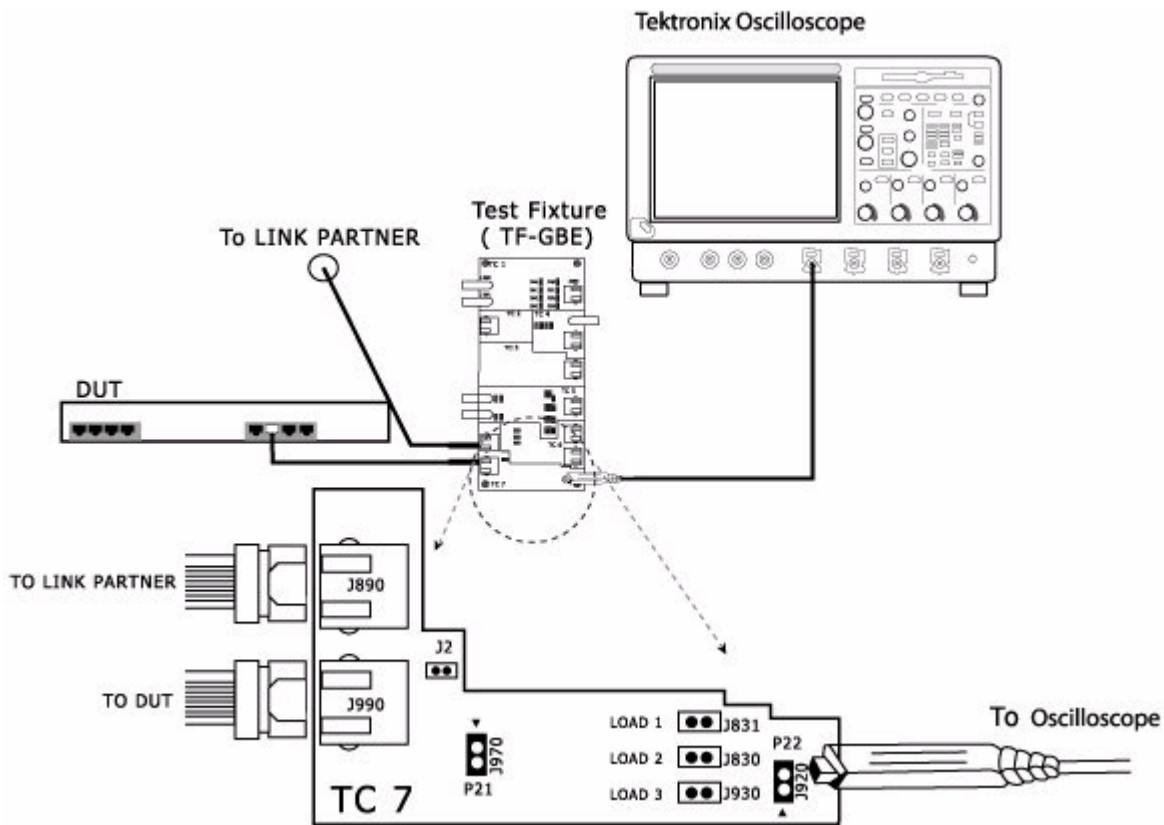

Figure 6-23: 10BASE-T Connections for TP_IDL with Twisted-pair model

1. Set the DUT to generate pseudo-random sequence signal.
2. Connect the Ethernet cable to J990 and test port of the DUT.

3. If you have a Link Partner, do the following:

- Connect the Ethernet cable to J890 and Link Partner.

If you do not have a link partner, short J2 using a jumper. If J2 is not present, go to the next step.

4. Connect the Differential Probe to P22 and configured channel of the oscilloscope.

5. Using the jumpers, short the LOAD1, LOAD2 or LOAD3 (100 Ohm). Ensure that the jumper you have short and the LOAD you have selected in the application are the same.

Jitter with cable Use TC7 of the test fixture for this test. Make the connections as shown by the following figure.

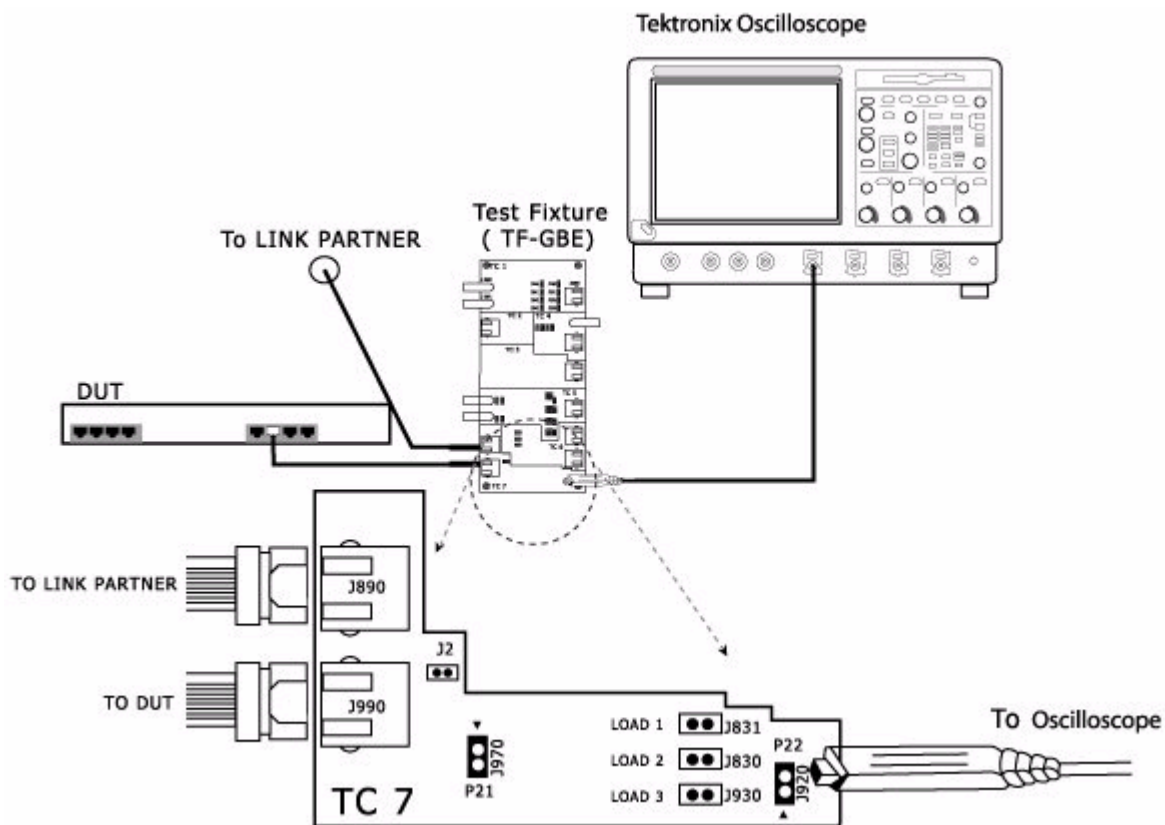

Figure 6-24: 10BASE-T Connections for Jitter with cable

1. Set the DUT to generate pseudo-random sequence signal.
2. Connect the Ethernet cable to J990 and test port of the DUT.

3. If you have a Link Partner, do the following:

- Connect the Ethernet Cable to J890 and Link Partner.

If you do not have a link partner, short J2 using a jumper. If J2 is not present, go to the next step.

4. Connect the Differential Probe to P22 and configured channel of the oscilloscope.
5. Short LOAD3 (100 Ohm) using a jumper.

Jitter without cable Use TC6 of the test fixture for this test. Make the connections as shown by the following figure.

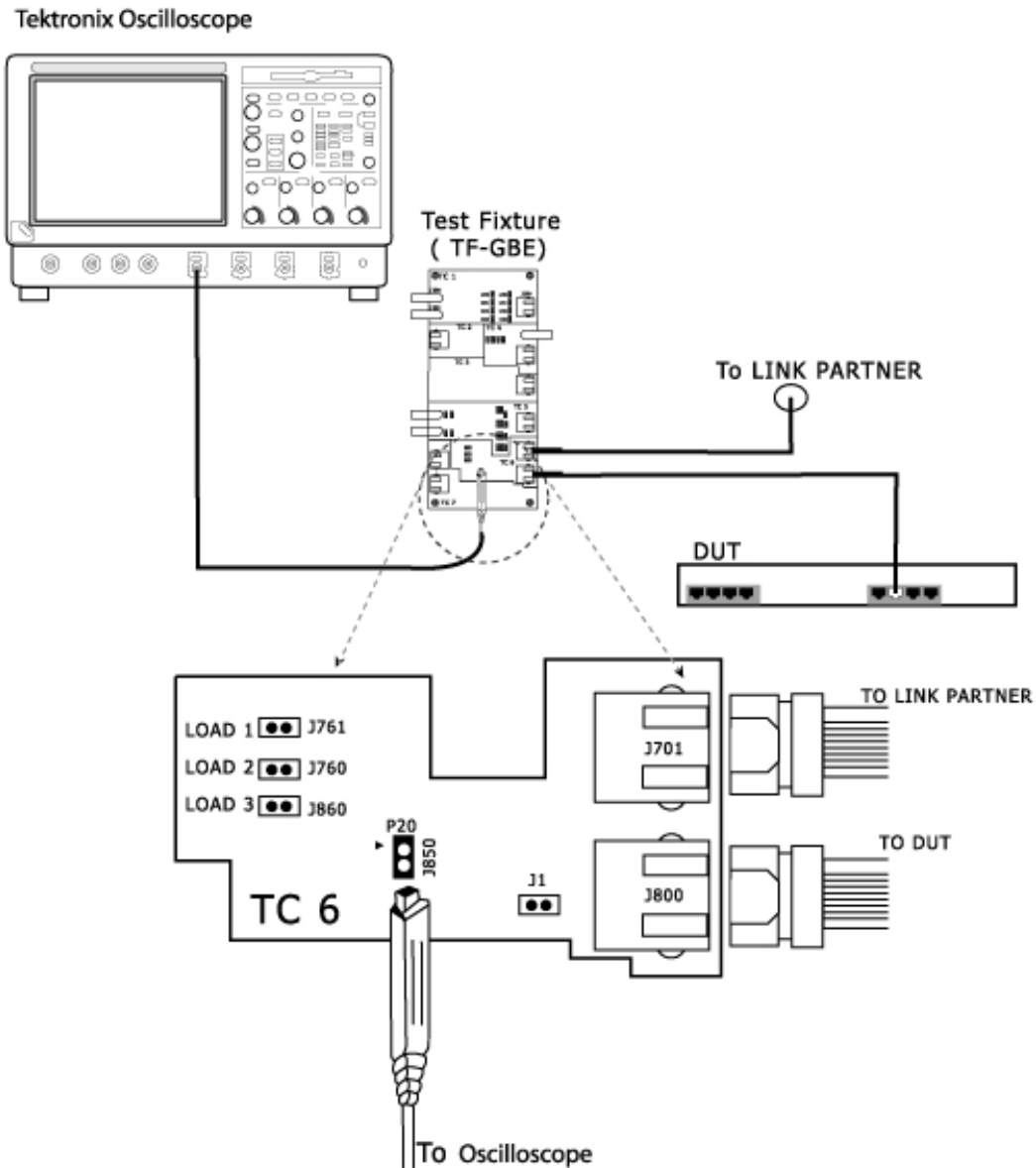

Figure 6-25: 10BASE-T Connections for Jitter without cable

1. Set the DUT to generate pseudo-random sequence signal.
2. Connect the Ethernet cable to J800 and test port of the DUT.
3. If you have a Link Partner, do the following:

- Connect the Ethernet Cable to J701 and Link Partner.

If you do not have a link partner, short J1 using a jumper. If J1 is not present, go to the next step.

4. Connect the Differential Probe to P20 and configured channel of the oscilloscope.
5. Short LOAD3 (100 Ohm) using a jumper.

Differential Voltage Use TC6 of the test fixture for this test. Make the connections as shown by the following figure.

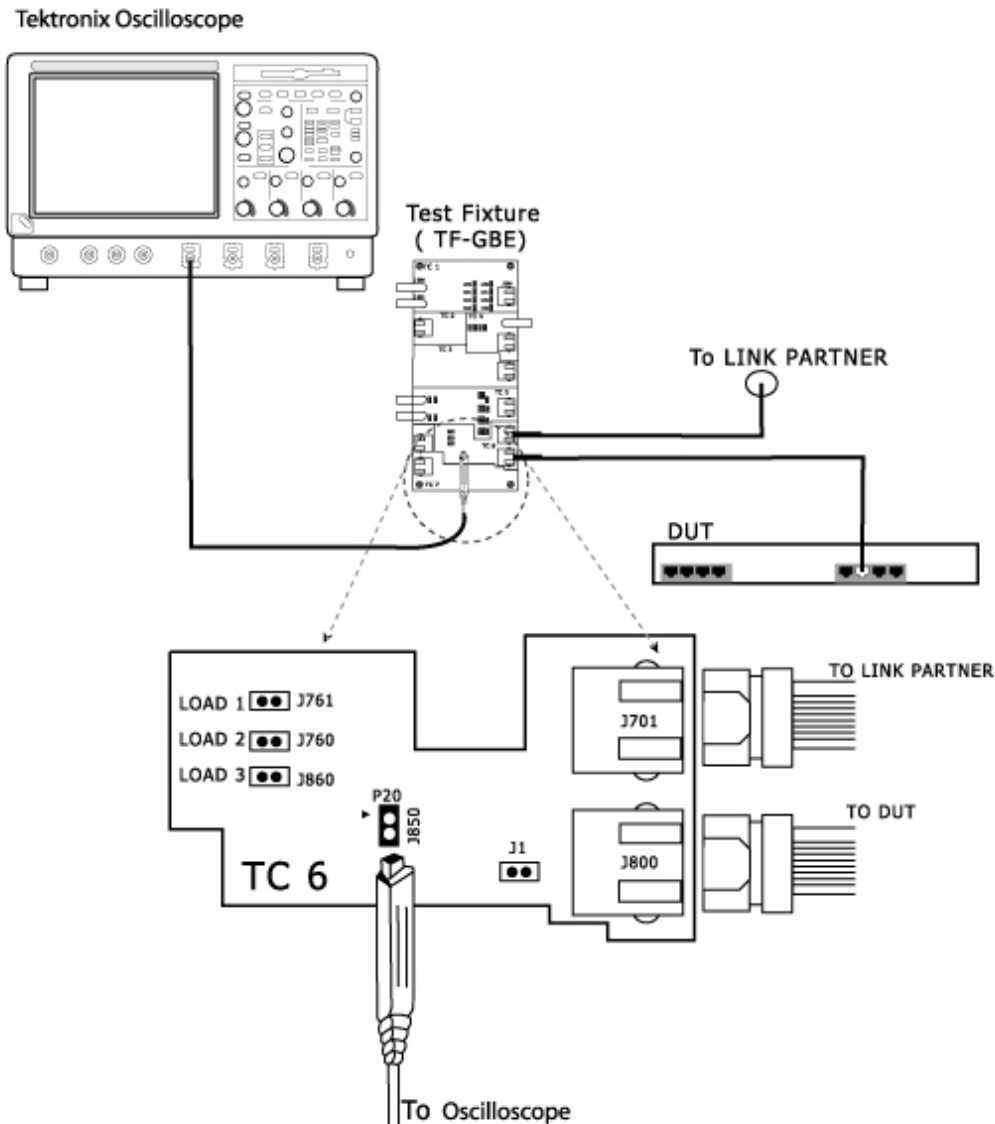

Figure 6-26: 10BASE-T Connections for Differential Voltage

1. Set the DUT to generate pseudo-random sequence signal.
2. Connect the Ethernet cable to J800 and test port of the DUT.
3. If you have a Link Partner, do the following:
 - Connect the Ethernet Cable to J701 and Link Partner.

If you do not have a link partner, short J1 using a jumper. If J1 is not present, go to the next step.

4. Connect the Differential Probe to P20 and configured channel of the oscilloscope.
5. Short LOAD3 (100 Ohm) using a jumper.

Harmonic Use TC6 of the test fixture for this test. Make the connections as shown by the following figure.

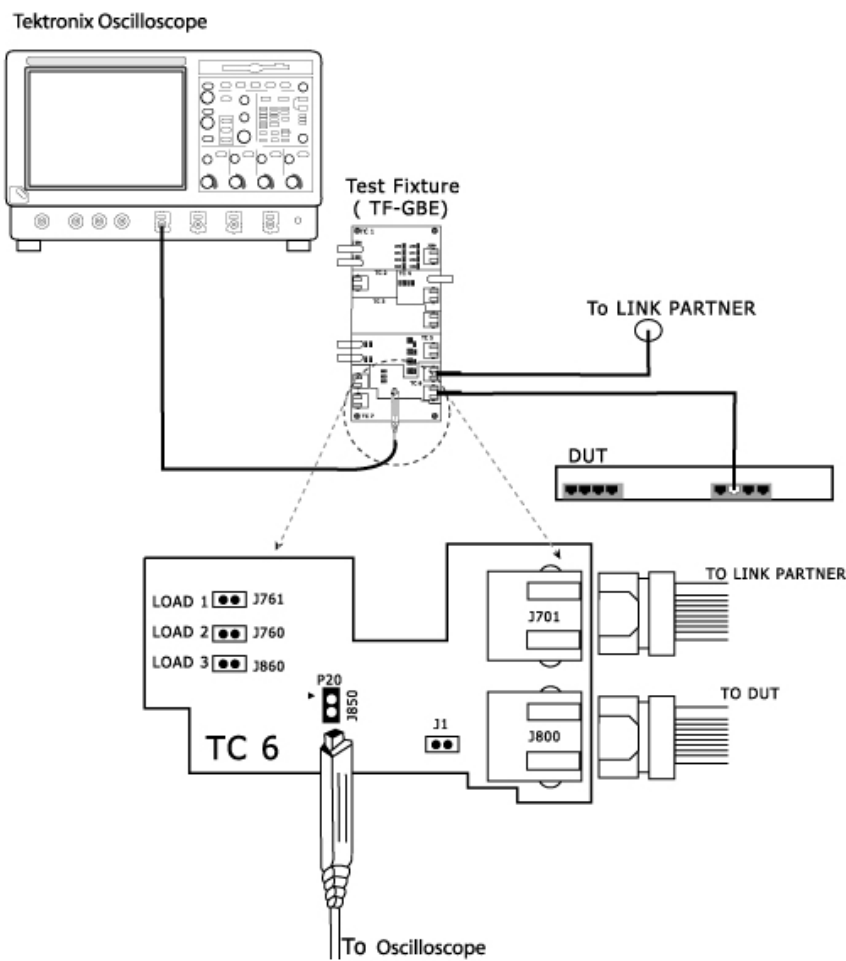

Figure 6-27: 10BASE-T Connections for Harmonic

1. Set the DUT to generate all-one or all-zero sequence signal.
2. Connect the Ethernet cable to J800 and test port of the DUT.
3. If you have a Link Partner, do the following:

- Connect the Ethernet Cable to J701 and Link Partner.

If you do not have a link partner, short J1 using a jumper. If J1 is not present, go to the next step.

4. Connect the Differential Probe to P20 and configured channel of the oscilloscope.
5. Short LOAD3 (100 Ohm) using a jumper.

Return Loss Use TC1 of the test fixture for this test. Make the connections as shown by the following figure.

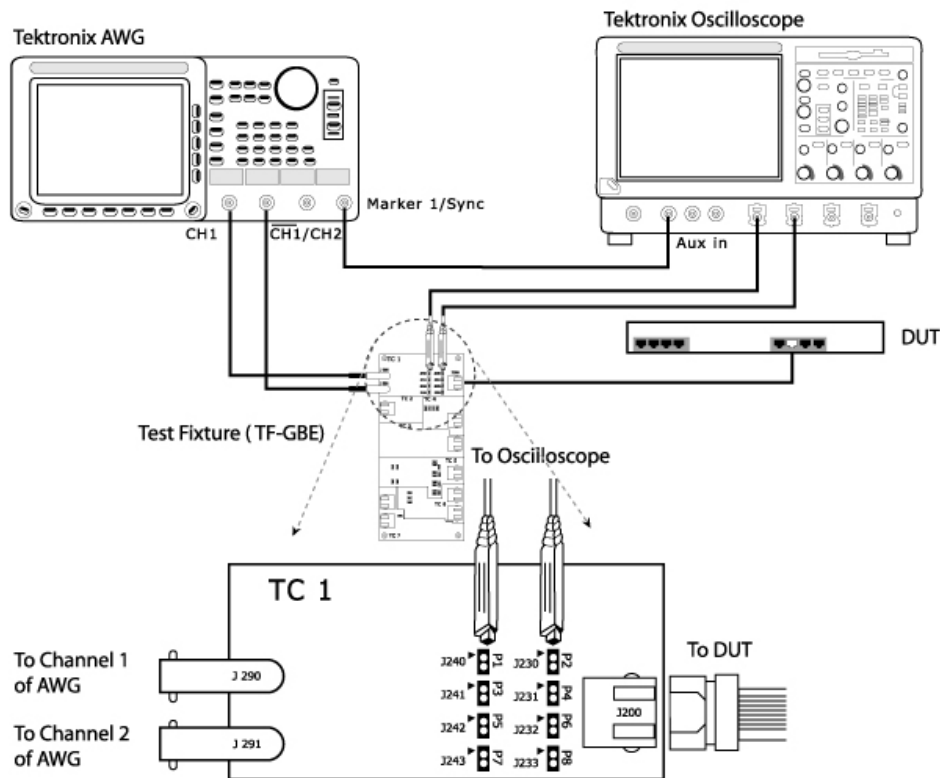

Figure 6-28: 10BASE-T Connections for Return Loss

1. Set the DUT to generate pseudo random sequence.
2. Connect the Ethernet cable to J200 and test port of the DUT.
3. Connect a BNC Cable to AWG+ and Channel 1 of Arbitrary Waveform Generator.
4. Connect a BNC Cable to AWG- and Channel 2 ($\overline{\text{CH1}}$) of Arbitrary Waveform Generator.

Note: The AWG waveforms are available in *C:\TekApplications\TDSET3\AWGWaveforms*. Some of the AWG models do not support the .set file for automatic settings. **In particular, ensure that the AWG clock frequency is set to 250 MHz.** Refer to the ReadMe.txt file for instructions to make those settings manually. This file is available in the corresponding AWG waveform file folder. You can automate the AWG to transfer files and settings as described in *Automate AWG*.

5. To test Transmitter, connect the Differential Probes to P1(J240) and P2(J230), and configured channels of the oscilloscope. Then, short the Jumper J241.
6. To test Receiver, connect the Differential Probe to P3(J241) and P4(J231), and configured channels of the oscilloscope.

Return Loss Calibration Use TC1 of the test fixture for this test. Make the connections as shown by the following figure.

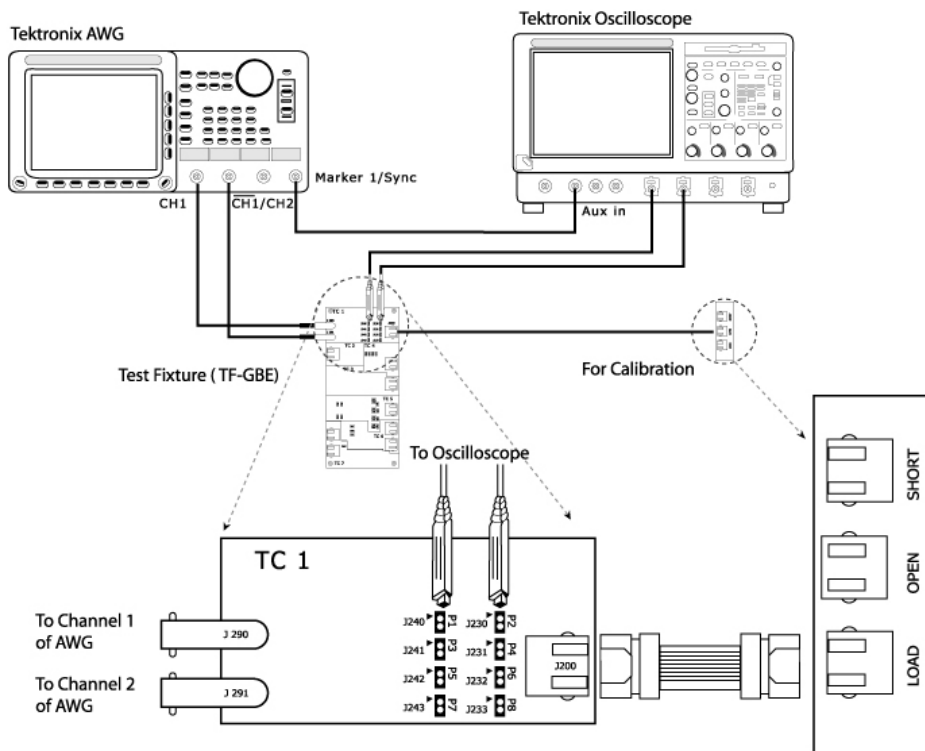

Figure 6-29: 10BASE-T Connections for Return Loss Calibration

1. Connect the Ethernet cable to J200 and test port of the DUT.

2. Connect a BNC Cable to AWG+ and Channel 1 of Arbitrary Waveform Generator.
3. Connect a BNC Cable to AWG- and Channel 2 ($\overline{\text{CH1}}$) of Arbitrary Waveform Generator.

*Note: The AWG waveforms are available in
C:\TekApplications\TDSET3\AWGWaveforms.*

4. To test Transmitter, connect the Differential Probes to P1(J240) and P2(J230), and configured channels of the oscilloscope. Then, short the Jumper J241.
5. To test Receiver, connect the Differential Probe to P3(J241) and P4(J231), and configured channels of the oscilloscope.
6. Connect CAT5 cable to J200 of TC1 and J702 for OPEN calibration.
7. Connect CAT5 cable to J200 of TC1 and J703 for SHORT calibration.
8. Connect CAT5 cable to J200 of TC1 and J704 for LOAD calibration.

CM Voltage Use TC4 of the test fixture for this test. Make the connections as shown by the following figure.

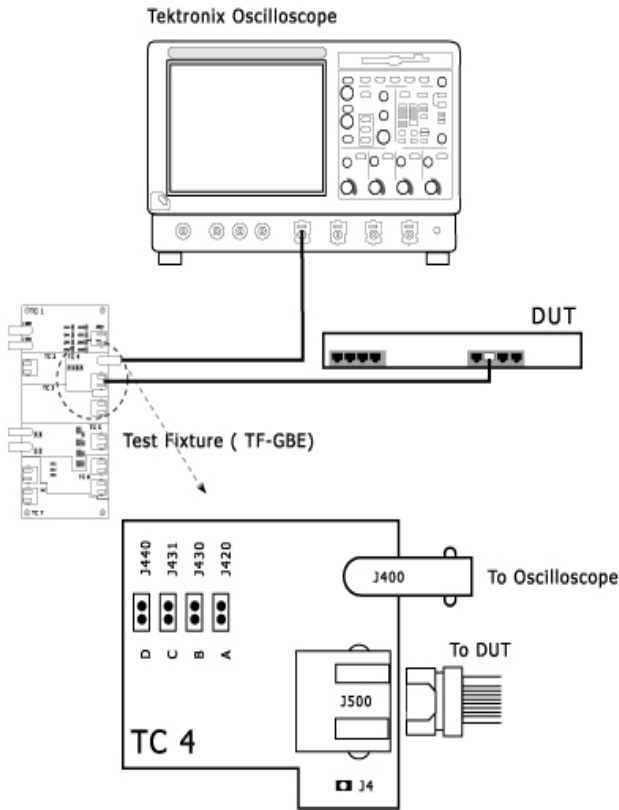

Figure 6-30: 10BASE-T Connections for CM Voltage

1. Set the DUT to generate pseudo-random sequence signal.
2. Connect one end of the Ethernet Cable to J500 of Test Fixture TC4 and the other end to the test port of the DUT.
3. Connect a BNC Cable between J400 of Test Fixture TC4 and configured channel of the oscilloscope.
4. Short J420 of Test Fixture TC4 using a jumper.

Set up the Signal

1000BASE-T

The DUT needs to be set in different modes for various tests as per the following table:

Table 7-1: Test and Pattern description

Test	Pattern	BIT1 (9.15)	BIT2 (9.14)	BIT3 (9.13)
Template, Peak Volt, Droop	Test mode 1	0	0	1
Jitter in Master mode	Test mode 2	0	1	0
Jitter in Slave mode	Test mode 3	0	1	1
Distortion, Return Loss, CM Voltage	Test mode 4	1	0	0
Normal Operation		0	0	0

Contact your PHY vendor for a program that allows you to modify the bits 13, 14, 15 in the GMII Management Register 9.

100BASE-TX

The following table lists the signal pattern that needs to be generated for each of the 100BASE-TX tests:

Table 7-2: Test and Pattern description

Test	Pattern
Template	Scrambled idles
Differential Output Voltage	Scrambled idles
Signal Amplitude Symmetry	Scrambled idles
Rise Time	Scrambled idles
Fall Time	Scrambled idles
Rise/Fall Time Symmetry	Scrambled idles
Waveform Overshoot	Scrambled idles
Jitter	Scrambled idles
Duty Cycle Distortion	Scrambled idles or 0101 pattern
Return Loss	Scrambled idles

If you are using a traffic generator to generate the signal, set the traffic generator to generate the signal pattern as listed in the table.

If you are not using a traffic generator to generate the signal, contact your PHY vendor for a special program to generate these patterns.

10BASE-T

The following table lists the signal pattern that needs to be generated for each of the 10BASE-T tests:

Table 7-3: Test and Pattern description

Test	Pattern
Link Pulse	Link Pulse
MAU	Pseudo-random sequence
TP_IDL	Pseudo-random sequence
Jitter	Pseudo-random sequence
Differential Voltage	Pseudo-random sequence
Harmonic	All 1s or 0s
Return Loss	Pseudo-random sequence
CM Voltage	Pseudo-random sequence

Note: *If you are using a Link Partner, ensure that you do not test the Link Pulse generated by the Link Partner, but test the Link Pulse generated by the DUT.*

If you are using a traffic generator to generate the signal, set the traffic generator to generate the signal pattern as listed in the table.

If you are not using a traffic generator to generate the signal, contact your PHY vendor for a special program to generate these patterns.

How To Test 1000BASE-T

Template

1. Click **Tests > Select > 1000BASE-T** from the menu bar.
2. In Template/Volt tab, select a point in the *Template* group, for example, A.

Note: The status bar displays the major configuration details. If you do not want to change the configuration settings, you can skip Step 3.

3. To change the configuration settings, select **Tests > Configure** from the menu bar, or click the Configure button in the Selection pane.
4. In the Configuration window, select the following options:

Table 8-1: 1000BASE-T Template Configuration Options

Parameter	Options	To Do
Data	CH1, CH2, CH3, or CH4	Select the channel to which the DUT is connected.
# Averages	64 to 10000	Enter the number of waveforms you want to average.
Output	Ref1, Ref2, Ref3, or Ref4	Select the reference waveform on which the processed waveform will be stored.
Disturbing Signal	Yes or No	Select the options depending on whether the Disturbing signal is present or not. <hr/> <i>Note: Selecting Disturbing Signal as Yes, enables the Jig Match in Connect pane.</i> <hr/>
Filter	Int or Ext	Select the options depending on whether the filter is applied or not. If you select Ext, the application assumes that the filter is applied externally.

5. Select **Tests > Connect** or Connect in the Selection pane and make connections.
6. Select **View Wfm** in the Selection pane, to view and compare the waveform with the acquired waveform.
7. If the disturbing signal is present and you have configured **Disturbing Signal** as **Yes**, then click **Run Test**. The application does as described next.

- Displays a message box to confirm the overwrite of the reference waveform. Select **Yes** to continue.
 - Checks whether the DUT is connected
 - Sets the trigger
 - Acquires, filters, and removes the disturbing signal
 - Normalizes the data
 - Displays the processed waveform on selected output (reference waveform) over the template mask
8. If the disturbing signal is not present and you have configured Disturbing Signal as **No**, and then click **Run Test**. The application does the following:
- Displays a message box to confirm the overwrite of the reference waveform. Select **Yes** to continue.
 - Checks whether the DUT is connected
 - Sets the trigger
 - Acquires, filters, and normalizes the data
 - Displays the processed waveform on selected output (reference waveform) over the template mask

If the test fails, the application captures the waveform, circles the hits and saves the information to the report.

The following figure shows a typical processed waveform for Template Testing on Points A, B, C, and D:

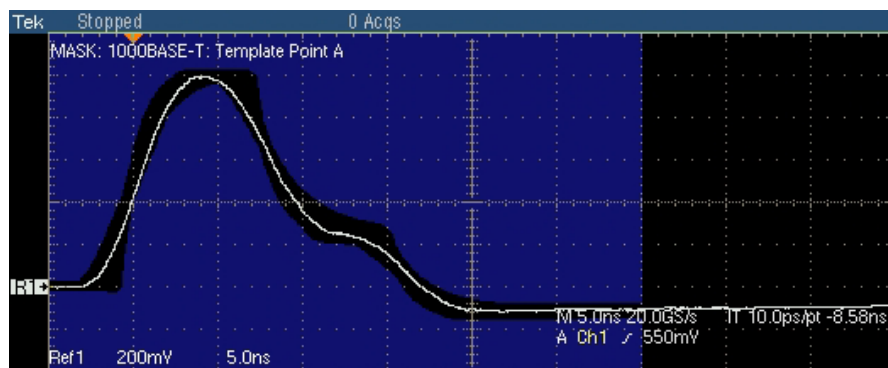

Figure 8-1: Waveform for 1000BASE-T Template Points A, B, C, and D

The following figure shows a typical processed waveform for Template Testing on Points F and H:

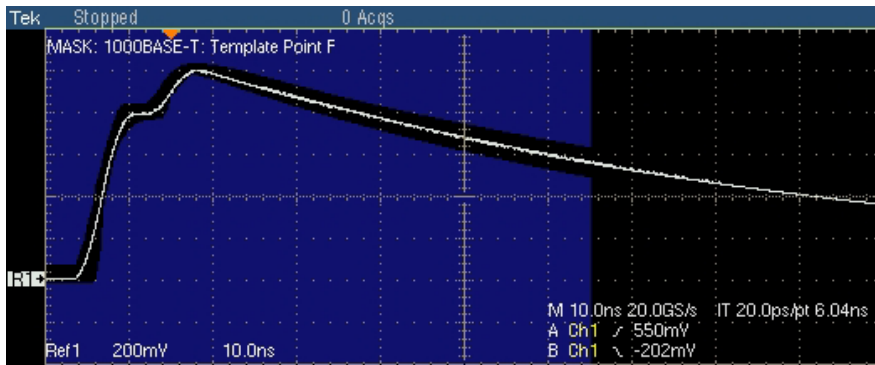

Figure 8-2: Waveform for 1000BASE-T Template Points F and H

Note: In TDS5000B series oscilloscopes, the horizontal scale is set to 4 ns.

The application also tests for mask and displays the results as pass or fail.

If the acquired waveform does not lie within the mask, click Manual Fit. Click the arrow buttons to adjust the Ref waveform to fit into the mask. This repeats the mask pass/fail test and displays the results in the **Results Summary** pane.

The application automatically displays the results as pass or fail. Select **Results** in the Execution pane and then click **Result Details** button to view the detailed results.

Peak Volt

1. Click **Tests > Select > 1000BASE-T** from the menu bar.
2. In Template/Volt tab, select a point in the *Peak Volt* group, for example, A.

Note: The status bar displays the major configuration details. If you do not want to change the configuration settings, you can skip Step 3.

3. To change the configuration settings, select **Tests > Configure** from the menu bar, or click the Configure button in the Selection pane.

4. In the Configuration window, select the following options:

Table 8-2: 1000BASE-T Peak Volt Configuration Options

Parameter	Options	To Do
Data	CH1, CH2, CH3, or CH4	Select the channel to which the DUT is connected.
# Averages	64 to 10000	Enter the number of waveforms you want to average.
Output	Ref1, Ref2, Ref3, or Ref4	Select the reference waveform on which the processed waveform will be stored.
Disturbing Signal	Yes or No	Select the options depending on whether the Disturbing signal is present or not.
Filter	Int or Ext	Select the options depending on whether the filter is applied or not. If you select Ext, the application assumes that the filter is applied externally.

5. Select **Tests > Connect** or Connect in the Selection pane and make connections.
6. Select View Wfm in the Selection pane, to view and compare the waveform with the acquired waveform.
7. If the disturbing signal is present and you have configured Disturbing Signal as **Yes**, and then click **Run Test**.

The application does the following:

- Displays a message box to confirm the overwrite of the reference waveform. Select **Yes** to continue.
 - Checks whether the DUT is connected
 - Acquires, filters, and removes the disturbing signal
 - Finds the peak value of the point selected after filtering
 - Compares with the specification range specified by the standard
 - Displays the processed waveform on the selected output
8. If the disturbing signal is not present and you have configured Disturbing Signal as **No**, and then click **Run Test**. The application does the following:
 - Displays a message box to confirm the overwrite of the reference waveform. Select **Yes** to continue.
 - Checks whether the DUT is connected
 - Acquires and filters the data

- Finds the peak value of the point selected after filtering
- Compares with the specification range specified by the standard
- Displays the processed waveform on the selected output

The following figure displays a typical DUT waveform for Peak Voltage Testing on Points A, B, C, and D:

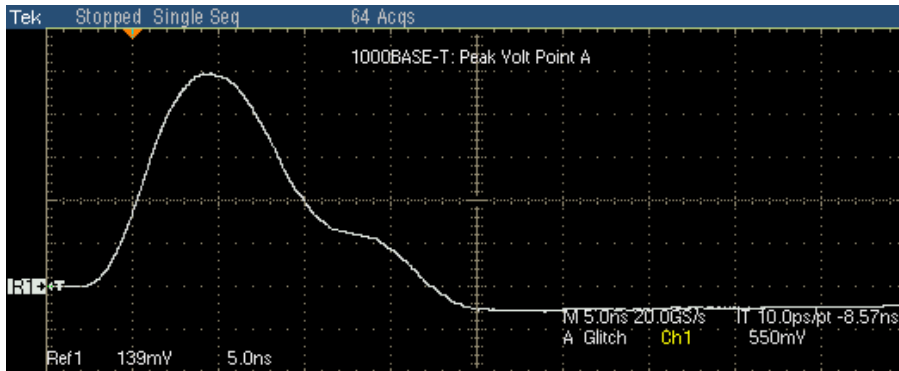

Figure 8-3: Waveform for 1000BASE-T Peak Volt Points A, B, C, and D

Note: In TDS5000B series oscilloscopes, the horizontal scale is set to 4 ns.

The application automatically displays the results as pass or fail. Select **Results** in the Execution pane and then click **Result Details** button to view the detailed results.

Drop

1. Click **Tests > Select > 1000BASE-T** from the menu bar.
2. In the Drop tab, select a point, for example, G.

Note: The status bar displays the major configuration details. If you do not want to change the configuration settings, you can skip Step 3.

3. To change the configuration settings, select **Tests > Configure** from the menu bar, or click the Configure button in the Selection pane.

4. In the Configuration window, select the following options:

Table 8-3: 1000BASE-T Droop Configuration Options

Parameter	Options	To Do
Data	CH1, CH2, CH3, or CH4	Select the channel to which the DUT is connected.
# Averages	64 to 10000	Enter the number of waveforms you want to average.
Output	Ref1, Ref2, Ref3, or Ref4	Select the reference waveform on which the processed waveform will be stored.
Disturbing Signal	Yes or No	Select the options depending on whether the Disturbing signal is present or not.

5. Select **Tests > Connect** or **Connect** in the Selection pane and make connections.
6. Select **View Wfm** in the Selection pane, to view and compare the waveform with the acquired waveform.
7. If the disturbing signal is present and you have configured **Disturbing Signal** as **Yes**, and then click **Run Test**.

The application does the following:

- Displays a message box to confirm the overwrite of the reference waveform. Select **Yes** to continue.
 - Checks whether the DUT is connected
 - Acquires and removes the disturbing signal
 - Displays the processed waveform on selected output and places vertical cursors at Point F and Point G,
 - Displays the cursor values - voltage, time, voltage difference and time difference – at the points F and G
8. If the disturbing signal is not present and you have configured **Disturbing Signal** as **No**, and then click **Run Test**. The application does the following:
 - Checks whether the DUT is connected
 - Displays the acquired waveform and places vertical cursors at Point F and Point G
 - Displays the cursor values - voltage, time, voltage difference, and time difference – at the Point F and Point G

The following figure shows a typical DUT waveform showing point F and G:

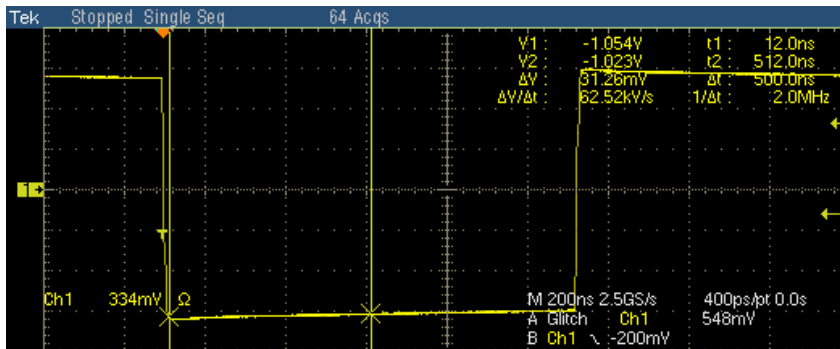

Figure 8-4: Waveform for 1000BASE-T Droop Points F and G

The application automatically displays the results as pass or fail. Select **Results** in the Execution pane and then click **Result Details** button to view the detailed results.

Jitter Master Filtered

1. Click **Tests > Select > 1000BASE-T** from the menu bar.
2. In the Jit/Distortion tab, select **Master Filtered**.

Note: The status bar displays the major configuration details. If you do not want to change the configuration settings, you can skip Step 3.

3. To change the configuration settings, select **Tests > Configure** from the menu bar, or click the Configure button in the Selection pane.
4. In the Configuration window, select the following options:

Table 8-4: 1000BASE-T Jitter Master Filtered Configuration Options

Parameter	Options	To Do
Data	CH1, CH2, CH3, or CH4	Select the channel to which the DUT is connected.
Master CLK	CH1, CH2, CH3, or CH4	Select the channel to which the Master TX_TCLK is connected.
Clock Edge	Rising or Falling	Select the clock edge on which the oscilloscope finds the trigger point.
Record Length		Varies depending on the Memory option available on the Oscilloscope.

TX_TCLK	Yes, No	Select Yes if you have access to TX_TCLK. Select No if you do not have access to TX_TCLK.
Data (TM2)	CH1, CH2, CH3, or CH4	Select the channel to which the Test Mode 2 signal is connected.
Hysteresis	5.00% to 30.00%	Enter the hysteresis percent value.

5. Select **Tests > Connect** or **Connect** in the Selection pane and make connections.
6. Select **View Wfm** in the Selection pane, to view and compare the waveform with the acquired waveform.

If you have access to TX_TCLK

- Click **Run Test**. The application displays the following dialog box.

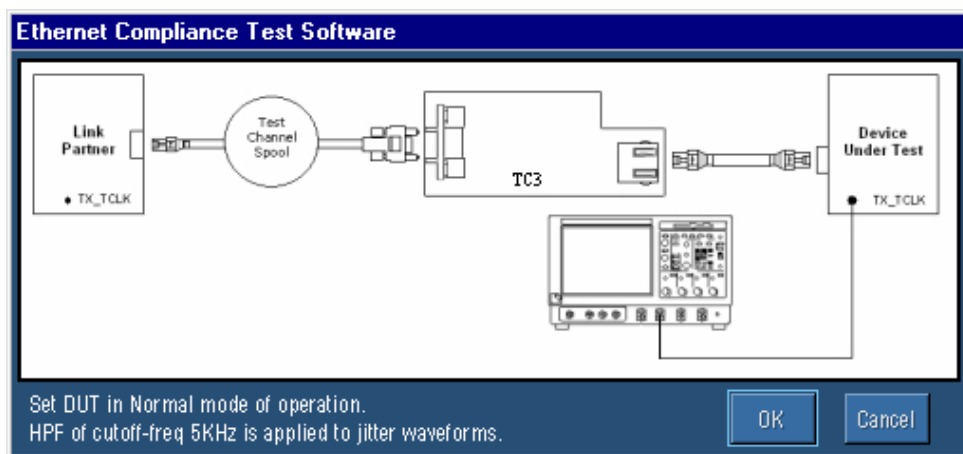

Figure 8-5: 1000BASE-T Jitter Master Filtered Step 1

- Set the DUT in Normal mode as Master and connect to the Link Partner. Then, click OK.
- The application does the following:
 - Checks whether the Master TX_TCLK is connected
 - Sets up the signal, where at least 10^5 edges (minimum of opt. 3M required) are available
 - Derives the jitter waveform, applies the filter
 - Determines the peak-to-peak value of the filtered waveform

- The application displays the following dialog box.

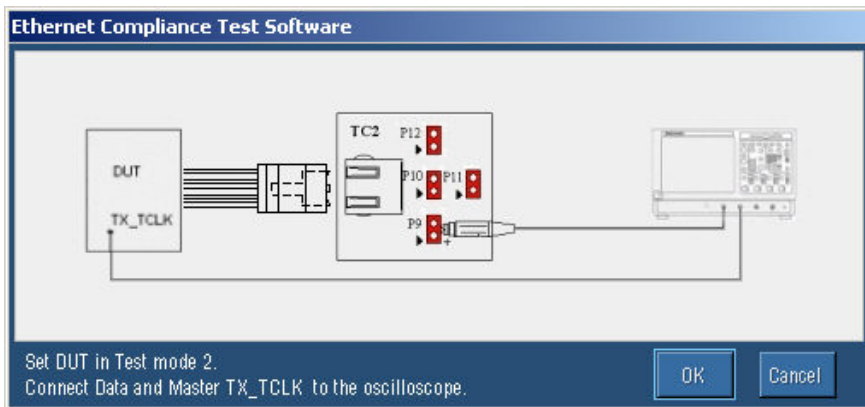

Figure 8-6: 1000BASE-T Jitter Master Filtered Step 2

- Set DUT in Test mode 2 and connect Data and Clock to the oscilloscope.
- Click OK. The application checks whether the Data and Master CLK signal is connected and then measures jitter (Jtxout) of the data with respect to the Master CLK.
- Displays the TIE plot of the jitter waveform as shown by the next figure.

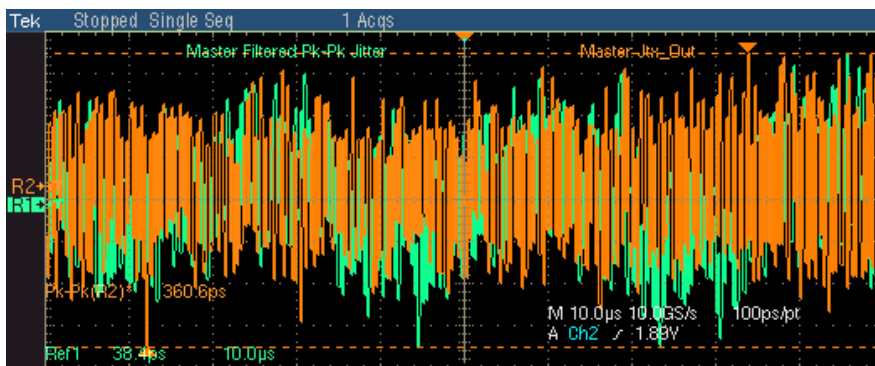

Figure 8-7: Waveform for 1000BASE-T Jitter Master Filtered

Note: The TDS6604 and TDS6404 oscilloscopes acquire approximately 1250 edges.

The application automatically displays the results as pass or fail. Select **Results** in the Execution pane and then click **Result Details** button to view the detailed results.

If you do not have access to TX_TCLK

- Click Run Test. A message box appears. Click OK to quit the message box and continue running the test.

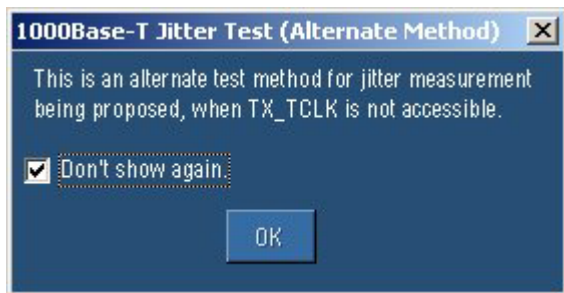

- Set the DUT in Test Mode 2 and connect Data (TM2) to the oscilloscope.
- Click OK. The application does the following:
 - Checks whether Data (TM2) is connected
 - Sets up the signal, where at least 105 edges (minimum of opt. 4M required) are available
 - Derives the jitter waveform, applies the filter
 - Determines the peak-to-peak value of the filtered waveform
- Displays the TIE plot of the jitter waveform.

The following figure shows a typical TIE plot of Jitter waveform:

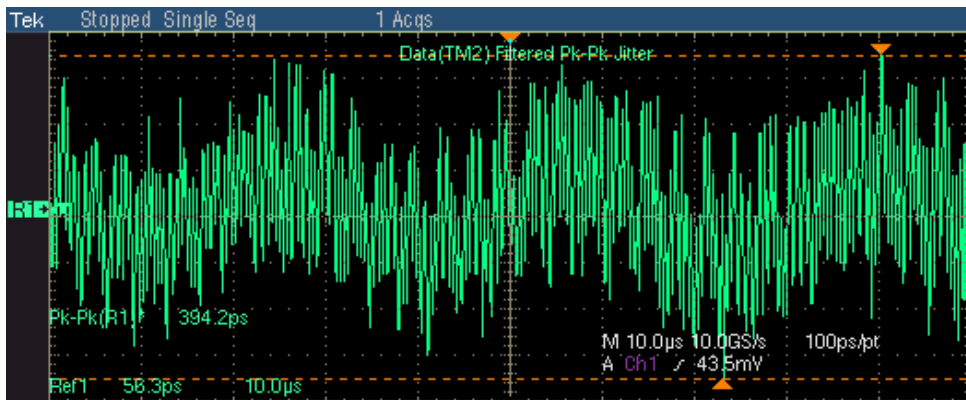

Figure 8-8: 1000BASE-T Jitter Master Filtered (without TX_TCLK)

***Note:** The TDS6604 and TDS6404 oscilloscopes acquire approximately 625 edges. This is an alternate test method for jitter measurement being proposed, when TX_TCLK is not accessible. This is an informal test method.*

- The application automatically displays the results as inconclusive or fail. Select Results in the Execution pane and then click Result Details button to view the detailed results.

Jitter Master Unfiltered

1. Click **Tests > Select > 1000BASE-T** from the menu bar.
2. In the Jit/Distortion tab, select **Master Unfiltered**.

Note: The status bar displays the major configuration details. If you do not want to change the configuration settings, you can skip Step 3.

3. To change the configuration settings, select **Tests > Configure** from the menu bar, or click the Configure button in the Selection pane.
4. In the Configuration window, select the following options:

Table 8-5: 1000BASE-T Jitter Master Unfiltered Configuration Options

Parameter	Options	To Do
Master CLK	CH1, CH2, CH3, or CH4	Select the channel to which the Master TX_TCLK is connected.
Clock Edge	Rising or Falling	Select the clock edge on which the oscilloscope finds the trigger point.
Meas Type	Histogram or TIE	Select the measurement type.
Record Length		Varies depending on the Memory option available on the Oscilloscope. <i>Note: The Record Length is enabled only if you select Meas Type as TIE.</i>
TX_TCLK	Yes, No	Select Yes if you have access to TX_TCLK. Select No if you do not have access to TX_TCLK.
Data (TM2)	CH1, CH2, CH3, or CH4	Select the channel to which the Test Mode 2 signal is connected.
Hysteresis	5.00% to 30.00%	Enter the hysteresis percent value.

5. Select **Tests > Connect** or **Connect** in the Selection pane and make connections.
6. Select **View Wfm** in the Selection pane, to view and compare the waveform with the acquired waveform.

If you have access to TX_TCLK

- Click **Run Test**. The application does the following for Histogram method:
 - Checks whether the Master TX_TCLK is connected
 - Trigger on Master TX_TCLK clock signal at 50% of peak-to-peak amplitude
 - Sets up the oscilloscope horizontal and vertical scale based on Master clock signal
 - Places a horizontal histogram on the pulse following the trigger pulse at the trigger level
 - Reads the peak-to-peak jitter from the histogram
 - Compares the read out values with the values specified in the standard
 - Takes approximately one minute to achieve approximately 13 million waveform acquisition
 - Displays the Master clock waveform
- Click **Run Test**. The application does the following for TIE method:
 - Checks whether the Master TX_TCLK is connected
 - Trigger on Master TX_TCLK clock signal at 50% of peak-to-peak amplitude
 - Derives the jitter waveform of the Master TX_TCLK with respect to unjittered reference.
 - Determines the Pk-Pk value of jitter waveform
 - Compares the read out values with the values specified in the standard
 - Displays the TIE plot of the jitter waveform

- The following figure shows a typical TIE plot of Jitter waveform:

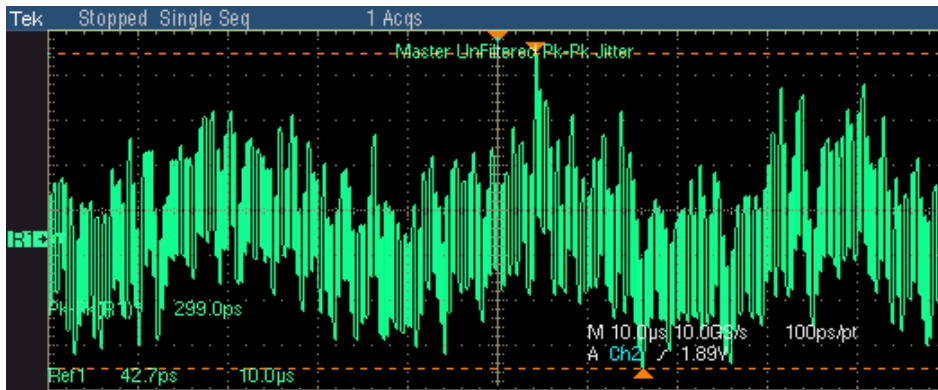

Figure 8-9: TIE Waveform for 1000BASE-T Jitter Master Unfiltered

Note: The TDS6604 and TDS6404 oscilloscopes acquire approximately 1250 edges.

- The following figure shows a typical Histogram plot of Jitter waveform:

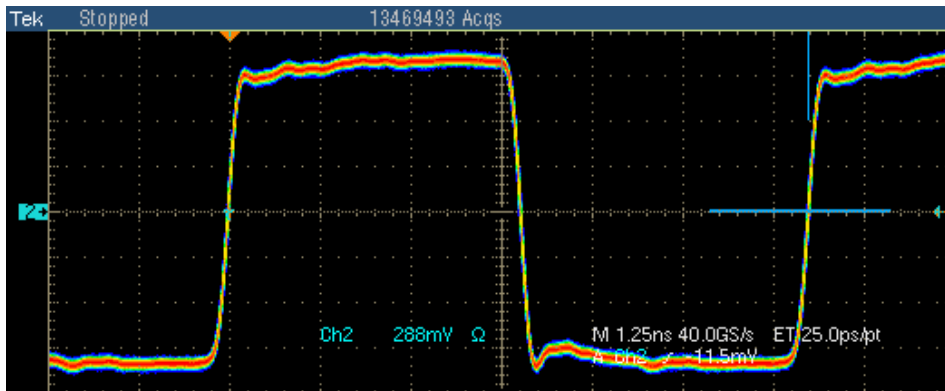

Figure 8-10: Histogram Waveform for 1000BASE-T Jitter Master Unfiltered

Note: In TDS6000 series oscilloscopes, approximately 13,000,000 waveform database samples are acquired.

The application automatically displays the results as pass or fail. Select **Results** in the Execution pane and then click **Result Details** button to view the detailed results.

If you do not have access to TX_TCLK

- Click **Run Test**. A message box appears. Click OK to quit the message box and continue running the test.

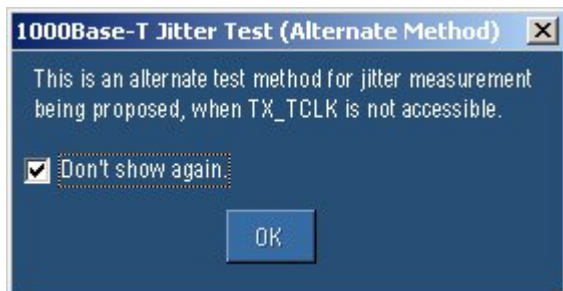

- The application does the following for Histogram method:
 - Checks whether Data (TM2) is connected
 - Trigger on Data (TM2) signal at 50% of peak-to-peak amplitude
 - Sets up the oscilloscope horizontal and vertical scale based on Data (TM2) signal
 - Places a horizontal histogram on the pulse following the trigger pulse at the trigger level
 - Reads the peak-to-peak jitter from the histogram
 - Compares the read out values with the values specified in the standard
 - Takes approximately one minute to achieve approximately 13 million waveform acquisition
 - Displays the Data (TM2) waveform
- Click **Run Test**.

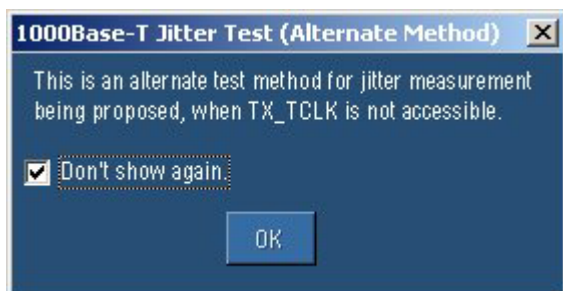

- The application does the following for TIE method:
 - Checks whether Data (TM2) is connected

- Trigger on Data (TM2) signal at 50% of peak-to-peak amplitude
 - Derives the jitter waveform of Data (TM2) with respect to unjittered reference
 - Determines the Pk-Pk value of jitter waveform
 - Compares the read out values with the values specified in the standard
 - Displays the TIE plot of the jitter waveform
- The following figure shows a typical TIE plot of Jitter waveform:

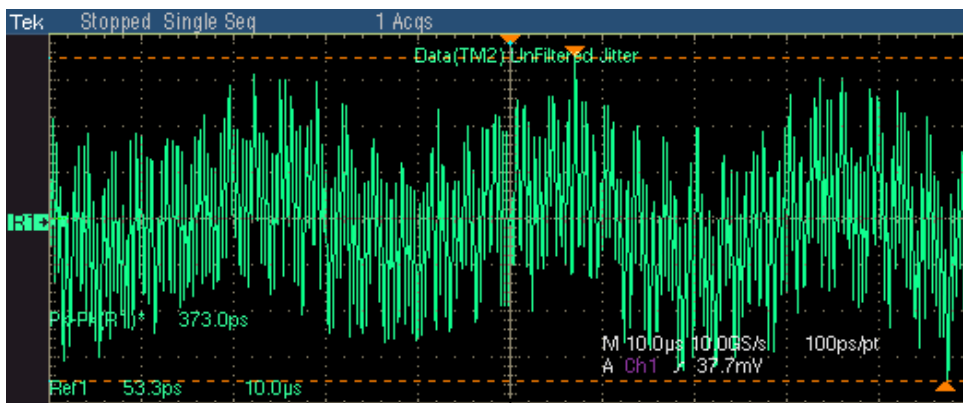

Figure 8-11: TIE Waveform for 1000BASE-T Jitter Master Unfiltered

Note: The TDS6604 and TDS6404 oscilloscopes acquire approximately 625 edges. This is an alternate test method for jitter measurement being proposed, when TX_TCLK is not accessible. This is an informal test method.

- The following figure shows a typical Histogram plot of Jitter waveform:

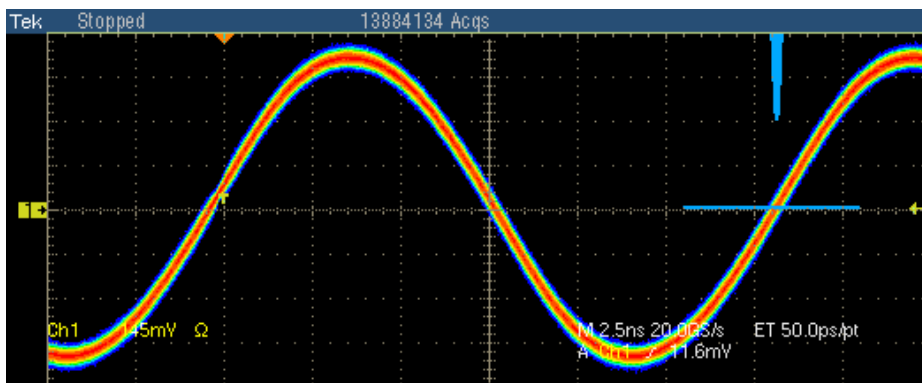

Figure 8-12: Histogram Waveform for 1000BASE-T Jitter Master Unfiltered

Note: In TDS6000 series oscilloscopes, approximately 13,000,000 waveform database samples are acquired.

The application automatically displays the results as pass or fail. Select **Results** in the Execution pane and then click **Result Details** button to view the detailed results.

Jitter Slave Filtered

Note: The two-channel oscilloscopes do not support Jitter Slave Filtered.

1. Click **Tests > Select > 1000BASE-T** from the menu bar.
2. In the Jit/Distortion tab, select **Slave Filtered**.

Note: The status bar displays the major configuration details. If you do not want to change the configuration settings, you can skip Step 3.

3. To change the configuration settings, select **Tests > Configure** from the menu bar, or click the Configure button in the Selection pane.
4. In the Configuration window, select the following options:

Table 8-6: 1000BASE-T Jitter Slave Filtered Configuration Options

Parameter	Options	To Do
Data	CH1, CH2, CH3, or CH4	Select the channel to which the DUT is connected.
Master CLK	CH1, CH2, CH3, or CH4	Select the channel to which the Master TX_TCLK is connected.
Slave CLK	CH1, CH2, CH3, or CH4	Select the channel to which the Slave TX_TCLK is connected.
Clock Edge	Rising or Falling	Select the clock edge on which the oscilloscope finds the trigger point.
Record Length		Varies depending on the Memory option available on the Oscilloscope.
TX_TCLK	Yes, No	Select Yes if you have access to TX_TCLK. Select No if you do not have access to TX_TCLK.
Data (TM2)	CH1, CH2, CH3, or CH4	Select the channel to which the Test Mode 2 signal is connected.
Data (TM3)	CH1, CH2, CH3, or CH4	Select the channel to which the Test Mode 3 signal is connected.
Hysteresis	5.00% to 30.00%	Enter the hysteresis percent value.

Table 8-6: 1000BASE-T Jitter Slave Filtered Configuration Options

5. Select **Tests > Connect** or **Connect** in the Selection pane and make connections.
6. Select **View Wfm** in the Selection pane, to view and compare the waveform with the acquired waveform.

If you have access to TX_TCLK

- Click **Run Test**. The application displays the following dialog box.

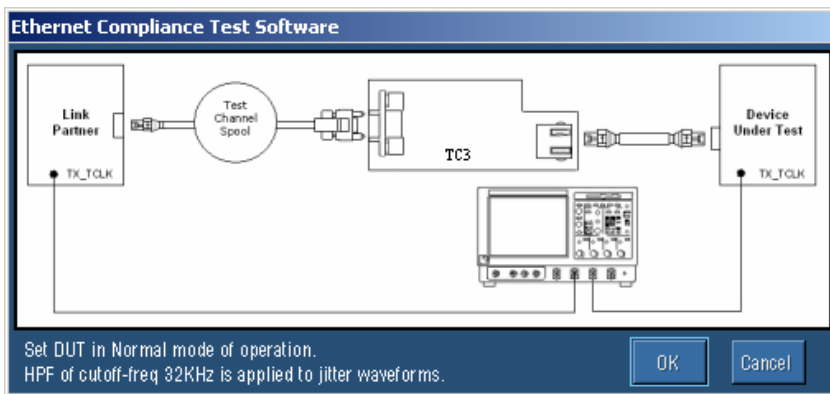

Figure 8-13: 1000BASE-T Jitter Slave Filtered Step 1

- Set the DUT in Normal mode as Slave and connect to the Link Partner. Then, click OK.
- The application does the following:
 - Checks whether the Master TX_TCLK and Slave TX_TCLK is connected
 - Sets up the signal, where at least 10^5 (minimum of opt. 3M required) edges are available
 - Derives the jitter waveform of Master TX_TCLK with respect to unjittered reference
 - Derives the jitter waveform of Slave TX_TCLK with respect to Master TX_TCLK
 - Applies the filter, and determines the peak-to-peak value of the filtered waveforms
- The application displays the following dialog box.

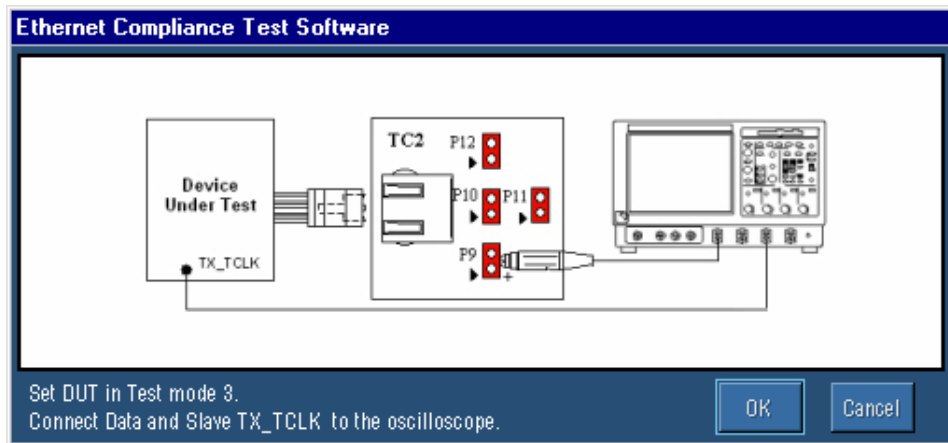

Figure 8-14: 1000BASE-T Jitter Slave Filtered Step 2

- Set DUT in Test mode 3 and connect Data and Slave TX_TCLK to the oscilloscope.
- Click OK. The application checks whether the Data and Slave TX_TCLK is connected.
- Then, the application measures jitter (Jtxout) of the data with respect to the Slave TX_TCLK.
- Displays the TIE plot of the Jitter waveform as shown by the next figure.

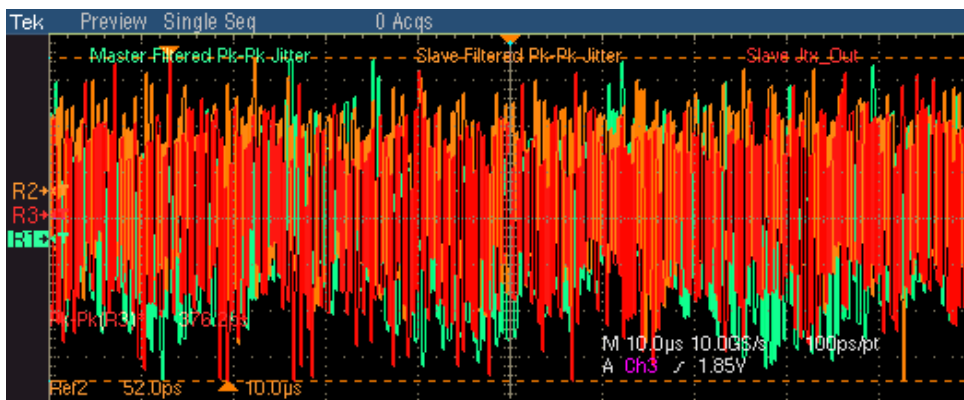

Figure 8-15: Waveform for 1000BASE-T Jitter Slave Filtered

Note: The TDS6604 and TDS6404 oscilloscopes acquire approximately 1250 edges.

The application automatically displays the results as pass or fail. Select **Results** in the Execution pane and then click **Result Details** button to view the detailed results.

If you do not have access to TX_TCLK

- Click **Run Test**. A message box appears. Click OK to quit the message box and continue running the test.

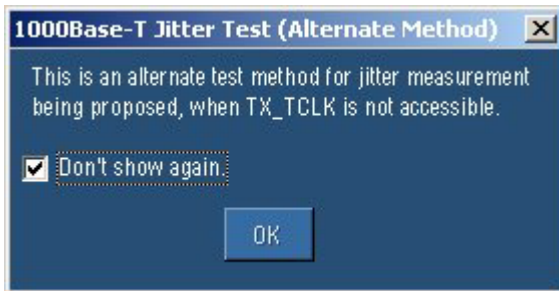

- Set the DUT in Normal mode as Slave and connect to the Link Partner. Then, click OK.
- The application does the following:
 - Checks whether Data (TM2) and Data (TM3) is connected
 - Sets up the signal, where at least 105 edges (minimum opt. 4M required) are available
 - Derives the jitter waveform of Data (TM2) with respect to unjittered reference
 - Derives the jitter waveform of Data (TM3) with respect to unjittered reference
 - Applies the filter, and determines the peak-to-peak value of the filtered waveforms

- Displays the TIE plot of the Jitter waveform as shown by the next figure.

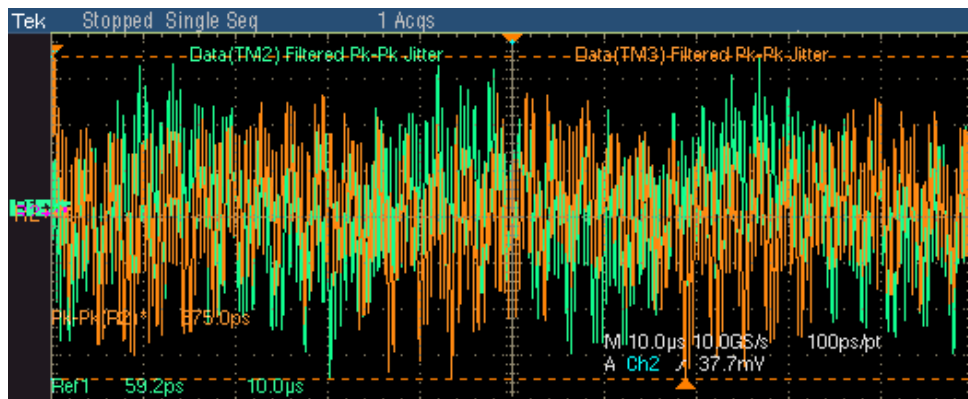

Figure 8-16: Waveform for 1000BASE-T Jitter Slave Filtered

Note: The TDS6604 and TDS6404 oscilloscopes acquire approximately 625 edges. This is an alternate test method for jitter measurement being proposed, when TX_TCLK is not accessible. This is an informal test method.

The application automatically displays the results as pass or fail. Select **Results** in the Execution pane and then click **Result Details** button to view the detailed results.

Jitter Slave Unfiltered

1. Click **Tests > Select > 1000BASE-T** from the menu bar.
2. In the Jit/Distortion tab, select **Slave Unfiltered**.

Note: The status bar displays the major configuration details. If you do not want to change the configuration settings, you can skip Step 3.

3. To change the configuration settings, select **Tests > Configure** from the menu bar, or click the Configure button in the Selection pane.

4. In the Configuration window, select the following options:

Table 8-7: 1000BASE-T Jitter Master Unfiltered Configuration Options

Parameter	Options	To Do
Master CLK	CH1, CH2, CH3, or CH4	Select the channel to which the Master TX_TCLK is connected.
Slave CLK	CH1, CH2, CH3, or CH4	Select the channel to which the Slave TX_TCLK is connected.
Clock Edge	Rising or Falling	Select the clock edge on which the oscilloscope finds the trigger point.
Meas Type	Histogram or TIE	Select the measurement type.
Record Length		Varies depending on the Memory option available on the Oscilloscope. <i>Note: The Record Length is enabled only if you select Meas Type as TIE.</i>
TX_TCLK	Yes, No	Select Yes if you have access to TX_TCLK. Select No if you do not have access to TX_TCLK.
Data (TM2)	CH1, CH2, CH3, or CH4	Select the channel to which the Test Mode 2 signal is connected.
Data (TM3)	CH1, CH2, CH3, or CH4	Select the channel to which the Test Mode 3 signal is connected.
Hysteresis	5.00% to 30.00%	Enter the hysteresis percent value.

5. Select **Tests > Connect** or **Connect** in the Selection pane and make connections.
6. Select **View Wfm** in the Selection pane, to view and compare the waveform with the acquired waveform.

If you have access to TX_TCLK

- Click **Run Test**. The application does the following for Histogram method:
 - Checks whether the Master TX_TCLK and Slave TX_TCLK is connected
 - Trigger on Master TX_TCLK clock signal at 50% of peak-to-peak amplitude
 - Sets up the oscilloscope horizontal and vertical scale based on Slave TX_TCLK signal
 - Places a horizontal histogram on the Slave TX_TCLK pulse following the trigger pulse at 50% of peak-to-peak amplitude

- Measures the peak-to-peak jitter from the histogram
 - Compares the read out values with the values specified in the standard
 - Takes approximately one minute to achieve approximately 13 million waveform acquisition
 - Displays the Slave TX_TCLK waveform
- Click **Run Test**. The application does the following for TIE method:
 - Checks whether the Master TX_TCLK and Slave TX_TCLK is connected
 - Trigger on Master TX_TCLK clock signal at 50% of peak-to-peak amplitude
 - Derives the jitter waveform of the Slave TX_TCLK with respect to Master TX_TCLK
 - Determines the Pk-Pk value of jitter waveform
 - Compares the read out values with the values specified in the standard
 - Displays the TIE plot of the jitter waveform

The following figure shows a typical TIE plot of Jitter waveform:

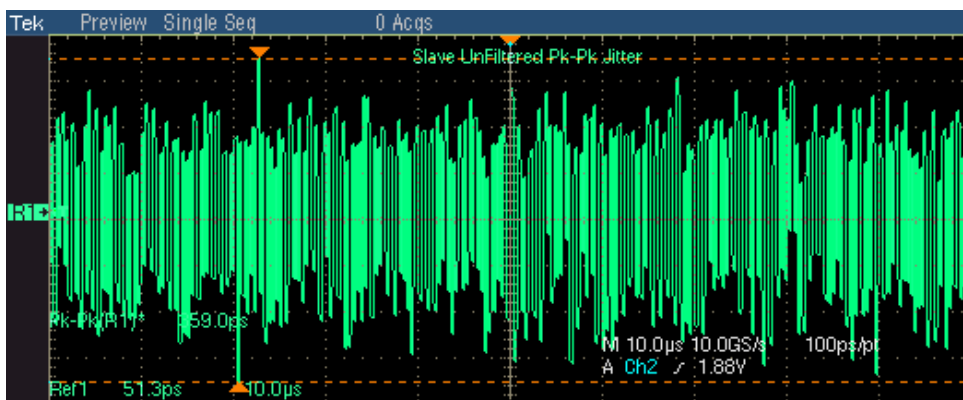

Figure 8-17: TIE Waveform for 1000BASE-T Jitter Slave Unfiltered

***Note:** The TDS6604 and TDS6404 oscilloscopes acquire approximately 1250 edges.*

- The following figure shows a typical Histogram plot of Jitter waveform:

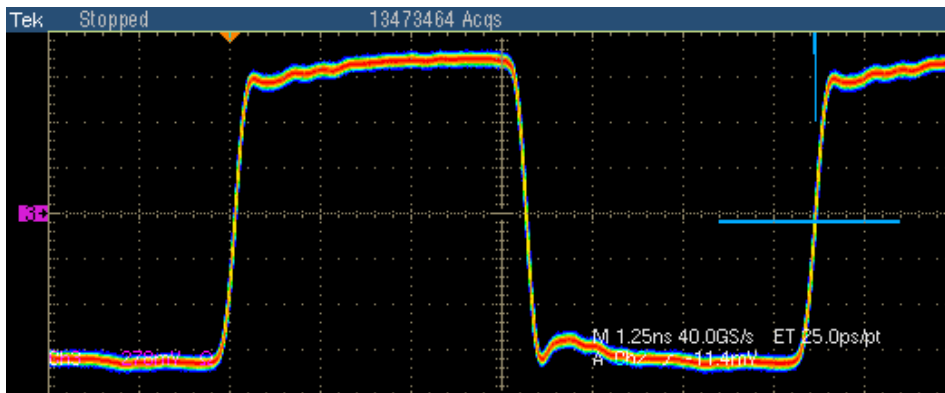

Figure 8-18: Histogram Waveform for 1000BASE-T Jitter Slave Unfiltered

Note: In TDS6000 series oscilloscopes, approximately 13,000,000 waveform database samples are acquired

The application automatically displays the results as pass or fail. Select **Results** in the Execution pane and then click **Result Details** button to view the detailed results.

If you do not have access to TX_TCLK

- Click Run Test. A message box appears. Click OK to quit the message box and continue running the test.



- The application does the following for Histogram method:
 - Checks whether Data (TM2) and Data (TM3) is connected
 - Trigger on Data (TM2) at 50% of peak-to-peak amplitude
 - Sets up the oscilloscope horizontal and vertical scale based on Data (TM2)
 - Places a horizontal histogram on the Data (TM2) pulse following the trigger pulse at 50% of peak-to-peak amplitude

- Measures the peak-to-peak Data (TM2) jitter from the histogram
 - Trigger on Data (TM3) at 50% of peak-to-peak amplitude
 - Sets up the oscilloscope horizontal and vertical scale based on Data (TM3)
 - Places a horizontal histogram on the Data (TM3) pulse following the trigger pulse at 50% of peak-to-peak amplitude
 - Measures the peak-to-peak Data (TM3) jitter from the histogram
 - Compares the read out values with the values specified in the standard
 - Takes approximately one minute to achieve approximately 13 million waveform acquisition
 - Displays the Data (TM2) and Data (TM3) waveform
- Click Run Test. A message box appears. Click OK to quit the message box and continue running the test.

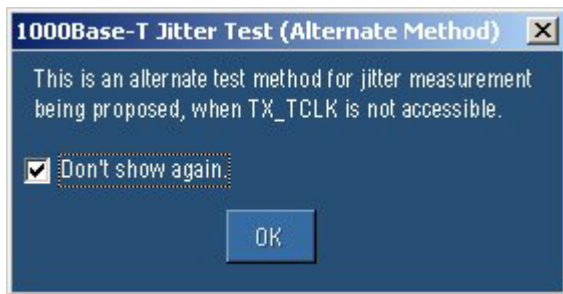

- The application does the following for TIE method:
 - Checks whether Data (TM2) and Data (TM3) is connected
 - Trigger on Data (TM2) at 50% of peak-to-peak amplitude
 - Derives the jitter waveform of the Data (TM2) with respect to unjittered reference
 - Determines the Pk-Pk value of Data (TM2) jitter waveform
 - Trigger on Data (TM3) at 50% of peak-to-peak amplitude
 - Derives the jitter waveform of the Data (TM3) with respect to unjittered reference
 - Determines the Pk-Pk value of Data (TM3) jitter waveform
 - Compares the read out values with the values specified in the standard

- Displays the TIE plot of the jitter waveform

The following figure shows a typical TIE plot of Jitter waveform:

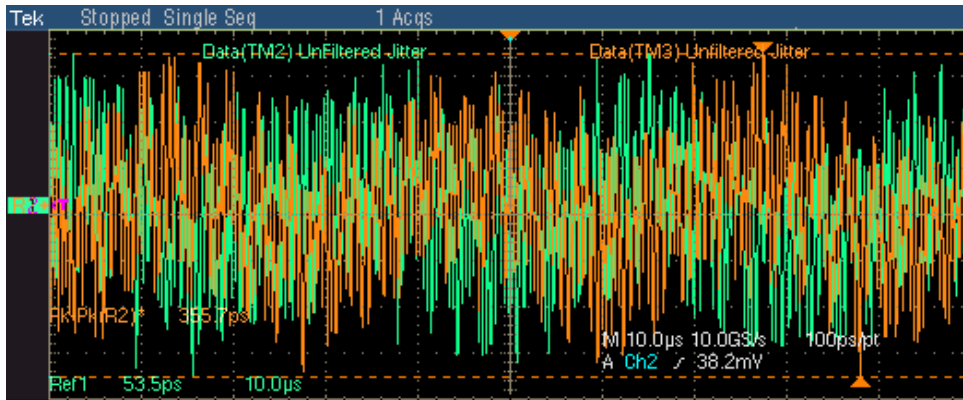

Figure 8-19: TIE Waveform for 1000BASE-T Jitter Slave Unfiltered

Note: The TDS6604 and TDS6404 oscilloscopes acquire approximately 625 edges. This is an alternate test method for jitter measurement being proposed, when TX_TCLK is not accessible. This is an informal test method.

- The following figure shows a typical Histogram plot of Jitter waveform:

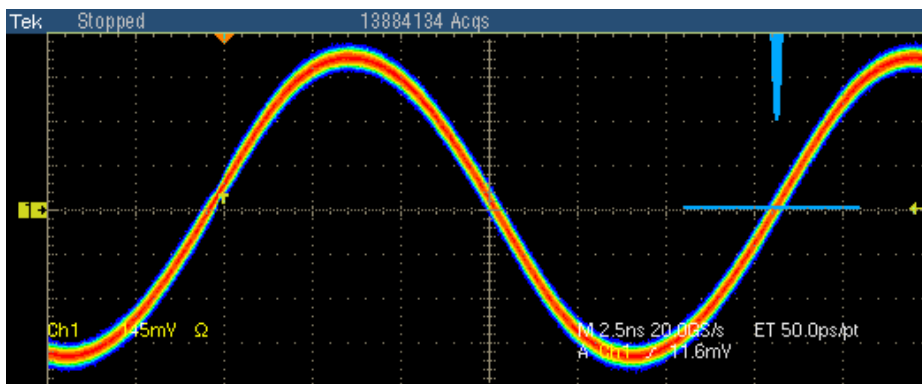

Figure 8-20: Histogram Waveform for 1000BASE-T Jitter Slave Unfiltered

Note: In TDS6000 series oscilloscopes, approximately 13,000,000 waveform database samples are acquired

The application automatically displays the results as pass or fail. Select **Results** in the Execution pane and then click **Result Details** button to view the detailed results.

Distortion

***Note:** The TDS5000 series oscilloscopes are not recommended for 1000BASE-T Distortion test.*

1. Click **Tests > Select > 1000BASE-T** from the menu bar.
2. In the Jit/Distortion tab, select **Distortion**.

***Note:** The status bar displays the major configuration details. If you do not want to change the configuration settings, you can skip Step 3.*

3. To change the configuration settings, select **Tests > Configure** from the menu bar, or click the Configure button in the Selection pane.
4. In the Configuration window, select the following options:

Table 8-8: 1000BASE-T Distortion Configuration Options

Parameter	Options	To Do
Data	CH1, CH2, CH3, or CH4	Select the channel to which the DUT is connected.
# Averages	64 to 10000	Enter the number of waveforms you want to average.
Output	Ref1, Ref2, Ref3, or Ref4	Select the reference waveform on which the processed waveform will be stored.
Disturbing Signal	Yes or No	Select the options depending on whether the Disturbing signal is present or not.
TX_TCLK	CH1, CH2, CH3, or CH4	Select the channel to which the clock source is connected.
Hi Resolution	2 to 75	Enter the number of averages to be done in the vertical domain.
Low Pass Filter	Yes, No	Select Yes or No depending on whether the noise elimination filter is required.

5. Select **Tests > Connect** or Connect in the Selection pane and make connections.
6. Select View Wfm in the Selection pane, to view and compare the waveform with the acquired waveform.
7. If the disturbing signal is present and you have configured Disturbing Signal as Yes, and then click **Run Test**.
8. The application does the following:

- Displays a message box to confirm the overwrite of the reference waveform. Select **Yes** to continue.
- Checks whether the DUT is connected
- Sets the trigger

9. The application displays the following dialog box.

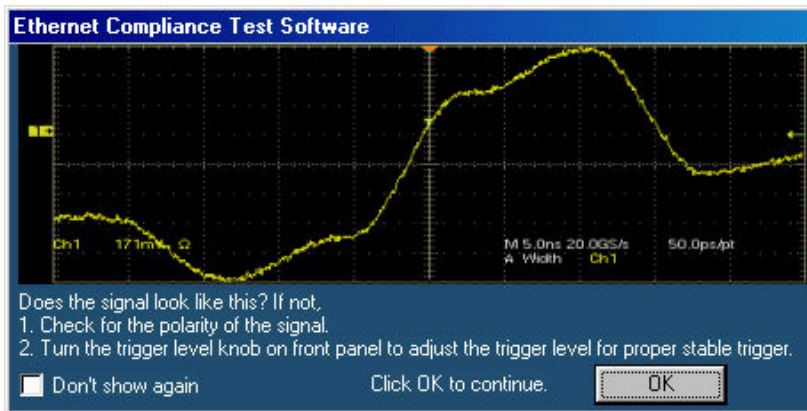

Figure 8-21: 1000BASE-T Distortion user control

Note: In TDS5000B series oscilloscopes, the horizontal scale is set to 10 ns.

- Check the polarity of the signal.
- If the trigger is not stable, adjust the trigger level for proper stable trigger. Then click **OK** to continue.

10. The application does the following:

- Acquires, filters, and removes the disturbing signal
- If TX_TCLK is set as Yes, The application samples the differential signal output with the symbol rate of selected TX_TCLK source at an arbitrary phase and processes a block of 2047 consecutive samples
If TX_TCLK is set as No, The application samples the differential signal output with the symbol rate with the estimated clock frequency at an arbitrary phase and processes a block of 2047 consecutive samples
- Displays the error plot on selected output (reference waveform)

11. If the disturbing signal is not present and you have configured Disturbing Signal as No, and then click Run Test. The application does the following:
 - Displays a message box to confirm the overwrite of the reference waveform. Select **Yes** to continue
 - Checks whether the DUT is connected
 - Sets the trigger
 - Acquires and filters the data
 - If TX_TCLK is set as Yes, The application samples the differential signal output with the symbol rate of selected TX_TCLK source at an arbitrary phase and processes a block of 2047 consecutive samples
 - If TX_TCLK is set as No, The application samples the differential signal output with the symbol rate with the estimated clock frequency at an arbitrary phase and processes a block of 2047 consecutive samples
 - Displays the error plot on selected output (reference waveform)

The following figure shows a typical error plot for Distortion.

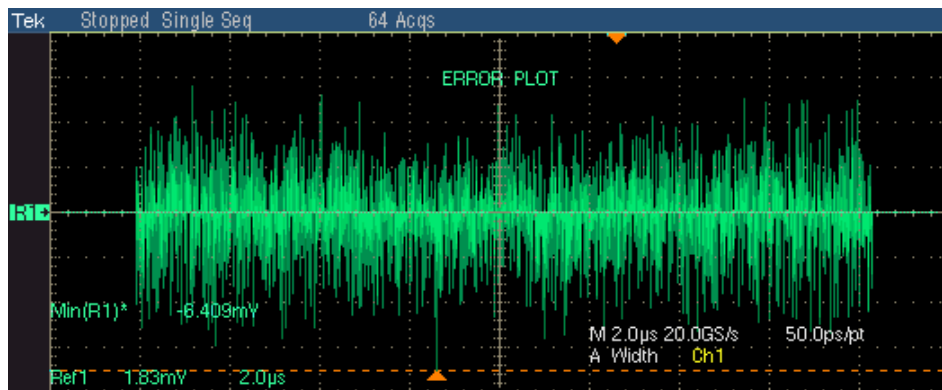

Figure 8-22: Waveform for 1000BASE-T Distortion

The application automatically displays the results as pass or fail. Select **Results** in the Execution pane and then click **Result Details** button to view the detailed results.

Return Loss

1. Click **Tests > Select > 1000BASE-T** from the menu bar.
2. In the Return Loss tab, select **Return Loss**.

Note: The status bar displays the major configuration details. If you do not want to change the configuration settings, you can skip Step 3.

3. To change the configuration settings, select **Tests > Configure** from the menu bar, or click the Configure button in the Selection pane.
4. In the Configuration window, select the following options:

Table 8-9: 1000BASE-T Return Loss Configuration Options

Parameter	Options	To Do
Sources P1/P3/P5/P7 P2/P4/P6/P8	CH1, CH2, CH3, or CH4 CH1, CH2, CH3, or CH4	Select the channel to which the DUT is connected.
Output Waveform Return Loss 0dB Marker	Ref1, Ref2, Ref3, or Ref4 Ref1, Ref2, Ref3, or Ref4	Select the reference waveform on which the output waveform will be stored. Select the reference waveform on which you want the 0dB Marker to be indicated. <i>Note: These fields appear only if you set Load as 100 ohm.</i>
Pair ID	A, B, C, D	Depending on the Pair ID selected the sources will change from P1/P3/P5/P7 and P2/P4/P6/P8.
Load	85, 100, 115 ohm or 100 ohm	Select the load as 85, 100, 111 ohm or 100 ohm.
#Averages	100 to 10000	Enter the number of waveforms you want to average.
Smooth	0 to 10	Enter the smoothening factor.
AWG Series	Select, AWG 4xx, AWG 2021, AWG 5xx, AWG 6xx, AWG 7xx	Select the AWG Series to use. If you select the default value–Select–then the application considers all AWGs other than the AWG 4xx series.

5. Select **Tests > Connect or Connect** in the Selection pane and make connections.

6. Calibrate the test setup. If you do not calibrate the test setup before running the test, an error message Error 412: Calibration Data Not Available appears.
7. Click **Run Test**. The application does the following:
 - Displays a message box to confirm the overwrite of the reference waveform. Select Yes to continue
 - Sets the trigger
 - Acquires, and computes the return loss
 - Displays the return loss curve on selected output (reference waveform)

If the test fails, the application captures the waveform, circles the hits and saves the information to the report. The application obtains the hits information only for the 100 ohm waveform.

The following figure shows a typical waveform for Return Loss.



Figure 8-23: Waveform for 1000BASE-T Return Loss

The application automatically displays the results as pass or fail. Select **Results** in the Execution pane and then click **Result Details** button to view the detailed results.

CM Voltage

1. Click Tests > Select > 1000BASE-T from the menu bar.
2. In the CM Voltage tab, select **CM Voltage**.

Note: The status bar displays the major configuration details. If you do not want to change the configuration settings, you can skip Step 3.

3. To change the configuration settings, select **Tests > Configure** from the menu bar, or click the Configure button in the Selection pane.
4. In the Configuration window, select the following options:

Table 8-10: 1000BASE-T CM Voltage Configuration Options

Parameter	Options	To Do
Data	CH1, CH2, CH3, or CH4	Select the channel to which the DUT is connected.

1.

5. Select Tests > Connect or Connect in the Selection pane and make connections.
6. Select View Wfm in the Selection pane, to view and compare the waveform with the acquired waveform.
7. Click Run Test. The application does the following:
 - Checks whether the DUT is connected and a valid signal is acquired
 - Sets the trigger
 - Measures the Output Voltage amplitude for positive and negative pulses of 96ns
 - Compares the values with the Standard
 - Displays the DUT waveform for Common mode Voltage testing

The following figure shows a typical waveform for Common mode Voltage.

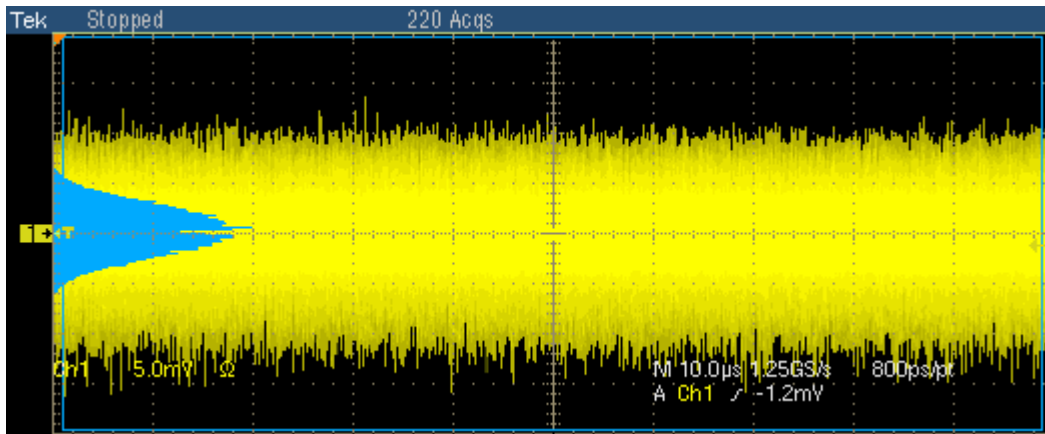

Figure 8-24: Waveform for 1000BASE-T Common mode Voltage

The application automatically displays the results as pass or fail. Select **Results** in the Execution pane and then click **Result Details** button to view the detailed results.

How To Test 100BASE-TX

Template

1. Click **Tests > Select > 100BASE-TX** from the menu bar.
2. In the Parametric tab, select **Output Volt**.
3. Select **Pos** for positive, **Neg** for negative, or **Both** in the Polarity drop-down list.

Note: The status bar displays the major configuration details. If you do not want to change the configuration settings, you can skip Step 3.

4. To change the configuration settings, select **Tests > Configure** from the menu bar, or click the Configure button in the Selection pane.
5. In the Configuration window, select the following options:

Table 9-1: 100BASE-TX Template Configuration Options

Parameter	Options	To Do
Data	CH1, CH2, CH3, or CH4	Select the channel to which the DUT is connected.
Acquisition	Sample or Average	Select the acquisition mode. If you select Average, # of Wfms appears. Enter the number of averages to test in the # of Wfms field.

6. Select **Tests > Connect** or Connect in the Selection pane and make connections.
7. Select View Wfm in the Selection pane, to view and compare the waveform with the acquired waveform.
8. Click **Run Test**. The application does the following:
 - Checks whether the DUT is connected and a valid signal is acquired
 - Sets up the Trigger
 - Loads the AOI template mask
 - Carries out the mask pass/fail test

If the test fails, the application captures the waveform, circles the hits and saves the information to the report.

The following figure shows a typical DUT waveform for AOI template test:

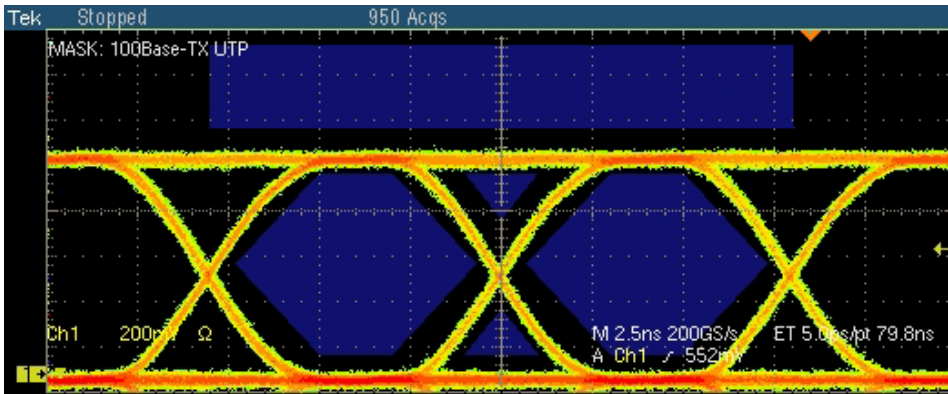

Figure 9-1: Waveform for 100BASE-TX Template for Positive polarity

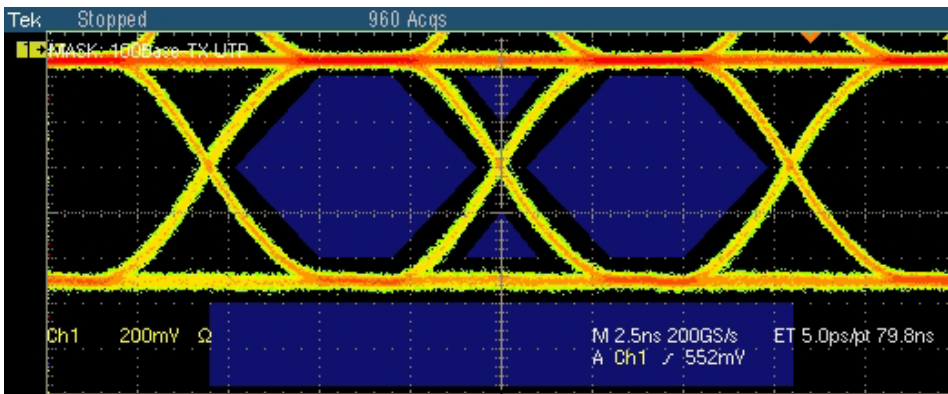

Figure 9-2: Waveform for 100BASE-TX Template for Negative polarity

The application also tests for mask and displays the results as pass or fail.

If the acquired waveform does not lie within the mask, click Manual Fit. To adjust the waveform to fit into the Mask, change the horizontal position and vertical position using the general purpose knobs or Virtual Keyboard. This repeats the mask pass/fail test and displays the results in the **Results Summary** pane.

The application automatically displays the results as pass or fail. Select **Results** in the Execution pane and then click **Result Details** button to view the detailed results.

Differential Output Voltage

1. Click Tests > Select > 100BASE-TX from the menu bar.
2. In the Parametric tab, select **Output Volt**.
3. Select **Pos** for positive, **Neg** for negative, or **Both** in the Polarity drop-down list.

Note: The status bar displays the major configuration details. If you do not want to change the configuration settings, you can skip Step 3.

4. To change the configuration settings, select **Tests > Configure** from the menu bar, or click the Configure button in the Selection pane.
5. In the Configuration window, select the following options:

Table 9-2: 100BASE-TX Differential Output Voltage Configuration Options

Parameter	Options	To Do
Data	CH1, CH2, CH3, or CH4	Select the channel to which the DUT is connected.
Acquisition	Sample or Average	Select the acquisition mode. If you select Average, # of Wfms appears. Enter the number of averages to test in the # of Wfms field.

6. Select Tests > Connect or Connect in the Selection pane and make connections.
7. Select View Wfm in the Selection pane, to view and compare the waveform with the acquired waveform.
8. Click Run Test. The application does the following:
 - Checks whether the DUT is connected and a valid signal is acquired
 - Sets up the Trigger
 - Measures the Output Voltage amplitude for positive and negative pulses of 96ns
 - Compares the values with the Standard

9. The following figure shows a typical waveform of Differential Output Voltage test for positive pulse:

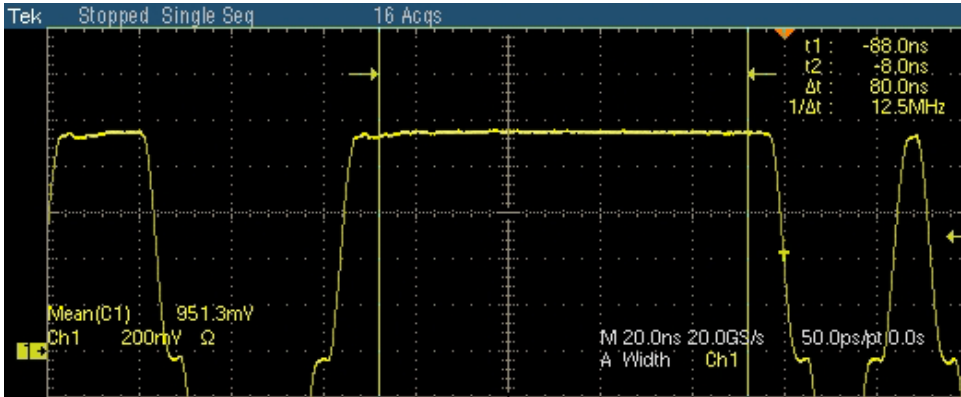

Figure 9-3: Waveform for 100BASE-TX Differential Output Voltage for Positive polarity

10. The following figure shows a typical waveform of Differential Output Voltage test for negative pulse:

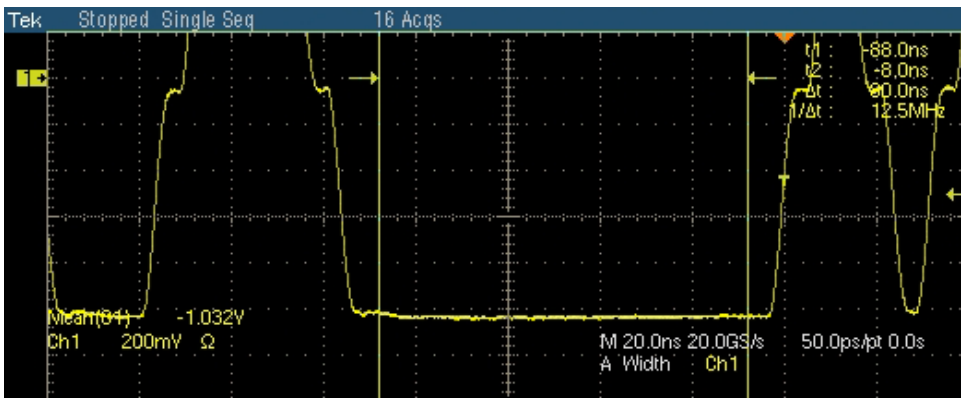

Figure 9-4: Waveform for 100BASE-TX Differential Output Voltage for Negative polarity

The application automatically displays the results as pass or fail. Select **Results** in the Execution pane and then click **Result Details** button to view the detailed results.

Signal Amplitude Symmetry

1. Click **Tests > Select > 100BASE-TX** from the menu bar.
2. In the Parametric tab, select **Amp Sym**.

Note: The status bar displays the major configuration details. If you do not want to change the configuration settings, you can skip Step 3.

3. To change the configuration settings, select **Tests > Configure** from the menu bar, or click the Configure button in the Selection pane.
4. In the Configuration window, select the following options:

Table 9-3: 100BASE-TX Amplitude Symmetry Configuration Options

Parameter	Options	To Do
Data	CH1, CH2, CH3, or CH4	Select the channel to which the DUT is connected.
Acquisition	Sample or Average	Select the acquisition mode. If you select Average, # of Wfms appears. Enter the number of averages to test in the # of Wfms field.

5. Select **Tests > Connect** or Connect in the Selection pane and make connections.
6. Select View Wfm in the Selection pane, to view and compare the waveform with the acquired waveform.
7. Click Run Test. The application does the following:
 - Checks whether the DUT is connected and a valid signal is acquired
 - Sets up the Trigger
 - Measures the Output Voltage amplitude for positive and negative pulses of 96ns
 - Calculates the Amplitude symmetry
 - Compares the values with the Standard

The following figure shows a typical waveform of Signal Amplitude Symmetry test.

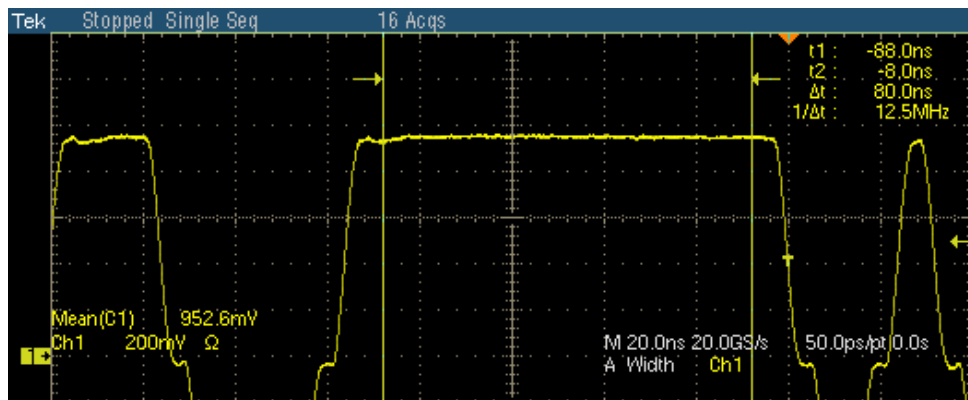

Figure 9-5: Waveform for 100BASE-TX Amplitude Symmetry for Positive polarity

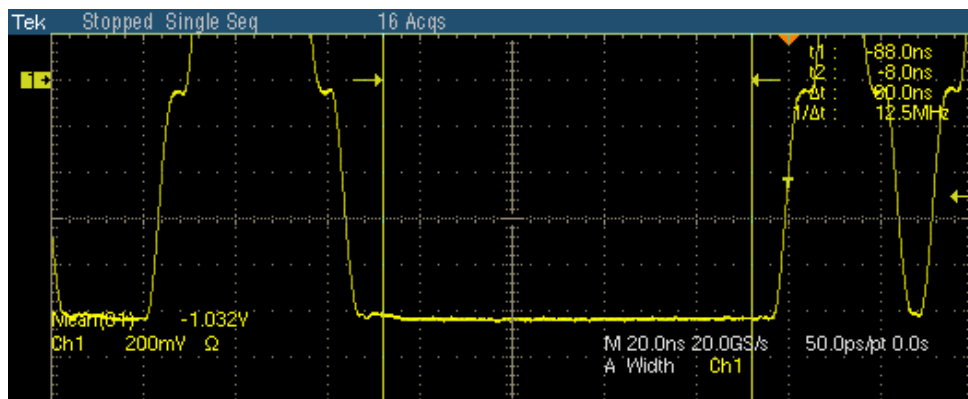

Figure 9-6: Waveform for 100BASE-TX Amplitude Symmetry for Negative polarity

The application automatically displays the results as pass or fail. Select **Results** in the Execution pane and then click **Result Details** button to view the detailed results.

Rise Time

1. Click **Tests > Select > 100BASE-TX** from the menu bar.
2. In the Parametric tab, select **Rise Time**.
3. Select **Pos** for positive, **Neg** for negative, or **Both** in the Polarity drop-down list.

Note: The status bar displays the major configuration details. If you do not want to change the configuration settings, you can skip Step 3.

4. To change the configuration settings, select **Tests > Configure** from the menu bar, or click the Configure button in the Selection pane.
5. In the Configuration window, select the following options:

Table 9-4: 100BASE-TX Rise Time Configuration Options

Parameter	Options	To Do
Data	CH1, CH2, CH3, or CH4	Select the channel to which the DUT is connected.
Acquisition	Sample or Average	Select the acquisition mode. If you select Average, # of Wfms appears. Enter the number of averages to test in the # of Wfms field.
Pulse Width	16ns or 80ns	Set Pulse Width to 16ns or 80ns.

6. Select **Tests > Connect** or Connect in the Selection pane and make connections.
7. Select View Wfm in the Selection pane, to view and compare the waveform with the acquired waveform.
8. Click **Run Test**. The application does the following:
 - Checks whether the DUT is connected and a valid signal is acquired
 - Sets up the Trigger
 - Measures the rise time of the positive and negative pulses of the configured pulse width
 - Compares the values with the Standard

The following figure shows a typical waveform of Rise Time test.

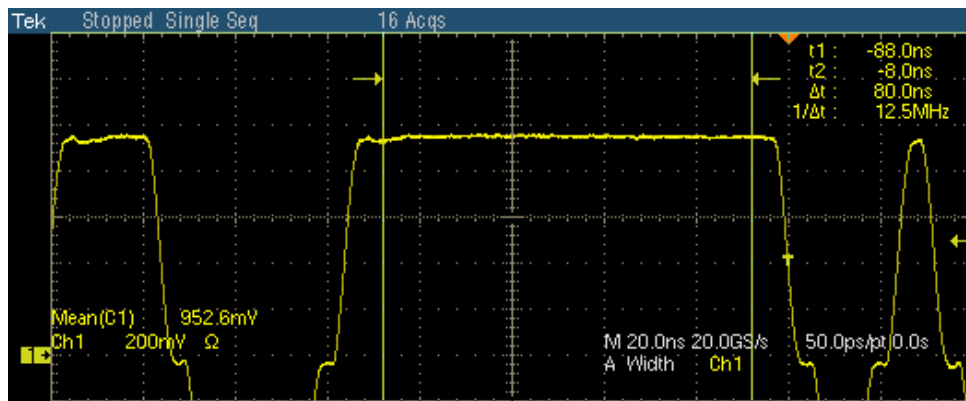

Figure 9-7: Waveform for 100BASE-TX Rise Time for Positive polarity

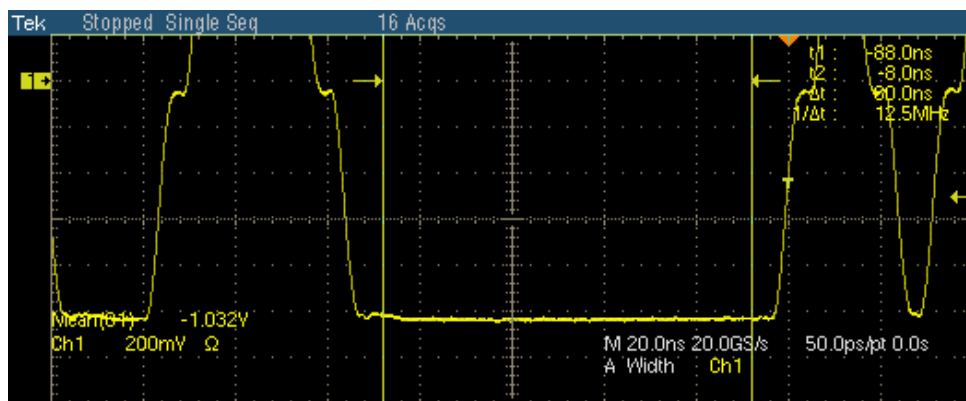

Figure 9-8: Waveform for 100BASE-TX Rise Time for Negative polarity

The application automatically displays the results as pass or fail. Select **Results** in the Execution pane and then click **Result Details** button to view the detailed results.

Fall Time

1. Click **Tests > Select > 100BASE-TX** from the menu bar.
2. In the Parametric tab, select **Fall Time**.
3. Select **Pos** for positive, **Neg** for negative, or **Both** in the Polarity drop-down list.

Note: The status bar displays the major configuration details. If you do not want to change the configuration settings, you can skip Step 3.

4. To change the configuration settings, select **Tests > Configure** from the menu bar, or click the Configure button in the Selection pane.
5. In the Configuration window, select the following options:

Table 9-5: 100BASE-TX Fall Time Configuration Options

Parameter	Options	To Do
Data	CH1, CH2, CH3, or CH4	Select the channel to which the DUT is connected.
Acquisition	Sample or Average	Select the acquisition mode. If you select Average, # of Wfms appears. Enter the number of averages to test in the # of Wfms field.
Pulse Width	16ns or 80ns	Set Pulse Width to 16ns or 80ns.

6. Select **Tests > Connect** or Connect in the Selection pane and make connections.
7. Select View Wfm in the Selection pane, to view and compare the waveform with the acquired waveform.
8. Click **Run Test**. The application does the following:
 - Checks whether the DUT is connected and a valid signal is acquired
 - Sets up the Trigger
 - Measures the fall time of the positive and negative pulses of the configured pulse width
 - Compares the values with the Standard

The following figure shows a typical waveform of Fall Time test.

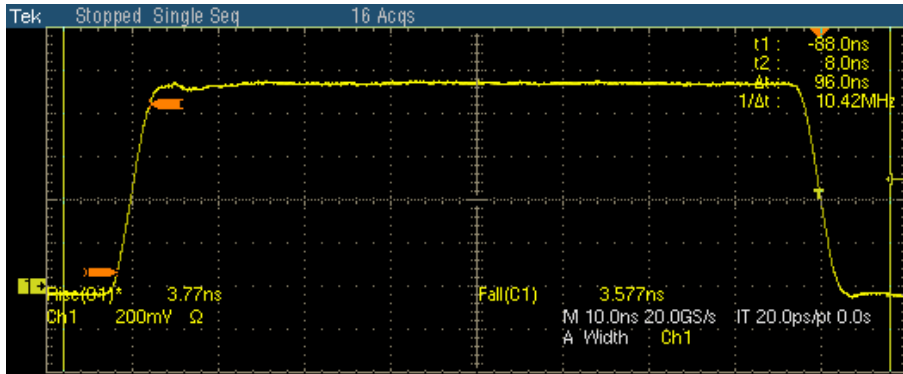

Figure 9-9: Waveform for 100BASE-TX Fall Time for Positive polarity

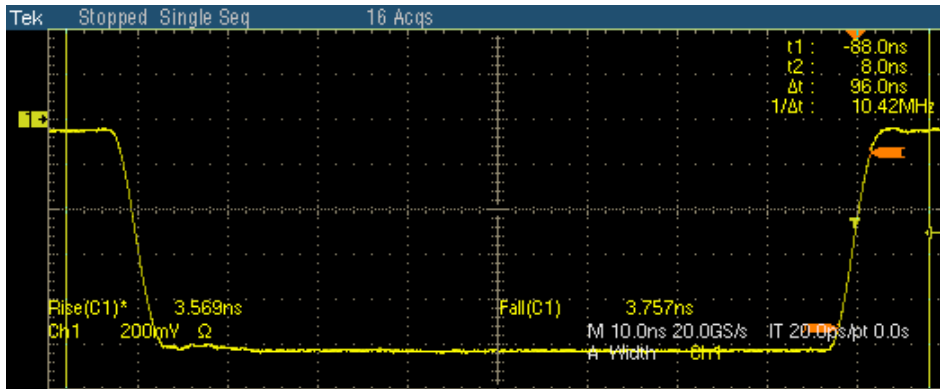

Figure 9-10: Waveform for 100BASE-TX Fall Time for Negative polarity

The application automatically displays the results as pass or fail. Select **Results** in the Execution pane and then click **Result Details** button to view the detailed results.

Rise/Fall Time Symmetry

1. Click **Tests > Select > 100BASE-TX** from the menu bar.
2. In the Parametric tab, select **R/F Sym**.
3. Select **Pos** for positive, **Neg** for negative, or **Both** in the Polarity drop-down list.

Note: The status bar displays the major configuration details. If you do not want to change the configuration settings, you can skip Step 3.

4. To change the configuration settings, select **Tests > Configure** from the menu bar, or click the Configure button in the Selection pane.
5. In the Configuration window, select the following options:

Table 9-6: 100BASE-TX Rise/Fall Time Symmetry Configuration Options

Parameter	Options	To Do
Data	CH1, CH2, CH3, or CH4	Select the channel to which the DUT is connected.
Acquisition	Sample or Average	Select the acquisition mode. If you select Average, # of Wfms appears. Enter the number of averages to test in the # of Wfms field.
Pulse Width	16ns or 80ns	Set Pulse Width to 16ns or 80ns.

6. Select **Tests > Connect** or Connect in the Selection pane and make connections.
7. Select View Wfm in the Selection pane, to view and compare the waveform with the acquired waveform.
8. Click **Run Test**. The application does the following:
 - Checks whether the DUT is connected and a valid signal is acquired
 - Sets up the Trigger
 - Measures the rise and fall time for the configured pulse width
 - Calculates the Rise/Fall Time Symmetry
 - Compares the values with the Standard

The following figure shows a typical waveform of Rise/Fall Time Symmetry test.

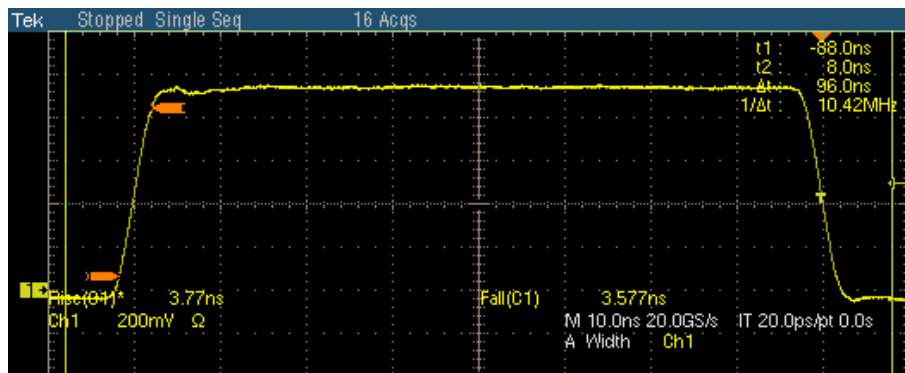

Figure 9-11: Waveform for 100BASE-TX Rise/Fall Time Symmetry for Positive polarity

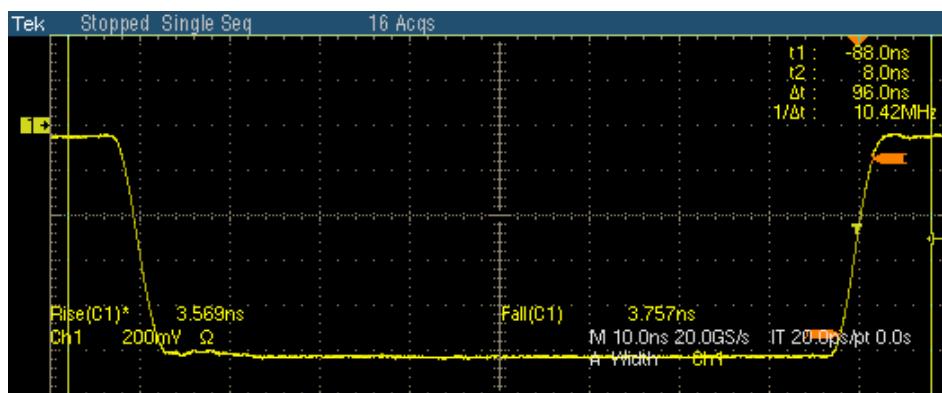

Figure 9-12: Waveform for 100BASE-TX Rise/Fall Time Symmetry for Negative polarity

The application automatically displays the results as pass or fail. Select **Results** in the Execution pane and then click **Result Details** button to view the detailed results.

Waveform Overshoot

1. Click **Tests > Select > 100BASE-TX** from the menu bar.
2. In the Parametric tab, select **Overshoot**.
3. Select **Pos** for positive, **Neg** for negative, or **Both** in the Polarity drop-down list.

Note: The status bar displays the major configuration details. If you do not want to change the configuration settings, you can skip Step 3.

4. To change the configuration settings, select **Tests > Configure** from the menu bar, or click the Configure button in the Selection pane.
5. In the Configuration window, select the following options:

Table 9-7: 100BASE-TX Waveform Overshoot Configuration Options

Parameter	Options	To Do
Data	CH1, CH2, CH3, or CH4	Select the channel to which the DUT is connected.
Acquisition	Sample or Average	Select the acquisition mode. If you select Average, # of Wfms appears. Enter the number of averages to test in the <i># of Wfms</i> field.

6. Select **Tests > Connect** or Connect in the Selection pane and make connections.
7. Select View Wfm in the Selection pane, to view and compare the waveform with the acquired waveform.
8. Click **Run Test**. The application does the following:
 - Checks whether the DUT is connected and a valid signal is acquired
 - Sets up the Trigger
 - Measures the Overshoot for positive and negative pulses of 96ns
 - Compares the values with the Standard

The following figure shows a typical waveform of Waveform Overshoot test.

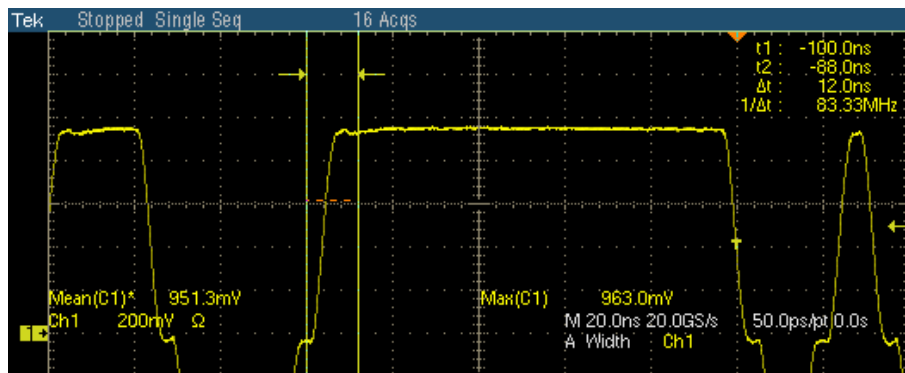

Figure 9-13: Waveform for 100BASE-TX Waveform Overshoot for Positive polarity

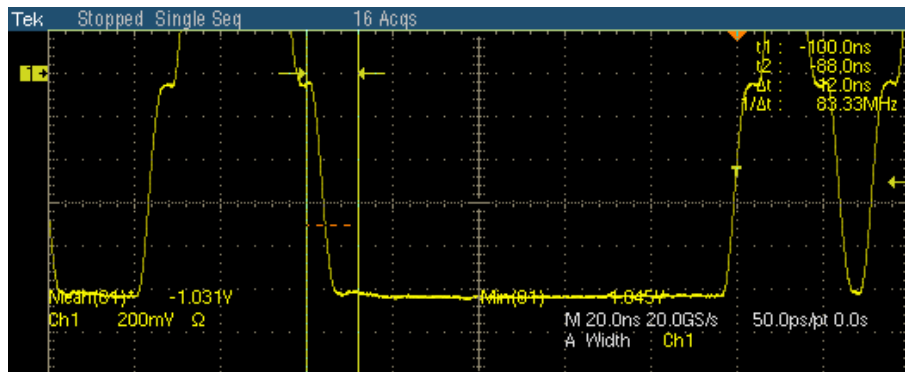

Figure 9-14: Waveform for 100BASE-TX Waveform Overshoot for Negative polarity

The application automatically displays the results as pass or fail. Select **Results** in the Execution pane and then click **Result Details** button to view the detailed results.

Jitter

1. Click **Tests > Select > 100BASE-TX** from the menu bar.
2. In the Parametric tab, select **Jitter**.

Note: The status bar displays the major configuration details. If you do not want to change the configuration settings, you can skip Step 3.

3. To change the configuration settings, select **Tests > Configure** from the menu bar, or click the Configure button in the Selection pane.

- In the Configuration window, select the following options:

Table 9-8: 100BASE-TX Jitter Configuration Options

Parameter	Options	To Do
Data	CH1, CH2, CH3, or CH4	Select the channel to which the DUT is connected.

- Select **Tests > Connect** or Connect in the Selection pane and make connections.
- Select View Wfm in the Selection pane, to view and compare the waveform with the acquired waveform.
- Click **Run Test**. The application does the following:
 - Checks whether the DUT is connected and a valid signal is acquired
 - Sets up the Trigger
 - Acquires the signal
 - Places a horizontal histogram at the crossing
 - Reads the peak-to-peak jitter from the histogram
 - Compares the values with the Standard

The following figure shows a typical waveform of Jitter test.

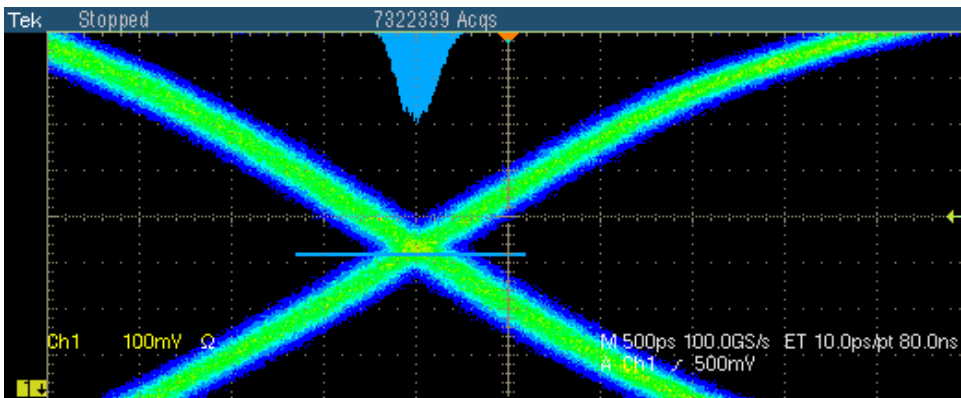

Figure 9-15: Waveform for 100BASE-TX Jitter for Positive polarity

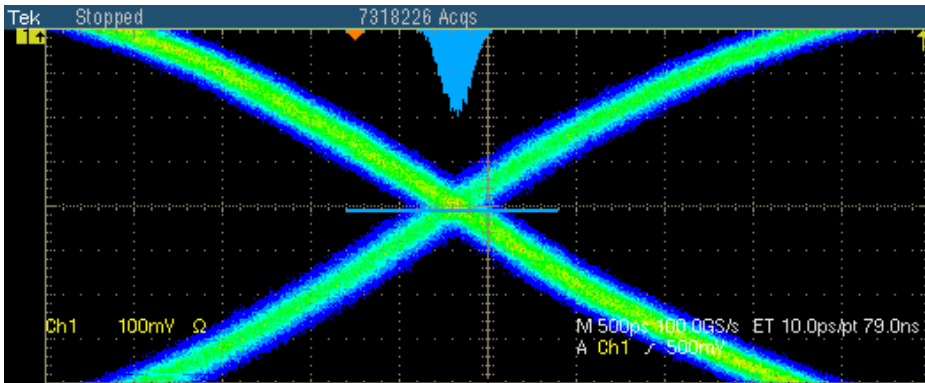

Figure 9-16: Waveform for 100BASE-TX Jitter for Negative polarity

The application automatically displays the results as pass or fail. Select **Results** in the Execution pane and then click **Result Details** button to view the detailed results.

Duty Cycle Distortion

1. Click **Tests > Select > 100BASE-TX** from the menu bar.
2. In the Parametric tab, select **Distortion**.
3. Select **Random** or **0101** in the Pattern drop-down list.

***Note:** The status bar displays the major configuration details. If you do not want to change the configuration settings, you can skip Step 3.*

4. To change the configuration settings, select **Tests > Configure** from the menu bar, or click the Configure button in the Selection pane.
5. In the Configuration window, select the following options:

Table 9-9: 100BASE-TX Distortion Configuration Options

Parameter	Options	To Do
Data	CH1, CH2, CH3, or CH4	Select the channel to which the DUT is connected.
Acquisition	Sample or Average	Select the acquisition mode. If you select Average, # of Wfms appears. Enter the number of waveforms to test in the # of Wfms field.

6. Select **Tests > Connect** or Connect in the Selection pane and make connections.

7. Select View Wfm in the Selection pane, to view and compare the waveform with the acquired waveform.
8. Click **Run Test**. The application does the following:
 - Checks whether the DUT is connected and a valid signal is acquired
 - Sets up the Trigger
 - Calculates the duty cycle distortion
 - Compares the values with the Standard

The following figure shows a typical waveform of Distortion test.

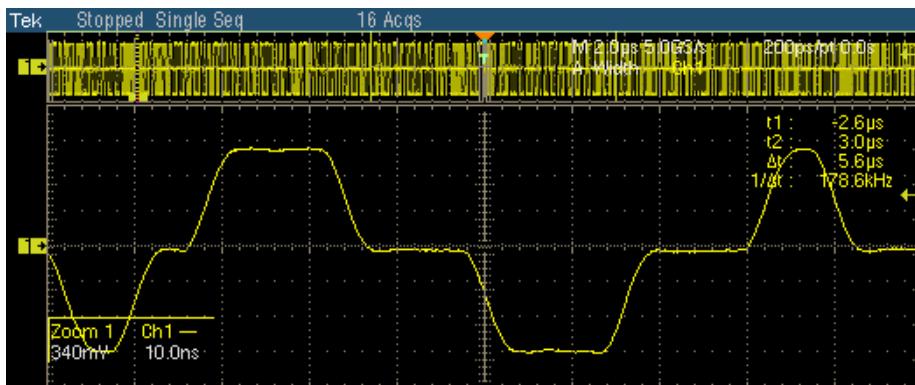

Figure 9-17: Waveform for 100BASE-TX Distortion

The application automatically displays the results as pass or fail. Select **Results** in the Execution pane and then click **Result Details** button to view the detailed results.

Return Loss

1. Click **Tests > Select > 100BASE-TX** from the menu bar.
2. In the Return Loss tab, select **Transmitter** or **Receiver**.

Note: The status bar displays the major configuration details. If you do not want to change the configuration settings, you can skip Step 3.

3. To change the configuration settings, select **Tests > Configure** from the menu bar, or click the Configure button in the Selection pane.
4. In the Configuration window, select the following options:

Table 9-10: 100BASE-TX Return Loss Configuration Options

Parameter	Options	To Do
Sources P1/P3 P2/P4	CH1, CH2, CH3, or CH4 CH1, CH2, CH3, or CH4	Select the channel to which the DUT is connected. <i>Note: Depending on whether the Transmitter or Receiver is selected, the sources will change from P1/P3 and P2/P4.</i>
Output Waveform Return Loss 0dB Marker	Ref1, Ref2, Ref3, or Ref4 Ref1, Ref2, Ref3, or Ref4	Select the reference waveform on which the output waveform will be stored. Select the reference waveform on which you want the 0dB Marker to be indicated. <i>Note: These fields appear only if you set Load as 100 ohm.</i>
Pair ID	A, B, C, D	Depending on the Pair ID selected the sources will change from P1/P3/P5/P7 and P2/P4/P6/P8.
Load	85, 100, 115 ohm or 100 ohm	Select the load as 85, 100, 111 ohm or 100 ohm.
AWG Series	Select, AWG 4xx, AWG 2021, AWG 5xx, AWG 6xx, AWG 7xx	Select the AWG Series to use. If you select the default value–Select–then the application considers all AWGs other than the AWG 4xx series.
#Averages	100 to 10000	Enter the number of waveforms you want to average.
Smooth	0 to 10	Enter the smoothing factor.

5. Select **Tests > Connect** or **Connect** in the Selection pane and make connections.
6. Select **View Wfm** in the Selection pane, to view and compare the waveform with the acquired waveform.
7. Click Run Test. The application does the following:
 - Displays a message box to confirm the overwrite of the reference waveform. Select Yes to continue
 - Sets up the Trigger
 - Acquires, and computes the return loss

- Displays the return loss curve on selected output (reference waveform)

If the test fails, the application captures the waveform, circles the hits and saves the information to the report. The application obtains the hits information only for the 100 ohm waveform.

The following figure shows a typical waveform for Return Loss Transmitter.



Figure 9-18: Waveform for 100BASE-TX Return Loss Transmitter

The following figure shows a typical waveform for Return Loss Receiver.



Figure 9-19: Waveform for 100BASE-TX Return Loss Receiver

The application automatically displays the results as pass or fail. Select **Results** in the Execution pane and then click **Result Details** button to view the detailed results.

How To Test 10BASE-T

MAU

1. Click **Tests > Select > 10BASE-T** from the menu bar.
2. In the Template tab, select **MAU**. In the adjacent drop-down list, select **Normal, Inverted, or Both**.

Note1: The status bar displays the major configuration details. If you do not want to change the configuration settings, you can skip Step 3.

Note2: If you select Both and if the test fails, then Locate hits and Flash hits display the MAU Inverted failures.

3. To change the configuration settings, select **Tests > Configure** from the menu bar, or click the Configure button in the Selection pane.
4. In the Configuration window, select the following options:

Table 10-1: 10BASE-T MAU Configuration Options

Parameter	Options	To Do
Data	CH1, CH2, CH3, or CH4	Select the channel to which the DUT is connected.
MAU Type	Internal, or External	Select the MAU Type.
MAU Scale	Normal, 0.9, 1.1	Select the MAU scale factor.
Mask Setup	Samples and Fail Thresh	Select the number of samples, and the number of samples for fail thresh.
Report Setup	Device ID, Device Description, and Report File	Configure the options to identify the report. You can also choose to automatically preview a file.

5. Select **Tests > Connect** or **Connect** in the Selection pane and make connections.
6. Select **View Wfm** in the Selection pane, to view and compare the waveform with the acquired waveform.
7. Click **Run Test**. The application does the following:
 - Checks whether the DUT is connected and a valid signal is acquired
 - Validates the DUT for noise and loads the mask
 - Sets up the Vertical, Horizontal, and Trigger oscilloscope parameters

The application displays the following dialog box:



Figure 10-1: 10BASE-T Template user control dialog box

- Toggle **Lock Mask to Wfm** between ON and OFF to lock or unlock the mask to waveform when you zoom in or zoom out.
- Toggle **Mask Autofit** between ON and OFF to allow the oscilloscope to automatically fit the waveform to mask.
- Click **OK** to continue.

The application then carries out the mask pass/fail test.

Note: The application introduces a gap in the mask where segments 1 and 5 merge.

If the test fails, the application captures the waveform, circles the hits and saves the information to the report.

The following figure shows a typical DUT waveform for Template testing of MAU Ext:

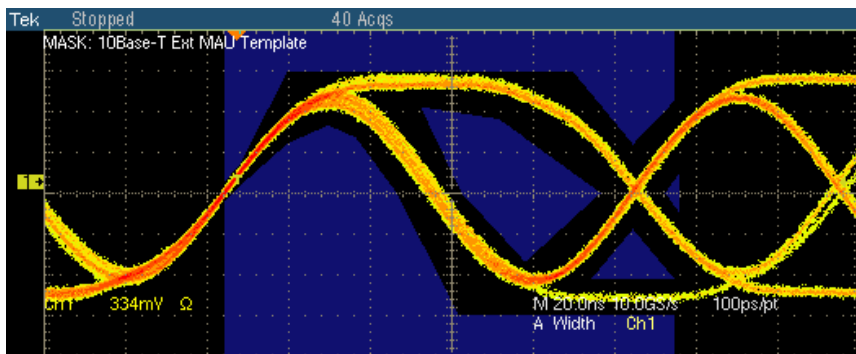

Figure 10-2: Waveform for 10BASE-T MAU Ext

The following figure shows a typical DUT waveform for Template testing of MAU Ext Inv:

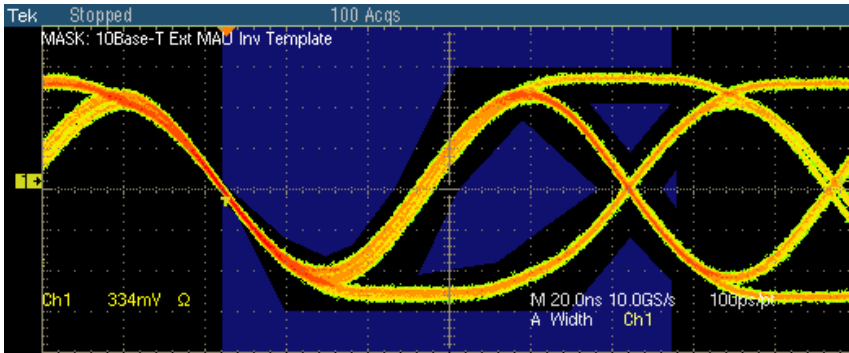

Figure 10-3: Waveform for 10BASE-T MAU Ext Inv

The following figure shows a typical DUT waveform for Template testing of MAU Int:

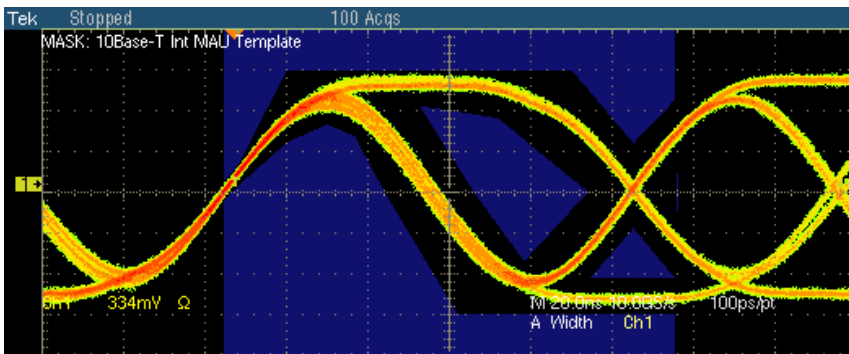

Figure 10-4: Waveform for 10BASE-T MAU Int

The following figure shows a typical DUT waveform for Template testing of MAU Int Inv:

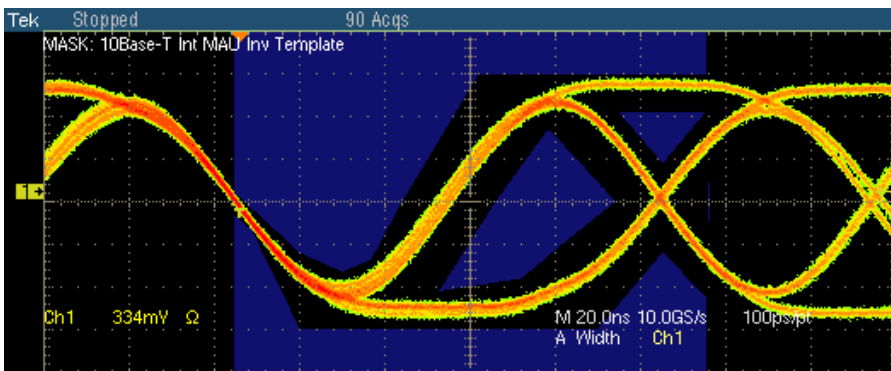

Figure 10-5: Waveform for 10BASE-T MAU Int Inv

If the acquired waveform does not lie within the mask, click **Manual Fit**. To adjust the waveform to fit into the Mask, change the horizontal position and vertical position using the general-purpose knobs or Virtual Keyboard. This repeats the mask pass/fail test and displays the results in the **Results Summary** pane.

The application automatically displays the results as pass or fail. Select **Results** in the Execution pane and then click **Result Details** button to view the detailed results.

Link Pulse

1. Click **Tests > Select > 10BASE-T** from the menu bar.
2. In the Template tab, select **Link Pulse**.
3. In the adjacent drop-down list, select the load with or without TPM — **Load1 w/o TPM, Load2 w/o TPM, 100 Ω w/o TPM, Load1 with TPM, Load2 with TPM, or 100 Ω with TPM**.

Note: The status bar displays the major configuration details. If you do not want to change the configuration settings, you can skip Step 3.

4. To change the configuration settings, select **Tests > Configure** from the menu bar, or click the **Configure** button in the Selection pane.
5. In the Configuration window, select the following options:

Table 10-2: 10BASE-T Link Pulse Configuration Options

Parameter	Options	To Do
Data	CH1, CH2, CH3, or CH4	Select the channel to which the DUT is connected.
Acquisition	Sample or Average	Select the acquisition mode. If you select Average, # of Wfms appears. Enter the number of waveforms to test in the # of Wfms field.
Section	Both, Head, or Tail	Select the section of mask to test. <i>Note: If you select Both and if the test fails, then Locate hits and Flash hits display the Tail section failures.</i>

Table 10-2: 10BASE-T Link Pulse Configuration Options

Mask Setup	# of Wfms and Fail Thresh	Select the number of waveforms to be tested and the number of waveforms that must fail for the test to fail.
Sequence	Normal (NLP), Fast (FLP)	Select the type of link pulse you want to test.
Test Options	Both, Template Only, Timing Only	Select Both to perform Template and Timing tests, Template Only to perform Template tests, and Timing Only to perform Timing tests. Timing tests are available for normal link pulse.

6. Select **Tests > Connect** or **Connect** in the Selection pane and make connections.
7. Select **View Wfm** in the Selection pane, to view and compare the waveform with the acquired waveform.
8. Click **Run Test**. The application does the following:
 - Checks whether the DUT is connected and a valid signal is acquired
 - Sets up the signal
 - Loads the front portion of the mask
9. The application displays the following dialog box.

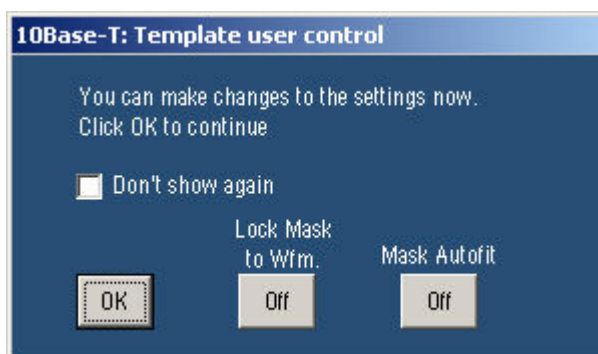
**Figure 10-6: 10BASE-T Template user control dialog box**

- Toggle **Lock Mask to Wfm** between ON and OFF to lock or unlock the mask to waveform when you zoom in or zoom out.
- Toggle **Mask Autofit** between ON and OFF to allow the oscilloscope to automatically fit the waveform to mask.
- Click **OK** to continue.

10. The application then carries out the mask pass/fail test.

Note: *If you have selected the Section as Both, the application sets up the signal and loads the front portion of the mask for the Head. Then, the application sets up the signal and loads the tail portion of the mask. The application adds the pass/fail result of both Head and Tail.*

If the test fails, the application captures the waveform, circles the hits and saves the information to the report.

The following figure shows a typical DUT waveform for Link Pulse Timing test:

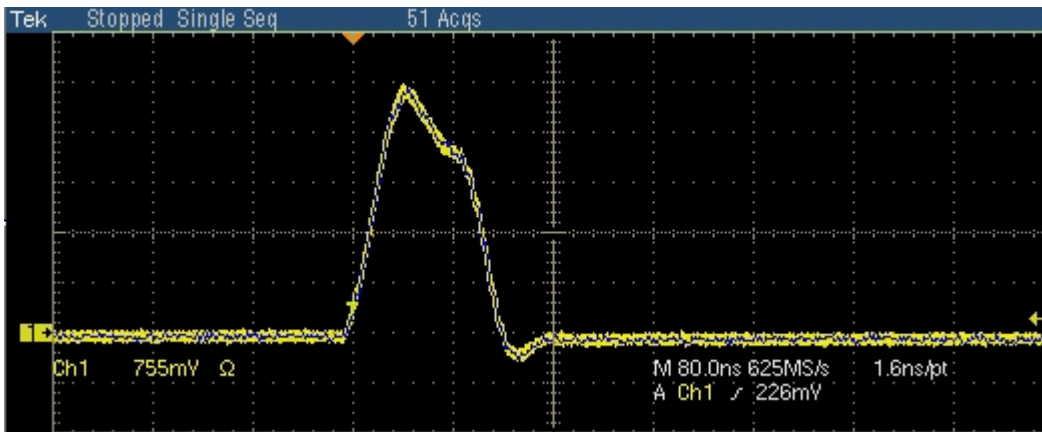

Figure 10-7: Waveform for 10BASE-T Link Pulse Timing

The following figure shows a typical DUT waveform for Template testing of Link Pulse:

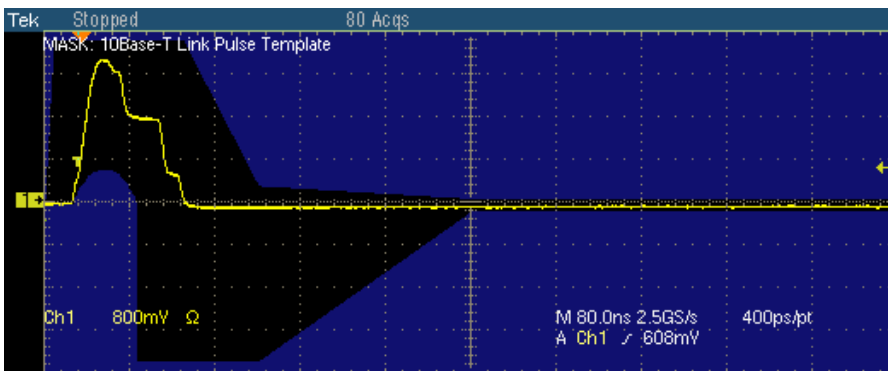

Figure 10-8: Waveform for 10BASE-T Link Pulse Head

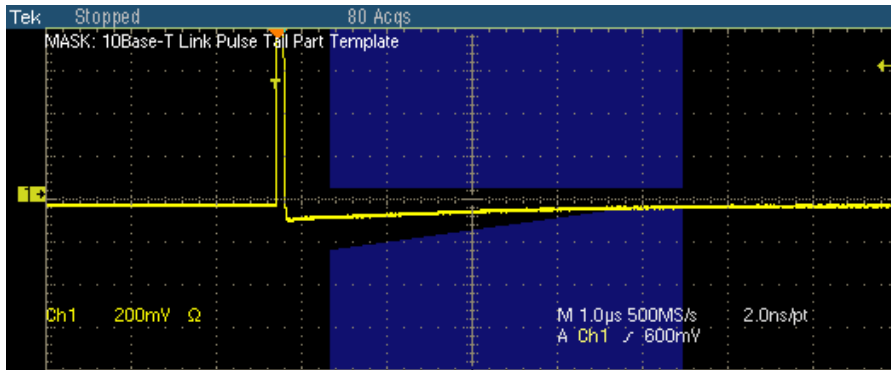

Figure 10-9: Waveform for 10BASE-T Link Pulse Tail

If the acquired waveform does not lie within the mask, click **Manual Fit**. To adjust the waveform to fit into the Mask, change the horizontal position and vertical position using the general purpose knobs or Virtual Keyboard. This repeats the mask pass/fail test and displays the results in the **Results Summary** pane.

The application automatically displays the results as pass or fail. Select **Results** in the Execution pane and then click **Result Details** button to view the detailed results.

Note: Link Pulse Timing test is not available in TDS6604 and TDS6804 oscilloscopes.

TP_IDL

1. Click **Tests > Select > 10BASE-T** from the menu bar.
2. In the Template tab, select **TP_IDL**.
3. In the adjacent drop-down list, select the load with or without TPM — **Load1 w/o TPM, Load2 w/o TPM, 100 Ω w/o TPM, Load1 with TPM, Load2 with TPM, or 100 Ω with TPM**

Note: The status bar displays the major configuration details. If you do not want to change the configuration settings, you can skip Step 3.

4. To change the configuration settings, select Tests > Configure from the menu bar, or click the Configure button in the Selection pane. In the Configuration window, select the following options:

Table 10-3: 10BASE-T TP_IDL Configuration Options

Parameter	Options	To Do
Data	CH1, CH2, CH3, or CH4	Select the channel to which the DUT is connected.
Acquisition	Sample or Average	Select the acquisition mode. If you select Average, # of Wfms appears. Enter the number of waveforms to test in the <i># of Wfms</i> field.
Section	Both, Head, or Tail	Select the section of mask to test. <i>Note: If you select Both and if the test fails, then Locate hits and Flash hits display the Tail section failures.</i>
Mask Setup	# of Wfms and Fail Thresh	Select the number of waveforms to be tested and the number of waveforms that must fail for the test to fail.

5. Select **Tests > Connect** or **Connect** in the Selection pane and make connections.
6. Select **View Wfm** in the Selection pane, to view and compare the waveform with the acquired waveform.
7. Click **Run Test**. The application does the following:
 - Checks whether the DUT is connected and a valid signal is acquired
 - Sets up the signal
 - Loads the front portion of the mask

8. The application displays the following dialog box.



Figure 10-10: 10BASE-T Template user control dialog box

- Toggle **Lock Mask to Wfm** between ON and OFF to lock or unlock the mask to waveform when you zoom in or zoom out.
- Toggle **Mask Autofit** between ON and OFF to allow the oscilloscope to automatically fit the waveform to mask.
- Click **OK** to continue.

9. The application then carries out the mask pass/fail test.

Note: If you have selected the Section as Both, the application sets up the signal and loads the front portion of the mask for the Head. Then, the application sets up the signal and loads the tail portion of the mask. The application adds the pass/fail result of both Head and Tail.

If the test fails, the application captures the waveform, circles the hits and saves the information to the report.

The following figure shows a typical DUT waveform for Template testing of TP_IDL:

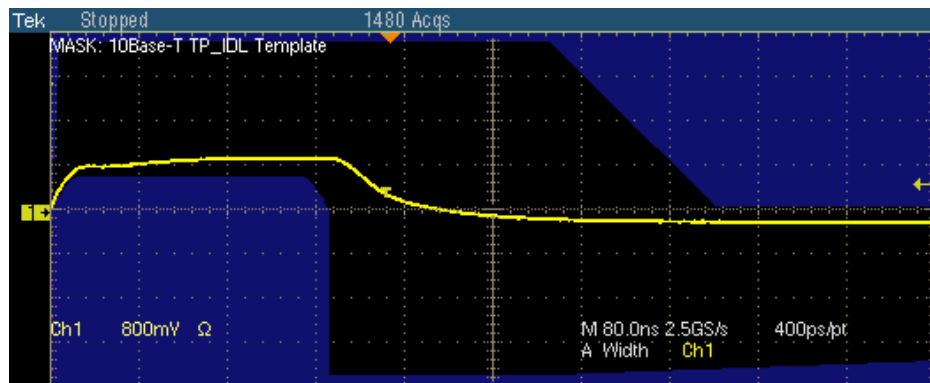

Figure 10-11: Waveform for 10BASE-T TP_IDL Head

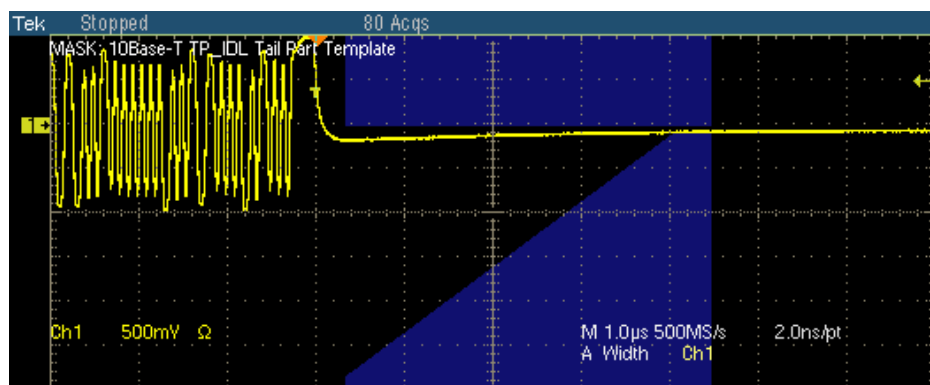

Figure 10-12: Waveform for 10BASE-T TP_IDL Tail

If the acquired waveform does not lie within the mask, click **Manual Fit**. To adjust the waveform to fit into the Mask, change the horizontal position and vertical position using the general purpose knobs or Virtual Keyboard. This repeats the mask pass/fail test and displays the results in the **Results Summary** pane.

The application automatically displays the results as pass or fail. Select **Results** in the Execution pane and then click **Result Details** button to view the detailed results.

Differential Voltage

1. Click Tests > Select > 10BASE-T from the menu bar.
2. In the Parametric tab, select Diff Volt. From the Peak drop-down list, select the peak value as Max or Min Max.

Note: The status bar displays the major configuration details. If you do not want to change the configuration settings, you can skip Step 3.

3. To change the configuration settings, select Tests > Configure from the menu bar, or click the Configure button in the Selection pane.
4. In the Configuration window, select the following options:

Table 10-4: 10BASE-T Differential Voltage Configuration Options

Parameter	Options	To Do
Data	CH1, CH2, CH3, or CH4	Select the channel to which the DUT is connected.

5. Select **Tests > Connect** or **Connect** in the Selection pane and make connections.
6. Select **View Wfm** in the Selection pane, to view and compare the waveform with the acquired waveform.
7. Click **Run Test**. The application does the following:
 - Checks whether the DUT is connected and a valid signal is acquired
 - Sets up the Vertical, Horizontal, Trigger oscilloscope parameters
 - Measures the maximum and minimum voltages on the waveform
8. The following figure shows a typical DUT waveform for Differential Voltage:

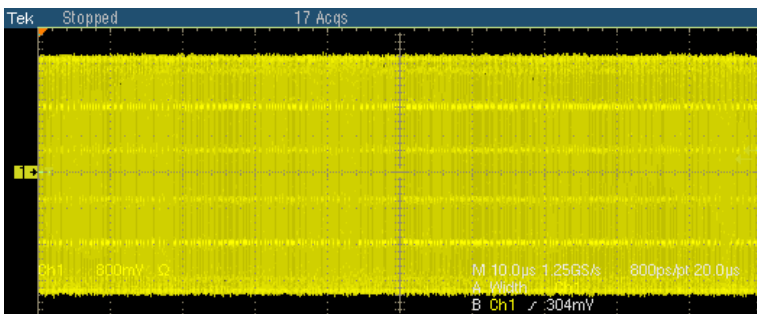

Figure 10-13: Waveform for 10BASE-T Differential Voltage

The application automatically displays the results as pass or fail. Select **Results** in the Execution pane and then click **Result Details** button to view the detailed results.

Note: The application displays the probe offset value in the Result Details dialog box.

Harmonic

1. Click **Tests > Select > 10BASE-T** from the menu bar.
2. In the Parametric tab, select **Harmonic**.

Note: The status bar displays the major configuration details. If you do not want to change the configuration settings, you can skip Step 3.

3. To change the configuration settings, select **Tests > Configure** from the menu bar, or click the **Configure** button in the Selection pane.
4. In the Configuration window, select the following options:

Table 10-5: 10BASE-T Harmonic Configuration Options

Parameter	Options	To Do
Data	CH1, CH2, CH3, or CH4	Select the channel to which the DUT is connected.
Harmonic Ones		
Output	Math1, Math2, Math3, or Math4	Select the math waveform on which the processed waveform will be stored.
# of Averages		Enter the number of waveforms to be averaged.
Time/Scale	1 or 10 microseconds	Enter the time or scale depending on the packet length being transmitted.

5. Select **Tests > Connect** or **Connect** in the Selection pane and make connections.
6. Select **View Wfm** in the Selection pane, to view and compare the waveform with the acquired waveform.
7. Click **Run Test**. The application does the following:
 - Checks whether the DUT is connected and a valid signal is acquired
 - Sets up the Vertical, Horizontal, Trigger and Math Spectral oscilloscope parameters
 - Displays the Math waveform

The following figure shows a typical DUT waveform for Harmonic:

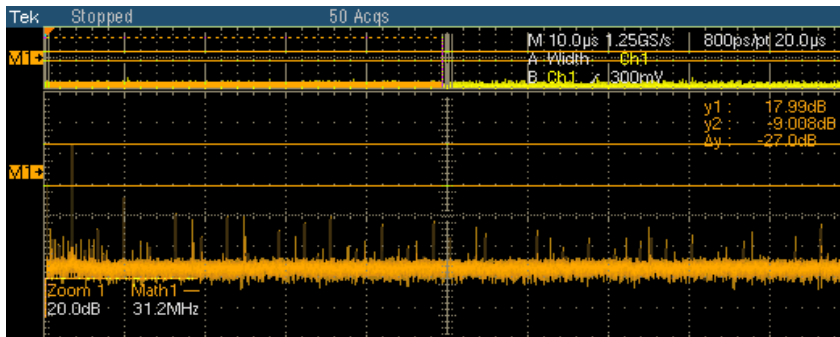

Figure 10-14: Waveform for 10BASE-T Harmonic

Note: The Harmonic results starts at 2 and ends at 25. If the calculated harmonic frequency value is not in the range of ± 0.5 MHz, then cursor based readings of the harmonic value are used.

The application automatically displays the results as pass or fail. Select **Results** in the Execution pane and then click **Result Details** button to view the detailed results.

Jitter with cable

1. Click **Tests > Select > 10BASE-T** from the menu bar.
2. In the Parametric tab, select **With Cable** in the Jitter group. Select Normal, 8BT, 8.5BT, or All in the adjacent drop-down list.

Note: The status bar displays the major configuration details. If you do not want to change the configuration settings, you can skip Step 3.

3. To change the configuration settings, select **Tests > Configure** from the menu bar, or click the Configure button in the Selection pane.
4. In the Configuration window, select the following options:

Table 10-6: 10BASE-T Jitter with cable Configuration Options

Parameter	Options	To Do
Data	CH1, CH2, CH3, or CH4	Select the channel to which the DUT is connected.
MAU Type	Internal, or External	Select the MAU Type as Internal or External.

5. Select **Tests > Connect** or **Connect** in the Selection pane and make connections.
6. Select **View Wfm** in the Selection pane, to view and compare the waveform with the acquired waveform.
7. Click **Run Test**. The application checks whether the DUT is connected and a valid signal is acquired.
8. If you selected 8BT or 8.5BT or All (Refer Step 2), the following window appears.



Figure 10-15: 10BASE-T Jitter with cable user control

If the signal does not look like the one in the image, you can setup the oscilloscope. The signal may not match the one in the image if there is interpacket interval observed on the screen. Adjust these parameters in the oscilloscope:

- Increase the trigger level so that the interpacket interval is not considered. Trigger level is currently set to 60 mV accounting for the noise of 50 mV.
 - If the signal still does not match the one in the image, adjust the trigger hold off parameter. This adjustment will help in skipping the interpacket interval and get the stable trigger every time.
9. The application does the following:
 - Sets up the signal
 - Places the horizontal histogram at the zero crossing
 - Reads the peak-to-peak jitter from the histogram
 - Compares the read out values with the Standard
 - Acquires the signal for approximately 15 seconds

If you have selected Output Timing Jitter as **Normal**, the application displays the typical DUT waveform for Jitter with cable testing as shown in the following figure:

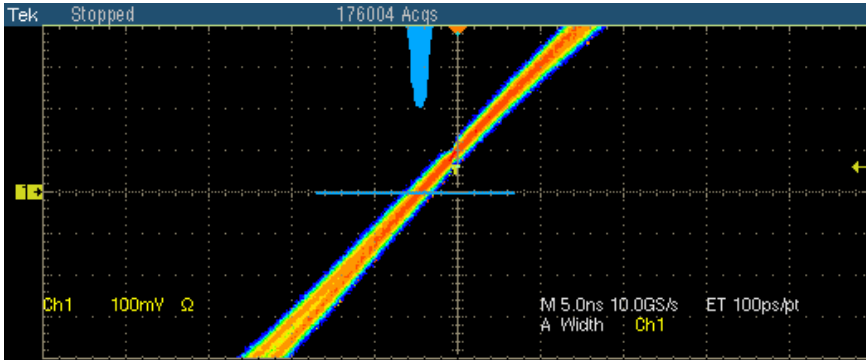

Figure 10-16: Waveform for 10BASE-T Jitter with Cable for Normal output timing jitter

If you have selected Output Timing Jitter as **8 BT**, the application displays the typical DUT waveform for Jitter with cable testing as shown in the following figure:

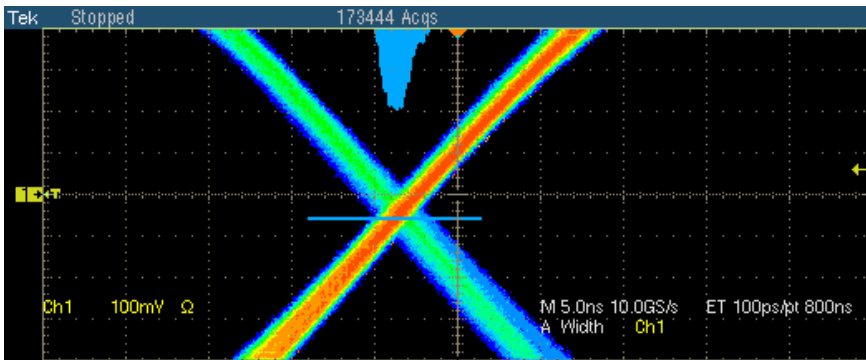

Figure 10-17: Waveform for 10BASE-T Jitter with Cable for 8 BT output timing jitter

If you have selected Output Timing Jitter as **8.5 BT**, the application displays the typical DUT waveform for Jitter with cable testing as shown in the following figure:

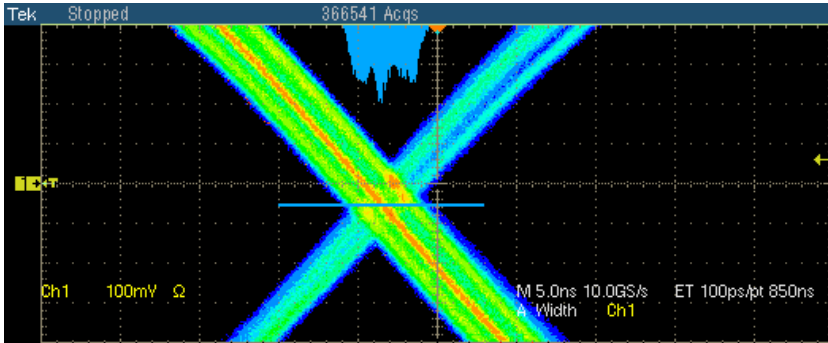

Figure 10-18: Waveform for 10BASE-T Jitter with Cable for 8.5 BT output timing jitter

The application automatically displays the results as pass or fail. Select **Results** in the Execution pane and then click **Result Details** button to view the detailed results.

Jitter without cable

1. Click **Tests > Select > 10BASE-T** from the menu bar.
2. In the Parametric tab, select w/o Cable in the Jitter group. Select Normal, 8BT, 8.5BT, or All in the adjacent drop-down list.

***Note:** The status bar displays the major configuration details. If you do not want to change the configuration settings, you can skip Step 3.*

3. To change the configuration settings, select **Tests > Configure** from the menu bar, or click the Configure button in the Selection pane.
4. In the Configuration window, select the following options:

Table 10-7: 10BASE-T Jitter without cable Configuration Options

Parameter	Options	To Do
Data	CH1, CH2, CH3, or CH4	Select the channel to which the DUT is connected.
MAU Type	Internal, or External	Select the MAU Type as Internal or External.

5. Select **Tests > Connect** or **Connect** in the Selection pane and make connections.

6. Select **View Wfm** in the Selection pane, to view and compare the waveform with the acquired waveform.
7. Click **Run Test**. The application checks whether the DUT is connected and a valid signal is acquired.
8. If you selected 8BT or 8.5BT or All (Refer Step 2), the following window appears.

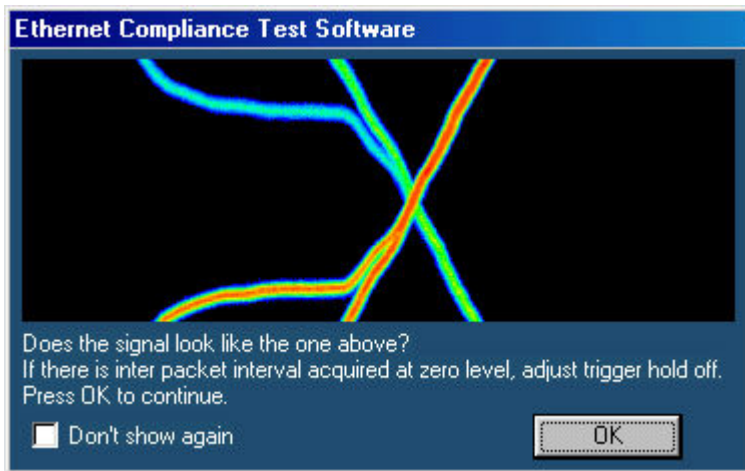

Figure 10-19: 10BASE-T Jitter without cable user control

If the signal does not look like the one in the image, you can setup the oscilloscope. The signal may not match the one in the image if there is interpacket interval observed on the screen. Adjust these parameters in the oscilloscope:

- Increase the trigger level so that the interpacket interval is not considered. Trigger level is currently set to 60 mV accounting for the noise of 50 mV.
 - If the signal still does not match the one in the image, adjust the trigger hold off parameter. This adjustment will help in skipping the interpacket interval and get the stable trigger every time.
9. The application does the following:
 - Sets up the signal
 - Places the horizontal histogram at the zero crossing
 - Reads the peak-to-peak jitter from the histogram
 - Compares the read out values with the Standard
 - Acquires the signal for approximately 15 seconds

If you have selected Output Timing Jitter as **Normal**, the application displays the typical DUT waveform for Jitter with cable testing as shown in the following figure:

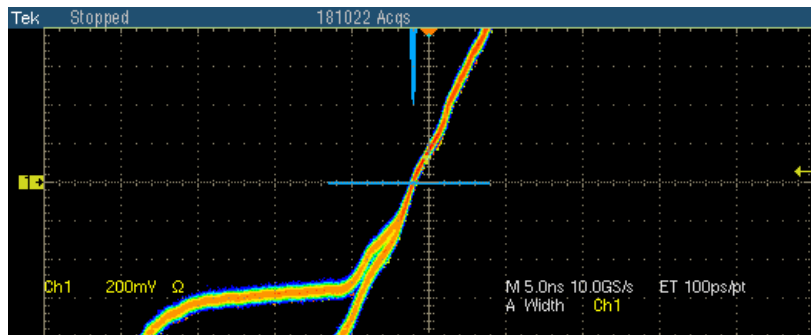

Figure 10-20: Waveform for 10BASE-T Jitter without Cable for Normal output timing jitter

If you have selected Output Timing Jitter as **8 BT**, the application displays the typical DUT waveform for Jitter with cable testing as shown in the following figure:

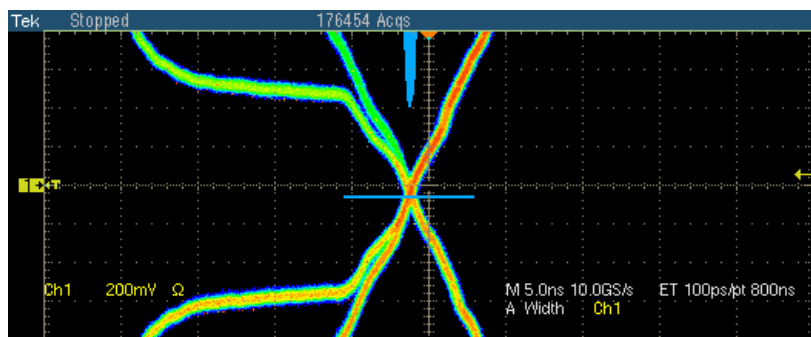

Figure 10-21: Waveform for 10BASE-T Jitter without Cable for 8 BT output timing jitter

If you have selected Output Timing Jitter as **8.5 BT**, the application displays the typical DUT waveform for Jitter with cable testing as shown in the following figure:

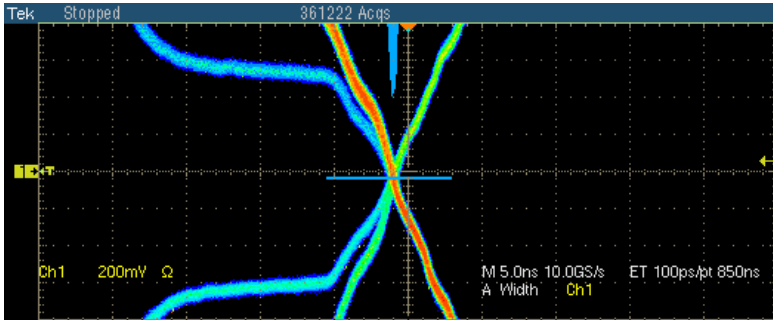

Figure 10-22: Waveform for 10BASE-T Jitter without Cable for 8.5 BT output timing jitter

The application automatically displays the results as pass or fail. Select **Results** in the Execution pane and then click **Result Details** button to view the detailed results.

Return Loss

1. Click **Tests > Select > 10BASE-T** from the menu bar.
2. In the Return Loss tab, select **Transmitter** or **Receiver**.

***Note:** The status bar displays the major configuration details. If you do not want to change the configuration settings, you can skip Step 3.*

3. To change the configuration settings, select **Tests > Configure** from the menu bar, or click the Configure button in the Selection pane.
4. In the Configuration window, select the following options:

Table 10-8: 10BASE-T Return Loss Configuration Options

Parameter	Options	To Do
Sources P1/P3 P2/P4	CH1, CH2, CH3, or CH4 CH1, CH2, CH3, or CH4	Select the channel to which the DUT is connected. <i>Note: Depending on whether the Transmitter or Receiver is selected, the sources will change from P1/P3 and P2/P4.</i>

Table 10-8: 10BASE-T Return Loss Configuration Options

Output Waveform	Ref1, Ref2, Ref3, or Ref4	Select the reference waveform on which the output waveform will be stored.
Return Loss		Select the reference waveform on which you want the OdB Marker to be indicated.
OdB Marker	Ref1, Ref2, Ref3, or Ref4	<i>Note: These fields appear only if you set Load as 100 ohm.</i>
AWG Series	Select, AWG 4xx, AWG 2021, AWG 5xx, AWG 6xx, AWG 7xx	Select the AWG Series to use. If you select the default value—Select—then the application considers all AWGs other than the AWG 4xx series.
Load	85, 100, 115 ohm or 100 ohm	Select the load as 85, 100, 111 ohm or 100 ohm.
#Averages	100 to 10000	Enter the number of waveforms you want to average.
Smooth	0 to 10	Enter the smoothing factor.

5. Select **Tests > Connect** or **Connect** in the Selection pane and make connections.
6. Select **View Wfm** in the Selection pane, to view and compare the waveform with the acquired waveform.
7. Click Run Test. The application does the following:
 - Displays a message box to confirm the overwrite of the reference waveform. Select Yes to continue
 - Sets up the Trigger
 - Acquires, and computes the return loss
 - Displays the return loss curve on selected output (reference waveform)

If the test fails, the application captures the waveform, circles the hits and saves the information to the report. The application obtains the hits information only for the 100 ohm waveform.

The following figure shows a typical waveform for Return Loss Transmitter.



Figure 10-23: Waveform for 10BASE-T Return Loss Transmitter

The following figure shows a typical waveform for Return Loss Receiver.



Figure 10-24: Waveform for 10BASE-T Return Loss Receiver

The application automatically displays the results as pass or fail. Select **Results** in the Execution pane and click **Result Details** button to view detailed results.

CM Voltage

1. Click **Tests > Select > 10BASE-T** from the menu bar.
2. In the CM Voltage tab, select **CM Voltage**.

Note: The status bar displays the major configuration details. If you do not want to change the configuration settings, you can skip Step 3.

3. To change the configuration settings, select **Tests > Configure** from the menu bar, or click the Configure button in the Selection pane.

4. In the Configuration window, select the following options:

Table 10-9: 10BASE-T CM Voltage Configuration Options

Parameter	Options	To Do
Data	CH1, CH2, CH3, or CH4	Select the channel to which the DUT is connected.

5. Select **Tests > Connect** or **Connect** in the Selection pane and make connections.
6. Select **View Wfm** in the Selection pane, to view and compare the waveform with the acquired waveform.
7. Click **Run Test**. The application does the following:
 - Checks whether the DUT is connected and a valid signal is acquired
 - Sets the trigger
 - Measures the maximum positive and negative voltage levels
 - Compares the values with the Standard
 - Displays the DUT waveform for Common mode Voltage testing

The following figure shows a typical waveform for Common mode Voltage:

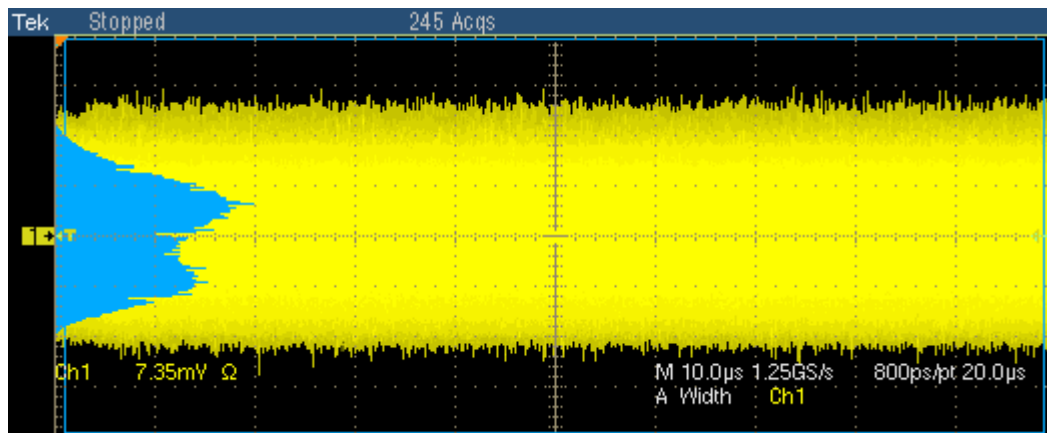

Figure 10-25: Waveform for 10BASE-T Common mode Voltage

The application automatically displays the results as pass or fail. Select **Results** in the Execution pane and then click **Result Details** button to view the detailed results.

View Waveform for 1000BASE-T

Template, Peak Volt, Droop



Figure 11-1: 1000BASE-T View Waveform for Template, Peak Volt, and Droop with disturbing signal

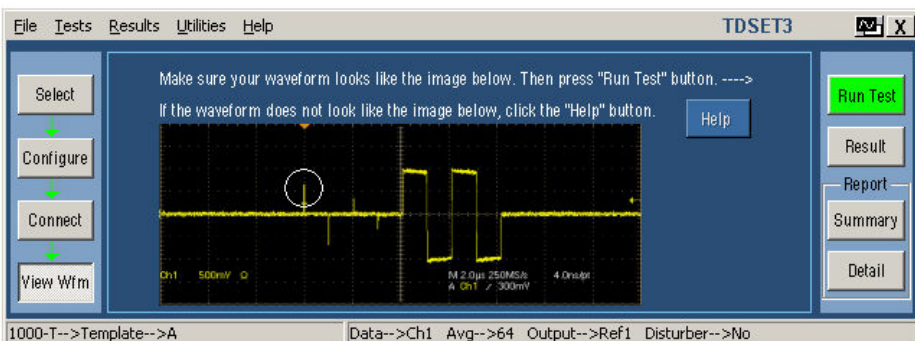

Figure 11-2: 1000BASE-T View Waveform for Template, Peak Volt, and Droop without disturbing signal

Ensure the waveform displayed by the application in the circled portion is similar to the acquired waveform.

If the waveform displayed by the application is not similar to the acquired waveform in the graticule, do the following:

- For Template, Peak Volt, and Droop tests, check if the DUT is set to transmit Test Mode 1 signal.
- Check for the polarity of the signal.
- Check for the correctness of jumper connections in the fixture.

- Check for the correctness of the probing point in the fixture.

Jitter Master

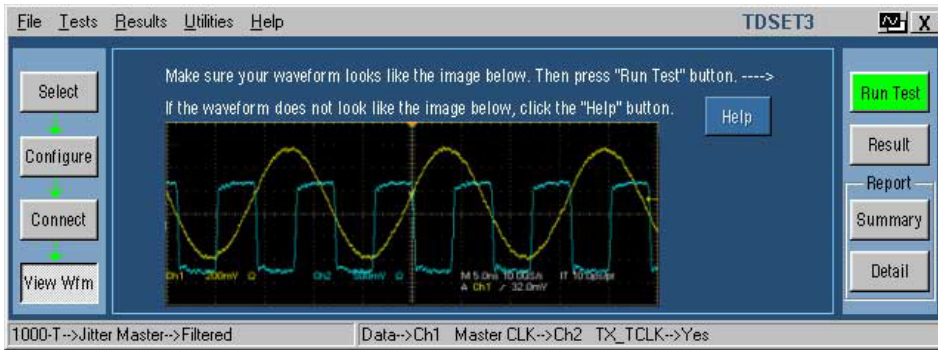

Figure 11-3: 1000BASE-T View Waveform for Jitter Master Filtered (with TX_TCLK access)

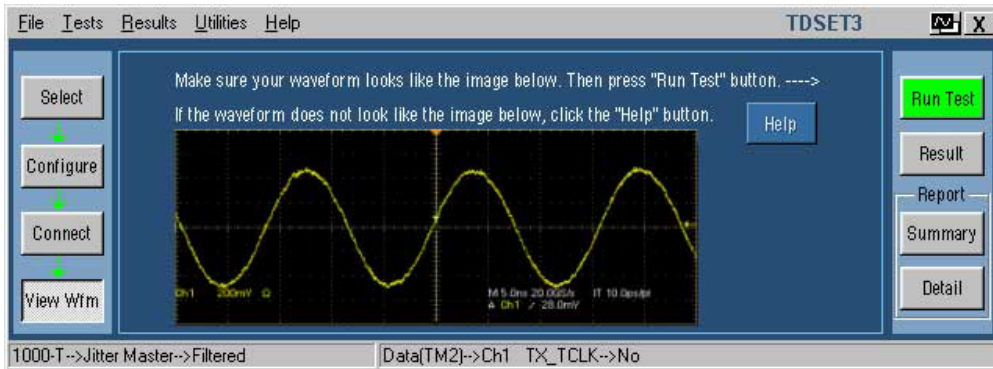

Figure 11-4: 1000BASE-T View Waveform for Jitter Master Filtered (without TX_TCLK access)

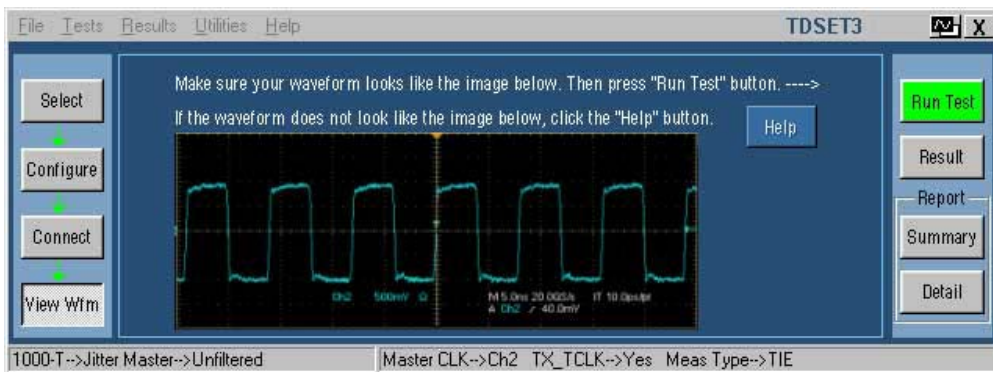

Figure 11-5: 1000BASE-T View Waveform for Jitter Master Unfiltered (with TX_TCLK access)

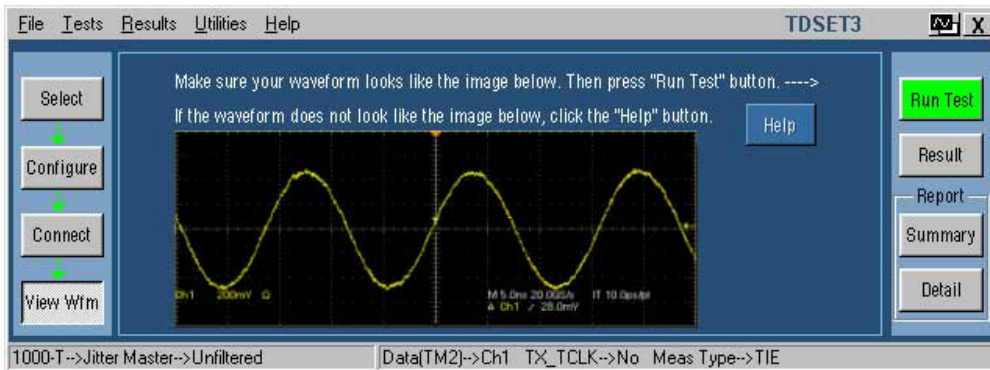

Figure 11-6: 1000BASE-T View Waveform for Jitter Master Filtered (without TX_TCLK access)

Note: In TDS5000B series oscilloscopes, the horizontal scale is set to 10 ns.

If the waveform displayed by the application is not similar to the acquired waveform in the graticule, do the following:

- Check if the DUT is set to transmit Test Mode 2 signal.
- Check for the correctness of test setup.
- Check for the correctness of the probing point in the fixture.

Jitter Slave

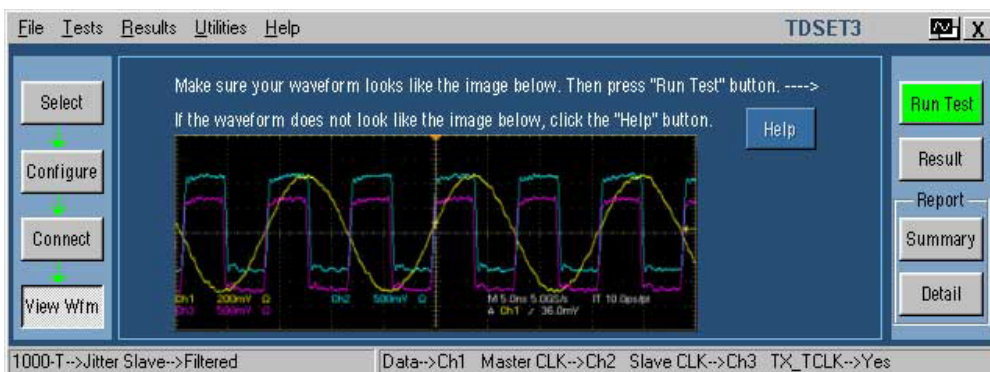

Figure 11-7: 1000BASE-T View Waveform for Jitter Slave Filtered (with TX_TCLK access)

View Waveform for 1000BASE-T

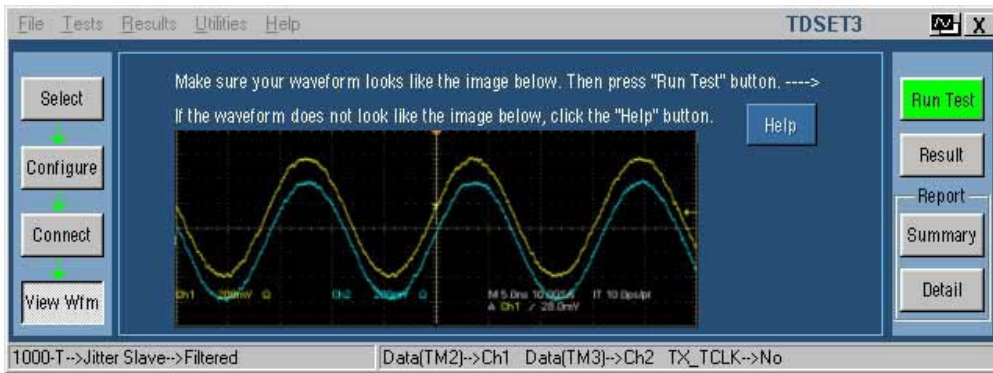

Figure 11-8: 1000BASE-T View Waveform for Jitter Master Filtered (without TX_TCLK access)



Figure 11-9: 1000BASE-T View Waveform for Jitter Slave Unfiltered (with TX_TCLK access)

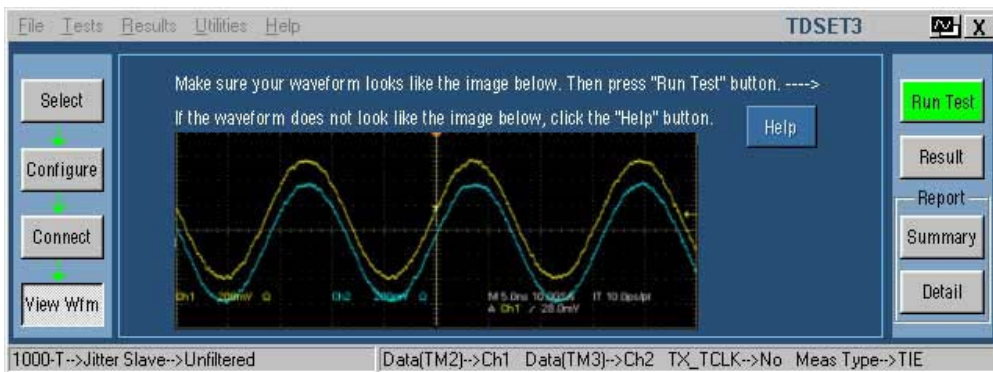

Figure 11-10: 1000BASE-T View Waveform for Jitter Master Filtered (without TX_TCLK access)

Note: In TDS5000B series oscilloscopes, the horizontal scale is set to 10 ns.

If the waveform displayed by the application is not similar to the acquired waveform in the graticule, do the following:

- Check if the DUT is set to transmit the appropriate Test Mode signal.
- Check for the correctness of test setup.
- Check for the correctness of the probing point in the fixture.

Distortion

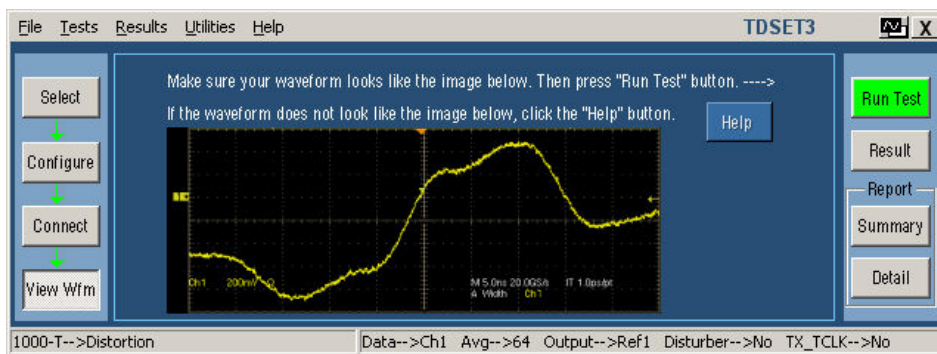

Figure 11-11: 1000BASE-T View Waveform for Distortion

Note: In TDS5000B series oscilloscopes, the horizontal scale is set to 10 ns.

If the waveform displayed by the application is not similar to the acquired waveform in the graticule, do the following:

- Check if the DUT is set to transmit Test Mode 4 signal.
- Check for the polarity of the signal.
- Check for the correctness of jumper connections in the fixture.
- Check for the correctness of the probing point in the fixture.

Return Loss



Figure 11-12: 1000BASE-T View Waveform for Return Loss

If the waveform displayed by the application is not similar to the acquired waveform in the graticule, do the following:

- Check if the DUT is set to transmit Test mode 4 signal.
- Check if the polarity of probe connection is right.
- Check for the correctness of the probing point in the Test Fixture.

CM Voltage



Figure 11-13: 1000BASE-T View Waveform for CM Voltage

If the waveform displayed by the application is not similar to the acquired waveform in the graticule, do the following:

1. Check if the DUT is set to transmit Test mode 4 signal.
2. Check if the probe is properly locked to the oscilloscope.
3. Check if all the connections are proper.

View Waveform for 100BASE-TX

All 100BASE-TX Tests except Return Loss

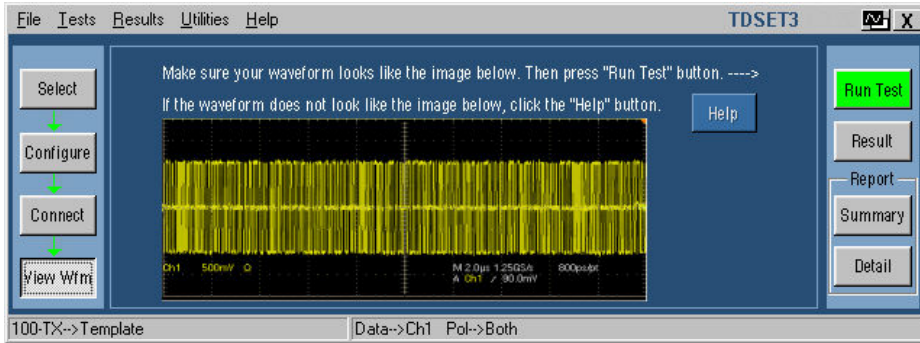

Figure 12-1: 100BASE-TX View Waveform for all tests except Return Loss

If the waveform displayed by the application is not similar to the acquired waveform in the graticule, do the following:

- Check if the DUT is set to transmit random sequence.
- Check if the polarity of probe connection is right.
- Check for the correctness of the probing point in the Test Fixture.

Return Loss



Figure 12-2: 100BASE-TX View Waveform for Return Loss Transmitter

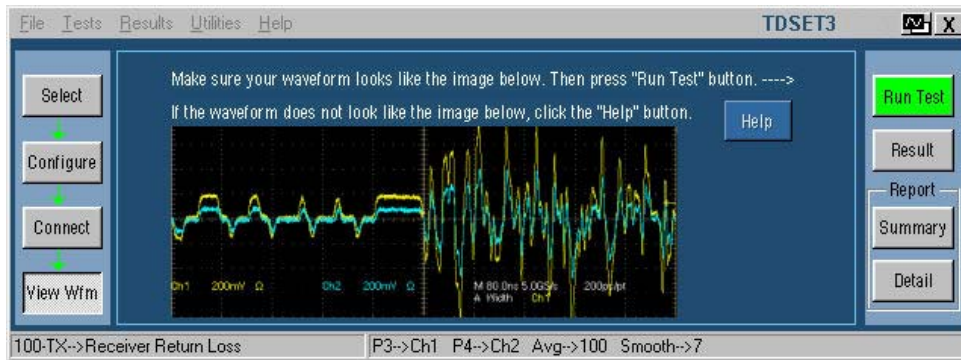

Figure 12-3: 100BASE-TX View Waveform for Return Loss Receiver

If the waveform displayed by the application is not similar to the acquired waveform in the graticule, do the following:

- Check if the DUT is set to transmit random sequence.
- Check if the polarity of probe connection is right.
- Check for the correctness of the probing point in the Test Fixture.

View Waveform for 10BASE-T

Link Pulse

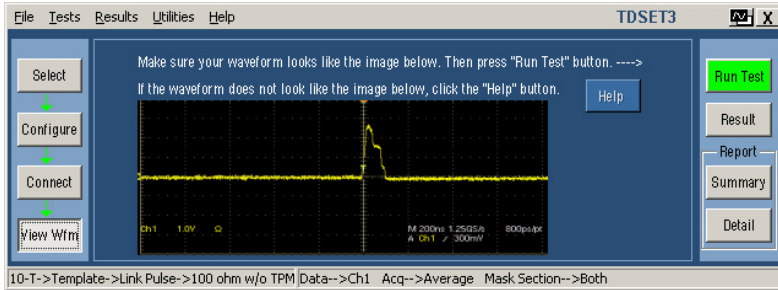

Figure 13-1: 10BASE-T View Waveform for Link Pulse

If the waveform displayed by the application is not similar to the acquired waveform in the graticule, do the following:

- Check if the DUT is transmitting the Link Pulse.
- Check if the probe is properly locked to the Oscilloscope.
- Check if the polarity of probe connection is right.
- Check if all the connections are proper.

MAU

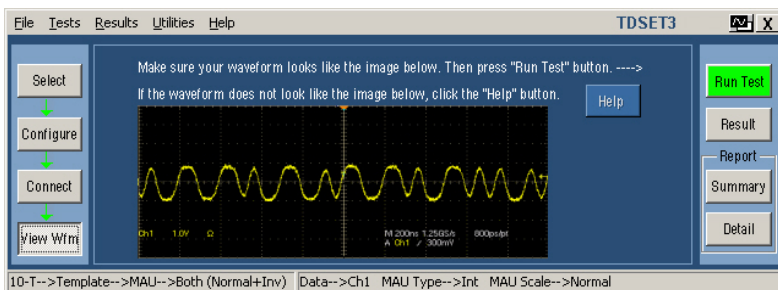

Figure 13-2: 10BASE-T View Waveform for MAU

If the waveform displayed by the application is not similar to the acquired waveform in the graticule, do the following:

- Check if the DUT is transmitting the Link Pulse.

- Check if the probe is properly locked to the Oscilloscope.
- Check if the polarity of probe connection is right.
- Check if all the connections are proper.

TP_IDL



Figure 13-3: 10BASE-T View Waveform for TP_IDL

If the waveform displayed by the application is not similar to the acquired waveform in the graticule, do the following:

- Check if the DUT is transmitting 10Base-T Packets.
- Check if the polarity of probe connection is right.
- Check if the probe is properly locked to the Oscilloscope.
- Check if all the connections are proper.

Jitter with or without cable

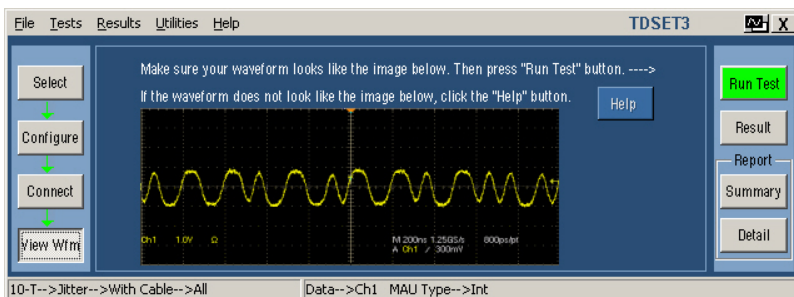

Figure 13-4: 10BASE-T View Waveform for Jitter with cable

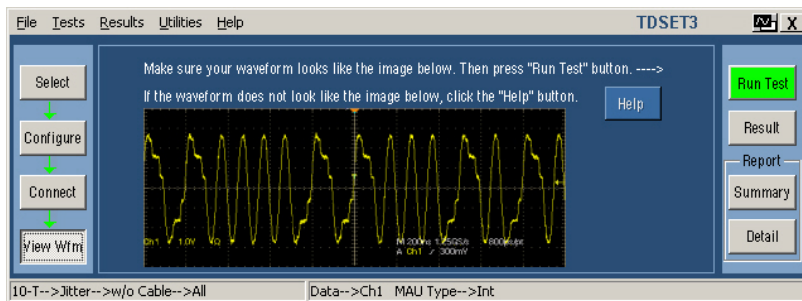

Figure 13-5: 10BASE-T View Waveform for Jitter with cable

If the waveform displayed by the application is not similar to the acquired waveform in the graticule, do the following:

- Check if the DUT is transmitting 10Base-T Packets.
- Check if the probe is properly locked to the Oscilloscope.
- Check if all the connections are proper.

Differential Voltage

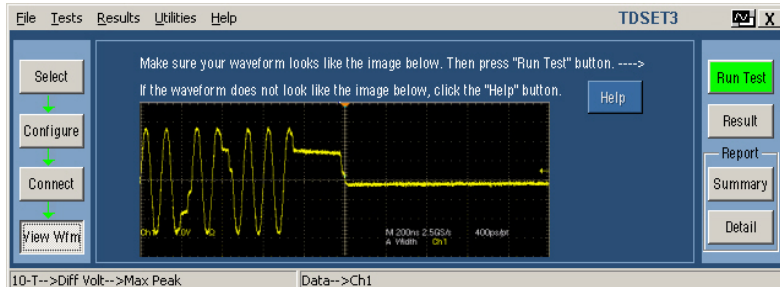

Figure 13-6: 10BASE-T View Waveform for Differential Voltage

If the waveform displayed by the application is not similar to the acquired waveform in the graticule, do the following:

- Check if the DUT is transmitting 10Base-T Packets.
- Check if the polarity of probe connection is right.
- Check if the probe is properly locked to the Oscilloscope.
- Check if all the connections are proper.

Harmonic

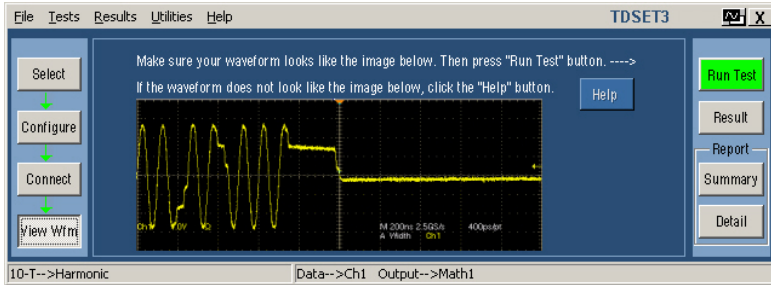

Figure 13-7: 10BASE-T View Waveform for Harmonic

If the waveform displayed by the application is not similar to the acquired waveform in the graticule, do the following:

- Check if the DUT is transmitting 10Base-T Packets.
- Check if the polarity of probe connection is right.
- Check if the probe is properly locked to the Oscilloscope.
- Check if all the connections are proper.

Return Loss

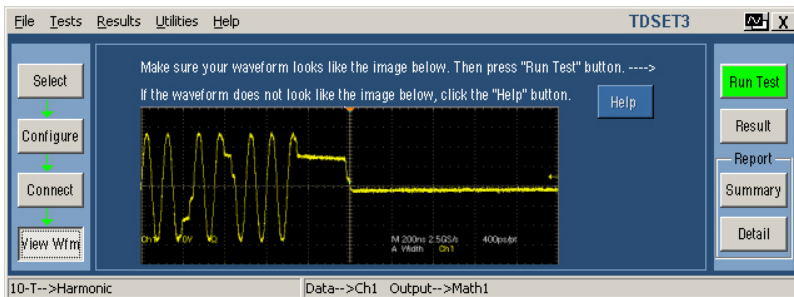

Figure 13-8: 10BASE-T View Waveform for Return Loss

If the waveform displayed by the application is not similar to the acquired waveform in the graticule, do the following:

- Check if the DUT is transmitting 10Base-T Packets.
- Check if the polarity of probe connection is right.
- Check if the probe is properly locked to the Oscilloscope.
- Check if all the connections are proper.

CM Voltage



Figure 13-9: 10BASE-T View Waveform for CM Voltage

If the waveform displayed by the application is not similar to the acquired waveform in the graticule, do the following:

- Check if the DUT is transmitting 10Base-T Packets.
- Check if the probe is properly locked to the Oscilloscope.
- Check if all the connections are proper.

Generate Reports

You can automatically generate reports using the **Report Summary** or *Details* button. You can use Report Configuration pane in the Result pane for configuring the DUT details and report file name.

Use Report Generator to manually generate the report. For more information, see the next section *About Report Generator*.

To manually generate the report, do the following:

1. From the application menu bar, select **Utilities > Report Generator** to display Report Generator window.
2. In the Generate Report tab, select **Browse**. The Open dialog box displays all the reports in the default directory **c:\TekApplications\TDSET3\Report Generator\Reports**.
3. In the Open dialog box, select the relevant tests, and then select **Open**.
4. In the Generate Report tab, select **Generate Report, Print Report, or Load Report**.
5. If you select **Generate Report**, the Assign Data to Report dialog box appears.
 - In the Assign Data to Report dialog box, select the test templates to assign the current data from your measurement application.
 - Select **Assign**. The Report Viewer displays the report with current data from the application. You can choose to export to rtf format.

If you select **Print Report**, the Report Viewer displays the selected report with current data from the application.

- If the page settings do not match the page settings for the report, a Page Size Mismatch message box displays a message — **The current page settings do not match the page settings for the Report. Do you want to continue?**
 - Click **Yes** to continue.
 - Click **No** to stop printing the report.
- If a printer is connected to the oscilloscope, the report is printed.

If you select **View Report**, the Report Viewer displays the selected report with current data from the application.

You can also define test templates, and define report layouts.

About Report Generator

The Report Generator enables you to generate and print reports directly from the oscilloscope. It enhances the TDSET3 application capabilities by simplifying the process of creating and maintaining reports.

The Report Generator automates the process of compiling the test results and generating the reports. It allows you to set up the template layout using the factory default templates or custom templates. The Report Generator allows you to save files in the custom file formats such as .rgt, .rpl, or .rpt. The generated reports can also be saved as an .rtf file. The Report Generator is integrated with the TDSET3 application.

To generate a report in PDF format, you can use any tool that converts RTF to PDF. For converting the .RPT to PDF, there are several tools such as RoboPDF™, GhostWriter™ and so on.

For more information on Report Generator, [click here to view the Report Generator Printed Help Document](#).

You can also access the file – **ReportGenerator.pdf** at **C:\Program Files\TekApplications\TDSET3**.

Automating AWG

Automate AWG

Utilities > Automate AWG

This procedure will guide you through the process of connecting and configuring the AWG and the oscilloscope for automation.

You will need: Tektronix AWG, Tektronix digital oscilloscope, and National Instruments GPIB-USB-A/B with the included software, NI-488.2 for Windows.

1. Connect the equipment and verify the connection.
2. From the TDSET3 menu, select **Utilities> Automate AWG**. The following screen appears:



Figure 15-1: AWG Automation Setup

3. Select GPIB to automate the AWG and configure GPIB setup. The following table describes the AWG Automation configuration parameters.
4. Select GPIB to automate the AWG and configure GPIB setup. The following table describes the AWG Automation configuration parameters.

Table 15-1: AWG Configuration Parameters and Descriptions

Configuration Parameter	Description
GPIB, Manual	Select GPIB to automate file transfer and settings to the AWG.
Board Type	Select the Board Type that you are using.
Primary Address	Select the Primary GPIB Address.

Table 15-1: AWG Configuration Parameters and Descriptions

Secondary Address	Select the Secondary GPIB Address.
Show File overwrite warnings	When checked, warns you before transferring files on the AWG while running a test.

Note: While running a test, the oscilloscope transfers waveform and setup files to the AWG. Ensure that the AWG does not have files with the same name to avoid overwriting those files.

Click Test Connection and look for a message that the connection is successful. Test Connection is enabled only for the GPIB mode.

RUN the selected test.

If you have selected Manual to set up the AWG and configure GPIB setup, you must:

- copy the waveform files from C:\TekApplications\TDSET3\AWG Waveforms.
- load the appropriate waveform onto the proper channel
- make the AWG settings according to the ReadMe.txt in the corresponding folder.
- then RUN the test.

Configuration Parameters and Default Settings:

Table 15-2: AWG Configuration Parameters and Defaults

Parameter	Default
Select: GPIB, Manual	Manual
Board Type	GPIB0
Primary Address	9
Secondary Address	0
Show File overwrite warnings	Checked

Connect the Equipment and Verify the Connections

Before you connect the equipment and verify the connection, ensure that you have installed NI-488.2 for Windows.

Follow these steps to install NI-488.2 for Windows.

1. Install NI-488.2 for Windows (version 2.1 or above) on the oscilloscope.

During Installation:

2. Ensure that NI-VISA is NOT installed.
3. Install the Measurement and Automation Explorer.
4. When prompted, enable the GPIB-USB-A/B interface.
5. Restart the oscilloscope.

Note: If you already have NI-488.2 installed in your oscilloscope, ensure that you have the version and installation parameters described in step 1. If you do not, then uninstall NI-488.2 and install it according to step 1.

Connect the Equipment

1. Connect the GPIB-USB-A/B to the USB port on the oscilloscope (the TDS7000B rear panel is shown here). The oscilloscope operating system will detect the USB-GPIB controller and install the appropriate driver for it.
2. Connect the GPIB-USB-A/B between the oscilloscope and the AWG.

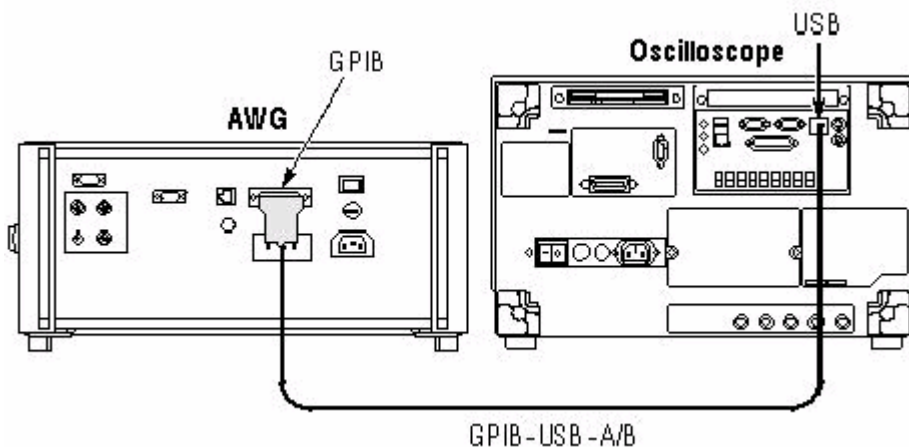

Figure 15-2: Connecting the AWG and the Oscilloscope

Verify the Equipment Connections

3. Open the Measurement & Automation Explorer that was installed with the NI-488.2 software.

4. In the Configuration pane, look under Devices and Interfaces for the GPIB device.

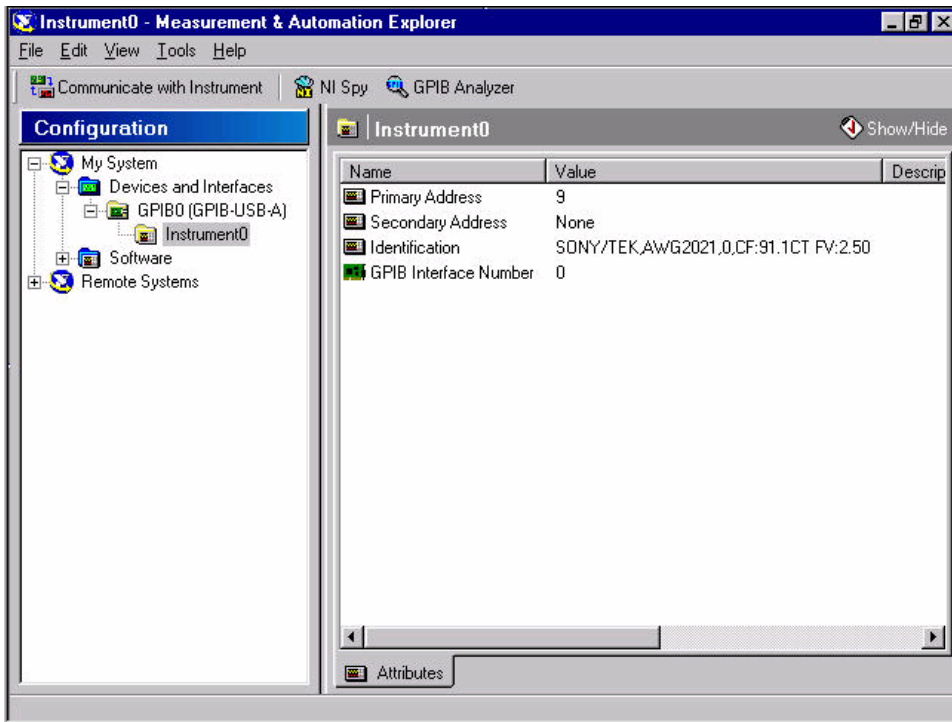

Figure 15-3: Verifying the instrument connections

5. Right-click on the GPIB device and click Scan for Instruments.
6. Note the GPIB Instrument Number and the Primary Address for configuring the instrument connection in the TDSET3 application.
7. Right Click on the instrument (Instrument0 in this example) and click Communicate with Instrument.
8. In the NI-488.2 Communicator dialog box, click Query and check that *IDN? Brings up a description of the correct equipment.
9. Search for the TekVISA configuration either on the desktop or in Start\Program Files\TekVISA\Tek VISA configuration. If you cannot find TekVISA, rename the visa32.dll in C:\wint\system32 and then install the latest TekVISA.
10. Click on the Find/Refresh button to refresh the list of devices connected to the oscilloscope.

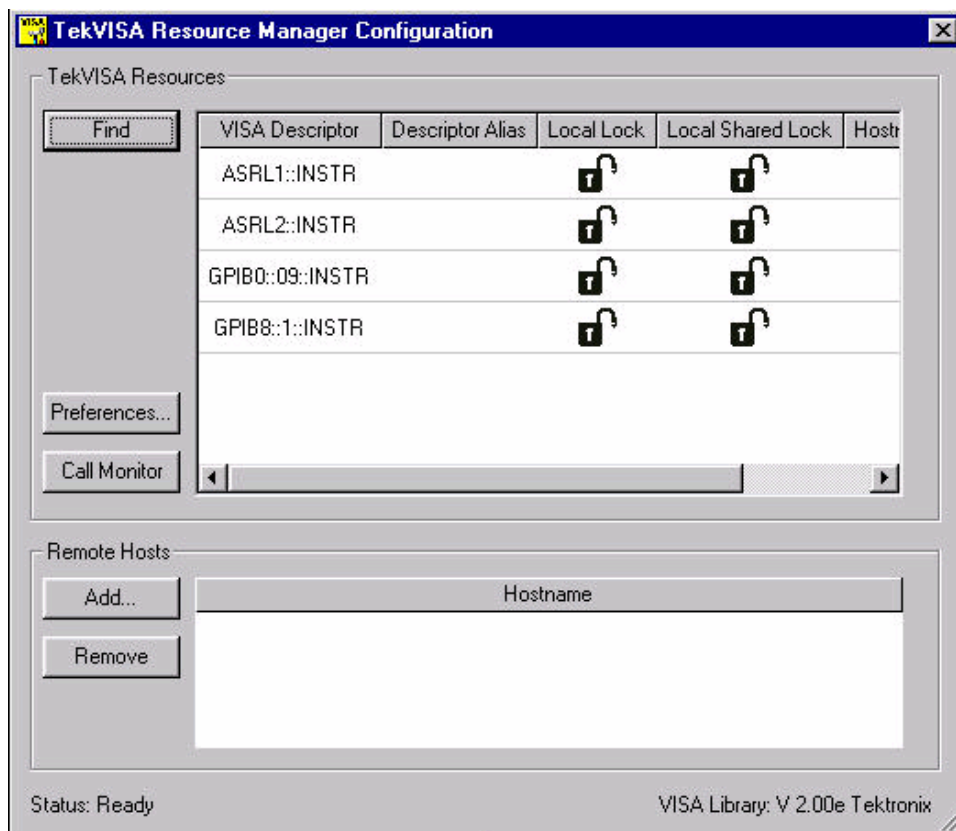

Figure 15-4: TekVISA Resource Manager Configuration

11. If the NI-488.2 GPIB settings and TekVISA configuration do not match, the connection/configuration might not be correct.

Note: If the AWG is not found listed in TekVISA (with the properties as in NI VISA), make sure that TekVISA detects the GPIB devices. Sometimes it could detect only those network devices that you see.

12. Start the application and continue with AWG automation.

Note: While running a test, the oscilloscope transfers waveform and setup files to the AWG. Ensure that the AWG does not have files with the same name to avoid overwriting those files.

Reference to Standards

1000BASE-T

Template Purpose:

To verify that the transmitter output fits the time domains transmit templates.

Reference to Standard:

Subclause 40.6.1.2.3 of IEEE standard 802.3-2000 ab

What Standard says:

According to standard, the test mode 1 signal from the DUT needs to be normalized. This should be compared to the differential output templates shown in Figure 40-26 of the standard. The normalization factors to be applied to various points:

For Point A: Normalization with the peak voltage at point A.

For Point B: Normalization with the negative of peak voltage at point A.

For Point C: Normalization with 0.5 times the peak voltage at point A.

For Point D: Normalization with the negative of 0.5 times the peak voltage at point A.

For Point F & H: The waveform around points F and H are compared to time domain transmit template 2 after the following normalization factors are applied:

Normalization with the peak voltage at point F.

Normalization with the peak voltage at point H.

According to standard, the waveform can be shifted in time to fit the template.

Peak Voltage Purpose:

To verify correct transmitter output levels.

Reference to Standard:

Subclause 40.6.1.2.1 of IEEE standard 802.3-2000 ab

What Standard says:

According to standard, magnitude of peak differential output voltage measure at points A and B should be between 670 and 820 mV. Also, these conditions should be met:

$$|PeakVoltageB| - |PeakVoltageA| < 1\%$$
$$\left\{ \begin{array}{l} |PeakVoltageC| \\ |PeakVoltageD| \end{array} \right\} < 2\% \text{ of } 0.5 \text{ times } \left(\frac{|PeakVoltageA| + |PeakVoltageB|}{2} \right)$$

Droop Purpose:

To verify that the transmitter output level does not decay faster than the maximum specified rate.

Reference to Standard:

Subclause 40.6.1.2.2 of IEEE standard 802.3-2000 ab

What Standard says:

According to standard, the Point G and J are exactly 500 ns from Points F and H respectively. The magnitude of voltage at Point G should be greater than 73.1% magnitude of voltage at Point F and magnitude of voltage at Point J should be greater than 73.1% magnitude of voltage at Point H.

Jitter (with TX_TCLK ACCESS)**Purpose:**

To verify that the transmitter output level does not reduce faster than the maximum specified rate.

Reference to Standard:

Subclause 40.6.1.2.5 of IEEE standard 802.3-2000 ab

What Standard says:

Jitter Master Unfiltered — According to standard the peak-to-peak value of jitter waveform on MASTER TX_TCLK relative to unfiltered reference should be less than 1.4 ns.

Jitter Master Filtered — According to standard the peak-to-peak value of jitter

waveform on MASTER TX_TCLK when filtered by a high pass filter, $H_{J1}(f)$ with the transfer function below + JTx out of Data related to the corresponding edge of MASTER TX_TCLK should be less than 0.3 ns.

$$H_{J1}(f) = \frac{jf}{jf + 5000} \text{ finHz}$$

Jitter Slave Unfiltered — According to standard the peak-to-peak value of jitter waveform on SLAVE TX_TCLK relative to unfiltered reference should be less than 1.4 ns.

Jitter Slave Filtered — According to standard the peak-to-peak value of jitter

waveform on SLAVE TX_TCLK when filtered by a high pass filter, $H_{J2}(f)$ with the transfer function below + JTx out of data related to the corresponding edge of SLAVE TX_TCLK should be less than 0.4 ns + peak-to-peak value of jitter

waveform on MASTER TX_TCLK when filtered by a high pass filter, $H_{J1}(f)$.

$$H_{J2}(f) = \frac{jf}{jf + 32000} \text{ finHz}$$

Note: J denotes the square root of -1.

Jitter (without TX_TCLK ACCESS) Purpose:

To provide an analysis of the Transmitter Timing Jitter test method defined in Clause 40.6.1.2.5 of IEEE 802.3, and to propose an alternative method that may be used in cases where a device does not provide access to the TX_TCLK signal.

Reference:

1. IEEE standard 802.3-2000, subclause 40.6.1.1.1 – Test channel
2. Ibid., subclause 40.6.1.1.2, figure 40-20 – Test modes
3. Ibid., subclause 40.6.1.1.3, figure 40-25 – Test fixtures
4. Ibid., subclause 40.6.1.2.5 – Transmitter Timing Jitter
5. Test suite appendix 40.6.A – 1000BASE-T transmitter test fixtures

Note: The references mentioned here are proposed, and not part of a standard. This is an alternate test method for jitter measurement being proposed, when TX_TCLK is not accessible. This is an informal test method.

Transmitting Timing Jitter (Alternate Method):

Jitter Master Unfiltered — The peak-to-peak value of jitter waveform on data in Test Mode 2 relative to unjittered reference should be less than 1.4 ns (pass).

The peak-to-peak value of jitter waveform on data in Test Mode 2 relative to unjittered reference should be more than 1.4 ns (inconclusive).

Jitter Master Filtered — The peak-to-peak value of jitter waveform on data in Test Mode 2 relative to unjittered reference, when filtered by a high pass filter, $H_{HP}(f)$ with the transfer function below should be less than 0.3 ns (pass).

The peak-to-peak value of jitter waveform on data in Test Mode 2 relative to unjittered reference, when filtered by a high pass filter, $H_{HP}(f)$ with the transfer function below should be more than 0.3 ns (inconclusive).

$$H_{HP}(f) = \frac{jf}{jf + 5000} \text{ } f \text{ in Hz}$$

Jitter Slave Unfiltered — The difference between the peak-to-peak value of jitter waveform on data in Test Mode 3 relative to unjittered reference and the peak-to-peak value of jitter waveform on data in Test Mode 2 relative to unjittered reference should be less than 1.4 ns (pass).

The difference between the peak-to-peak value of jitter waveform on data in Test Mode 3 relative to unjittered reference and the peak-to-peak value of jitter waveform on data in Test Mode 2 relative to unjittered reference should be more

than 1.4 ns (fail).

Jitter Slave Filtered — The difference between the peak-to-peak value of jitter waveform on data in T_{est} Mode 3 relative to unjittered reference, when filtered by a high pass filter, $H_{\text{HP1}}(f)$ with the transfer function below, and the peak-to-peak value of jitter waveform on data in T_{est} Mode 2 relative to unjittered reference, when filtered by a high pass filter, $H_{\text{HP2}}(f)$ with the transfer function below, should be less than 0.4 ns (pass).

The difference between the peak-to-peak value of jitter waveform on data in T_{est} Mode 3 relative to unjittered reference, when filtered by a high pass filter, $H_{\text{HP1}}(f)$ with the transfer function below, and the peak-to-peak value of jitter waveform on data in T_{est} Mode 2 relative to unjittered reference, when filtered by a high pass filter, $H_{\text{HP2}}(f)$ with the transfer function below, should be more than 0.4 ns (fail).

$$H_{\text{HP1}}(f) = \frac{jf}{jf + 5000} \text{ } f \text{ in Hz}$$

$$H_{\text{HP2}}(f) = \frac{jf}{jf + 32000} \text{ } f \text{ in Hz}$$

Distortion Purpose:

To verify that the peak distortion of the DUT is within the conformance limits.

Reference to Standard:

Subclause 40.6.1.2.4 of IEEE standard 802.3-2000

What Standard says:

The peak distortion of the test mode 4 differential signal, when sampled with the symbol rate TX_TCLK at an arbitrary phase and processing this block of any 2047 consecutive samples, should be less than 10 mV.

CM Voltage Purpose:

To verify that the common-mode voltage of the DUT is within the conformance limits.

Reference to Standard:

Subclause 40.8.3.3 of IEEE standard 802.3-2000

What Standard says:

The magnitude of the total common-mode output voltage, Ecm_out, on any transmit circuit, shall be less than 50 mV peak-to-peak when transmitting data.

Return Loss Purpose:

To verify that the return loss of the device under test (DUT) is above the conformance limit.

Reference to Standard:

Subclause 40.8.3.1 of IEEE standard 802.3-2000 ab

What Standard says:

At least 16 dB over the frequency range of 1.0 MHz to 40 MHz and at least $10 - 20 \log_{10}(f/80)$ dB over the frequency range 40 MHz to 100 MHz (f in MHz).

100BASE-TX

Template Purpose:

To verify that the transmitter output fits the time domains transmit templates.

Reference to Standard:

Annex J of ANSI X3.263-1995

What Standard says:

According to standard, Active Output Interface (AOI) transmitting scrambled Halt Line State should fit in the template.

Differential Output Voltage Purpose:

To verify that the differential output voltage of the device under test (DUT) is within the conformance limits.

Reference to Standard:

Subclause 9.1.2.2 of ANSI X3.263-1995

What Standard says:

According to standard, differential output voltage (V_{out}) should lie in the range of 950 mV to 1050 mV in both positive and negative excursion.

Signal Amplitude Symmetry**Purpose:**

To verify that the signal amplitude symmetry of the device under test (DUT) is within the conformance limits.

Reference to Standard:

Subclause 9.1.4 of ANSI X3.263-1995

What Standard says:

The ratio of the + V_{out} magnitude to – V_{out} magnitude shall be between the limits:

$$0.98 \leq |V_{out}| / |-V_{out}| \leq 1.02$$

Rise and Fall Time**Purpose:**

To verify that the response times of the DUT are within the conformance limits.

Reference to Standard:

Subclause 9.1.6 of ANSI X3.263-1995

What Standard says:

Active Output Interface (AOI) rise and fall time shall be in the range of 3.0ns and 5.0ns. Rise and fall times are defined as time difference between 10% and 90% voltage levels. Both positive and negative rise/fall times should be validated.

The difference between the maximum and the minimum of all measured rise and fall times should be less than 0.5 ns.

Waveform Overshoot Purpose:

To verify that the waveform overshoot of the DUT is below the conformance limit.

Reference to Standard:

Subclause 9.1.3 of ANSI X3.263-1995

What Standard says:

According to standard, Overshoot is the percentage excursion of the differential signal transition beyond V_{out} . Differential signal overshoot should not exceed 5%. Both positive and negative overshoot are to be measured.

Jitter Purpose:

To verify that the peak-to-peak jitter of the DUT is within the conformance limits.

Reference to Standard:

Subclause 9.1.9 of ANSI X3.263-1995

What Standard says:

According to standard, the peak-to-peak jitter should not exceed 1.4 ns.

Duty Cycle Distortion Purpose:

To verify that the duty cycle distortion of the DUT is below the conformance limit.

Reference to Standard:

Subclause 9.1.8 of ANSI X3.263-1995

What Standard says:

According to standard, duty cycle distortion should be measured at the 50% voltage points on rise and fall transitions of the differential output waveform and should not exceed ± 0.25 ns.

Return Loss Purpose:

To verify that the return loss at the transmitter or receiver of the device under test (DUT) is above the conformance limit.

Reference to Standard:

Subclause 9.1.5 and 9.2.2 of ANSI X3.263-1995

What Standard says:

Greater than 16 dB from 2 MHz to 30 MHz

Greater than $(16 - 20\log(f/30 \text{ MHz}))$ dB from 30 MHz to 60 MHz

Greater than 10 dB from 60 MHz to 80 MHz

10BASE-T

MAU Ext Purpose:

To verify that the transmitter output equalization meets standard specifications.

Reference to Standard:

Subclause 14.3.1.2.1 of IEEE standard 802.3-2000

What Standard says:

According to standard, the transmitter waveform should lie within the template for all data sequences at the twisted-pair model's output with 100 ohm termination.

MAU Int Purpose:

To verify that the transmitter output equalization meets standard specifications.

Reference to Standard:

Subclause 14.3.1.2.1 of IEEE standard 802.3-2000

What Standard says:

According to standard, the transmitter waveform should lie within the template for all data sequences at the twisted-pair model's output with 100 ohm termination.

TP_IDL Purpose:

To verify that the transmitter functions properly after a transition to the idle state.

Reference to Standard:

Subclause 14.3.1.2.1 of IEEE standard 802.3-2000

What Standard says:

According to standard, the TP_IDL pulse should lie within the template. This test shall be done across each of the specified test loading Load 1, Load 2, Load 3 with and without twisted-pair model.

Link Pulse Purpose:

To verify that the link test pulse waveforms meet specification.

Reference to Standard:

Subclause 14.3.1.2.1 of IEEE standard 802.3-2000

What Standard says:

According to standard, the link test pulse should lie within the template. This test shall be done across each of the specified test loading Load 1, Load 2, Load 3 with and without twisted-pair model.

Differential Voltage Purpose:

To verify that the differential voltage of the DUT is within the conformance limits.

Reference to Standard:

Subclause 14.3.1.2.1 of IEEE standard 802.3-2000

What Standard says:

Peak differential voltage of transmitter waveform when terminated with a 100 ohm resistor should lie between 2.2 V and 2.8 V for all data sequences.

Harmonic Purpose:

To verify that the harmonic content of the DUT is within the conformance limits.

Reference to Standard:

Subclause 14.3.1.2.1 of IEEE standard 802.3-2000

What Standard says:

Harmonic test is done when the DO circuit is driven by all ones. Each harmonic measured at the output of the transmitter shall be at least 27 dB below the fundamental.

Jitter Purpose:

To verify that the jitter of the DUT is within the conformance limits.

Reference to Standard:

Subclause 14.3.1.2.3 of IEEE standard 802.3-2000

Annexure B.4.3.3 Note for 14.3.1.2.3 of IEEE standard 802.3-2000

What Standard says:

The transmitter output jitter when measured at the output of the twisted-pair model should lie within ± 5.5 ns.

As per B.4.3.3 Note for 14.3.1.2.3 of IEEE standard 802.3-2000, failure of this test does not demonstrate noncompliance.

The transmitter output jitter when measured without the twisted-pair model should lie within ± 8.0 ns.

CM Voltage Purpose:

To verify that the common-mode voltage of the DUT is within the conformance limits.

Reference to Standard:

Subclause 14.3.1.2.5 of IEEE standard 802.3-2000

What Standard says:

The magnitude of the total common-mode output voltage of the transmitter, E_{cm} , shall be less than 50 mV peak.

Return Loss Purpose:

To verify that the return loss at the transmitter or receiver of the device under test (DUT) is above the conformance limit.

Reference to Standard:

Subclause 14.3.1.2.2 of IEEE standard 802.3-2000 ab

What Standard says:

At least 15 dB over the frequency range of 5.0 to 10 MHz.

Remote GPIB

About Remote GPIB

To enable Remote GPIB, click **Utilities > Enable Remote GPIB**.

With knowledge of the GPIB command syntax, you can design a GPIB program to do the following tasks:

- Start the TDSET3 application
- Recall the saved setup, either default or the user defined
- Select the technology (speed) and the test
- Configure test parameters
- Run the test
- Retrieve the results for the conducted tests
- Generate Reports
- Save the current setup
- Exit the application

Starting and Setting Up the Application Using GPIB

To start the TDSET3 application, you must send the oscilloscope the following GPIB command:

```
application:activate "Ethernet Compliance Test  
Software"
```

The application uses the GPIB VARIABLE:VALUE command with arguments to execute the supported features.

You must continually query for **application** status. If the status indicates **GPIB disabled**, you must manually enable Remote GPIB by clicking **Utilities > Enable Remote GPIB**.

GPIB Command Syntax

Description

This command accepts string arguments for a control or data variable and a value to which to set the argument.

Syntax

```
VARIABLE:VALUE "<variable name>", "<variable value>"
```

Note:

The arguments <variable name> and <variable value> are required in the order indicated.

VARIABLE:VALUE? <variable name> for query.

Note. Commands are case and space sensitive. Your program will not operate correctly if you do not follow the capitalization and spacing precisely.

TDSET3 Application Command Arguments and Queries

Table 17-1: Command Arguments and Queries

Group / Name	Value	Function	Query Returns
Application			
recall	The setup file name which consists of any string from 1 to 40 characters from A to Z and, or 0 to 9 or special characters like "." or "default". "default" refers to the default file name. If file extension not specified , it is assumed to be .ini.	Recalls the settings for the application from the mentioned file. The directory location of the file is the default (C:\TekApplications\TDSET3\setup. If the file doesn't have appropriate setting values, the default settings will override the same.	Query is not valid.
save	The setup filename, which consists of any string from 1 to 40 characters from A to Z and, or 0 to 9 or Special characters like "."If file extension not specified , it is assumed to be .ini.	Saves the current application settings in the filename specified. The directory location of the file is the default (C:\TekApplications\TDSET3\setup	Query is not valid.
application	exitwrecall, exitworecall	Exits the application	Returns the value of application variable.
application	minimize	Minimizes the active application	Returns the value of application variable.

Table 17-1: Command Arguments and Queries

Group / Name	Value	Function	Query Returns
application	hide	Hides the active application	Returns the value of application variable.
application	maximize	Maximizes the active application	Returns the value of application variable.
Application	show	Shows the application, which was earlier hidden.	Returns the value of application variable.
version	Query only		Returns the version number of the application.
Speed			
speed	1000-T, 100-TX, 10-T	Sets the speed	The value of the set speed
run	on, off	Runs the previously selected test if value is ON Stops the currently running test, if any, if the value is OFF	The value of test variable, on, off
Results			
resultSum	Query only		Returns the summary of the last test conducted, pass, fail
1000Base-T test values for "resultfor" variable			
resultfor	templatea, templateb, templatec, templated, templatef, templateh, peaka, peakb, peakc, peakd, droopg, droopj, jitmasterfilt, jitmasterunfilt, jitslavefilt, jitslaveunfilt, distortionm, returnloss1000, cmvolt1000	Sets the result variables with appropriate result values for that particular test.	
100Base-TX test values for "resultfor" variable			
resultfor	templatepos, templateneg, outputvoltpos, outputvoltneg, ampsym, risetimepos, risetimeneg, falltimepos, falltimeneg, rfsympos, rfsymneg, rfsymmaxmin, overshootpos, overshootneg, jitpos, jitneg, dcdrand, dcd0101, returnlosstx100, returnlossrx100	Sets the result variables with appropriate result values for that particular test.	

Table 17-1: Command Arguments and Queries

Group / Name	Value	Function	Query Returns
10Base-T test values for "resultfor" variable			
resultfor	maunorm, mauinvt, lpload1wotpm, lpload2wotpm, lp100wotpm, lpload1wotpm, lpload2wotpm, lp100wotpm, tpidlload1wotpm, tpidlload2wotpm, tpidl100wotpm, tpidlload1wotpm, tpidlload2wotpm, tpidl100wotpm, diffvoltmaxpos, diffvoltmaxneg, diffvoltpos, diffvoltneg, harmonic, jitwcablenorm, jitwcable8bt, jitwcable85bt, jitwocablenorm, jitwocable8bt, jitwocable85bt, returnlossrx10, returnlossrx10, cmvolt10	Sets the result variables with appropriate result values for that particular test.	
resultstd	Query only		Standard field of the result details, for the test queried
resultmeas	Query only		Measured field of the result details, for the test queried
resultsts	Query only		Status field of the result details, for the test queried
resultrem	Query only		Remark field of the result details, for the test queried
status	Query only		Returns the error code or "stopped" or "running"
harmonics0	Query only		Harmonic test's result measured. Measured results from Harmonic2 to Harmonic5 can be got from this variable
harmonics1	Query only		Harmonic test's result measured. Measured results from Harmonic6 to Harmonic9 can be got from this variable
harmonics2	Query only		Harmonic test's result measured. Measured results from Harmonic10 to Harmonic13 can be got from this variable
harmonics3	Query only		Harmonic test's result measured. Measured results from Harmonic14 to Harmonic17 can be got from this variable
harmonics4	Query only		Harmonic test's result measured. Measured results from Harmonic18 to Harmonic21 can be got from this variable

Table 17-1: Command Arguments and Queries

Group / Name	Value	Function	Query Returns
harmonics5	Query only		Harmonic test's result measured. Measured results from Harmonic22 to Harmonic25 can be got from this variable
status	Query only		Returns the error code or "Test Stopped", "Test running", "Test Complete"
Report Configuration			
report	summary, detail	Invokes the report generation, summary or detailed.	Query not valid.
repname	The setup filename, which consists of any string from 1 to 40 characters from A to Z and, or 0 to 9 or Special characters like "."	Sets the report layout filename	Returns the filename.
deviceid	Any string from 1 to 40 characters from A to Z and, or 0 to 9 with valid Windows, Dos format.	Specifies the device ID field for report generation. This field is visible in several locations throughout the application independent of the report generations panelDefault setting is set to "." 1 space character	Returns the specified DeviceIDApplies to Compliance modules.
portid		Sets the Port id.	Returns the value of port id.
reppairid		Sets the report pair id.	Returns the report pair id.
devicedetails		Sets the devicedetails parameter.	Returns the device details.
process		Sets the value for the process.	Returns the value of process.
volt		Sets the value for the voltage report config.	Returns the value of voltage.
temp		Sets the value for the temperature report config.	Returns the value of temperature.
lastcaldate		Sets the last calibration date.	Returns the last calibration date.
imgport	yes, no	Sets the image port.	Returns the status of image port.
lastrepdet	Query only		Returns the last saved (detailed) report filename.
lastrepsum	Query only		Returns the last saved (summary) report filename.

GPIB Commands for 1000BASE-T

Table 17-2: 1000BASE-T GPIB Commands

Group / Name	Value	Function	Query Returns
Selecting test parameters for 1000BASE-T			
test	templatea, templateb, templatec, templated, templatef, templateh	Selects the template test.	The value of test variable.
test	peaka, peakb, peakc, peakd	Selects the peak volt test.	The value of test variable.
test	templatepeakall	Selects all the template and peak volt tests.	The value of test variable.
test	droopg, droopj, droopall	Selects the droop test.	The value of test variable.
test	jitmasterfilt, jitmasterunfilt	Selects the jitter master test.	The value of test variable.
test	jitslaveunfilt	Selects the jitter slave test.	The value of test variable.
test	distortion	Selects the distortion test.	The value of test variable.
test	returnloss1000	Select the return loss test.	The value of test variable.
test	cmvolt1000	Select the CM voltage test.	The value of test variable.
Configuring test parameters for 1000BASE-T			
avgs:1000	n >= 64 and n <= 10,000	Configures the number of averages for template peak, and droop	The number of averages
avgs4distortion	n >= 64 and n <= 10,000	Configuring the number of averages distortion 1000Base-T test	The number of averages set for distortion test
clkedge	rising/falling	Configures the clock edge for jitter tests	The type of clock edge - rising or falling
data:1000	ch1/ch2/ch3/ch4	Configures the source data for template, peak, droop, jitter, distortion, and cmvoltage tests	The channel chosen for source data
disturber	yes/no	Configures the disturber for template, peak, droop and distortion tests	The status indicating if the disturber is included or not
filter	Int/ext	Configures the filter - internal or external - for template, and peak tests	The type of the filter used, either internal or external
masterclk	ch1/ch2 /ch3/ch4	Configures the master clock for jitter 1000Base-T test	The value of the channel chosen for master clock
meastype	TIE/Histogram	Configures the measure type for unfiltered jitter test	The measure type
slaveclk	ch1/ch2/ch3/ch4	Configures the slave clock for jitter slave test	The value of the channel chosen for slave clock
trigger	ch1/ch2/ch3/ch4	Configures the trigger, when disturber is yes	The channel chosen for trigger
output:1000	ref1/ref2/ ref3/ref4	Configures the output for template, peak, droop and distortion tests	The channel chosen for output

Table 17-2: 1000BASE-T GPIB Commands

Group / Name	Value	Function	Query Returns
reclen	1, 4, 8, 16	Configuring the record length for jitter tests in 1000Base T. This is not present for unfiltered jitter test with measurement type set to Histogram. Default value is max memory available on the Oscilloscope	The value of record length previously set.
resolution	$n \geq 2$ and $n \leq 75$	Configuring the resolution for the distortion test in 1000Base T	The value of the resolution previously set.
txtclsrc	ch1, ch2, ch3, ch4	Configuring the clock, when distortion test is selected and distclk is set to yes, for 1000Base-T	The channel chosen for txtclock source.
txtclk	yes, no	The status indicating if txtclk is included or not	The status indicating if txtclk is included or not
distclk	yes, no	The status indicating if the clock is included or not	The status indicating if the disturber is included or not.
lpfilter	yes, no	Status of the Low Pass filter for distortion tests	The status of the Low Pass filter for distortion tests.
rsrc1:1000	ch1, ch2, ch3, ch4	Configuring the sources P1/P3/P5/P7 for the return loss test in 1000Base T	The value of the source1 for return loss.
rsrc2:1000	ch1, ch2, ch3, ch4	Configuring the sources P2/P4/P6/P8 for the return loss test in 1000Base T	The value of the source2 for return loss.
rloutput:1000	ref1, ref2, ref3, ref4	Configuring the source for the return loss test in 1000Base T	The value of the return loss for output waveform.
rlimit:1000	ref1, ref2, ref3, ref4	Configuring the source for the return loss test in 1000Base T	The value of the limit for output waveform of return loss.
avgtme:1000	$n \geq 100$ and $n \leq 10,000$	Configuring the average time for return loss test for 1000Base T	The value of average time.
smooth:1000	$n \geq 00$ and $n \leq 10$	Configuring the average frequency for return loss test for 1000Base T	The value of average frequency.
pairid	a, b, c, d	Configuring the pair id for return loss test for 1000Base T	The value of the pair id previously set.
load:1000	"load85/100/115","load100"	Configuring the load parameter for return loss test in 1000BaseT	The value of the load parameter
awg:1000	{awgselect,awg4xx/awg2021/awg5xx/awg6xx/awg7xx}	Configure the AWG being used for 1000Base-T return loss tests.	Returns the AWG series being used for 1000Base-T return loss test.
datatm2	ch1, ch2, ch3, ch4	Configuring the data test mode 2 source for the jitter test in 1000Base T	The value of the test mode 2 source for jitter test
datatm3	ch1, ch2, ch3, ch4	Configuring the data test mode 3 source for the jitter test in 1000Base T	The value of the test mode 3 source for jitter test
Hysteresis	{n} $n \geq 5.0$ and $n \leq 30.0$	Configuring the hysteresis value for jitter 1000Base-T tests	The value of hysteresis for jitter tests
Jig Match			
jmmeas	Jmdistall, jmdutamp, jmprobeamp	Measure the jig match parameters	Query not valid.

Table 17-2: 100BASE-T GPIB Commands

Group / Name	Value	Function	Query Returns
jmdef	Jmdistall, jmdutamp, jmprobeamp	Set the jig match parameters to default	Query not valid.
jmlastjm	Query only		Returns the last jig match parameter measured
jmamp	Query only		Returns the value of the amp.
jmfreq	Query only		Returns the value of the freq.
jmdutamp	Query only		Returns the value of the DUT amp.
jmprobeamp	Query only		Returns the value of the probe point amp.
jmatten	Query only		Returns the value of the atten.
jmstatus	Query only		Returns the Jig Match status, either jmon/jmoff.ON indicates jig match measure is in progress.
jmaction	jmapply, jmcancel		Applies the measured values or cancels the same.

GPIB Commands for 100BASE-TX

Table 17-3: 100BASE-TX GPIB Commands

Group / Name	Value	Function	Query Returns
Selecting test parameters for 100BASE-TX			
test	template, templatepos, templateneg	Selects the template test and the polarity	The value of test variable.
test	outputvoltboth, outputvoltpos, outputvoltneg	Selects the output volt test and the polarity	The value of test variable.
test	ampsym	Selects the amp sym test	The value of test variable.
test	risetimeboth, risetimepos, risetimeneg	Selects the rise time test and the polarity	The value of test variable.
test	falltimeboth, falltimepos, falltimeneg	Selects the fall time test and the polarity	The value of test variable.
test	rfsymboth, rfsympos, rfsymneg	Selects the rfsym test, with the polarity	The value of test variable.
test	overshootboth, overshootpos, overshootneg	Selects the overshoot test, with the polarity	The value of test variable.
test	jitboth, jitpos, jitneg	Selects the jitter test and the polarity	The value of test variable.
test	dcdrand, dcd0101	Selects the distortion test and pattern values	The value of test variable.
test	all	Selects all the 100-Tx tests with polarity as "both" and pattern as "random"	The value of test variable.

Table 17-3: 100BASE-TX GPIB Commands

Group / Name	Value	Function	Query Returns
test	returnlosstx100, returnlossrx100	Select the return loss test	The value of test variable.
Configuring test parameters for 100BASE-TX			
acq:100	sample, avg	Configures the acquisition to sample or average for all 100Base-T tests except template and jitter	The type of acquisition
data:100	ch1, ch2, ch3, ch4	Configures the source data for tests	The channel chosen for source data
pulsewidth	16, 80	Configures the pulse width for rise, fall time test, R/F sym test	The pulse width value
maskscale	norm,0.95,1.05	Configuring the template scale for template tests of 100 Base T	The value of template scale.
rsrc1:100	ch1, ch2, ch3, ch4	Configuring the sources P1, P3 for the return loss test in 100-Tx	The value of the source1 for return loss.
rsrc2:100	ch1, ch2, ch3, ch4	Configuring the sources P2, P4 for the return loss test in 100-Tx	The value of the source2 for return loss.
rloutput:100	ref1, ref2, ref3, ref4	Configuring the source for the return loss test in 100-Tx	The value of the return loss for output waveform.
rllimit:100	ref1, ref2, ref3, ref4	Configuring the source for the return loss test in 100-Tx	The value of the limit for output waveform of return loss.
avgtime:100	n >= 100 and n <= 10,000	Configuring the average time for return loss test for 100-Tx	The value of average time.
smooth:100	n >= 0 and n <= 10	Configuring the average frequency for return loss test for 100-Tx	The value of average frequency.
load:100	"load85, 100, 115","load100"	Configuring the load parameter for return loss test in 100BaseTx	The value of the load parameter
awg:100	awg4xx, awg2021, awg5xx, awg6xx, awg7xx	Configure the AWG being used for 100BaseTx return loss tests.	Returns the AWG series being used for 100BaseTx return loss test.

GPIB Commands for 10BASE-T

Table 17-4: 10BASE-T GPIB Commands

Group / Name	Value	Function	Query Returns
Selecting test parameters for 10BASE-T			
test	mauboth, maunorm, mauinv	Selects the mau test with both, normal or inverted	The value of test variable.
test	lload1wotpm, lload2wotpm, lp100wotpm, lload1wtpm, lload2wtpm, lp100wtpm	Selects the link pulse with load test	The value of test variable.

Table 17-4: 10BASE-T GPIB Commands

Group / Name	Value	Function	Query Returns
test	tpidload1wotpm, tpidload2wotpm, tpidl100wotpm, tpidload1wtpm, tpidload2wtpm, tpidl100wtpm	Selects the tp idl with load test	The value of test variable.
test	diffvoltmax, diffvoltall	Selects the diff volt test	The value of test variable.
test	harmonic	Selects the harmonic test	The value of test variable.
test	jitwcableall, jitwcablenorm, jitwcable8bt, jitwcable85bt, jitwocableall, jitwocablenorm, jitwocable8bt, jitwocable85bt	Selects the jitter test, with or without cable	The value of test variable.
test	returnlosstx10, returnlossrx10	Select the return loss test	The value of test variable.
test	cmvolt10	Select the CM voltage test	The value of test variable.

Configuring test parameters for 10BASE-T

acq:10	sample, avg	Configures the acquisition to sample or average for link pulse and tp_idl tests	The type of acquisition
avgs:10	n >= 2 and n <= 10,00,000	Configures the number of averages for harmonic test	The number of averages
data:10	ch1, ch2, ch3, ch4	Configures the source data	The channel chosen for source data
masksel	both, head, tail	Configures the mask selection section for link pulse or TP_IDL tests	The mask selection
mauscale	norm, 0.9, 1.1	Configures the MAU scale for MAU template test	The mau scale value, either normal or 0.9 or 1.1
mautype	int, ext	Configures the mau type for jitter with, without cable (parameteric) and MAU (template) tests	The MAU type, either internal or external
timescale	10, 1	Configures the time scale for harmonic test	The time scale value
linkseq	Norm, fast	Configuring the sequence for Link Pulse test in 10Base T	The type of sequencing.
testoptions	both, template, timing	Configuring the test options for the link pulse test in 10BaseT	The test option chosen for the link pulse test.
output:10	math1, math2, math3, math4	Configures the output for harmonic test	The channel chosen for output
rlsrc1:10	ch1, ch2, ch3, ch4	Configuring the sources P1, P3 for the return loss test in 10Base T	The value of the source1 for return loss.
rlsrc2:10	ch1, ch2, ch3, ch4	Configuring the sources P2, P4 for the return loss test in 10Base T	The value of the source2 for return loss.

Table 17-4: 10BASE-T GPIB Commands

Group / Name	Value	Function	Query Returns
rloutput:10	ref1, ref2, ref3, ref4	Configuring the source for the return loss test in 10Base T	The value of the return loss for output waveform.
rlimit:10	ref1, ref2, ref3, ref4	Configuring the source for the return loss test in 10Base T	The value of the limit for output waveform of return loss.
avgtime:10	n >= 100 and n <= 10,000	Configuring the average time for return loss test for 10Base T	The value of average time.
smooth:10	n >= 0 and n <= 10	Configuring the average frequency for return loss test for 10Base T	The value of average frequency.
load:10	"load85, 100, 111", "load100"	Configuring the load parameter for return loss test in 10BaseT	The value of the load parameter
awg:10	awg4xx, awg2021, awg5xx, awg6xx, awg7xx	Configure the AWG being used for 10BaseT return loss tests.	Returns the AWG series being used for 10BaseT return loss test.

GPIB Commands for AWG Automation

Table 17-5: AWG Automation GPIB Commands

Group / Name	Value	Function	Query Returns
AWG Automation			
automate	gpib, manual	Sets the AWG automation to GPIB mode or manual mode.	Returns the current mode of automation.
boardtype	GPIB0, GPIB1, GPIB2, GPIB3, GPIB4, GPIB5, GPIB6, GPIB7, GPIB8, GPIB9	Sets the GPIB board type to the specified value. This will be used if the AWG is automated.	Returns the board type being used for automation of AWG.
priaddr	n, where n = 0 to 30	Sets the primary address to the specified value. This will be used if the AWG is automated.	Returns the primary address over which the oscilloscope talks to the AWG if the automation mode is GPIB.
secaddr	n, where n = 0 to 30	Sets the secondary address to the specified value. This will be used if the AWG is automated.	Returns the secondary address over which the oscilloscope talks to the AWG if the automation mode is GPIB.
testconn	start	Initiates the connection testing process.	No Query supported. "status" can be queried to know the result of test connection.

Program Example

The program example shows how to communicate to the TDSET3 application using remote GPIB commands.

The oscilloscope hard disk and optional application compact disc both contain the file, **DefaultRun.c**. On the hard drive, the file resides in the *C:\TekApplications\TDSET3\GPIBExamples* directory.

The Program Example shows how a GPIB program executes the application to do the following tasks:

- Start the TDSET3 application
- Run the test
- Retrieve the results for the conducted tests
- Recall the default setup

In this example, you will recall the default setup. You can use the **File> Save** function in the application to save setup files.

```
#ifdef __cplusplus
extern "C"{
#endif
#include <windows.h>
#include <stdio.h>
#include <stdlib.h>
#include "decl-32.h"
#ifdef __cplusplus
}
#endif

/* Forward Declarations */
int start_application(int Oscilloscope);
int exit_application(int Oscilloscope);
int recall_setup(int Oscilloscope, char* filename);
int recall_defaultsetup(int Oscilloscope) ;
int run_single_test (int Oscilloscope);
void query_results(int Oscilloscope) ;
void GPIBCleanup(int ud, char* ErrorMessage);
// parameters needed to access the device driver handler
```

```
#define BDINDEX 0 // Board Index
#define PRIMARY_ADDR_OF_DMM 1 // Primary address of device
#define NO_SECONDARY_ADDR 0 // Secondary address of device
#define TIMEOUT T10s // Timeout value = 10 seconds
#define EOTMODE 1 // Enable the END message
#define EOSMODE 0 // Disable the EOS mode
#define APP_NOT_RUNNING -1
#define RGPIB_ENABLED 1
#define RGPIB_DISABLED 0
char ErrorMnemonic[21][5] = {"EDVR", "ECIC", "ENOL", "EADR", "EARG",
"ESAC", "EABO", "ENEB", "EDMA", "",
"EOIP", "ECAP", "EFSO", "", "EBUS",
"ESTB", "ESRQ", "", "", "", "ETAB"};
/*
* After each GPIB call, the application checks whether the call
* succeeded. If an NI-488.2 call fails, the GPIB driver sets the
* corresponding bit in the global status variable. If the call
* failed, this procedure prints an error message, takes
* the device offline and exits.
*/
//-----
int main()
{
    int Dev;
    char write_buffer[100];
    int status;
    int nAppStatus = -1;
```

```
Dev = ibdev (BDINDEX, PRIMARY_ADDR_OF_DMM, NO_SECONDARY_ADDR,  
TIMEOUT, EOTMODE, EOSMODE);  
if (ibsta & ERR)  
{  
    GPIBCleanup(Dev, "Unable to open device");  
}  
else  
{  
    printf("My device id - %i", Dev);  
}  
sprintf(write_buffer, "%s", "header off");  
status = ibwrt(Dev, write_buffer, strlen(write_buffer));  
nAppStatus = start_application(Dev);  
if ( nAppStatus == RGPIB_ENABLED )  
{  
    printf("\nApplication started..\n");  
}  
else if ( nAppStatus == RGPIB_DISABLED )  
{  
    printf("\nRGPIB is disabled, please enable it and then press  
Enter to continue");  
    getchar();  
}  
else if ( nAppStatus == APP_NOT_RUNNING )  
{  
    exit_application(Dev);  
    // leave the device back elegantly
```

```
        printf("Cleanup: Taking device offline\n");
        ibonl(Dev, 0);
        exit(0);
    }
    run_single_test(Dev);
    printf("\nRun single test complete now..\n");
    query_results(Dev);
    printf("\nQuery results complete now..\n");
    recall_defaultsetup(Dev);
    printf("\nRecall Default complete now..\n");
    printf("Cleanup: Taking device offline\n");
    ibonl(Dev, 0);

    printf("Press any key to exit this sample application..\n");
    getchar();
}
//-----
/* Start Ethernet Compliance Test Software application */
int start_application( int Oscilloscope )
{
    char write_buffer[100];
    char read_buffer[100];
    int status;
    int timer = 1;
    /* Start the application */
    sprintf(write_buffer, "%s", "Application:activate \"Ethernet
Compliance Test Software\"");
    status = ibwrt(scope, write_buffer, strlen(write_buffer));
}
```

```
if (ibsta & ERR)
{
    GPIBCleanup(scope, "Unable to start the application");
    return 0;
}
while (1)
{
    // Check whether application has started
    sprintf(write_buffer, "%s", "Variable:value? \"application\");
    status = ibwrt(scope, write_buffer, strlen(write_buffer));
    status = ibrd(scope, read_buffer, sizeof(read_buffer));
    read_buffer[ibcnt] = '\0';
    if ( strcmp(read_buffer, "\"GPIB Enabled\"\n") == 0 )
    {
        return RGPIB_ENABLED;
    }
    else if (strcmp(read_buffer, "\"GPIB Disabled\"\n") == 0 )
    {
        return RGPIB_DISABLED;
    }
    timer++;
    if (timer >500)
    {
        return 0;
    }
    sleep(1000);
}
```



```
        return APP_NOT_RUNNING;
    }
//-----
int exit_application(int oscilloscope)
{
    char write_buffer[100];
    printf("Exit Application ..\n");
    sprintf(write_buffer, "%s", "Variable:value
    \"application\", \"exitworecall\"");
    ibwrt(scope, write_buffer, strlen(write_buffer));
    return 1;
}
//-----
int recall_setup(int oscilloscope, char* filename)
{
    char write_buffer[100];
    int status;
    /* recall setup */
    sprintf(write_buffer, "%s%s%s", "Variable:value \"recall\",\",\",
    filename, "\");
    status = ibwrt(scope, write_buffer, strlen(write_buffer));
    if (ibsta & ERR)
    {
        GPIBCleanup(scope, "Unable to communicate with oscilloscope");
        return 0;
    }
    return 1;
}
```

```
}  
//-----  
int recall_defaultsetup(int Oscilloscope)  
{  
    char write_buffer[100];  
    int status;  
    /* recall default setup */  
    sprintf(write_buffer, "%s", "Variable:value \"recall\", \"Default\"");  
    status = ibwrt(scope, write_buffer, strlen(write_buffer));  
    if (ibsta & ERR)  
    {  
        GPIBCleanup(scope, "Unable to communicate with Oscilloscope");  
        return 0;  
    }  
    return 1;  
}  
//-----  
int run_single_test (int Oscilloscope)  
{  
    char write_buffer[100];  
    char read_buffer[100];  
    int timer;  
    sprintf(write_buffer, "%s", "Variable:value \"run\", \"on\"");  
    ibwrt(scope, write_buffer, strlen(write_buffer));  
    printf("Executing Test..\n");  
    sleep(1000);  
    // wait for application to come to Ready State
```

```
timer = 1;
while (1)
{
    timer++;
    if (timer > 500)
    {
        printf("*****Test Time Out *****\n");
        return 0;
    }
    sprintf(write_buffer, "%s", "variable:value? \"run\"");
    ibwrt(scope, write_buffer, strlen(write_buffer));
    /* read the answer */
    ibrd(scope, read_buffer, 99);
    if (ibsta & ERR)
    {
        GPIBCleanup(scope, "Unable to write to device");
    }
    read_buffer[ibcnt - 1] = '\0';
    if (strcmp(read_buffer, "\"off\"") == 0)
    {
        printf("Test Completed or stopped ..\n");
        return 1;
    }
    sleep(1000);
}
}
//-----
```

```
void query_results(int oscilloscope)
{
    char write_buffer[100];
    char read_buffer[100];
    // Check for errors
    sprintf(write_buffer, "%s", "variable:value? \"status\");
    ibwrt(scope, write_buffer, strlen(write_buffer));
    /* read the answer */
    ibrd(scope, read_buffer, 99);
    if (ibsta & ERR)
    {
        GPIBCleanup(scope, "Unable to write to device");
    }
    read_buffer[ibcnt - 1] = '\0';
    if (strcmp(read_buffer, "\"Test Complete\"") != 0)
    {
        printf("Error has occurred. %s\n", read_buffer);
    }
    else
    printf("\nstatus is %s\n", read_buffer);
    // If no error, check for results
    //result summary
    sprintf(write_buffer, "%s", "variable:value? \"resultsum\");
    ibwrt(scope, write_buffer, strlen(write_buffer));
    /* read the answer */
    ibrd(scope, read_buffer, 99);
    if (ibsta & ERR)
```

```
{
    GPIBCleanup(scope, "Unable to write to device");
}
read_buffer[ibcnt - 1] = '\\0';
printf("Result summary : %s\\n",read_buffer);
//result standard
sprintf(write_buffer, "%s", "variable:value? \\\"resultstd\\\"");
ibwrt(scope, write_buffer, strlen(write_buffer));
/* read the answer */
ibrd(scope, read_buffer, 99);
if (ibsta & ERR)
{
    GPIBCleanup(scope, "Unable to write to device");
}
read_buffer[ibcnt - 1] = '\\0';
printf("Result standard : %s\\n",read_buffer);
//result measured
sprintf(write_buffer, "%s", "variable:value? \\\"resultmeas\\\"");
ibwrt(scope, write_buffer, strlen(write_buffer));
/* read the answer */
ibrd(scope, read_buffer, 99);
if (ibsta & ERR)
{
    GPIBCleanup(scope, "Unable to write to device");
}
read_buffer[ibcnt - 1] = '\\0';
printf("Result Measured : %s\\n",read_buffer);
```

```
//result remarks
sprintf(write_buffer, "%s", "Variable:value? \"resultrem\");
ibwrt(scope, write_buffer, strlen(write_buffer));
/* read the answer */
ibrd(scope, read_buffer, 99);
if (ibsta & ERR)
{
    GPIBCleanup(scope, "Unable to write to device");
}
read_buffer[ibcnt - 1] = '\0';
printf("Result Remarks : %s\n",read_buffer);
//result status
sprintf(write_buffer, "%s", "Variable:value? \"resultsts\");
ibwrt(scope, write_buffer, strlen(write_buffer));
/* read the answer */
ibrd(scope, read_buffer, 99);
if (ibsta & ERR)
{
    GPIBCleanup(scope, "Unable to write to device");
}
read_buffer[ibcnt - 1] = '\0';
printf("Result Status : %s\n",read_buffer);
}
//-----
void GPIBCleanup(int ud, char* ErrorMessage)
{
    printf("Error : %s\nibsta = 0x%x iberr = %d (%s)\n",
```

```
ErrorMsg, ibsta, iberr, ErrorMnemonic[iberr]);  
if (ud != -1)  
{  
    printf("Cleanup: Taking device offline\n");  
    ibonl(ud, 0);  
}  
exit(0);  
}  
//-----
```

Guidelines to GPIB Programming

The application includes an example file of a GPIB program. Your GPIB program should comply with the following guidelines:

- You need to manually enable Remote GPIB by clicking Utilities > Enable Remote GPIB. The Remote GPIB remains enabled or disabled until you manually change it.
- You need to connect a separate GPIB cable between the PC and the oscilloscope for GPIB to work. GPIB commands do not work through LAN.
- You need to ensure that the startup is complete before sending additional GPIB commands to the application.
- After sending a GPIB command to activate the application, you can send a remote GPIB command to query for application variable to check if the application is activated or not and to know the GPIB status that is enabled or disabled.
- You need to include delay between commands in the GPIB command script.
- You can query for test results after the test is run and complete.
- Before running the GPIB commands, you can query for *IDN? variable to identify the Oscilloscope and ensure that the Oscilloscope is responding.
- You can query for the status variable to either know if the tests is complete or ensure that an error has not occurred.

- Ensure that you are in the appropriate technology for which you are selecting or configuring test parameters.
- You can query for lastrepedet variable to know where the last detailed report is saved.
- You can query for lastrepsum variable to know where the last report summary is saved.
- You can query for jmstatus variable to know if the application is compensating a disturber or test fixture. Do not query for Jig Match parameters if the jmstatus variable is ON.
- You can query for variables harmonicres0 to harmonicres5 to view the harmonic test results.

Notes:

- *The application does not respond to commands that were sent before the application was activated.*
 - *GPIB commands do not work through LAN.*
 - *Remote GPIB commands does not support View Waveform functionality.*
 - *When the application processes remote GPIB commands, all the relevant message boxes are disabled.*
 - *If you are in the Select pane while sending GPIB commands for configuring a test parameter, the application does not display the configure pane. But if you are in the Configure pane while sending GPIB commands for selecting a test, the application will display the Select pane.*
 - *The Result Details variables such as resultmeas, resultstd, or resultsts are updated only after the selected test is run. If the tests run are either 1000Base-T Select All, or 100Base-T All the result details variables will be updated only after you chose the test for which you would like to see the results for by setting the resultsfor variable with the test name.*
 - *While running a test, the remote GPIB commands are not processed until the test is complete.*
 - *Do not operate User Interface and Front panel of the oscilloscope manually.*
 - *The application does not display the report irrespective of the preview option being enabled or disabled.*
-

Calibration for Return Loss

1000BASE-T Return Loss

Use TC1 of the test fixture for calibration. Make the connections as shown by the following figure.

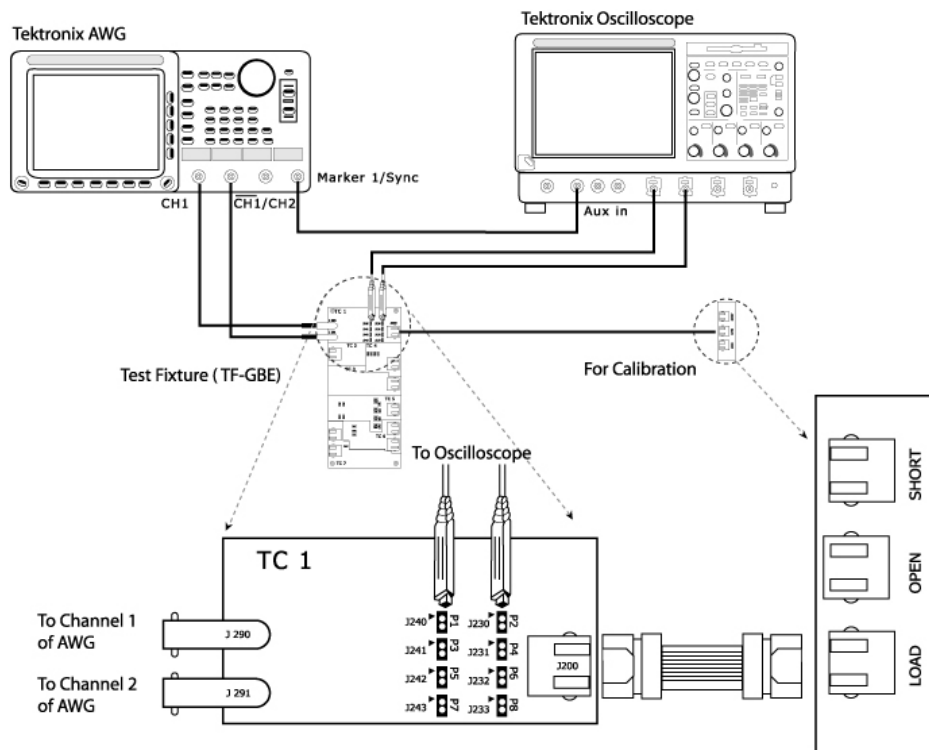

Figure 18-1: Calibration for 1000BASE-T Return Loss

1. Click Tests > Select > 1000BASE-T from the menu bar.
2. In the Return Loss tab, select **Return Loss**.
3. Select **Tests > Connect** or **Connect** to display the Connect pane.

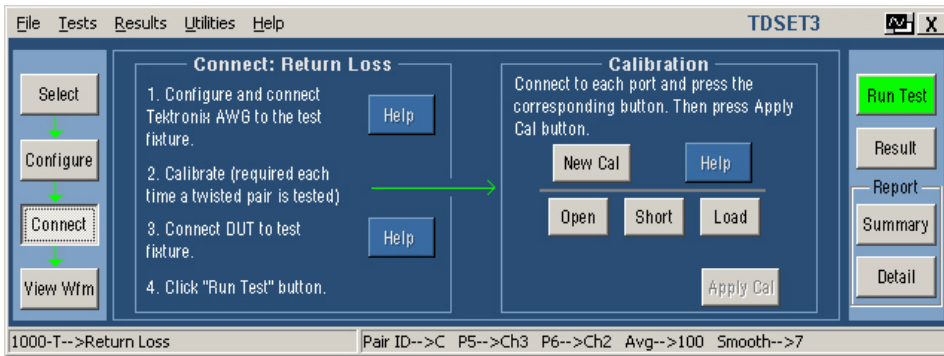

Figure 18-2: Connect pane of 1000BASE-T Return Loss

Note: The Open, Load and Short button are enabled only after you press New Cal.

4. Click on New Cal.
5. Connect CAT5 cable to J200 of TC1 and J702 (OPEN).
6. Click Open. Once the open calibration is complete, the string Done appears below the selected calibration. The following figure shows a typical waveform for Return Loss Open Calibration.

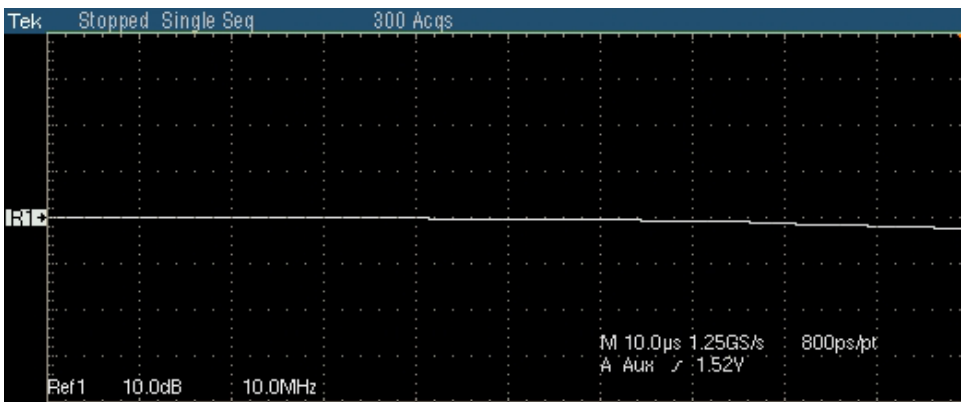

Figure 18-3: Waveform of 1000BASE-T Return Loss Open Calibration

7. Connect CAT5 cable to J200 of TC1 and J703 (SHORT).
8. Click Short. Once the Short calibration is complete, the string Done appears below the selected calibration. The following figure shows a typical waveform for Return Loss Short Calibration.

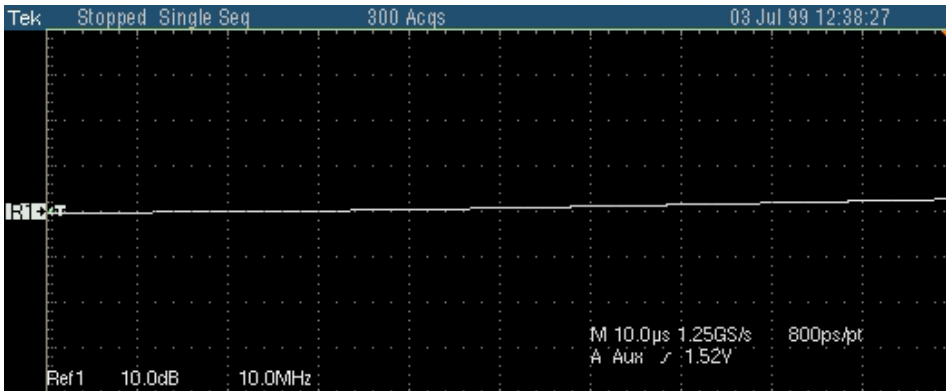

Figure 18-4: Waveform of 1000BASE-T Return Loss Short Calibration

9. Connect CAT5 cable to J200 of TC1 and J704 (LOAD).
10. Click Load. Once the Load calibration is complete, the string Done appears below the selected calibration. The following figure shows a typical waveform for Return Loss Load Calibration.

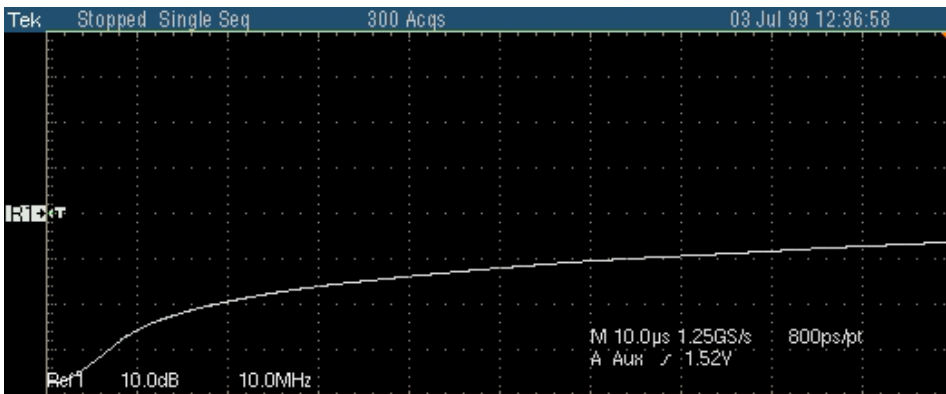

Figure 18-5: Waveform of 1000BASE-T Return Loss Load Calibration

11. After all the calibrations are complete, the Apply Cal button is enabled.
12. Click Apply Cal. The calibration is complete.
13. To clear the calibrations and recalibrate, click on New Cal again.

100BASE-TX Return Loss Transmitter

Use TC1 of the test fixture for calibration. Make the connections as shown by the following figure.

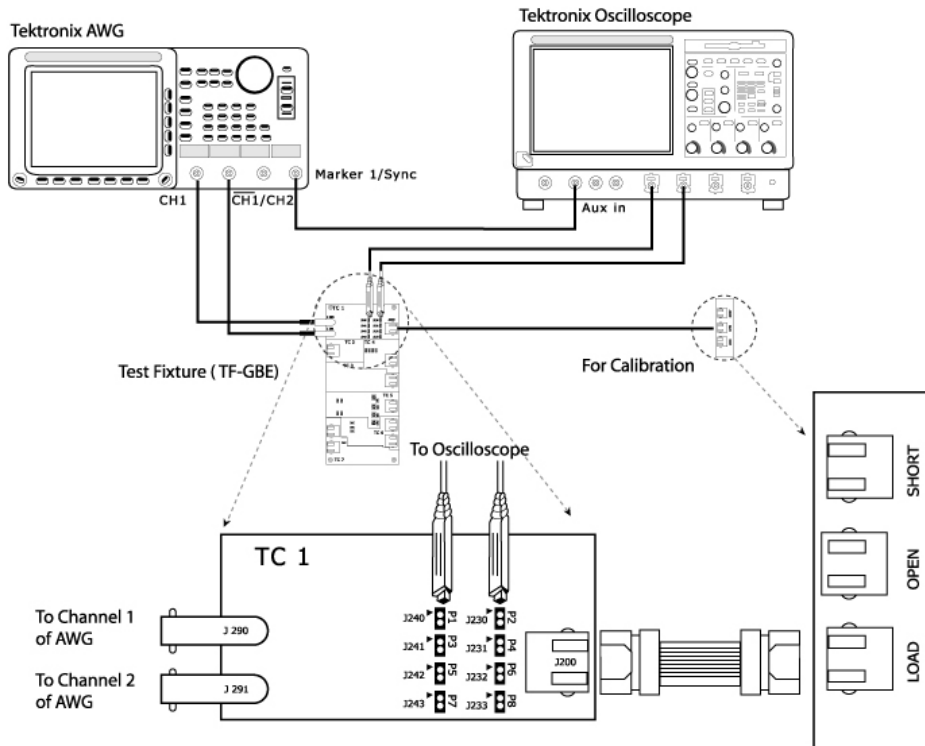

Figure 18-6: Calibration for 100BASE-TX Return Loss

1. Click Tests > Select > 100BASE-TX from the menu bar.
2. In the Return Loss tab, select **Transmitter**.
3. Select **Tests > Connect** or **Connect** to display the Connect pane.

***Note:** The Open, Load and Short button are enabled only after you press New Cal.*

4. Click on New Cal.
5. Connect CAT5 cable to J200 of TC1 and J702 (OPEN).
6. Click Open. Once the open calibration is complete, the string Done appears below the selected calibration. The following figure shows a typical waveform for Return Loss Open Calibration.

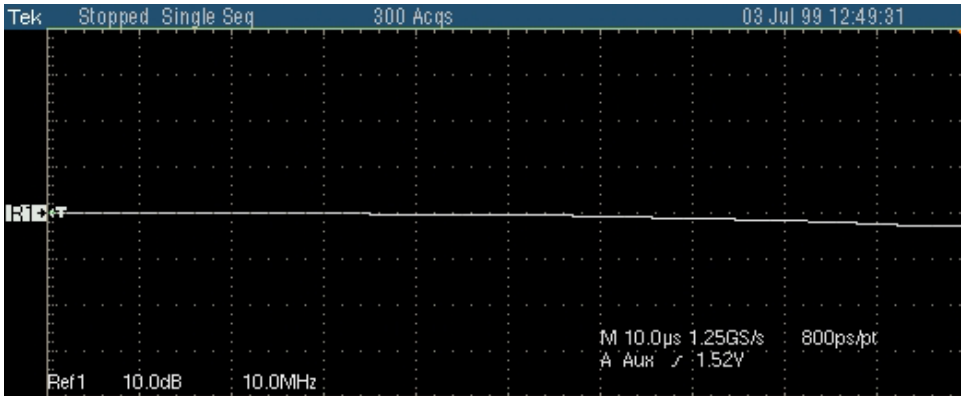

Figure 18-7: Waveform of 100BASE-TX Return Loss Open Calibration

7. Connect CAT5 cable to J200 of TC1 and J703 (SHORT).
8. Click Short. Once the Short calibration is complete, the string Done appears below the selected calibration. The following figure shows a typical waveform for Return Loss Short Calibration.

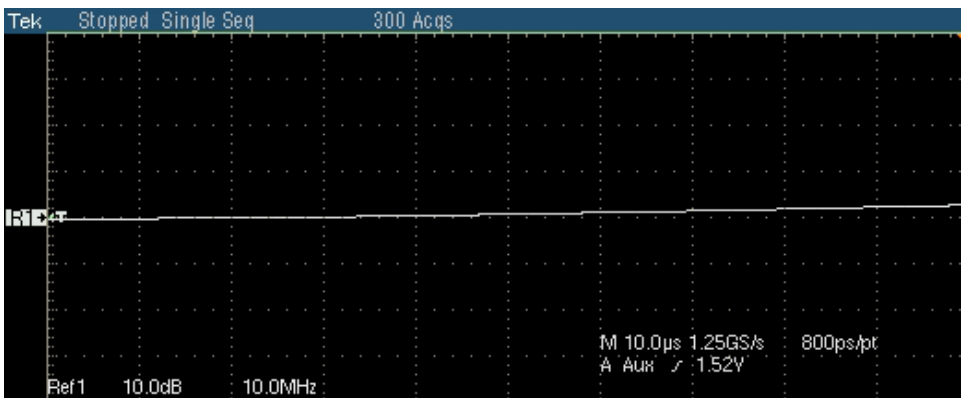

Figure 18-8: Waveform of 100BASE-TX Return Loss Short Calibration

9. Connect CAT5 cable to J200 of TC1 and J704 (LOAD).
10. Click Load. Once the Load calibration is complete, the string Done appears below the selected calibration. The following figure shows a typical waveform for Return Loss Load Calibration.

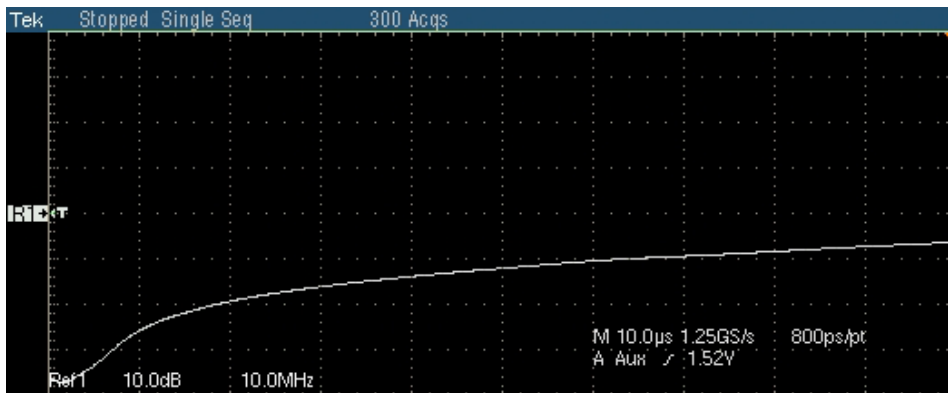

Figure 18-9: Waveform of 100BASE-TX Return Loss Load Calibration

11. After all the calibrations are complete, the Apply Cal button is enabled.
12. Click Apply Cal. The calibration is complete.
13. To clear the calibrations and recalibrate, click on New Cal again.

100BASE-TX Return Loss Receiver

Use TC1 of the test fixture for calibration. Make the connections as shown by the following figure.

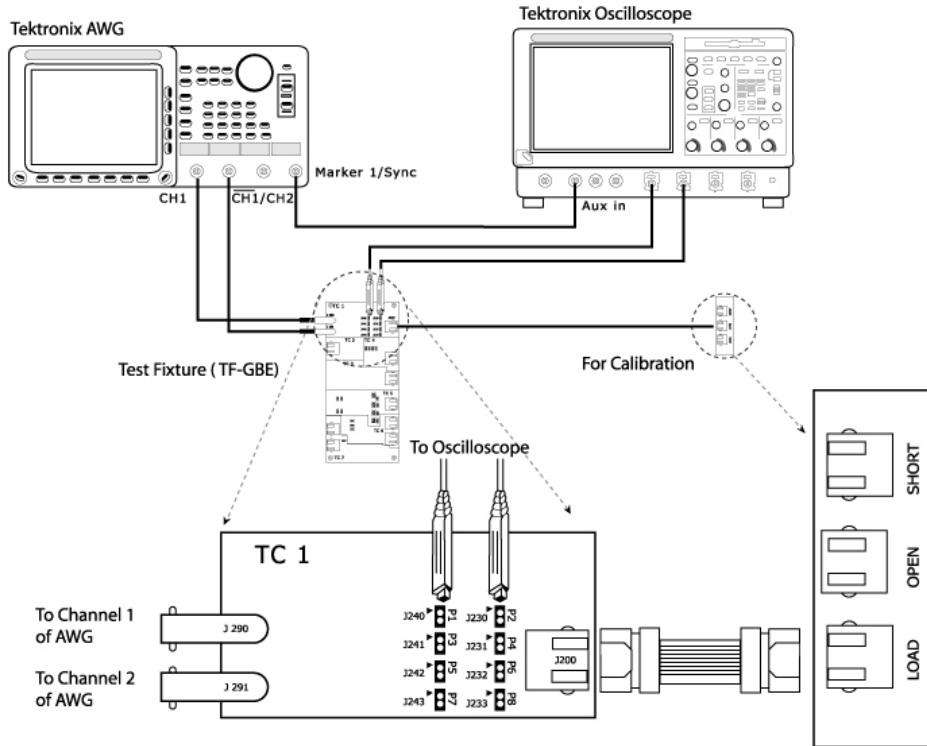

Figure 18-10: Calibration for 100BASE-TX Return Loss

1. Click Tests > Select > 100BASE-TX from the menu bar.
2. In the Return Loss tab, select **Receiver**.
3. Select **Tests > Connect** or **Connect** to display the Connect pane.

Note: The Open, Load and Short button are enabled only after you press New Cal.

4. Click on New Cal.
5. Connect CAT5 cable to J200 of TC1 and J702 (OPEN).
6. Click Open. Once the open calibration is complete, the string Done appears below the selected calibration. The following figure shows a typical waveform for Return Loss Open Calibration.

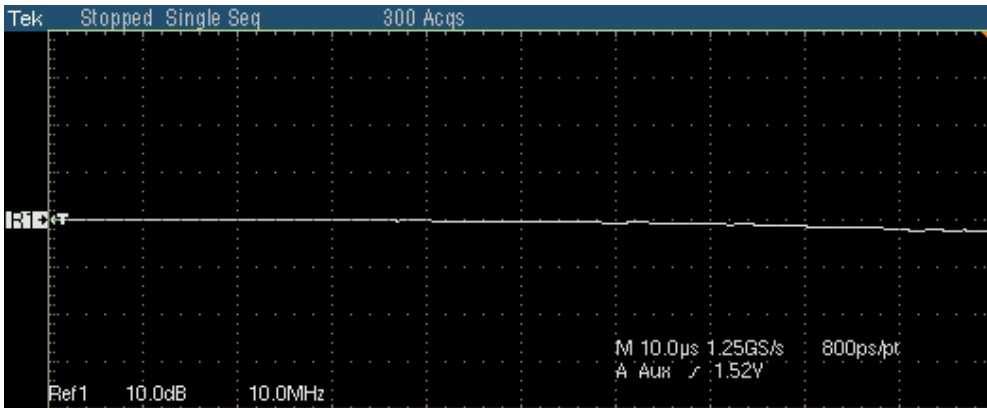

Figure 18-11: Waveform of 100BASE-TX Return Loss Open Calibration

7. Connect CAT5 cable to J200 of TC1 and J703 (SHORT).
8. Click Short. Once the Short calibration is complete, the string Done appears below the selected calibration. The following figure shows a typical waveform for Return Loss Short Calibration.

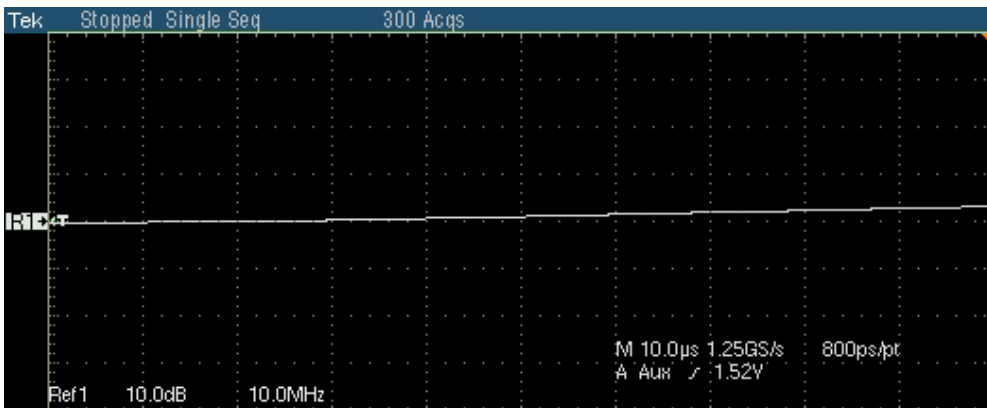

Figure 18-12: Waveform of 100BASE-TX Return Loss Short Calibration

9. Connect CAT5 cable to J200 of TC1 and J704 (LOAD).
10. Click Load. Once the Load calibration is complete, the string Done appears below the selected calibration. The following figure shows a typical waveform for Return Loss Load Calibration.

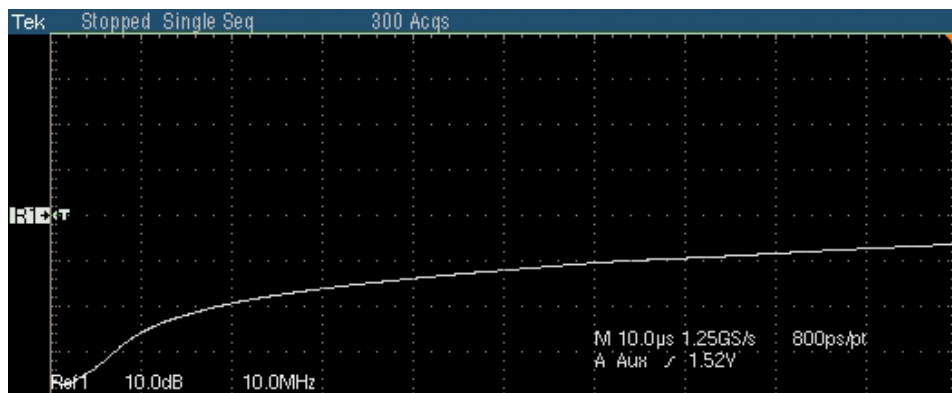

Figure 18-13: Waveform of 100BASE-TX Return Loss Load Calibration

11. After all the calibrations are complete, the Apply Cal button is enabled.
12. Click Apply Cal. The calibration is complete.
13. To clear the calibrations and recalibrate, click on New Cal again.

10BASE-T Return Loss Transmitter

Use TC1 of the test fixture for calibration. Make the connections as shown by the following figure.

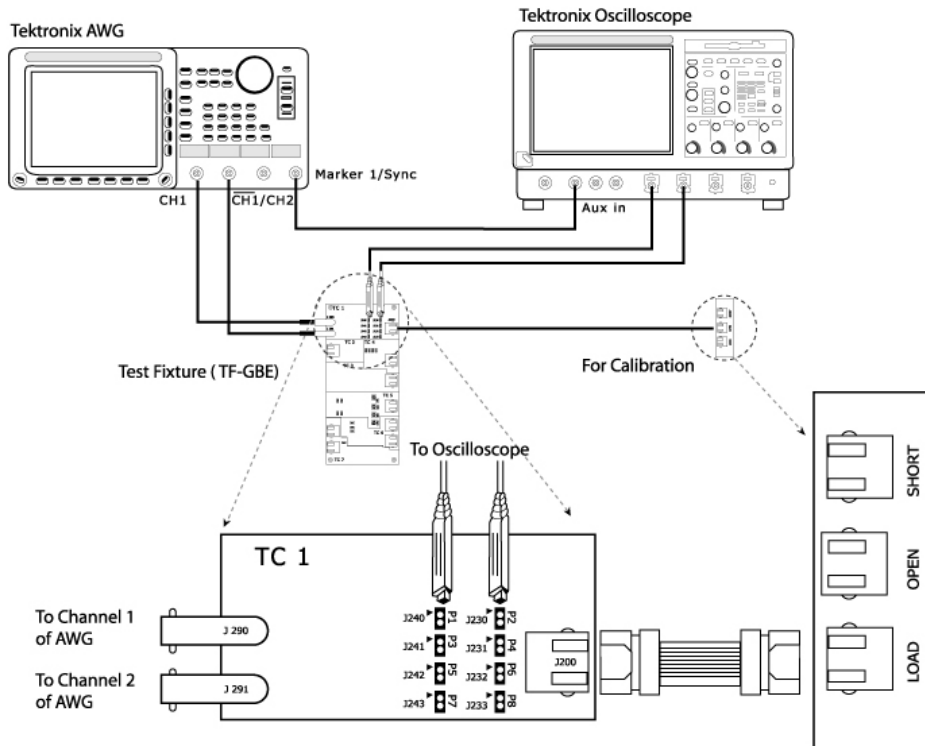

Figure 18-14: Calibration for 10BASE-T Return Loss

1. Click Tests > Select > 10BASE-T from the menu bar.
2. In the Return Loss tab, select **Transmitter**.
3. Select **Tests > Connect** or **Connect** to display the Connect pane.

Note: The Open, Load and Short button are enabled only after you press New Cal.

4. Click on New Cal.
5. Connect CAT5 cable to J200 of TC1 and J702 (OPEN).
6. Click Open. Once the open calibration is complete, the string Done appears below the selected calibration. The following figure shows a typical waveform for Return Loss Open Calibration.

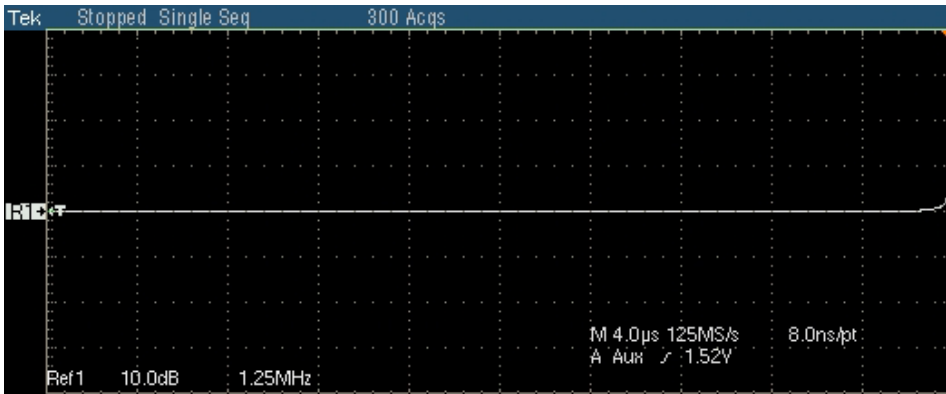

Figure 18-15: Waveform of 10BASE-T Return Loss Open Calibration

7. Connect CAT5 cable to J200 of TC1 and J703 (SHORT).
8. Click Short. Once the Short calibration is complete, the string Done appears below the selected calibration. The following figure shows a typical waveform for Return Loss Short Calibration.

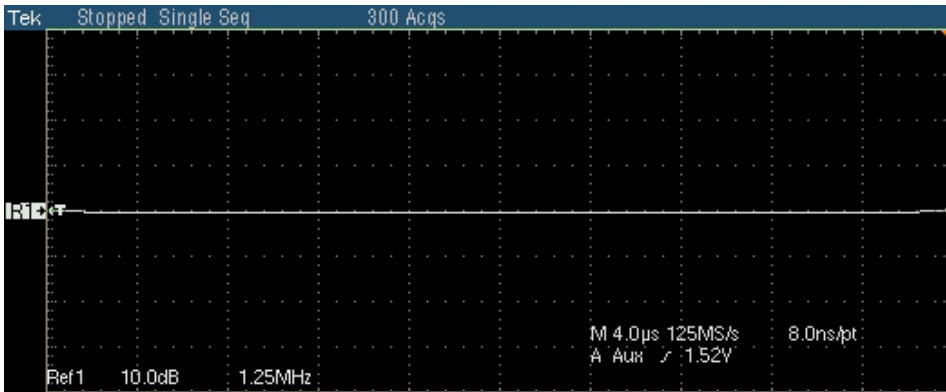

Figure 18-16: Waveform of 10BASE-T Return Loss Short Calibration

9. Connect CAT5 cable to J200 of TC1 and J704 (LOAD).
10. Click Load. Once the Load calibration is complete, the string Done appears below the selected calibration.

11. The following figure shows a typical waveform for Return Loss Load Calibration.

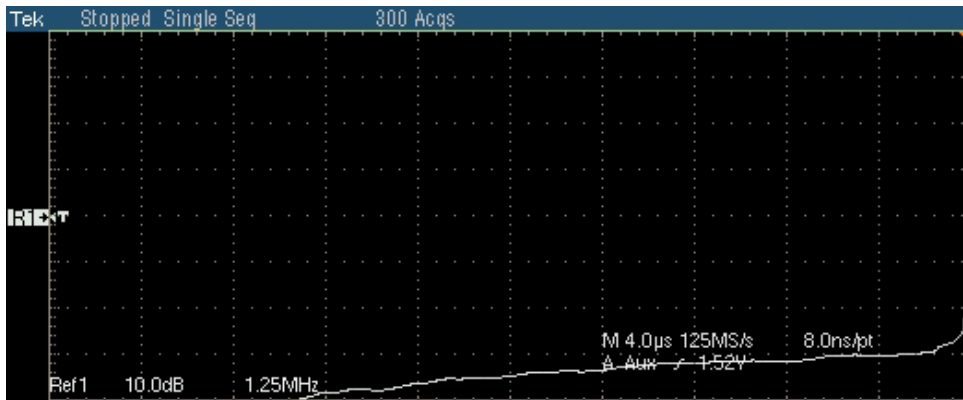

Figure 18-17: Waveform of 10BASE-T Return Loss Load Calibration

12. After all the calibrations are complete, the Apply Cal button is enabled.
13. Click Apply Cal. The calibration is complete.
14. To clear the calibrations and recalibrate, click on New Cal again.

10BASE-T Return Loss Receiver

Use TC1 of the test fixture for calibration. Make the connections as shown by the following figure.

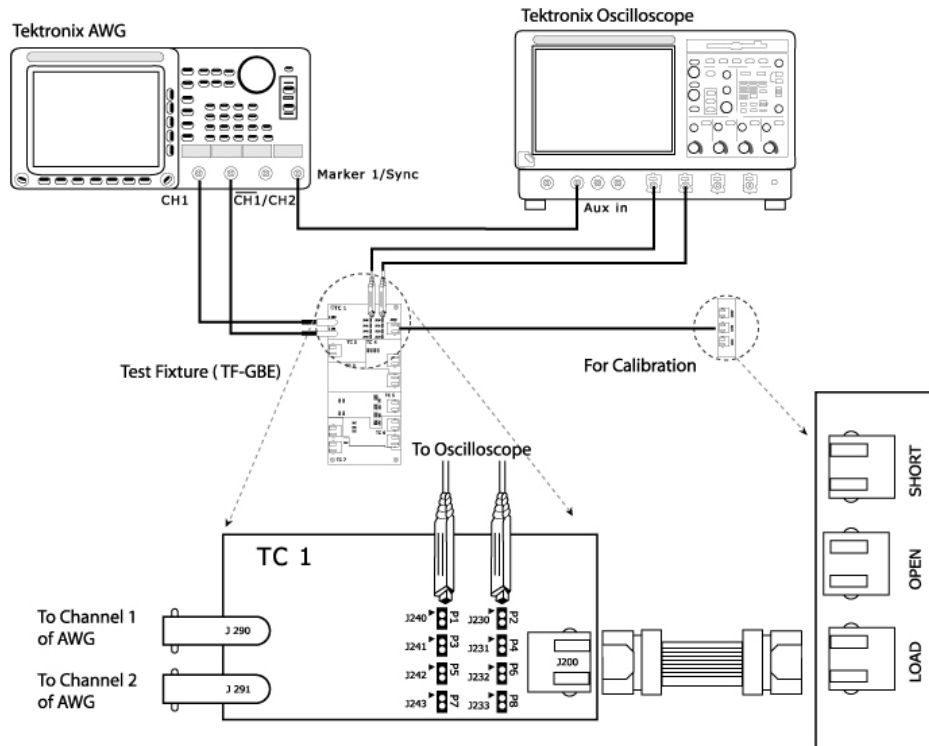

Figure 18-18: Calibration for 10BASE-T Return Loss

1. Click Tests > Select > 10BASE-T from the menu bar.
2. In the Return Loss tab, select **Receiver**.
3. Select **Tests > Connect** or **Connect** to display the Connect pane.

Note: The Open, Load and Short button are enabled only after you press New Cal.

4. Click on New Cal.
5. Connect CAT5 cable to J200 of TC1 and J702 (OPEN).
6. Click Open. Once the open calibration is complete, the string Done appears below the selected calibration. The following figure shows a typical waveform for Return Loss Open Calibration.



Figure 18-19: Waveform of 10BASE-T Return Loss Open Calibration

7. Connect CAT5 cable to J200 of TC1 and J703 (SHORT).
8. Click Short. Once the Short calibration is complete, the string Done appears below the selected calibration. The following figure shows a typical waveform for Return Loss Short Calibration.

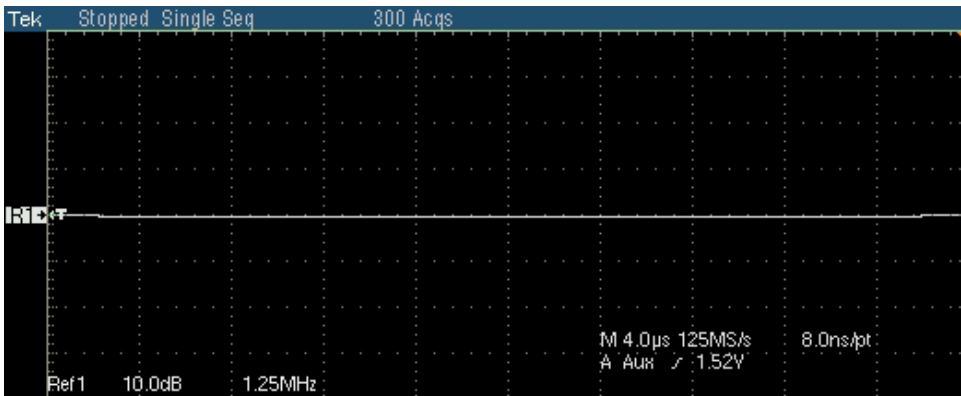

Figure 18-20: Waveform of 10BASE-T Return Loss Short Calibration

9. Connect CAT5 cable to J200 of TC1 and J704 (LOAD).
10. Click Load. Once the Load calibration is complete, the string Done appears below the selected calibration. The following figure shows a typical waveform for Return Loss Load Calibration.

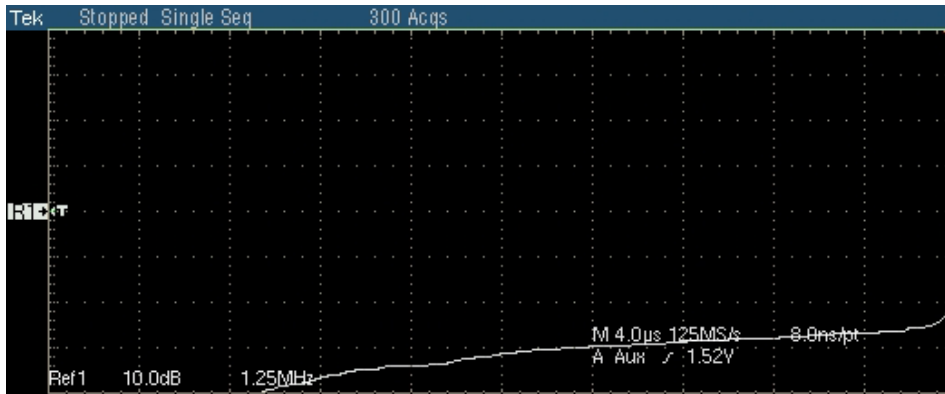

Figure 18-21: Waveform of 10BASE-T Return Loss Load Calibration

11. After all the calibrations are complete, the Apply Cal button is enabled.
12. Click Apply Cal. The calibration is complete.
13. To clear the calibrations and recalibrate, click on New Cal again.

Appendix A: Specification Range

1000BASE-T

Each test result depends on whether the measured value is within the specification range.

The specification range for 1000BASE-T are listed in the following table:

Table A-0-1: 1000BASE-T Specification Range

Test	Specification Range
Template	
A	Fit the template
B	Fit the template
C	Fit the template
D	Fit the template
F	Fit the template
H	Fit the template
Peak Voltage	
A	670 mV to 820 mV
B	670 mV to 820 mV
% Difference between A & B Test	$(1 - Point A / Point B) * 100 < 1\%$
C	$(1 - (0.5 * (Point A + Point B)/2)/ Point C) * 100\% < 2\%$
D	$(1 - (0.5 * (Point A + Point B)/2)/ Point D) * 100\% < 2\%$
Droop	
G	$(Point G/Point F) * 100\% > 73.1\%$
J	$(Point H/Point J) * 100\% > 73.1\%$
Jitter	
TX_TCLK (Yes)	
Master Filtered	Master Filtered Pk-Pk Jitter + Jtxout < 0.3 ns
Master Unfiltered	Master Unfiltered Pk-Pk Jitter < 1.4ns
Slave Filtered	Slave Filtered Pk-Pk Jitter + Jtxout < 0.4 ns + Master Filtered Pk-Pk Jitter
Slave Unfiltered	Slave Unfiltered Pk-Pk Jitter < 1.4ns
TX_TCLK (No)	
Master Filtered	Data (TM2) Filtered Pk-Pk Jitter < 0.3ns - Inconclusive Data (TM2) Filtered Pk-Pk Jitter > 0.3ns - Fail
Master Unfiltered	Data (TM2) Unfiltered Pk-Pk Jitter < 1.4ns - Pass Data (TM2) Unfiltered Pk-Pk Jitter > 1.4ns - Inconclusive

Table A-0-1: 1000BASE-T Specification Range

Test	Specification Range
Slave Filtered	Data (TM3) Filtered Pk-Pk Jitter - Data (TM2) Filtered Pk-Pk Jitter < 0.4ns - Pass Data (TM3) Filtered Pk-Pk Jitter - Data (TM2) Filtered Pk-Pk Jitter > 0.4ns - Fail
Slave Unfiltered	Data (TM3) Unfiltered Pk-Pk Jitter - Data (TM2) Unfiltered Pk-Pk Jitter < 1.4ns - Pass Data (TM3) Unfiltered Pk-Pk Jitter - Data (TM2) Unfiltered Pk-Pk Jitter > 1.4ns - Fail
Distortion	< 10 mV
Return Loss	At least 16 dB over the frequency range of 1.0 MHz to 40 MHz and at least 10 -20log 10 (f /80)dB over the frequency range 40 MHz to 100 MHz (f in MHz)
Common Mode Voltage	< 50 mV Pk-Pk

100BASE-TX

Each test result depends on whether the measured value is within the specification range.

The specification range for 100BASE-TX are listed in the following table:

Table A-0-2: 100BASE-TX Specification Range

Test	Specification Range
Template	
AOI Template	Fit the template
Differential Output Voltage	
Output Voltage (+Vout)	950 mV to 1050 mV
Output Voltage (-Vout)	-950 mV to -1050 mV
Signal Amplitude Symmetry	
Signal Amplitude Symmetry	0.98 to 1.02
Rise Time	
Rise Time (+ve)	3.0ns to 5.0ns
Rise Time (-ve)	3.0ns to 5.0ns
Fall Time	
Fall Time (+ve)	3.0ns to 5.0ns
Fall Time (-ve)	3.0ns to 5.0ns
Rise/Fall Time Symmetry	
Rise/Fall Symmetry (+ve)	<500ps
Rise/Fall Symmetry (-ve)	<500ps

Table A-0-2: 100BASE-TX Specification Range

Test	Specification Range
Waveform Overshoot	
Overshoot(+ve)	<5%
Overshoot(-ve)	<5%
Jitter	
Transmit Jitter	< 1.4ns
Duty Cycle Distortion	
Distortion	< 500ps(+/- 250ps)
Return Loss	> 16 dB from 2 MHz to 30 MHz > (16 - 20log(f/30 MHz)) dB from 30 MHz to 60 MHz > 10 dB from 60 MHz to 80 MHz

10BASE-T

Each test result depends on whether the measured value is within the specification range.

The specification range for 10BASE-T are listed in the following table:

Table A-0-3: 10BASE-T Specification Range

Test	Specification Range
Template	
MAU Ext	Fit the Template
MAU Ext Inv	Fit the Template
MAU Int	Fit the Template
MAU Int Inv	Fit the Template
Link Pulse	Fit the Template
TP_IDL	Fit the Template
Differential Voltage	Positive peaks - +2.2V to +2.8V Negative peaks - -2.2V to -2.8V
Harmonic	< Fundamental - 27 dB
Jitter	

Note: Jitter values are according to the Internal MAU measurement.

with cable	
Normal	< 11ns (+/- 5.5ns)
8.0BT	< 22 ns (+/- 11ns)
8.5BT	< 22 ns (+/- 11ns)

Appendix A: Specification Range

Table A-0-3: 10BASE-T Specification Range

Test	Specification Range
without cable	
Normal	< 16ns (+/- 8ns)
8.0BT	< 40ns (+/- 20ns)
8.5BT	< 40ns (+/- 20ns)

Note: Jitter values are according to the External MAU measurement.

with cable	
Normal	< 7(+/-3.5ns)
8.0BT	< 14(+/-7)
8.5BT	< 14(+/-7)
without cable	
Normal	< 16(+/-8ns)
8.0BT	< 32(+/-16ns)
8.5BT	< 32(+/-16ns)
Return Loss	At least 15 dB over the frequency range of 5.0 to 10 MHz
Common mode Voltage	< 50 mV Peak

Appendix B: Error Messages

TDSET3 Error Messages

Table B-0-1: TDSET3 Error Messages

Code	Error Message	Description	Possible Solution
E101	Few samples, edge finding failed.	The application is not able to detect valid clock signal.	Ensure the correct signal is connected and the configuration parameters are correct.
E102	The selected input sources should be mutually exclusive.	Data, Master CLK, Slave CLK cannot be configured to the same source.	Ensure that the oscilloscope channels that you configure for the input sources are mutually exclusive.
E103	Invalid signal. The measured clock is out of range.	The estimated TX_TCLK for Distortion test, is either very low or high.	Ensure the correct signal is connected and the configuration parameters are correct. Ensure that the trigger level is adjusted to get a stable trigger.
E104	The measured value is unstable. The previous values will be restored.	The application is not able to get stable measured values.	Ensure the correct signal is connected and the configuration parameters are correct.
E105	Not enough clock edges.	The application is not able to find sufficient clock edges for Distortion test.	Ensure the correct clock signal is connected and the configuration parameters are correct.
E401	Cannot connect to the instrument.	The application is not able to communicate with the Oscilloscope.	Reboot the Oscilloscope.
E402	This application requires firmware version 2.2.0 or above. Please install the latest firmware available at the Tektronix Web site. The application will exit now.	The application works only with Firmware version 2.2.0 or above.	Download the latest Firmware from Tektronix Web site.
E403	Default file does not exist.	The application's default settings file is not found.	Reinstall the application.
E404	Unable to set the mask.	The Mask file is missing or corrupted.	Reinstall the application.
E405	Enter a valid file name to generate a report.	The file name in the report setup is not valid.	Go to Report Setup dialog box and enter a valid file name.
E406	Report data base file read failed.	The application's system file is missing/corrupted.	Reinstall the application.
E407	System file exception.	If the oscilloscope has a file exception, this error is displayed at run time by the operating system.	Reboot the Oscilloscope.
E408	System memory exception.	If the oscilloscope has a memory exception, this error is displayed at run time by the operating system.	Reboot the Oscilloscope.

Table B-0-1: TDSET3 Error Messages

Code	Error Message	Description	Possible Solution
E409	Unknown exception.	If the oscilloscope has an unknown exception, this error is displayed at run time by the operating system.	Reboot the Oscilloscope.
E410	Invalid signal. Check whether the DUT is connected.	The application is not able to detect a valid signal.	Ensure the correct signal is connected and the configuration parameters are correct.
E411	This application has not been enabled. To enable the application, select Utility>Option Installation to enter a key. To purchase a key, contact your Tektronix representative. Select Help>Technical Support to contact Tektronix representative.	The application is not purchased.	Contact your Tektronix representative.
E412	Calibration Data unavailable.	Calibration is not complete for the selected test.	Complete all three Load, Short, Open calibration steps for the selected test.
E413	Unable to find crossover.	Unable to find crossover to place the histogram while 100BASE-TX, and 10BASE-T Jitter tests.	For 100BASE-TX tests, re-run the test. For 10BASE-T tests, select the Show 10BAse-T Jitter User Control check box in the Preference dialog box and then re-run the test. When the <i>10BAse-T Jitter User Control</i> dialog box appears, adjust the <i>TiggerHoldOff</i> parameter of the oscilloscope.
E414	The selected oscilloscope sources are mutually exclusive.	Same channel is selected for multiple input sources which is not allowed.	Select separate channel for each input source.
E415	The selected output sources are mutually exclusive.	Same Reference source is selected for output which is not allowed.	Select separate Reference waveform for output.
E416	External trigger unavailable. Check whether the 'sync Out' of the AWG is connected to the 'AUX IN' of the Oscilloscope.	The sync/marker1 of the AWG is not connected to the 'AUX IN' of the Oscilloscope.	Connect the sync/marker1 of the AWG to the 'AUX IN' of the Oscilloscope.
E417	System failure.	There is a problem while allocating a system resource.	Reboot the Oscilloscope.
E418	Unknown Error.	If the application has an unknown error, this error message is displayed.	Reboot the Oscilloscope.
E419	Tekscope is not running. TDSET3 will now exit.	This error message appears if you click on Run Test button in the TDSET3 application after you have exit from the TekScope.	Launch the TekScope and then TDSET3 from RunApplication menu to work with TDSET3 application.

***Note:** The Error Message E419 appears only if you are running the TDSET3 application on a TDS5000B series oscilloscope.*

Remote GPIB Error Messages

Table B-0-2: Remote GPIB Error Messages

Code	Error Message	Description	Possible Solution
E601	GPIB write failure	The oscilloscope did not accept the GPIB write command.	Reboot the Oscilloscope.
E602	GPIB read failure	The oscilloscope did not accept the GPIB read command.	Reboot the Oscilloscope.
E603	Unable to clear event queue	The oscilloscope event queue was not cleared.	Reboot the Oscilloscope.
E604	Invalid value set; variable reset to nearest limit value	The Value set was not within the acceptable range.	The variable value has been reset.
E605	Conversion error: value reset to the old value	The Value set characteristics do not match.	The variable value has been reset.
E606	Application setup file unavailable	The setup file is missing.	Resend the command with the appropriate file name.
E607	Selected test to query the result details is invalid	Invalid test chosen for result details query.	Resend the command with the appropriate test name.
E608	Selected test has not been run	Querying for a result before the test is run.	Run the test and then query for the results.
E609	Invalid value is set, old value will be reset	The Value set characteristics do not match.	The variable value has been reset.
E610	Test in progress, unable to retrieve the results	Querying for a result before the test is complete.	Query for results after the test is complete.
E611	Character string too long	The value field is too long.	Resend the command with a value within the acceptable range.
E612	Invalid test/configuration selected	The test or configuration selected or the do not correspond to the current technology.	Select the appropriate technology and then select the test or configuration.
E613	Unable to save application settings	The application settings could not be saved to a default file.	Resend the command with a different file name.
E614	You cannot set values for query only commands	You cannot set values for query only commands.	Do not set value for query only commands.
E700	GPIB Time Out	GPIB command has timed out.	Reboot the Oscilloscope.

