

# Technical Reference



## **TDS5000B Series Digital Phosphor Oscilloscopes Specifications and Performance Verification**

**071-1420-03**

### **Revision A**

This document applies to firmware version 1.00 and above.

### **Warning**

The servicing instructions are for use by qualified personnel only. To avoid personal injury, do not perform any servicing unless you are qualified to do so. Refer to all safety summaries prior to performing service.

**[www.tektronix.com](http://www.tektronix.com)**

Copyright © Tektronix, Inc. All rights reserved.

Tektronix products are covered by U.S. and foreign patents, issued and pending. Information in this publication supercedes that in all previously published material. Specifications and price change privileges reserved.

Tektronix, Inc., P.O. Box 500, Beaverton, OR 97077

TEKTRONIX and TEK are registered trademarks of Tektronix, Inc.

# Table of Contents

<b>General Safety Summary</b> .....	<b>v</b>
<b>Specifications</b> .....	<b>1-1</b>
Product and Feature Description .....	1-2
Acquisition Features .....	1-2
Signal Processing Features .....	1-3
Display Features .....	1-3
Measurement Features .....	1-4
Trigger Features .....	1-4
Convenience Features .....	1-4
Specification Tables .....	1-6

## Performance Verification

Conventions .....	2-2
<b>Brief Procedures</b> .....	<b>2-5</b>
Self Tests .....	2-5
Verify Internal Adjustment, Self Compensation, and Diagnostics .....	2-5
Functional Tests .....	2-6
Verify All Input Channels .....	2-7
Verify the Time Base .....	2-9
Verify the A (Main) and B (Delayed) Trigger Systems .....	2-11
Verify the File System .....	2-12
Verify the Internal Printer (Optional) .....	2-14
<b>Performance Tests</b> .....	<b>2-17</b>
Prerequisites .....	2-17
Equipment Required .....	2-18
TDS5000B Series Test Record .....	2-20
Signal Acquisition System Checks .....	2-24
Check DC Voltage Measurement Accuracy .....	2-24
Check Analog Bandwidth .....	2-28
Check Delay Between Channels .....	2-33
Check Channel Isolation (Crosstalk) .....	2-37
Time Base System Checks .....	2-39
Check Long-Term Sample Rate and Delay Time Accuracy .....	2-39
Check Delta Time Measurement Accuracy .....	2-41
Trigger System Checks .....	2-45
Check Time Accuracy for Pulse, Glitch, Timeout, and Width Triggering .....	2-45
Check Sensitivity, Edge Trigger, DC Coupled .....	2-48
Output Signal Checks .....	2-54
Check Outputs .....	2-54
Check Probe Compensation Output .....	2-57
Sine Wave Generator Leveling Procedure .....	2-61

# List of Figures

<b>Figure 2-1: Toolbar and menu bar</b> .....	<b>2-3</b>
<b>Figure 2-2: Universal test hookup for functional tests - CH 1 shown</b>	<b>2-7</b>
<b>Figure 2-3: Channel button location</b> .....	<b>2-8</b>
<b>Figure 2-4: Setup for time base test</b> .....	<b>2-9</b>
<b>Figure 2-5: Setup for trigger test</b> .....	<b>2-11</b>
<b>Figure 2-6: Setup for the file system test</b> .....	<b>2-13</b>
<b>Figure 2-7: Example test page from the internal printer</b> .....	<b>2-15</b>
<b>Figure 2-8: Initial test hookup</b> .....	<b>2-25</b>
<b>Figure 2-9: Measurement of DC accuracy at maximum offset and position</b> .....	<b>2-27</b>
<b>Figure 2-10: Initial test hookup</b> .....	<b>2-29</b>
<b>Figure 2-11: Optional initial test hookup</b> .....	<b>2-29</b>
<b>Figure 2-12: Measurement of analog bandwidth</b> .....	<b>2-32</b>
<b>Figure 2-13: Initial test hookup</b> .....	<b>2-34</b>
<b>Figure 2-14: Measurement of channel delay</b> .....	<b>2-36</b>
<b>Figure 2-15: Initial test hookup</b> .....	<b>2-37</b>
<b>Figure 2-16: Initial test hookup</b> .....	<b>2-39</b>
<b>Figure 2-17: Measurement of accuracy - long-term and delay time</b>	<b>2-41</b>
<b>Figure 2-18: Delta time accuracy test hookup</b> .....	<b>2-42</b>
<b>Figure 2-18: Initial test hookup</b> .....	<b>2-45</b>
<b>Figure 2-19: Measurement of time accuracy for pulse and glitch triggering</b> .....	<b>2-47</b>
<b>Figure 2-20: Initial test hookup</b> .....	<b>2-49</b>
<b>Figure 2-21: Measurement of trigger sensitivity showing 50 MHz results</b> ..	<b>2-50</b>
<b>Figure 2-22: Initial test hookup</b> .....	<b>2-54</b>
<b>Figure 2-23: Measurement of main trigger out limits</b> .....	<b>2-56</b>
<b>Figure 2-24: Initial test hookup</b> .....	<b>2-57</b>
<b>Figure 2-25: Measurement of probe compensator frequency</b> .....	<b>2-58</b>
<b>Figure 2-26: Subsequent test hookup</b> .....	<b>2-59</b>
<b>Figure 2-27: Measurement of probe compensator amplitude</b> .....	<b>2-60</b>
<b>Figure 2-28: Sine wave generator leveling equipment setup (Method A)</b> .....	<b>2-61</b>
<b>Figure 2-29: Sine wave generator leveling equipment setup (Method B)</b> .....	<b>2-63</b>

## List of Tables

<b>Table 1-1: TDS5000B Series models</b> .....	<b>1-2</b>
<b>Table 1-2: Channel input and vertical specifications</b> .....	<b>1-6</b>
<b>Table 1-3: Horizontal and acquisition system specifications</b> .....	<b>1-13</b>
<b>Table 1-4: Trigger specifications</b> .....	<b>1-14</b>
<b>Table 1-5: Display specifications</b> .....	<b>1-19</b>
<b>Table 1-6: Input/output port specifications</b> .....	<b>1-19</b>
<b>Table 1-7: Data storage specifications</b> .....	<b>1-20</b>
<b>Table 1-8: Power source specifications</b> .....	<b>1-21</b>
<b>Table 1-9: Mechanical specifications</b> .....	<b>1-21</b>
<b>Table 1-10: Environmental specifications</b> .....	<b>1-22</b>
<b>Table 1-11: Certifications and compliances</b> .....	<b>1-23</b>
<b>Table 2-1: Test equipment</b> .....	<b>2-18</b>
<b>Table 2-2: DC Voltage measurement accuracy</b> .....	<b>2-26</b>
<b>Table 2-3: Analog bandwidth</b> .....	<b>2-30</b>
<b>Table 2-4: Delta time measurement</b> .....	<b>2-44</b>



# General Safety Summary

Review the following safety precautions to avoid injury and prevent damage to this product or any products connected to it. To avoid potential hazards, use this product only as specified.

*Only qualified personnel should perform service procedures.*

While using this product, you may need to access other parts of the system. Read the *General Safety Summary* in other system manuals for warnings and cautions related to operating the system.

## To Avoid Fire or Personal Injury

**Use Proper Power Cord.** Use only the power cord specified for this product and certified for the country of use.

**Connect and Disconnect Properly.** Do not connect or disconnect probes or test leads while they are connected to a voltage source.

**Ground the Product.** This product is grounded through the grounding conductor of the power cord. To avoid electric shock, the grounding conductor must be connected to earth ground. Before making connections to the input or output terminals of the product, ensure that the product is properly grounded.

**Observe All Terminal Ratings.** To avoid fire or shock hazard, observe all ratings and markings on the product. Consult the product manual for further ratings information before making connections to the product.

**Do Not Operate Without Covers.** Do not operate this product with covers or panels removed.

**Use Proper Fuse.** Use only the fuse type and rating specified for this product.

**Avoid Exposed Circuitry.** Do not touch exposed connections and components when power is present.

**Do Not Operate With Suspected Failures.** If you suspect there is damage to this product, have it inspected by qualified service personnel.

**Do Not Operate in Wet/Damp Conditions.**

**Do Not Operate in an Explosive Atmosphere.**

**Keep Product Surfaces Clean and Dry.**

**Provide Proper Ventilation.** Refer to the manual's installation instructions for details on installing the product so it has proper ventilation.

**Symbols and Terms**

**Terms in this Manual.** These terms may appear in this manual:



---

**WARNING.** *Warning statements identify conditions or practices that could result in injury or loss of life.*

---



---

**CAUTION.** *Caution statements identify conditions or practices that could result in damage to this product or other property.*

---

**Terms on the Product.** These terms may appear on the product:

DANGER indicates an injury hazard immediately accessible as you read the marking.

WARNING indicates an injury hazard not immediately accessible as you read the marking.

CAUTION indicates a hazard to property including the product.

**Symbols on the Product.** The following symbols may appear on the product:





# Specifications

This chapter contains specifications for the TDS5000B Series Digital Phosphor Oscilloscopes. All specifications are guaranteed unless labeled “typical.” Typical specifications are provided for your convenience but are not guaranteed. Specifications marked with the ✓ symbol are verified in the *Performance Verification* section.

The specifications in this section apply to all TDS5000B Series models unless noted otherwise. To meet specifications, the following conditions must be met:

- The oscilloscope must have been calibrated in an ambient temperature between 20 °C and 30 °C (68 °F and 86 °F).
- The oscilloscope must be operating within the environmental limits listed in Table 1-10 on page 1-22.
- The oscilloscope must be powered from a source that meets the specifications listed in Table 1-8 on page 1-21.
- The oscilloscope must have been operating continuously for at least 20 minutes within the specified operating temperature range.
- You must perform the Signal Path Compensation procedure after the 20-minute warm-up period and the ambient temperature must not change more than 5 °C (9 °F) without first repeating the procedure. See *Run the signal-path compensation routine* on page 2-6 for instructions on how to perform this procedure.
- You must perform the Signal Path Compensation procedure after the 20-minute warm-up period, and the ambient temperature must not change more than 5 °C without first repeating the procedure. See *Optimizing Measurement Accuracy* on page 2-6 for instructions to perform this procedure.

## Product and Feature Description

The TDS5000B Series Digital Phosphor Oscilloscope family consists of the models shown in Table 1-1.

**Table 1-1: TDS5000B Series models**

Model	Number of channels	Bandwidth	Maximum sample rate (real time)
TDS5032B	2	350 MHz	5 GS/s
TDS5034B	4	350 MHz	5 GS/s
TDS5052B	2	500 MHz	5 GS/s
TDS5054B	4	500 MHz	5 GS/s
TDS5054BE	4	500 MHz	1 GS/s
TDS5104B	4	1 GHz	5 GS/s

### Acquisition Features

**Separate Digitizers.** Ensure accurate timing measurements with separate digitizers for each channel. Acquisition on multiple channels is always concurrent and supports full bandwidth for single-shot acquisitions on each channel. The digitizers can also be combined to yield a higher sample rate on a single channel.

**NOTE.** Full bandwidth single-shot acquisition is not available for TDS5104B Series oscilloscopes, except in one or two channel mode.

Digitizers cannot be combined to yield a higher sample rate for a single channel when using TDS5054BE Series oscilloscopes.

**Fast Acquisition.** Acquire up to 100,000 waveforms per second to see rapidly changing signals or intermittent signal irregularities.

**Long Record Lengths.** Choose record lengths from 500 points to up to 2,000,000 points per channel (up 8,000,000 points on a single channel). Extend the maximum record length up to a maximum of 16,000,000 points with memory options.

**Peak Detect Acquisition Mode.** See pulses as narrow as 400 ps, even at the slower time base settings. Peak detect helps you see noise and glitches in your signal.

**Acquisition Control.** Acquire continuously or set up to capture single shot acquisitions. Enable or disable optional acquisition features such as equivalent time or roll mode.

**Horizontal Delay.** Use delay when you want to acquire a signal at a significant time interval after the trigger point. Toggle delay on and off to quickly compare the signal at two different points in time.

### Signal Processing Features

**Average, Envelope, and Hi Res Acquisition.** Use Average acquisition mode to remove uncorrelated noise from your signal. Use Envelope to capture and display the maximum variation of the signal. Use Hi Res to increase vertical resolution for lower bandwidth signals.

**Waveform Math.** Set up simple math waveforms using the basic arithmetic functions including FFT, or create more advanced math waveforms using the optional math expression editor. Waveform expressions can even contain measurement results and other math waveforms.

**Spectral Analysis.** Display spectral magnitude and phase waveforms based on your time-domain acquisitions. Control the oscilloscope using the traditional spectrum analyzer controls such as span and center frequency.

### Display Features

**Color LCD Display.** Identify and differentiate waveforms easily with color coding. Waveforms, readouts, and inputs are color matched to increase productivity and reduce operating errors.

**Digital Phosphor.** A Digital Phosphor Oscilloscope can clearly display intensity modulation in your signals. The oscilloscope automatically overlays subsequent acquisitions and then decays them to simulate the writing and decay of the phosphor in an analog oscilloscope CRT (cathode-ray tube). The feature results in an intensity-graded or color-graded waveform display that shows the information in the intensity modulation.

**Fit to Screen.** The Digital Phosphor technology performs the compression required to represent all record points on the screen, even at the maximum record length settings.

**Zoom.** To take advantage of the full resolution of the oscilloscope you can zoom in on a waveform to see the fine details. Both vertical and horizontal zoom functions are available.

**Measurement Features**      **Cursors.** Use cursors to take simple voltage, time, and frequency measurements.

**Automatic Measurements.** Choose from a large palette of amplitude, time, and histogram measurements. You can customize the measurements by changing reference levels or by adding measurement gating.

**Trigger Features**      **Simple and Advanced Trigger Types.** Choose simple edge trigger or choose from many advanced trigger types to help you capture a specific signal fault or event.

**Dual Triggers.** Use the A (main) trigger system alone or add the B trigger to capture more complex events. You can use the A and B triggers together to set up a delay-by-time or delay-by-events trigger condition.

**Convenience Features**      **Autoset.** Use Autoset to quickly set up the vertical, horizontal, and trigger controls for a usable display.

**Touch Screen Interface. (Optional)** You can operate all oscilloscope functions (except the power switch) from the touch screen interface. You can also install a mouse and keyboard to use the interface.

**Toolbar or Menu Bar.** You can choose a toolbar operating mode that is optimized for use with the touch screen, or a PC-style menu-bar operating mode that is optimized for use with a mouse.

**Open Desktop.** The oscilloscope is built on a Microsoft Windows software platform; the oscilloscope application program starts automatically when you apply power to the instrument. You can minimize the oscilloscope application and take full advantage of the built-in PC to run other applications. Moving waveform images and data into other applications is as simple as a copy/paste operation.

**Dedicated Front Panel Controls.** The front panel contains knobs and buttons to provide immediate access to the most common oscilloscope controls. Separate vertical controls are provided for each channel. The same functions are also available through the screen interface.

**Data Storage and I/O.** The oscilloscope has a standard floppy disk drive and CD-R/W drive or optional removable hard disk drive, that can be used for storage and retrieval of data. The oscilloscope has GPIB, USB, Parallel, RS232, and Ethernet ports for input and output to other devices.

**Online Help.** The oscilloscope has a complete online help system that covers all its features. The help system is context sensitive; help for the displayed control window is automatically shown if you touch the help button. Graphical aids in the help windows assist you in getting to the information you need. You can also access the help topics through a table of contents or index.

## Specification Tables

**Table 1-2: Channel input and vertical specifications**

Characteristic	Description	
Input coupling	AC, DC, and GND	
Input channels		
TDS5034B, TDS5054B, TDS5054BE, TDS5104B	Four identical channels	
TDS5032B, TDS5052B	Two identical channels	
Input impedance selection	50 $\Omega$ or 1 M $\Omega$ .	
	TDS5104B bandwidth limited to 500 MHz, 1 M $\Omega$ selected	
Input impedance, DC coupled	<i>Product</i>	<i>Limits</i>
50 $\Omega$ , typical	TDS5032B, TDS5052B, TDS5034B, TDS5054B, TDS5054BE	$\pm 1.0\%$
	TDS5104B	$\pm 2.5\%$
VSWR	TDS5032B, TDS5034B	$\leq 1.6:1$ typical from DC to 350 MHz
	TDS5052B, TDS5054B, TDS5054BE	$\leq 1.6:1$ typical from DC to 500 MHz
	TDS5104B	$\leq 1.5:1$ typical from DC to 1 GHz
1 M $\Omega$	TDS5032B, TDS5052B, TDS5034B, TDS5054B, TDS5054BE	$\pm 1.0\%$ in parallel with 15.5 pF $\pm 2$ pF
	TDS5104B	$\pm 1.0\%$ in parallel with 18 pF $\pm 2$ pF
Maximum voltage at input BNC	AC, DC, or GND coupled	
1 M $\Omega$	150 V <sub>RMS</sub> CAT I, and $\leq 400$ peak	
	For steady state sinusoidal waveforms, derate at 20 dB/decade above 200 kHz to 9 V <sub>RMS</sub> at $\geq 3$ MHz	
50 $\Omega$	TDS5032B, TDS5052B, TDS5034B, TDS5054B, TDS5054BE	5 V <sub>RMS</sub> with peaks less than $\pm 30$ V
	TDS5104B	< 1 V <sub>rms</sub> for settings below 100mV/div < 5 V <sub>rms</sub> for 100 mV/div settings and above
✓ Differential delay, DC 50 $\Omega$ input	$\leq 100$ ps between any two channels with DC input coupling and the same V/div scale settings at or above 10 mV/div	
Deskew range, typical	$\pm 75.0$ ns	
✓ Channel-to-channel crosstalk	$\geq 100:1$ at $\leq 100$ MHz	

Table 1-2: Channel input and vertical specifications (Cont.)

Characteristic	Description	
	≥30:1 at >100 MHz up to the rated bandwidth for any two channels with equal V/div settings	
Digitizers	8-bit resolution	
	TDS5032B, TDS5052B	Two separate digitizers, each channel sampled simultaneously
	TDS5034B, TDS5054B, TDS5054BE, TDS5104B	Four separate digitizers, each channel sampled simultaneously
Sensitivity range	Fine adjustment available with ≤1% resolution	
1 MΩ	1 mV/div to 10 V/div, in a 1-2-5 sequence	
50 Ω	1 mV/div to 1 V/div, in a 1-2-5 sequence	
✓ Analog bandwidth	<i>SCALE range</i>	<i>Bandwidth</i>
TDS5032B, TDS5034B	1 mV/div to 1.99 mV/div	DC to 150 MHz
	2 mV/div to 4.98 mV/div	DC to 250 MHz
	5 mV/div to 1 V/div	DC to 350 MHz
	DC 50 Ω coupling; bandwidth limit set to Full; operating ambient ≤30 °C; derated by 2.5 MHz/°C above 30 °C	
TDS5052B, TDS5054B, TDS5054BE	1 mV/div to 1.99 mV/div	DC to 175 MHz
	2 mV/div to 4.98 mV/div	DC to 300 MHz
	5 mV/div to 1 V/div	DC to 500 MHz
	DC 50 Ω coupling; bandwidth limit set to Full; operating ambient ≤30 °C; derated by 2.5 MHz/°C above 30 °C	
TDS5104B	1 mV/div to 1.99 mV/div	DC to 175 MHz
	2 mV/div to 1 V/div	DC to 1 GHz
		DC 50 Ω coupling; bandwidth limit set to Full; operating ambient ≤30 °C; derated by 5 MHz/°C above 30 °C
Analog bandwidth selections	20 MHz, 150 MHz, or Full	

**Table 1-2: Channel input and vertical specifications (Cont.)**

Characteristic	Description	
Analog Bandwidth Limit		
Low frequency, AC coupled	50 $\Omega$ : < 200 kHz	
	1 M $\Omega$ : < 10 Hz, reduced by a factor of ten when using a 10X probe	
High frequency, typical	20 MHz: with 20 MHz bandwidth limit turned on	
	150 MHz: with 150 MHz bandwidth limit turned on	
Calculated rise time, typical	DC 50 $\Omega$ coupling, bandwidth limit set to Full	
	<i>SCALE range</i>	<i>Rise time</i>
TDS5032B, TDS5034B	1 mV/div to 1.99 mV/div	2.67 ns
	2 mV/div to 4.98 mV/div	1.6 ns
	5 mV/div to 1 V/div	1.15 ns
TDS5052B, TDS5054B, TDS5054BE	1 mV/div to 1.99 mV/div	2.29 ns
	2 mV/div to 4.98 mV/div	1.33 ns
	5 mV/div to 1 V/div	800 ps
TDS5104B	1 mV/div to 1.99 mV/div	2.29 ns
	2 mV/div to 1 V/div	300 ps
Step response settling errors, typical	Bandwidth limit set to Full	
	<i>SCALE range</i>	<i>Settling error at time after step</i>
$\leq 2$ V step amplitude	1 mV/div to 99.5 mV/div	20 ns: $\leq 0.5\%$
		100 ns: $\leq 0.2\%$
		20 ms: $\leq 0.1\%$
$\leq 20$ V step amplitude	100 mV/div to 1.0 V/div	20 ns: $\leq 1.0\%$
		100 ns: $\leq 0.5\%$
		20 ms: $\leq 0.2\%$
$\leq 200$ V step amplitude	1.01 V/div to 10 V/div	20 ns: $\leq 1.0\%$
		100 ns: $\leq 0.5\%$
		20 ms: $\leq 0.2\%$
Position range	$\pm 5$ divisions	
Peak Detect or Envelope Mode Pulse Response	Capture of single event pulses	
	<i>Number of channels</i>	<i>Minimum pulse width</i>
	1 or 2	400 ps
	3 or 4	800 ps
Offset range	User-adjustable input offset voltages	



**Table 1-2: Channel input and vertical specifications (Cont.)**

Characteristic	Description	
TDS5032B, TDS5034B, TDS5052B, TDS5054B, TDS5054BE	<i>SCALE range</i>	<i>Offset range</i>
	1 M $\Omega$ coupling	$\pm 1$ V
		$\pm 10$ V
		$\pm 100$ V
	50 $\Omega$ coupling	$\pm 1$ V
		$\pm 10$ V
TDS5104B	<i>SCALE range</i>	<i>Offset range</i>
	1 M $\Omega$ coupling	$\pm 1$ V
		$\pm 10$ V
		$\pm 100$ V
	50 $\Omega$ coupling	$\pm 0.5$ V
		$\pm 0.25$ V
		$\pm 5$ V
		$\pm 2.5$ V

**Table 1-2: Channel input and vertical specifications (Cont.)**

Characteristic	Description	
Offset accuracy	<i>SCALE range</i>	<i>Offset range</i>
	1 mV/div to 9.95 mV/div	$\pm[(0.2\% \times   \text{net offset}  ) + 1.5 \text{ mV} + (0.1 \text{ div} \times \text{V/div setting})]$
	10 mV/div to 99.5 mV/div	$\pm[(0.35\% \times   \text{net offset}  ) + 1.5 \text{ mV} + (0.1 \text{ div} \times \text{V/div setting})]$
	100 mV/div to 1.0 V/div	$\pm[(0.35\% \times   \text{net offset}  ) + 15 \text{ mV} + (0.1 \text{ div} \times \text{V/div setting})]$
	1.01 V/div to 10 V/div	$\pm[(0.25\% \times   \text{net offset}  ) + 150 \text{ mV} + (0.1 \text{ div} \times \text{V/div setting})]$
	Temperatures >40 °C	$\pm[(0.75\% \times   \text{net offset}  ) + 150 \text{ mV} + (0.1 \text{ div} \times \text{V/div setting})]$
DC gain accuracy, Sample or Average acquisition mode	<i>where, net offset = offset - (position × volts/division)</i>	
	$\pm 1.5\% + 1.0\% \times  \text{net offset} / \text{offset range} $	
	TDS5104B: $\pm 3\% + 1.0\% \times  \text{net offset} / \text{offset range} $ for 2 mV/div - 3.98 mV/div	
	Refer to <i>Offset Range</i> specifications	

Table 1-2: Channel input and vertical specifications (Cont.)

Characteristic	Description	
DC voltage measurement accuracy	<i>Measurement type</i>	<i>DC accuracy (in volts)</i>
	Sample acquisition mode, typical	<p>Any sample</p> $\pm[(1.5\% + 1.0\% \times  \text{net offset /offset range} ) \times  \text{reading} - \text{net offset}  + \text{offset accuracy} + (0.13 \text{ div} \times \text{V/div setting}) + 0.6 \text{ mV}]$ <p>TDS5104B: 2 mV/div - 3.98 mV/div</p> $\pm[(1.5\% + 3.0\% \times  \text{net offset /offset range} ) \times  \text{reading} - \text{net offset}  + \text{offset accuracy} + (0.13 \text{ div} \times \text{V/div setting}) + 0.6 \text{ mV}]$
	Delta voltage measurement between any two points acquired under the same setup and ambient conditions	$\pm[(1.5\% + 1.0\% \times  \text{net offset /offset range} ) \times  \text{reading} - \text{net offset}  + (0.26 \text{ div} \times \text{V/div setting}) + 1.2 \text{ mV}]$ <p>TDS5104B: 2 mV/div - 3.98 mV/div</p> $\pm[(1.5\% + 3.0\% \times  \text{net offset /offset range} ) \times  \text{reading} - \text{net offset}  + (0.26 \text{ div} \times \text{V/div setting}) + 1.2 \text{ mV}]$
<i>where, net offset = offset - (position × volts/division)</i>		
✓ Average acquisition mode	Average of ≥16 waveforms	$\pm[(1.5\% + 1.0\% \times  \text{net offset /offset range} ) \times  \text{reading} - \text{net offset}  + \text{offset accuracy} + 0.06 \text{ div} \times \text{V/div}]$ <p>TDS5104B: 2 mV/div - 3.98 mV/div</p> $\pm[(1.5\% + 3.0\% \times  \text{net offset /offset range} ) \times  \text{reading} - \text{net offset}  + \text{offset accuracy} + (0.06 \text{ div} \times \text{V/div})]$
	Delta voltage measurement between any two averages of ≥16 waveforms acquired under the same setup and ambient conditions	$\pm[(1.5\% + 1.0\% \times  \text{net offset /offset range} ) \times  \text{reading} - \text{net offset}  + (0.1 \text{ div} \times \text{V/div setting}) + 0.3 \text{ mV}]$ <p>TDS5104B: 2 mV/div - 3.98 mV/div</p> $\pm[(1.5\% + 3.0\% \times  \text{net offset /offset range} ) \times  \text{reading} - \text{net offset}  + (0.1 \text{ div} \times \text{V/div setting}) + 0.3 \text{ mV}]$
	<i>Where, net offset = offset - (position × volts/division)</i>	
Nonlinearity, typical	< 1 LSB differential, < 1 LSB integral, independently based	

**Table 1-2: Channel input and vertical specifications (Cont.)**

Characteristic	Description	
Effective bits, typical	Sine wave input at the indicated frequency and pk-pk amplitude, 50 mV/div and 25 °C	
	<i>Signal and input conditions</i>	<i>Effective bits</i>
TDS5032B, TDS5034B, TDS5052B, TDS5054B, TDS5054BE	1 MHz, 9.2 div, 5 GS/s sample rate, Sample acquisition mode	6.8 bits
	1 MHz, 9.2 div, 10 MS/s sample rate, HiRes acquisition mode	9.1 bits
TDS5032B, TDS5034B	350 MHz, 6.5 div, 5 GS/s sample rate, Sample acquisition mode	6.5 bits
TDS5052B, TDS5054B, TDS5054BE	500 MHz, 6.5 div, 5 GS/s sample rate, Sample acquisition mode	6.5 bits
TDS5104B	1 MHz, 9.2 div, 5 GS/s sample rate, Sample acquisition mode	6.6 bits
	1 MHz, 9.2 div, 10 MS/s sample rate, HiRes acquisition mode	9.0 bits
	1 GHz, 6.5 div, 5 GS/s sample rate, Sample acquisition mode	4.7 bits

**Table 1-3: Horizontal and acquisition system specifications**

Characteristic	Description	
Acquisition modes	Sample, Peak detect, Hi Res, Average, and Envelope	
Fast acquisition rate	Up to 100,000 waveforms-per-second with Fast Acquisition mode on	
	Up to 130 waveforms-per-second with Fast Acquisition mode off	
Minimum record length	500 points	
Maximum record length	Depends on number of active channels and amount of memory installed	
Standard	2,000,000 points (3 or 4 channels) 4,000,000 points (2 channels) 8,000,000 points (1 channel)	
Option 3M installed	4,000,000 points (3 or 4 channels) 8,000,000 points (2 channels) 16,000,000 points (1 channel)	
Sample rate range, real-time	<i>Number acquired channels</i>	<i>Sample rate range</i>
TDS5032B, TDS5034B, TDS5052B, TDS5054B, TDS5104B	1	1.25 S/s to 5 GS/s
	2	1.25 S/s to 2.5 GS/s
	3 or 4	1.25 S/s to 1.25 GS/s
TDS5054BE	1,2,3, or 4	1.00 S/s to 1.00 GS/s
Equivalent-time sample rate or interpolated waveform rate range	Listed values depend on the number of channels in use, horizontal scale, and resolution settings.  Equivalent-time acquisition can be enabled or disabled. When disabled, waveforms are interpolated at the fastest time base settings.	
TDS5032B, TDS5034B, TDS5052B, TDS5054B, TDS5104B	2.5 GS/s to 250 GS/s	
TDS5054BE	2 GS/s to 200 GS/s	
Seconds/division range	(s/div x 10) to 1,000 s	
Horizontal delay range	16 ns to 250 s	
✓ Long term sample rate and delay time accuracy	±15 ppm over any ≥1 ms interval	
RMS aperture uncertainty, typical	≤ [3 ps + (0.1 ppm × record duration)] for real-time or interpolated records with a duration ≥1 minute	

**Table 1-3: Horizontal and acquisition system specifications (Cont.)**

Characteristic	Description	
✓ Delta time measurement accuracy	For a single channel, with signal amplitude > 5 div, reference level set at 50%, interpolation set to sin(x)/x, volts/division set to ≥ 5 mV/div, with (displayed risetime)/(sample interval) ratio between 1.4 and 4, where sample interval = 1/(real-time sample rate)	
	<i>Conditions</i>	<i>Accuracy</i>
	Single shot signal, Sample, or Hi Res acquisition mode, Full bandwidth	± (15 ppm ×  reading  + 0.3 sample intervals)
	Average acquisition mode, ≥100 averages, Full bandwidth	± (15 ppm ×  reading  + 20 ps)

**Table 1-4: Trigger specifications**

Characteristic	Description	
Auxiliary trigger input resistance, typical	≥1.5 kΩ	
Maximum trigger input voltage, typical	±20 V (DC or peak AC)	
✓ Edge trigger sensitivity, Main and Delayed trigger	<i>Trigger Source</i>	<i>Sensitivity</i>
	TDS5032B, TDS5034B	Any channel, DC coupled
	Auxiliary input	400 mV from DC to 50 MHz, increasing to 750 mV at 100 MHz
TDS5052B, TDS5054B, TDS5054BE	Any channel, DC coupled	0.35 div from DC to 50 MHz, increasing to 1 div at 500 MHz
	Auxiliary input	400 mV from DC to 50 MHz, increasing to 750 mV at 100 MHz
TDS5104B	Any channel, DC coupled	0.35 div from DC to 50 MHz, increasing to 1 div at 1 GHz
	Auxiliary input	400 mV from DC to 50 MHz, increasing to 750 mV at 100 MHz

**Table 1-4: Trigger specifications (Cont.)**

Characteristic	Description	
Edge trigger sensitivity, typical	All sources, for vertical scale settings $\geq 10$ mV/div and $\leq 1$ V/div	
	<i>Trigger coupling</i>	<i>Sensitivity</i>
	NOISE REJ	$3 \times$ the DC-coupled limits
	AC	Same as DC-coupled limits for frequencies $\geq 60$ Hz; attenuates signals $< 60$ Hz
	HF REJ	$1.5 \times$ the DC-coupled limits from DC to 30 kHz; attenuates signals $> 30$ kHz
	LF REJ	$1.5 \times$ the DC-coupled limits for frequencies $\geq 80$ kHz; attenuates signals $< 80$ kHz
Advanced trigger sensitivity, typical	For all trigger types except Edge, with vertical scale settings $\geq 10$ mV/div and $\leq 1$ V/div	
	1.0 div from DC to 500 MHz	
Event count sensitivity, typical	For sequential trigger delayed by events, with vertical scale settings $\geq 10$ mV/div and $\leq 1$ V/div	
	1.0 div, from DC to 500 MHz	
Video trigger sensitivity, typical	For delayed and main triggers, with vertical scale settings $\geq 10$ mV/div and $\leq 1$ V/div	
	Any channel	0.6 to 2.5 divisions of video sync tip
Video Trigger Format	Triggers from negative sync composite video, field 1 or field 2 for interlaced systems, any field, specific line, or any line for interlaced or noninterlaced systems	
	Supported systems include NTSC, PAL, SECAM, and analog HDTV	
Trigger level or threshold range	<i>Trigger Source</i>	<i>Sensitivity</i>
	Any channel	$\pm 10$ divisions from center of screen
	Auxiliary input	$\pm 8$ V
	Line	Fixed at zero volts

**Table 1-4: Trigger specifications (Cont.)**

Characteristic	Description		
Trigger level or threshold accuracy, typical	Edge trigger, DC coupling, for signals having rise and fall times $\leq 20$ ns		
	<i>Trigger Source</i>	<i>Accuracy</i>	
	Any channel	$\pm [(2\% \times   \text{setting} - \text{net offset}  ) + (0.3 \text{ div} \times \text{volts/div setting}) + \text{offset accuracy}]$	
	Auxiliary	Not calibrated or specified	
	<i>Where, net offset = offset - (position <math>\times</math> volts/division)</i>		
Set level to 50% function, typical	Operates with signals $\geq 30$ Hz		
Trigger position error, typical	Edge trigger, DC coupling, for signals having a slew rate at the trigger point of $\leq 0.5$ div/ns		
	<i>Acquisition mode</i>	<i>Error</i>	
	Sample, Average	$\pm (1 \text{ displayed pt} + 1 \text{ ns})$	
	Envelope	$\pm (2 \text{ displayed pts} + 1 \text{ ns})$	
Trigger jitter, typical	$\sigma = 8$ ps RMS		
B Event (Delayed) trigger	<i>Trigger After Time</i>	<i>Trigger on <math>n^{\text{th}}</math> Event</i>	
	Range	Delay time = 16 ns to 250 s	Event count = 1 to $10^7$
	Minimum time between arm (A Event) and trigger (B Event), typical	2 ns from the end of the time period to the B trigger event	2 ns between the A trigger event and the first B trigger event
	Minimum pulse width, typical	—	B event width $\geq 1$ ns
	Maximum frequency, typical	—	B event frequency $\leq 500$ MHz
Advanced trigger timing	For vertical scale settings $\geq 10$ mV/div and $\leq 1$ V/div		
	<i>Minimum recognizable event width or time</i>	<i>Minimum rearm time to recognize next event</i>	
	Glitch type	Minimum glitch width = 1 ns	2 ns + 5% of glitch width setting
	Runt or window type	Minimum runt width = 2 ns	2 ns
	Runt or window type (time qualified)	Minimum runt width = 2 ns	8.5 ns + 5% of runt width setting
	Runt or window type (logic qualified)	Minimum runt width = 2 ns	8.5 ns + 5% of runt width setting



**Table 1-4: Trigger specifications (Cont.)**

Characteristic	Description	
Width type	Minimum difference between upper and lower limits = 1 ns	2 ns + 5% of upper limit setting
Timeout type	Minimum timeout time = 1 ns	2 ns + 5% of timeout setting
Transition type	Minimum transition time = 600 ps	8.5 ns + 5% of transition time setting
Pattern type, typical	Minimum time the pattern is true = 1 ns	1 ns
Logic	Not applicable	1 ns
Events Delay	1 ns (single channel)	Not applicable
State type, typical	Minimum true time before clock edge = 1 ns Minimum true time after clock edge = 1 ns	1 ns
Setup/Hold type, typical	<i>Minimum clock pulse width from active edge to inactive edge</i>	<i>Minimum clock pulse width from inactive edge to active edge</i>
	3 ns + hold time setting	2 ns
	<i>Setup and Hold parameters</i>	<i>Limits</i>
	Setup time (time from data transition to clock edge)	-100 ns minimum +100 ns maximum
	Hold time (time from clock edge to data transition)	-1 ns minimum +102 ns maximum
	Setup time + Hold time (algebraic sum of the two settings)	+2 ns minimum +202 ns maximum

**Table 1-4: Trigger specifications (Cont.)**

Characteristic	Description	
Advanced trigger timer ranges	<i>Limits</i>	
Glitch type	1 ns to 1 s	
Runt or window type, wider than	1 ns to 1 s	
Runt or window type, time qualified	1 ns to 1 s	
Width type	1 ns to 1 s	
Timeout type	1 ns to 1 s	
Transition type	1 ns to 1 s	
Pattern type	1 ns to 1 s	
Setup/Hold type	<i>Setup and Hold timers</i>	<i>Limits</i>
	Setup time (time from data transition to clock edge)	-100 ns to +100 ns
	Hold time (time from clock edge to data transition)	-1 ns to +100 ns
	Setup time + Hold time (algebraic sum of the two settings)	+2 ns to +200 ns
✓ Advanced trigger timer accuracy	For Glitch, Timeout, or Width types	
	<i>Time range</i>	<i>Accuracy</i>
	1 ns to 500 ns	±(20% of setting + 0.5 ns)
	520 ns to 1 s	±(0.01% of setting + 100 ns)
Trigger holdoff range	1.5 μs to 12 s, minimum resolution is 8 μs for settings ≤1.2 ms	

**Table 1-5: Display specifications**

Characteristic	Description
Display type	264 mm (10.4 in) diagonal, liquid crystal active-matrix color display Width: 211.2 mm (8.3 in) Length: 158.4 mm (6.2 in)
Display resolution	640 horizontal × 480 vertical pixels
Pixel pitch	0.33 mm horizontal, 0.33 mm vertical
Contrast ratio, typical	150:1
Response time, typical	50 ms, black to white
Display refresh rate	59.94 frames per second
Displayed intensity levels	Supports Windows SVGA high-color mode (16-bit or 24-bit)

**Table 1-6: Input/output port specifications**

Characteristic	Description
✓ Probe Compensator Output	Front-panel terminals <i>Output voltage</i>   <i>Frequency</i> 1.0 V (from base to top) ±1.0% into a ≥ 10 kΩ load   1 kHz ±5%
✓ Analog Signal Output	Rear-panel BNC connector, provides a buffered version of the signal that is attached to the channel 3 signal input 50 mV/div ±20% into a 1 MΩ load 25 mV/div ±20% into a 50 Ω load
Bandwidth, typical	100 MHz into a 50 Ω load
✓ Auxiliary Output levels	Rear-panel BNC connector, provides a TTL-compatible, negative-polarity pulse for each A or B trigger (selectable) <i>V<sub>out high</sub></i>   <i>V<sub>out low (true)</sub></i> ≥2.5 V into open circuit, ≥1.0 V into 50 Ω load   ≤0.7 V with ≤4 mA sink, ≤0.25 V into 50 Ω load
Auxiliary Output pulse width, typical	Pulse width varies, 1 μs minimum
External Reference Input	Rear-panel BNC connector 9.8 MHz to 10.2 MHz 200 mV <sub>p-p</sub> to 7 V <sub>p-p</sub> < 1.5 kΩ in series with ~10 nF DC blocking capacitor
Side-panel I/O ports	Ports located on the side panel

**Table 1-6: Input/output port specifications (Cont.)**

Characteristic	Description
Parallel port (IEEE 1284)	DB-25 connector, supports the following modes: Standard, output only  Bidirectional, PS-2 compatible  Bidirectional Enhanced Parallel Port (IEEE 1284 standard, mode 1 or mode 2, v 1.7)  Bidirectional High-speed Extended Capabilities Port
Audio ports	Miniature phone jacks for stereo microphone input and stereo line output
USB port (2)	Allows connection of USB keyboard/mouse and or other devices while scope power is on  Supports USB 2.0 protocol
Keyboard port	PS-2 compatible, oscilloscope power must be off to make connection
Mouse port	PS-2 compatible, oscilloscope power must be off to make connection
LAN port	RJ-45 connector, supports 10 base-T and 100 base-T
Serial port (COM1)	DB-9 connector, uses NS16C550-compatible UARTS, transfer speeds up to 115.2 kb/s
SVGA video port	Upper video port, DB-15 female connector, connect a second monitor to use dual-monitor display mode, supports Basic requirements of PC99 specifications
GPIB port	IEEE 488.2 standard interface
Scope VGA video port	Lower video port, DB-15 female connector, 31.6 kHz sync, EIA RS-343A compliant, connect to show the oscilloscope display, including live waveforms, on an external monitor

**Table 1-7: Data storage specifications**

Characteristic	Description
CD-ROM	Side-panel CD-R/W drive; reads CD/CD-ROM, CD-R, and CD-R/W disks  24X read speed; 24X write speed
Floppy disk	Front-panel 3.5 in USB floppy disk drive, 1.44 MB capacity
Hard disk	Standard internal hard disk capacity: 80 GB  External hard disk capacity: refer to added options

**Table 1-8: Power source specifications**

Characteristic	Description
Source voltage and frequency	100 to 240 V <sub>RMS</sub> ±10%, 47 Hz to 63 Hz
Power consumption	≤ 220 Watts
Fuse rating	Internal to power supply; not serviceable by user
Nonvolatile memory retention	CMOS settings stored for a period of 3 years without instrument connection to power mains
	Calibration settings and error log entries stored for 1 million cycles or 20 years
Overvoltage Category	Overvoltage Category II (as defined in IEC61010-1/A2)

**Table 1-9: Mechanical specifications**

Characteristic	Description		
Weight	Benchtop configuration		
	24.75 lbs (10.2 kg) oscilloscope only 56.5 lbs (25.6 kg) when packaged for domestic shipment		
Rackmount kit	5 lbs (2.3 kg) rackmount conversion kit 8 lbs (3.6 kg) kit packaged for domestic shipment		
Dimensions	Benchtop configuration		
	Height: 14.2 in (360.7 mm) Height, feet extended: 14.25 in (362 mm) Width: 17.6 in (447 mm) Depth: 11.35 in (288.3 mm)		
Rackmount configuration (Option 1R)	Height: 10.5 in (267 mm) Width: 19 in (483 mm) Depth: 9.1 in (231 mm)		
Cooling	Fan-forced air circulation with no air filter		
	Required clearances	Top	0 in (0 mm)
		Bottom	0.25 in minimum or 0 in (0 mm) when standing on the feet
		Left side	3 in (76 mm)
		Right side	0 in [5 in (126 mm) required to access CD-ROM]
		Front	0 in (0 mm)
		Rear	0 in (0 mm)

**Table 1-9: Mechanical specifications (Cont.)**

Characteristic	Description
Construction material	Chassis parts constructed of aluminum alloy; front-panel constructed of plastic laminate; circuit boards constructed of glass laminate; outer shell molded and textured from a polycarbonate/ABS blend

**Table 1-10: Environmental specifications**

Characteristic	Description
Temperature	
Operating	+5 °C to +45 °C (+41 °F to +113 °F) +15 °C to +45 °C (+59 °F to +113 °F) with integrated printer, Option 1P, installed
Nonoperating	-20 °C to +60 °C (-4 °F to +140 °F)
Humidity	
Operating	20% to 80% relative humidity with a maximum wet bulb temperature of +29 °C (84.2 °F) at or below +45 °C (113 °F), noncondensing  Upper limit derated to 30% relative humidity at +45 °C (113 °F)
Nonoperating	With no diskette in floppy disk drive  5% to 90% relative humidity with a maximum wet bulb temperature of +29 °C (84.2 °F) at or below +60 °C (+140 °F), noncondensing  Upper limit derated to 20% relative humidity at +60 °C (+140 °F)
Altitude	
Operating	10,000 ft (3,048 m)
Nonoperating	40,000 ft (12,190 m)
Random vibration	
Operating	0.1 g <sub>RMS</sub> from 5 Hz to 500 Hz, 10 minutes on each axis
Nonoperating	2.0 g <sub>RMS</sub> from 5 Hz to 500 Hz, 10 minutes on each axis
Shock, nonoperating	30 g (11 ms half-sine wave) or less

**Table 1- 11: Certifications and compliances**

Category	Standards or description
EC Declaration of Conformity - EMC	<p>Meets intent of Directive 89/336/EEC for Electromagnetic Compatibility. Compliance was demonstrated to the following specifications as listed in the Official Journal of the European Union:</p> <p>EN 61326 Emissions <sup>1, 3, 4</sup> Class A Radiated and Conducted Emissions</p> <p>EN 61326 Immunity <sup>1, 4</sup></p> <p>IEC 61000-4-2 Electrostatic Discharge Immunity ±4 kV contact discharge, ±8 kV air discharge</p> <p>IEC 61000-4-3 RF field immunity 3 V/m, 80 MHz to 1 GHz, 80% amplitude modulated with a 1 kHz sinewave <sup>2</sup></p> <p>IEC 61000-4-4 Electrical Fast Transient/Burst Immunity 1 kV on AC mains, 500 V on I/O</p> <p>IEC 61000-4-5 AC Surge Immunity 500 V differential mode, 1 kV common mode</p> <p>IEC 61000-4-6 RF Conducted Immunity 3 V, 150 kHz to 80 MHz, amplitude modulated with a 1 kHz sinewave <sup>2</sup></p> <p>IEC 61000-4-11 AC Mains Voltage Dips and Interruption Immunity 100% reduction for one cycle</p> <p>EN 61000-3-2 Power Harmonic Current Emissions</p> <p>EN 61000-3-3 Voltage Changes, Fluctuations, and Flicker</p> <p><sup>1</sup> Use low-EMI shielded interconnect cables, equivalent to the following Tektronix cables:            GPIB cable: 012-0991-01, 012-0991-02, or 012-0991-03.            RS-232 cable: 012-1213-00 or CA part number 0294-9.            Centronics Cable: 012-1214-00 or LCOM part number CTL3VGAMM-5 VGA Cable.</p> <p><sup>2</sup> Under these conditions, the specifications are amended as follows:            1 mV/division to 1 V/division: ≤0.2 division waveform displacement or ≤0.4 division increase in peak-to-peak noise.</p> <p><sup>3</sup> Radiated emissions may exceed the levels specified in EN 61326 when this oscilloscope is connected to a test object.</p> <p><sup>4</sup> Tested in accordance with EN 61326 Annex D.</p>
FCC	Radiated and conducted emissions do not exceed the levels specified in FCC47 CFR, Part 15, Subpart B, for Class A equipment.

**Table 1- 11: Certifications and compliances (cont.)**

Category	Standards or description
EC Declaration of Conformity - Low Voltage	<p>Compliance was demonstrated to the following specification as listed in the Official Journal of the European Union:</p> <p>Low Voltage Directive 73/23/EEC, amended by 93/68/EEC</p> <p>EN 61010-1/A2:1995 Safety requirements for electrical equipment for measurement control and laboratory use.</p>
U.S. Nationally Recognized Testing Laboratory Listing	<p>UL3111-1, First Edition Standard for electrical measuring and test equipment.</p>
Canadian Certification	<p>CAN/CSA C22.2, No. 1010.1-92 Safety requirements for electrical equipment for measurement, control, and laboratory use.</p>
Additional Compliance	<p>IEC61010-1/A2 Safety requirements for electrical equipment for measurement, control, and laboratory use.</p>
Installation (Overvoltage) Category	<p>Terminals on this product may have different installation (overvoltage) category designations. The installation categories are:</p> <p>CAT III Distribution-level mains (usually permanently connected). Equipment at this level is typically in a fixed industrial location.</p> <p>CAT II Local-level mains (wall sockets). Equipment at this level includes appliances, portable tools, and similar products. Equipment is usually cord-connected.</p> <p>CAT I Secondary (signal level) or battery operated circuits of electronic equipment.</p>
Pollution Degree	<p>A measure of the contaminates that could occur in the environment around and within a product. Typically the internal environment inside a product is considered to be the same as the external. Products should be used only in the environment for which they are rated.</p> <p>Pollution Degree 2 Normally only dry, nonconductive pollution occurs. Occasionally a temporary conductivity that is caused by condensation must be expected. This location is a typical office/home environment. Temporary condensation occurs only when the product is out of service.</p>
<b>Safety Certification Compliance</b>	
Equipment Type	Test and measuring
Safety Class	Class 1 (as defined in IEC 61010-1/A2) - grounded product
Pollution Degree	<p>Pollution Degree 2 as defined in IEC 61010-1/A2</p> <p>Rated for indoor use only</p>



# Performance Verification

Two types of Performance Verification procedures can be performed on this product: *Brief Procedures* and *Performance Tests*. You may not need to perform all of these procedures, depending on what you want to accomplish.

- To rapidly confirm oscilloscope function and proper adjustment, perform the procedures under *Self Tests*, which begin on page 2-5.

**Advantages:** These procedures are quick to do, require no external equipment or signal sources, and perform extensive functional and accuracy testing to provide high confidence that the oscilloscope will perform properly. They can be used as a quick check before making a series of important measurements.

- To further check functionality, first perform the *Self Tests* just mentioned; then perform the procedures under *Functional Tests* that begin on page 2-6.

**Advantages:** These procedures require minimal additional time to perform, require no additional equipment other than a 10X probe such as a P5050, and more completely test the internal hardware of the oscilloscope. They can be used to quickly determine if the oscilloscope is suitable for putting into service, such as when it is first received.

- If more extensive confirmation of performance is desired, do the *Performance Tests*, beginning on page 2-17, after doing the *Functional* and *Self Tests* mentioned above.

**Advantages:** These procedures add direct checking of the warranted specifications marked with the ✓ symbol in the *Specifications* section. These procedures are fairly quick to execute but require specific test equipment. (See *Table 2-1: Test equipment* on page 2-18).

If you are not familiar with operating this oscilloscope, read the oscilloscope reference or user manuals or explore the online help.

## Conventions

Throughout the performance verifications procedures the following conventions apply:

- Each test procedure uses the following general format:
  - Title of Test
  - Equipment Required
  - Prerequisites
  - Procedure
- Each procedure consists of as many steps, substeps, and subparts as required to perform the test. Steps, substeps, and subparts are sequenced as follows:
  1. First Step
    - a. First Substep
      - First Subpart
      - Second Subpart
    - b. Second Substep
  2. Second Step
- In steps and substeps, the lead-in statement in italics instructs you what to do, while the instructions that follow tell you how to do it, as in the example step below:

*Initialize the oscilloscope:* Push the front-panel **DEFAULT SETUP** button.
- Where instructed to use a control in the display or a front-panel button or knob, the name of the control, button, or knob appears in boldface type. Where instructed to make or verify a setting, the value of the setting also appears in boldface type.

---

**STOP.** *The **STOP** notation at the left is accompanied by information you must read to do the procedure properly.*

---

- The term “toolbar” refers to a row of buttons at the top of the display. The term “menu bar” refers to a row of menus at the top of the display. You can switch between toolbar and menu bar operating modes by clicking the button near the top right corner of the display. See Figure 2-1.

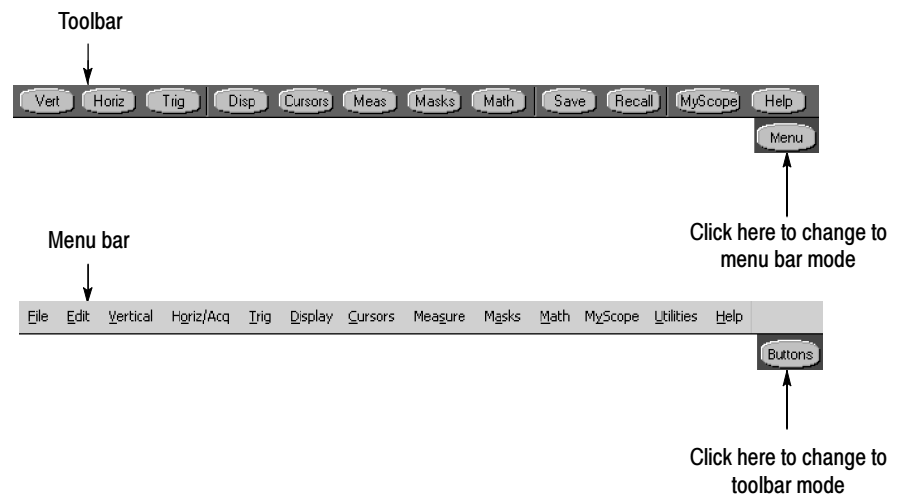

**Figure 2-1: Toolbar and menu bar**

- The procedures to follow assume that you have connected a mouse to the oscilloscope so that you can click on the screen controls. If you have not connected a mouse, you can use the optional touch screen to operate all the screen controls.



# Brief Procedures

The *Self Tests* use internal routines to confirm basic functionality and proper adjustment. No test equipment is required to perform these test procedures.

The *Functional Tests* utilize the probe-compensation output at the front panel as a test-signal source for further verifying that the oscilloscope functions properly. A 10X probe, such as a P5050, is required to perform these test procedures.

## Self Tests

This procedure uses internal routines to verify that the oscilloscope is adjusted and functioning properly. No test equipment or hookups are required.

### Verify Internal Adjustment, Self Compensation, and Diagnostics

<b>Equipment required</b>	None
<b>Prerequisites</b>	Power on the oscilloscope and allow a 20 minute warm-up before initiating this test procedure.

1. *Verify that internal diagnostics pass:* Perform the following substeps to verify passing of internal diagnostics.
  - a. *Display the System diagnostics menu:*
    - If the oscilloscope is in toolbar mode, click the **MENU** button to put the oscilloscope into menu bar mode.
    - Pull down the **Utility** menu and select **Instrument Diagnostics. . . .** This displays the diagnostics control window.
  - b. *Run the System Diagnostics:*
    - First disconnect all input signals from the instrument.
    - Click the **Run** button in the diagnostics control window.
  - c. *Wait:* The internal diagnostics do an exhaustive verification of proper oscilloscope function. This verification may take several minutes. When the verification is complete, the resulting status will appear in the diagnostics control window.
  - d. *Verify that no failures are found and reported on-screen.* All tests should pass. If any failures occur, you can use the GPIB command **DIAG:RESULTS:VERBOSE?** to query for details on the errors.

- e. *Run the signal-path compensation routine:*
  - Pull down the Utilities menu and select **Instrument Calibration**. . . . This displays the instrument calibration control window.

---

**NOTE.** *Signal Path Compensation is not valid until the oscilloscope reaches a valid temperature. Calibration Status must be **Pass**.*

---

- Click the **Calibrate** button to start the routine.
  - f. *Wait:* Signal-path compensation may take ten minutes to run.
  - g. *Confirm signal-path compensation returns passed status:* Verify that the word **Pass** appears in the instrument calibration control window.
2. *Return to regular service:* Click the **Close** button to exit the instrument calibration control window.

## Functional Tests

The purpose of these procedures is to confirm that the oscilloscope functions properly. The only equipment required is a 10X probe, such as a P5050.

To check the file system, a 3.5 inch, 720 K or 1.44 Mbyte, formatted floppy disk is required.

---

**NOTE.** *If your instrument includes Option FHD (Front-Panel Removable Hard Disk Drive) you do not have a floppy disk drive. If you need to store settings during these procedures, access the local C:drive and store them in the TekScope > Setups directory.*

---

---

**STOP.** *The following procedures verify instrument functionality; that is, they verify that oscilloscope features operate properly. They do not verify that they operate within limits.*

*For example, when the instructions in the following functional tests request that you verify that a signal appears on-screen “that is about five divisions in amplitude” or “has a period of about six horizontal divisions,” do NOT interpret these quantities as given limits. Operation within limits is checked in Performance Tests, which begin on page 2-17.*

---

**STOP.** In the following procedures, do not make changes to front-panel settings that are not specifically called out. Each verification procedure requires that you set the oscilloscope to certain default settings before verifying functions. If you make changes to settings other than those called out in a procedure, you may obtain invalid results. In such cases, repeat the procedure starting over from step 1.

If you are instructed to press a front-panel or screen button, the button may already be selected (its label will be highlighted). If this is the case, it is not necessary to press the button.

## Verify All Input Channels

<b>Equipment required</b>	One 10X oscilloscope probe, such as Tektronix P5050
<b>Prerequisites</b>	None

1. *Initialize the oscilloscope:* Push the front-panel **DEFAULT SETUP** button.
2. *Hook up the signal source:* Connect the probe to the probe compensation connector and the channel input that you want to test (beginning with CH 1) as shown in Figure 2-2.

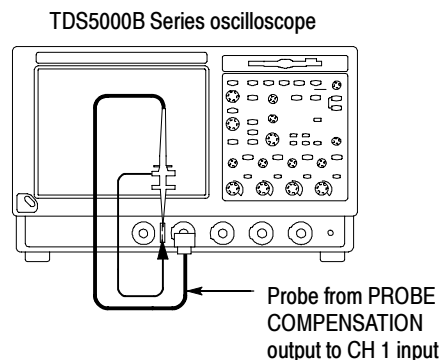

**Figure 2-2: Universal test hookup for functional tests - CH 1 shown**

3. *Turn off all channels:* If any of the front-panel channel buttons are lighted, push those buttons to turn off the displayed channels. See Figure 2-3.

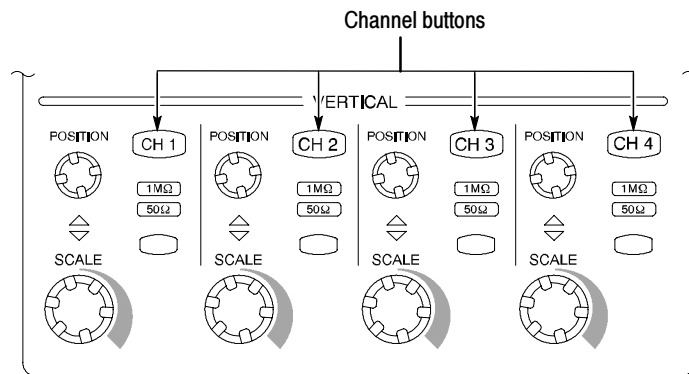

**Figure 2-3: Channel button location**

4. *Select the channel to test:* Push the channel button for the channel that you are currently testing. The button lights, and the channel display comes on.
5. *Set up the oscilloscope:* Push the front panel **AUTOSET** button. This sets the horizontal and vertical scale for a usable display and also sets the trigger source to the channel that you are testing.
6. *Verify that the channel is operational:* Confirm that the following statements are true.
  - The vertical scale readout for the channel under test shows a setting of 500 mV, and a square-wave probe-compensation signal about 2 divisions in amplitude is on-screen.
  - The front-panel vertical **POSITION** knob (for the channel that you are testing) moves the signal up and down the screen when rotated.
  - Turning the vertical **SCALE** knob counterclockwise (for the channel that you are testing) decreases the amplitude of the waveform on-screen, turning the knob clockwise increases the amplitude, and returning the knob to 500 mV returns the amplitude to about 2 divisions.
7. *Verify that the channel acquires in all acquisition modes:* Pull down the Horiz/Acq menu to select **Horizontal/Acquisition Setup**. . . . Click the **Acquisition** tab in the control window that displays. Click each of the six acquisition modes and confirm that the following statements are true.
  - Sample mode displays an actively acquiring waveform on-screen. (Note that there is a small amount of noise present on the square wave).
  - Peak Detect mode displays an actively acquiring waveform on-screen with the noise present in Sample mode “peak detected.”
  - Hi Res mode displays an actively acquiring waveform on-screen with the noise that was present in Sample mode reduced.



- Average mode displays an actively acquiring waveform on-screen with the noise reduced.
  - Envelope mode displays an actively acquiring waveform on-screen with the noise displayed.
  - WMFDB Mode displays an actively acquiring waveform on-screen with noise. All channels will change to a red color.
8. *Test all channels:* Repeat steps 2 through 7 until all input channels are verified.
  9. *Remove the test hookup:* Disconnect the probe from the channel input and the probe compensation output.

### Verify the Time Base

<b>Equipment required</b>	One 10X oscilloscope probe, such as Tektronix P5050
<b>Prerequisites</b>	None

1. *Initialize the oscilloscope:* Push the front-panel **DEFAULT SETUP** button.
2. *Hook up the signal source:* Connect the probe to the probe compensation output and to the CH 1 input as shown in Figure 2-4.

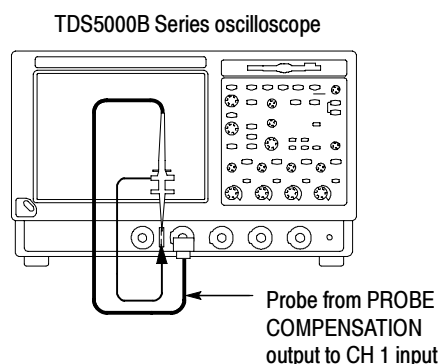

**Figure 2-4: Setup for time base test**

3. *Set up the oscilloscope:* Push the front panel **AUTOSET** button.
4. *Set the time base:* Set the horizontal **SCALE** to **200  $\mu\text{s}/\text{div}$** . The time-base readout is displayed at the bottom of the graticule.
5. *Verify that the time base operates:* Confirm the following statements.
  - One period of the square-wave probe-compensation signal is about five horizontal divisions on-screen for the 200  $\mu\text{s}/\text{div}$  horizontal scale setting.

- Rotating the horizontal SCALE knob clockwise expands the waveform on-screen (more horizontal divisions per waveform period), counter-clockwise rotation contracts it, and returning the horizontal scale to 200  $\mu\text{s}/\text{div}$  returns the period to about five divisions.
  - The horizontal POSITION knob positions the signal left and right on-screen when rotated.
6. *Verify horizontal delay:*
- a. *Center a rising edge on screen:*
    - Set the horizontal POSITION knob so the rising edge, where the waveform is triggered, lines up with the center horizontal graticule.
    - Change the horizontal SCALE to **20  $\mu\text{s}/\text{div}$** . The rising edge of the waveform should remain near the center graticule and the falling edge should be off screen.
  - b. *Turn on and set horizontal delay:*
    - Pull down the Horiz/Acq menu to select **Horizontal/Acquisition Setup. . . .**
    - Click the **Horizontal** tab in the control window that displays.
    - Click the **Delay Mode** button to turn delay on.
    - Double click the **Horiz Delay** control in the control window to display the pop-up keypad. Click the keypad buttons to set the horizontal delay to **500  $\mu\text{s}$** , and then click the **ENTER** key.
  - c. *Verify the waveform:* Verify that a falling edge of the waveform is within a few divisions of center screen.
  - d. *Adjust the horizontal delay:* Rotate the upper multipurpose knob to change the horizontal delay setting. Verify that the falling edge shifts horizontally. Rotate the front-panel horizontal **POSITION** knob. Verify that this knob has the same effect (it also adjusts delay, but only when delay mode is on).
  - e. *Verify the delay toggle function:*
    - Rotate the front-panel horizontal POSITION knob to center the falling edge horizontally on the screen.
    - Change the horizontal SCALE to **40 ns/div (50 ns/div for TDS5054BE)**. The falling edge of the waveform should remain near the center graticule. If not, readjust the delay setting to center the falling edge.

- Push the front-panel **DELAY** button several times to toggle delay off and on and back off again. Verify that the display switches quickly between two different points in time (the rising and falling edges of this signal).
7. *Remove the test hookup:* Disconnect the probe from the channel input and the probe compensation output.

### Verify the A (Main) and B (Delayed) Trigger Systems

<b>Equipment required</b>	One 10X oscilloscope probe, such as Tektronix P5050
<b>Prerequisites</b>	None

1. *Initialize the oscilloscope:* Push the front-panel **DEFAULT SETUP** button.
2. *Hook up the signal source:* Connect the probe to the probe compensation output and to the CH 1 input as shown in Figure 2-5.

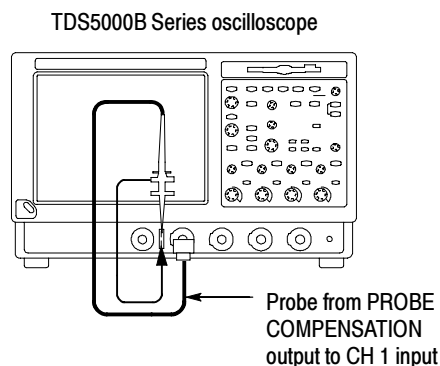

**Figure 2-5: Setup for trigger test**

3. *Set up the oscilloscope:* Push the front-panel **AUTOSSET** button.
4. *Verify that the main trigger system operates:* Confirm that the following statements are true.
  - The trigger level readout for the A (main) trigger system changes with the trigger-LEVEL knob.
  - The trigger-LEVEL knob can trigger and untrigger the square-wave signal as you rotate it. (Leave the signal *untriggered*).
  - Pushing the front-panel trigger **LEVEL** knob sets the trigger level to the 50% amplitude point of the signal and triggers the signal that you just left untriggered. (Leave the signal triggered.)

5. *Verify that the delayed trigger system operates:*
  - a. *Set up the delayed trigger:*
    - Pull down the Trig menu and select **A→B Trigger Sequence. . .**. This displays the A→B Sequence tab of the trigger setup control window.
    - Click the **Trig After Time** button under A Then B.
    - Click the **B Trig Level** control in the control window.
    - Set the Trigger MODE to **NORM**.
  - b. *Confirm that the following statements are true:*
    - The trigger-level readout for the B trigger system changes as you turn the lower multipurpose knob.
    - As you rotate the lower multipurpose knob, the square-wave probe-compensation signal can become triggered and untriggered. (Leave the signal triggered.)
  - c. *Verify the delayed trigger counter:*
    - Double-click the **Trig Delay** control to pop up a numeric keypad for that control.
    - Click on the keypad to enter a trigger delay time of **1 second**, and then click **Enter**.
    - Verify that the **TRIG'D** indicator on the front panel flashes about once every second as the waveform is updated on-screen.
6. *Remove the test hookup:* Disconnect the probe from the channel input and the probe compensation output.

### Verify the File System

<b>Equipment required</b>	One 10X oscilloscope probe, such as Tektronix P5050 One 720 K or 1.44 Mbyte, 3.5 inch DOS-compatible formatted disk. If your instrument does not include a floppy disk drive, see the Note on page 2-6.
<b>Prerequisites</b>	None

1. *Initialize the oscilloscope:* Push the front-panel **DEFAULT SETUP** button.
2. *Hook up the signal source:* Connect the probe to the probe compensation output and the CH 1 input as shown in Figure 2-6.

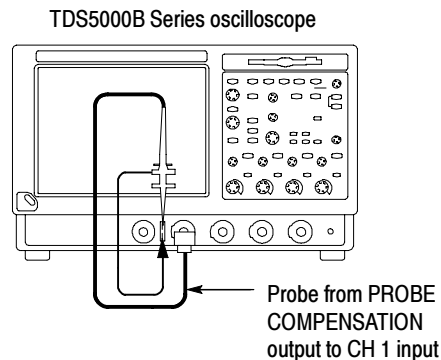

**Figure 2-6: Setup for the file system test**

3. *Insert the test disk:* Insert the floppy disk in the floppy disk drive at the top of the front panel. If your instrument does not include a floppy disk drive, see the Note on page 2-6.
4. *Set up the oscilloscope:* Push the front panel **AUTOSET** button.
5. *Set the time base:* Set the horizontal **SCALE** to **1 ms/div**. The time-base readout is displayed at the bottom of the graticule.
6. *Save the settings:*
  - a. From the File menu select **Save As**. This displays the Save As dialog box.
  - b. In the Save What field click **Waveform**.
  - c. In the Source drop-down list box select **CH1**.
  - d. In the Save in drop-down list box select **3<sup>1</sup>/<sub>2</sub> Floppy**.
  - e. Note the default file name.
  - f. Click the **Save** button to save the waveform to the floppy disk.
7. *Change the settings again:* Set the horizontal **SCALE** to **200  $\mu$ s/div**.
8. *Verify the file system works:*
  - a. From the File menu select **Recall**. This displays the Recall dialog box.
  - b. In the Recall What field click **Waveform**.
  - c. In the Look in drop-down list box select **3<sup>1</sup>/<sub>2</sub> Floppy**. If your instrument does not include a floppy disk drive, see the Note on page 2-6.
  - d. Locate and select the waveform file name you previously stored.
  - e. Click the **Recall** button to display the stored waveform on screen.

- f. Verify that the oscilloscope retrieved the saved waveform from the disk. Do this by noticing the horizontal SCALE is again 1 ms and the waveform shows ten cycles just as it did when you saved the setup.

9. *Remove the test hookup:*

- a. Disconnect the probe from the channel input and the probe compensation output.
- b. Remove the floppy disk from the floppy disk drive, if present.

**Verify the Internal Printer  
(Optional)**

<b>Equipment required</b>	Integrated Thermal Printer (Option 1P)
<b>Prerequisites</b>	None

1. From the Windows desktop, select **Start > Settings > Control Panel**.
2. Open the Printers file.
3. Right-click on the Integrated Thermal Printer icon; then select Properties.
4. Click the **General** tab.
5. Click **Print Test Page**.
6. Verify that the test page advances through the printer and prints clearly. Refer to Figure 2-7 on page 2-15 for a sample of the test page.



# Windows Millennium Edition

Congratulations!

If you can read this information, you have correctly installed your Integrated Thermal Printer.

The information below describes your printer driver and port settings.

Printer name: Integrated Thermal Printer  
Printer model: Integrated Thermal Printer  
Driver name: ITP.DRV  
Driver version: 4.00  
Color support: No  
Port name: LPTUSB001:  
Data format: RAW

Files used by this driver:  
C:\WINDOWS\SYSTEM\ITP.DRV (GPC  
257.5308840)  
C:\WINDOWS\SYSTEM\UNIDRV.DLL (4.90.3000)  
C:\WINDOWS\SYSTEM\UNIDRV.HLP  
C:\WINDOWS\SYSTEM\ICONLIB.DLL (4.90.3000)

This is the end of the printer test page.

**Figure 2-7: Example test page from the internal printer**





# Performance Tests

This section contains a collection of manual procedures for checking that the TDS5000B Series Oscilloscopes performs as warranted. The preceding procedures are faster to complete, and should be done first if you intend to perform the performance tests.

The procedures are arranged in four logical groupings: *Signal Acquisition System Checks*, *Time Base System Checks*, *Triggering System Checks*, and *Output Ports Checks*. They verify all characteristics designated as checked in the *Specifications section*. (The characteristics that are checked appear with a ✓).

---

**STOP.** *The following procedures extend the confidence level provided by the basic procedures described on page 2-5. The basic procedures should be completed first; then complete the procedures in this section, if desired.*

---

## Prerequisites

The tests in this section comprise an extensive, valid confirmation of performance and functionality when the following requirements are met:

- The cover is not removed from the oscilloscope.
- You have performed and passed the procedures under *Self Tests*, found on page 2-5, and those under *Functional Tests*, found on page 2-6.
- You have completed a signal-path compensation within the recommended calibration interval and at a temperature within  $\pm 5$  °C ( $\pm 9$  °F) of the present operating temperature. (If at the time you did the prerequisite *Self Tests*, the temperature was within the limits just stated, consider this prerequisite met).
- The oscilloscope was last adjusted at an ambient temperature between 20 °C (68 °F) and 30 °C (86 °F), has been warmed-up for a period of at least 20 minutes, and is operating within the ambient temperature described in Table 1-10 on page 1-22. (The warm-up requirement is usually met in the course of meeting the Self Tests and Functional Tests prerequisites listed above).

## Equipment Required

The procedures starting on page 2–24 use external, traceable, signal sources to check warranted characteristics. Table 2-1 lists recommended equipment.

**Table 2-1: Test equipment**

Item number and description	Minimum requirements	Example	Purpose
1. Attenuator, 10X (two required)	Ratio: 10X; impedance 50 $\Omega$ ; connectors: female BNC input, male BNC output	Tektronix part number 011-0059-02	Signal Attenuation
2. Attenuator, 5X	Ratio: 5X; impedance 50 $\Omega$ ; connectors: female BNC input, male BNC output	Tektronix part number 011-0060-02	Signal Attenuation
3. Termination, 50 $\Omega$	Impedance 50 $\Omega$ ; connectors: female BNC input, male BNC output	Tektronix part number 011-0049-01	Signal Termination for Channel Delay Test
4. Cable, Precision 50 $\Omega$ Coaxial (three required)	50 $\Omega$ , 36 in, male-to-male BNC connectors	Tektronix part number 012-0482-00	Signal Interconnection
5. Connector, Dual-Banana (two required)	Female BNC-to-dual banana	Tektronix part number 103-0090-00	Various Accuracy Tests
6. Connector, BNC "T"	Male BNC-to-dual female BNC	Tektronix part number 103-0030-00	Checking Trigger Sensitivity
7. Coupler, Dual-Input	Female BNC-to-dual male BNC	Tektronix part number 067-0525-02	Checking Delay Between Channels
8. Probe, 10X	A P5050, P6243, or P6245 probe <sup>3</sup>	Tektronix part number P5050 or P6245	Signal Interconnection
9. Floppy disk	3.5 inch, 720 K or 1.44 Mbyte, DOS-compatible floppy disk	Standard IBM PC-compatible disk	Checking File System Basic Functionality
10. Generator, DC Calibration	Variable amplitude to $\pm 104$ V; accuracy to 0.1%	Wavetek 9500 <sup>1</sup>	Checking DC Offset, Gain, and Measurement Accuracy
11. Generator, Calibration	500 mV square wave calibrator amplitude; accuracy to 0.25%	Wavetek 9500 <sup>1</sup>	To check accuracy of Signal Out
12. Generator, Time Mark (optional)	Variable marker frequency from 10 ms to 10 ns; accuracy within 2 ppm	Wavetek 9500 <sup>1</sup>	Checking Sample-Rate and Delay-time Accuracy
13. Generator, Sine Wave	250 kHz to $\geq 500$ MHz (higher for higher-bandwidth oscilloscopes). Variable amplitude from 60 mV to 2 V <sub>p-p</sub> into 50 $\Omega$ . Frequency error $>2.0\%$	Wavetek 9500 <sup>1</sup>	Checking Analog Bandwidth, Trigger Sensitivity, Sample-rate, External Clock, and Delay-Time Accuracy
14. Meter, Level and Power Sensor	Frequency range: 10 MHz to the oscilloscope bandwidth. Amplitude range: 6 mV <sub>p-p</sub> to 2 V <sub>p-p</sub>	Wavetek 9500 <sup>1</sup>	Checking Analog Bandwidth and Trigger Sensitivity
15. Splitter, Power	Frequency range: DC to 4 GHz. Tracking: $>2.0\%$	Wavetek 9500 <sup>1</sup>	Checking Analog Bandwidth

Table 2-1: Test equipment (Cont.)

Item number and description	Minimum requirements	Example	Purpose
16. Adapter (three required)	SMA female-to-female	Tektronix part number 015-1012-00	Checking the delay between channels
17. Adapter (three required)	SMA male-to-female BNC	Tektronix part number 015-1018-00	Checking the delay between channels
18. Pulse Generator	250 MHz, $\leq 1$ ns rise time, 5 V out	Wavetek 9500 <sup>1,2</sup>	Used to Test Delta Time Measurement Accuracy
19. Cable, Coaxial (two required)	50 $\Omega$ , 20 in, male-to-male SMA connectors	Tektronix part number 174-1427-00	Used to Test Delta Time Measurement Accuracy
20. Adapter (four required)	Male N-to-female BNC	Tektronix part number 103-0045-00	Checking Analog Bandwidth
21. Adapter	Female N-to-male BNC	Tektronix part number 103-0058-00	Checking Analog Bandwidth
22. Adapter	SMA "T", male to 2 SMA female	Tektronix part number 015-1016-00	Used to Test Delta Time Measurement Accuracy
23. Adapter	SMA female to BNC male	Tektronix part number 015-0572-00	Used to Test Delta Time Measurement Accuracy
24. Adapter	BNC male to female elbow	Tektronix part number 103-0031-00	Used to Test Delta Time Measurement Accuracy
25. Adapter	BNC female to clip lead	Tektronix part number 013-0076-00	Used to Test Probe Compensation Output
26. Termination	Short circuit, SMA connector	Tektronix part number 015-1021-00	Used to Test Delta Time Measurement Accuracy
27. Attenuator, 2X	Ratio: 2X; impedance 50 $\Omega$ ; connectors: female BNC input, male BNC output	Tektronix part number 011-0069-02	Used to Test Delta Time Measurement Accuracy
28. Mouse or keyboard		Tektronix part numbers: 119-6298-xx (mouse) 119-6297-xx (keyboard)	Used to input test selections

<sup>1</sup> Wavetek 9500/Option 100 and output head appropriate for the bandwidth of the oscilloscope under test (9520, 9530, 9560). **Warning: This generator can output dangerous voltages. Set the generator to Off or 0 volts before connecting, disconnecting, or changing any test hookup during all procedures to follow. Also read the Warning statement on page 2-24.**

<sup>2</sup> For Delta Time Measurement Accuracy, use a Wavetek 9500 or a pulse generator with a rise time as shown in Table 2-4 on page 2-45.

<sup>3</sup> **Warning: The P6243 and P6245 probes that may be used with this oscilloscope provide an extremely low loading capacitance (<1 pF) to ensure the best possible signal reproduction. These probes should not be used to measure signals exceeding  $\pm 8$  V, or errors in signal measurement will be observed. Above 40 V, damage to the probe may result. To make measurements beyond  $\pm 8$  V, use either the P5050 probe (good to 500 V), or refer to the catalog for a recommended probe.**

## TDS5000B Series Test Record

Photocopy this table and use it to record the performance test results for your TDS5000B Series Oscilloscope.

### TDS 5000B Series Test Record

Instrument Serial Number: \_\_\_\_\_ Certificate Number: \_\_\_\_\_  
 Temperature: \_\_\_\_\_ RH %: \_\_\_\_\_  
 Date of Calibration: \_\_\_\_\_ Technician: \_\_\_\_\_

TDS5000B Series performance test		Minimum	Incoming	Outgoing	Maximum
DC voltage measurement accuracy (averaged)					
CH1	5 mV Vert scale setting, -5 Div position setting, +1 V offset	+ 1.0353 V	_____	_____	+ 1.0447 V
CH1	5 mV Vert scale setting, +5 Div position setting, -1 V offset	- 1.0447 V	_____	_____	- 1.0353 V
CH1	200 mV Vert scale setting, -5 Div position setting, +10 V offset	+ 11.4989 V	_____	_____	+ 11.7011 V
CH1	200 mV Vert scale setting, +5 Div position setting, -10 V offset	- 11.7011 V	_____	_____	- 11.4989 V
CH1	1.01 V Vert scale setting, -5 Div position setting, +10 V offset	+ 17.602 V	_____	_____	+ 18.398 V
CH1	1.01 V Vert scale setting, +5 Div position setting, -10 V offset	- 18.398 V	_____	_____	- 17.602 V
CH2	5 mV Vert scale setting, -5 Div position setting, +1 V offset	+ 1.0353 V	_____	_____	+ 1.0447 V
CH2	5 mV Vert scale setting, +5 Div position setting, -1 V offset	- 1.0447 V	_____	_____	- 1.0353 V
CH2	200 mV Vert scale setting, -5 Div position setting, +10 V offset	+ 11.4989 V	_____	_____	+ 11.7011 V
CH2	200 mV Vert scale setting, +5 Div position setting, -10 V offset	- 11.7011 V	_____	_____	- 11.4989 V
CH2	1.01 V Vert scale setting, -5 Div position setting, +10 V offset	+ 17.602 V	_____	_____	+ 18.398 V
CH2	1.01 V Vert scale setting, +5 Div position setting, -10 V offset	- 18.398 V	_____	_____	- 17.602 V
CH3	5 mV Vert scale setting, -5 Div position setting, +1 V offset	+ 1.0353 V	_____	_____	+ 1.0447 V
CH3	5 mV Vert scale setting, +5 Div position setting, -1 V offset	- 1.0447 V	_____	_____	- 1.0353 V
CH3	200 mV Vert scale setting, -5 Div position setting, +10 V offset	+ 11.4989 V	_____	_____	+ 11.7011 V

**TDS 5000B Series Test Record (cont.)**

Instrument Serial Number: \_\_\_\_\_ Certificate Number: \_\_\_\_\_  
 Temperature: \_\_\_\_\_ RH %: \_\_\_\_\_  
 Date of Calibration: \_\_\_\_\_ Technician: \_\_\_\_\_

<b>TDS5000B Series performance test</b>		<b>Minimum</b>	<b>Incoming</b>	<b>Outgoing</b>	<b>Maximum</b>
CH3	200 mV Vert scale setting, +5 Div position setting, -10 V offset	- 11.7011 V	_____	_____	- 11.4989 V
CH3	1.01 V Vert scale setting, -5 Div position setting, +10 V offset	+ 17.602 V	_____	_____	+ 18.398 V
CH3	1.01 V Vert scale setting, +5 Div position setting, -10 V offset	- 18.398 V	_____	_____	- 17.602 V
CH4	5 mV Vert scale setting, -5 Div position setting, +1 V offset	+ 1.0353 V	_____	_____	+ 1.0447 V
CH4	5 mV Vert scale setting, +5 Div position setting, -1 V offset	- 1.0447 V	_____	_____	- 1.0353 V
CH4	200 mV Vert scale setting, -5 Div position setting, +10 V offset	+ 11.4989 V	_____	_____	+ 11.7011 V
CH4	200 mV Vert scale setting, +5 Div position setting, -10 V offset	- 11.7011 V	_____	_____	- 11.4989 V
CH4	1.01 V Vert scale setting, -5 Div position setting, +10 V offset	+ 17.602 V	_____	_____	+ 18.398 V
CH4	1.01 V Vert scale setting, +5 Div position setting, -10 V offset	- 18.398 V	_____	_____	- 17.602 V

**Analog bandwidth**

CH1	100 mV	424 mV	_____	_____	N/A
CH2	100 mV	424 mV	_____	_____	N/A
CH3	100 mV	424 mV	_____	_____	N/A
CH4	100 mV	424 mV	_____	_____	N/A
Delay between channels		N/A	_____	_____	100 ps

**TDS 5000B Series Test Record (cont.)**

Instrument Serial Number: \_\_\_\_\_ Certificate Number: \_\_\_\_\_  
 Temperature: \_\_\_\_\_ RH %: \_\_\_\_\_  
 Date of Calibration: \_\_\_\_\_ Technician: \_\_\_\_\_

<b>TDS5000B Series performance test</b>	<b>Minimum</b>	<b>Incoming</b>	<b>Outgoing</b>	<b>Maximum</b>
Channel isolation: <b>100 MHz</b>				
Input to CH 1	N/A	_____	_____	8.00 divisions
CH 2	N/A	_____	_____	0.08 divisions
CH 3	N/A	_____	_____	0.08 divisions
CH 4	N/A	_____	_____	0.08 divisions
Channel isolation: <b>100 MHz</b>				
CH 1	N/A	_____	_____	0.08 divisions
Input to CH 2	N/A	_____	_____	8.00 divisions
CH 3	N/A	_____	_____	0.08 divisions
CH 4	N/A	_____	_____	0.08 divisions
Channel isolation: <b>100 MHz</b>				
CH 1	N/A	_____	_____	0.08 divisions
CH 2	N/A	_____	_____	0.08 divisions
Input to CH 3	N/A	_____	_____	8.00 divisions
CH 4	N/A	_____	_____	0.08 divisions
Channel isolation: <b>100 MHz</b>				
CH 1	N/A	_____	_____	0.08 divisions
CH 2	N/A	_____	_____	0.08 divisions
CH 3	N/A	_____	_____	0.08 divisions
Input to CH 4	N/A	_____	_____	8.00 divisions
Channel isolation: <b>Full Bandwidth</b>				
Input to CH 1	N/A	_____	_____	8.00 divisions
CH 2	N/A	_____	_____	0.16 divisions
CH 3	N/A	_____	_____	0.16 divisions
CH 4	N/A	_____	_____	0.16 divisions
Channel isolation: <b>Full Bandwidth</b>				
CH 1	N/A	_____	_____	0.16 divisions
Input to CH 2	N/A	_____	_____	8.00 divisions
CH 3	N/A	_____	_____	0.16 divisions
CH 4	N/A	_____	_____	0.16 divisions
Channel isolation: <b>Full Bandwidth</b>				
CH 1	N/A	_____	_____	0.16 divisions
CH 2	N/A	_____	_____	0.16 divisions
Input to CH 3	N/A	_____	_____	8.00 divisions
CH 4	N/A	_____	_____	0.16 divisions
Channel isolation: <b>Full Bandwidth</b>				
CH 1	N/A	_____	_____	0.16 divisions
CH 2	N/A	_____	_____	0.16 divisions
CH 3	N/A	_____	_____	0.16 divisions
Input to CH 4	N/A	_____	_____	8.00 divisions

**TDS 5000B Series Test Record (cont.)**

Instrument Serial Number: \_\_\_\_\_ Certificate Number: \_\_\_\_\_  
 Temperature: \_\_\_\_\_ RH %: \_\_\_\_\_  
 Date of Calibration: \_\_\_\_\_ Technician: \_\_\_\_\_

<b>TDS5000B Series performance test</b>	<b>Minimum</b>	<b>Incoming</b>	<b>Outgoing</b>	<b>Maximum</b>
<b>Time base system</b>				
Long-term sample rate and delay time accuracy @ 10.0 ms	-15 ppm	_____	_____	+15 ppm
Delta time measurement	N/A	_____	_____	Pass/Fail
<b>Trigger system accuracy</b>				
Time accuracy for pulse, glitch, timeout, and Width, Hor. scale $\leq 1 \mu\text{s}$				
Lower Limit	3.5 ns	_____	_____	6.5 ns
Upper Limit	3.5 ns	_____	_____	6.5 ns
Time accuracy for pulse, glitch, timeout, and width, Hor. scale $> 1 \mu\text{s}$				
Lower Limit	1.9 $\mu\text{s}$	_____	_____	2.1 $\mu\text{s}$
Upper Limit	1.9 $\mu\text{s}$	_____	_____	2.1 $\mu\text{s}$
CH1 trigger sensitivity, 50 MHz	Pass/Fail	_____	_____	Pass/Fail
CH1 delayed trigger sensitivity, 50 MHz	Pass/Fail	_____	_____	Pass/Fail
CH1 AUX trigger input, 50 MHz	Pass/Fail	_____	_____	Pass/Fail
CH1 trigger sensitivity, full bandwidth	Pass/Fail	_____	_____	Pass/Fail
CH1 delayed trigger sensitivity, full bandwidth	Pass/Fail	_____	_____	Pass/Fail
CH1 AUX trigger input, 100 MHz	Pass/Fail	_____	_____	Pass/Fail
<b>Output signal checks</b>				
Auxiliary trigger output, open circuit				
High	High $\geq 2.5 \text{ V}$	_____	_____	Low $\leq 0.7 \text{ V}$
Low		_____	_____	
Auxiliary trigger output, 50 $\Omega$				
High	High $\geq 1.0 \text{ V}$	_____	_____	Low $\leq 0.25 \text{ V}$
Low		_____	_____	
Analog signal output, 1 M $\Omega$	p-p $\geq 200 \text{ mV}$	_____	_____	p-p $\leq 300 \text{ mV}$
Analog signal output, 50 $\Omega$	p-p $\geq 100 \text{ mV}$	_____	_____	p-p $\leq 150 \text{ mV}$
<b>Probe compensation output signal</b>				
Frequency	950 Hz	_____	_____	1.050 kHz
Voltage (difference)	990 mV	_____	_____	1010 mV

## Signal Acquisition System Checks

The following procedures verify those characteristics that relate to the signal-acquisition system and are listed as checked under *Warranted Characteristics* in the *Specifications* section. Refer to Table 2-1 on page 2-18 for test equipment specifications.

**NOTE.** *References to CH 3 and CH 4 apply to the TDS5034B, TDS5054B, TDS5054BE, and TDS5104B models only.*

### Check DC Voltage Measurement Accuracy



**WARNING.** *The generator is capable of outputting dangerous voltages. Be sure to set the DC calibration generator to off or 0 volts before connecting, disconnecting, and/or moving the test hookup during the performance of this procedure. Also, verify that the calibrator does not have shorting straps installed between the DC and sense outputs or grounds.*

<b>Equipment required</b>	Two dual-banana connectors (Item 5) One BNC T connector (Item 6) One DC calibration generator (Item 10) Two precision 50 Ω coaxial cables (Item 4)
<b>Prerequisites</b>	The oscilloscope must meet the prerequisites listed on page 2-17.

1. *Install the test hookup and preset the instrument controls:*
  - a. *Hook up the test-signal source:*
    - Set the output of a DC calibration generator to off or 0 volts.
    - Connect the output of a DC calibration generator through a dual-banana connector followed by a 50 Ω precision coaxial cable to one side of a BNC T connector. See Figure 2-8.
    - Connect the Sense output of the generator through a second dual-banana connector followed by a 50 Ω precision coaxial cable to the other side of the BNC T connector. Now connect the BNC T connector to CH 1. See Figure 2-8.



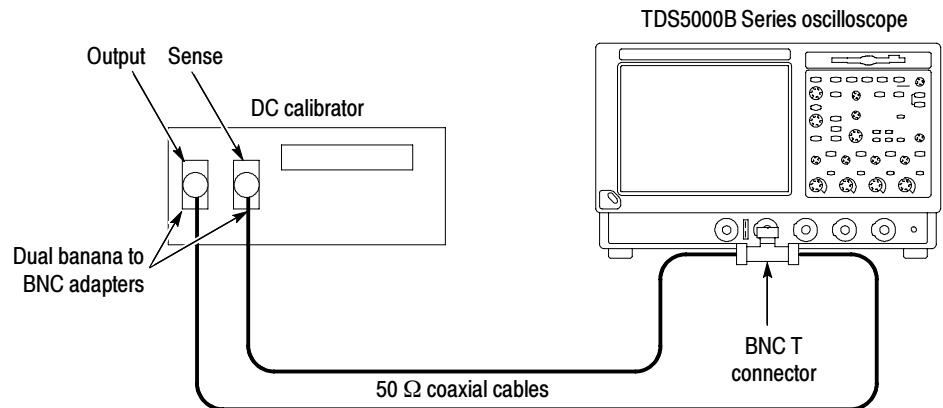

**Figure 2-8: Initial test hookup**

- b. *Initialize the oscilloscope:* Press **DEFAULT SETUP**.
- c. *Modify the default settings:*
  - From the toolbar bar, click **Horiz** and select the **Acquisition** tab.
  - Click **Average** and set the number of averages to **16**.
2. *Confirm input channels are within limits for DC accuracy at maximum offset and position:* Perform the following substeps — test CH 1 first, *skipping substep 2a, since CH 1 is already selected from step 1.*
  - a. *Select an unchecked channel:*
    - From the toolbar bar, click **MEAS** and then **Clear** to remove the previous measurement.
    - Press the **Vertical** button of the channel just confirmed to remove the channel from the display.
    - Press the front-panel **Vertical** button that corresponds to the channel that you are to confirm.
    - *Set the generator output to 0 V.*
    - Move the test hookup to the channel that you selected.
  - b. *Turn on the measurement Mean for the channel:*
    - From the toolbar bar, click **MEAS** and select the **Ampl** tab, and then click **Mean** to measure the mean of the current channel.
    - Press **Close**.

- c. *Set the vertical scale:* Set the vertical SCALE to one of the settings listed in Table 2-2 that is not yet checked. (Start with the first setting listed.)

**Table 2-2: DC Voltage measurement accuracy**

Scale setting	Position setting (Divs)	Offset setting	Generator setting	Accuracy limits
5 mV	-5	+1 V	+1.040 V	+1.0353 V to +1.0447 V
	+5	-1 V	-1.040 V	-1.0447 V to -1.0353 V
200 mV	-5	+10 V	+11.6 V	+11.4989 V to +11.7011 V
	+5	-10 V	-11.6 V	-11.7011 V to -11.4989 V
1.01 V	-5	+10 V	+18 V	+17.602 V to +18.398 V
	+5	-10 V	-18 V	-18.398 V to -17.602 V

- d. *Display the test signal:*
- From the toolbar bar click **VERT**, and then click **Position**.
  - Use the keypad to set vertical position to -5 divisions (press **CLR**, **5**, **-**, and then **ENTER**, on the keypad). The baseline level will move off screen.
  - Click **Offset**.
  - Use the keypad to set vertical offset to the positive-polarity setting listed in the table for the current vertical scale setting. The baseline level will remain off screen.
  - Set the generator to the level and polarity indicated in the table for the vertical scale, position, and offset settings that you have made. The DC test level should appear on the screen. (If it doesn't return, the DC accuracy check has failed for the current vertical scale setting of the current channel.)
- e. *Measure the test signal:* Press **Close**. Read the measurement results at the Mean measurement readout. See Figure 2-9.

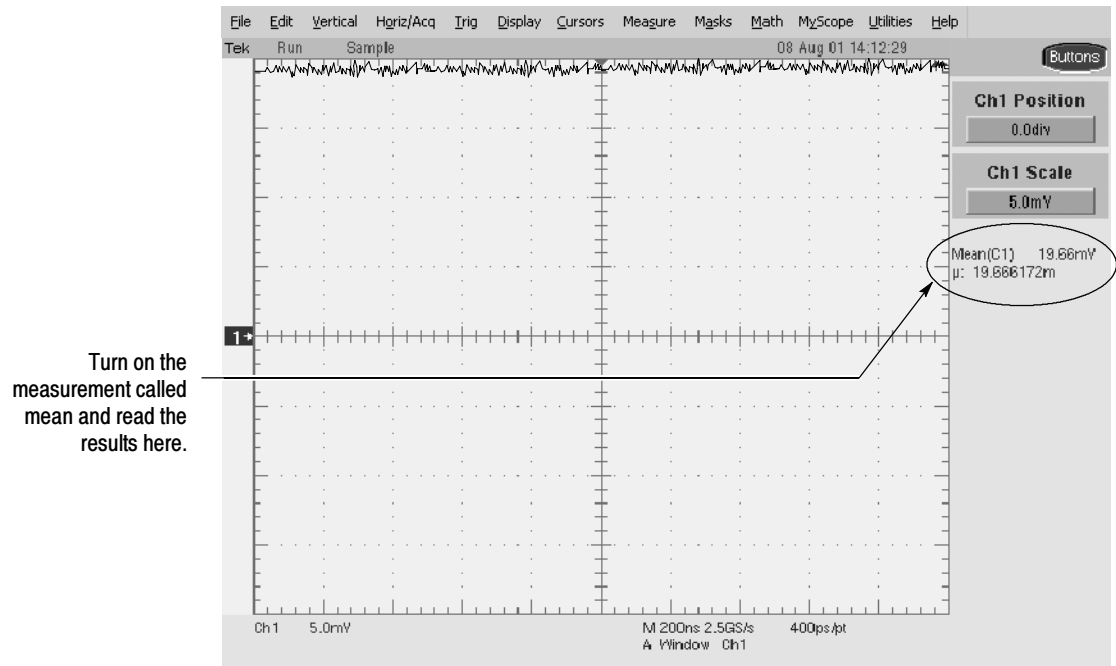

**Figure 2-9: Measurement of DC accuracy at maximum offset and position**

**f. Check against limits:**

- CHECK that the Mean readout on the screen is within the limits listed for the current vertical scale and position/offset/generator settings. Enter the value in the test record.
- Repeat substep **d**, reversing the polarity of the position, offset, and generator settings as is listed in the Table 2-2 on page 2-26.
- CHECK that the Mean measurement readout on the screen is within the limits listed for the current vertical scale setting and position/offset/generator settings. Enter the value in the test record.
- Repeat substeps **c** through **f** until all vertical scale settings, listed in Table 2-2, are checked for the channel under test.

**g. Test all channels:** Repeat substeps **a** through **f** for all channels.

**3. Disconnect the hookup:**

- a.** Set the generator output to **0 V**.
- b.** Disconnect the cable from the generator output at the input connector of the channel last tested.

**Check Analog Bandwidth**

<b>Equipment required</b>	One sine wave generator (Item 13) One level meter and power sensor (Item 14) One power divider (Item 15) One female N to male BNC adapter (Item 21) Four male N to female BNC adapters (Item 20) Two 50 $\Omega$ precision cables (Item 4) Attenuators (Items 1 and 2) Optional: One high-frequency leveled sine wave generator and its leveling head - replaces items 13, 14, 15, 20, and 21
<b>Prerequisites</b>	Read <i>Prerequisites</i> on page 2-17 and footnote warnings on page 2-19.

1. *Install the test hookup and preset the instrument controls:*
  - a. *Initialize the oscilloscope:*
    - Press **DEFAULT SETUP**.
  - b. *Modify the default settings:*
    - Turn the horizontal **SCALE** knob to **40 ns** (**50 ns** for TDS5054BE).
    - From the toolbar bar, click **Horiz** and select the **Acquisition** tab.
    - Click **Average** and set the number of averages to **16**.
    - Click **ET** (Equivalent Time).
    - From the toolbars, click **MEAS**. Click Setup **Ref Levs**; then click the Determine Base, Top From **Min-Max** button.

---

**NOTE.** *The sine wave generator output amplitude must be leveled to within 0.35 db of the reference frequency (10 MHz) through the bandwidth frequency listed in Table 2-3 on page 2-30. The 0.35 db requirement is necessary to ensure a bandwidth that meets Tektronix specifications.*

*You can perform bandwidth Performance Verification using an unleveled sine wave generator (with amplitude error >0.35 db). Under these conditions, the bandwidth PV is subject to the flatness errors associated with the generator used.*

*Refer to the Sine Wave Generator Leveling Procedure on page 2-62 if your sine wave generator does not have automatic output amplitude leveling.*

---

- c. *Hook up the test-signal source:* Connect the sine wave output of a leveled sine wave generator to CH 1. Set the output of the generator to a reference frequency of 10 MHz or less. See Figure 2-10.

For the optional setup using a leveled sine wave generator with a leveling head, see Figure 2-11 and, if using this optional setup with the example Tektronix SG504, set the generator output to 6 MHz.

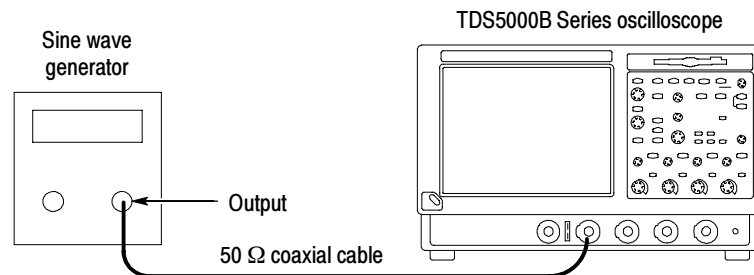

**Figure 2-10: Initial test hookup**

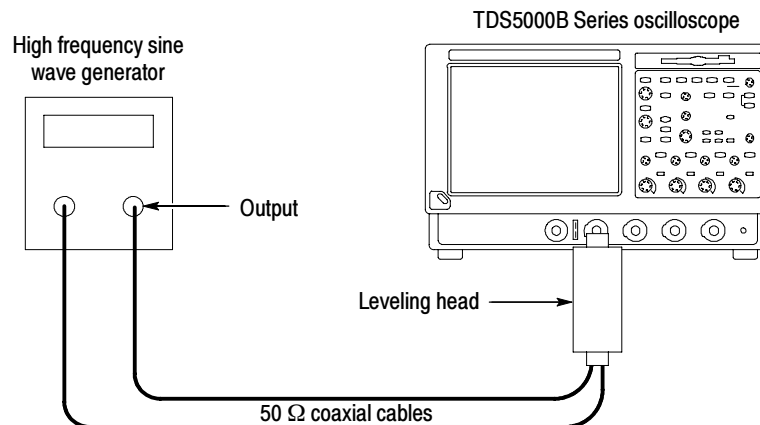

**Figure 2-11: Optional initial test hookup**

2. *Confirm the input channels are within limits for analog bandwidth:* Do the following substeps — test CH 1 first, *skipping substeps a and b since CH 1 is already set up for testing from step 1.*
  - a. *Select an unchecked channel:*
    - From the toolbar bar, click **MEAS** and then **Clear** to remove the previous measurement.
    - Press the **Vertical** button of the channel just confirmed to remove the channel from the display.

- Press the front-panel **Vertical** button that corresponds to the channel that you are to confirm.
  - Move the leveling output of the sine wave generator to the channel that you selected.
- b. *Match the trigger source to the channel selected:*
- Press the Trigger **SOURCE** button until the source that corresponds to the channel that you are to confirm is on.
- c. *Set its input impedance:*
- From the toolbar, click the **VERT** button and select the tab for the channel that you are to confirm. Click the Termination **50 Ω** button.
- d. *Set the vertical scale:* Set the vertical **SCALE** that corresponds to the channel that you are to confirm to one of the settings listed in Table 2-3 not yet checked. (Start with the 100 mV setting.)
- e. *Set the triggering coupling:*
- Click the Coupling **DC** button.

**Table 2-3: Analog bandwidth**

Vertical scale	Reference amplitude (6 division)	Horizontal scale	Test frequency			-3 db Limits
			TDS5032B TDS5034B	TDS5052B TDS5054B TDS5054BE	TDS5104B	
1 mV	6 mV	1 ns	150 MHz	175 MHz	175 MHz	≥4.24 mV
2 mV	12 mV	1 ns	250 MHz	300 MHz	1 GHz	≥8.48 mV
5 mV	30 mV	1 ns	350 MHz	500 MHz	1 GHz	≥21.2 mV
10 mV	60 mV	1 ns	350 MHz	500 MHz	1 GHz	≥42.4 mV
20 mV	120 mV	1 ns	350 MHz	500 MHz	1 GHz	≥84.8 mV
50 mV	300 mV	1 ns	350 MHz	500 MHz	1 GHz	≥212 mV
100 mV	600 mV	1 ns	350 MHz	500 MHz	1 GHz	≥424 mV
200 mV	1.2 V	1 ns	350 MHz	500 MHz	1 GHz	≥848 mV
500 mV	3 V <sup>1</sup>	1 ns	350 MHz	500 MHz	1 GHz	≥2.12 V <sup>1</sup>
1 V	6 V <sup>1</sup>	1 ns	350 MHz	500 MHz	1 GHz	≥4.24 V <sup>1</sup>

<sup>1</sup> If your generator cannot output 6 divisions of amplitude, determine its maximum output at the Test frequency, and use this for the reference amplitude. The -3 db limit can be calculated as:  $0.707 \times$  reference amplitude.

- 
- f. *Display the test signal:* Do the following subparts to first display the reference signal and then the test signal.
- From the toolbar click **MEAS**; then select the **Time** tab.
  - Click the **Freq** button to measure the frequency of the current channel.
  - Select the **Ampl** tab. Click the **Pk-Pk** button.
  - Click **Close** button.
  - Set the generator output so the CH<x> Pk-Pk readout equals the reference amplitude in Table 2-3 that corresponds to the vertical scale set in substep d.
  - Press the front-panel **PUSH TO SET 50%** as necessary to trigger a stable display. At full bandwidth, you may also want to make small, manual adjustments to the trigger level. You can use the Trigger LEVEL knob to do this. (Full bandwidth varies with TDS model as is shown in Table 2-3.)
- g. *Measure the test signal:*
- Set the frequency of the generator, as shown on the screen, to the test frequency in Table 2-3 that corresponds to the vertical scale set in substep d. See Figure 2-12.
  - Set the horizontal **SCALE** to the horizontal scale setting in Table 2-3 that corresponds to the vertical scale set in substep d. Press **PUSH TO SET 50%** as necessary to trigger the signal.
  - Read the results at the CH<x> Pk-Pk readout, which will automatically measure the amplitude of the test signal. See Figure 2-12.

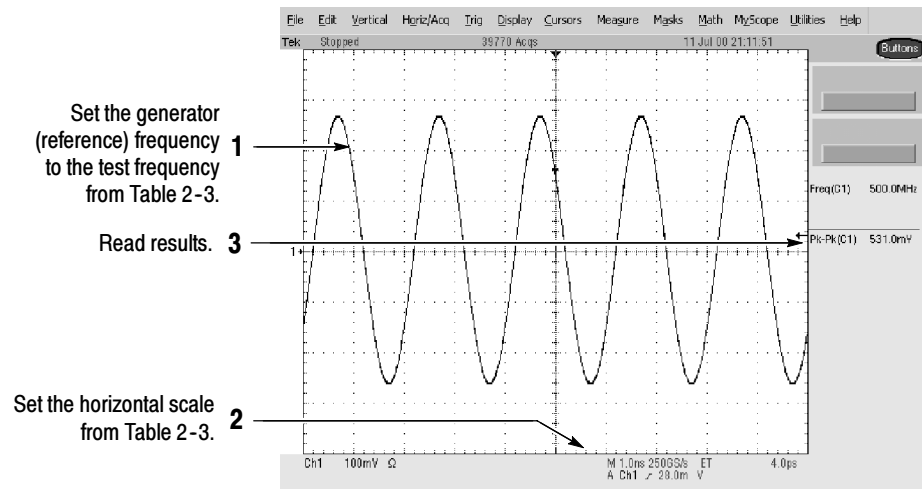

**Figure 2- 12: Measurement of analog bandwidth**

**h. Check against limits:**

- CHECK that the Pk-Pk readout on the screen is within the limits listed in Table 2-3 for the current vertical scale setting.
- Enter the voltage in the test record.
- When finished checking, set the horizontal **SCALE** back to the **40 ns (50 ns for TDS5054BE)** setting.

---

**STOP.** Checking the bandwidth of each channel at all vertical scale settings is time consuming and unnecessary. You can skip checking the remaining vertical scale settings in Table 2-3 (that is, skip the following substep, i) if this oscilloscope has performed as follows:

---

- Passed the 100 mV vertical scale setting just checked in this procedure.
- Passed the *Verify Internal Adjustment, Self Compensation, and Diagnostics* procedure found under *Self Tests* on page 2-5.

---

**NOTE.** Passing the *Signal Path Compensation* confirms the signal path for all vertical scale settings for all channels. Passing the *Internal Diagnostics* ensures that the factory-set adjustment constants that control the bandwidth for each vertical scale setting have not changed.

---



- i. *Check remaining vertical scale settings against limits (optional):*
    - If desired, finish checking the remaining vertical scale settings for the channel under test by repeating substeps d through h for each of the remaining scale settings listed in Table 2-3 for the channel under test.
    - Before doing substep f, click the **Clear** button to remove the previous channel measurements.
    - When doing substep f, skip the subparts that turn on the CH<x> Pk-Pk measurement until you check a new channel.
    - Install/remove attenuators between the generator leveling head and the channel input as needed to obtain the six division reference signals listed in the table.
  - j. *Test all channels:* Repeat substeps a through h for all channels.
3. *Disconnect the hookup:* Disconnect the test hook up from the input connector of the channel last tested.

### Check Delay Between Channels

<b>Equipment required</b>	One sine wave generator (Item 13) Three precision 50 $\Omega$ coaxial cables (Item 4) One power divider (Item 15) or dual input coupler (item 7) 3 SMA female to female adapter connector (Item 16) 3 SMA male-to-female BNC adapter connector (Item 17)
<b>Prerequisites</b>	Read <i>Prerequisites</i> on page 2-17 and footnote warnings on page 2-19.

**STOP.** Do not use the vertical position knob to reposition any channel while doing this check. To do so invalidates the test.

1. *Install the test hookup and preset the instrument controls:*
  - a. *Initialize the front panel:* Press the **DEFAULT SETUP** button.
  - b. *Modify the initialized front-panel control settings:*
    - Do not adjust the vertical position of any channel during this procedure.
    - From the toolbar, click the **Vert** button.
    - Set the termination of each channel to 50  $\Omega$  by selecting each channel tab and clicking the **Termination 50  $\Omega$**  button.

- Set the horizontal **SCALE** to **400 ps (500 ps for TDS5054BE)**.
  - From the toolbar bar, click **Horiz**, and select the **Acquisition** tab.
  - Click **Average**, and set the number of averages to **16**.
- c. *Hook up the test-signal source:*
- Connect the sine wave output of a sine wave generator to a 50  $\Omega$  precision coaxial cable.
  - Connect the cable to either a coupler or power divider and two 50  $\Omega$  precision coaxial cables, as shown in Figure 2-13. (See note below.)

---

**NOTE.** To ensure that you do not introduce errors into the delay measurements, use cables that have a delay difference of less than 10 ps between each other.

You can check the variance in delay between cables by connecting the cables to **CH 1** and **CH 2**. and, using the **V bar** cursors, measure the delay. Reverse the cables and repeat the measurement. Divide the difference between the two delay measurements by 2. If the result is less than 10 ps, you can proceed with the test.

---

- Connect the coupler or cables to CH 1 and CH 2. See Figure 2-13.

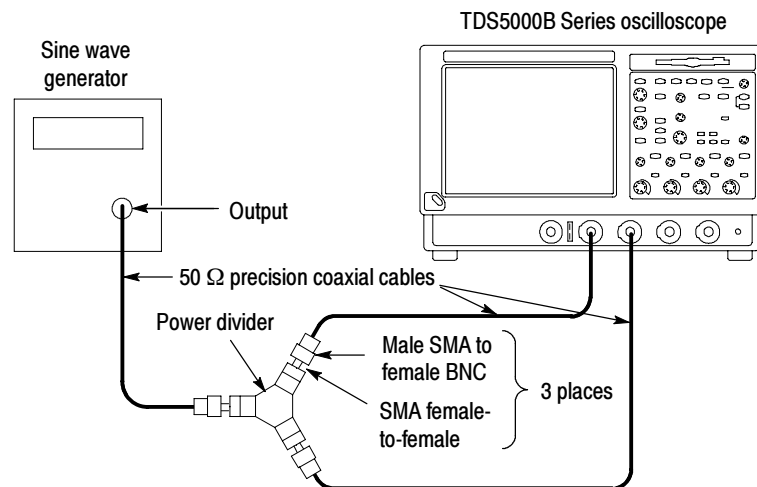

**Figure 2- 13: Initial test hookup**

2. *Confirm all four channels are within limits for channel delay:*
  - a. *Set up the generator:* Set the generator frequency to 250 MHz and the amplitude at six to eight divisions for CH 1.

Hint: As you adjust the generator amplitude, push **PUSH TO SET 50%** often to speed up the updating of the waveform amplitude on screen.

- b. Set the horizontal **SCALE** to **200 ps**.
- c. *Save a CH 2 waveform:*
  - Press the **CH 2 Vertical** button.
  - From the toolbar, click **Save** to open the Save As dialog box.
  - In the Save What field, click **Waveform**. The Save as Type is **Tektronix Waveform Data (\*.wfm)**.
  - In the Source drop-down list box, select **CH 2**.
  - In the Save in: Oscilloscope Memory field, select **Ref 2**; then click the **Save** button.
- d. *Save CH 3 waveform:*
  - Press the **CH 2 Vertical** button to turn CH 2 off; then press the **CH 3 Vertical** button to turn CH 3 on.
  - Move the coupler or cable from CH 2 to CH 3, so that CH 1 and CH 3 are driven.
  - From the toolbar, click **Save** to open the Save As dialog box.
  - In the Save What field, click **Waveform**. The Save as Type is **Tektronix Waveform Data (\*.wfm)**.
  - In the Source drop-down list box, select **CH 3**.
  - In the Save in: Oscilloscope Memory field, select **Ref 3**; then click the **Save** button.
- e. *Display all test signals:*
  - Press the **CH 3 Vertical** button to remove CH 3 from the display.
  - To display the live waveform, move the coupler or cable from CH 3 to CH 4, so CH 1 and CH 4 are driven. Press the Vertical **CH 4** button to activate the display. See Figure 2-14 on page 2-36.
  - To display reference waveforms, select **Ref 3** from the Source drop-down list box; then click the Ref 3 Display **Off** button to toggle it to On and display the reference.

Hint: To control reference waveforms, use the Reference Waveform Controls menu on the right side of the screen.

- Select **Ref 2** from the Source drop-down list box; then click the Display **Off** button to toggle it to On. You may notice their overlapping waveform handle icons. See Figure 2-14 on page 2-36.
  - Click the **Close** button.
- f. *Measure the test signal:*
- Locate the time reference points for these waveforms by first identifying the point where the rising edge of the left-most waveform crosses the center horizontal graticule line, then note the corresponding *time reference point* for the right-most waveform. See Figure 2-14.
  - Press **CURSORS** and select the **V Bars** Cursors Type; then click the **Close** button.
  - Align one V bar cursor to the *time reference point* of the left-most waveform edge and the other cursor to the *time reference point* of the right-most waveform edge by rotating the multipurpose knobs (if necessary, press the FINE buttons). See Figure 2-14.
  - Read the measurement results at the  $\Delta$ : cursor readout on the screen.

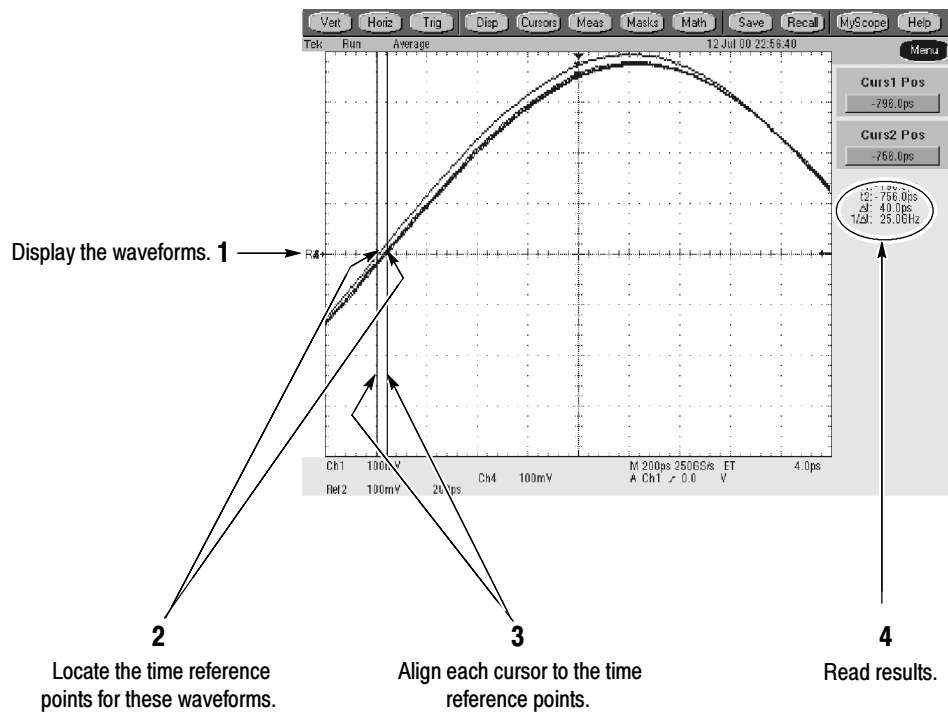
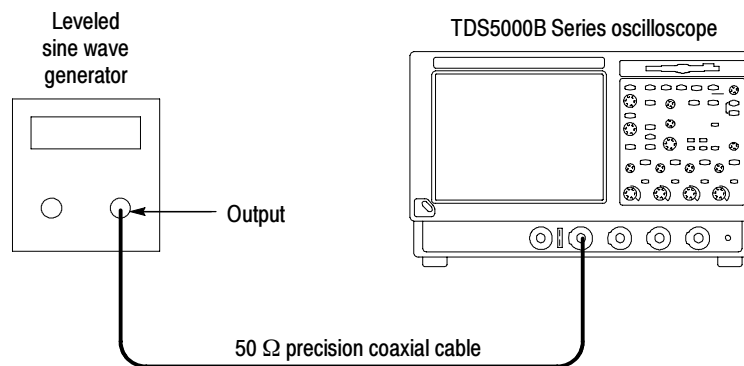

Figure 2- 14: Measurement of channel delay

- g. *Check against limits:* CHECK that the cursor readout is  $\leq 100$  ps.
  - h. Enter the time in the test record.
3. *Disconnect the hookup:* Disconnect the coupler or cables from the input connectors of the channels.

### Check Channel Isolation (Crosstalk)

<b>Equipment required</b>	One leveled sine-wave generator (Item 13) One 50 $\Omega$ , precision coaxial cable (Item 4)
<b>Prerequisites</b>	Read <i>Prerequisites</i> on page 2-17 and footnote warnings on page 2-19.



**Figure 2- 15: Initial test hookup**

1. *Install the test hookup and preset the instrument controls:*
  - a. *Hook up the test-signal source:* Connect, through a 50  $\Omega$  precision coaxial cable, the output of the generator to **CH 1**. See Figure 2-15.
  - b. *Initialize the oscilloscope:* Press the **DEFAULT SETUP** button.
  - c. *Modify the initialized control settings:*
    - Turn on all vertical channels (press the Vertical button of any off channels: CH 1, CH 2, and, if equipped, CH 3, and CH 4).
    - From the toolbar, click the **Vert** button. Set the termination of each channel to 50  $\Omega$  by selecting each channel tab and clicking its Termination **50  $\Omega$**  button.
    - Set the Vertical SCALE of CH 1, CH 2, CH 3, and CH 4 to **100 mV**.
    - Set the Trigger SOURCE to **CH 1**.
    - Set the Horizontal SCALE to **20 ns** (**25 ns** for TDS5054BE).

- From the toolbar, click the **Horiz** button. In the Horizontal menu, open the Acquisition tab and set the instrument to E.T. mode.
- Click the **Close** button.

2. *Check channel isolation against limits:*

- a. *Display the test signal:* Set the generator frequency to 100 MHz and adjust the output level for an 8-division display.
- b. Check — Amplitude of each trace other than CH 1 is 0.08 division or less (discount trace width). Enter the amplitude in the test record.
- c. Move the signal to the CH 2 input connector, and then change the Trigger SOURCE to **CH 2**.
- d. Check — Amplitude of each trace other than CH 2 is 0.08 division or less (discount trace width). Enter the amplitude in the test record.
- e. Move the signal to the CH 3 input connector, and then change the Trigger SOURCE to **CH 3** (TDS5034B, TDS5054B, TDS5054BE, or TDS5104B). If you are checking a TDS5032B or TDS5052B, proceed to step i below.
- f. Check — Amplitude of each trace other than CH 3 is 0.08 division or less (discount trace width). Enter the amplitude in the test record.
- g. Move the signal to the CH 4 input connector, and then change the Trigger SOURCE to **CH 4**. (TDS5034B, TDS5054B, TDS5054BE, or TDS5104B)
- h. Check — Amplitude of each trace other than CH 4 is 0.08 division or less (discount trace width). Enter the amplitude in the test record.
- i. Move the signal to the CH 1 input connector, and then change the Trigger SOURCE to **CH 1**.
- j. Set the generator output frequency to 350 MHz for the TDS5032B and TDS5034B, 500 MHz for the for the TDS5052B, TDS5054B, and TDS5054BE, or 1 GHz for the TDS5104B. Adjust the generator output level for an 8-division display.
- k. Check — Amplitude of each trace other than CH 1 is 0.16 division or less (discount trace width). Enter the amplitude in the test record.
- l. Move the signal to the CH 2 input connector, and then change the Trigger SOURCE to **CH 2**.
- m. Check — Amplitude of each trace other than CH 2 is 0.16 division or less (discount trace width). Enter the amplitude in the test record.

- n. Move the signal to the CH 3 input connector, and then change the Trigger SOURCE to **CH 3** (TDS5034B, TDS5054B, TDS5034BE, or TDS5104B).
  - o. Check — Amplitude of each trace other than CH 3 is 0.16 division or less (discount trace width). Enter the amplitude in the test record.
  - p. Move the signal to the CH 4 input connector, and then change the Trigger SOURCE to **CH 4** (TDS5034B, TDS5054B, TDS5054BE, or TDS5104B).
  - q. Check — Amplitude of each trace other than CH 4 is 0.16 division or less (discount trace width). Enter the amplitude in the test record.
3. *Disconnect the hookup:* Disconnect the cable from the generator output at the input connector of the channel.

## Time Base System Checks

The following procedures verify those characteristics that relate to the time base system and are listed as checked under *Warranted Characteristics* in the *Specifications* section.

### Check Long-Term Sample Rate and Delay Time Accuracy

<b>Equipment required</b>	One time-mark generator (Item 12), or Sine wave generator (Item 13)  One 50 $\Omega$ , precision coaxial cable (Item 4)
<b>Prerequisites</b>	Read <i>Prerequisites</i> on page 2-17 and footnote warnings on page 2-19.

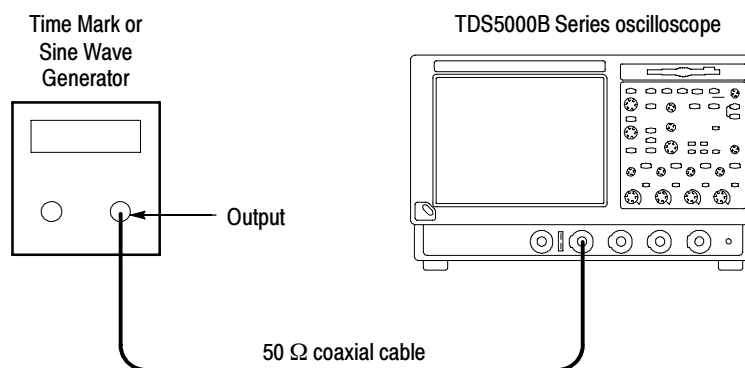

**Figure 2- 16: Initial test hookup**

1. *Install the test hookup and preset the instrument controls:*
  - a. *Hook up the test-signal source:* Connect, through a 50  $\Omega$  precision coaxial cable, the output of the generator to **CH 1**. See Figure 2-16.
    - If using a time-mark generator, set the output for 10 ms markers.
    - If using a sine wave generator, set the output for 1.2 V and 500 kHz.
  - b. *Initialize the oscilloscope:* Press the **DEFAULT SETUP** button.
  - c. *Modify the initialized front-panel control settings:*
    - Set the Vertical **SCALE** to **200 mV** (or 500 mV with the optional Tektronix TG501A Time Mark Generator).
    - Set the Horizontal **SCALE** to **80 ns** (**100 ns** for TDS5054BE).
    - From the toolbar, click the **Vert** button; then click the Termination **50  $\Omega$**  button.
    - Press **PUSH TO SET 50%**.
    - Click the **Close** button.
    - Use the Vertical **POSITION** knob to center the test signal on the screen.
    - Press the Trigger **MODE** button to toggle it to **NORMAL**.



2. Confirm that the time base is within limits for accuracies:

a. Measure the test signal:

- If using a time-mark generator, align the trigger T to the center vertical graticule line by adjusting the Horizontal POSITION. See Figure 2-17.

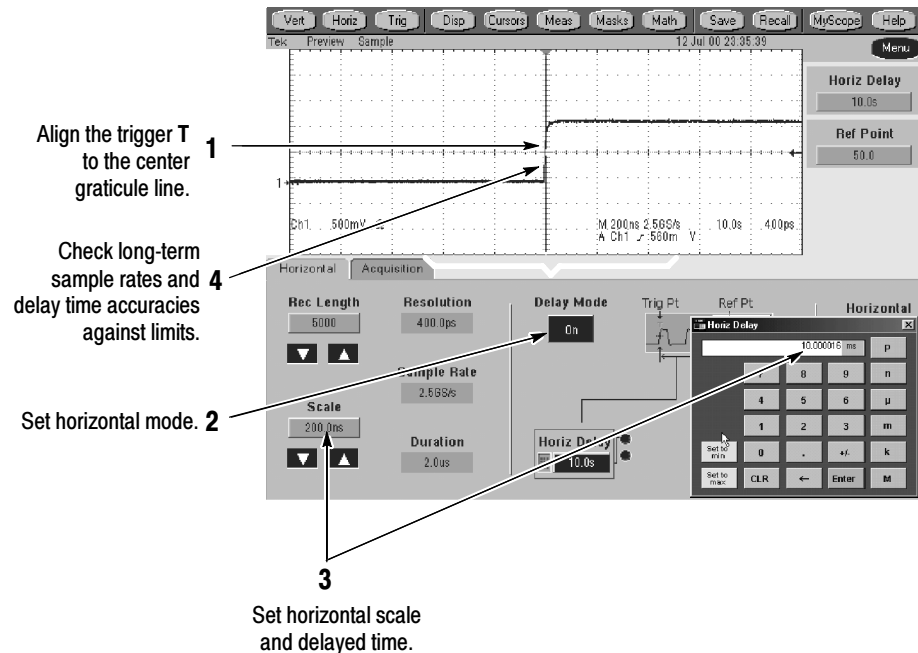

Figure 2-17: Measurement of accuracy - long-term and delay time

- If using a sine wave generator, align the rising edge of the sine wave on the center graticule crosshairs by adjusting the Horizontal POSITION.
- From the toolbar, click the **Horiz** button, and select the **HORIZONTAL** tab.
- Press the Horizontal **DELAY Mode** button to toggle it on. See Figure 2-17 on page 2-41.
- Set the delay time to 10 ms. (Do this by clicking **Horiz Delay** and on the keypad press **10**, then **m** followed by **ENTER**.)

- b. *Check the long-term sample rate and delay time accuracies against limits:*
  - Note the number of major divisions that the rising edge of the marker (or sine wave) is offset from the center vertical graticule line, when it crosses the center horizontal graticule line.
  - Multiply the number of divisions by 8 (by 10 for TDS5054BE) to find the accuracy in ppm.
  - CHECK that the accuracy is within  $\pm 15$  ppm.
  - Enter the accuracy in ppm in the test record.
- 3. *Disconnect the hookup:* Disconnect the cable from the generator output at the input connector of CH 1.

**Check Delta Time Measurement Accuracy**

<b>Equipment required</b>	One 50 $\Omega$ , precision coaxial cable (Item 4) One Connector, BNC "T", male BNC-to-dual female BNC (Item 6) One Pulse Generator, Wavetek 9500 or equivalent (Item 18) Two 50 $\Omega$ , coaxial cable, male-to-male SMA connectors (Item 19) One SMA female to BNC male connector (Item 23) One BNC elbow connector (Item 24) One SMA "T", male to two SMA female connectors (Item 22) Two SMA termination connectors, short circuit (Item 26) One 2X attenuator, 50 $\Omega$ , female BNC-to- male BNC (Item 28)
<b>Prerequisites</b>	Read <i>Prerequisites</i> on page 2-17 and footnote warnings on page 2-19.

This procedure checks the sample rate portion of the Delta Time Measurement Accuracy as listed in the *Specifications* section. The previous procedure, *Check Long-Term Sample Rate and Delay Time Accuracy*, on page 2-39, verified the "PPM" portion of the delta time specification.

- 1. *Install the test hookup and preset the instrument controls:*
  - a. *Initialize the oscilloscope:* Press the **DEFAULT SETUP** button.
  - b. *Hook up the pulse generator as shown in Figure 2-18.*

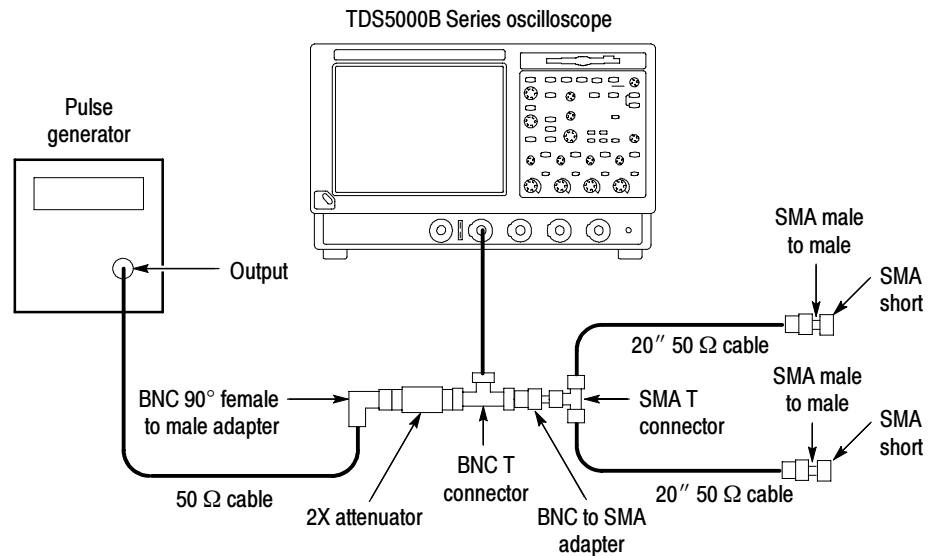

**Figure 2-18: Delta time accuracy test hookup**

- Set the pulse generator output for a positive-going pulse with a 280 ps - 800 ps rise-time, as shown in Table 2-4 on page 2-45, and for the fastest possible rep rate (at least 1 kHz).
  - Set the pulse generator output for about 500 mV. (This amplitude can be adjusted later to get a 5-division pulse on the screen.)
- c. *Modify the initialized front-panel control settings:*
- From the toolbar, click the **Vert** button. Set the termination of the channel to 50 Ω by selecting the channel tab and clicking the Termination **50 Ω** button.
  - Press **AUTOSET**. You may see both positive and negative pulses. Adjust the Trigger LEVEL knob so that the trigger level is about 50% of the rising edge of the positive pulse.
  - If you are testing a TDS5054BE instrument, set the Bandwidth to 150 MHz on all channels. (All other models are tested at full bandwidth.)
  - From the toolbar, click the **Horiz** button, and select the Acquisition tab. Under Sampling Mode, press the **RT** (Real Time Only) button.
  - Set the horizontal SCALE to **10 ns/division**. The pulse width should be approximately 6 ns. For the TDS5054BE, set the horizontal scale to **50 ns/division**, and press the ZOOM button.

- Adjust the pulse amplitude and the vertical scale and position of the instrument as necessary to obtain about 5 divisions of positive pulse amplitude. Ensure that the positive pulse amplitude is greater than 200 mV.
- d. *Set up for statistics measurements:*
- Readjust the Trigger LEVEL knob so that the trigger level is about 50% of the rising edge of the positive pulse. Note the voltage of the trigger level—this voltage will be used in the following steps.
  - Press **RUN/STOP** button to freeze the display.
  - Click **MEAS**, and then select the **Time** tab to bring up the Time Measurements menu.
  - Click the **Positive Width** button.
  - Click Setup **Statistics**. Click the Measurement Statistics **All** button, and then click **Reset** to reset the statistics.
  - Click **Weight n=**. On the keypad press **1000** and **ENTER**; then click **Setup**.
  - Click Setup **Ref Levs**.
  - Click Units **Absolute**.
  - Set **Mid Ref** to the voltage of the trigger level noted previously in this step. (This level is about 50% of the rising edge of the positive pulse.)
  - Click **Setup**, and then click **Close**.
  - Press the **RUN/STOP** button to start the acquisitions.
  - Wait approximately 30 seconds.
  - Press the **RUN/STOP** button to freeze the display.
  - Record all statistics values.
  - Calculate the difference of the Maximum (M) minus the mean ( $\mu$ ).
  - Calculate the difference of the mean ( $\mu$ ) minus the Minimum (m).
  - Both differences must be less than or equal to the Delta-time accuracy limit shown in Table 2-4 for your oscilloscope.
  - Enter the pass/fail result for delta time in the test record.

**Table 2-4: Delta time measurement**

<b>Instrument Model</b>	<b>Pulse rise time range</b>	<b>Delta time accuracy limit</b>
TDS5104B, TDS5054B, TDS5034B, TDS5052B, TDS5032B	280 ps - 800 ps	≤ 0.060 ns
TDS5054BE	1.4 ns - 4 ns (The internal 150 MHz bandwidth filter will slow pulse rising edges to this range.)	≤ 0.300 ns

- e. *Repeat for all other channels:*
- Note the vertical scale setting of the channel just confirmed.
  - Press the Vertical channel button for the channel just confirmed to remove the channel from display.
  - Click **MEAS**, and then **Clear** to remove the measurement.
  - Press the front-panel button that corresponds to the channel that you are to confirm.
  - Set vertical **SCALE** to the setting noted in step e, first bullet.
  - Press the Trigger Source button to toggle the source to the channel selected.
  - Move the test hookup to the channel that you selected.
  - From the toolbar, click the **Vert** button. Set the termination of the channel to 50 Ω by selecting the channel tab and clicking the Termination **50 Ω** button. (If you are testing a TDS5054BE model, make sure the 150 MHz bandwidth limit has been turned on. All other models are tested at full bandwidth.)
  - Press the **RUN/STOP** button to start the display.
  - Repeat step d.

2. *Disconnect all test equipment from the oscilloscope.*

## Trigger System Checks

The following procedures check those characteristics that relate to the trigger system and are listed as checked in the *Specifications* section.

### Check Time Accuracy for Pulse, Glitch, Timeout, and Width Triggering

<b>Equipment required</b>	One sine wave generator (Item 13) One 10X attenuator (Item 1) One 50 $\Omega$ , precision coaxial cable (Item 4)
<b>Prerequisites</b>	Read <i>Prerequisites</i> on page 2-17 and footnote warnings on page 2-19.

1. *Install the test hookup and preset the instrument controls:*

- a. *Initialize the instrument:* Press the **DEFAULT SETUP** button.
- b. *Modify the default setup:*
  - Set the horizontal **SCALE** to **10 ns**.
  - From the toolbar, click the **Vert** button; then click the Termination **50  $\Omega$**  button.
- c. *Hook up the test-signal source:* Connect the output of the sine wave generator (Item 13) to CH 1 as shown in Figure 2-18.

Use a 50  $\Omega$  precision coaxial cable, followed by a 10X attenuator. The 10X attenuator is optional if the SG503 is used.

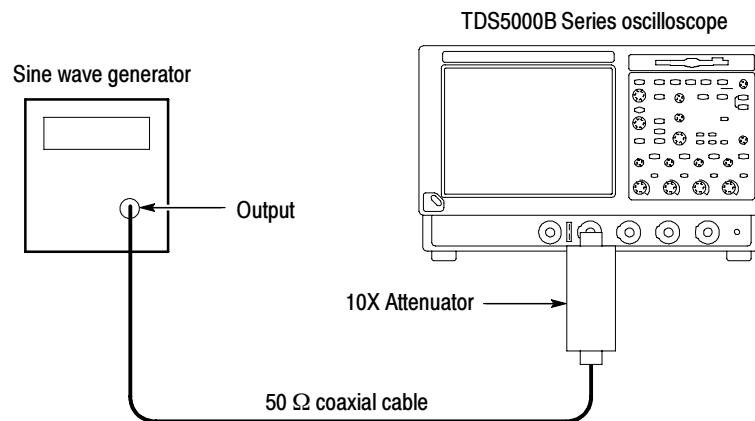
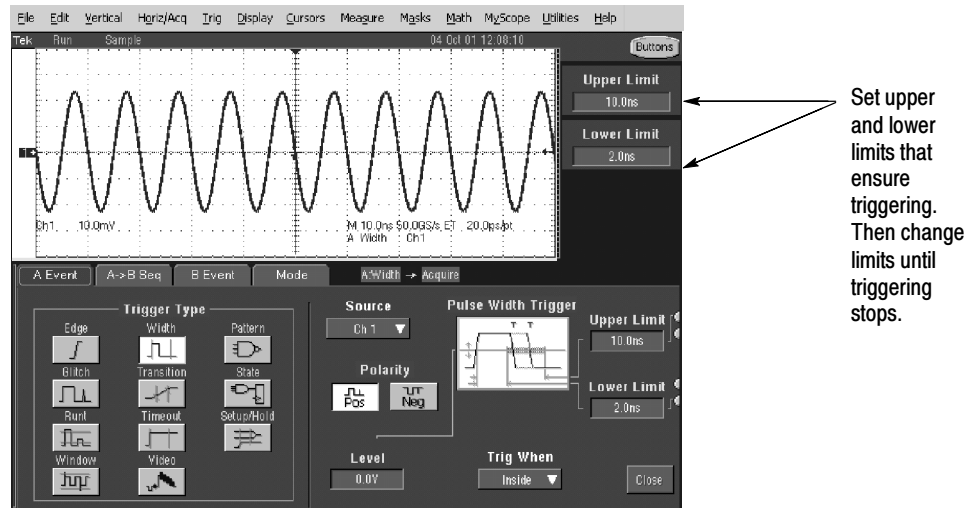

**Figure 2- 18: Initial test hookup**

2. *Confirm that the trigger system is within the time-accuracy limits for pulse-glitch or pulse-width triggering (time range  $\leq 500$  ns):*

- a. *Display the test signal:* Set the output of the sine wave generator for a 100 MHz, five-division sine wave on the screen; then press **PUSH TO SET 50%**.

- 
- b. *Set the trigger mode:* Press the Trigger **MODE** button to toggle it to **NORMAL**.
- c. *Set upper and lower limits that ensure triggering:* See Figure 2-19 on page 2-48.
- Press the front-panel **ADVANCED** button, and select the **A Event** tab; then select width triggering by clicking the **Width** button.
  - Click the **Trig When** button, and select **Inside** limits.
  - Click **Upper Limit**, and use the keyboard to set the upper limit to 10 ns: press **10**, then **n**, and **ENTER**.
  - Click **Lower Limit**, and use the keypad to set the lower limit to 2 ns.
- d. *Change limits until triggering stops:*
- Press **PUSH TO SET 50%**.
  - While implementing the following substeps, monitor the display (it will stop acquiring) and the front-panel light TRIG'D (it will extinguish) to determine when triggering is lost. Click **Close**.
  - Click **Lower Limit**.
  - Use the multipurpose knob to *increase* the Lower Limit readout until triggering is lost.
  - CHECK that the Lower Limit readout, after the oscilloscope loses triggering, is within 3.5 ns to 6.5 ns, inclusive.
  - Enter the time in the test record.
  - Use the keypad to return the **Lower Limit** to **2 ns** and reestablish triggering.
  - Click **Upper Limit**; then use the multipurpose knob to slowly *decrease* the **Upper Limit** readout until triggering is lost.
  - CHECK that the Upper Limit readout, after the oscilloscope loses triggering, is within 3.5 ns to 6.5 ns, inclusive.
  - Enter the time in the test record.



**Figure 2- 19: Measurement of time accuracy for pulse and glitch triggering**

3. *Confirm that the trigger system is within the time-accuracy limits for pulse-glitch or pulse-width triggering (time range >520 ns):*
  - a. *Set the upper and lower limits that ensure triggering at 250 kHz:*
    - Click **Upper Limit**. Use the keyboard to set the upper limit to 4  $\mu$ s.
    - Click **Lower Limit**. Use the keypad to set the lower limit to 500 ns.
  - b. *Display the test signal:*
    - Set the Horizontal **SCALE** to 4  $\mu$ s (5  $\mu$ s for TDS5054BE).
    - Set the output of the sine wave generator for a 250 kHz, five-division sine wave on the screen. Set the Vertical **SCALE** to 20 mV (the waveform will overdrive the display).
    - Press **PUSH TO SET LEVEL 50%**.
  - c. *Check against limits:* Do the following subparts in the order listed.
    - Use the multipurpose knob to *increase* the Lower Limit readout until triggering is lost.
    - CHECK that the Lower Limit readout, after the oscilloscope stops triggering, is within 1.9  $\mu$ s to 2.1  $\mu$ s, inclusive.
    - Enter the time in the test record.
    - Use the keypad to return the **Lower Limit** to **500 ns** and re-establish triggering.



- Click **Upper Limit**; then use the multipurpose knob to slowly *decrease* the Upper Limit readout until triggering stops.
  - CHECK that the Upper Limit readout, after the oscilloscope loses triggering, is within 1.9  $\mu$ s to 2.1  $\mu$ s, inclusive.
  - Enter the time in the test record.
4. *Disconnect the hookup*: Disconnect the cable from the generator output at the input connector of CH 1.

### Check Sensitivity, Edge Trigger, DC Coupled

<b>Equipment required</b>	One sine wave generator (Item 13) One precision 50 $\Omega$ coaxial cable (Item 4) One 50 $\Omega$ termination (Item 4) One 10X attenuator (Item 1) One 5X attenuator (Item 2)
<b>Prerequisites</b>	Read <i>Prerequisites</i> on page 2-17 and footnote warnings on page 2-19.

1. *Install the test hookup and preset the instrument controls*:
  - a. *Initialize the oscilloscope*: Press the **DEFAULT SETUP** button.
  - b. *Modify the initialized front-panel control settings*:
    - Set the Horizontal **SCALE** to **20 ns** (25 ns for TDS5054BE).
    - Press the Trigger **MODE** button to toggle it to **Normal**.
    - From the toolbar, click **Horiz**, and select the **Acquisition** tab.
    - Click **Average**, and set the number of averages to **16**.
  - c. *Hook up the test-signal source*:
    - Connect one end of a precision 50  $\Omega$  coaxial cable to the signal output of the generator. Connect the other end of the coaxial cable to **CH 1** through a 50  $\Omega$  termination. See Figure 2-20.

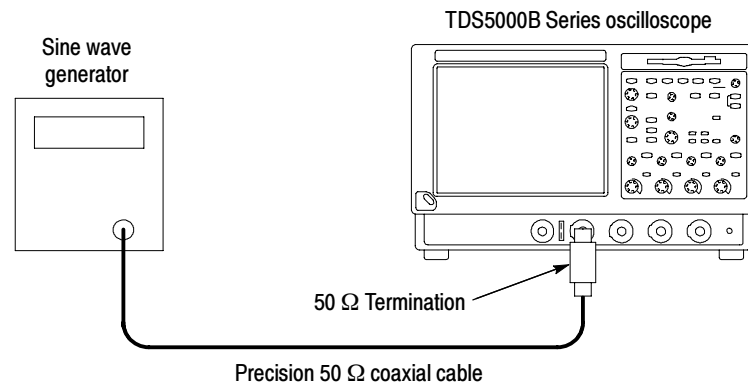

**Figure 2-20: Initial test hookup**

2. *Confirm the trigger system is within sensitivity limits (50 MHz):*

a. *Display the test signal:*

- Set the generator frequency to **50 MHz**.
- From the toolbar, click **MEAS**.
- Click Setup **Ref Levs**; then click the **Min-Max** button.
- Click the **Setup** button and select the **Ampl** tab; then click the **Amplitude** button.
- Click **Close**.
- Press **PUSH TO SET 50%**.
- Set the test signal amplitude for about three and a half divisions on the screen. Fine-adjust the generator output until the CH 1 Amplitude readout indicates that the amplitude is 350 mV. The readout may fluctuate around 350 mV.
- Disconnect the 50 Ω termination (with the 50 Ω precision coaxial cable attached) from CH 1, and reconnect it to CH 1 through a 10X attenuator.

b. *Check the Main trigger system for stable triggering at limits:*

- Read the following definition: A stable trigger is one that is consistent, that is, one that results in a uniform, regular display triggered on the selected slope (positive or negative). This display should not have its trigger point alternating between opposite slopes, nor should it roll across the screen. At horizontal scale settings of 2 ms/division and faster, TRIG'D will remain constantly lit. It will flash for slower settings.

- Press the Trigger **Slope** button to select the positive slope.
- Adjust the Trigger **LEVEL** knob to produce a stable trigger. **CHECK** that the trigger is stable for the test waveform on the positive slope.
- Press the Trigger **Slope** button to select the negative slope. Adjust the Trigger **LEVEL** knob so that there is a stable trigger. **CHECK** that the trigger is stable for the test waveform on the negative slope.
- Enter the pass/fail result for trigger in the test record.
- Leave the trigger system triggered on the positive slope of the waveform before continuing to the next step.

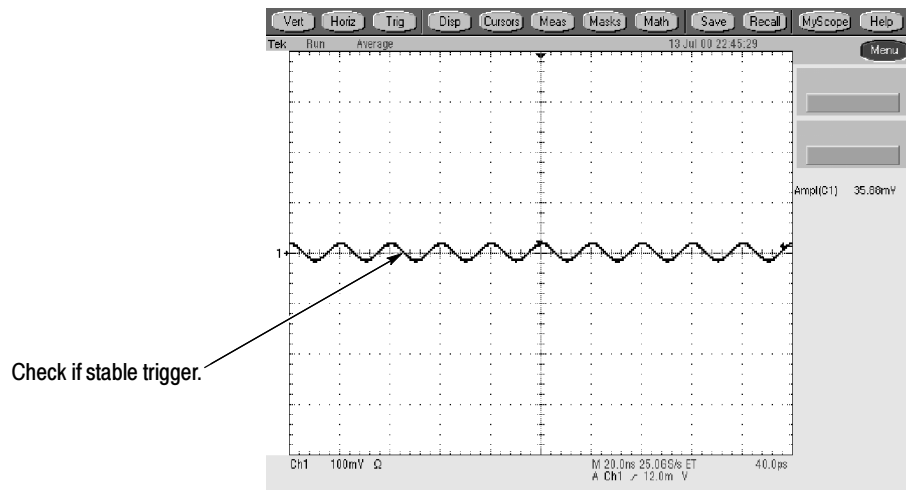

**Figure 2-21: Measurement of trigger sensitivity showing 50 MHz results**

- c. *Check Delayed trigger system for stable triggering at limits:* Do the following subparts in the order listed.
- From the toolbar click **Trig**, select the **A Event** tab, and set the **Source** to Line.
  - Select the **A->B Seq** tab, and then click the **A then B Trig After Time** button.
  - Select the **B Event** tab, and then click the **Set 50%** button.

**CHECK** that a stable trigger is obtained for the test waveform for both the positive and negative slopes of the waveform. Use the **TRIGGER LEVEL** knob to stabilize the Main trigger. Click **B Trig Level**, and use the keypad or the multipurpose knob/FINE button to

stabilize the Delayed trigger. Click one of the Slope buttons to switch between trigger slopes. See Figure 2-21 on page 2-51.

- Enter the pass/fail result for delayed trigger in the test record.
- Leave the Delayed trigger system triggered on the positive slope of the waveform before continuing to the next step. Also, return to the main trigger: select the **A->B Seq** tab and click the A->B Sequence **A Only** button.
- Select the **A Event** tab; then press **Close**.

3. *Confirm the AUX Trigger input:*

a. *Display the test signal:*

- Remove the 10X attenuator; then reconnect the 50  $\Omega$  termination and precision 50  $\Omega$  cable to CH 1.
- Press the Trigger **SOURCE** button to select **CH 1**.
- Set the test signal amplitude for approximately 4 divisions on the screen.
- Fine-adjust the generator output until the CH 1 Amplitude readout indicates that the amplitude is 400 mV.

b. *Check the AUX trigger source for stable triggering at 50 MHz: Do the following in the order listed.*

- Move the 50  $\Omega$  termination and precision 50  $\Omega$  cable from CH 1 to AUX IN.
- Press the Trigger **SOURCE** button to set the source to **EXT**.
- Adjust the Trigger **LEVEL** knob in the positive direction.
- CHECK for a stable trigger. When a stable trigger is obtained, the TRIG'D indicator is lighted.

---

**NOTE.** *You will not see the signal on the display.*

---

- Press the Trigger **SLOPE** button to toggle it to **NEG**.
- Adjust the Trigger **LEVEL** knob in the negative direction.
- CHECK for a stable trigger. When a stable trigger is obtained, the TRIG'D indicator is lighted.
- Enter the pass/fail results in the test record.

- Set the trigger system to trigger on the positive slope of the waveform before proceeding to the next check.
  - Press the Trigger **SOURCE** button to set the trigger source to **CH 1**.
  - Click **Vert** in the toolbar. Click Termination **50 Ω**. Click **Close**.
  - Disconnect the hookup installed in step 1.
4. *Confirm that the trigger system is within sensitivity limits (full bandwidth):*
- a. *Hook up the test-signal source:* Connect the signal output of a high-frequency sine wave generator to CH 1 through a precision 50 Ω coaxial cable. To test some TDS models, a high frequency (>1 GHz) generator is required; see footnote 1 in Table 2-1 on page 2-19.
  - b. *Set the Horizontal Scale:* Set the Horizontal **SCALE** to **400 ps (500 ps for TDS5054BE)**.
  - c. *Display the test signal:*
    - Set the generator frequency to full bandwidth as follows:

TDS5032B, TDS5034B	<b>350 MHz</b>
TDS5052B, TDS5054B, TDS5054BE	<b>500 MHz</b>
TDS5104B	<b>1 GHz</b>

Note: For the TDS5054BE, set the instrument to E.T. mode.
    - Set the test signal amplitude for approximately five divisions on-screen; then fine-adjust the generator output until the CH 1 Amplitude readout indicates the amplitude is 500 mV. The readout may fluctuate around 500 mV.
    - Disconnect the leveling head at CH 1 and reconnect it to **CH 1** through a 5X attenuator. Check that a stable trigger is obtained.
  - d. Repeat step 2, substeps b and c only, for the full bandwidth selected.
    - Press the Trigger **SOURCE** button to toggle it to **CH 1**.
  - e. *Display the test signal:*
    - Set the generator frequency to 100 MHz.
    - Set the Horizontal **SCALE** to **10 ns**.
    - Remove the 5X attenuator and reconnect the cable to CH 1.
    - Set the generator amplitude on the screen for 7.5 divisions.
    - Fine-adjust the generator output until the **CH 1 Amplitude** readout indicates the amplitude is 750 mV.



## Output Signal Checks

The following procedures verify characteristics of the output signals that are listed as checked under *Warranted Characteristics* in the *Specifications* section. The oscilloscope outputs these signals at its front and rear panels.

**Check Outputs:  
CH 3 Signal Out  
(TDS5034B, TDS5054B,  
TDS5054BE TDS5104B)  
and Aux Trigger Out**

<b>Equipment required</b>	Two precision 50 $\Omega$ coaxial cables (Item 4) One calibration generator (Item 11)
<b>Prerequisites</b>	Read <i>Prerequisites</i> on page 2-17 and footnote warnings on page 2-19. Also, the oscilloscope must have passed <i>Check DC Voltage Measurement Accuracy</i> on page 2-24.

### 1. Install the test hookup and preset the instrument controls:

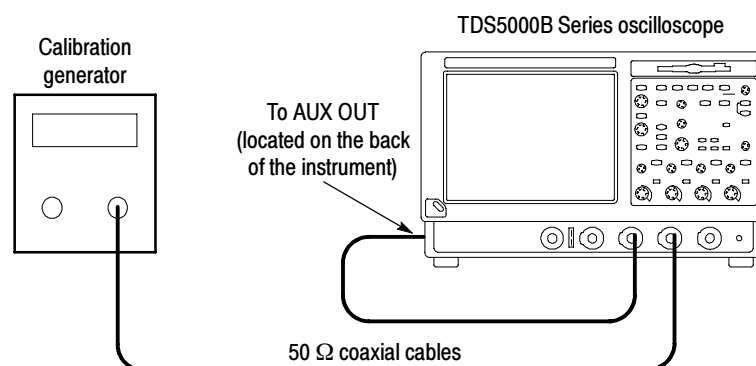
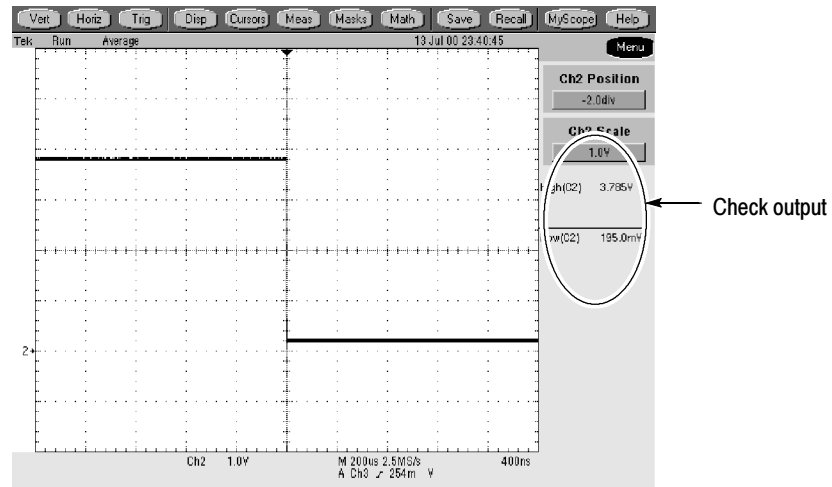

**Figure 2-22: Initial test hookup**

- a. *Hook up test-signal source 1:*
  - Connect the standard amplitude output of a calibration generator through a 50  $\Omega$  precision coaxial cable to CH 3. See Figure 2-22.
  - Set the calibration generator to output a 0.500 V square wave.
- b. *Hook up test-signal source 2:* Connect the **Aux Out** at the rear panel to CH 2 through a 50  $\Omega$  precision cable.
- c. *Initialize the oscilloscope:* Press the **DEFAULT SETUP** button.
- d. *Modify the initialized front-panel control settings:*
  - Press the Vertical **CH 1** button to toggle it off.
  - Press the Vertical **CH 3** button to display that channel.

- Push Trigger **Source** to toggle the source to **CH 3**.
  - Set the Horizontal **SCALE** to **200  $\mu$ s**.
  - If necessary, adjust the calibration generator output for an amplitude of 5 divisions. For oscilloscopes with 50  $\Omega$  inputs, you may need to double the output of the generator.
  - From the toolbar bar, click **Horiz**, and select the **Acquisition** tab.
  - Click **Average**, and set the number of averages to **64**.
  - Click the **Close** button.
2. *Confirm AUX OUT is within limits for logic levels:*
- a. *Display the test signal:*
    - Press the Vertical **CH 3** button to turn off CH 3.
    - Press the Vertical **CH 2** button to display that channel.
    - Set the CH 2 Vertical **SCALE** to **1 V**.
    - Use the Vertical **POSITION** knob to center the display on-screen.
  - b. *Measure logic levels:*
    - From the toolbar, click **MEAS**, and select the **Ampl** tab.
    - Click the **High** and **Low** buttons.
    - Click the **Close** button.
  - c. *Check AUX OUT output against limits:*
    - CHECK that the CH 2 High readout is  $\geq 2.5$  volts and that the CH 2 Low readout is  $\leq 0.7$  volts. See Figure 2-23.
    - Enter the high and low voltages in the test record.
    - From the toolbar, click the **Vert** button. Click the Termination **50  $\Omega$**  button.
    - Click the **Close** button.
    - CHECK that the CH 2 High readout is  $\geq 1.0$  volt and that the CH 2 Low readout  $\leq 0.25$  volts.
    - Enter the high and low voltages in the test record.





**Figure 2-23: Measurement of main trigger out limits**

**3. Confirm SIGNAL OUT is within limits for gain:**

**a. Measure gain:**

- Move the precision 50  $\Omega$  cable from the AUX OUT BNC to the SIGNAL OUT BNC.
- Set CH 2 Vertical SCALE to **100 mV**.
- Press **PUSH TO SET 50%**.
- From the toolbar, click **MEAS**, and select the **Ampl** tab.
- Click the **Pk-Pk** button.
- Click **Close**.

**b. Check against limits:**

- From the toolbar, click the **Vert** button, then click the Termination **1 M $\Omega$**  button.
- Click **Close**.
- CHECK that the readout CH2 Pk-Pk is between 200 mV and 300 mV, inclusive.
- Enter the voltage in the test record.
- From the toolbar, click the **Vert** button; then click the Termination **50  $\Omega$**  button.
- Click **Close**.

- CHECK that the readout CH 2 Pk-Pk is between 100 mV and 150 mV, inclusive.
  - Enter the voltage in the test record.
4. *Disconnect the hookup:* Disconnect the cables from the channel inputs and the rear panel outputs.

**Check Probe Compensation Output**

<b>Equipment required</b>	One BNC male-to-male cable and a BNC female-to-clip lead adapter used between CH1 and the Probe Comp Output DC Calibrator
<b>Prerequisites</b>	See page 2-17. Also, the oscilloscope must have passed <i>Check Long-Term Sample Rate and Delay Time Accuracy</i> on page 2-39.

1. *Install the test hookup and preset the instrument controls:*
- a. *Hook up test-signal:* Connect the PROBE COMP output to **CH 1** using the BNC male-to-male cable and the BNC female-to-clip lead adapter. See Figure 2-24.

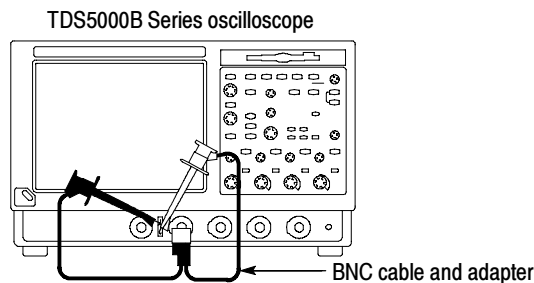
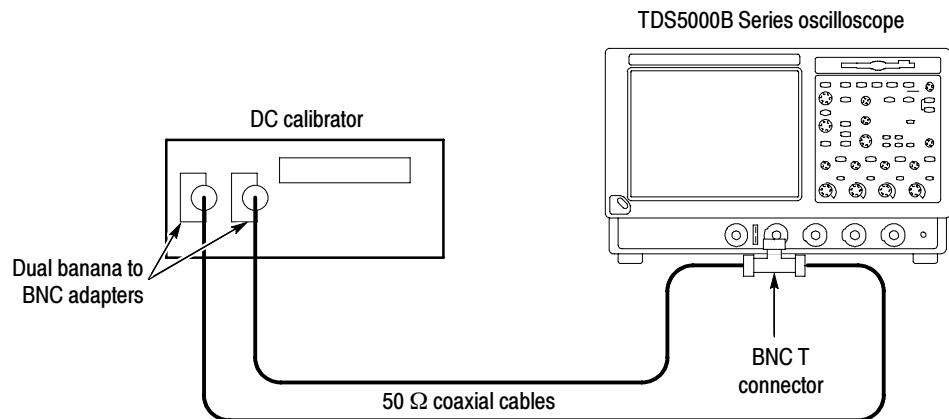

**Figure 2- 24: Initial test hookup**

- b. *Initialize the oscilloscope:* Press the **DEFAULT SETUP** button.
- c. *Modify the initialized front-panel control settings:*
  - Set the Vertical **SCALE** to **200 mV**.
  - Set the Horizontal **SCALE** to **200 μs**.
  - Press **PUSH TO SET 50%**.
  - Use the Vertical **POSITION** knob to center the display on the screen.
  - From the toolbar bar, click **Horiz** and select the **Acquisition** tab.



- To view the stored waveform on screen, verify that the display On button (in the control window) is toggled to **On**.
- d. *Hook up the DC standard source:*
- Set the output of a DC calibration generator to off or **0 volts**.
  - Connect the output of the DC calibration generator, through a dual-banana connector, followed by a 50  $\Omega$  precision coaxial cable, to one side of a BNC T connector. See Figure 2-26.
  - Connect the Sense output of the generator, through a second dual-banana connector, followed by a 50  $\Omega$  precision coaxial cable, to the other side of the BNC T connector. Connect the BNC T connector to CH 1. See Figure 2-26.



**Figure 2-26: Subsequent test hookup**

- e. *Measure amplitude of the probe compensation signal:*
- From the toolbar bar, click **Horiz**, and select the **Acquisition** tab.
  - Click **Average** and set the number of averages to **16** using the keypad or the multipurpose knob.
  - Adjust the output of the DC calibration generator until it precisely overlaps the top (upper) level of the stored probe compensation signal. (This value will be near 1000 mV.)
  - Record the setting of the DC generator.
  - Adjust the output of the DC calibration generator until it precisely overlaps the base (lower) level of the stored probe compensation signal. (This value will be near zero volts.)

- Record the setting of the DC generator.
- f. Press **Close** to remove the menus from the display. See Figure 2-27.

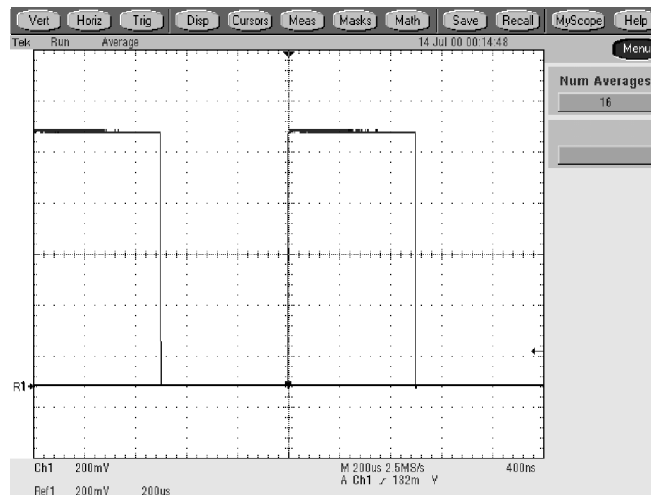

**Figure 2-27: Measurement of probe compensator amplitude**

- g. *Check against limits:*
- Subtract the value just obtained (base level) from that obtained previously (top level).
  - CHECK that the difference obtained is within 990 mV to 1010 mV, inclusive.
  - Enter the voltage difference in test record.
3. *Disconnect the hookup:* Disconnect the cable from CH 1.
- This completes the performance verification of the oscilloscope.

## Sine Wave Generator Leveling Procedure

Some procedures in this manual require a leveled sine wave generator to produce the necessary test signals. If you do not have a leveled sine wave generator, use one of the following procedures to level the output amplitude of your sine wave generator.

**Method A** If you have a power divider, use this setup to monitor the generator output simultaneously with the level meter and the oscilloscope.

<b>Equipment required</b>	Sine wave generator (Item 13) Level meter and power sensor (Item 14) Power divider (Item 15) Two male N to female BNC adapters (Item 20) One precision coaxial cable (Item 4)
<b>Prerequisites</b>	Read <i>Prerequisites</i> on page 2-17 and footnote warnings on page 2-19.

1. *Install the test hookup:* Connect the equipment as shown in Figure 2-28.

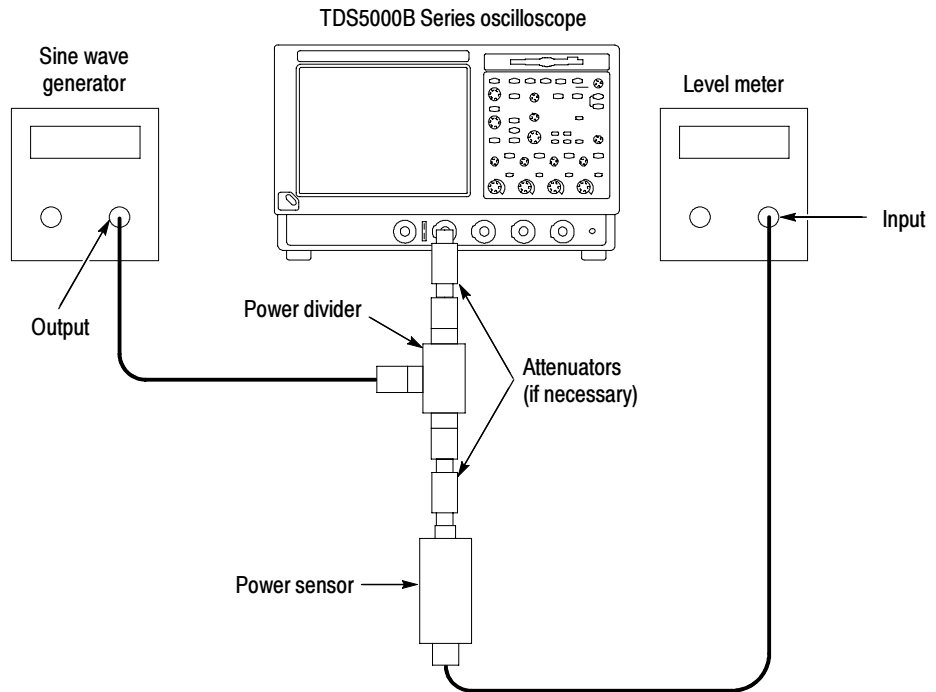

**Figure 2-28: Sine wave generator leveling equipment setup (Method A)**

2. *Set the Generator:*
  - Set the sine wave generator to a reference frequency of **10 MHz**.
  - Adjust the sine wave generator amplitude to the required number of divisions as measured by the oscilloscope.
3. *Record the reference level:* Note the reading on the level meter.
4. *Set the generator to the new frequency and reference level:*
  - Change the sine wave generator to the desired new frequency.
  - Input the correction factor and/or the new frequency into the level meter.
  - Adjust the sine wave generator amplitude until the level meter again reads the value noted in step 3. The signal amplitude is now correctly set for the new frequency for your specific test procedure.

Proceed with the test instructions that require a leveled sine wave generator at the frequency you set in step 4.

**Method B** Use this setup if you do not have a power divider.

<b>Equipment required</b>	Sine wave generator (Item 13) Level meter and power sensor (Item 14) Two male N to female BNC adapters (Item 20) Two precision coaxial cables (Item 4)
<b>Prerequisites</b>	Read <i>Prerequisites</i> on page 2-17 and footnote warnings on page 2-19.

1. *Install the test hookup:* Connect the equipment as shown in Figure 2-29 (start with the sine wave generator connected to the oscilloscope).

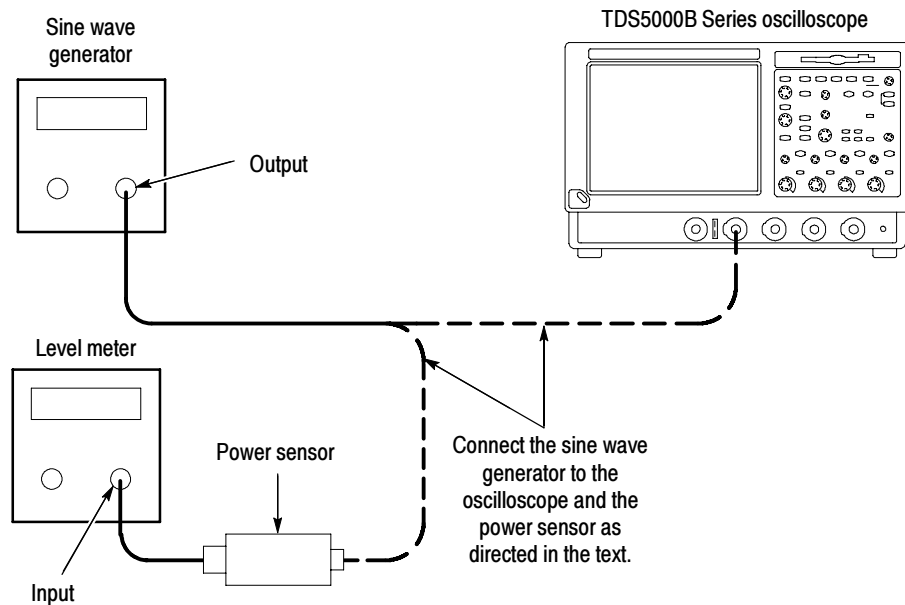

**Figure 2-29: Sine wave generator leveling equipment setup (Method B)**

**2. Set the Generator:**

- Set the sine wave generator to a reference frequency of 10 MHz.
- Adjust the sine wave generator amplitude to the required number of divisions as measured by the oscilloscope.

**3. Record the reference level:**

- Disconnect the sine wave generator from the oscilloscope.
- Connect the sine wave generator to the power sensor.
- Note the level meter reading.

**4. Set the generator to the new frequency and reference level:**

- Change the sine wave generator to the desired new frequency.
- Input the correction factor and/or the new frequency into the level meter.
- Adjust the sine wave generator amplitude until the level meter again reads the value noted in step 3. The signal amplitude is now correctly set for the new frequency for your specific test procedure.
- Disconnect the sine wave generator from the power sensor.



Connect the sine wave generator to the oscilloscope and proceed with the test instructions that require a leveled sine wave generator at the frequency you set in step 4.

