



**TBS1000B/EDU, TBS1000, TDS2000C/TDS1000C-EDU,
TDS2000B/TDS1000B, TDS2000/TDS1000, TDS200 and
TPS2000B/TPS2000 Series Digital Oscilloscopes**

Programmer



077-0444-03



**TBS1000B/EDU, TBS1000, TDS2000C/TDS1000C-EDU,
TDS2000B/TDS1000B, TDS2000/TDS1000, TDS200 and
TPS2000B/TPS2000 Series Digital Oscilloscopes**

Programmer

Revision A 20170113

www.tek.com

077-0444-03

Copyright © Tektronix. All rights reserved. Licensed software products are owned by Tektronix or its subsidiaries or suppliers, and are protected by national copyright laws and international treaty provisions.

Tektronix products are covered by U.S. and foreign patents, issued and pending. Information in this publication supersedes that in all previously published material. Specifications and price change privileges reserved.

TEKTRONIX and TEK are registered trademarks of Tektronix, Inc.

OpenChoice® is a registered trademark of Tektronix Inc.

Tektronix is an authorized licensee of the CompactFlash® trademark.

PictBridge is a trademark of the Standard of Camera & Imaging Products Association CIPA DC-001-2003 Digital Photo Solutions for Imaging Devices.

Contacting Tektronix

Tektronix, Inc.
14150 SW Karl Braun Drive
P.O. Box 500
Beaverton, OR 97077
USA

For product information, sales, service, and technical support:

- In North America, call 1-800-833-9200.
- Worldwide, visit www.tek.com to find contacts in your area.

Table of Contents

Preface	iii
Related Documents	iv
Conventions	vii

Getting Started

Getting Started	1-1
-----------------------	-----

Syntax and Commands

Command Syntax	2-1
Command Syntax	2-1
Command and Query Structure	2-2
Command Entry	2-4
Constructed Mnemonics	2-6
Argument Types	2-7
Command Groups	2-11
Acquisition Commands	2-11
Calibration and Diagnostic Commands	2-11
Counter Commands (TBS1000B/EDU models only)	2-12
Cursor Commands	2-12
Data Logging Commands (Available Only On TBS1000B, TBS1000 and TDS2000C Series Models)	2-13
Display Commands	2-13
FFT Commands (TBS1000B/EDU models only)	2-15
File System Commands (TBS1000B/EDU, TBS1000, TDS2000C, TDS1000C-EDU, TDS2000B, TDS1000B, TDS2MEM Module, TPS2000B, and TPS2000 Only)	2-15
Hard Copy Commands	2-17
Horizontal Commands	2-17
Limit Test Commands (Available Only On TBS1000B, TBS1000 and TDS2000C Series Models)	2-18
Math Commands	2-20
Measurement Commands	2-22
Miscellaneous Commands	2-23
PictBridge Commands (TBS1000B/EDU, TBS1000, TDS2000C, TDS1000C-EDU, TDS2000B, and TDS1000B Only)	2-24
Power and Battery-Related Commands (TPS2000B and TPS2000 Only)	2-25
Power Measurement (TPS2000B/TPS2000 with TPS2PWR1 Power Analysis Application Key Installed Only)	2-25
RS-232 Commands (TDS2000, TDS1000, TDS200, TPS2000B, and TPS2000 Only)	2-28

Save and Recall Commands	2-28
Status and Error Commands	2-29
Trend Plot Commands (TBS1000B models only).....	2-30
Trigger Commands	2-30
Vertical Commands	2-32
Waveform Commands.....	2-32
Zoom Commands (TBS1000B/EDU models only)	2-36
Command Descriptions	2-39
Manual Conventions.....	2-39

Status and Events

Status and Events	3-1
Registers	3-1
Queues	3-4
Event Handling Sequence.....	3-5
Synchronization Methods	3-7

Programming Examples

Programming Examples	4-1
----------------------------	-----

Appendices

Appendix A: ASCII Code Chart	A-1
Appendix B: Factory Setup.....	B-1
TBS1000, TDS2000C, TDS1000C-EDU, TDS2000B, and TDS1000B Series Oscilloscopes.....	B-1
TPS2000 Series Oscilloscopes	B-2
TPS2000B Series Oscilloscopes	B-4
TDS1000 and TDS2000 Series Oscilloscopes.....	B-5
TDS210 and TDS220 Oscilloscopes	B-7
TDS224 Oscilloscopes	B-8
Appendix C: Reserved Words.....	C-1

Glossary

Preface

This programmer manual provides information on how to remotely operate your oscilloscope. You can use communication ports and protocols, such as for the RS-232, the General Purpose Interface Bus (GPIB), or Universal Serial Bus (USB) standards, to remotely control and operate your oscilloscope.

This document supports the following products:

- TBS1000B/EDU Series instructions, any version
- TBS1000 Series instruments, any version
- TPS2000 and TPS2000B Series instruments, any version.
- TDS1000C-EDU, any version.
- TDS2000C Series instruments, any version.
- TDS1000B and TDS2000B Series instruments, any version.
- TDS2CM or TDS2CMA, any version, when used in TDS1000 or TDS2000 Series instruments, any version.
- TDS2MEM any version, when used in most TDS1000 or TDS2000 Series instruments (except TDS1001 and TDS2004 models), any version.
- TDS2CM, TDS2CMA, or TDS2MM any version, when used in a TDS224 instrument, any version.
- TDS2CM or TDS2CMA version CMV:v1.04 and above, or TDS2MM any version, when used in TDS210 and TDS220 instruments with FV:v1.09 and above.

Related Documents

Each series of oscilloscopes has a different set of documentation.

TBS1000B/EDU Series Manuals

Language	TBS user manual part number
English	077-0886-XX
French	077-0887-XX
Italian	077-0888-XX
German	077-0889-XX
Spanish	077-0890-XX
Japanese	077-0891-XX
Portuguese	077-0892-XX
Simplified Chinese	077-0893-XX
Traditional Chinese	077-0894-XX
Korean	077-0895-XX
Russian	077-0896-XX

TBS1000 Series Manuals

Language	TBS user manual part number
English	077-0760-XX
French	077-0761-XX
Italian	077-0762-XX
German	077-0763-XX
Spanish	077-0764-XX
Japanese	077-0765-XX
Portuguese	077-0766-XX
Simplified Chinese	077-0767-XX
Traditional Chinese	077-0768-XX
Korean	077-0769-XX
Russian	077-0770-XX

TPS2000 and TPS2000B Series Manuals

For general operation, refer to your product user manual, a standard accessory, listed in the following table.

Language	TPS user manual part number	
	TPS2000 Series	TPS2000B Series
English	071-1441-XX	071-2722-XX
French	071-1442-XX	071-2723-XX

Language	TPS user manual part number	
	TPS2000 Series	TPS2000B Series
Italian	071-1443-XX	071-2724-XX
German	071-1444-XX	071-2725-XX
Spanish	071-1445-XX	071-2726-XX
Japanese	071-1446-XX	071-2727-XX
Portuguese	071-1447-XX	071-2728-XX
Simplified Chinese	071-1448-XX	071-2729-XX
Traditional Chinese	071-1449-XX	071-2730-XX
Korean	071-1450-XX	071-2731-XX
Russian	071-1451-XX	071-2732-XX

For information on the TPS2PWR1 Power Analysis Application, refer to the *TPS2PWR1 Power Analysis Application User Manual*, an optional accessory available in eleven languages.

Language	TPS2PWR1 user manual part number
English	071-1452-XX
French	071-1453-XX
Italian	071-1454-XX
German	071-1455-XX
Spanish	071-1456-XX
Japanese	071-1457-XX
Portuguese	071-1458-XX
Simplified Chinese	071-1459-XX
Traditional Chinese	071-1460-XX
Korean	071-1461-XX
Russian	071-1462-XX

**TDS1000, TDS2000,
TDS1000C-EDU, and
TDS2000C Series manuals**

For general operation, refer to the user manual for your product. For information on the TDS2CMA Communications module, refer to the *TDS1000 and TDS2000 Series Digital Storage Oscilloscope User Manual*.

Language	User manual part number		
	TDS1000/TDS2000	TDS1000B/TDS2000B	TDS1000C-EDU/TDS2000C
English	071-1064-XX	071-1817-XX	071-2722-XX
French	071-1065-XX	071-1818-XX	071-2723-XX
Italian	071-1066-XX	071-1819-XX	071-2724-XX
German	071-1067-XX	071-1820-XX	071-2725-XX
Spanish	071-1068-XX	071-1821-XX	071-2726-XX
Japanese	071-1069-XX	071-1822-XX	071-2727-XX
Portuguese	071-1070-XX	071-1823-XX	071-2728-XX
Simplified Chinese	071-1071-XX	071-1824-XX	071-2729-XX
Traditional Chinese	071-1072-XX	071-1825-XX	071-2730-XX
Korean	071-1073-XX	071-1826-XX	071-2731-XX
Russian	071-1074-XX	071-1827-XX	071-2732-XX

For information on the TDS2MEM Storage Memory and Communications module, refer to the *TDS2MEM Storage Memory and Communications Module User Manual* (071-1262-XX), an optional accessory that includes eleven languages.

TDS200 Series Manuals

For general operation, refer to the *TDS200 Series Digital Real-Time Oscilloscope User Manual*, a standard accessory.

Language	User manual part number
English	071-0398-XX
French	071-0400-XX
Italian	071-0401-XX
German	071-0402-XX
Spanish	071-0399-XX
Japanese	071-0405-XX
Portuguese	071-0403-XX
Simplified Chinese	071-0406-XX
Traditional Chinese	071-0407-XX
Korean	071-0408-XX
Russian	071-0404-XX

For information on the TDS2CMA Communications module, or TDS2MM Math Measurements module, refer to the *TDS200 Series Extension Modules Instructions Manual* (071-0409-XX), a standard accessory for extension modules in English only.

Service Manuals (English Only)

For information on how to service your oscilloscope, refer to the appropriate manual from the following optional accessories:

- *TBS1000B/EDU Series Digital Storage Oscilloscopes Service Manual (077-0897-XX)*
- *TBS1000 Series Digital Storage Oscilloscopes Service Manual (077-0772-XX)*
- *TDS2000C and TDS1000C-EDU Series Digital Storage Oscilloscopes Service Manual (077-0446-XX)*
- *TDS1000B and TDS2000B Series Digital Storage Oscilloscopes Service Manual (077-0356-XX)*
- *TDS1000 and TDS2000 Series Digital Storage Oscilloscopes Service Manual (071-1076-XX)*
- *TDS200 Series Digital Real-Time Oscilloscopes Service Manual (071-0492-XX)*
- *TPS2000B Series Digital Storage Oscilloscopes Service Manual (077-4447-XX)*
- *TPS2000 Series Digital Storage Oscilloscopes Service Manual (071-1465-XX) or (077-0306-00)*

Conventions

Refer to *Command Syntax* for information about command conventions. (See page 2-1.)

This manual uses the following conventions:

- References to the TDS2CMA Communications Extension Module include the TDS2CM and TDS2CMAX modules.
- Command descriptions list specific oscilloscopes series (and modules) when commands are valid for only those products

Getting Started

Getting Started

This manual contains information on how to remotely control and operate your oscilloscope through communications protocol and commands.

NOTE. For TBS1000B/EDU, TBS1000, TDS2000C, TDS1000C-EDU, TDS2000B, and the TDS1000B Series, you need to install the PC Communications software from the CD that came with the oscilloscope on a PC before you connect the oscilloscope USB Device port to the PC. Refer to the product user manual for installation information.

For all products, you need to connect an appropriate cable between the communications port on your oscilloscope and your PC.

The next table describes where the communications port is located on an extension module or oscilloscope, and the function of the port.

Series	Port location	Port function
TDS200	TDS2CM, TDS2CMA, or TDS2CMAX Communications, TDS2MM Math	RS-232, Centronics, GPIB
TDS1000/ TDS2000 ¹	TDS2CMA or TDS2CMAX TDS2MEM Storage Memory and Communications	RS-232, Centronics, GPIB CompactFlash
TBS1000B/EDU, TBS1000, TDS2000C, TDS1000C-EDU, TDS1000B, and TDS2000B ²	Back of oscilloscope	USB Device GPIB with a TEK-USB-488 adapter
TPS2000 and TPS2000B	Back of oscilloscope	RS-232, Centronics

¹ TDS1001 and TDS2004 are not compatible with the TDS2MEM module.

² Install the PC Communications software from the CD that came with the oscilloscope first, and then refer to your product user manual for information on installing the software. After the software is installed, connect the oscilloscope to a PC.

Refer to your oscilloscope user manual for information on how to install, test, and configure your oscilloscope and module.

NOTE. The firmware for the TBS1000B/EDU, TBS1000, TDS2000C, TDS1000C-EDU, TDS1000B, TDS2000B, TPS2000B, and TPS2000 Series oscilloscopes includes communications, math, and storage memory functions.

Series	TDS2CM, TDS2CMA or TDS2CMAX	TDS2MM	TDS2MEM	TEK-USB-488
TDS200	Yes	Yes	No	No
TDS1000 or TDS2000	Yes	No	Yes ¹	No
TBS1000B/EDU, TBS1000, TDS2000C, TDS1000C-EDU, TDS1000B or TDS2000B	No	No	No	Yes
TPS2000 or TPS2000B ²	No	No	No	No

¹ TDS1001 and TDS2004 models are not compatible with the TDS2MEM module.

² RS-232 is included in the oscilloscope firmware.

NOTE. *If you use GPIB with the TBS1000B/EDU, TBS1000, TDS2000C, TDS1000C-EDU, TDS2000B, or TDS1000B Series, you can set a unique GPIB address for the oscilloscope through the UTILITY ► Options ► GPIB Setup option.*

Syntax and Commands

Command Syntax

You can control the oscilloscope through the GPIB, RS-232, or USB interface using a large group of commands and queries.

This section describes the syntax these commands and queries use and the conventions the oscilloscope uses to process them. The commands and queries themselves are listed in the *Command Descriptions* section.

Command Syntax

Table 2-1: Oscilloscope communication protocol

Model or option	GPIB	RS-232	USB
TDS2CM, TDS2CMA, TDS2CMAX	Yes	Yes	No
TDS2MM	Yes	Yes	No
TDS2MEM	No	Yes	No
TDS1000 or TDS2000	Yes ¹	Yes ¹ ²	No
TBS1000B/EDU, TBS1000, TDS2000C, TDS1000C-EDU, TDS1000B, or TDS2000B	Yes ³	No	Yes
TPS2000B, TPS2000	No	Yes	No

¹ Function available with a TDS2CM, TDS2CMA, or TDS2CMAX module.

² Function available with a TDS2MEM module.

³ Function available with a TEK-USB-488 adapter.

You transmit commands to the oscilloscope using the enhanced American Standard Code for Information Interchange (ASCII) character encoding. *Appendix A* contains a chart of the ASCII character set.

The Backus Naur Form (BNF) notation is used in this manual to describe commands and queries.

Table 2-2: BNF notation

Symbol	Meaning
< >	Defined element
::=	Is defined as
	Exclusive OR
{ }	Group; one element is required

Table 2-2: BNF notation (cont.)

Symbol	Meaning
[]	Optional; can be omitted
. . .	Previous element(s) may be repeated
()	Comment

Command and Query Structure

Commands consist of set commands and query commands (usually simply called commands and queries). Commands change oscilloscope settings or perform a specific action. Queries cause the oscilloscope to return data and information about its status.

Most commands have both a set form and a query form. The query form of the command is the same as the set form except that it ends with a question mark. For example, the set command ACQUIRE:MODE has a query form ACQUIRE:MODE?. Not all commands have both a set and a query form; some commands are set only and some are query only.

A few commands do both a set and query action. For example, the *CAL? command runs a self-calibration program on the oscilloscope, then returns the result of the calibration.

A command message is a command or query name, followed by any information the oscilloscope needs to execute the command or query. Command messages consist of five different element types.

Table 2-3: Command message elements

Symbol	Meaning
<Header>	The basic command name. If the header ends with a question mark, the command is a query. The header may begin with a colon (:) character; if the command is concatenated with other commands the beginning colon is required. The beginning colon can never be used with command headers beginning with a star (*).
<Mnemonic>	A header subfunction. Some command headers have only one mnemonic. If a command header has multiple mnemonics, they are always separated from each other by a colon (:) character.
<Argument>	A quantity, quality, restriction, or limit associated with the header. Not all commands have an argument, while other commands have multiple arguments. Arguments are separated from the header by a <Space>. Arguments are separated from each other by a <Comma>.
<Comma>	A single comma between arguments of multiple-argument commands. It may optionally have white space characters before and after the comma.
<Space>	A white space character between command header and argument. It may optionally consist of multiple white space characters.

The following figure shows the five command message elements.

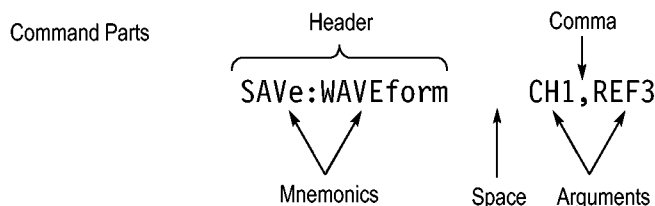

Figure 2-1: Command message elements

Commands Commands cause the oscilloscope to perform a specific function or change one of its settings. Commands have the structure:

```
[:]<Header>[<Space><Argument>[<Comma><Argument>]...]
```

A command header is made up of one or more mnemonics arranged in a hierarchical or tree structure. The first mnemonic is the base or root of the tree and each subsequent mnemonic is a level or branch off of the previous one. Commands at a higher level in the tree may affect those at a lower level. The leading colon (:) always returns you to the base of the command tree.

Queries Queries cause the oscilloscope to return information about its status or settings. Queries have the structure:

```
[:]<Header>
```

```
[:]<Header>[<Space><Argument>[<Comma><Argument>]...]
```

You can specify a query command at any level within the command tree unless otherwise noted. These branch queries return information about all the mnemonics below the specified branch or level.

For example, MEASUREMENT:MEAS<x>:UNITS? returns the measurement units, while MEASUREMENT:MEAS<x>:TYPE? returns the measurement type selected for the measurement, and MEASUREMENT:MEAS<x>? returns all the measurement parameters for the specified measurement.

Headers in Query Responses

You can control whether the oscilloscope returns headers as part of the query response. Use the HEADER command to control this feature. If header is on, the oscilloscope returns command headers as part of the query and formats the query response as a valid set command. When header is off, the oscilloscope sends back only the values in the response. This format can make it easier to parse and extract the information from the response.

Table 2-4: Comparison of Header Off and Header On responses

Query	Header Off response	Header On response
ACQuire:NUMAVg	64	ACQUIRE:NUMAVG 64
CHx1:COUPling	DC	CH1:COUPLING DC

Clearing the Output Queue

To clear the output queue and reset the oscilloscope to accept a new command or query, send a Device Clear (DCL) from a GPIB host.

From an RS-232 host, send a break signal. The RS-232 interface responds by returning the ASCII string "DCL."

From a USB host, send an INITIATE_CLEAR followed by a CHECK_CLEAR_STATUS. The USB interface responds to CHECK_CLEAR_STATUS with STATUS_SUCCESS when it is finished clearing the output queue.

Command Entry

Follow these general rules when entering commands:

- Enter commands in upper or lower case.
- You can precede any command with white space characters. White space characters include any combination of the ASCII control characters 00 through 09 and 0B through 20 hexadecimal (0 through 9 and 11 through 32 decimal).
- The oscilloscope ignores commands that consists of just a combination of white space characters and line feeds.

Abbreviating Commands

You can abbreviate many oscilloscope commands. These abbreviations are shown in capital letters in the command listing in the *Command Groups* section and *Command Descriptions* section. For example, the command ACQuire:NUMAVg can be entered simply as ACQ:NUMA or acq:numa.

If you use the HEADer command to have command headers included as part of query responses, you can also control whether the returned headers are abbreviated or are full-length using the VERBose command.

Concatenating Commands

You can concatenate any combination of set commands and queries using a semicolon (;). The oscilloscope executes concatenated commands in the order received. When concatenating commands and queries you must follow these rules:

- Completely different headers must be separated by both a semicolon and by the beginning colon on all commands but the first. For example, the commands TRIGger:MODE NORMal and ACQuire:NUMAVg 16 can be concatenated into a single command:

TRIGger:MODE NORMAL;:ACQuire:NUMAVg 16

- If concatenated commands have headers that differ by only the last mnemonic, you can abbreviate the second command and eliminate the beginning colon. For example, the commands ACQuire:MODE AVErAge and ACQuire:NUMAVg 16 could be concatenated into a single command:

ACQuire:MODE AVErAge; NUMAVg 16

The longer version works equally well:

ACQuire:MODE AVErAge;:ACQuire:NUMAVg 16

- Never precede a star (*) command with a colon or semicolon:

ACQuire:MODE AVErAge;*TRG

The oscilloscope processes commands that follow the star command as if the star command was not there, so:

ACQuire:MODE AVErAge;*TRG;NUMAVg 16

sets the acquisition mode to average and sets acquisition averaging to 16. The *TRG command is ignored.

- When you concatenate queries, the responses to all queries are combined into a single response message. For example, if channel 1 coupling is set to DC and the bandwidth is set to 20 MHz, the concatenated query:

CH1:COUPLing;BANdwidth

returns CH1:COUPLING DC;:CH1:BANDWIDTH ON if header is on, or DC;ON if header is off.

- You can concatenate set commands and queries in the same message. For example:

ACQuire:MODE AVErAge;NUMAVg;STATE

is a valid message that sets the acquisition mode to average, queries the number of acquisitions for averaging, and then queries the acquisition state. The oscilloscope executes concatenated commands and queries in the order it receives them.

- Any query that returns arbitrary data, such as ID, must be the last query when part of a concatenated command. If the query is not last, the oscilloscope generates event message 440.

Here are some INVALID concatenation examples:

- CH1:COUPLing DC;ACQuire:NUMAVg 16 (missing colon before ACQuire)
- CH1:COUPLing DC;:BANdwidth ON (invalid colon before BANDwidth)
- CH1:COUPLing DC;:*TRG (invalid colon before a star (*) command)

- HORizontal:MAIn:POSition 0;MAIn:SCAlE 1E-13 (levels of mnemonics are different; either remove the second occurrence of MAIn:, or put HORizontal: in front of MAIN:SCAlE)

Message Terminators

This manual uses the term <EOM> (End of message) to represent a message terminator.

GPIB End of Message (EOM) Terminators. GPIB EOM terminators can be the END message (EOI asserted concurrently with the last data byte), the ASCII code for line feed (LF) sent as the last data byte, or both. The oscilloscope always terminates messages with LF and EOI. White space is allowed before the terminator; for example, CR LF is acceptable.

USB End of Message (EOM) Terminators. The EOM bit must be set in the USB header of the last transfer of a command message

See the USB Test and Measurement Class Specification (USBTMC) section 3.2.1 for details. The oscilloscope terminates messages by setting the EOM bit in the USB header of the last transfer of a message to the host (USBTMC Specification section 3.3.1), and by terminating messages with a LF. White space is allowed before the terminator; for example, CR LF is acceptable.

RS-232 End of Message Terminators. RS-232 EOM terminators can be a CR (carriage return), LF (line feed), CRLF (carriage return followed by a line feed), or LFCR (line feed followed by a carriage return)

When receiving, the oscilloscope accepts all four combinations as valid input message terminators regardless of the currently selected terminator. When a combination of multiple characters is selected (CRLF or LFCR), the oscilloscope interprets the first character as the terminator and the second character as a null command.

Constructed Mnemonics

Some header mnemonics specify one of a range of mnemonics. For example, a channel mnemonic could be CH2. You can use these mnemonics in the command just as you do any other mnemonic. For example, there is a CH1:VOLts command and there is also a CH2:VOLts command. In the command descriptions, this list of choices is abbreviated CH<x>.

Channel mnemonics. Commands specify the channel to use as a mnemonic in the header.

Symbol	Meaning
CH<x>	2-channel models: A channel specifier; <x> is 1 or 2. 4-channel models: A channel specifier; <x> is 1, 2, 3, or 4.

Reference Waveform Mnemonics Commands can specify the reference waveform to use as a mnemonic in the header.

Symbol	Meaning
REF<x>	2-channel models: A reference waveform specifier; <x> is A or B. 4-channel models: A reference waveform specifier; <x> is A, B, C, or D.

Waveform Mnemonics In some commands you can specify a waveform without regard to its type: channel waveform, math waveform, or reference waveform. The "y" is the same as "x" in Reference Waveform Mnemonics.

Symbol	Meaning
<wfm>	Can be CH<x>, MATH, or REF<y>

Cursor Position Mnemonic When the oscilloscope displays cursors, commands may specify which cursor of the pair to use.

Symbol	Meaning
POSITION<x>	A cursor selector; <x> is 1 or 2.

Measurement Specifier Mnemonics Commands can specify which measurement to set or query as a mnemonic in the header. The oscilloscope can display up to four (TDS200) or five (TBS1000, TDS2000C, TDS1000C-EDU, TDS2000B, TDS1000B, TDS2000, TDS1000, TPS2000B, and TPS2000) or six (TBS1000B/EDU) automated measurements.

Symbol	Meaning
MEAS<x>	A measurement specifier; <x> is 1-4 (TDS200) or 1-5 (TBS1000, TDS2000C, TDS1000C-EDU, TDS2000B, TDS1000B, TDS2000, TDS1000, TPS2000B, and TPS2000) or 1-6 (TBS1000B/EDU).

Argument Types

A command argument can be in one of several forms. The individual descriptions of each command tell which argument types to use with that command.

Numeric Arguments Many oscilloscope commands require numeric arguments.

Table 2-5: Types of numeric arguments

Symbol	Meaning
<NR1>	Signed integer value
<NR2>	Floating point value without an exponent
<NR3>	Floating point value with an exponent

The syntax shown is the data format that the oscilloscope returns in response to a query. This format is also the preferred format when sending a command to the oscilloscope.

When you enter an incorrect numeric argument, the oscilloscope automatically forces the numeric argument to a correct value.

Table 2-6: Oscilloscope handling of incorrect numeric arguments

Argument value	Oscilloscope response
Numeric argument is less than lowest correct value for that command	Sets the specified command to the lowest correct value and executes the command
Numeric argument is greater than the highest correct value for that command	Sets the specified command to the highest correct value and executes the command
Numeric value is between two correct values	Rounds the entered value to the nearest correct value and executes the command

Quoted String Arguments Some commands accept or return data in the form of a quoted string, which is simply a group of ASCII characters enclosed by single quotes (') or double quotes ("). For example:

"this is a quoted string"

Symbol	Meaning
<QString>	Quoted string of ASCII text

Follow these rules when you use quoted strings:

1. A quoted string can include any character defined in the 7-bit ASCII character set. (See page A-1, *ASCII Code Chart*.)
2. Use the same type of quote character to open and close the string:
"this is a valid string"
3. You can mix quotation marks within a string if you follow the previous rule:
"this is an 'acceptable' string"
4. You can include a quote character within a string simply by repeating the quote. For example,
"here is a "" mark"
5. Strings can have upper or lower case characters.
6. If you use a GPIB network, you cannot terminate a quoted string with the END message before the closing delimiter.
7. A carriage return or line feed embedded in a quoted string does not terminate the string, but is treated as just another character in the string.
8. The maximum length of a quoted string returned from a query is 1000 characters.

Here are some examples of invalid strings:

"Invalid string argument" (quotes are not of the same type)
"test<EOI>" (termination character is embedded in the string)

Block Arguments

Several oscilloscope commands use a block argument form.

Table 2-7: Parts of a block argument

Symbol	Meaning
<NZDig>	A nonzero digit character, in the range 1-9 Specifies the number of <Dig> elements that follow
<Dig>	A digit character, in the range 0-9
<DChar>	A character with the hex equivalent of 00 through FF hexadecimal (0 through 255 decimal)
<Block>	A block of data bytes, defined as: <Block> := { #<NZDig><Dig>[<Dig>...][<DChar>...] #0[<DChar>...]<terminator> }

The following figure shows an example of a block argument.

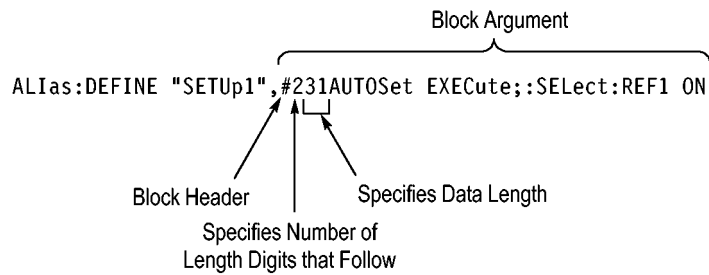

Figure 2-2: Block argument example

<NZDig> specifies the number of <Dig> elements that follow. Taken together, the <Dig> elements form a decimal integer that specifies how many <DChar> elements follow.

#0 means that the <Block> is an indefinite length block. The <terminator> ends the block. You should not use indefinite length blocks with RS-232, because there is no way to include a <terminator> character as a <DChar> character.

The first occurrence of a <terminator> character signals the end of the block and any subsequent <DChar> characters will be interpreted as a syntax error. With the GPIB, the EOI line signals the last byte. With the USB, the EOM bit signals the last byte.

Command Groups

This section lists the commands organized by functional group. The *Command Descriptions* section lists all commands alphabetically.

The oscilloscope GPIB, USB, and RS-232 interfaces conform to Tektronix standard codes and formats except where noted. The GPIB interface also conforms to IEEE Std 488.2–1987 except where noted. The USB interface also conforms to USB Test and Measurement Class, Subclass USB488 Specification, except where noted.

Acquisition Commands

Acquisition commands affect the acquisition of waveforms. These commands control mode, averaging, and single-waveform acquisition.

Table 2-8: Acquisition commands

Command	Description
ACQUIRE?	Return acquisition parameters
ACQUIRE:MODE	Set or query the acquisition mode
ACQUIRE:NUMACQ?	Return the # of acquisitions obtained
ACQUIRE:NUMAVG	Set or query the number of acquisitions for average
ACQUIRE:STATE	Start or stop the acquisition system
ACQUIRE:STOPAFTER	Set or query the acquisition control

Calibration and Diagnostic Commands

Calibration and Diagnostic commands let you initiate the oscilloscope self-calibration routines and examine the results of diagnostic tests.

Table 2-9: Calibration and Diagnostic commands

Command	Description
*CAL?	Perform an internal self-calibration and return result status
CALIBRATE:ABORT	Stop an in-progress factory calibration
CALIBRATE:CONTINUE	Perform the next step in the factory calibration sequence
CALIBRATE:FACTORY	Initialize the factory calibration sequence
CALIBRATE:INTERNAL	Perform an internal self-calibration
CALIBRATE:STATUS?	Return PASS or FAIL status of the last self- or factory-calibration operation

Table 2-9: Calibration and Diagnostic commands (cont.)

Command	Description
DIAg:RESUlt:FLAg?	Return diagnostic tests status
DIAg:RESUlt:LOG?	Return diagnostic test sequence results
ERRLOG:FIRST?	Returns first entry from error log
ERRLOG:NEXT?	Returns next entry from error log

Counter Commands (TBS1000B/EDU models only)

Counter commands provide control over the oscilloscope counter feature.

Table 2-10: Counter commands

Header	Description
COUNTERFreq?	Returns all counter frequency parameters (TBS1000B/EDU models only)
COUNTERFreq:CH1Level	Sets or queries the CH1 trigger level value (TBS1000B/EDU models only)
COUNTERFreq:CH1State	Sets or queries the CH1 counter to be on or off (TBS1000B/EDU)
COUNTERFreq:CH1Value?	Returns the CH1 counter frequency value (TBS1000B/EDU models only)
COUNTERFreq:CH2Level	Sets or queries the CH2 trigger level value (TBS1000B/EDU models only)
COUNTERFreq:CH2State	Sets or queries the CH2 counter to be on or off (TBS1000B/EDU models only)
COUNTERFreq:CH2Value?	Returns the CH2 counter frequency value (TBS1000B/EDU models only)

Cursor Commands

Cursor commands provide control over the oscilloscope cursor display and readout.

Table 2-11: Cursor commands

Header	Description
CURSor?	Return cursor settings
Command	Set or query the cursors on or off; select cursor type
CURSor:HBArs?	Return horizontal bar settings
CURSor:HBArs:DELTA?	Return vertical distance between horizontal bar cursors

Table 2-11: Cursor commands (cont.)

Header	Description
CURSor:HBArs:POSITION<x>	Set or query the position of a horizontal bar cursor
CURSor:HBArs:UNIts?	Query vertical scale units
CURSor:SElect:SOUrce	Select waveform
CURSor:VBArs?	Return vertical bar settings
CURSor:VBArs:DELTA?	Return horizontal distance between cursors
CURSor:VBArs:HDELTA?	Return horizontal distance between cursors. Same as CURSor:VBArs:DELTA
CURSor:VBArs:HPOS<x>?	Return the amplitude of the waveform at the cursor position
CURSor:VBArs:POSITION<x>	Set or query the position of a vertical bar cursor
CURSor:VBArs:SLOPE?	Return the value of the on-screen dV/dt or dI/dt measurement
CURSor:VBArs:UNIts	Set or query the vertical cursors to time or frequency
CURSor:VBArs:VDELTA?	Return the vertical distance between cursors

Data Logging Commands (Available Only On TBS1000B, TBS1000 and TDS2000C Series Models)

Data logging commands let you direct the oscilloscope to automatically collect data over a period of time.

Table 2-12: Data logging commands

Command	Description
DATALOGging?	Return all the data logging parameters
DATALOGging:DURAtion	Set the duration of the data logging
DATALOGging:SOURCE	Set up the data logging source
DATALOGging:STATE	Turn on or off the data logging feature

Display Commands

Display commands let you change the graticule style, displayed contrast, and change other display attributes.

Table 2-13: Display commands

Command	Description
DISplay?	Return display settings
DISplay:BACKLight	Sets the backlight value (TBS1000B/EDU models only)
DISplay:BRIGHTness	Set or query the LCD display brightness
DISplay:CONTRast	Set or query the LCD display contrast
DISplay:FORMat	Set or query the YT or XY display
DISplay:INVert	Set or query the normal or inverted monochrome display
DISplay:PERStence	Set or query the accumulate time
DISplay:STYle	Set or query the waveform display style

FFT Commands (TBS1000B/EDU models only)

These commands provide control over the oscilloscope FFT feature.

Table 2-14: FFT commands

Command	Description
FFT?	Returns all FFT parameters (TBS1000B/EDU models only)
FFT:HORizontal:POSition	Sets or queries the FFT horizontal display position (TBS1000B/EDU models only)
FFT:HORizontal:SCAle	Sets or queries the FFT horizontal zoom factor (TBS1000B/EDU models only)
FFT:SOURce	Sets or queries the FFT source (TBS1000B/EDU models only)
FFT:SRCWFM	Sets or queries the FFT source waveform display state (TBS1000B/EDU models only)
FFT:VERtical:POSition	Sets or queries the FFT vertical display position (TBS1000B/EDU models only)
FFT:VERtical:SCAle	Sets or queries the FFT vertical zoom factor (TBS1000B/EDU models only)
FFT:WIN	Sets or queries the FFT window state (TBS1000B/EDU models only)
SElect:FFT	Sets or queries the FFT display state (TBS1000B/EDU models only)

File System Commands (TBS1000B/EDU, TBS1000, TDS2000C, TDS1000C-EDU, TDS2000B, TDS1000B, TDS2MEM Module, TPS2000B, and TPS2000 Only)

File system commands perform file management tasks on the CompactFlash (CF) card of TPS2000 and TPS2000B oscilloscopes, and TDS models with a TDS2MEM module; and on USB flash drives of TBS1000B/EDU, TBS1000, TDS2000C, TDS1000C-EDU, TDS2000B, TDS1000B oscilloscopes.

Table 2-15: File System commands

Command	Description
FILESystem?	Return the current working directory (CWD) and CF card or USB flash drive free space values
FILESystem:CWD	Set or query the current CF card or USB flash drive directory
FILESystem:DELEte	Delete specified file on the CF card or USB flash drive

Table 2-15: File System commands (cont.)

Command	Description
FILESystem:DIR?	Return a list of files in current CF card or USB flash drive directory
FILESystem:FORMat	Format the CF card or USB flash drive
FILESystem:FREEspace?	Return free space on the CF card or USB flash drive
FILESystem:MkDir	Create a new directory on the CF card or USB flash drive
FILESystem:REName	Assign new name to specified file on the CF card or USB flash drive
FILESystem:RMDir	Delete specified directory

File System Conventions

Use the following conventions when specifying file paths and file names:

- The default folder (directory) for non-TBS1000B/EDU models is A:\.
- The default folder (directory) for TBS1000B/EDU models is /usb0/.
- File and folder names have a maximum of 11 characters; eight characters, followed by a period, followed by up to three characters. This format is referred to as 8.3 naming.
- Wild card characters (*, %,) are not valid characters in file or path names.
- Lists the Windows-generated short file and folder names for long file or folder names created on PC Windows operating systems.

Hard Copy Commands

The hard copy commands let you control the format of hard copy output, and the starting and stopping of hard copies.

NOTE. *TBS1000B/EDU, TBS1000, TDS2000C, TDS1000C-EDU, TDS1000B, and TDS2000B oscilloscopes include PictBridge commands to provide additional control of the hard copy format.*

Table 2-16: Hard Copy commands

Command	Description
HARDCopy	Start or terminate hard copy
HARDCopy:BUTTON	Set or query the hard copy button function For TBS1000B/EDU, TBS1000, TDS2000C, TDS1000C-EDU, TDS2000B, TDS1000B, TPS2000, and TPS2000B set or query the PRINT button function
HARDCopy:FORMat	Set or query the hard copy output format
HARDCopy:INKSaver	Set or query the hard copy ink saver option
HARDCopy:LAYout	Set or query the hard copy orientation
HARDCopy:PORT	Set or query the hard copy port for output: RS232, GPIB, Centronics, or USB

Horizontal Commands

Horizontal commands control the time bases of the oscilloscope. You can set the position and time per division of both the main and window time bases. You can substitute SECdiv for SCALE in all appropriate horizontal commands. This provides program compatibility with previous Tektronix digitizing oscilloscopes.

Table 2-17: Horizontal commands

Command	Description
HORizontal?	Return horizontal settings
HORizontal:DELay?	Return all settings for the window time base. NOTE. <i>This command is not applicable to TBS1000B/EDU models.</i>
HORizontal:DELay:POSition	Position window NOTE. <i>This command is not applicable to TBS1000B/EDU models.</i>

Table 2-17: Horizontal commands (cont.)

Command	Description
HORizontal:DELay:SCAlE	Set or query the window time base time/division NOTE. This command is not applicable to TBS1000B/EDU models.
HORizontal:DELay:SECdiv	Same as HORizontal:DELay:SCAlE NOTE. This command is not applicable to TBS1000B/EDU models.
HORizontal:MAIn?	Return the main time base time/division
HORizontal:MAIn:POSition	Set or query the main time base trigger point
HORizontal:MAIn:SCAlE	Set or query the main time base time/division
HORizontal:MAIn:SECdiv	Same as HORizontal:MAIn:SCAlE
HORizontal:POSition	Set or query the position of waveform to display
HORizontal:RECOrdlength?	Return waveform record length
HORizontal:SCAlE	Same as HORizontal:MAIn:SCAlE
HORizontal:SECdiv	Same as HORizontal:MAIn:SCAlE
HORizontal:VIEW	Select view NOTE. This command is not applicable to TBS1000B/EDU models.

Limit Test Commands (Available Only On TBS1000B, TBS1000 and TDS2000C Series Models)

Limit test commands direct the oscilloscope to monitor an active input signal against a template and to output pass or fail results by judging whether the input signal is within the bounds of the template.

Table 2-18: Limit test commands

Command	Description
LIMit?	Return all limit test parameters
LIMit:COMpare	Set or return the template against which to compare the waveform acquired through the specified channel. NOTE. This command is not applicable to TBS1000B models.

Table 2-18: Limit test commands (cont.)

Command	Description
LIMit:RESUlt:FAIL?	Return the number of fail cases
LIMit:RESUlt:PASS?	Return the number of pass cases
LIMit:RESUlt:TOTAL?	Return the number of total cases tested
LIMit:SAVEIMAge	Set or return whether the oscilloscope should save the screen image to a file on a limit test failure event
LIMit:SAVEWFM	Set or return whether the oscilloscope should save the waveform to a file on a limit test failure event
LIMit:SOUrce	Sets or returns the source channel for the waveform currently being compared to the test template
LIMit:STATE	Turn limit testing on or off, or return whether limit testing is in effect
LIMit:STOPAfter:MODe	Set or restore the mode for the limit test stop after feature
LIMit:STOPAfter:TIMe	Set or return the limit test stop after time setting
LIMit:STOPAfter:VIOLation	Set or return the limit test stop after violation setting
LIMit:STOPAfter:WAVEform	Set or return the setting for the limit test stop after waveform function
LIMit:TEMPLate	Create and store the limit test template
LIMit:TEMPLate:DESTination	Set or return the destination reference waveform.
	NOTE. This command is not applicable to TBS1000B models.
LIMit:TEMPLate:SOUrce	Set or return the limit test source channel or reference waveform
LIMit:TEMPLate:DUALSOUrce	Sets the dual template waveform source.
	NOTE. This command is applicable only to TBS1000B models.
LIMit:TEMPLate:SAVEFIRSource	Saves the first template source data temporarily
	NOTE. This command is applicable only to TBS1000B models.
LIMit:TEMPLate:SAVESECSOURCE	Saves the second template source data temporarily
	NOTE. This command is applicable only to TBS1000B models.

Table 2-18: Limit test commands (cont.)

Command	Description
LIMit:TEMPLate:SAVESOUrce	Saves the template source data for single waveform templates NOTE. <i>This command is applicable only to TBS1000B models.</i>
LIMit:TEMPLate:TOLerance:HORizontal	Set or return the amount by which the source waveform is varied horizontally when creating the destination template waveform
LIMit:TEMPLate:TOLerance:VERTical	Set or return the amount by which the source waveform is varied vertically when creating the destination template waveform

Math Commands

Math commands provide math function definition.

Table 2-19: Math commands

Command	Description
MATH?	Query the definition for the math waveform
MATH:DEFINE	Set or query the math waveform definition
MATH:FFT?	Return all math FFT parameters. NOTE. <i>This command is not applicable to TBS1000B/EDU models.</i>
MATH:FFT:HORizontal:POSition	Set or query the FFT horizontal display position NOTE. <i>This command is not applicable to TBS1000B/EDU models.</i>
MATH:FFT:HORizontal:SCAle	Set or query the FFT horizontal zoom factor NOTE. <i>This command is not applicable to TBS1000B/EDU models.</i>
MATH:FFT:VERTical:POSition	Set or query the FFT vertical display position. NOTE. <i>This command is not applicable to TBS1000B/EDU models.</i>

Table 2-19: Math commands (cont.)

Command	Description
MATH:FFT:VERTical:SCALE	Set or query the FFT vertical zoom factor NOTE. <i>This command is not applicable to TBS1000B/EDU models.</i>
MATH:VERTical?	Return all math vertical waveform parameters
MATH:VERTical:POSition	Set or query the math waveform display position
MATH:VERTical:SCALE	Set or query the math waveform display scale

Measurement Commands

Measurement commands control the automated measurement system. The oscilloscope can display up to four (TDS200) or five (TBS1000, TDS2000C, TDS1000C-EDU, TDS2000B, TDS1000B, TDS2000, TDS1000, TPS2000B, and TPS2000) or six (TBS1000B/EDU) automated measurements. In the commands, these measurement readouts are named MEAS<x>, where <x> can be 1, 2, 3, or 4 (or 5 for TBS1000, TDS2000C, TDS1000C-EDU, TDS2000B, TDS1000B, TDS2000, TDS1000, TPS2000B, and TPS2000) (or 6 for the TBS1000B/EDU).

The best method for taking measurements over the computer interface is to use the MEASUREMENT:IMMED commands and queries. The immediate measurement has no front-panel equivalent, and the oscilloscope never displays immediate measurements.

Because they are computed only when they are requested, immediate measurements slow the waveform update rate less than displayed measurements.

Use the VALue? query to obtain measurement results of either displayed or immediate measurements.

Several measurement commands set and query measurement parameters. You can assign some parameters, such as waveform sources, differently for each measurement readout.

Table 2-20: Measurement commands

Command	Description
MEASUrement?	Return all measurement parameters
MEASUrement:CLEARSNAPSHOT	Clears the existing snapshot results and removes the snapshot window NOTE. This command is applicable only to TBS1000B/EDU models.
MEASUrement:GATing	Sets or returns the measurement gating NOTE. This command is applicable only to TBS1000B/EDU models.
MEASUrement:IMMed?	Return immediate measurement parameters
MEASUrement:IMMed:SOUrce[1]	Set or query the channel for immediate measurement
MEASUrement:IMMed:SOURCE2	Set or query the channel for two-source immediate measurements (TPS2000B/TPS2000 with Power Analysis Module only)
MEASUrement:IMMed:TYPe	Set or query the immediate measurement to be taken
MEASUrement:IMMed:UNIts?	Return the immediate measurement units
MEASUrement:IMMed:VALue?	Return the immediate measurement result

Table 2-20: Measurement commands (cont.)

Command	Description
MEASUrement:MEAS<x>?	Return parameters on the periodic measurement
MEASUrement:MEAS<x>:SOUrce	Set or query the channel to take the periodic measurement from
MEASUrement:MEAS<x>:TYPe	Set or query the type of periodic measurement to be taken
MEASUrement:MEAS<x>:UNIts?	Return the units for periodic measurement
MEASUrement:MEAS<x>:VALue?	Return periodic measurement results
MEASUrement:SNAPSHOT	Sets the measurement snapshot measurements <i>NOTE. This command is applicable only to TBS1000B/EDU models.</i>
MEASUrement:SNAPSOUrce	Sets or returns the snapshot source <i>NOTE. This command is applicable only to TBS1000B/EDU models.</i>

Miscellaneous Commands

Miscellaneous commands are a group of commands that do not fit into any other category.

Several commands and queries are common to all 488.2-1987 devices on the GPIB or USB bus, and the device on the RS-232 interface. These commands and queries are defined by IEEE Std. 488.2-1987 and Tektronix Standard Codes and Formats 1989 and begin with an asterisk (*) character.

Table 2-21: Miscellaneous commands

Command	Description
AUTORange	Return all autorange parameters
AUTORange:SETTings	Set or query the which parameters autorange can adjust
AUTORange:STATE	Set or query the autorange to on or off
AUTOSet	Automatic oscilloscope setup
AUTOSet:ENABLE	Allows educators to disable or enable the Autorange and Autoset functions. ¹ <i>NOTE. This command is not applicable to TBS1000B/EDU models.</i>
AUTOSet:SIGNAL?	Return the type of signal found by autoset

Table 2-21: Miscellaneous commands (cont.)

Command	Description
AUTOSet:VIEW	Set or query the Autoset view
DATE	Set or query the date value
*DDT	Set or query the group execute trigger (GET)
FACTory	Reset to factory default
HDR	Same as HEADer
HEADer	Set or query the command header
ID?	Return identification information
*IDN?	Return identification information
LANGuage	Set or query the language for display messages
LOCK	Lock front panel (local lockout)
*LRN?	Query device settings
REM	No action; remark only
*RST	Reset
SET?	Same as *LRN
TIMe	Set or query the time value
*TRG	Perform Group Execute Trigger (GET)
*TST?	Return self-test results
UNLock	Unlock front panel (local lockout)
VERBose	Return full command name or minimum spellings with query

¹ AUTOSet: ENABLE can be manually set from the Service Diag menu. To access the service diagnostics menu, refer to your product service manual.

PictBridge Commands (TBS1000B/EDU, TBS1000, TDS2000C, TDS1000C-EDU, TDS2000B, and TDS1000B Only)

The PictBridge commands let you control the format of the hard copy on the PictBridge compatible printer.

NOTE. The *HARDCopy:BUTTON*, *HARDCopy:INKSaver*, and *HARDCopy:LAYOUT* commands apply to the TBS1000B/EDU, TBS1000, TDS2000C, TDS1000C-EDU, TDS2000B, and TDS1000B oscilloscopes.

Table 2-22: PictBridge commands

Command	Description
PICTBridge:DEF	Set the next six options to default
PICTBridge:PAPERSIZE	Set or query the paper size
PICTBridge:IMAGESIZE	Set or query the image size
PICTBridge:PAPERTYPE	Set or query the paper type
PICTBridge:PRINTQUAL	Set or query the print quality
PICTBridge:DATEPRINT	Set or query the date print
PICTBridge:IDPRINT	Set or query the ID print

Power and Battery-Related Commands (TPS2000B and TPS2000 Only)

Power and Battery-Related commands provide battery management functions to a TPS2000B and TPS2000 oscilloscope.

Table 2-23: Power and Battery-Related commands (TPS2000B and TPS2000 only)

Command	Description
POWer?	Return all power parameters
POWer:AC:PRESENT?	Return whether the oscilloscope is being powered by battery or AC
POWer:BATTERY<x>:GASgauge?	Return the charge remaining in battery x
POWer:BATTERY<x>:STATUS?	Return status for battery x
POWer:BATTERIES:TIME?	Return the time remaining in both batteries
POWer:BUTTONLIGHT	Turn the lighted front-panel buttons on and off

Power Measurement (TPS2000B/TPS2000 with TPS2PWR1 Power Analysis Application Key Installed Only)

Power Measurement commands provide power measurements to a TPS2000B/TPS2000 oscilloscope with the TPS2PWR1 Power Analysis application software key installed.

Table 2-24: Power Measurement commands (TPS2000B/TPS2000 with TPS2PWR1 only)

Command	Description
HARmonics?	Return all harmonic parameters
HARmonics:ENABLE	Set or query the harmonics menu on and off
HARmonics:FREquency?	Return the frequency of the selected harmonic

Table 2-24: Power Measurement commands (TPS2000B/TPS2000 with TPS2PWR1 only) (cont.)

Command	Description
HARmonics:HRMS?	Return the frequency of the selected harmonic
HARmonics:PERCent?	Return the amplitude of the selected harmonic as a percent of the fundamental
HARmonics:PHase?	Return the phase of the selected harmonic, in degrees, relative to the fundamental
HARmonics:RMS?	Return the amplitude of the harmonics source in RMS units. This may be V_{rms} or I_{rms} depending on the type of source waveform
HARmonics:SAVe	Set the file name and path to save harmonic data
HARmonics:SELEct	Set or query the selected harmonic
HARmonics:SEtUp	Set or query the operating mode for harmonics measurements commands
HARmonics:SHOW	Set or query the specified harmonics
HARmonics:SOUrce	Set or query the source in the harmonics menu
HARmonics:THDF?	Query the total harmonic distortion of the waveform as percent of fundamental
HARmonics:THDR?	Query the total harmonic distortion of the waveform as % of input V_{rms}
POWerANALYSIS:SOUrces	Sets or query the power analysis sources
SWLoss?	Return switching loss measurement settings
SWLoss:ACQuire	Set or query the type of acquisition to use for Switching Loss commands
SWLoss:AVErage:CONDUCTION?	Return the power loss of the device under test when the device is conducting
SWLoss:AVErage:N?	Return the number of measurements used to calculate the averaged value for switching loss commands
SWLoss:AVErage:TOTAL?	Return the sum of the turn-on, turn-off, and conduction switching losses for an Average measurement
SWLoss:AVErage:TURNOff?	Return the power loss of the device under test when the device is transitioning from on to off
SWLoss:AVErage:TURNON?	Return the power loss of the device under test when the device is transitioning from off to on
SWLoss:ENABLe	Set or query switching loss measurements on or off

Table 2-24: Power Measurement commands (TPS2000B/TPS2000 with TPS2PWR1 only) (cont.)

Command	Description
SWLoss:LEVELS	Return oscilloscope Switching Loss Measurement settings to factory default (SWLoss:TONSTART, SWLoss:TONEND, SWLoss:TOFFSTART, SWLoss:TOFFEND only)
SWLoss:LOG:CONDUCTION?	Return the Conduction Loss for a switching loss measurement
SWLoss:LOG:INDEX	Set or query which measurement to return for a SWLoss:LOG command
SWLoss:LOG:TOTAL?	Return the Total Loss for a switching loss measurement
SWLoss:LOG:TURNOFF?	Return the Turn-Off Loss for a switching loss measurement
SWLoss:LOG:TURNON?	Return the Turn-On Loss for a switching loss measurement
SWLoss:SAVE	Saves the Switching Loss Measurements
SWLoss:SOURCES	Set or query the input sources for Switching Loss Measurements
SWLoss:STOPAfter	Set or query the number of acquisitions used for Switching Loss Measurements
SWLoss:TOFFEND	Set or query a level on the first falling edge of the current waveform that occurs after the turn-off starts
SWLoss:TONEND	Set or query a level on the first rising edge of the voltage waveform that occurs after the first falling edge
SWLoss:TOFFSTART	Set or query a level on the falling edge of the voltage waveform that defines where the beginning of the switching loss measurement ends
SWLoss:TONSTART	Set or query a level on the falling edge of the voltage waveform that defines where the switching loss measurement begins
SWLoss:UNITS	Set or query the units for Switching Loss Measurement
SWLoss:VALue:CONDUCTION?	Return the power loss of the device under test when the device is conducting in its on state
SWLoss:VALue:TOTAL?	Return the sum of the turn-on, turn-off, and conduction switching losses

Table 2-24: Power Measurement commands (TPS2000B/TPS2000 with TPS2PWR1 only) (cont.)

Command	Description
SWLoss:VALue:TURNOff?	Return the power loss of the device under test when the device is transitioning between its on and off state
SWLoss:VALue:TURNON?	Return the power loss of the device under test when the device is transitioning between its off and on state display
SWLoss:VSAT	Set or query the saturation voltage for the device under test
WAVEFORMANALYSIS:SOUrce	Set or query the source for Waveform Analysis commands

RS-232 Commands (TDS2000, TDS1000, TDS200, TPS2000B, and TPS2000 Only)

RS-232 commands allow you to set or query the parameters that control the RS-232 port.

Table 2-25: RS-232 commands

Command	Description
RS232?	Query RS232 parameters
RS232:BAUd	Set or query the baud rate
RS232:HARDFlagging	Set or query the hard flagging
RS232:PARity	Set or query the parity type
RS232:SOFTFlagging	Set or query the soft flagging
RS232:TRANsmit:TERMinator	Set or query the end-of-line terminator

Only certain oscilloscope models are compatible with RS-232. (See Table 2-1 on page 2-1.)

Save and Recall Commands

Save and Recall commands allow you to store and retrieve internal waveforms and settings. When you "save a setting," you save most of the settings of the oscilloscope. When you then "recall a setting," the oscilloscope restores itself to the state it was in when you saved that setting.

To display a saved waveform, use the [SELect:<wfm>](#) command.

Table 2-26: Save and Recall commands

Command	Description
*RCL	Recall setting
RECALL:SETUp	Recall saved oscilloscope setting
RECALL:WAVEForm	Recall saved waveform
*SAV	Save oscilloscope setting
SAVe:IMAge	Save screen image to file
SAVe:IMAge:FILEFormat	Set screen image file format
SAVe:SETUp	Save oscilloscope setting
SAVe:WAVEform	Save waveform

Status and Error Commands

Status and error commands let you determine the status of the oscilloscope and control events.

Several commands and queries are common to all devices on the GPIB or USB bus. These commands and queries are defined by IEEE Std. 488.2-1987 and Tek Standard Codes and Formats 1989, and begin with an asterisk (*) character.

Table 2-27: Status and Error commands

Command	Description
ALLEv?	Return all events
BUSY?	Return oscilloscope busy status
*CLS	Clear status
DESE	Set or query the device event status enable
*ESE	Set or query the standard event status enable
*ESR?	Return standard event status register; this is the usual way to determine whether a set command executed without error
EVENT?	Return event code
EVMsg?	Return event message
EVQty?	Return number of events in queue
*OPC	Set or query the operation complete
*PSC	Set or query the power-on status clear
*SRE	Set or query the service request enable
*STB?	Read status byte
*WAI	Wait to continue

Trend Plot Commands (TBS1000B models only)

Table 2-28: Trend plot commands

Command	Description
TRENDPLOT?	Returns all trend plot parameters (TBS1000B models only)
TRENDPLOT:STATE	Returns the running state of the trend plot (TBS1000B models only)
TRENDPLOT:TIME	Queries the elapsed time (TBS1000B models only)
TRENDPLOT:TP<x>:AVG?	Queries the current statistical average value (TBS1000B models only)
TRENDPLOT:TP<x>:MAX?	Queries the current statistical maximum value (TBS1000B models only)
TRENDPLOT:TP<x>:MIN?	Queries the current statistical minimum value (TBS1000B models only)
TRENDPLOT:TP<x>:SCALE?	Queries the current scale of per div (TBS1000B models only)
TRENDPLOT:TP<x>:SCALEMAX?	Queries the maximum value you can plot on the display (TBS1000B models only)
TRENDPLOT:TP<x>:SCALEMIN?	Queries the minimum value you can plot on the display (TBS1000B models only)
TRENDPLOT:TP<x>:SOURCE	Sets or returns the trend plot source (TBS1000B models only)
TRENDPLOT:TP<x>:TYPE	Sets or returns the trend plot type (TBS1000B models only)

Trigger Commands

Trigger commands control all aspects of oscilloscope triggering.

The three types of triggers are edge, pulse width, and video. Edge triggering is the default type. Edge triggering lets you acquire a waveform when the signal passes through a voltage level of your choosing. Pulse width triggering lets you trigger on normal or aberrant pulses. Video triggering adds the capability of triggering on video fields and lines.

Table 2-29: Trigger commands

Command	Description
TRIGger	Force trigger event
TRIGger:MAIn	Set main trigger level to 50%; Query returns main trigger settings
TRIGger:MAIn:EDGE?	Return edge trigger settings

Table 2-29: Trigger commands (cont.)

Command	Description
TRIGger:MAIn:EDGE:COUPling	Set or query the edge trigger coupling
TRIGger:MAIn:EDGE:SLOpe	Set or query the edge trigger slope
TRIGger:MAIn:EDGE:SOUrce	Set or query the edge trigger source
TRIGger:MAIn:FREQuency?	Return trigger frequency value (TBS1000B/EDU, TBS1000, TDS2000C, TDS1000C-EDU, TDS2000B, TDS1000B, TDS2000, TDS10000, TPS2000B, and TPS2000 only)
TRIGger:MAIn:HOLDOff?	Return trigger holdoff value
TRIGger:MAIn:HOLDOff:VALue	Set or query the trigger holdoff value
TRIGger:MAIn:LEVel	Set or query the trigger level
TRIGger:MAIn:MODE	Set or query the trigger mode
TRIGger:MAIn:PULse?	Return pulse trigger settings (TBS1000B/EDU, TBS1000, TDS2000C, TDS1000C-EDU, TDS2000B, TDS1000B, TDS2000, TDS1000, TPS2000B, and TPS2000 only)
TRIGger:MAIn:PULse:SOUrce	Set or query the pulse trigger source (TBS1000B/EDU, TBS1000, TDS2000C, TDS1000C-EDU, TDS2000B, TDS1000B, TDS2000, TDS1000, TPS2000B, and TPS2000 only)
TRIGger:MAIn:PULse:WIDth?	Return pulse trigger width parameters (TBS1000B/EDU, TBS1000, TDS2000C, TDS1000C-EDU, TDS2000B, TDS1000B, TDS2000, TDS1000, TPS2000B, and TPS2000 only)
TRIGger:MAIn:PULse:WIDth:POLarity	Set or query the pulse trigger polarity (TBS1000B/EDU, TBS1000, TDS2000C, TDS1000C-EDU, TDS2000B, TDS1000B, TDS2000, TDS1000, TPS2000B, and TPS2000 only)
TRIGger:MAIn:PULse:WIDth:WHEN	Set or query the pulse trigger when
TRIGger:MAIn:PULse:WIDth:WIDth	Set or query the pulse trigger width
TRIGger:MAIn:TYPe	Set or query the main trigger type
TRIGger:MAIn:VIDeo?	Query video trigger parameters
TRIGger:MAIn:VIDeo:LINE	Set or query the video trigger line (TBS1000B/EDU, TBS1000, TDS2000C, TDS1000C-EDU, TDS2000B, TDS1000B, TDS2000, TDS1000, TPS2000B, and TPS2000 only)
TRIGger:MAIn:VIDeo:POLarity	Set or query the video trigger polarity
TRIGger:MAIn:VIDeo:SOUrce	Set or query the video trigger source

Table 2-29: Trigger commands (cont.)

Command	Description
TRIGger:MAIn:VIDeo:STANDard	Set or query the video trigger standard (TBS1000B/EDU, TBS1000, TDS2000C, TDS1000C-EDU, TDS2000B, TDS1000B, TDS2000, TDS1000, TPS2000B, and TPS2000 only)
TRIGger:MAIn:VIDeo:SYNC	Set or query the video trigger sync
TRIGger:STATE?	Return trigger system status

Vertical Commands

Vertical commands control the attributes of the channels. The SElect:<wfm> command also displays a specified waveform or removes it from the display.

Table 2-30: Vertical commands

Command	Description
CH<x>?	Return vertical parameters
CH<x>:BANdwidth	Set or query the channel bandwidth
CH<x>:COUPling	Set or query the channel coupling
CH<x>:CURRENTPRObe	Set or query the scale settings for current probes (TBS1000B/EDU, TBS1000, TDS2000C, TDS1000C-EDU, TDS2000B, TDS1000B, TPS2000B, and TPS2000 only)
CH<x>:INVert	Set or query the channel invert ¹
CH<x>:POSition	Set or query the channel position
CH<x>:PRObe	Set or query the channel probe parameters
CH<x>:SCAlE	Set or query the channel volts/div
CH<x>:VOLts	Same as CH<x>:SCAlE
CH<x>:YUNit	Set or query the units of the specified channel (TBS1000B/EDU, TBS1000, TDS2000C, TDS1000C-EDU, TDS2000B, TDS1000B, TPS2000B, and TPS2000 only)
SElect?	Controls the display of waveforms
SElect:<wfm>	Set or query the waveform display state

¹ All oscilloscope, firmware version, and module combinations except TDS210 and TDS220 with both a firmware version below V 2.00 and a TDS2CMA communications module installed.

Waveform Commands

Waveform commands let you transfer waveform data points to and from the oscilloscope. Waveform data points are a collection of values that define a

waveform. One data value usually represents one data point in the waveform record. When working with peak-detect waveforms, each data value is either the min or max of a min/max pair. Before you can transfer waveform data, you must specify the data format and waveform locations.

Refer to the text following this table for more information about waveform commands.

Table 2-31: Waveform commands

Command	Description
CURVe	Transfer waveform data to or from the oscilloscope
DATa	Set or query the waveform data format and location
DATa:DESTination	Set or query the destination for waveforms sent to the oscilloscope
DATa:ENCdg	Set or query the waveform data encoding method
DATa:SOUrce	Set or query the source of CURVe? data
DATa:STARt	Set or query the starting point in waveform transfer
DATa:STOP	Set or query the ending point in waveform transfer
DATa:TARget	Same as DATa:DESTination
DATa:WIDth	Set or query the byte width of waveform points
WAVFrm?	Return waveform preamble and curve data
WFMPre?	Return waveform preamble
WFMPre:<wfm>?	Return waveform formatting data
WFMPre:BIT_Nr	Set or query the preamble bit width of waveform points
WFMPre:BN_Fmt	Set or query the preamble binary encoding type
WFMPre:BYT_Nr	Set or query the preamble byte width of waveform points
WFMPre:BYT_Or	Set or query the preamble byte order of waveform points
WFMPre:ENCdg	Set or query the preamble encoding method
WFMPre:NR_Pt?	Query the number of points in the curve transfer
WFMPre:<wfm>:NR_Pt?	Return the number of points in the transmitted waveform record
WFMPre:PT_Fmt	Set or query the format of curve points
WFMPre:PT_Off	Query the trigger offset

Table 2-31: Waveform commands (cont.)

Command	Description
WFMPre:WFId?	Query the waveform identifier
WFMPre:XINcr	Set or query the horizontal sampling interval
WFMPre:XUNit	Set or query the horizontal units
WFMPre:XZEro	Set or query the time of first data point in waveform
WFMPre:YMUIt	Set or query the vertical scale factor
WFMPre:YOFf	Set or query the vertical position
WFMPre:YUNit	Set or query the vertical units
WFMPre:YZEro	Set or query the waveform conversion factor (TBS1000B/EDU, TBS1000, TDS2000C, TDS1000C-EDU, TDS2000B, TDS1000B, TDS2000, TDS1000, TPS2000B, TPS2000, and TDS200 with TDS2MM module only.

Waveform Data Formats

Internally, the oscilloscope uses one 8-bit data byte to represent each waveform data point, regardless of the acquisition mode.

The DATA:WIDTH command lets you specify the number of bytes per data point when transferring data to and from an oscilloscope. This provides compatibility with other digitizing oscilloscopes.

When DATA:WIDTH is set to two:

- If sending data, the oscilloscope multiplies each point by 256; the most significant byte then has meaningful data and the least significant byte is 0
- If receiving data, the oscilloscope truncates the data (divides by 256) and saves the most significant byte

NOTE. *The oscilloscopes uses these methods to handle waveforms transmitted in ASCII or binary format.*

The oscilloscope can transfer waveform data in either ASCII or binary format. Use the DATA:ENCdg command to specify one of the following formats:

- ASCII data is represented by signed integer values. The range of values depends on the byte width specified. One-byte-wide data ranges from -128 to 127. Two-byte-wide data ranges from -32768 to 32767.

Each data value requires two to seven characters. This includes one character for the minus sign if the value is negative, one to five ASCII characters for the waveform value, and a comma to separate data points.

An example of an ASCII waveform data string follows:

CURVE<space>-110,-109,-110,-110,-109,-107,-109,-107,
-106,-105,-103,-100,-97,-90,-84,-80

- Binary data can be represented by signed integer or positive integer values. The range of the values depends on the byte width specified.

Table 2-32: Binary data ranges

Byte width	Signed integer range	Positive integer range
1	-128 to 127	0 to 255
2	-32,768 to 32,767	0 to 65,535

The defined binary formats also specify the order in which the bytes are transferred giving a total of four binary formats: RIBinary, RPBinary, SRIBinary, and SRPBinary.

RIBinary is signed integer where the most significant byte is transferred first, and RPBinary is positive integer where the most significant byte is transferred first. SRIBinary and SRPBinary correspond to RIBinary and RPBinary respectively but use a swapped byte order where the least significant byte is transferred first. The byte order is ignored when DATA:WIDTH is set to 1.

Waveform Data Record

You can transfer multiple points for each waveform record. You can transfer a part of the waveform or you can transfer the entire record. The DATA:START and DATA:STOP commands let you specify the first and last data points of the waveform record.

When transferring data into the oscilloscope you must specify the location of the first data point within the waveform record. For example, when DATA:START is set to 1, data points will be stored starting with the first point in the record, and when DATA:START is set to 500, data will be stored starting at the 500th point in the record. The oscilloscope ignores DATA:STOP when reading in data as the oscilloscope will stop reading data when there is no more data to read or when it has reached 2500 data points.

You must specify the first and last data points in the waveform record when transferring data from the oscilloscope to an external device. Setting DATA:START to 1 and DATA:STOP to 2500 always sends the entire waveform, regardless of the acquisition mode.

Waveform Data Locations and Memory Allocation

The DATA:SOURCE command specifies the location of the data when transferring waveforms from the oscilloscope. You can transfer one waveform at a time.

You can transfer only one waveform into the oscilloscope at a time. Each waveform is stored in one of two stored waveform locations for 2-channel models or one of four stored waveform locations for 4-channel models. You specify the stored waveform location with the DATA:DESTINATION command.

NOTE. *The oscilloscope stores waveforms that are ≤ 2500 data points long. The oscilloscope truncates waveforms longer than 2500 data points.*

Waveform Preamble Each waveform that is transferred has an associated waveform preamble that contains information such as the horizontal scale, vertical scale, and other settings in place when the waveform was created. Refer to the [WFMPre?](#) commands for more information about the waveform preamble.

Scaling Waveform Data Once you transfer the waveform data to the controller, you can convert the data points into voltage values for analysis using information from the waveform preamble.

Transferring Waveform Data Data transfer times depend on data format, data width, and the speed of the controller. (See page 4-1, *Programming Examples*.)

From the oscilloscope. To transfer waveforms from the oscilloscope to an external controller, follow these steps:

1. Use the [DATA:SOURce](#) command to select the waveform source.
2. Use the [DATA:ENCdg](#) command to specify the waveform data format.
3. Use the [DATA:WIDth](#) command to specify the number of bytes per data point.
4. Use the [DATA:STARt](#) and [DATA:STOP](#) commands to specify the part of the waveform that you want to transfer.
5. Use the [WFMPre?](#) command to transfer waveform preamble information.
6. Use the [CURVe](#) command to transfer waveform data.

To the oscilloscope. To transfer waveform data to an oscilloscope waveform storage location, follow these steps:

1. Use the [DATA:DESTination](#) command to specify the stored waveform location.
2. Use the [DATA:ENCdg](#) command to specify the waveform data format.
3. Use the [DATA:WIDth](#) command to specify the number of bytes per data point.
4. Use the [DATA:STARt](#) command to specify the first data point in the waveform record.
5. Use the [WFMPre?](#) command to transfer waveform preamble information.
6. Use the [CURVe](#) command to transfer waveform data.

Zoom Commands (TBS1000B/EDU models only)

These commands support the zoom feature.

Table 2-33: Zoom commands

Command	Description
ZOOM?	Returns all zoom parameters (TBS1000B models only)
ZOOM:FACTOR	Sets or queries the zoom factor of a particular zoom box (TBS1000B models only)
ZOOM:HORIZONTAL:POSITION	Sets or queries the horizontal position of a particular zoom box (TBS1000B/EDU models only)
ZOOM:HORIZONTAL:SCALE?	Queries the zoom window current time scale (TBS1000B/EDU models only)
ZOOM:MODE	Sets or queries the zoom mode as SCALE/POSITION (TBS1000B/EDU models only)
ZOOM:STATE	Sets or queries the zoom on/off state (TBS1000B/EDU models only)

Command Descriptions

Commands either set or query oscilloscope values. Some commands both set and query, some only set, and some only query.

Manual Conventions

This manual uses the following conventions:

- No query form exists for commands identified as "No Query Form"
- A question mark (?) appended to the command and "Query Only" indicates query-only commands
- Headers,, mnemonics, and arguments are fully spelled out, with the minimal spelling shown in upper case. For example, to use the abbreviated form of the ACQUIRE:MODE command, just type ACQ:MOD

The syntax of some commands varies, depending on the model of oscilloscope and extension module you use; differences are noted

- Command descriptions list specific oscilloscope series (and module) when commands are valid for only those products

NOTE. While Trigger View is active (when you push the front-panel TRIG VIEW button), the oscilloscope ignores the set form of most commands. If you send a command at this time, the oscilloscope generates execution error 221 (Settings conflict).

ACQUIRE? (Query Only)

Returns current acquisition settings.

Group	Acquisition
Syntax	ACQUIRE?
Returns	Returns current acquisition settings.
Examples	ACQUIRE? might return the following string for the current acquisition: ACQUIRE:STOPAFTER RUNSTOP;STATE 1;MODE SAMPLE;NUMAVG 16

ACQUIRE:MODE

Sets or queries the oscilloscope acquisition mode. This affects all live waveforms and is equivalent to setting the Mode option in the Acquire menu.

Waveforms are the displayed data point values taken from acquisition intervals. Each acquisition interval represents a time duration that is determined by the horizontal scale (time per division).

The oscilloscope sampling system can operate at a rate greater than that indicated by the horizontal scale. Therefore, an acquisition interval can include more than one sample.

The acquisition mode, which you set using this ACQUIRE:MODE command, determines how the final value of the acquisition interval is generated from the many data samples.

Group Acquisition

Syntax ACQUIRE:MODE { SAMPLE | PEAKdetect | AVERAGE }
ACQUIRE:MODE?

Arguments SAMPLE specifies that the displayed data point value is the first sampled value that was taken during the acquisition interval. The waveform data has 8 bits of precision in all acquisition modes. You can request 16 bit data with a CURVE? query, but the lower-order 8 bits of data will be zero. SAMPLE is the default mode.

PEAKdetect specifies the display of the high-low range of the samples taken from a single waveform acquisition. The oscilloscope displays the high-low range as a vertical range that extends from the highest to the lowest value sampled during the acquisition interval. PEAKdetect mode can reveal the presence of aliasing.

AVERAGE specifies averaging mode, where the resulting waveform shows an average of SAMPLE data points from several separate waveform acquisitions. The number of waveform acquisitions that go into making up the average waveform is set or queried using the ACQUIRE:NUMAVG command.

Examples ACQUIRE:MODE PEAKDETECT displays a vertical area representing the range of the highest to lowest value of the acquired signal.

ACQUIRE:MODE? might return SAMPLE.

ACQUIRE:NUMACq? (Query Only)

Indicates the number of acquisitions that have taken place since starting oscilloscope acquisition. The maximum number of acquisitions that can be counted is $2^{31}-1$. This value is reset to zero when you change most Acquisition, Horizontal, Vertical, or Trigger arguments that affect the waveform except for the following:

- Changing the trigger level or trigger holdoff when in Sample or Peak Detect mode does not reset the value

NOTE. Any change made when in Average mode aborts the acquisition and resets ACQUIRE:NUMACq to zero.

- TDS200: changing the vertical position does not reset the value
- TBS1000B/EDU, TBS1000, TDS2000C, TDS1000C-EDU, TDS2000B, TDS1000B, TDS2000, TDS1000, TPS2000B, and TPS2000 Series: if the Trigger mode is set to Auto, and the Horizontal Scale is 10 ms/div or slower, changing the vertical position does not reset the value

NOTE. In Scan mode, ACQUIRE:NUMACq? always returns zero.

Group	Acquisition
Syntax	ACQUIRE:NUMACq?
Returns	<NR1>
Examples	ACQUIRE:NUMACQ? might return 350, indicating that 350 acquisitions took place since an ACQUIRE:STATE RUN command was executed.

ACQUIRE:NUMAVg

Sets the number of oscilloscope waveform acquisitions that make up an averaged waveform. This command is equivalent to setting the Averages option in the Acquire menu.

Group Acquisition

Syntax ACQUIRE:NUMAVG <NR1>
ACQUIRE:NUMAVG?

Arguments <NR1> is the number of waveform acquisitions. Correct values are 4, 16, 64, and 128.

Examples ACQUIRE:NUMAVG 16 specifies that an averaged waveform will show the result of combining 16 separately acquired waveforms.

ACQUIRE:NUMAVG? might return 64, indicating that there are 64 acquisitions specified for averaging.

ACQUIRE:STATE

Starts or stops oscilloscope acquisitions. This command is the equivalent of pressing the front-panel RUN/STOP button. If ACQUIRE:STOPAfter is set to SEQUENCE, other signal events may also stop acquisition.

NOTE. The best way to determine when a single sequence acquisition is complete is to use *OPC rather than ACQUIRE:STATE.

Group Acquisition

Syntax ACQUIRE:STATE { OFF | ON | RUN | STOP | <NR1> }
ACQUIRE:STATE?

Related Commands *OPC

Arguments OFF|STOP|<NR1> = 0 stops acquisitions.

ON|RUN|<NR1> ≠ 0 starts acquisition and display of waveforms. If the command was issued in the middle of an acquisition sequence (for instance averaging), RUN restarts the sequence, discarding any data accumulated before the STOP. It also resets the number of acquisitions.

Examples ACQUIRE:STATE RUN starts acquisition of waveform data and resets the number of acquisitions count (NUMACQ) to zero.

ACQUIRE:STATE? returns 0 or 1, depending on whether the acquisition system is running.

ACQUIRE:STOPAfter

Tells the oscilloscope when to stop taking acquisitions.

Group Acquisition

Syntax ACQUIRE:STOPAfter { RUNSTOP | SEQUENCE}
ACQUIRE:STOPAfter?

Arguments RUNSTOP specifies that the run and stop states should be determined by pressing the front-panel RUN/STOP button or issuing the ACQUIRE:STATE command.

SEQUENCE specifies "single sequence" operation, where the oscilloscope stops after it has acquired enough waveforms to satisfy the conditions of the acquisition mode. For example, if the acquisition mode is set to sample, the oscilloscope stops after digitizing a waveform from a single trigger event. However, if the acquisition mode is set to average 64 waveforms, then the oscilloscope stops only after acquiring all 64 waveforms.

The ACQUIRE:STATE command and the front-panel RUN/STOP button also stop acquisitions when the oscilloscope is in single sequence mode.

Examples ACQUIRE:STOPAFTER RUNSTOP sets the oscilloscope to stop the acquisition when you press the front-panel RUN/STOP button.

ACQUIRE:STOPAFTER? might return SEQUENCE.

ALLEV? (Query Only)

Causes the oscilloscope to return all events and their messages, and removes the returned events from the Event Queue. The messages are separated by commas. Use the *ESR? query to enable the events to be returned. Refer to the *Status and Events* section for a complete description of how to use these registers. This command is similar to repeatedly sending *EVMsg? queries to the oscilloscope.

Group Status and Error

Syntax ALLEV?

Related Commands *CLS, DESE, *ESE, *ESR?, EVENT?, EVMsg?, EVQty?, *SRE, *STB?

Returns The event code and message in the following format:

<Event Code><Comma><QString> [<Comma><Event Code><Comma><QString>...]

<QString> ::= <Message> [<Command>]

<Command> is the command that caused the error and may be returned when a command error is detected by the oscilloscope. As much of the command is returned as possible without exceeding the 60 character limit of the <Message> and <Command> strings combined. The command string is right-justified.

Examples ALLEV? might return the following string: ALLEV 2225, "MEASUREMENT ERROR, NO WAVEFORM TO MEASURE; ", 420, "QUERY UNTERMINATED; "

AUTORange (No Query Form)

Returns current AUTORange settings.

Conditions This command applies to the TBS1000B/EDU, TBS1000, TDS2000C, TDS1000C-EDU, TDS2000B, TDS1000B, TPS2000B, and TPS2000 Series only.

Group Miscellaneous

Syntax AUTORange

Examples AUTORANGE? might return AUTORANGE:SETTINGS BOTH;STATE 1, indicating that Autorange is active and adjusting both the horizontal and vertical settings.

AUTORange:STATE

Toggles Autorange off and on.

Conditions This command applies to the TBS1000B/EDU, TBS1000, TDS2000C, TDS1000C-EDU, TDS2000B, TDS1000B, TPS2000B, and TPS2000 Series only.

Group Miscellaneous

Syntax AUTORange:STATE { OFF | ON | <NR1> }
AUTORange:STATE?

Related Commands [AUTORange:SETTings](#)

Arguments	<p>OFF deactivates the Autorange feature.</p> <p>ON activates the Autorange feature.</p> <p><NR1> = 0 deactivates the Autorange feature.</p> <p><NR1> ≠ 0 activates the Autorange feature.</p>
Examples	<p>AUTORANGE:STATE ON starts the Autorange function.</p> <p>AUTORANGE:STATE? returns 0 or 1, depending on whether the Autorange function is on.</p>

AUTORange:SETTings

Controls the parameters that the Autorange function can adjust. It is equivalent to the option buttons in the Autorange menu.

Conditions	This command applies to the TBS1000B/EDU, TBS1000, TDS2000C, TDS1000C-EDU, TDS2000B, TDS1000B, TPS2000B, and TPS2000 Series only.
Group	Miscellaneous
Syntax	<pre>AUTORange:SETTings { HORizontal VERTical BOTH } AUTORange:SETTings?</pre>
Related Commands	AUTORange:STATE
Arguments	<p>HORizontal allows Autorange to adjust the horizontal, but not vertical, settings.</p> <p>VERTical allows Autorange to adjust the vertical, but not horizontal, settings.</p> <p>BOTH allows Autorange to adjust both the horizontal and vertical settings.</p>
Examples	<p>AUTORANGE:SETTINGS VERTICAL turns on the Autorange vertical settings.</p> <p>AUTORANGE:SETTINGS? might return VERTICAL, indicating that Autorange will only adjust the vertical settings.</p>

AUTOSet (No Query Form)

Causes the oscilloscope to adjust its vertical, horizontal, and trigger controls to display a stable waveform. This command is equivalent to pushing the front-panel

AUTOSET button. For a detailed description of the Autoset function, refer to the user manual for your oscilloscope.

Group Miscellaneous

Syntax AUTOSet EXECute

Arguments EXECute invokes Autoset.

AUTOSet:ENABLE

Allows educators to disable or enable the Autorange and Autoset functions. The function can be manually set from the Service Diag menu. To access the menu, refer to the your product service manual.

Conditions This command applies to the TBS1000, TDS2000C, TDS1000C-EDU, TDS2000B, and TDS1000B Series only. It is not applicable to TBS1000B/EDU models.

Group Miscellaneous

Syntax AUTOSet:ENABLE

AUTOSet:SIGNAL? (Query Only)

Returns the type of signal discovered by the most recent execution of Autoset.

Group Miscellaneous

Syntax AUTOSet:SIGNAL?

Returns LEVEL if the oscilloscope discovered a DC level.
SINE if the oscilloscope discovered a sine-like waveform.
SQUARE if the oscilloscope discovered a square-like waveform.
VIDPAL if the oscilloscope discovered a PAL or SECAM standard video signal.
VIDNTSC if the oscilloscope discovered an NTSC standard video signal.

OTHER if the oscilloscope was unable to classify the signal.

NONE if the AUTOSET menu is not displayed.

AUTOSet:VIEW (No Query Form)

If the current menu is not the Autoset menu, or if the view is not valid for the detected waveform, the set command causes the oscilloscope to generate error 221 (Settings conflict).

Conditions	This command applies to the TBS1000B/EDU, TBS1000, TDS2000C, TDS1000C-EDU, TDS2000B, TDS1000B, TDS2000, TDS1000, TPS2000B, and TPS2000 Series only.
Group	Miscellaneous
Syntax	AUTOSet:VIEW { MULTICYCLe SINGLECYCLe FFT RISINGedge FALLINGedge FIELD ODD EVEN LINE LINENum DCLINE DEFault NONE }
Arguments	<p>MULTICYCLe displays a sine or square wave of several cycles. Default for sine-like and square-like signals.</p> <p>SINGLECYCLe displays a sine or square wave of approximately one cycle.</p> <p>FFT displays the FFT of a sine wave.</p> <p>RISING displays the rising edge of a square wave.</p> <p>FALLING displays the falling edge of a square wave.</p> <p>FIELD displays a video signal synchronized on all fields. This is the default for video signals.</p> <p>ODD displays a video signal synchronized on odd fields.</p> <p>EVEN displays a video signal synchronized on even fields.</p> <p>LINE displays a video signal synchronized on all lines.</p> <p>LINENum displays a video signal synchronized on the specified line number.</p> <p>DCLINE returns a query response when the oscilloscope finds a DC level.</p> <p>DEFault returns a query response when the oscilloscope cannot determine the signal type.</p> <p>NONE returns a query response when the AUTOSET menu is not displayed. Set is ignored.</p>

Examples AUTOSET:VIEW EVEN will display video signals synchronized on even fields when operated in autose mode.

BUSY? (Query Only)

Returns the status of the oscilloscope. This command allows you to synchronize the operation of the oscilloscope with your application program. (See page 3-7, *Synchronization Methods*.)

Certain oscilloscope operations can affect the BUSY? response. (See Table 3-3 on page 3-7.)

Group Status and Error

Syntax BUSY?

Related Commands *OPC, *WAI

Returns <NR1> = 0 means the oscilloscope is not busy processing a command whose execution time is extensive.
<NR1> = 1 means the oscilloscope is busy processing a command whose execution time is extensive. (See Table 3-3 on page 3-7.)

Examples BUSY? might return :BUSY 1 indicating that the oscilloscope is now busy.

*CAL? (Query Only)

Performs an internal self-calibration and returns its status. This is equivalent to selecting the Do Self Cal option in the Utility menu. Although *CAL? is a query command, it does perform an action.

NOTE. *The self-calibration can take several minutes to complete. During this time, the oscilloscope does not execute any commands.*

Disconnect all signals from the oscilloscope before performing an internal self-calibration.

Group Calibration and Diagnostic

Syntax *CAL?

Related Commands [CALibrate:INTERNAL](#)

Returns 0 indicates that the self-calibration completed without any errors detected.
Any value other than zero indicates that the self-calibration did not complete successfully or completed with errors.

Examples *CAL? performs a self-calibration and might return 0 to indicate that it completed successfully.

CALibrate:ABOrt (No Query Form)

***NOTE.** You should only use this command in a qualified service environment. For more information about the factory calibration sequence, refer to the service manual for your oscilloscope.*

Aborts the factory calibration process. When you abort the factory calibration, the oscilloscope restores the calibration settings to the previous factory calibration constants stored in nonvolatile memory.

Group Calibration and Diagnostic

Syntax CALibrate:ABOrt

Examples CALIBRATE:ABORTstops the in-process factory calibration procedure.

CALibrate:CONTINUE (No Query Form)

***NOTE.** You should only use this command in a qualified service environment. For more information about the factory calibration sequence, refer to the service manual for your oscilloscope.*

Performs the next step in the factory calibration operation.

Group Calibration and Diagnostic

Syntax CALibrate:CONTINUE

Examples CALIBRATE:CONTINUE performs the next step in the factory calibration operation.

CALibrate:FACTory (No Query Form)

NOTE. *You should only use this command in a qualified service environment. For more information about the factory calibration sequence, refer to the service manual for your oscilloscope.*

Starts the oscilloscope internal factory calibration operation. The calibration operation consists of a sequence of steps. You send the CALibrate:CONTINUE command to advance to the next calibration step. The calibration program automatically sets up the oscilloscope for each calibration step. Use the CALibrate:ABOrt command to abort the factory calibration.

You can only send synchronization commands or queries (such as *OPC, OPC, *WAI, BUSY) while doing a factory calibration.

Group Calibration and Diagnostic

Syntax CALibrate:FACTory

Examples CALIBRATE:FACTORY starts the factory calibration process.

CALibrate:INTERNAL (No Query Form)

Performs an internal self-calibration but does not return any status. This is equivalent to selecting the Do Self Cal option in the Utility menu.

NOTE. *The self-calibration can take several minutes to complete. During this time, the oscilloscope does not execute any commands.*

Disconnect all signals from the oscilloscope before performing an internal self-calibration.

Group Calibration and Diagnostic

Syntax CALibrate:INTERNAL

Related Commands *CAL?

Examples CALIBRATE:INTERNAL performs an internal self-calibration.

CALibrate:STATUS? (Query Only)

Returns the status of the last calibration operation performed (either self- or factory-calibration) since power on.

Group Calibration and Diagnostic

Syntax CALibrate:STATUS?

Returns PASS indicates that the oscilloscope completed the last calibration operation without detecting any errors.

FAIL indicates that the oscilloscope detected errors during the last calibration operation, or that no calibration operations have been performed since power on.

Examples CALIBRATE:STATUS? might return CALIBRATE:STATUS FAIL, if the oscilloscope failed the last calibration operation.

CH<x>? (Query Only)

Returns the current oscilloscope vertical settings. The value of <x> can vary from 1 through 4 for 4-channel instruments or 1 through 2 for 2-channel instruments.

Because CH<x>:SCALE and CH<x>:VOLts are identical, only CH<x>:SCALE is returned.

Group Vertical

Syntax CH<x>?

Related Commands SElect:<wfm>

Returns Oscilloscope vertical settings.

Examples CH1? might return the following string for channel 1: CH1:SCALE 1.0E0;POSITION 0.0E0; COUPLING DC;BANDWIDTH OFF;PROBE 1.0E0

CH<x>:BANDwidth

Sets or queries the bandwidth setting of the specified oscilloscope channel. The value of <x> can vary from 1 through 4 for 4-channel instruments or 1 through 2 for 2-channel instruments.

This command is equivalent to setting the BW Limit option in the Vertical menu.

Group Vertical

Syntax CH<x>:BANDwidth { ON | OFF }
CH<x>:BANDwidth?

Arguments ON sets the channel bandwidth to 20 MHz.

OFF sets the channel bandwidth to the full bandwidth of the oscilloscope.

In most acquisition modes, full bandwidth is 40 MHz, 50 MHz, 60 MHz, 70 MHz, 100 MHz, or 200 MHz (depending on the oscilloscope model). There are exceptions:

- For TBS1000B/EDU, TBS1000, TDS2000C, TDS1000C-EDU, TDS2000B, TDS1000B, TDS2000, TDS1000, TPS2000B, and TPS2000 Series: At vertical scales from 2.00 to 4.99 mV/div (sensitivity at the BNC; that is, after the probe factor is removed), the full bandwidth is 20 MHz.
- For TDS200 Series: At vertical scales of 5 mV/div or less (sensitivity at the BNC; that is, after the probe factor is removed), the full bandwidth is 20 MHz. When the acquisition mode is Peak Detect, and the vertical scale at the BNC is 10 mV/div or less, the full bandwidth is also 20 MHz.

Examples CH2:BANDWIDTH ON sets the bandwidth of channel 2 to 20 MHz.

CH1:BANDWIDTH? might return OFF. This indicates there is no bandwidth limiting on channel 1.

CH<x>:COUPLing

Sets or queries the input attenuator coupling setting of the specified oscilloscope channel. The value of <x> can vary from 1 through 4 for 4-channel instruments or 1 through 2 for 2-channel instruments.

This command is equivalent to setting the Coupling option in the Vertical menu.

Group	Vertical
Syntax	CH<x>:COUPLing { AC DC GND } CH<x>:COUPLing?
Arguments	AC sets the specified oscilloscope channel to AC coupling. DC sets the specified oscilloscope channel to DC coupling. GND sets the specified oscilloscope channel to ground. Only a flat ground-level waveform is displayed.
Examples	CH1:COUPLING AC establishes AC coupling on channel 1. CH2:COUPLING? might return DC. Indicating that channel 2 is set to DC coupling.

CH<x>:CURRENTPRObe

Sets or queries the scale factor of the specified channel for current probes. The value of <x> can vary from 1 through 4 for 4-channel instruments or 1 through 2 for 2-channel instruments.

You can issue this command when CH<x>:YUNit <QString> is set to V. However, this command only affects the readouts when CH<x>:YUNit <QString> is set to A.

Conditions	This command applies to the TBS1000B/EDU, TBS1000, TDS2000C, TDS1000C-EDU, TDS2000B, TDS1000B, TPS2000B, and TPS2000 Series only.
Group	Vertical
Syntax	CH<x>:CURRENTPRObe {0.2 1 2 5 10 50 100 1000} CH<x>:CURRENTPRObe?

Arguments 0.2 sets the specified oscilloscope channel to 0.2X attenuation.
 1 sets the specified oscilloscope channel to 1X attenuation.
 2 sets the specified oscilloscope channel to 2X attenuation.
 5 sets the specified oscilloscope channel to 5X attenuation.
 10 sets the specified oscilloscope channel to 10X attenuation.
 50 sets the specified oscilloscope channel to 50X attenuation.
 100 sets the specified oscilloscope channel to 100X attenuation.
 1000 sets the specified oscilloscope channel to 1000X attenuation.

Returns <NR1>

Examples CH2:CURRENTPROBE 1000 sets channel 2 to 1000X attenuation.
 CH1:CURRENTPROBE? might return 10.

CH<x>:INVert

NOTE. *You cannot use this command with a TDS210 or TDS220 oscilloscope with firmware below V 2.00 and a TDS2CMA (or TDS2CM) communications module.*

Sets or queries the inversion state of the specified oscilloscope channel. The value of <x> can vary from 1 through 4 for 4-channel instruments or 1 through 2 for 2-channel instruments.

This command is equivalent to setting the Invert option in the Vertical channel menus.

Group Vertical

Syntax CH<x>:INVert { ON | OFF }
 CH<x>:INVert?

Arguments ON inverts the specified oscilloscope channel.
 OFF sets the specified oscilloscope channel to noninverted.

Examples CH1:INVERT ON inverts the signal on channel 1.
 CH2:INVERT? might return OFF, indicating that channel 2 is not inverted.

CH<x>:POSition

Sets or queries the vertical position of the specified oscilloscope channel. The value of <x> can vary from 1 through 4 for 4-channel instruments or 1 through 2 for 2-channel instruments.

The position voltage value is applied to the signal before digitization. This command is equivalent to adjusting the front-panel VERTICAL POSITION knob.

Group Vertical

Syntax CH<x>:POSition <NR3>
 CH<x>:POSition?

Arguments <NR3> is the position in divisions from the center graticule.

Table 2-34: Vertical position ranges using a 1X probe

Vertical position	Range
2 mV/div	±1000 divs
5 mV/div	±400 divs
10 mV/div	±200 divs
20 mV/div	±100 divs
50 mV/div	±40 divs
100 mV/div	±20 divs
200 mV/div	±10 divs
500 mV/div	±100 divs
1 V/div	±50 divs
2 V/div	±25 divs
5 V/div	±10 divs

Examples CH2:POSITION 1.32E0 positions the channel 2 input signal 1.32 divisions above the center of the display.
 CH1:POSITION? might return -1.32E0, indicating that the current position of channel 1 is at -1.32 divisions.

CH<x>:PRObe

Sets or queries the attenuation factor of the specified channel or voltage probes. The value of <x> can vary from 1 through 4 for 4-channel instruments or 1 through 2 for 2-channel instruments.

Group Vertical

Syntax CH<x>:PRObe { 1 | 10 | 20 | 50 | 100 | 500 | 1000 }
CH<x>:PRObe?

Arguments

- 1 sets the specified oscilloscope channel to 1X attenuation.
- 10 sets the specified oscilloscope channel to 10X attenuation.
- 20 sets the specified oscilloscope channel to 20X attenuation. (TBS1000B/EDU, TBS1000, TDS2000C, TDS1000C-EDU, TDS2000B, TDS1000B, TPS2000B, and TPS2000 Series only)
- 50 sets the specified oscilloscope channel to 50X attenuation. (TBS1000B/EDU, TBS1000, TDS2000C, TDS1000C-EDU, TDS2000B, TDS1000B, TPS2000B, and TPS2000 Series only)
- 100 sets the specified oscilloscope channel to 100X attenuation.
- 500 sets the specified oscilloscope channel to 500X attenuation. (TBS1000B/EDU, TBS1000, TDS2000C, TDS1000C-EDU, TDS2000B, TDS1000B, TPS2000B, and TPS2000 Series only)
- 1000 sets the specified oscilloscope channel to 1000X attenuation.

Returns <NR1>

Examples CH2:PROBE 1000 sets channel 2 to 1000X attenuation.
CH1:PROBE? might return CH1:PROBE 10.

CH<x>:SCAle

Sets or queries the vertical gain of the specified oscilloscope channel. The value of <x> can vary from 1 through 4 for 4-channel instruments or 1 through 2 for 2-channel instruments.

This command is equivalent to adjusting the front-panel VOLTS/DIV knob.

Group	Vertical
Syntax	CH<x>:SCALE <NR3> CH<x>:SCALE?
Related Commands	CH<x>:VOLts
Arguments	<NR3> is the gain, in volts or amps per division. For example, the voltage range is 5 V/div to 2 mV/div when using a 1X voltage probe.
Examples	CH1:SCALE 100E-3 sets the channel 1 gain to 100 mV/div. CH2:SCALE? might return 1.0E0 , indicating that the current V/div setting of channel 2 is 1 V/div.

CH<x>:VOLts

Sets or queries the vertical gain of the specified channel. The value of <x> can vary from 1 through 4 for 4-channel instruments or 1 through 2 for 2-channel instruments.

This command is identical to the CH<x>:SCALE command and is included for compatibility purposes. Only CH<x>:SCALE is returned in response to a CH<x>? query.

Group	Vertical
Syntax	CH<x>:VOLts

CH<x>:YUNit

Sets or queries the units of the specified channel. The value of <x> can vary from 1 through 4 for 4-channel instruments or 1 through 2 for 2-channel instruments.

Conditions This command applies to the TBS1000B/EDU, TBS1000, TDS2000C, TDS1000C-EDU, TDS2000B, TDS1000B, TPS2000B, and TPS2000 Series only.

Group	Vertical
--------------	----------

Syntax CH<x>:YUNIT <QString>
CH<x>:YUNIT?

Arguments <QString> is either "V" for volts or "A" for amps. This is equivalent to setting the probe to Voltage or Current in the probe front-panel menu. This command is case insensitive.

Examples CH2:YUNIT might return CH2:YUNIT "V", indicating that the channel 2 units are volts.

*CLS (No Query Form)

The *CLS command clears the following oscilloscope status data structures:

- The Event Queue
- The Standard Event Status Register (SESR)
- The Status Byte Register (except the MAV bit)

If the *CLS command immediately follows an <EOI>, the Output Queue and MAV bit (Status Byte Register bit 4) are also cleared. MAV indicates information is in the output queue. The device clear (DCL) GPIB control message and the USBTMC INITIATE_CLEAR control message will clear the output queue and also MAV.

*CLS does not clear the output queue or MAV. *CLS can suppress a service request that is to be generated by an *OPC command. This will happen if a hard copy output or single sequence acquisition operation is still being processed when the *CLS command is executed. (See page 3-1, *Registers*.)

Group Status and Error

Syntax *CLS

Related Commands [DESE](#), [*ESE](#), [*ESR?](#), [EVENT?](#), [EVMsg?](#), [*SRE](#), [*STB?](#)

COUNTERFreq? (Query Only)

Returns all counter frequency parameters.

Group Counter

Syntax COUNTERFreq?

COUNTERFreq:CH1Level

Sets or queries the CH1 trigger level value.

Group Counter

Syntax COUNTERFreq:CH1Level <x>
COUNTERFreq:CH1Level?

COUNTERFreq:CH1State

Sets or queries the CH1 counter frequency to be on or off.

Group Counter

Syntax COUNTERFreq:CH1State { OFF | ON | 1 | 0 }
COUNTERFreq:CH1State?

Examples COUNTERFreq:CH1State OFF turns off the CHQ counter frequency feature.

COUNTERFreq:CH1Value? (Query Only)

Returns the CH1 counter frequency value.

Group Counter

Syntax COUNTERFreq:CH1Value?

COUNTERFreq:CH2Level

Sets or queries the CH2 trigger level value.

Group Counter

Syntax COUNTERFreq:CH2Level <x>
COUNTERFreq:CH2Level?

COUNTERFreq:CH2State

Sets or queries the CH2 counter frequency to be on or off.

Group Counter

Syntax COUNTERFreq:CH2State { OFF | ON | 1 | 0 }
COUNTERFreq:CH2State?

Examples COUNTERFreq:CH2State ON turns on the CHQ counter frequency feature.

COUNTERFreq:CH2Value? (Query Only)

Returns the CH2 counter frequency value.

Group Counter

Syntax COUNTERFreq:CH2Value?

CURSOr? (Query Only)

Returns current cursor settings.

Group Cursor

Syntax CURSOr?

Returns Oscilloscope cursor settings.

Examples CURSOR? might return the following string as the current cursor settings: CURSOR:FUNCTION VBARS;SELECT:SOURCE CH1; CURSOR:VBARS:UNITS SECONDS;POSITION1 0.0E0;POSITION2 4.48E-3;:CURSOR:HBARS:UNITS VOLTS;POSITION1 0.0E0;POSITION2 5.0E-1.

CURSor:FUNCtion

Selects and displays the oscilloscope cursor type. Cursors are attached to the waveform selected by CURSor:SElect:SOUrce. This command is equivalent to setting the Type option in the Cursor menu. Setting the function to anything other than OFF causes the Cursor menu to be displayed.

NOTE. *Setting the display format to XY removes the cursors. Sending the CURSor:FUNCtion command when the display format is XY causes the oscilloscope to generate event 221 (Settings conflict) and leaves the display in XY format.*

Group	Cursor
Syntax	CURSor:FUNCtion { HBArS OFF VBArS } CURSor:FUNCtion?
Arguments	<p>HBArS specifies horizontal bar cursors that measure the vertical units in volts, amps, divisions, or decibels.</p> <p>OFF removes cursors from the display.</p> <p>VBArS specifies vertical bar cursors that measure time or frequency.</p>
Examples	CURSOR:FUNCTION VBARS selects vertical bar type cursors.

CURSor:HBArS? (Query Only)

Returns the settings for the oscilloscope horizontal bar cursors.

Group	Cursor
Syntax	CURSor:HBArS?
Returns	Current horizontal bar cursor settings.
Examples	CURSOR:HBARS? might return the following string: CURSOR:HBARS:UNITS VOLTS;POSITION1 0.0E0; POSITION2 0.0E0.

CURSor:HBARs:DELTA? (Query Only)

Returns the difference (in vertical units) between the two horizontal bar cursors in the oscilloscope display.

NOTE. *If Trigger View is active, this query returns 9.9E37 and generates event 221 (Settings conflict).*

Group	Cursor
Syntax	CURSor:HBARs:DELTA?
Returns	<NR3>
Examples	CURSOR:HBARS:DELTA? might return 5.08E0 for the difference between the two cursors.

CURSor:HBARs:POSITION<x>

Positions a horizontal bar cursor. The value of <x> can vary from 1 through 2.

NOTE. *If Trigger View is active, the query form returns 9.9E37 and generates event 221 (Settings conflict).*

Group	Cursor
Syntax	CURSor:HBARs:POSITION<x> <NR3> CURSor:HBARs:POSITION<x>?
Arguments	<p><NR3> specifies the horizontal bar cursor position, relative to ground (in volts when the units are volts and amps when the units are amps), relative to the center of the screen (in divs when units are divisions), or relative to 1 V RMS (in decibels when the source is an FFT math waveform), for the waveform specified by the CURSor:SELEct:SOURce command.</p> <p>The cursor position is limited to the graticule whenever an attempt is made to move it outside the graticule.</p>

NOTE. *The source always determines the measurement units.*

Examples `CURSOR:HBARS:POSITION1 25.0E-3` positions one of the horizontal cursors at 25.0 mV (assuming the vertical units are volts).

`CURSOR:HBARS:POSITION2` might return `-6.40E-2`, indicating that the second horizontal bar cursor is at -64.0 mV (assuming the vertical units are volts).

CURSor:HBARs:UNIts? (Query Only)

Returns the vertical scale units for the selected cursor source waveform.

Group Cursor

Syntax `CURSOR:HBARS:UNITS?`

Returns `VOLTS` indicates volts from ground as the unit of measure.

`DIVS` indicates divisions as the unit of measure, with center of screen as 0 divisions and bottom of screen as -4 divisions.

`DECIBELS` indicates decibels as the unit of measure, relative to a 1 V_{rms} sine wave. (FFT only)

`UNKNOWN` indicates that Trigger View is active. This also generates event message 221. (Settings conflict)

`AMPS` indicates amperes as the unit of measure. (TBS1000B/EDU, TBS1000, TDS2000C, TDS1000C-EDU, TDS2000B, TDS1000B, TPS2000B, and TPS2000 Series only)

`VOLTSSQUARED` indicates volts squared (V^2) as the unit of measure. (TBS1000B/EDU, TBS1000, TDS2000C, TDS1000C-EDU, TDS2000B, TDS1000B, TPS2000B, and TPS2000 Series only)

`AMPSSQUARED` indicates amperes squared (A^2) as the unit of measure. (TBS1000B/EDU, TBS1000, TDS2000C, TDS1000C-EDU, TDS2000B, TDS1000B, TPS2000B, and TPS2000 Series only)

`VOLTSAMPS` indicates voltage times current ($V \cdot A$) as the unit of measure. (TBS1000B/EDU, TBS1000, TDS2000C, TDS1000C-EDU, TDS2000B, TDS1000B, TPS2000B, and TPS2000 Series only)

NOTE. *Unknown units are represented by "" in the oscilloscope readouts.*

Examples `CURSOR:HBARS:UNITS?` might return `CURSOR:HBARS:UNITS VOLTS`.

CURSor:SElect:SOUrce

Sets or queries the waveform that is the source of the vertical and horizontal scale factors used in determining cursor values. This command is equivalent to setting the Source option in the Cursor menu.

Group	Cursor
Syntax	CURSor:SElect:SOUrce <wfm> CURSor:SElect:SOUrce?
Arguments	<wfm> specifies the waveform data source on which cursor measurements will be taken.
Examples	CURSOR:SELECT:SOURCE CH1 selects channel 1. CURSOR:SELECT:SOURCE? might return MATH.

CURSor:VBArS? (Query Only)

Returns the current vertical bar cursor horizontal position and units settings.

Group	Cursor
Syntax	CURSor:VBArS?
Examples	CURSOR:VBARS? might return CURSOR:VBARS:UNITS SECONDS; POSITION1 1.00E-6; POSITION2 9.00E-6.

CURSor:VBArS:DELTA? (Query Only)

Returns the time or frequency difference between the two vertical bar cursors. The units (seconds or Hertz) are specified by the CURSor:VBArS:UNIts command. If the cursor source is an FFT math waveform, CURSor:VBArS:DELTA is always in Hertz, regardless of the value set by CURSor:VBArS:UNIts.

NOTE. *If Trigger View is active, this query returns 9.9E37 and generates event 221 (Settings conflict).*

Group	Cursor
Syntax	CURSOR:VBARS:DELTA?
Returns	<NR3>
Examples	CURSOR:VBARS:DELTA? might return 8.92E-1, indicating that the time difference between the vertical bar cursors is 0.892 seconds.

CURSOR:VBARS:HDELTA? (Query Only)

Returns the time or frequency difference between the two vertical bar cursors. The units (seconds or Hertz) are specified by the CURSOR:VBARS:UNITS command. If the cursor source is an FFT math waveform, CURSOR:VBARS:DELTA is always in Hertz, regardless of the value set by CURSOR:VBARS:UNITS.

The command is identical to the CURSOR:VBARS:DELTA query. It is included for compatibility with the TDS3000 Series.

NOTE. *If Trigger View is active, this query returns 9.9E37 and generates event 221 (Settings conflict).*

Conditions	This command applies to the TBS1000B/EDU, TBS1000, TDS2000C, TDS1000C-EDU, TDS2000B, TDS1000B, TPS2000B, and TPS2000 Series only.
Group	Cursor
Syntax	CURSOR:VBARS:HDELTA?
Returns	<NR3>
Examples	CURSOR:VBARS:HDELTA? might return 8.92E-1, indicating that the time difference between the vertical bar cursors is 0.892 seconds.

CURSOR:VBARS:HPOS<x>? (Query Only)

Returns the waveform amplitude at the specified cursor position. The units are specified by the CURSOR:HBARS:UNITS query. <x> specifies the cursor. Valid values are 1 and 2.

Conditions	This command applies to the TBS1000B/EDU, TBS1000, TDS2000C, TDS1000C-EDU, TDS2000B, TDS1000B, TPS2000B, and TPS2000 Series only.
Group	Cursor
Syntax	CURSOR:VBARS:HPOS<x>?
Related Commands	CURSOR:HBArs:UNIts?
Returns	<NR3> indicates the amplitude value at the selected position.
Examples	CURSOR:VBARS:HPOS1? might return 1.37, indicating the value of one vertical bar tic.

CURSOR:VBARS:POSITION<x>

Positions a vertical bar cursor. The unit is specified by the CURSOR:VBARS:UNIts command, and can be in units of seconds or frequency (Hertz). If the cursor source is an FFT math waveform, CURSOR:VBARS:POSITION is always in Hertz, regardless of the value set by CURSOR:VBARS:UNIts.

NOTE. *If Trigger View is active, the query form returns 9.9E37 and generates event 221 (Settings conflict).*

Group	Cursor
Syntax	CURSOR:VBARS:POSITION<x> <NR3> CURSOR:VBARS:POSITION<x>?
Arguments	<x> specifies which cursor to position. Correct values are 1 and 2. <NR3> specifies the cursor position in the units specified by the CURSOR:VBARS:UNIts command. The position is relative to the trigger except when the cursor source is a math FFT waveform. The cursor position is limited to the graticule whenever an attempt is made to move it outside the graticule.
Examples	CURSOR:VBARS:POSITION2 9.00E-6 positions the second vertical bar cursor at 9ms.

`CURSOR:VBARS:POSITION1?` might return `1.00E-6`, indicating the first vertical bar cursor is at 1 μ s.

CURSOR:VBARS:SLOPE? (Query Only)

Returns the change in amplitude divided by the change in time, as measured between the two cursors. The units are derivable from the `CURSOR:HBars:UNITS` and `CURSOR:VBARS:UNITS` queries.

Conditions	This command applies to the TPS2000B/TPS2000 Series with TPS2PWR1 Power Analysis Module only.
Group	Cursor
Syntax	<code>CURSOR:VBARS:SLOPE?</code>
Examples	<code>CURSOR:VBARS:SLOPE?</code> might return <code>1.22E3</code> , indicating the slope measured between Vertical Cursor 1 and Vertical Cursor 2.

CURSOR:VBARS:UNITS

Sets or queries the units for the vertical bar cursors.

NOTE. *When Trigger View is active, `CURSOR:VBARS:UNITS?` generates event 221(Settings conflict).*

Group	Cursor
Syntax	<code>CURSOR:VBARS:UNITS { SECONDS HERTZ }</code> <code>CURSOR:VBARS:UNITS?</code>
Arguments	<code>SECONDS</code> specifies units of time. <code>HERTZ</code> specifies units of frequency (reciprocal of time).
Examples	<code>CURSOR:VBARS:UNITS SECONDS</code> sets the units for the vertical bar cursors to seconds. <code>CURSOR:VBARS:UNITS?</code> returns <code>HERTZ</code> when the vertical bar cursor units are Hertz.

CURSOR:VBARS:VDELTA? (Query Only)

Returns the vertical (amplitude) difference between the two vertical bar cursors. The units are specified by the CURSOR:HBars:UNits query.

Conditions	This command applies to the TBS1000B/EDU, TBS1000, TDS2000C, TDS1000C-EDU, TDS2000B, TDS1000B, TPS2000B, and TPS2000 Series only.
Group	Cursor
Syntax	CURSOR:VBARS:VDELTA?
Returns	<NR3> indicates the vertical difference between the two vertical bar cursors.
Examples	CURSOR:VBARS:VDELTA? might return 1.064E+0, indicating that the vertical difference between the vertical bar cursor ticks is 1.064 units.

CURVe

Transfers oscilloscope waveform data to and from the oscilloscope in binary or ASCII format. Each waveform that is transferred has an associated waveform preamble that contains information such as data format and scale. For information about the waveform preamble, refer to [WFMPre?](#). The data format is specified by the [DATA:ENCdg](#) and [DATA:WIDth](#) commands.

The CURVe? query sends data from the oscilloscope to an external device. The data source is specified by the DATA:SOURce command. The first and last data points that are transferred are specified by the DATA:STARt and DATA:STOP commands.

NOTE. *If the waveform specified by the DATA:SOURce command is not displayed, the CURVe? query returns nothing, and generates events 2244 (Waveform requested is not activated) and 420 (Query UNTERMINATED).*

In Scan Mode (Sec/div \geq 100 ms and AUTO Mode), approximately one division of data points will be invalid due to the blanked moving cursor.

The CURVe set command sends waveform data from an external device to the oscilloscope. The data is stored in the stored waveform location specified by DATA:DESTination, starting with the data point specified by DATA:STARt. Only one waveform can be transferred at a time. The waveform will only be displayed if the reference waveform is displayed.

Refer to *Waveform Commands* for a description of the waveform transfer process. (See page 2-32.)

Group Waveform

Syntax CURVE { <Block> | <asc curve> }
CURVE?

Related Commands [DATA](#)

Arguments <Block> is the waveform data in binary format. The waveform is formatted as: #<x><yyy><data> where <x> is the number of characters in <yyy>. For example, if <yyy> = 500, then <x> = 3, where <yyy> is the number of bytes to transfer. Refer to *Block Arguments*

If width is 1, then all bytes on the bus are single data points. If width is 2, then all bytes on the bus are 2-byte pairs. Use the DATA:WIDTH command to set the width. <data> is the curve data.

<asc curve> is the waveform data in ASCII format. The format for ASCII data is <NR1>[,<NR1>...] where each <NR1> represents a data point.

Examples CURVE might return the following ASCII data:

```
CURVE 13,6,3,2,-1,-9,-14,-19,-29,-35,-67,-1,-78,-62,
-50,-31,-27,-7,0,12,29,39,45,43,41,47,41,38,33,26
```

DATA

Sets or queries the format and location of the waveform data that is transferred with the CURVE command. Since DATA:DESTINATION and DATA:TARGET are equivalent, only DATA:DESTINATION is returned by the DATA? query.

Group Waveform

Syntax DATA { INIT }
DATA?

Related Commands [CURVE](#)

Arguments INIT reinitializes the waveform data settings to their factory defaults.

Examples DATA INIT reinitializes the waveform data settings to their factory defaults:
 DESTINATION = REFA (=TARGET) ENCDG = RIBINARY SOUrcE = CH1
 START = 1 STOP = 2500 WIDTH = 1
 DATA? might return the following string: DATA:ENCDG
 RPBINARy;DESTINATION REFA; SOURCE REFB;START 1;STOP
 500;WIDTH 2

DATA:DESTination

Sets or queries the reference memory location for storing oscilloscope waveform data that is transferred into the oscilloscope by the CURVe command. This command is identical to the DATA:TARget command.

Group Waveform

Syntax DATA:DESTination REF<x>
 DATA:DESTination?

Related Commands [CURVe](#)

Arguments REF<x> is the reference memory location where the waveform will be stored.

Examples DATA:DESTINATION REFA stores incoming waveform data into reference memory REFA.
 DATA:DESTINATION? might return REFB as the waveform location that is currently selected.

DATA:ENCdg

Sets or queries the format of the waveform data. This command is equivalent to setting WFMPre:ENCdg, WFMPre:BN_Fmt, and WFMPre:BYT_Or. (See Table 2-35.)

Setting the DATA:ENCdg value causes the corresponding WFMPre values to update. Setting the WFMPre value causes the corresponding DATA:ENCdg values to update.

Group Waveform

Syntax DATA:ENCdg { ASCIi | RIBinary | RPBinary | SRIBinary | SRPbinary }
DATA:ENCdg?

Related Commands [WFMPre:ENCdg](#), [WFMPre:BN_Fmt](#)

Arguments ASCIi specifies the ASCII representation of signed integer (RIBinary) data. If this is the value at power-on, the WFMPre values for BN_Fmt, BYT_Or, and ENCdg are set as RP, MSB, and ASC respectively.

RIBinary specifies signed integer data-point representation with the most significant byte transferred first. This format results in the fastest data transfer rate when DATA:WIDTH is set to 2.

The range is -128 to 127 when DATA:WIDTH is 1. Zero is center screen. The range is -32768 to 32767 when DATA:WIDTH is 2. The upper limit is one division above the top of the screen and the lower limit is one division below the bottom of the screen.

RPBinary specifies positive integer data-point representation with the most significant byte transferred first.

The range is 0 to 255 when DATA:WIDTH is 1. Center screen is 127. The range is 0 to 65,535 when DATA:WIDTH is 2. The upper limit is one division above the top of the screen and the lower limit is one division below the bottom of the screen.

SRIBinary is the same as RIBinary except that the byte order is swapped, meaning that the least significant byte is transferred first. This format is useful when transferring data to IBM compatible PCs.

SRPbinary is the same as RPBinary except that the byte order is swapped, meaning that the least significant byte is transferred first. This format is useful when transferring data to IBM compatible PCs.

Table 2-35: DATA and WFMPre parameter settings

DATA:ENCdg setting	WFMPre settings		
	:ENCdg	:BN_Fmt	:BYT_Or
ASCLi	ASC	N/A	N/A
RIBinary	BIN	RI	MSB
RPBinary	BIN	RP	MSB
SRIBinary	BIN	RI	LSB
SRPbinary	BIN	RP	LSB

Examples DATA:ENCDG RPBINARY sets the data encoding format to be positive integer where the most significant byte is transferred first.

DATA:ENCDG? might return SRPBINARY for the format of the waveform data.

DATA:SOURce

Sets or queries which waveform will be transferred from the oscilloscope by the CURVe, WFMPre, or WAVFrm? queries. You can transfer only one waveform at a time.

Group Waveform

Syntax DATA:SOURce <wfm>
DATA:SOURce?

Related Commands [CURVe](#), [WFMPre?](#)

Arguments <wfm> is the location of the waveform data that will be transferred from the oscilloscope to the external device. Allowable values are CH<x>, MATH, and REF<x>. For TBS1000B/EDU models, FFT is also permitted.

Examples DATA:SOURCE REFB specifies that reference waveform REFB will be transferred in the next CURVe? query.

DATA:SOURCE? might return REFA, indicating the source for the waveform data that is transferred using the CURVe? command.

DATA:START

Sets or queries the starting data point for waveform data transfers. This command lets you transfer partial waveforms to and from the oscilloscope.

Group Waveform

Syntax DATA:START <NR1>
DATA:START?

Related Commands [CURVe](#)

Arguments <NR1> is an integer value that ranges from 1 to 2500, and specifies the first data point that will be transferred. Data is transferred from <NR1> to DATA:STOP or 2500, whichever is less. When DATA:STOP is less than DATA:START, the values are swapped internally for CURVe.

Examples DATA:START 10 specifies that the waveform transfer will begin with data point 10.
DATA:START? might return 214 as the first waveform data point that will be transferred.

DATA:STOP

Sets or queries the last data point in the waveform that will be transferred when executing the CURVe? command. This lets you transfer partial waveforms from the oscilloscope.

When using the CURVe command, the oscilloscope stops reading data when there is no more data to read or when the 2500 data point limit is reached.

Group Waveform

Syntax DATA:STOP <NR1>
DATA:STOP?

Related Commands [CURVe](#)

Arguments <NR1> is an integer value that ranges from 1 to 2500, and specifies the last data point that will be transferred. When DATA:STOP is less than DATA:START, the values are swapped internally for CURVe.

If you always want to transfer complete waveforms, set DATA:START to 1 and DATA:STOP to 2500.

Examples DATA:STOP 150 specifies that the waveform transfer will stop at data point 150.
DATA:STOP? might return 285 as the last data point that will be transferred.

DATA:TARget

Sets or queries the location for storing waveform data transferred from an external device to the oscilloscope when executing the CURVe command. This command is equivalent to the DATA:DESTination command and is included here for compatibility with older Tektronix oscilloscopes.

Group Waveform

Syntax DATA:TARget

DATA:WIDTH

Sets the number of bytes per waveform data point to be transferred when executing the CURVe command. (Changing DATA:WIDTH may change the following WFMPre parameters: BIT_Nr, BYT_Nr, YMULt, YOOff, and YZEro.)

Group Waveform

Syntax DATA:WIDTH <NR1>
DATA:WIDTH?

Related Commands [CURVe](#), [WFMPre:BIT_Nr](#)

Arguments <NR1> = 1 sets the number of bytes per waveform data point to 1 byte (8 bits).
<NR1> = 2 sets the number of bytes per waveform data point to 2 bytes (16 bits).
If DATA:WIDTH is set to 2, the least significant byte is always zero.

Examples DATA:WIDTH 1 sets the data width to 1 byte per data point for CURVe data.

DATALOGging? (Query Only)

Returns all the data logging parameters.

NOTE. Data Logging features are available only on TBS1000B, TBS1000 and TDS2000C Series models.

Group Data Logging

Syntax DATALOGging?

DATALOGging:DURATION

Sets the duration of the data logging, in minutes.

NOTE. Data Logging features are available only on TBS1000B, TBS1000 and TDS2000C Series models.

Group Data Logging

Syntax DATALOGging:DURation 30, 60, 90, 120, 150, 180, 210, 240, 270, 300, 330, 360, 390, 420, 450, 480, 540, 600, 660, 720, 780, 840, 900, 960, 1020, 1080, 1140, 1200, 1260, 1320, 1380, 1440, Infinite.
DATALOGging:DURation?

Related Commands [DATALOGging:SOURCE](#), [DATALOGging:STATE](#)

Arguments { 30 | 60 | 90 | 120 | 150 | 180 | 210 | 240 | 270 | 300 | 330 | 360 | 390 | 420 | 450 | 480 | 540 | 600 | 660 | 720 | 780 | 840 | 900 | 960 | 1020 | 1080 | 1140 | 1200 | 1260 | 1320 | 1380 | 1440 } is the data logging time period, in minutes.

{Infinite} runs data logging with no set time limit.

Examples DATALOGGING:DURATION 30
enables data logging to last for 30 minutes.

DATALOGging:SOURCE

Sets up the data logging source.

NOTE. Data Logging features are available only on TBS1000B, TBS1000 and TDS2000C Series models.

Group Data Logging

Syntax DATALOGging:SOURCE { CH<x> | MATH | FFT (on TBS1000B models only) }

Related Commands [DATALOGging:DURation](#), [DATALOGging:STATE](#)

Arguments CH<x> is a channel, where <x> is 1, 2, 3, or 4.
MATH is the MATH channel.

Examples DATALOGGING:SOURCE CH1
sets up CH1 as the source location from which to log data.

DATALOGging:STATE

Turns on or off the data logging feature.

NOTE. *Data Logging features are available only on TBS1000B, TBS1000 and TDS2000C Series models.*

Group Data Logging

Syntax DATALOGging:STATE
DATALOGging:STATE { OFF | ON | 0 | 1 }

Related Commands [DATALOGging:DURAtion](#), [DATALOGging:SOURCE](#)

Arguments OFF or <NR1> = 0 turns off the data logging function.
ON or <NR1> ≠ 0 turns on the data logging function.

Examples DATALOGGING:STATE ON
turns on data logging.

DATE

Sets or queries the oscilloscope date value. The oscilloscope uses these values to time stamp files saved to the CompactFlash card (TDS2MEM and TPS2000B/TPS2000 Series only), or to the USB flash drive (TBS1000B/EDU, TBS1000, TDS2000C, TDS1000C-EDU, TDS2000B, and TDS1000B Series only), as well as show the time and date on the oscilloscope display.

Conditions This command applies to the TBS1000B/EDU, TBS1000, TDS2000C, TDS1000C-EDU, TDS2000B, TDS1000B, TPS2000B, and TPS2000 and TDS2MEM Series only.

Group Miscellaneous

Syntax DATE <QString>
DATE?

Related Commands [TIMe](#)

Arguments <QString> is a date in the form "yyyy-mm-dd".

Examples DATE "2010-05-06" sets the date to May 6th, 2010.

*DDT (No Query Form)

Lets you specify a command or a list of commands to execute when the oscilloscope receives a *TRG command, or the GET GPIB interface message, or the USBTMC TRIGGER message. This is a special alias that *TRG uses.

TRG command, or the GET GPIB interface message, or the USBTMC TRIGGER message.

Group Miscellaneous

Syntax *DDT { <Block> | <QString> }
*DDT?

Related Commands [*TRG](#)

Arguments <Block> or <QString> is a complete sequence of program messages. The messages must contain only valid commands that must be separated by semicolons and must follow all rules for concatenating commands (See page 2-4, *Concatenating Commands*). The sequence must be ≤80 characters. <Block> format is always returned as a query response.

Examples *DDT #217ACQui re:STATE RUN<EOI> specifies that the acquisition system will be started each time a *TRG command is sent.

DESE

Sets and queries the bits in the Device Event Status Enable Register (DESER). The DESER is the mask that determines whether events are reported to the Standard Event Status Register (SESR), and entered into the Event Queue. (See page 3-1, *Status and Events*.)

Group Status and Error

Syntax DESE <NR1>
DESE?

Related Commands [*CLS](#), [*ESE](#), [*ESR?](#), [EVENT?](#), [EVMsg?](#), [*SRE](#)

Arguments <NR1> is an integer value in the range from 0 to 255. The binary bits of DESER are set according to this value. For example, DESE 209 sets the DESER to the binary value 11010001 (that is, the most significant bit in the register is set to 1, the next most significant bit to 1, the next bit to 0, and so on).

The power-on default for DESER is all bits set to 1 if *PSC is 1. If *PSC is 0, the DESER maintains its value through a power cycle.

NOTE. *Setting DESER and ESER to the same value allows only those codes to be entered into the Event Queue and summarized on the ESB bit (bit 5) of the Status Byte Register. Use the *ESE command to set ESER. For more information on event handling, refer to the Status and Events section.*

Examples DESE 209 sets the DESER to binary 11010001, which enables the PON, URQ, EXE, and OPC bits.

DESE? might return the following string `DESE 186` , showing that DESER contains the binary value 10111010.

DIAG:RESUlt:FLAg? (Query Only)

Returns the Pass/Fail status from the last diagnostic test sequence execution (those run automatically at power on, or those requested through the Service Menu). Use the DIAG:RESUlt:LOG? query to determine which test(s) has failed.

Group Calibration and Diagnostic

Syntax DIAG:RESUlt:FLAg?

Returns PASS means that the oscilloscope passes all diagnostic tests.
 FAIL means that the oscilloscope has failed at least one of the diagnostic tests.

Examples DIAG:RESUlt:FLAg
 Returns either PASS or FAIL.

DIAG:RESULT:LOG? (Query Only)

Returns the internal results log from the last diagnostic test sequence execution (those run automatically at power on, or those requested through the Service Menu). The list contains all modules and module interfaces that were tested with the pass or fail status of each.

Group	Calibration and Diagnostic
Syntax	DIAG:RESULT:LOG?
Returns	<QString> in the following format: <Status>,<Module name>[,<Status>,<Module name>...]
Examples	DIAG:RESULT:LOG? might return "PASS-CPU, PASS-ACQ1, PASS-EXTENSION" for power-up diagnostics.

DISplay? (Query Only)

Returns the current display settings.

Group	Display
Syntax	DISplay?
Returns	The current display settings
Examples	DISPLAY? might return DISPLAY:FORMAT YT;STYLE VECTORS; PERSISTENCE OFF;CONTRAST 50; INVERT OFF.

DISplay:BACKLight

Sets the backlight value.

Conditions	TBS1000B/EDU models only.
Group	Display

Syntax `DISplay:BACKLight <NR3>`
`DISplay:BACKLight?`

Arguments Sets the display backlight value in percent, as an integer, between 1 and 100.

DISplay:BRIGHTness

Sets or queries the brightness of the LCD display.

Conditions This command applies to the TPS2000 Series and TPS2000B Series only.

Group Display

Syntax `DISplay:BRIGHTness { 100 | 90 | 75 | 60 | 45 | 30 | 15 | 0 }`
`DISplay:BRIGHTness?`

Related Commands [DISplay:CONTRast](#)

Arguments Sets the display brightness in percent.

Examples `DISPLAY: BRIGHTNESS 75` sets the display brightness to 75%.

DISplay:CONTRast

Sets or queries the contrast of the LCD display. This command is equivalent to setting the Contrast option in the Display menu. The TBS1000B/EDU, TBS1000, TDS2000C, TDS1000C-EDU, and TDS2000B Series do not support the `DISplay:CONTRast` command and the display contrast feature.

Group Display

Syntax `DISplay:CONTRast <NR1>`
`DISplay:CONTRast?`

Related Commands [DISplay:INVert](#)

Arguments <NR1> is an integer in the range from 1 through 100. The larger the value, the greater the screen contrast.

Examples DISPLAY:CONTRAST 63 sets the display contrast to 63%.

DISplay:FORMat

Sets or queries the oscilloscope display format. This command is equivalent to setting the Format option in the Display menu.

Group Display

Syntax DISplay:FORMat { XY | YT }
DISplay:FORMat?

Arguments XY displays the voltage of channel 1 (horizontal axis) against the voltage of channel 2 (vertical axis).

NOTE. Setting the display format to XY turns cursors off. Sending the CURSor:FUNctioN command when the display format is XY causes the oscilloscope to generate event 221 (Settings conflict) and leaves the display in XY format.

YT sets the display to vertical values versus time format and is the default mode.

Examples DISPLAY:FORMAT YT selects a voltage versus time format for the display.
DISPLAY:FORMAT? might return XY for the display format.

DISplay:INVert

Sets or queries the TDS1000B and TDS1000 display format. This command is equivalent to setting the Display Style option in the Utility Options menu for the TDS1000B and TDS1000 Series.

The TBS1000B/EDU, TBS1000, TDS2000C, TDS1000C-EDU, TDS2000B, TDS2000, TPS2000B, and TPS2000 Series do not have a Display Style option, but accept the DISplay:INVert command and query for compatibility. The query always returns OFF.

The TDS200 Series is not supported.

Group	Display
Syntax	DISplay:INVert { ON OFF} DISplay:INVert?
Arguments	OFF chooses a default black-on-white display. ON chooses a white-on-black display.
Examples	DISPLAY:INVERT might return OFF.

DISplay:PERSistence

Sets the length of time that data points are displayed.

Group	Display
Syntax	DISplay:PERSistence { 1 2 5 INF OFF } DISplay:PERSistence?
Arguments	1 2 5 specifies the length, in seconds, that the waveform points are displayed on the screen. INF specifies infinite persistence. OFF specifies that persistence is turned off.
Returns	0 means that the persistence is turned off. 2 or 5 means that the persistence is set to two or five seconds. 99 means that the persistence is set to infinite.
Examples	DISPLAY:PERSISTENCE 5 specifies that the waveform points are displayed on the screen for five seconds before they fade.

DISplay:STYLE

Selects how to display the waveform data. This command is equivalent to setting the Type option in the Display menu.

Group	Display
Syntax	DISplay:STyle { DOTs VECtors } DISplay:STyle?
Arguments	DOTs displays individual data points. VECTors connects adjacent data points.
Examples	DISPLAY:STYLE VEC sets the display to connect adjacent data points. DISPLAY:STYLE might return DOTs indicating that the display shows individual waveform data points.

ERRLOG:FIRST? (Query Only)

Returns the first entry in the error log, or an empty string if the error log is empty. Use this command with ERRLOG:NEXT? to retrieve error log messages.

Group	Calibration and Diagnostic
Syntax	ERRLOG:FIRST?
Returns	Refer to the service manual for your oscilloscope for information about error log message format.

ERRLOG:NEXT? (Query Only)

Returns the next entry in the error log, or an empty string if the error log is empty or you have reached the end of the log. To start at the top of the error log, run the ERRLOG:FIRST? query to return the first error log message. Then use the ERRLOG:NEXT? query to step through the error log.

Group	Calibration and Diagnostic
Syntax	ERRLOG:NEXT?
Returns	Refer to the service manual for your oscilloscope for information about error log message format.

*ESE (No Query Form)

Sets and queries the bits in the Event Status Enable Register (ESER). The ESER prevents events from being reported to the Status Byte Register (STB). (See page 3-1, *Status and Events*.)

Group Status and Error

Syntax *ESE <NR1>
*ESE?

Related Commands [*CLS](#), [DESE](#), [*ESR?](#), [EVENT?](#), [EVMsg?](#)

Arguments <NR1> is a value in the range from 0 through 255. The binary bits of the ESER are set according to this value.

The power-on default for ESER is 0 if *PSC is 1. If *PSC is 0, the ESER maintains its value through a power cycle.

NOTE. *Setting the DESER and the ESER to the same value allows only those codes to be entered into the Event Queue and summarized on the ESB bit (bit 5) of the Status Byte Register. Use the DESE command to set the DESER. (See page 3-5, Event Handling Sequence.)*

Examples *ESE 209 sets the ESER to binary 11010001, which enables the PON, URQ, EXE, and OPC bits.

*ESE might return the string *ESE 186, showing that the ESER contains the binary value 10111010.

*ESR? (Query Only)

Returns the contents of the Standard Event Status Register (SESR). *ESR? also clears the SESR (since reading the SESR clears it). (See page 3-1, *Status and Events*.)

Group Status and Error

Syntax *ESR?

Related Commands [ALLEv?](#), [*CLS](#), [DESE](#), [*ESE](#), [EVENT?](#), [EVMsg?](#), [*OPC](#), [*SRE](#)

Returns Contents of the Standard Event Status Register.

Examples *ESR? might return the value 213, showing that the SESR contains binary 11010101.

EVENT? (Query Only)

Returns from the Event Queue an event code that provides information about the results of the last *ESR? read. EVENT? also removes the returned value from the Event Queue. (See page 3-5, *Event Handling Sequence*.)

Group Status and Error

Syntax EVENT?

Related Commands [ALLEv?](#), [*CLS](#), [DESE](#), [*ESE](#), [*ESR?](#), [EVMsg?](#), [*SRE](#)

Returns <NR1>

Examples EVENT? might return EVENT 110, indicating there was an error in a command header.

EVMsg? (Query Only)

Removes from the Event Queue a single event code associated with the results of the last *ESR? read, and returns the event code with an explanatory message. (See page 3-5, *Event Handling Sequence*.)

Group Status and Error

Syntax EVMsg?

Related Commands [ALLEv?](#), [*CLS](#), [DESE](#), [*ESE](#), [*ESR?](#), [EVENT?](#), [*SRE](#)

Returns The event code and message in the following format:

```
<Event Code><Comma><QString>[<Event Code><Comma>
<QString>...]
```

<QString> ::= <Message>[<Command>]

where <Command> is the command that caused the error and may be returned when a command error is detected by the oscilloscope. As much of the command as possible is returned without exceeding the 60 character limit of the <Message> and <Command> strings combined. The command string is right-justified.

Examples EVMSG? might return the message EVMSG 110, "Command header error"

EVQty? (Query Only)

Returns the number of event codes that are in the Event Queue. This is useful when using ALLEv? since it lets you know exactly how many events will be returned.

Group Status and Error

Syntax EVQty?

Related Commands [ALLEv?](#), [EVENT?](#)

Returns <NR1>

Examples EVQTY? might return 3 as the number of event codes in the Event Queue.

FACTory

Resets the oscilloscope to its factory default settings. Refer to *Appendix B: Factory Setup* for a list of the factory default settings.

Group Miscellaneous

Syntax **FACTory**

Setting the oscilloscope to factory default has the following impact on the programming interface:

- Clears the Event Status Enable Register
- Clears the Service Request Enable Register
- Sets the Device Event Status Enable Register to 255
- Sets the Power On Status Clear Flag to TRUE
- Enables all Command Headers (HEADer ON)
- Sets the macro defined by *DDT to a "zero-length field"
- Clears the pending operation flag and associated operations
- Performs the equivalent of DATA INIT

The FACTory command does not change the following items:

- State of the RS-232, GPIB, or USB interface
- Selected GPIB address
- Front panel LOCK state
- Verbose state
- Display Brightness, TPS2000 Series and TPS2000B Series only
- Display Contrast, TDS1000, TDS2000, TDS1000B, and TPS2000 Series
- Calibration data that affects device specifications
- Stored settings
- Stored waveforms or data
- Hard copy parameters
- Display messages language selection
- Current page of paged menus
- SAVE:IMAGE:FILEFORMAT
- FILESYSTEM:CWD

Related Commands [*PSC](#), [*RCL](#), [RECALL:SETUp](#), [*RST](#), [*SAV](#), [SAVe:SETUp](#), [SAVe:IMAge:FILEFormat](#)

Examples Refer to *Appendix B: Factory Setup*

FILESystem? (Query Only)

Returns the current working directory and amount of free space on the CompactFlash card (TDS2MEM and TPS2000B/TPS2000 Series only), or on the USB flash drive (TBS1000B/EDU, TBS1000, TDS2000C, TDS1000C-EDU, TDS2000B, and TDS2000B Series only).

Group	File system
Syntax	FILESystem?
Examples	<p>For non-TBS1000B/EDU models. FILESYSTEM? might return FILESYSTEM:CWD "A:\";FREESPACE 29691904.</p> <p>For TBS1000B/EDU models. FILESYSTEM? might return FILESYSTEM:CWD "/usb0/";FREESPACE 2691904.</p>

FILESystem:CWD

Sets or queries the current working folder path on the CompactFlash card (TDS2MEM and TPS2000B/TPS2000 Series only), or on the USB flash drive (TBS1000B/EDU, TBS1000, TDS2000C, TDS1000C-EDU, TDS2000B, and TDS1000B Series only).

Conditions	This command applies to the TBS1000B/EDU, TBS1000, TDS2000C, TDS1000C-EDU, TDS2000B, TDS1000B, TDS2MEM, TPS2000B, and TPS2000 Series only.
Group	File system
Syntax	FILESystem:CWD <folder path> FILESystem:CWD?
Arguments	<folder path> is a quoted string that defines the folder name and path. The root folder is A:\ for non-TBS1000B/EDU models and is /usb0/ for TBS1000B/EDU models. If there is no CompactFlash card or USB flash drive installed in the oscilloscope, the query returns a null string. This command is the easiest way for a program to check for the presence of a CompactFlash card or a USB flash drive.

- Examples** **For non-TBS1000B/EDU models.**
 FILESYSTEM:CWD "A:\MYDIR" sets the current working folder to MYDIR.
 FILESYSTEM:CWD? might return FILESYSTEM:CWD "A:\PROD-TST", if
 PROD-TST is the current working folder.
- For TBS1000B/EDU models.**
 FILESYSTEM:CWD "/usb0/MYDIR" sets the current working folder to MYDIR.
 FILESYSTEM:CWD? might return FILESYSTEM:CWD "/usb0/PROD-TST", if
 PROD-TST is the current working folder.

FILESystem:DELEte (No Query Form)

Deletes the specified file name from the CompactFlash card (TDS2MEM and TPS2000B/TPS2000 Series only), or from the USB flash drive (TBS1000B/EDU, TBS1000, TDS2000C, TDS1000C-EDU, TDS2000B, and TDS1000B Series only).

- Conditions** This command applies to the TBS1000B/EDU, TBS1000, TDS2000C, TDS1000C-EDU, TDS2000B, TDS1000B, TDS2MEM, TPS2000B, and TPS2000 Series only.
- Group** File system
- Syntax** FILESystem:DELEte <file path>
- Arguments** <file path> is a quoted string that defines the folder path and file name of the file to delete. The root directory is "A:\\" for non-TBS1000B/EDU models and is "/usb0/" for TBS1000B/EDU models. You cannot use an asterisk (*) wild card character to delete multiple files. For example, FILESYSTEM:DELETE "A:\PROD-TST*.SET" is not valid for non-TBS1000B/EDU models. Also, FILESYSTEM:DELETE "/usb0/PROD-TST/*.SET" is not valid for TBS1000B/EDU models.
- Examples** **For non-TBS1000B/EDU models.**
 FILESYSTEM:DELETE "A:\PROD-TST\1ST-RUN\TESTFREQ.SET" deletes the setup file TESTFREQ.SET from the CompactFlash card (TDS2MEM and TPS2000B/TPS2000 Series only), or from the USB flash drive (TBS1000, TDS2000C, TDS1000C-EDU, TDS2000B, and TDS1000B Series only).
- For TBS1000B models.**
 FILESYSTEM:DELETE "/usb0/PROD-TST/1ST-RUN/TESTFREQ.SET" deletes the setup file TESTFREQ.SET from the from the USB flash drive.

FILESystem:DIR? (Query Only)

Returns a list of strings. Each string contains the name of a file or folder in the current working folder on the CompactFlash card (TDS2MEM and TPS2000B/TPS2000 Series only), or on the USB flash drive (TBS1000B/EDU, TBS1000, TDS2000C, TDS1000C-EDU, TDS2000B, and TDS1000B Series only).

Group File system

Syntax FILESystem:DIR?

Examples FILESYSTEM:DIR? might return FILESYSTEM:DIR "ALL000", "ALL001".

FILESystem:FORMat (No Query Form)

Formats the CompactFlash card (TDS2MEM and TPS2000B/TPS2000 Series only) or the USB flash drive (TBS1000B/EDU, TBS1000, TDS2000C, TDS1000C-EDU, TDS2000B, and TDS1000B Series only). Formatting a CompactFlash card or a USB flash drive deletes all files and folders on the memory device.

Conditions This command applies to the TBS1000B/EDU, TBS1000, TDS2000C, TDS1000C-EDU, TDS2000B, TDS1000B, TDS2MEM, , TPS2000B, and TPS2000 Series only.

Group File system

Syntax FILESystem:FORMat <drive>

Arguments <drive> is a quoted string that sets the CompactFlash card (TDS2MEM and TPS2000B/TPS2000 Series only), or the USB flash drive (TBS1000B/EDU, TBS1000, TDS2000C, TDS1000C-EDU, TDS2000B and TDS1000B Series only) to format. Valid non-TBS1000B/EDU drive values are "A:" and "a:". The valid TBS1000B/EDU drive value is "/usb0/". Using any other drive value returns an error.

NOTE. *The oscilloscope reads the internal structure of the CompactFlash card or the USB flash drive every time the card is inserted. The time to complete the read depends on the size of the card and how it was formatted. To significantly shorten the initial read time of 64 MB and larger cards, format the card or flash drive as FAT32 with your personal computer.*

- Examples** **For non-TBS1000B/EDU models.**
 FILESYSTEM:FORMAT "A:" formats the CompactFlash card, or the USB flash drive.
- For TBS1000B/EDU models.**
 FILESYSTEM:FORMAT "/usb0/" formats the USB flash drive.

FILESystem:FREESpace? (Query Only)

Returns a numeric value, in bytes, of the memory space available on the CompactFlash card (TDS2MEM and TPS2000B/TPS2000 Series only), or on the USB flash drive (TBS1000B/EDU, TBS1000, TDS2000C, TDS1000C-EDU, TDS2000B, and TDS1000B Series only). This command returns 0 (zero) when there is no memory device installed in the oscilloscope.

- Group** File system
- Syntax** FILESystem:FREESpace?
- Examples** FILESYSTEM:FREESPACE? might return 6242501.

FILESystem:MKDir (No Query Form)

Creates a folder at the specified location on the CompactFlash card (TDS2MEM and TPS2000B/TPS2000 Series only), or on the USB flash drive (TBS1000B/EDU, TBS1000, TDS2000C, TDS1000C-EDU, TDS2000B, and TDS1000B Series only).

- Conditions** This command applies to the TBS1000B/EDU, TBS1000, TDS2000C, TDS1000C-EDU, TDS2000B, TDS1000B, TDS2MEM, TPS2000B, and TPS2000 Series only.
- Group** File system

Syntax FILESystem:MKDir <folder path>

Arguments <folder path> is a quoted string that defines the location and name of the folder to create. If you do not specify a path to the folder, the oscilloscope creates the folder in the current working directory. The current directory refers to the name of a folder as returned by the FILESystem:CWD query.

Folder names must follow the same rules as file names. (See page 2-16, *File System Conventions*.)

Examples **For all models.**

FILESYSTEM:MKDIR "VID-EVAL" creates a new folder VID-EVAL in the current working folder.

For non-TBS1000B/EDU models.

FILESYSTEM:MKDIR "A:\PROD-TST\2ND-RUN" creates a new folder 2ND-RUN in the existing folder A:\PROD-TST.

For TBS1000B/EDU models.

FILESYSTEM:MKDIR "/usb0/PROD-TST/2ND-RUN" creates a new folder 2ND-RUN in the existing folder /usb0/PROD-TST.

FILESystem:REName (No Query Form)

Assigns a new name to a file or folder on the CompactFlash card (TDS2MEM and TPS2000B/TPS2000 Series only), or on the USB flash drive (TBS1000B/EDU, TBS1000, TDS2000C, TDS1000C-EDU, TDS2000B, and TDS1000B Series only). You can also move a file or folder by specifying the new name in a different folder.

Conditions This command applies to the TBS1000B/EDU, TBS1000, TDS2000C, TDS1000C-EDU, TDS2000B, TDS1000B, TDS2MEM, TPS2000B, and TPS2000 Series only.

Group File system

Syntax FILESystem:REName <old filepath>,<new filepath>

Arguments <old filepath> is a quoted string that defines the path and name of the file to rename. If you do not specify a path to the file, the oscilloscope looks for the file in the current working folder. The current directory refers to the name of a folder as returned by the FILESystem:CWD query.

<new filepath> is a quoted string that defines the path and new name of the file. If you do not specify a path to a folder, the oscilloscope places the renamed file into the current working folder. (See page 2-16, *File System Conventions*.)

Examples **For all models.**

FILESYSTEM:RENAME "VID-CH1.BMP", "VID-EVAL.BMP" renames the file VID-CH1.BMP to VID-EVAL.BMP in the current working folder.

For non-TBS1000B/EDU models.

FILESYSTEM:RENAME
"A:\PROD-TST\VID-EVAL1.BMP", "A:\PROD-TST\VID-EVAL2.BMP"
renames the file VID-EVAL1.BMP to VID-EVAL2.BMP in A:\PROD-TST.

For TBS1000B/EDU models.

FILESYSTEM:RENAME
"/usb0/PROD-TST/VID-EVAL1.BMP", "/usb0/PROD-TST/VID-EVAL2.BMP"
renames the file VID-EVAL1.BMP to VID-EVAL2.BMP in /usb0/PROD-TST.

For file and folder name rules, see *File System Conventions*. (See page 2-16.)

FILESystem:RMDir (No Query Form)

Deletes a folder at the specified location on the CompactFlash card (TDS2MEM and TPS2000B/TPS2000 Series only), or on the USB flash drive (TBS1000B/EDU, TBS1000, TDS2000C, TDS1000C-EDU, TDS2000B, and TDS1000B Series only).

Conditions This command applies to the TBS1000B/EDU, TBS1000, TDS2000C, TDS1000C-EDU, TDS2000B, TDS1000B, TDS2MEM, TPS2000B, and TPS2000 Series only.

Group File system

Syntax FILESystem:RMDir <folder path>

Arguments <folder path> is a quoted string that defines the location and name of the folder to delete. If you do not specify a path to the folder, the oscilloscope deletes the specified folder in the current working folder. The current folder refers to the name of a folder as returned by the FILESystem:CWD query.

NOTE. *A folder must be empty before you can delete it.*

- Examples** `FILESYSTEM:RMDIR "/usb0/PROD-TST/2ND-RUN"` deletes the folder 2ND-RUN in the folder /usb0/PROD-TST.
- `FILESYSTEM:RMDIR "VID-EVAL"` deletes the folder VID-EVAL in the current working folder.

FFT? (Query Only)

Returns all FFT parameters.

Conditions TBS1000B/EDU models only.

Group FFT

Syntax FFT?

FFT:HORizontal:POSition

Sets or queries the FFT horizontal display position.

Conditions TBS1000B/EDU models only.

Group FFT

Syntax `FFT:HORizontal:POSition <NR3>`
`FFT:HORizontal:POSition?`

FFT:HORizontal:SCALE

Sets or queries the FFT zoom factor.

Conditions TBS1000B/EDU models only.

Group FFT

Syntax `FFT:HORizontal:SCALE <NR3>`
`FFT:HORizontal:SCALE?`

FFT:SOURce

Sets or queries the FFT source.

Conditions	TBS1000B/EDU models only.
Group	FFT
Syntax	FFT:SOURce { CH1 CH2 } FFT:SOURce?

FFT:SRCWFM

Sets or queries the FFT source waveform display state.

Conditions	TBS1000B/EDU models only.
Group	FFT
Syntax	FFT:SRCWFM { ON OFF } FFT:SRCWFM?

FFT:VERTical:POSition

Sets or queries the FFT vertical display position.

Conditions	TBS1000B/EDU models only.
Group	FFT
Syntax	FFT:VERTical:POSition <NR3> FFT:VERTical:POSition?

FFT:VERTical:SCAle

Sets or queries the FFT vertical zoom factor.

Conditions	TBS1000B/EDU models only.
Group	FFT
Syntax	FFT:VERTical:SCALE <NR3> FFT:VERTical:SCALE?

FFT:WIN

Sets or queries the FFT window state.

Conditions	TBS1000B/EDU models only.
Group	FFT
Syntax	FFT:WIN { HANNING FLATTOP RECTANGULAR } FFT:WIN?

HARDCopy

Sends a copy of the screen display followed by an EOI to the port specified by HARDCopy:PORT. The format and layout of the output is specified with the HARDCopy:FORMat and HARDCopy:LAYout commands. This command is equivalent to pressing the PRINT button on the front panel of the TBS1000, TDS2000C, TDS1000C-EDU, TDS2000B, TDS1000B, TDS2000, TDS1000, TPS2000B, and TPS2000 Series or the HARDCOPY button on the front panel of the TDS200 Series.

NOTE. *The TBS1000B/EDU, TBS1000, TDS2000C, TDS1000C-EDU, TDS2000B, and TDS1000B Series support the HARDCopy:PORT commands and queries for compatibility with programs designed for earlier oscilloscopes. (For TBS1000B/EDU, TBS1000, TDS2000C, TDS1000C-EDU, TDS2000B, and TDS1000B Series, you can only set the port to USB and the query will always return USB). The TBS1000B/EDU, TBS1000, TDS2000C, TDS1000C-EDU, TDS2000B, and TDS1000B oscilloscopes provide PictBridge printer support through a USB Device port on the rear of the oscilloscope. PictBridge Commands(See page 2-24, PictBridge Commands (TBS1000B/EDU, TBS1000, TDS2000C, TDS1000C-EDU, TDS2000B, and TDS1000B Only).)*

HARDCopy? returns format, layout, and port information.

NOTE. *This command is not IEEE Std 488.2-1987 compatible.*

Group	Hard copy
Syntax	HARDCopy { ABOrt STARt } HARDCopy?
Arguments	ABOrt terminates the hard copy output in process.

NOTE. *DCL does not clear the output queue once a hard copy is in process. The only way to abort the hard copy process is to send the HARDCopy ABOrt command. The output queue can then be cleared by sending a DCL message.*

STARt initiates a screen copy that is sent to the port specified by the HARDCOPY:PORT command.

NOTE. *Use the *WAI command between HARDCopy STARt commands to make sure that the first hard copy is complete before starting another.*

Examples	HARDCOPY ABORT stops any hard copy output that is in process.
-----------------	---

HARDCopy:BUTTON

Sets or returns the current PRINT front-panel button function.

NOTE. *This command does not affect the HARDCopy STARt command.*

Conditions	This command applies to the TBS1000B/EDU, TBS1000, TDS2000C, TDS1000C-EDU, TDS2000B, TDS1000B, TDS2MEM, , TPS2000B, and TPS2000 Series only.
Group	Hard copy
Syntax	HARDCopy:BUTTON { PRINTS SAVESA11 SAVESImage } HARDCopy:BUTTON?

- Arguments** PRINTS sets the PRINT button to send the screen image to the current printer port, using the current printer format.
- SAVESAll sets the PRINT button to save all active oscilloscope information (waveforms, screen image, settings) to files in a new subfolder in the current CompactFlash card folder (TDS2MEM and TPS2000B/TPS2000 Series only), or in the current USB flash drive folder (TBS1000B/EDU, TBS1000, TDS2000C, TDS1000C-EDU, TDS2000B, and TDS1000B Series only).
- SAVESImage sets the PRINT button to save the screen image to a file on the CompactFlash card or on the USB flash drive.
- Examples** HARDCOPY:BUTTON SAVESIMAGE sets the front-panel PRINT button to save the screen image to a file when pushed.

HARDCopy:FORMat

Sets the hard copy output data format. This command is the same as setting the Format option in the UTILITY > Options > Hard Copy or Printer Setup menu, depending on your oscilloscope model.

NOTE. *The TBS1000B/EDU, TBS1000, TDS2000C, TDS1000C-EDU, TDS2000B, and TDS1000B oscilloscopes provide PictBridge printer support through a USB Device port on the rear of the oscilloscope. (See page 2-24, PictBridge Commands (TBS1000B/EDU, TBS1000, TDS2000C, TDS1000C-EDU, TDS2000B, and TDS1000B Only).)*

The HARDCopy:FORMat is always Exif/JPEG when printing to a PictBridge printer.

For TBS1000B/EDU, TBS1000, TDS2000C, TDS1000C-EDU, TDS2000B, and TDS1000B oscilloscopes, use the HARDCopy:FORMat command to set the file format when saving an image to a USB flash drive or over USBTMC.

Group Hard copy

Syntax **For non-TBS1000B/EDU models.** HARDCopy:FORMat { BMP | BUBBLEJet | DESKJet | DPU3445 | DPU411 | DPU412 | EPSC60 | EPSC80 | EPSIMAGE | EPSON | INTERLEAF | JPEG | LASERJet | PCX | RLE | THINKjet | TIFF }

For TBS1000B/EDU models. HARDCopy:FORMat { BMP | JPEG }
 HARDCopy:FORMat?

- Arguments**
- BMP** (non-TBS1000B/EDU Series only) sets the hard copy output format to Microsoft Windows Bitmap format.
- BUBBLEJet** (TDS1000, TDS2000, TPS2000, and TPS2000B Series only) sets the hard copy output format to Canon Bubblejet format.
- DESKjet** (TDS200, TDS1000, TDS2000, TPS2000, and TPS2000B Series only) sets the hard copy output format to HP DeskJet format.
- DPU3445** (TDS1000, TDS2000, TPS2000, and TPS2000B Series only), **DPU411**, and **DPU412** set the hard copy output format to Seiko formats.
- EPSC60** sets the hard copy output to Epson C60 model printer format. Available on TDS1000 and TDS2000 models with firmware versions 2.12 or greater (two channel models) or 4.12 or greater (four channel models), any firmware version with a TDS2CMA, TDS2CMAX, or TDS2MEM module installed, or the TPS2000B/TPS2000 Series.
- EPSC80** sets the hard copy output to Epson C80 model printer format. Available on TDS1000 and TDS2000 series models with firmware versions 2.12 or greater (two channel models) or 4.12 or greater (four channel models), any firmware version with a TDS2CMA, TDS2CMAX, or TDS2MEM module installed, or the TPS2000B/TPS2000 Series.
- EPSIMAGE** (non-TBS1000B/EDU Series only) sets the hard copy format data to Postscript format.
- EPSON** (TDS2000, TDS1000, TDS200, TPS2000B, and TPS2000 Series only) sets the hard copy output format to 9-pin or 24-pin dot matrix printer format.
- INTERLEAF** (TDS200 Series only) sets the hard copy format data to Interleaf file format.
- JPEG** (TBS1000B/EDU, TBS1000, TDS2000C, TDS1000C-EDU, TDS2000B, and TDS1000B Series only) sets the hard copy format to JPEG format.
- LASERJet** (TBS1000, TDS1000C-EDU, TDS2000, TDS1000, TDS200, TPS2000B, and TPS2000 Series only) sets the hard copy output format to HP LaserJet II printer format.
- PCX** (non-TBS1000B/EDU) sets the hard copy output format to DOS Paintbrush format.
- RLE** (TBS1000, TDS2000C, TDS1000C-EDU, TDS2000B, TDS1000B, TDS2000, TDS1000, TPS2000B, and TPS2000 Series only) sets the hard copy output format to Windows color image file format (*.RLE). Use RLE for faster transfer rates and smaller resulting files. Many programs that recognize .BMP files also recognize .RLE files.
- THINKjet** (TDS2000, TDS1000, TDS200, TPS2000B, and TPS2000 Series only) sets the hard copy output format to HP Thinkjet printer format.
- TIFF** (TDS2000, TDS1000, TPS2000B, and TPS2000 Series only) sets the hard copy output format to Tagged Image File Format.

Examples `HARDCOPY:FORMAT LASERJET` sets the hard copy output format to LaserJet II.
`HARDCOPY:FORMAT?` might return EPSON as the hard copy output format.

HARDCopy:INKSaver

Sets the TBS1000B/EDU, TBS1000, TDS2000C, TDS1000C-EDU, TDS2000B, TDS1000B, TDS2000, TPS2000B, and TPS2000 Ink Saver feature to on or off. This command is equivalent to setting the Ink Saver option in the UTILITY > Options > Printer Setup menu of TBS1000B/EDU, TBS1000, TDS2000C, TDS1000C-EDU, TDS2000B, TDS1000B, TDS2000, TPS2000B, and TPS2000 oscilloscopes. This command has no effect on the TDS1000 oscilloscope, but is accepted for compatibility.

NOTE. *This command also controls the format of saved images.*

Conditions This command applies to the TBS1000B/EDU, TBS1000, TDS2000C, TDS1000C-EDU, TDS2000B, TDS1000B, TDS2000, TPS2000B, and TPS2000 Series only.

Group Hard copy

Syntax `HARDCopy:INKSaver { ON | OFF }`
`HARDCopy:INKSaver?`

Arguments `OFF` prints "WYSIWYG" hard copies, with color waveforms on a black background.
`ON` (default) prints color waveforms on a white background.

Examples `HARDCOPY:INKSAVER?` might return ON.

HARDCopy:LAYout

Selects the printing orientation. This command is equivalent to setting the Layout option in the UTILITY > Options > Hard Copy Setup menu.

NOTE. *This command also controls the format of saved images.*

Only TBS1000B/EDU, TBS1000, TDS2000C, TDS1000C-EDU, TDS2000B, and TDS1000B oscilloscopes are compatible with PictBridge printers. When printing to a PictBridge printer, the printer determines the orientation and will override the argument.

Group	Hard copy
Syntax	HARDCopy:LAYout { LANDscape PORTRait } HARDCopy:LAYout?
Arguments	<p>LANDscape specifies that the bottom of the hard copy is along the long side of the piece of paper.</p> <p>PORTRait specifies that the bottom of the hard copy is along the short side of the piece of paper. This is the standard format.</p>
Examples	HARDCOPY:LAYOUT might return PORTRAIT as the page layout format of the hard copy output.

HARDCopy:PORT

Selects where to send the hard copy data when the oscilloscope receives the next HARDCOPY START command. This command is equivalent to setting the Port option in the UTILITY > Options > Hard Copy Setup menu.

NOTE. *The TBS1000B/EDU, TBS1000, TDS2000C, TDS1000C-EDU, TDS2000B, and TDS1000B oscilloscopes provide PictBridge printer support through a USB Device port on the rear of the oscilloscope. (See page 2-24, PictBridge Commands (TBS1000B/EDU, TBS1000, TDS2000C, TDS1000C-EDU, TDS2000B, and TDS1000B Only).)*

Group	Hard copy
Syntax	HARDCopy:PORT { CENTronics RS232 GPIb USB } HARDCopy:PORT?
Arguments	<p>CENTronics specifies that the hard copy data is sent out the Centronics port.</p> <p>RS232 specifies that the hard copy data is sent out the RS232 port. If you set the port to RS232, and use it to transfer a BMP screen image format file to a PC or</p>

other computer, observe the following precaution that the BMP file is a binary file, and therefore does not use line feeds (hexadecimal 0a) as a terminator.

There are two ways to work around this limitation:

- Write your controller program to use the byte count information in the BMP file header.
- Set your RS232 program time out value to a large enough value to guarantee that the program does not time out before completing the data transfer. For example, to transfer an 80 kB file at 9600 baud, set the transfer program time out to 300 seconds.

GPIb specifies that the hard copy data is sent to the GPIB port. This argument is available on instruments with a TDS2CM, TDSCMA, TDSCMAX, or TDSMM module installed.

USB specifies that the hard copy data is sent to the USB Device port on the back of a TBS1000B/EDU, TBS1000, TDS2000C, TDS1000C-EDU, TDS2000B, or TDS1000B Series oscilloscope only.

Examples `HARDCOPY:PORT` might return RS232 as the selected hard copy output port.

HARmonics? (Query Only)

Returns settings for the HARmonic commands.

Group Power Measurement

Syntax `HARmonics?`

Examples `HARMONICS?` might return `HARMONICS:ENABLE ON; SETUP AUTOMATIC; SHOW ALL; SELECT 1; SOURCE CH1`, indicating that the oscilloscope is acquiring and showing all harmonics and measuring the first harmonic from channel 1.

HARmonics:ENABLE

Turns the harmonics measurement on or off.

Conditions This command applies to the TPS2000B/TPS2000 Series with TPS2PWR1 Power Analysis Module only.

Group Power Measurement

Syntax	<code>HARmonics:ENABle { ON OFF }</code> <code>HARmonics:ENABle?</code>
Arguments	ON causes the oscilloscope to display the harmonics menu and turn on Harmonics analysis. OFF causes the oscilloscope to display the CH1 menu.
Examples	<code>HARMONICS:ENABLE ON</code> causes the oscilloscope to display the harmonics menu. <code>HARMONICS:ENABLE?</code> might return OFF, indicating that the harmonics menu is turned off.

HARmonics:FREquency? (Query Only)

Returns the frequency of the selected harmonic.

Group	Power Measurement
Syntax	<code>HARmonics:FREquency?</code>
Returns	<NR3>
Examples	<code>HARMONICS:FREQUENCY?</code> might return <code>3.60576923E2</code> , indicating that the frequency of the selected harmonic is 360.57 Hz.

HARmonics:HRMS? (Query Only)

Returns the RMS amplitude of the selected harmonic in the same units as the source waveform.

Group	Power Measurement
Syntax	<code>HARmonics:HRMS?</code>
Returns	<NR3>
Examples	<code>HARMONICS:HRMS?</code> might return <code>6.18267221409E-1</code> .

HARmonics:PERCent? (Query Only)

Returns the amplitude of the selected harmonic as a percent of the fundamental.

Group Power Measurement

Syntax HARmonics:PERCent?

Examples HARMONICS:PERCENT? might return 5.0, indicating that the amplitude of the selected harmonic as a percent of the fundamental frequency is 5.0%.

HARmonics:PHase? (Query Only)

Returns the phase of the selected harmonic, in degrees, relative to the fundamental.

Group Power Measurement

Syntax HARmonics:PHase?

Examples HARMONICS:PHASE? might return 45.0, indicating that the phase of the selected harmonic, relative to the fundamental frequency, is 45 degrees.

HARmonics:RMS? (Query Only)

Returns the amplitude of the harmonics source in RMS. This may be V_{rms} or I_{rms} depending on the type of source waveform.

Group Power Measurement

Syntax HARmonics:RMS?

Examples HARMONICS:RMS? might return 120.0, indicating that the RMS value is 120 volts RMS.

HARmonics:SAVe (No Query Form)

Sets the file name and path to save the selected waveform harmonic data to the oscilloscope CompactFlash card in .CSV format.

The following data is included in the file:

- Harmonics, 1 through 50
- Magnitude
- Percent of fundamental
- Frequency
- Phase angle

NOTE. *You can view the contents of the saved file on your personal computer. You cannot recall saved harmonics files to the oscilloscope.*

Conditions	This command applies to the TPS2000B/TPS2000 Series with TPS2PWR1 Power Analysis Module only.
Group	Power Measurement
Syntax	<code>HARmonics:SAve <file path></code>
Arguments	<code><file path></code> specifies the full path to save harmonic measurement data.
Examples	<code>HARMONICS:SAVE "A:\data1.CSV"</code> specifies the file name and path to save harmonic loss measurement data to the oscilloscope CompactFlash card.

HARmonics:SElect

Selects an individual harmonic. If the harmonics function is enabled but the requested harmonic is not currently on the screen, the oscilloscope will put it on the screen. If the harmonics function is not enabled, the oscilloscope will remember the requested value but will not enable the harmonics function.

Conditions	This command applies to the TPS2000B/TPS2000 Series with TPS2PWR1 Power Analysis Module only.
Group	Power Measurement
Syntax	<code>HARmonics:SElect <NR1></code> <code>HARmonics:SElect?</code>

- Arguments** <NR1> specifies the harmonic from 1 to 50.
- Examples** HARMONICS:SELECT 1 instructs the oscilloscope to select the first harmonic.
HARMONICS:SELECT? might return 3, indicating that the third harmonic is selected.

HARmonics:SETUp

Sets or queries the operating mode of harmonics measurements.

- Conditions** This command applies to the TPS2000B/TPS2000 Series with TPS2PWR1 Power Analysis Module only.
- Group** Power Measurement
- Syntax** HARMONICS:SETUp { MANUAL | AUTOMATIC }
HARMONICS:SETUp?
- Arguments** MANUAL The oscilloscope does not adjust the setup when entering or exiting the harmonics measurement mode.
AUTOMATIC The oscilloscope adjusts various settings to optimize the harmonics display. The oscilloscope returns to your previous settings when you exit the harmonics measurement mode.
- Examples** HARMONICS:SETUP might return AUTOMATIC.

HARmonics:SHOW

Sets or returns the type of displayed harmonics.

- Conditions** This command applies to the TPS2000B/TPS2000 Series with TPS2PWR1 Power Analysis Module only.
- Group** Power Measurement
- Syntax** HARMONICS:SHOW { ALL | ODD | EVEN }
HARMONICS:SHOW?

Arguments	ALL displays both odd and even harmonics. ODD displays odd harmonics only. EVEN displays even harmonics only.
Examples	HARMONICS:SHOW ALL instructs the oscilloscope to display all harmonics. HARMONICS:SHOW? might return HARMONICS:SHOW ODD, indicating that instrument displays only the odd harmonics.

HARmonics:SOURce

Sets the source in the power menu.

Conditions	This command applies to the TPS2000B/TPS2000 Series with TPS2PWR1 Power Analysis Module only.
Group	Power Measurement
Syntax	HARmonics:SOURce { CH<x> } HARmonics:SOURce?
Arguments	CH<x> is one of the allowable input channels. The value of <x> can vary from 1 through 4 for 4-channel instruments or 1 through 2 for 2-channel instruments.
Examples	HARMONICS:SOURCE CH1 sets the source for the harmonics function to CH1. HARMONICS:SOURCE might return CH1, indicating that the harmonics source is channel 1.

HARmonics:THDF? (Query Only)

Returns total harmonic distortion of the waveform as a percentage of the fundamental.

Group	Power Measurement
Syntax	HARmonics:THDF?

Returns <NR3>

Examples HARMONICS:THDF? might return 1.1117748204298E1, indicating that the total harmonic distortion is 11.11% of the fundamental frequency.

HARmonics:THDR? (Query Only)

Returns the total harmonic distortion of the waveform as a percentage of the V_{rms} or I_{rms} of the input signal.

Group Power Measurement

Syntax HARMONICS:THDR?

Returns <NR3>

Examples HARMONICS:THDR? might return 1.1094271493299E1, indicating that the harmonic distortion is 11.09% of the RMS input voltage.

HDR

This command is identical to the HEADer query and is included for compatibility with other Tektronix oscilloscopes.

Group Miscellaneous

Syntax HDR

HEADer

Sets and queries the Response Header Enable State that causes the oscilloscope to either include or omit headers on query responses. This command does not affect IEEE Std 488.2-1987 Common Commands (those starting with an asterisk); they never return headers.

Group Miscellaneous

Syntax	HEADer { <NR1> OFF ON } HEADer?
Arguments	<p>ON or <NR1> ≠ 0 sets the Response Header Enable State to true. This causes the oscilloscope to include headers on applicable query responses. You can then use the query response as a command.</p> <p>OFF or <NR1> = 0 sets the Response Header Enable State to false. This causes the oscilloscope to omit headers on query responses so that only the argument is returned.</p>
Examples	<p>HEADER OFF causes the oscilloscope to omit headers from query responses.</p> <p>HEADER? might return 1, showing that the Response Header Enable State is true.</p>

HORizontal? (Query Only)

Returns all settings for the horizontal commands. The commands HORizontal:MAIn:SCAle, HORizontal:MAIn:SECdiv, HORizontal:SCAle, and HORizontal:SECdiv are equivalent, so HORizontal:MAIn:SCAle is the value that is returned.

The commands HORizontal:MAIn:POStion and HORizontal:POStion are equivalent, so HORizontal:MAIn:POStion is the value that is returned.

Group	Horizontal
Syntax	HORizontal?
Returns	Returns all horizontal settings
Examples	HORIZONTAL? might return the following string: HORIZONTAL:VIEW MAIN;RECORDLENGTH 2500;MAIN:POSITION 0.0E0;SCALE 5.0E-4;HORIZONTAL:DELAY:POSITION 0.0E0;SCALE 2.5E-4

HORizontal:DELay? (Query Only)

Returns all settings for the window time base. The commands HORizontal:DELay:SECdiv and HORizontal:DELay:SCAle are equivalent, so only the values for HORizontal:DELay:SCAle are returned.

Conditions	This command is NOT applicable to TBS1000B/EDU models.
-------------------	--

Group	Horizontal
Syntax	HORizontal:DELay?
Returns	All settings for the window time base
Examples	HORIZONTAL:DELAY? might return HORIZONTAL:DELAY:POSITION 0.0E0; SCALE 5.0E-4

HORizontal:DELay:POSition

Sets or queries the window time base horizontal position. This command is equivalent to adjusting the Horizontal Position when Window Zone or Window is selected from the Horizontal menu.

Conditions	This command is NOT applicable to TBS1000B/EDU models.
Group	Horizontal
Syntax	HORizontal:DELay:POSition <NR3> HORizontal:DELay:POSition?
Arguments	<NR3> is the position in seconds. This value is the difference between the trigger point and the center graticule. Positive values place the trigger before the center graticule.
Examples	HORIZONTAL:DELAY:POSITION 2.0E-6 sets the window position to 2ms before the center graticule. HORIZONTAL:DELAY:POSITION? might return -1.0E-3, indicating that the window position is 1 ms after the center graticule.

HORizontal:DELay:SCAle

Sets the time per division for the oscilloscope window time base. This command is equivalent to setting SEC/DIV when Window Zone or Window is selected from the Horizontal menu.

Conditions	This command is NOT applicable to TBS1000B/EDU models.
-------------------	--

Group	Horizontal
Syntax	<code>HORizontal:DELay:SCALE <NR3></code> <code>HORizontal:DELay:SCALE?</code>
Arguments	<NR3> is the time per division. The range depends on the oscilloscope model. The acceptable values are in a 1-2.5-5 sequence. If the window time base scale is set slower than the main time base scale, both the main and window time base scales are set to the window scale value.
Examples	<code>HORIZONTAL:DELAY:SCALE 2.0E-6</code> sets the window scale to 2 ms per division. <code>HORIZONTAL:DELAY:SCALE 9.0E-6</code> sets the window scale to 10 ms per division. Since 9 μ s is not a correct value within the 1-2.5-5 sequence, it is automatically set to the closest correct value. <code>HORIZONTAL:DELAY:SCALE?</code> might return <code>1.0E-3</code> , indicating that the window scale is 1 ms per division.

HORizontal:DELay:SECdiv

This command is identical to the `HORizontal:DELay:SCALE`. It is provided to maintain program compatibility with some older models of Tektronix oscilloscopes.

Conditions	This command is NOT applicable to TBS1000B/EDU models.
Group	Horizontal
Syntax	<code>HORizontal:DELay:SECdiv</code>

HORizontal:MAIn? (Query Only)

Returns all settings for the oscilloscope main time base. The `HORizontal:MAIn:SECdiv` and `HORizontal:MAIn:SCALE` commands are identical so only `HORizontal:MAIn:SCALE` is returned.

Group	Horizontal
Syntax	<code>HORizontal:MAIn?</code>

Returns All settings for the main time base.

Examples HORIZONTAL:MAIN? might return HORIZONTAL:MAIN:POSITION
0.0E0;SCALE 5.0E-4

HORizontal:MAIn:POSition

Sets or queries the main time base horizontal position. This command is equivalent to adjusting the Horizontal Position when Main is selected from the Horizontal menu.

Horizontal

Group Horizontal

Syntax HORIZONTAL:MAIN:POSITION <NR3>
HORIZONTAL:MAIN:POSITION?

Arguments <NR3> is the position in seconds. This value is the difference between the trigger point and the center graticule. Positive values place the trigger before the center graticule.

Examples HORIZONTAL:MAIN:POSITION 2.0E-6 sets the main trigger position to 2ms before the center graticule.

HORIZONTAL:MAIN:POSITION? might return -1.0E-3, indicating that the main trigger position is 1 ms after the center graticule.

HORizontal:MAIn:SCAle

Sets the time per division for the main time base. This command is equivalent to setting SEC/DIV when Main is selected from the Horizontal menu.

Group Horizontal

Syntax HORIZONTAL:MAIN:SCALE <NR3>
HORIZONTAL:MAIN:SCALE?

Arguments <NR3> is the time per division. The range depends on the oscilloscope model. The acceptable values are in a 1-2.5-5 sequence. Other values are forced to the closest acceptable value.

Examples `HORIZONTAL:MAIN:SCALE 2.5E-6` sets the main scale to 2.5 ms per division.

HORizontal:MAIn:SECdiv

Sets the time per division for the oscilloscope main time base. This command is identical to the `HORizontal:MAIn:SCALE` command. It is provided to maintain program compatibility with some older models of Tektronix oscilloscopes.

Group Horizontal

Syntax `HORizontal:MAIn:SECdiv`

HORizontal:POSition

Sets or queries the main time base horizontal position. This command is identical to the `HORizontal:MAIn:POSition` command. This command is included for compatibility.

Group Horizontal

Syntax `HORizontal:POSition <NR3>`
`HORizontal:POSition?`

Arguments `<NR3>` is the position in seconds. This value is the difference between the trigger point and the center graticule. Positive values place the trigger before the center graticule.

Examples `HORIZONTAL:POSITION 2.0E-6` sets the main trigger position to 2ms before the center graticule.

`HORIZONTAL:POSITION?` might return `-1.0E-3`, indicating that the main trigger position is 1 ms after the center graticule.

HORizontal:RECOrdlength? (Query Only)

Returns the number of acquisition data points. For TBS1000B/EDU, TBS1000, TDS2000C, TDS1000C-EDU, TDS2000B, TDS1000B, TDS2000, TDS1000, TDS200, TPS2000B, and TPS2000 oscilloscopes, this value is always 2500, even in FFT mode. This command is provided to maintain program compatibility with other Tektronix digital oscilloscopes.

Group	Horizontal
Syntax	HORizontal:RECOrdlength?
Related Commands	WFMPre:NR_Pt?
Returns	2500
Examples	HORIZONTAL:RECORDLENGTH? returns 2500 as the number of data points in each record.

HORizontal:SCALE

Sets the time per division for the main time base and is identical to the HORizontal:MAIn:SCALE command. It is included for compatibility purposes.

Group	Horizontal
Syntax	HORizontal:SCALE

HORizontal:SECdiv

Sets the time per division for the main time base and is identical to the HORizontal:MAIn:SCALE command. It is included for compatibility purposes.

Group	Horizontal
Syntax	HORizontal:SECdiv

HORizontal:VIEW

Specifies whether the horizontal display uses the Main, Window Zone, or Window view. This is equivalent to setting the View in the Horizontal menu.

Conditions	This command is NOT applicable to TBS1000B/EDU models.
-------------------	--

Group	Horizontal
Syntax	HORizontal:VIEW { MAIN WINDOW ZONE } HORizontal:VIEW?
Arguments	<p>MAIN specifies that the waveform is acquired and displayed using the Main time base.</p> <p>WINDOW specifies that the waveform is acquired and displayed using the Window (delay) time base.</p> <p>ZONE is the same as MAIN, but adds display of vertical cursor bars to show the part of the waveform that is acquired and displayed using the window (delay) time base.</p>
Examples	HORIZONTAL:VIEW MAIN specifies the default horizontal view.

ID? (Query Only)

Returns identifying information about the oscilloscope and its firmware in Tektronix Codes and Formats notation.

NOTE. *ID? must be the last command when part of a concatenated statement. Otherwise the oscilloscope generates event message 440.*

The ID? and *IDN? responses are slightly different.

Group	Miscellaneous
Syntax	ID?
Returns	<p>Returns the oscilloscope identification in the following format for TDS2CM, TDS2CMA, and TDS2MM modules:</p> <p>ID TEK/<model number>,CF:91.1CT,FV:v<oscilloscope firmware version number>,TDS2XX:XXV:v<module firmware version number></p> <p>Where XX is the module type, CM (TDS2CM or TDS2CMA communications module) or MM (measurement module).</p> <p>Returns the oscilloscope identification in the following format for TDS2MEM modules:</p>

ID TEK/<model number>,CF:91.1CT TDS2MEM:FV:v<module firmware version number>

Returns the oscilloscope identification in the following format for TPS2000B/TPS2000 oscilloscopes:

ID TEK/<model number>,CF:91.1CT FV:v<oscilloscope firmware version number> TPS2XXXV:v<module firmware version number>

Returns the oscilloscope identification in the following format for TBS1000B/EDU, TBS1000, TDS2000C, TDS1000C-EDU, TDS2000B, and TDS1000B oscilloscopes:

ID TEK/<model number>,CF:91.1CT FV:v<oscilloscope firmware version number>

Examples ID? might return the following response with a TDS2CMA installed: ID TEK/TDS 220,CF:91.1CT,FV:V1.00 TDS2CM:CMV:V1.00

ID? might return the following response with a TDS2MEM installed: ID TEK/TDS 2022,CF:91.1CT TDS2MEM:FV:V6.00

ID? might return the following response with a TPS2PWR installed: ID TEK/TPS 2012,CF:91.1CT FV:V9.48 TPS2PWR1:V1.00

ID? might return the following response for a TDS1012B oscilloscope: ID TEK/TDS 1012B,CF:91.1CT FV:v21.21

*IDN? (Query Only)

Returns the oscilloscope identification code in IEEE 488.2 notation.

NOTE. **IDN? must be the last command when part of a concatenated statement. Otherwise the oscilloscope generates event message 440.*

The *IDN? and ID? responses are slightly different.

Group Miscellaneous

Syntax *IDN?

Returns Returns the oscilloscope identification in the following format for TDS2CM, TDS2CMA, and TDS2MM modules:

TEKTRONIX, <model number>,CF:91.1CT FV:v<oscilloscope firmware version number>,TDS2XX:XXV:v<module firmware version number>

Where XX is the module type CM (TDS2CM or TDS2CMA communications module) or MM (measurement module).

Returns the oscilloscope identification in the following format for TDS2MEM modules:

TEKTRONIX, <model number>,CF:91.1CT TDS2MEM:FV:v<module firmware version number>

Returns the oscilloscope identification in the following format for TPS2000B/TPS2000 oscilloscopes:

TEKTRONIX,<model number>,CF:91.1CT FV:v<oscilloscope firmware version number> TPS2XXXV:v<module firmware version number>

Returns the oscilloscope identification in the following format for TBS1000B/EDU, TBS1000, TDS2000C, TDS1000C-EDU, TDS2000B, and TDS1000B oscilloscopes:

TEKTRONIX/<model number>,<serial number>, CF:91.1CT FV:v<oscilloscope firmware version number>

Examples

*IDN? might return the following response with a TDS2CMA installed: ID
TEKTRONIX,TDS 220,0,CF:91.1CT FV:v2.12 TDS2CM:CMV: v1.04

*IDN? might return the following response with a TDS2MEM installed: ID
TEKTRONIX,TDS 2022,0,CF:91.1CT TDS2MEM:FV:v6.00

*IDN? might return the following response for a TPS2012 oscilloscope with a TPS2PWR1 power analysis module installed: TEKTRONIX,TPS
2012,0,CF:91.1CT FV:v9.48 TPS2PWR1:v1.00

*IDN? might return the following response for a TPS2022B oscilloscope with the serial number CU10100: TEKTRONIX,TDS 2022B,CU10100,CF:91.1CT
FV:v20.22

*IDN? might return the following response for a TDS1012B oscilloscope with the serial number CU010114: TEKTRONIX,TDS 1012B,CU010114,CF:91.1CT
FV:v21.21

LANGuage

Sets or queries the languages that the oscilloscope uses to display information on the screen. This is equivalent to setting the Language option in the Utility menu.

Group Miscellaneous

Syntax LANGUAGE { ENGLISH | FRENCH | GERMAN | ITALIAN | SPANISH | JAPANESE | PORTUGUESE | KOREAN | TRADITIONALCHINESE | SIMPLIFIEDCHINESE }
LANGUAGE?

Arguments Specifies the language used to display oscilloscope information on the screen.

Examples LANGUAGE FRENCH specifies that the oscilloscope displays information in French.
LANGUAGE? might return SPANISH.

LIMit? (Query Only)

Returns all limit testing parameters.

Conditions TBS1000B, TBS1000 and TDS2000C Series models only.

Group Limit Test

Syntax LIMit?

Examples LIMIT?
asks for all the limit testing parameters.

LIMit:COMpare

Sets or returns the template against which to compare the waveform acquired through the specified channel. The template can be a waveform saved in any of the reference locations REF1 through REF4.

Conditions TBS1000 and TDS2000C models. Not applicable to TBS1000B models.

Group Limit Test

Syntax LIMit:COMpare :REF<x>
LIMit:COMpare?

Related Commands [LIMit:TEMPLate](#)

Arguments	REF<x> is a reference waveform, where <x> is 1, 2, 3, or 4.
Examples	<code>LIMIT:COMPARE REF1</code> specifies REF1 as the template waveform against which to compare waveforms acquired on the specified channel. <code>LIMIT:COMPARE?</code> might return: REF4, indicating that waveforms acquired will be compared to the limit test template waveform stored in REF4.

LIMit:RESULT:FAIL? (Query Only)

Returns the number of failure cases.

Conditions	TBS1000B, TBS1000 and TDS2000C Series models only.
Group	Limit Test
Syntax	<code>LIMit:RESUlT:FAIL?</code>
Related Commands	LIMit:RESULT:PASS? , LIMit:RESULT:TOTAL?
Examples	<code>LIMIT:RESULT:FAIL?</code> might return: 25, indicating that 25 test cases were detected as failing.

LIMit:RESULT:PASS? (Query Only)

Returns the number of pass cases.

Conditions	TBS1000B, TBS1000 and TDS2000C Series models only.
Group	Limit Test
Syntax	<code>LIMit:RESUlT:PASS?</code>
Related Commands	LIMit:RESULT:FAIL? , LIMit:RESULT:TOTAL?

Examples `LIMIT:RESULT:PASS?`
might return: 25, indicating that 25 test cases were detected as passing.

LIMit:RESUlt:TOTAL? (Query Only)

Returns the number of total cases tested.

Conditions TBS1000B, TBS1000 and TDS2000C Series models only.

Group Limit Test

Syntax `LIMit:RESUlt:TOTAL?`

Related Commands [LIMit:RESUlt:FAIL?](#), [LIMit:RESUlt:PASS?](#)

Examples `LIMIT:RESULT:TOTAL?`
might return: 25, indicating that there were 25 test cases detected.

LIMit:SAVEIMAge

Sets or returns whether the oscilloscope should save the screen image to a file on a limit test failure event. When enabled, this command copies image data from all active waveforms that have limit test failures to a file on the oscilloscope flash memory drive.

Conditions TBS1000B, TBS1000 and TDS2000C Series models only.

Group Limit Test

Syntax `LIMit:SAVEIMAge { OFF | ON | 0 | 1 }`
`LIMit:SAVEIMAge?`

Related Commands [LIMit:SAVEWFM](#)

Arguments OFF or `<NR1> = 0` turns off the function to save waveform image data to the flash drive for limit testing.

ON or <NR1> ≠ 0 turns on the function to save waveform image data to the flash drive for limit testing.

Examples `LIMIT:SAVEIMAGE ON`
turns on the function to save waveform image data to the flash drive for limit testing.

LIMit:SAVEWFM

Sets or returns whether the oscilloscope should save the waveform to a file on a limit test failure event. When enabled, this command copies waveform data from all active waveforms that have limit test failures to a file on the oscilloscope flash memory drive.

Conditions TBS1000B, TBS1000 and TDS2000C Series models only.

Group Limit Test

Syntax `LIMit:SAVEWFM { OFF | ON | 0 | 1 }`
`LIMit:SAVEWFM?`

Related Commands [LIMit:SAVEIMAge](#)

Arguments OFF or <NR1> = 0 turns off the function to save waveform data to the flash drive for limit testing.

ON or <NR1> ≠ 0 turns on the function to save waveform data to the flash drive for limit testing.

Examples `LIMIT:SAVEWFM OFF`
turns off the feature to save the waveform to a file on a limit test failure.

LIMit:SOUrce

Sets or returns the source channel for the waveform currently being compared to the test template.

Conditions TBS1000B, TBS1000 and TDS2000C Series models only.

Group	Limit Test
Syntax	LIMit:SOURCE { CH<x> MATH } LIMit:SOURCE?
Related Commands	LIMit:TEMPLate:SOURCE
Arguments	CH<x> specifies that the source channel for the waveform currently being compared to the test template. MATH specifies the source channel as the math waveform.
Examples	LIMIT:SOURCE MATH sets the MATH waveform as the source channel.

LIMit:STATE

Turns limit testing on or off, or returns whether limit testing is in effect.

Conditions	TBS1000B, TBS1000 and TDS2000C Series models only.
Group	Limit Test
Syntax	LIMit:STATE { OFF ON 0 1 } LIMit:STATE?
Related Commands	LIMit:COMpare , LIMit:TEMPLate
Arguments	OFF or <NR1> = 0 turns off limit testing. ON or <NR1> ≠ 0 turns on limit testing.
Examples	LIMIT:STATE OFF turns limit testing off.

LIMit:STOPAfter:MODE

Sets or restores the mode for the limit test stop after feature.

Conditions	TBS1000B, TBS1000 and TDS2000C Series models only.
Group	Limit Test
Syntax	LIMit:STOPAfter:MODE { MANUal WAVEform VIOLation TIME } LIMit:STOPAfter:MODE?
Related Commands	LIMit:STOPAfter:TIME , LIMit:STOPAfter:VIOLation , LIMit:STOPAfter:WAVEform
Arguments	<p>MANual causes the test to stop after an operator manually stops it.</p> <p>WAVEform causes the test to stop after the oscilloscope tests a specified number of waveforms.</p> <p>VIOLation causes the test to stop after the oscilloscope detects a violation.</p> <p>TIME causes the test to stop after the oscilloscope detects that the preset running time has elapsed.</p>
Examples	<pre>LIMIT:STOPAFTER:MODE?</pre> <p>might return VIOLATION</p>

LIMit:STOPAfter:TIME

Sets or returns the limit test stop after time setting. The limit test will automatically stop when it reaches the specified time, in seconds.

Conditions	TBS1000B, TBS1000 and TDS2000C Series models only.
Group	Limit Test
Syntax	LIMit:STOPAfter:TIME <NR3> LIMit:STOPAfter:TIME?
Related Commands	LIMit:STOPAfter:MODE , LIMit:STOPAfter:VIOLation , LIMit:STOPAfter:WAVEform
Arguments	<NR3> is the time in seconds to run the limit test.

Examples `LIMIT:STOPAFTER:TIME 10`
sets the limit test to run for 10 seconds.

LIMit:STOPAfter:VIOLation

Sets or returns the limit test stop after violation setting. The test will automatically stop after it detects the specified number of violations.

Conditions TBS1000B, TBS1000 and TDS2000C Series models only.

Group Limit Test

Syntax `LIMit:STOPAfter:VIOLation <NR3>`
`LIMit:STOPAfter:VIOLation?`

Related Commands [LIMit:STOPAfter:MODE](#), [LIMit:STOPAfter:TIME](#), [LIMit:STOPAfter:WAVEform](#)

Arguments <NR3> is the number of violations to detect before stopping the limit test.

Examples `LIMIT:STOPAFTER:VIOLATION 10`
sets the limit test to run until it detects 10 violations.

LIMit:STOPAfter:WAVEform

Sets or returns the setting for the limit test stop after waveform function. The test will automatically stop when it tests the specified number of waveforms.

Conditions TBS1000B, TBS1000 and TDS2000C Series models only.

Group Limit Test

Syntax `LIMit:STOPAfter:WAVEform <NR3>`
`LIMit:STOPAfter:WAVEform`

Related Commands [LIMit:STOPAfter:MODE](#), [LIMit:STOPAfter:TIME](#), [LIMit:STOPAfter:VIOLation](#)

Arguments <NR3> is the number of waveforms to test before stopping the limit test.

Examples `LIMIT:STOPAFTER:WAVEFORM 1000`
sets the limit test to run until it has tested 1000 waveforms.

LIMit:TEMPLate (No Query Form)

Uses the values specified by LIMit:TEMPLate:SOUrce, LIMit:TEMPLate:TOLerance:HORizontal, and LIMit:TEMPLate:TOLerance:VERTical to create a limit test template and store the template in the reference waveform memory location specified in LIMit:TEMPLate:DESTination. You can compare the waveform acquired through the specified channel against this template. The template can be a waveform saved in any of the reference locations REF1 through REF4.

Conditions TBS1000B, TBS1000 and TDS2000C Series models only.

Group Limit Test

Syntax `LIMit:TEMPLate APPLY`

Related Commands [LIMit:TEMPLate:DESTination](#), [LIMit:TEMPLate:SOUrce](#), [LIMit:TEMPLate:TOLerance:HORizontal](#), [LIMit:TEMPLate:TOLerance:VERTical](#)

Arguments APPLY creates a template with the specified source waveform and tolerances, and stores it in the destination reference waveform to be used in the limit test comparisons.

Examples `LIMIT:TEMPLATE APPLY`
creates a template with the specified source waveform and tolerances, and stores it in the destination reference waveform to be used in the limit test comparisons.

LIMit:TEMPLate:DESTination

Sets or returns the destination reference waveform that the LIMit:TEMPLate APPLY command will use.

Conditions TBS1000 and TDS2000C Series models only. It is not applicable for TBS1000B Series models.

Group Limit Test

Syntax `LIMit:TEMPLate:DESTination REF<x>`
`LIMit:TEMPLate:DESTination?`

Related Commands [LIMit:TEMPLate](#), [LIMit:TEMPLate:SOURce](#), [LIMit:TEMPLate:TOLerance:HORizontal](#), [LIMit:TEMPLate:TOLerance:VERTical](#)

Arguments REF<x> specifies the reference waveform destination in which the template waveform is to be stored.

Examples `LIMIT:TEMPLATE:DESTINATION REF2`
specifies that the template waveform referred to with the `LIMit:TEMPLate APPLY` command is stored as the REF2 waveform.

LIMit:TEMPLate:DUALSOURce

Sets or returns the dual template waveform source. `LIMit:TEMPLate:APPLY` will use this value in deriving the limit test template waveform, when the template is created by a single source.

Conditions TBS1000B models only.

Group Limit Test

Syntax `LIMit:TEMPLate:DUALSOURce { CH1 | CH2 | MATH }`

LIMit:TEMPLate:SAVEFIRSource (No Query Form)

Save the first template source data information temporarily for applying the template. It will not save to REFA.

Conditions TBS1000B models only.

Group Limit Test

Syntax `LIMit:TEMPLate:SAVEFIRSource`

LIMit:TEMPLate:SAVESECSource (No Query Form)

Save the second template source data information temporarily for applying the template. It will not save to REFA.

Conditions	TBS1000B models only.
Group	Limit Test
Syntax	LIMit:TEMPLate:SAVESECSource

LIMit:TEMPLate:SAVESOURCE (No Query Form)

Saves the template source data for single waveform templates.

Conditions	TBS1000B models only
Group	Limit Test
Syntax	LIMit:TEMPLate:SAVESOURCE

LIMit:TEMPLate:SOURCE

Sets or returns the source channel or math waveform that LIMit:TEMPLate APPLY will use in deriving the limit test template waveform, when the template is created by single source.

Conditions	TBS1000B, TBS1000 and TDS2000C Series models.
Group	Limit Test
Syntax	LIMit:TEMPLate:SOURCE { CH<x> MATH } LIMit:TEMPLate:SOURCE?

Related Commands [LIMit:TEMPLate](#), [LIMit:TEMPLate:DESTination](#), [LIMit:TEMPLate:TOLerance:HORizontal](#), [LIMit:TEMPLate:TOLerance:VERTical](#)

Arguments CH<x> specifies that the template waveform source is the waveform currently being acquired using the specified channel.

MATH specifies the template waveform source channel as the math waveform.

Examples `LIMIT:TEMPLATE:SOURCE CH2`
 specifies that the template waveform for limit tests is the waveform currently acquired using channel 2.

`LIMIT:TEMPLATE:SOURCE?`
 might return CH2, specifying that the template waveform source for limit tests is the waveform currently stored as the channel 2 waveform.

LIMit:TEMPLate:TOLerance:HORizontal

Sets or returns the amount, in units of horizontal divisions, by which the source waveform is varied horizontally when creating the destination template waveform.

Conditions TBS1000B, TBS1000 and TDS2000C Series models.

Group Limit Test

Syntax `LIMit:TEMPLate:TOLerance:HORizontal <NR3>`
`LIMit:TEMPLate:TOLerance:HORizontal?`

Related Commands [LIMit:TEMPLate](#), [LIMit:TEMPLate:DESTination](#), [LIMit:TEMPLate:SOURce](#), [LIMit:TEMPLate:TOLerance:VERTical](#)

Arguments <NR3> is the amount, in horizontal divisions, by which the source waveform is horizontally modified to generate the template that is stored in the destination reference. The range is 0 to 5 divisions.

Examples `LIMIT:TEMPLATE:TOLERANCE:HORIZONTAL 1.0`
 specifies that the source waveform is modified horizontally by a ± 1.0 horizontal division when generating the template waveform.

`LIMIT:TEMPLATE:TOLERANCE:HORIZONTAL?`
 might return 1.0, specifying that the source waveform is modified horizontally by a ± 1.0 horizontal division when generating the template waveform.

LIMit:TEMPLate:TOLerance:VERTical

Sets or returns the amount, in units of vertical divisions, by which the source waveform is varied vertically when creating the destination template waveform.

Conditions TBS1000B, TBS1000 and TDS2000C Series models.

Group Limit Test

Syntax LIMit:TEMPLate:TOLerance:VERTical <NR3>
LIMit:TEMPLate:TOLerance:VERTical?

Related Commands [LIMit:TEMPLate](#), [LIMit:TEMPLate:DESTination](#), [LIMit:TEMPLate:SOUrce](#), [LIMit:TEMPLate:TOLerance:HORizontal](#)

Arguments <NR3> is the amount, in vertical divisions, by which the source waveform is varied vertically when creating the test waveform. The range is 0 to 5 divisions.

Examples LIMIT:TEMPLATE:TOLERANCE:VERTICAL 1.0
might return 1.0, specifying that the source waveform is vertically varied by ± 1.0 vertical division when creating this test waveform.

LOCK

Enables and disables all front-panel buttons and knobs. There is no front-panel equivalent.

Group Miscellaneous

Syntax LOCK { ALL | NONE }
LOCK?

Arguments ALL disables all front-panel controls.

NONE enables all front-panel controls. This is equivalent to the UNLOCK ALL command.

Examples LOCK ALL locks the front-panel controls.

LOCK? returns NONE when the front-panel controls are enabled by this command.

*LRN? (Query Only)

This is identical to the [SET?](#) query.

Miscellaneous

Group Miscellaneous

Syntax *LRN?

MATH? (Query Only)

Returns the definition for the math waveform.

Group Math

Syntax MATH?

Returns Definition for the math waveform.

Examples MATH? might return the following for an FFT waveform: MATH:DEFINE "FFT(CH1,HANNING)";VERTICAL:POSITION 0.0E0;SCALE 1.0E0;:MATH:FFT:HORIZONTAL:POSITION 5.0E1;SCALE 1.0E0;:MATH:FFT:VERTICAL:POSITION 0.0E0;SCALE 1.0E0

MATH:DEFINE

Performs the specified mathematical operation on the input signal or signals. To activate or deactivate the math waveform, use the [SElect:<wfm>](#) command.

NOTE. Remember that <QString> must be enclosed in quotes. You can use white space characters between words.

Group Math

Syntax MATH:DEFINE <QString>
MATH:DEFINE?

Arguments <QString> specifies a math waveform, and can be one of the following:
 TDS1001, TDS1002, TDS1012, TDS2002, TDS2012 and TDS2022 models;
 TDS210 and TDS220 models (firmware V2.00 and above) with a TDS2MM
 measurement module.

CH1+CH2 CH1-CH2 CH2-CH1 FFT (CH<x> [, <window>]) TDS2004,
 TDS2014 and TDS2024 models; TDS224 model with a TDS2MM measurement
 module.

CH1+CH2 CH3+CH4 CH1-CH2 CH2-CH1 CH3-CH4 CH4-CH3 FFT (CH<x>
 [, <window>]) TDS210 and TDS220 models, firmware below V2.00 with a
 TDS2CMA communications module.

CH1-CH2 CH2-CH1 CH1+CH2 -CH1 -CH2 TDS210 and TDS220 models
 (firmware below V2.00) with a TDS2MM measurement module.

CH1+CH2 (to subtract, invert one of the waveforms through CH<x>:INVert, and
 then add) FFT (CH<x> [, <window>])TDS210 and TDS220 models (firmware
 V2.00) and above with a TDS2CMA communications module.

CH1+CH2 CH1-CH2 CH2-CH1 TDS224 model with a TDS2CMA
 communications module.

CH1+CH2 CH3+CH4 (4-channel models) CH1-CH2 CH2-CH1 CH3-CH4
 (4-channel models) CH4-CH3 (4-channel models) TBS1000B/EDU, TBS1000,
 TDS2000C, TDS1000C-EDU, TDS2000B, TDS1000B, TPS2000B, and TPS2000
 Series.

CH1+CH2 CH3+CH4 (4-channel models) CH1-CH2 CH2-CH1 CH3-CH4
 (4-channel models) CH4-CH3 (4-channel models) CH1*CH2 CH3*CH4
 (4-channel models) FFT (CH<x>[, <window>])

For FFT, the optional <window> argument is HANning, FLATop, or
 RECTangular.

Examples MATH:DEFINE "CH1+CH2" sets the math waveform so that it displays the sum of
 channel 1 and channel 2.

MATH:DEFINE "FFT (CH1, HANNING)" sets the math waveform to display an
 FFT of channel 1 using a Hanning window.

NOTE. You can use this FFT example with TBS1000, TDS2000C,
 TDS1000C-EDU, TDS2000B, TDS1000B, TDS2000, TDS1000, TPS2000B, and
 TPS2000 Series oscilloscopes, as well as a TDS200 Series oscilloscope with a
 TDS2MM measurement module. It is not applicable for TBS1000B/EDU models.

MATH:FFT? (Query Only)

NOTE. You can use this command with TBS1000, TDS2000C, TDS1000C-EDU, TDS2000B, TDS1000B, TDS2000, TDS1000, TPS2000B, and TPS2000 oscilloscopes, as well as a TDS200 oscilloscope with a TDS2MM measurement module.

This command is NOT applicable for the TBS1000B

Returns the current MATH:FFT display settings.

Conditions This command is not applicable for the TBS1000B/EDU.

Group Math

Syntax MATH:FFT?

Examples MATH:FFT? might return the following: MATH:FFT:HORIZONTAL:POSITION 5.0E1;SCALE 1.0E0;:MATH:FFT:VERTICAL:POSITION 0.0E0;SCALE 1.0E0

MATH:FFT:HORizontal:POSition

NOTE. You can use this command with TBS1000, TDS2000C, TDS1000C-EDU, TDS2000B, TDS1000C, TDS2000, TDS1000, TPS2000B, and TPS2000 oscilloscopes, as well as a TDS200 oscilloscope with a TDS2MM measurement module.

Sets or queries the FFT math waveform horizontal position.

Conditions This command is not applicable for the TBS1000B/EDU.

Group Math

Syntax MATH:FFT:HORizontal:POSition <NR3>
MATH:FFT:HORizontal:POSition?

- Arguments** <NR3> specifies the point in the FFT waveform data record to display at the center vertical graticule line. The data record point is a percentage of the total record length, in the range of 0 to 100. The default value is 50. How much data is displayed depends on the FFT Zoom factor setting. The oscilloscope rounds <NR3> to the nearest workable value.
- Examples** MATH:FFT:HORIZONTAL:POSITION 25 sets the FFT waveform horizontal position such that the data at the 25% point of the record is centered on the display.
- MATH:FFT:HORIZONTAL:POSITION? might return 5.0E1, indicating that the 50% point in the data record is horizontally centered on the display.

MATH:FFT:HORizontal:SCALE

NOTE. You can use this command with TBS1000, TDS2000C, TDS1000C-EDU, TDS2000B, TDS1000B, TDS2000, TDS1000, TPS2000B, and TPS2000 oscilloscopes, as well as a TDS200 oscilloscope with a TDS2MM measurement module.

Sets or queries the FFT math waveform horizontal zoom factor.

- Conditions** This command is not applicable for the TBS1000B/EDU
- Group** Math
- Syntax** MATH:FFT:HORizontal:SCALE <NR3>
MATH:FFT:HORizontal:SCALE?
- Arguments** <NR3> specifies the horizontal magnification factor, where the axis of magnification is the center vertical graticule line. Valid zoom factors are 1, 2, 5, and 10. If other values are entered the oscilloscope rounds the value of <NR3> to the nearest valid zoom factor.
- Examples** MATH:FFT:HORIZONTAL:SCALE 5 sets the FFT waveform horizontal zoom factor to X5.
- MATH:FFT:HORIZONTAL:SCALE? might return 2.0E0, indicating that the zoom factor setting is X2.

MATH:FFT:VERTical:POSition

NOTE. You can use this command with TBS1000, TDS2000C, TDS1000C-EDU, TDS2000B, TDS1000B, TDS2000, TDS1000, TPS2000B, and TPS2000 oscilloscopes, as well as a TDS200 oscilloscope with a TDS2MM measurement module.

Sets or queries the FFT math waveform vertical position.

Conditions This command is not applicable for the TBS1000B/EDU.

Group Math

Syntax MATH:FFT:VERTical:POSition <NR3>
MATH:FFT:VERTical:POSition?

Arguments <NR3> specifies the FFT waveform vertical position in divisions.

Examples MATH:FFT:VERTICAL:POSITION 2 sets the FFT waveform vertical position to 2 major divisions above the center horizontal graticule line.

MATH:FFT:VERTICAL:POSITION? might return 5, indicating that the FFT waveform 0 reference point is 5 major divisions from the center horizontal graticule line.

MATH:FFT:VERTical:SCAle

NOTE. You can use this command with TBS1000, TDS2000C, TDS1000C-EDU, TDS2000B, TDS1000B, TDS2000, TDS1000, TPS2000B, and TPS2000 oscilloscopes, as well as a TDS200 oscilloscope with a TDS2MM measurement module.

Sets or queries the FFT math waveform vertical zoom factor.

Conditions This command is not applicable for the TBS1000B/EDU.

Group Math

Syntax	MATH:FFT:VERTical:SCALE <NR3> MATH:FFT:VERTical:SCALE?
Arguments	<NR3> specifies the vertical zoom factor, where the axis of magnification is the center horizontal graticule line. Valid zoom factors are 0.5, 1, 2, 5, and 10. If other values are entered the oscilloscope rounds the value of <NR3> to the nearest valid zoom factor.
Examples	MATH:FFT:VERTICAL:SCALE 5 sets the FFT waveform vertical zoom factor to X5. MATH:FFT:VERTICAL:SCALE? might return 2.0E0, indicating that the zoom factor setting is X2.

MATH:VERTical? (Query Only)

Returns the MATH:VERTical display settings.

Group	Math
Syntax	MATH:VERTical?
Examples	MATH:VERTICAL?? might return MATH:VERTICAL:POSITION 0.0E0;SCALE 5.0E-1, indicating the math waveform position and scale.

MATH:VERTical:POSition

Sets or returns the math waveform display position.

Conditions	This command applies to the TBS1000B/EDU, TBS1000, TDS2000C, TDS1000C-EDU, TDS2000B, TDS1000B, TPS2000B, and TPS2000 Series only.
Group	Math
Syntax	MATH:VERTical:POSition <NR3> MATH:VERTical:POSition?
Arguments	<NR3> specifies the math vertical position in divisions from center screen.

Examples MATH:VERTICAL:POSITION might return -3.0E0, indicating that the math waveform is 3 divisions below center screen.

MATH:VERTical:SCALE

Sets or returns the math waveform display scale in units per division. It is not possible to use this command to set the math scale to a fine scale not achievable from the front panel. This command typically rounds down to an achievable value. If the value input is below the minimum value, then the command will round up.

Conditions This command applies to the TBS1000B/EDU, TBS1000, TDS2000C, TDS1000C-EDU, TDS2000B, TDS1000B, TPS2000B, and TPS2000 Series only.

Group Math

Syntax MATH:VERTical:SCALE <NR3>
MATH:VERTical:SCALE?

Arguments <NR3> specifies the math vertical scale in units per division.

Examples MATH:VERTICAL:SCALE 5.0E0 sets the math vertical scale to five math waveform units per division.

MEASUREMENT? (Query Only)

Returns the current MEASUREMENT settings.

Group Measurement

Syntax MEASUREMENT?

Returns Oscilloscope measurement settings.

Examples MEASUREMENT? might return the following:
MEASUREMENT:MEAS1:TYPE PERIOD;UNITS "S";SOURCE CH1;
MEASUREMENT:MEAS2:TYPE FREQUENCY;UNITS "HZ";SOURCE
CH1; MEASUREMENT:MEAS3:TYPE PK2PK;UNITS "V";SOURCE

```
CH2; MEASUREMENT:MEAS4:TYPE MEAN;UNITS "V";SOURCE CH2;  
:MEASUREMENT:IMMED:TYPE CRMS;UNITS "V";SOURCE CH1
```

MEASUREMENT:CLEARSNAPSHOT (No Query Form)

Clears the existing snapshot results and removes the snapshot window.

Conditions TBS1000B/EDU models only.

Group Measurement

Syntax MEASUREMENT:CLEARSNAPSHOT

MEASUREMENT:GATING

Sets or returns the measurement gating.

Conditions TBS1000B/EDU models only.

Group Measurement

Syntax MEASUREMENT:GATING { OFF | ON | 0 | 1 }

Arguments OFF or <NR1> = 0 turns off gating.
ON or <NR1> ≠ 0 turns on gating.

MEASUREMENT:IMMED? (Query Only)

Returns all immediate measurement setup parameters. Immediate queries and commands are the preferred methods for programming. An immediate measurement selection is not visible or accessible through the display screen or front panel.

Group Measurement

Syntax MEASUREMENT:IMMED?

Returns Immediate measurement setup parameters

Examples MEASUREMENT:IMMED? might return PERIOD;"s";CH1

MEASUREMENT:IMMED:SOURCE[1]

Sets or queries the source for single-source immediate measurements.

Group Measurement

Syntax MEASUREMENT:IMMED:SOURCE[1] { CH<x> | MATH }
MEASUREMENT:IMMED:SOURCE[1]?

Arguments CH<x> specifies the measurement source channel as one of the input channels. The value of <x> can vary from 1 through 4 for 4-channel instruments or 1 through 2 for 2-channel instruments.

MATH specifies the measurement source channel as the math waveform. (TBS1000B/EDU, TBS1000, TDS2000C, TDS1000C-EDU, TDS2000B, TDS1000B, TPS2000B, and TPS2000 Series only)

Examples MEASUREMENT:IMMED:SOURCE CH1 specifies channel 1 as the immediate measurement source.

MEASUREMENT:IMMED:SOURCE2

Sets or queries the secondary source for dual-source immediate measurements. For example, power analysis and phase angle measurements.

Conditions This command applies to the TPS2000B/TPS2000 Series with TPS2PWR1 Power Analysis Module only.

NOTE. This command is only available when the Power Analysis Module application key is installed.

Group Measurement

Syntax MEASUREMENT:IMMED:SOURCE2 { CH<x> | MATH }
MEASUREMENT:IMMED:SOURCE2?

- Arguments** CH<x> specifies the measurement source channel as one of the input channels. The value of <x> can vary from 1 through 4 for 4-channel instruments or 1 through 2 for 2-channel instruments. For power analysis, Source2 must be Amperes.
- MATH specifies the measurement source channel as the math waveform.
- Examples** MEASUREMENT:IMMED:SOURCE2 CH2 specifies channel 2 as the immediate measurement source.

MEASUREMENT:IMMED:TYPE

Sets or queries the immediate measurement type.

NOTE. *Selecting one of the power arguments for this command, without installing the Power Analysis Module application key, will generate an error.*

Group Measurement

Syntax **For non-TBS1000B/EDU models.**
 MEASUREMENT:IMMED:TYPE { CRMS | CURSORRms | DELay | FALL | FREQuency | MAXImum | MEAN | MINImum | NONE | NWidth | PDuty | PERIod | PHase | PK2pk | PWidth | RISE }

For TPS2000 with a TPS2PWR1 Power Analysis Module.

MEASUREMENT:IMMED:TYPE { WFCREST | WFFREQ | WFCYCRMS | TRUEPOWER | VAR | POWERFACTOR | PFPHASE | Phase }

For TBS1000B/EDU models.

MEASUREMENT:IMMED:TYPE { CRMS | FALL | FREQuency | MAXImum | MEAN | MINImum | NONE | NWidth | PERIod | PK2pk | PWidth | RISE | RMS | CURSORRms | PDuty | PHase | DELAYRR | DELAYRF | DELAYFR | DELAYFF | AMPlitude | CMEAN | High | LOW | NDuty | POVERshoot | NOVERshoot | CURSORMean | BURSTWIDTH | AREA | CAREA | PPULSECount | NPULSECount | REDGECOUNT | FEDGECOUNT }

MEASUREMENT:IMMED:TYPE?

- Arguments** CRMS is the true Root Mean Square voltage of the first complete cycle in the waveform.
- CURSORRms (TBS1000B/EDU, TBS1000, TDS2000C, TDS1000C-EDU Series) is the true Root Mean Square (RMS) value of the selected waveform data, between the start point and the end point.

DElay (TBS1000, TDS2000C, TDS1000C-EDU Series) (not applicable for TBS1000B/EDU models) is the delay from one waveform's edge event to another.

FALL (TBS1000B/EDU, TBS1000, TDS2000C, TDS1000C-EDU, TDS2000B, TDS1000B, TDS2000, TDS1000, TDS200 Series with a TDS2MM measurement module, TPS2000B, and TPS2000 Series only) is the fall time between 90% and 10% of the first falling edge of the waveform. Falling edge must be displayed to measure. The oscilloscope automatically calculates the 10% and 90% measurement points.

FREquency is the reciprocal of the period measured in Hertz.

MAXImum (TBS1000B/EDU, TBS1000, TDS2000C, TDS1000C-EDU, TDS2000B, TDS1000B, TDS2000, TDS1000, TPS2000B, and TPS2000 Series only) is the value of the largest point in the waveform.

MEAN is the arithmetic mean over the entire waveform.

MINImum (TBS1000B/EDU, TBS1000, TDS2000C, TDS1000C-EDU, TDS2000B, TDS1000B, TDS2000, TDS1000, TPS2000B, and TPS2000 Series only) is the value of the smallest point in the waveform.

NWIdth (TBS1000B/EDU, TBS1000, TDS2000C, TDS1000C-EDU, TDS2000B, TDS1000B, TDS2000, TDS1000, TDS200 Series with a TDS2MM measurement module, TPS2000B, and TPS2000 Series only) is the negative pulse width between the first falling edge and the next rising edge at the waveform 50% level. Falling and rising edges must be displayed to measure. The oscilloscope automatically calculates the 50% measurement point.

PDuty (TBS1000B/EDU, TBS1000, TDS2000C, TDS1000C-EDU Series) is the ratio of the pulse width to the signal period, expressed as a percentage.

PERIod is the duration, in seconds, of the first complete cycle in the waveform.

PHase (TBS1000B/EDU, TBS1000, TDS2000C, TDS1000C-EDU Series) is the phase difference from the selected waveform to the designated waveform.

PK2pk is the absolute difference between the maximum and minimum amplitude.

PWIdth (TBS1000B/EDU, TBS1000, TDS2000C, TDS1000C-EDU, TDS2000B, TDS1000B, TDS2000, TDS1000, TDS200 Series with a TDS2MM measurement module, TPS2000B, and TPS2000 Series only) is the positive pulse width between the first rising edge and the next falling edge at the waveform 50% level. Rising and falling edges must be displayed to measure. The oscilloscope automatically calculates the 50% measurement point.

RIse (TBS1000B/EDU, TBS1000, TDS2000C, TDS1000C-EDU, TDS2000B, TDS1000B, TDS2000, TDS1000, TDS200 Series with a TDS2MM measurement module, TPS2000B, and TPS2000 Series only) is the rise time between 10% and 90% of the first rising edge of the waveform. Rising edge must be displayed to measure. The oscilloscope automatically calculates the 10% and 90% measurement points.

The following are for use with the TPS2000 Series with the TPS2PWR1 Power Analysis Module:

PFPHASE (TPS2000B/TPS2000 Series with TPS2PWR1 Power Analysis Module only) is the phase angle measurement in degrees. Source 1 must be volts; source 2 must be Amperes.

PHAsE (TPS2000B/TPS2000 Series with TPS2PWR1 Power Analysis Module only) is the measurement of phase between source 1 and source 2, in degrees.

POWERFACTOR (TPS2000B/TPS2000 Series with TPS2PWR1 Power Analysis Module only) is the true power factor ratio measurement. Source 1 must be volts; source 2 must be Amperes.

TRUEPOWER (TPS2000B/TPS2000 Series with TPS2PWR1 Power Analysis Module only) is the true power measurement in Watts. Source 1 must be volts; source 2 must be Amperes.

VAR (TPS2000B/TPS2000 Series with TPS2PWR1 Power Analysis Module only) is the reactive power measurement. Source 1 must be volts; source 2 must be Amperes.

WFCREST (TPS2000B/TPS2000 Series with TPS2PWR1 Power Analysis Module only) is the measurement of the maximum value to the cycle RMS value of the waveform, a unit-less ratio.

WFCYCRMS (TPS2000B/TPS2000 Series with TPS2PWR1 Power Analysis Module only) is the measurement of RMS voltage calculated over the first cycle, using the min-max, high-low method.

WFFREQ (TPS2000B/TPS2000 Series with TPS2PWR1 Power Analysis Module only) is the measurement of frequency using the min-max, high-low method.

DELAYRR (TBS1000B/EDU Series only) is the time between the mid reference (default 50%) amplitude point of two different rising waveforms.

DELAYRF (TBS1000B/EDU Series only) is the time between the mid reference (default 50%) amplitude point of the rising and falling waveforms.

DELAYFR (TBS1000B/EDU Series only) is the time between the mid reference (default 50%) amplitude point of the falling and rising waveforms.

DELAYFF (TBS1000B/EDU Series only) is the between the mid reference (default 50%) amplitude point of the two different falling waveforms.

Amplitude (TBS1000B/EDU Series only) is the high value less the low value measured over the entire waveform or gated region.

CMEAN (TBS1000B/EDU Series only) (cycle mean) is the arithmetic mean over the first cycle in the waveform or the first cycle in the gated region.

HIGH (TBS1000B/EDU Series only) is the value used as 100% whenever high reference, mid reference, or low reference values are needed, such as in fall time or rise time measurements. Calculate using either the min-max or histogram

method. The min-max method uses the maximum value found. The histogram method uses the most common value found above the midpoint. This value is measured over the entire waveform or gated region.

LOW (TBS1000B/EDU Series only) is the value used as 0% whenever high reference, mid reference, or low reference values are needed, such as in fall time or rise time measurements. Calculate using either the min-max or histogram method. The min-max method uses the minimum value found. The histogram method uses the most common value found below the midpoint. This value is measured over the entire waveform or gated region.

NDuty (TBS1000B/EDU Series only) is the ratio of the negative pulse width to the signal period expressed as a percentage. The duty cycle is measured on the first cycle in the waveform or gated region.

POVERshoot (TBS1000B/EDU Series only) is measured over the entire waveform or gated region and is expressed as:
 Positive Overshoot = $(\text{Maximum} - \text{High}) / \text{Amplitude} * 100\%$.

NOVERshoot (TBS1000B/EDU Series only) is measured over the entire waveform or gated region and is expressed as:
 Negative Overshoot = $(\text{Low} - \text{Minimum}) / \text{Amplitude} * 100\%$.

CURSORMean (TBS1000B/EDU Series only) is the arithmetic mean of the waveform data from the selected starting to the ending point.

BURSTWIDTH (TBS1000B/EDU Series only) is the duration of a burst (a series of transient events) and is measured over the entire waveform or gated region.

AREA (TBS1000B/EDU Series only) is a voltage over time measurement. It returns the area over the entire waveform or gated region in volt-seconds. Area measured above ground is positive. Area measured below ground is negative.

CAREA (TBS1000B/EDU Series only) (cycle area) is a voltage over time measurement. The measurement is the area over the first cycle in the waveform or the first cycle in the gated region expressed in volt-seconds. The area above the common reference point is positive. The area below the common reference point is negative.

PPULSECount (TBS1000B/EDU Series only) is the number of positive pulses that rise above the mid reference crossing in the waveform or gated region.

NPULSECount (TBS1000B/EDU Series only) is the number of negative pulses that fall below the mid reference crossing in the waveform or gated region.

REDGECCount (TBS1000B/EDU Series only) is the number of positive transitions from the low reference value to the high reference value in the waveform or gated region.

FEDGECount (TBS1000B/EDU Series only) is the number of negative transitions from the high reference value to the low reference value in the waveform or gated region.

Examples MEASUREMENT:IMMED:TYPE FREQUENCY defines the immediate measurement to be a frequency measurement.

MEASUREMENT:IMMED:UNITS? (Query Only)

Returns the units for the immediate oscilloscope measurement.

Group Measurement

Syntax MEASUREMENT:IMMED:UNITS?

Returns <QString> returns "V" for volts, "s" for seconds, or "Hz" for Hertz.

For the TBS1000B/EDU, TBS1000, TDS2000C, TDS1000C-EDU, TDS2000B, TDS1000B, TPS2000B, and TPS2000 Series, <QString> can also return the following:

- A for amps
- VA for volt-amperes
- AA for amperes*amperes
- VV for volts*volts

You can also use this command for undefined math waveforms.

Examples MEASUREMENT:IMMED:UNITS? might return "s", indicating that the unit for the immediate measurement is seconds.

MEASUREMENT:IMMED:VALUE? (Query Only)

Executes the immediate oscilloscope measurement specified by the MEASUREMENT:IMMED:TYPE command. The measurement is taken on the source specified by the MEASUREMENT:IMMED:SOURCE command. Immediate queries and commands are the preferred measurement method for programming.

To check whether the measurement was successful, use the *ESR? query followed by the EVENT? or ALLEv? queries to read the Standard Event Status Register (SESR).

NOTE. *If the channel specified by MEASUREMENT:IMMED:SOURCE is not currently displayed, the oscilloscope generates event 2225 and returns 9.9E37.*

If Trigger View is active, Scan mode is in effect, or the display format is set to XY, this query returns 9.9E37 and generates event 221 (Settings conflict)

When math is FFT, turned on, and used as a measurement source, attempting to query the measurement value returns 9.9e37 and raises error 2225 (no waveform to measure).

Group	Measurement
Syntax	MEASUREMENT:IMMED:VALUE?
Related Commands	*ESR?, EVENT?
Returns	<NR3>
Examples	<p>MEASUREMENT:IMMED:VALUE? might return 28.75E6 if you are measuring the frequency of a 28.75 MHz signal.</p> <p>MEASUREMENT:IMMED:VALUE? might return 9.9E37, which means that the channel specified by MEASUREMENT:IMMED:SOURCE is not currently displayed.</p> <p>*ESR? after a measurement query might return 16, indicating that there are error messages in the queue.</p> <p>ALLEV might return ALLEV 541,"Measurement warning, Low signal amplitude: "</p>

MEASUREMENT:MEAS<x>? (Query Only)

Returns all measurement parameters for the displayed oscilloscope periodic measurement specified by <x>. Where <x> identifies the measurement, 1 through 4 for the TDS200 Series, and 1 through 5 for the TBS1000, TDS2000C, TDS1000C-EDU, TDS2000B, TDS1000B, TDS2000, TDS1000, TPS2000B, and TPS2000 Series, and 1 through 6 for the TBS1000B/EDU Series.

Group	Measurement
Syntax	MEASUREMENT:MEAS<x>?

Returns Settings for the specified measurement source.

Examples MEASUREMENT:MEAS3? might return PERIOD;"s";CH1

MEASUREMENT:MEAS<x>:SOURCE

Sets or queries the source for an automated measurement. Where <x> identifies the measurement, 1 through 4 for the TDS200 Series, and 1 through 5 for the TBS1000, TDS2000C, TDS1000C-EDU, TDS2000B, TDS1000B, TDS2000, TDS1000, TPS2000B, and TPS2000 Series, and 1 through 6 for the TBS1000B/EDU Series.

This is equivalent to selecting the measurement source in the MEASURE menu.

Group Measurement

Syntax MEASUREMENT:MEAS<x>:SOURCE { CH<y> | MATH }
MEASUREMENT:MEAS<x>:SOURCE?

Arguments CH<y> specifies the input channel source for the measurement.

MATH specifies the measurement source channel as the math waveform. (TBS1000B/EDU, TBS1000, TDS2000C, TDS1000C-EDU, TDS2000B, TDS1000B, TPS2000B, and TPS2000 Series only)

Examples MEASUREMENT:MEAS2:SOURCE CH1 sets the source for Measurement 2 to channel 1.

MEASUREMENT:MEAS<x>:TYPE

Sets or queries the on-screen periodic oscilloscope measurement type for the measurement specified by <x>. Where <x> identifies the measurement, 1 through 4 for the TDS200 Series, and 1 through 5 for the TBS1000, TDS2000C, TDS1000C-EDU, TDS2000B, TDS1000B, TDS2000, TDS1000, TPS2000B, and TPS2000 Series, and 1 through 6 for the TBS1000B/EDU Series.

This is equivalent to selecting the measurement type in the MEASURE menu. Setting the type to anything other than NONE displays the MEASURE menu on the screen.

NOTE. *You should use the MEASUREMENT:IMMED command with programming to take measurements, as this is preferred to the MEASUREMENT:MEAS<x> command.*

Group Measurement

Syntax **For non-TBS1000B/EDU models.**
 MEASUREMENT:MEAS<x>:TYPE { CRMS | CURSORRms | DELay | FALL | FREQUency | MAXImum | MEAN | MINImum | NONE | NWidth | PDuty | PERIoD | PHASE | PK2pk | PWidth | RISE }

For TBS1000B/EDU models.

MEASUREMENT:MEAS<x>:TYPE { CRMS | FALL | FREQUency | MAXImum | MEAN | MINImum | NONE | NWidth | PERIoD | PK2pk | PWidth | RISE | RMS | CURSORRms | PDUTy | PHASE | DELAYRR | DELAYRF | DELAYFR | DELAYFF | AmPliTude | CMEAN | High | LOW | NDUTy | POVERshoot | NOVERshoot | CURSORMean | BURSTWIDth | AREA | CAREA | PPULSECount | NPULSECount | REDGECOUNT | FEDGECOUNT }

MEASUREMENT:MEAS<x>:TYPE?

Arguments CRMS is the true Root Mean Square voltage of the first complete cycle in the waveform.

CURSORRms (TBS1000B/EDU, TBS1000, TDS2000C, TDS1000C-EDU Series) is the true Root Mean Square (RMS) value of the selected waveform data, between the start point and the end point.

DELay (TBS1000, TDS2000C, TDS1000C-EDU Series) (not applicable for TBS1000B/EDU models) is the delay from one waveform's edge event to another.

FALL (TBS1000B/EDU, TBS1000, TDS2000C, TDS1000C-EDU, TDS2000B, TDS1000B, TDS2000, TDS1000, TDS200 Series with a TDS2MM measurement module, TPS2000B, and TPS2000 Series only) is the fall time between 90% and 10% of the first falling edge of the waveform. Falling edge must be displayed to measure. The oscilloscope automatically calculates the 10% and 90% measurement points.

FREQUency is the reciprocal of the period measured in Hertz.

MAXImum (TBS1000B/EDU, TBS1000, TDS2000C, TDS1000C-EDU, TDS2000B, TD1000B, TDS2000, TDS1000, TPS2000B, and TPS2000 Series only) is the value of the largest point in the waveform.

MEAN is the arithmetic mean over the entire waveform.

MINImum (TBS1000B/EDU, TBS1000, TDS2000C, TDS1000C-EDU, TDS2000B, TDS1000B, TDS2000, TDS1000, TPS2000B, and TPS2000 Series only) is the value of the smallest point in the waveform.

NONE disables the measurement specified by <x>.

NWidth (TBS1000B/EDU, TBS1000, TDS2000C, TDS1000C-EDU, TDS2000B, TDS1000B, TDS2000, TDS1000, TDS200 Series with a TDS2MM measurement module, TPS2000B, and TPS2000 Series only) is the negative pulse width between the first falling edge and the next rising edge at the waveform 50% level. Falling and rising edges must be displayed to measure. The oscilloscope automatically calculates the 50% measurement point.

PDuty (TBS1000B/EDU, TBS1000, TDS2000C, and TDS1000C-EDU Series) is the ratio of the pulse width to the signal period, expressed as a percentage.

PERIOD is the duration, in seconds, of the first complete cycle in the waveform.

PHase (TBS1000B/EDU, TBS1000, TDS2000C, and TDS1000C-EDU Series) is the phase difference from the selected waveform to the designated waveform.

PK2pk is the absolute difference between the maximum and minimum amplitude.

PWidth (TBS1000B/EDU, TBS1000, TDS2000C, TDS1000C-EDU, TDS2000B, TDS1000B, TDS2000, TDS1000, TDS200 Series with a TDS2MM measurement module, TPS2000B, and TPS2000 Series only) is the positive pulse width between the first rising edge and the next falling edge at the waveform 50% level. Rising and falling edges must be displayed to measure. The oscilloscope automatically calculates the 50% measurement point.

RIse (TBS1000B/EDU, TBS1000, TDS2000C, TDS1000C-EDU, TDS2000B, TDS1000B, TDS2000, TDS1000, TDS200 Series with a TDS2MM measurement module, TPS2000B, and TPS2000 Series only) is the rise time between 10% and 90% of the first rising edge of the waveform. Rising edge must be displayed to measure. The oscilloscope automatically calculates the 10% and 90% measurement points.

DELAYRR (TBS1000B/EDU Series only) is the time between the mid reference (default 50%) amplitude point of two different rising waveforms.

DELAYRF (TBS1000B/EDU Series only) is the time between the mid reference (default 50%) amplitude point of the rising and falling waveforms.

DELAYFR (TBS1000B/EDU Series only) is the time between the mid reference (default 50%) amplitude point of the falling and rising waveforms.

DELAYFF (TBS1000B/EDU Series only) is the between the mid reference (default 50%) amplitude point of the two different falling waveforms.

Amplitude (TBS1000B/EDU Series only) is the high value less the low value measured over the entire waveform or gated region.

CMEAN (TBS1000B/EDU Series only) (cycle mean) is the arithmetic mean over the first cycle in the waveform or the first cycle in the gated region.

HIGH (TBS1000B/EDU Series only) is the value used as 100% whenever high reference, mid reference, or low reference values are needed, such as in fall time or rise time measurements. Calculate using either the min-max or histogram method. The min-max method uses the maximum value found. The histogram

method uses the most common value found above the midpoint. This value is measured over the entire waveform or gated region.

LOW (TBS1000B/EDU Series only) is the value used as 0% whenever high reference, mid reference, or low reference values are needed, such as in fall time or rise time measurements. Calculate using either the min-max or histogram method. The min-max method uses the minimum value found. The histogram method uses the most common value found below the midpoint. This value is measured over the entire waveform or gated region.

NDuty (TBS1000B/EDU Series only) is the ratio of the negative pulse width to the signal period expressed as a percentage. The duty cycle is measured on the first cycle in the waveform or gated region.

POVERshoot (TBS1000B/EDU Series only) is measured over the entire waveform or gated region and is expressed as:

$$\text{Positive Overshoot} = (\text{Maximum} - \text{High}) / \text{Amplitude} * 100\%.$$

NOVERshoot (TBS1000B/EDU Series only) is measured over the entire waveform or gated region and is expressed as:

$$\text{Negative Overshoot} = (\text{Low} - \text{Minimum}) / \text{Amplitude} * 100\%.$$

CURSORMean (TBS1000B/EDU Series only) is the arithmetic mean of the waveform data from the selected starting to the ending point.

BURSTWIDth (TBS1000B/EDU Series only) is the duration of a burst (a series of transient events) and is measured over the entire waveform or gated region.

AREA (TBS1000B/EDU Series only) is a voltage over time measurement. It returns the area over the entire waveform or gated region in volt-seconds. Area measured above ground is positive. Area measured below ground is negative.

CAREA (TBS1000B/EDU Series only) (cycle area) is a voltage over time measurement. The measurement is the area over the first cycle in the waveform or the first cycle in the gated region expressed in volt-seconds. The area above the common reference point is positive. The area below the common reference point is negative.

PPULSECount (TBS1000B/EDU Series only) is the number of positive pulses that rise above the mid reference crossing in the waveform or gated region.

NPULSECount (TBS1000B/EDU Series only) is the number of negative pulses that fall below the mid reference crossing in the waveform or gated region.

REDGECCount (TBS1000B/EDU Series only) is the number of positive transitions from the low reference value to the high reference value in the waveform or gated region.

FEDGECCount (TBS1000B/EDU Series only) is the number of negative transitions from the high reference value to the low reference value in the waveform or gated region.

Examples `MEASUREMENT:MEAS3:TYPE` CRMS specifies MEAS3 to calculate the true Root Mean Square value.

MEASUREMENT:MEAS<x>:UNITS? (Query Only)

Returns the units for the oscilloscope measurement specified by `MEASUREMENT:MEAS<x>:TYPE`. Where <x> identifies the measurement, 1 through 4 for the TDS200 Series, and 1 through 5 for the TBS1000, TDS2000C, TDS1000C-EDU, TDS2000B, TDS1000B, TDS2000, TDS1000, TPS2000B, and TPS2000 Series, and 1 through 6 for the TBS1000B/EDU Series.

Group Measurement

Syntax `MEASUREMENT:MEAS<x>:UNITS?`

Returns <QString> returns "V" for volts, "s" for seconds, or "Hz" for Hertz, or a null string if `MEASUREMENT:MEAS<x>:TYPE` is set to NONE.

For the TBS1000B/EDU, TBS1000, TDS2000C, TDS1000C-EDU, TDS2000B, TDS1000B, TPS2000B, and TPS2000 Series, <QString> can also return the following:

- A for amps
- VA for volt-amperes
- AA for amperes*amperes
- VV for volts*volts

You can also use this command for undefined math waveforms.

Examples `MEASUREMENT:MEAS3:UNITS` might return "V", indicating the units for measurement 3 are volts.

MEASUREMENT:MEAS<x>:VALUE? (Query Only)

Returns the value that was calculated for the oscilloscope on-screen periodic measurement specified by <x>. Where <x> identifies the measurement, 1 through 4 for the TDS200 Series, and 1 through 5 for the TBS1000, TDS2000C, TDS1000C-EDU, TDS2000B, TDS1000B, TDS2000, TDS1000, TPS2000B, and TPS2000 Series, and 1 through 6 for the TBS1000B/EDU Series.

This value is a display value and will be updated about every 1/2 second if both the MEASURE menu and the MEAS<x> source channel are displayed. If you are

acquiring at a slow sweep rate, the oscilloscope may take longer than 1/2 second to update.

NOTE. *MEASurement:IMMed is usually more useful than MEASurement:MEAS<x> when using the oscilloscope with external devices.*

If MEASurement:MEAS<x>:TYPE is set to NONE, MEASurement:MEAS<x>:VALue generates event message 2231 (Measurement error, measurement is not activated) and returns 9.9E37.

If the channel specified by MEASurement:MEAS<x>:SOURCE is not displayed on the oscilloscope, the oscilloscope generates event message 2225 (Measurement error, no waveform to measure) and returns 9.9E37.

Use the *ESR? and ALLEv? queries to check for measurement errors. An example error is "2204, Low signal amplitude".

NOTE. *If Trigger View is active, scan mode is in effect, or the display format set to XY, this query generates event 221 (Settings conflict) and returns 9.9E37.*

NOTE. *When math is FFT, turned on, and used as a measurement source, attempting to query the measurement value returns 9.9e37 and raises error 2225 (no waveform to measure).*

Group	Measurement
Syntax	MEASurement:MEAS<x>:VALue?
Returns	<NR3>
Examples	MEASUREMENT:MEAS3:VALUE might return 28.75E6 if measurement number three is frequency.

MEASurement:SNAPSHOT (No Query Form)

Sets the measurement snapshot feature.

Conditions TBS1000B/EDU models only.

Group	Measurement
Syntax	MEASUREMENT:SNAPSHOT

MEASUREMENT:SNAPSOURCE

Sets or returns the snapshot source.

Conditions TBS1000B/EDU models only.

Group Measurement

Syntax MEASUREMENT:SNAPSOURCE { CH1 | CH2 | MATH }
MEASUREMENT:SNAPSOURCE?

*OPC

Generates the operation complete message in the Standard Event Status Register (SESR) when all pending commands that generate an OPC message are complete. The *OPC? query places the ASCII character "1" into the output queue when all such OPC commands are complete. The *OPC? response is not available to read until all pending operations finish. (See page 3-224, *Status and Events*.)

The *OPC command allows you to synchronize the operation of the oscilloscope with your application program. (See page 3-7, *Synchronization Methods*.)

Certain oscilloscope operations can affect the *OPC response. (See Table 3-3 on page 3-7.)

Group Status and Error

Syntax *OPC
*OPC?

Related Commands [BUSY?](#), [*WAI](#)

Examples *OPC generates the operation complete message in the SESR at the completion of all pending OPC operations.

*OPC? might return 1 to indicate that all pending OPC operations are finished.

PICTBridge:DATEPRINT

Sets the date and time to be printed on the hard copy if the feature is available on the compatible printer. This command is equivalent to setting the Date Print option in the UTILITY > Options > Printer Setup > PRINT Button > Prints menu of TBS1000B/EDU, TBS1000, TDS2000C, TDS1000C-EDU, TDS2000B, and TDS1000B oscilloscopes.

Conditions This command applies to the TBS1000B/EDU, TBS1000, TDS2000C, TDS1000C-EDU, TDS2000B, and TDS1000B Series only.

Group PictBridge

Syntax PICTBridge:DATEPRINT { DEFLT | OFF | ON }
PICTBridge:DATEPRINT?

Arguments DEFLT will match the default setting of the printer: on or off.

ON prints the date and time on the hard copy.

OFF does not print the date and time.

Examples PICTBRIDGE:DATEPRINT? might return ON if the printer is set to print the date and time.

PICTBridge:DEF (No Query Form)

Sets the arguments for all PictBridge commands to their default values. The default values are the same as the default settings for the printer. This command is equivalent to setting all the options to default in the UTILITY > Options > Printer Setup > PRINT Button > Prints menu of TBS1000B/EDU, TBS1000, TDS2000C, TDS1000C-EDU, TDS2000B, and TDS1000B oscilloscopes.

NOTE. *The HARDCopy:BUTTON, HARDCopy:INKSaver, and HARDCopy:LAYOUT commands apply to the TBS1000B/EDU, TBS1000, TDS2000C, TDS1000C-EDU, TDS2000B, and TDS1000B oscilloscopes.*

Conditions This command applies to the TBS1000B/EDU, TBS1000, TDS2000C, TDS1000C-EDU, TDS2000B, and TDS1000B Series only.

Group PictBridge

Syntax PICTBridge:DEF

Examples PICTBRIDGE:DEF sets the parameters for the compatible printer to the default values.

PICTBridge:IDPRINT

Sets the oscilloscope model and serial number to be printed on the hard copy if the feature is available on the compatible printer. This command is equivalent to setting the ID Print option in the UTILITY > Options > Printer Setup > PRINT Button > Prints menu of TBS1000B/EDU, TBS1000, TDS2000C, TDS1000C-EDU, TDS2000B, and TDS1000B oscilloscopes.

Conditions This command applies to the TBS1000B/EDU, TBS1000, TDS2000C, TDS1000C-EDU, TDS2000B, and TDS1000B Series only.

Group PictBridge

Syntax PICTBridge:IDPRINT { DEFLT | OFF | ON }
PICTBridge:IDPRINT?

Arguments DEFLT will match the default setting of the printer: on or off.
ON prints the model and serial number on the hard copy.
OFF does not print the model and serial number.

Examples PICTBRIDGE:IDPRINT? might return ON if the printer is set to print the model and serial number.

PICTBridge:IMAGESIZE

Sets the size of the image to print. This command is equivalent to setting the Image Size option in the UTILITY > Options > Printer Setup > PRINT Button > Prints menu of TBS1000B/EDU, TBS1000, TDS2000C, TDS1000C-EDU, TDS2000B, and TDS1000B oscilloscopes.

Conditions This command applies to the TBS1000B/EDU, TBS1000, TDS2000C, TDS1000C-EDU, TDS2000B, and TDS1000B Series only.

Group	PictBridge
Syntax	<pre> PICTBridge:IMAGESIZE { DEFLT IN2P5BY3P25 L IN4BY6 L2 IN8BY10 L4 E CARD HAGAKIPC CM6BY8 CM7BY10 CM9BY13 CM10BY15 CM13BY18 CM15BY21 CM18BY24 A4 LETTER } PICTBridge:IMAGESIZE? </pre>
Arguments	<p>DEFLT specifies the default size of the image to print.</p> <p>All image size arguments are valid if the paper size can accommodate the image. The paper size should be larger than the image size.</p>
Examples	PICTBRIDGE:IMAGESIZE? might return LETTER as the size of the image to print.

PICTBridge:PAPERSIZE

Sets the paper size of the hard copy from those available on the compatible printer. This command is equivalent to setting the Paper Size option in the UTILITY > Options > Printer Setup > PRINT Button > Prints menu of TBS1000B/EDU, TBS1000, TDS2000C, TDS1000C-EDU, TDS2000B, and TDS1000B oscilloscopes.

Conditions	This command applies to the TBS1000B/EDU, TBS1000, TDS2000C, TDS1000C-EDU, TDS2000B, and TDS1000B Series only.
Group	PictBridge
Syntax	<pre> PICTBridge:PAPERSIZE { DEFLT L L2 HAGAKIPCARD MM54BY86 MM100BY150 IN4BY6 IN8BY10 LETTER IN11BY17 A0 A1 A2 A3 A4 A5 A6 A7 A8 A9 B0 B1 B2 B3 B4 B5 B6 B7 B8 B9 ROLL89MM ROLL127MM ROLL100MM ROLL210MM } PICTBridge:PAPERSIZE? </pre>
Arguments	<p>DEFLT specifies the default paper size of the printer.</p> <p>Any paper size argument is valid when the paper is available for the printer.</p>
Examples	PICTBRIDGE:PAPERSIZE? might return LETTER as the selected paper size for the printer.

PICTBridge:PAPERTYPE

Sets the type of paper from those available on the compatible printer. This command is equivalent to setting the Paper Type option in the UTILITY > Options > Printer Setup > PRINT Button > Prints menu of TBS1000B/EDU, TBS1000, TDS2000C, TDS1000C-EDU, TDS2000B, and TDS1000B oscilloscopes.

Conditions This command applies to the TBS1000B/EDU, TBS1000, TDS2000C, TDS1000C-EDU, TDS2000B, and TDS1000B Series only.

Group PictBridge

Syntax PICTBridge:PAPERTYPE { DEFLT | PLAIN | PHOTO | FASTPHOTO }
PICTBridge:PAPERTYPE?

Arguments DEFLT specifies the type of paper used by default in the printer.

Examples PICTBRIDGE:PAPERTYPE might return PLAIN as the paper type.

PICTBridge:PRINTQUAL

Sets the quality of the print from those available on the compatible printer. This command is equivalent to setting the Print Quality option in the UTILITY > Options > Printer Setup > PRINT Button > Prints menu of TBS1000B/EDU, TBS1000, TDS2000C, TDS1000C-EDU, TDS2000B, and TDS1000B oscilloscopes.

Conditions This command applies to the TBS1000B/EDU, TBS1000, TDS2000C, TDS1000C-EDU, TDS2000B, and TDS1000B Series only.

Group PictBridge

Syntax PICTBridge:PRINTQUAL { DEFLT | NRMAL | FINE | DRAFT }
PICTBridge:PRINTQUAL?

Arguments DEFLT specifies the quality of the hard copy used by default on the printer.

NRMAL prints a normal quality hard copy.

FINE prints a high quality hard copy.

DRAFT prints a low quality hard copy.

Examples PICTBRIDGE:PRINTQUAL? might return DRAFT as the quality of the print.

POWER? (Query Only)

Returns the current POWER measurement settings.

Group Power and Battery-Related

Syntax POWER?

Examples POWER? might return the following: POWER:AC:PRESENT 1;:POWER:BATTERY1:GASGAUGE 0 ;STATUS NOTINSTALLED;:POWER:BATTERY2:GASGAUGE 0 ;STATUS NOTINSTALLED;:POWER:BATTERIES:TIME 0; POWER:BUTTONLIGHT 1

POWER:AC:PRESENT? (Query Only)

Returns a statement indicating whether the oscilloscope is being powered by battery or AC.

Group Power and Battery-Related

Syntax POWER:AC:PRESENT?

Returns 0 if the oscilloscope is being powered by battery. 1 if the oscilloscope is being powered by AC.

Examples POWER:AC:PRESENT? might return 0, specifying that the oscilloscope is being powered by its battery.

POWER:BATTERY<x>:GASgauge? (Query Only)

Returns the amount of charge remaining in Battery x, where x is Battery 1 or Battery 2.

This command is valid only if POWER:BATTERY<x>:STATUS? returns NORMAL.

Group	Power and Battery-Related
Syntax	POWER : BATTERY<x> : GASgauge?
Returns	<NR1>, a number between 0 and 100, indicates the charge remaining in the battery. 0 indicates the battery is fully discharged. 100 indicates the battery is fully charged.
Examples	POWER : BATTERY1 : GASGAUGE? might return 60, specifying that battery 1 is 60% charged.

POWER:BATTERY<x>:STATUS? (Query Only)

Returns the status of battery x, where x is Battery 1 or Battery 2.

Group	Power and Battery-Related
Syntax	POWER : BATTERY<x> : STATUS?
Returns	FULL indicates that the battery is fully charged. DISCHARGED indicates that the battery has no charge remaining. The battery can be discharged, but still report a small percent remaining. UNCALIBRATED indicates that the oscilloscope cannot predict the battery charge remaining. NOTINSTALLED indicates that the battery is not installed in the oscilloscope. NORMAL indicates that the battery status is not any of the states in this list.
Examples	POWER : BATTERY1 : STATUS? might return FULL, which indicates that Battery 1 is at maximum capacity.

POWER:BATTERIES:TIME? (Query Only)

Returns the charge remaining in both batteries. This value is not accurate when either battery is uncalibrated.

Group	Power and Battery-Related
--------------	---------------------------

- Syntax** `POWER:BATTERIES:TIME?`
- Returns** `<NR1>` specifies the operating time remaining for both batteries in minutes.
- Examples** `POWER:BATTERIES:TIME?` might return `10`, specifying that the battery or batteries installed can provide about 10 minutes of power to the oscilloscope.

POWER:BUTTONLIGHT

Turns the lights on the front-panel buttons of the TPS2000 Series and TPS2000B Series on and off.

- Conditions** This command applies to the TPS2000 Series and TPS2000B Series only.
- Group** Power and Battery-Related
- Syntax** `POWER:BUTTONLIGHT <NR1> | ON | OFF`
`POWER:BUTTONLIGHT?`
- Arguments** `ON` or `<NR1> ≠ 0` turns the lights on.
`OFF` or `<NR1> = 0` turns the lights off.
- Examples** `POWER:BUTTONLIGHT ON` sets the front-panel button lights to on.

POWERANALYSIS:SOURces

Sets or queries the Power Analysis sources. This command is equivalent to setting the Sources option in the Power Analysis menu. It does not affect the sources for any customer-visible PI measurements.

- Conditions** This command applies to the TPS2000 Series and TPS2000B Series only.
- Group** Power Measurement
- Syntax** `POWERANALYSIS:SOURces { CH1CH2 | CH3CH4 }`
`POWERANALYSIS:SOURces?`

Arguments CH1CH2 selects Channel 1 and Channel 2 as the power analysis source.
CH3CH4 selects Channel 3 and Channel 4 as the power analysis source.

NOTE. *The "CH3CH4" argument is only valid for instruments with four channels.*

Examples POWERANALYSIS:SOURCES CH1CH2 specifies Channel 1 and Channel 2 as the power analysis source.
POWERANALYSIS:SOURCES? might return CH1CH2.

*PSC (No Query Form)

Sets and queries the power-on status flag that controls the automatic power-on handling of the DESER, SRER, and ESER registers. When *PSC is true, the DESER register is set to 255 and the SRER and ESER registers are set to 0 at power on. When *PSC is false, the current values in the DESER, SRER, and ESER registers are preserved in nonvolatile memory when power is shut off and are restored at power on. Refer to the *Status and Events* section for more information.

Group Status and Error

Syntax *PSC <NR1>
*PSC?

Related Commands [DESE](#), [*ESE](#), [FACTory](#), [*RST](#)

Arguments <NR1> = 0 sets the power-on status clear flag to false, disables the power on clear, and allows the oscilloscope to possibly assert SRQ after power on.
<NR1> ≠ 0 sets the power-on status clear flag true. Sending *PSC 1, therefore, enables the power-on status clear and prevents any SRQ assertion after power on.

Examples *PSC 0 sets the power-on status clear flag to false.
*PSC? might return the value 1, showing that the power-on status clear flag is set to true.

*RCL (No Query Form)

Restores the state of the oscilloscope from a copy of its settings stored in memory. (The settings are stored using the *SAV command.) This command is equivalent to RECALL:SETUp, and performs the same function as the Recall Saved Setup item in the front-panel Save/Recall Setup menu.

Group Save and Recall

Syntax *RCL <NR1>

Related Commands [FACTory](#), [*LRN?](#), [RECALL:SETUp](#), [*RST](#), [*SAV](#)

Arguments <NR1> is an integer value in the range from 1 to 5 (TDS200 Series), or 1 to 10 (TBS1000B/EDU, TBS1000, TDS2000C, TDS1000C-EDU, TDS2000B, and TDS1000B, TDS2000, TDS1000, TPS2000B, and TPS2000 Series), and specifies a setup storage location.

Examples *RCL 3 restores the oscilloscope from a copy of the settings stored in memory location 3.

RECALL:SETUp (No Query Form)

Restores a stored or factory front-panel setup of the oscilloscope from internal nonvolatile memory, or from a file on the CompactFlash card (TDS2MEM and TPS2000B/TPS2000 Series only), or on the USB flash drive (TBS1000B/EDU, TBS1000, TDS2000C, TDS1000C-EDU, TDS2000B, and TDS1000B Series only). When used with the FACTORY argument, this command is equivalent to pushing the DEFAULT SETUP front-panel button.

Group Save and Recall

Syntax RECALL:SETUp { FACTory | <NR1> | <file path> }

Related Commands [FACTory](#), [*RCL](#), [*RST](#), [*SAV](#)

Arguments FACTory selects the factory setup.

<NR1> is a value in the range from 1 to 5 (TDS200 Series), or from 1 to 10 (TBS1000B/EDU, TBS1000, TDS2000C, TDS1000C-EDU, TDS2000B,

TDS1000B, TDS2000, TDS1000, TPS2000B, and TPS2000 Series), and specifies a setup storage location.

<file path> (TBS1000B/EDU, TBS1000, TDS2000C, TDS1000C-EDU, TDS2000B, TDS1000C, TDS2MEM, TPS2000B, and TPS2000 Series only) is a quoted string that defines the location and name of the setup file to recall from the CompactFlash card or the USB flash drive. If you do not specify a path to the folder, the TDS2MEM looks for the file in the current working folder. The current folder refers to the name of a folder as returned by the FILESystem:CWD query.

Examples `RECALL:SETUP FACTORY` recalls the oscilloscope setup to its factory defaults.

`RECALL:SETUP "A:\TSTSETUP\PRTST01.SET"` recalls the oscilloscope settings from the file PRTST01.SET file on the CompactFlash card (TDS2MEM and TPS2000B/TPS2000 Series only), or on the USB flash drive (TBS1000B/EDU, TBS1000, TDS2000C, TDS1000C-EDU, TDS2000B, and TDS1000B Series only).

RECALL:WAVEForm (No Query Form)

Recalls a stored waveform from the CompactFlash card (TDS2MEM and TPS2000B/TPS2000 Series only), or from the USB flash drive (TBS1000B/EDU, TBS1000, TDS2000C, TDS1000C-EDU, TDS2000B, and TDS1000B Series only) into a reference location.

Conditions This command applies to the TBS1000B/EDU, TBS1000, TDS2000C, TDS1000C_EDU, TDS2000B, TDS1000B, TDS2MEM, TPS2000B, and TPS2000 Series only.

Group Save and Recall

Syntax `RECALL:WAVEForm <file path>,REF<x>`

Related Commands [SAVE:WAVEform](#)

Arguments <file path> is a quoted string that defines the location and name of the waveform file to recall. If you do not specify a path to the folder, the oscilloscope looks for the file in the current working folder. The current folder refers to the name of a folder as returned by the FILESystem:CWD query.

`REF<x>` is the oscilloscope reference memory location in which to load the waveform. You must load a saved waveform into a reference memory location before displaying the waveform.

Examples RECALL:WAVEFORM "A:\TST-PRD\TST-01.CSV", REFC loads the waveform file TST-01.CSV into reference memory RefC. Then use SElect:REFC to display this waveform.

REM (No Query Form)

Specifies a comment. This line is ignored by the oscilloscope.

Group Miscellaneous

Syntax REM <QString>

Arguments <QString> is a string that can have a maximum of 80 characters.

Examples REM "This is a comment" is ignored by the oscilloscope.

RS232? (Query Only)

Returns the RS232 settings.

Group RS-232

Syntax RS232?

Returns The current RS-232 settings.

Examples RS232? might return the following string: RS232:BAUD 9600; SOFTFLAGGING 0; HARDFLAGGING 1; PARITY NONE; TRANSMIT:TERMINATOR LF

RS232:BAUd

Sets or queries the RS-232C interface transmission speed. If no flow control (flagging) is used, commands may be received faster than the oscilloscope can process them. Also, if another command is sent immediately after this command, without waiting for the baud rate to be programmed, the first couple of characters may be lost.

Conditions	This command applies to the TDS2000, TDS1000, TDS200, TPS2000B, and TPS2000 Series only.
Group	RS-232
Syntax	RS232:BAUD <NR1> RS232:BAUD?
Arguments	<NR1> which can be 300, 600, 1200, 2400, 4800, 9600, or 19200.
Examples	RS232:BAUD 9600 sets the transmission rate to 9600 baud.

RS232:HARDFlagging

Sets or queries the state of RS232 hard flagging. When hard flagging is enabled, the oscilloscope sends data if CTS (Clear To Send) is asserted. When receiving data, the oscilloscope asserts RTS (Request To Send) until the input buffer is almost full. When the oscilloscope no longer asserts RTS, it continues to read incoming data until the input buffer is full and then reports an input overrun error. The oscilloscope asserts DTR (Data Terminal Ready) at all times when the oscilloscope power is on.

Hard flagging and soft flagging cannot be on at the same time. However, hard and soft flagging can both be off at the same time. Turning hard flagging on turns soft flagging off. Turning soft flagging on turns hard flagging off.

Conditions	This command applies to the TDS2000, TDS1000, TDS200, TPS2000B, and TPS2000 Series only.
Group	RS-232
Syntax	RS232:HARDFlagging { ON OFF <NR1> } RS232:HARDFlagging?
Arguments	ON or <NR1> \neq 0 activates hard flagging and turns off soft flagging. OFF or <NR1> = 0 deactivates hard flagging (RTS always asserted).
Examples	RS232:HARDFLAGGING ON activates hard flagging and deactivates soft flagging.

RS232:PARity

Sets or queries the parity used for all RS-232C data transfers. When parity is odd or even, the oscilloscope generates the selected parity on output and checks all input against the selected parity. When parity is none, the oscilloscope performs no input parity error checks and generates no output parity.

When the parity (ninth) bit does not match the parity type, the oscilloscope reports a parity error. If another command is sent immediately after this command, without waiting for the parity to be programmed, the first few characters may be lost.

Conditions This command applies to the TDS2000, TDS1000, TDS200, TPS2000B, and TPS1000B Series only.

Group RS-232

Syntax RS232:PARity { EVEN | ODD | NONE }
RS232:PARity?

Arguments EVEN sets even parity.
ODD sets odd parity.
NONE sets no parity (no ninth bit transmitted).

Examples RS232:PARITY EVEN sets even parity.

RS232:SOFTFlagging

Sets or queries the input and output soft flagging over the RS-232C port. After receiving an XOFF (DC3), the oscilloscope sends two or less characters. The oscilloscope begins transmitting data again when it receives an XON (DC1) character.

The oscilloscope sends an XOFF character when its input buffer is running out of space. After sending an XOFF character it can receive at least 20 more bytes. It sends XON when its input buffer has an acceptable number of free bytes.

When soft flagging is enabled and binary data is transferred, data transmission will lock up if the data contains XOFF or XON characters.

Hard flagging and soft flagging cannot be active at the same time. However, hard and soft flagging can both be inactive at the same time. Activating soft flagging deactivates hard flagging. Activating hard flagging deactivates soft flagging.

Conditions	This command applies to the TDS2000, TDS1000, TDS200, TPS2000B, and TPS2000 Series only.
Group	RS-232
Syntax	RS232:SOFTFlagging { ON OFF <NR1> } RS232:SOFTFlagging?
Arguments	ON or <NR1> ≠ 0 activates soft flagging and deactivates hard flagging. OFF or <NR1> = 0 deactivates soft flagging.
Examples	RS232:SOFTFLAGGING ON activates soft flagging and deactivates hard flagging.

RS232:TRANsmit:TERMinator

Sets or queries the end-of-line (EOL) terminator. When transmitting, the oscilloscope appends the terminator to the end of each message. When receiving, the oscilloscope accepts all four terminators, regardless of the currently selected terminator. When a combination of multiple characters is selected (CRLF or LFCR), the oscilloscope interprets the first character as the terminator; it treats the second character as a null command.

CR represents an ASCII carriage return character (0x0D) and LF represents an ASCII line feed character (0x0A).

Conditions	This command applies to the TDS2000, TDS1000, TDS200, TPS2000B, and TPS2000 Series only.
Group	RS-232
Syntax	RS232:TRANsmit:TERMinator { CR LF CRLF LFCr } RS232:TRANsmit:TERMinator?
Arguments	CR selects the carriage return character as the EOL terminator. LF selects the line feed character as the EOL terminator. CRLF selects the carriage return and line feed characters as the EOL terminator. LFCr selects the line feed and carriage return characters as the EOL terminator.

Examples RS232:TRANSMIT:TERMINATOR CR sets the carriage return as the EOL terminator.

*RST

(Reset) Returns the oscilloscope to a known set of oscilloscope settings, but does not purge any stored settings. This command executes a subset of the FACTory command.

Sending the *RST command does the following:

- Returns the oscilloscope settings to the factory defaults (refer to *Appendix B: Factory Setup*)
- Sets the macro defined by *DDT to a zero-length field
- Clears the pending operation flag and associated operations

The *RST command does not change the following items:

- State of the RS-232, GPIB, or USB interface
- Calibration data that affects device specifications
- Current GPIB oscilloscope address
- Stored settings or waveforms
- Output queue
- Service Request Enable Register settings
- Standard Event Status Enable Register settings
- Power-On Status Clear flag setting
- Hard copy parameters
- Response Header Enable State
- Front panel LOCK state
- Verbose State
- Display Brightness, TPS2000B and TPS2000 Series only
- Display Contrast (TDS1000B, TDS2000, TDS1000, and TPS2000 Series only)

Group Miscellaneous

Syntax *RST

Related Commands [FACTory](#), [*PSC](#), [*RCL](#), [RECALL:SETUp](#), [*SAV](#), [SAVE:SETUp](#)

***SAV (No Query Form)**

Saves the state of the oscilloscope into a specified nonvolatile memory location. You can later use the [*RCL](#) command to restore the oscilloscope to this saved state. This is equivalent to selecting the Save Setup option in the Save/Recall Setup menu.

Group Save and Recall

Syntax [*SAV](#) <NR1>

Related Commands [FACTory](#), [*RCL](#), [RECALL:SETUp](#)

Arguments <NR1> is an integer value in the range from 1 to 5 (TDS200 Series) or from 1 to 10 (TBS1000B/EDU, TBS1000, TDS2000C, TDS1000C-EDU, TDS2000B, TDS1000B, TDS2000, TDS1000, TPS2000B, and TPS2000 Series) and specifies a memory location. Any settings that have been stored previously at this location are overwritten.

Examples [*SAV 2](#) saves the settings in memory location 2.

SAVE:IMAge (No Query Form)

Saves the screen image to a file on the CompactFlash card (TDS2MEM and TPS2000B/TPS2000 Series only), or on the USB flash drive (TBS1000B/EDU, TBS1000, TDS2000C, TDS1000C-EDU, TDS2000B, and TDS1000B Series only).

Conditions This command applies to the TBS1000B/EDU, TBS1000, TDS2000C, TDS1000C-EDU, TDS2000B, TDS1000B, TDS2MEM, TPS2000B, and TPS2000 Series only.

Group Save and Recall

Syntax [SAVE:IMAge](#) <file path>

Arguments <file path> is a quoted string that defines the path and name of the screen image file to save. Use file name extensions that are appropriate for image format. If you do not specify a path to a folder, the oscilloscope saves the screen image file in the current working folder, using the current save image file format. The current folder refers to the name of a folder as returned by the FILESystem:CWD query.

Use the SAVE:IMAge:FILEFormat command to set the screen image graphical file format.

Examples SAVE:IMAGE "A:\PROD-TST\VID-EVAL.BMP" saves the screen image to the file VID-EVAL.BMP in the folder A:\PROD-TST on the CompactFlash card (TDS2MEM and TPS2000B/TPS2000 Series only), or on the USB flash drive (TBS1000B/EDU, TBS1000, TDS2000C, TDS1000C-EDU, TDS2000B, and TDS1000B Series only).

SAVE:IMAge:FILEFormat (No Query Form)

Sets the screen image file format used by the SAVE:IMAGE command and by the SAVE > Action > Save Image and SAVE > Action > Save All front-panel operations.

Conditions This command applies to the TBS1000B/EDU, TBS1000, TDS2000C, TDS1000C-EDU, TDS2000B, TDS1000B, TDS2MEM, TPS2000B, and TPS2000 Series only.

Group Save and Recall

Syntax **For non-TBS1000B/EDU Series.** SAVE:IMAge:FILEFormat {BMP | EPSIMAGE | JPG | PCX | RLE | TIFF}

For TBS1000B/EDU Series. SAVE:IMAge:FILEFormat {BMP | JPG }

Arguments BMP sets the screen image file format to Microsoft Windows Bitmap format.

EPSIMAGE (non-TBS1000B/EDU Series only) sets the screen image file format to Postscript format.

JPG (TBS1000B/EDU, TBS1000, TDS2000C, TDS1000C-EDU, TDS2000B, and TDS1000B Series only) sets the screen image file format to JPEG bitmap (uses a lossy file compression algorithm).

PCX (non-TBS1000B/EDU Series only) sets the screen image file format to DOS Paintbrush format.

RLE (non-TBS1000B/EDU Series only) sets the screen image file format to Windows color image file format (*.RLE). Use RLE for faster transfer rates and smaller resulting files. Many programs that recognize .BMP files also recognize .RLE files.

TIFF (non-TBS1000B/EDU Series only) sets the screen image file format to Tagged Image File Format.

Examples `SAVE:IMAGE:FILEFORMAT TIFF` sets the screen image graphical file format to TIFF.

SAVe:SETUp (No Query Form)

Saves the current state of the oscilloscope into the specified nonvolatile memory location, or to a file on the CompactFlash card (TDS2MEM and TPS2000B/TPS2000 Series only), or on the USB flash drive (TBS1000B/EDU, TBS1000, TDS2000C, TDS1000C-EDU, TDS2000B, and TDS1000B Series only). This is equivalent to selecting the Save Setup option in the Save/Recall Setup menu.

Group Save and Recall

Syntax `SAVe:SETUp {<NR1> | <file path>}`

Related Commands [RECALL:SETUp](#), [*RCL](#)

Arguments <NR1> is an integer value in the range from 1 to 5 (TDS200 Series), or 1 to 10 (TBS1000B/EDU, TBS1000, TDS2000C, TDS1000C-EDU, TDS2000B, TDS1000B, TDS2000, TDS1000, TPS2000B, and TPS2000 Series), and specifies a memory location. Any settings that have been stored previously at this location are overwritten.

<file path> (TBS1000B/EDU, TBS1000, TDS2000C, TDS1000C-EDU, TDS2000B, TDS1000B, TDS2MEM, TPS2000B, and TPS2000 Series only) is a quoted string that defines the path and name of the setup file to save. Use the extension .SET for oscilloscope setup file names.

If you do not specify a path to a folder, the TDS2MEM saves the setup file in the current working folder. The current folder refers to the name of a folder as returned by the FILESystem:CWD query.

- Examples** `SAVE:SETUP 5` saves the current front-panel setup to memory location 5.
- `SAVE:SETUP "A:\PROD-TST\VID-EVAL.SET"` saves the oscilloscope settings to the file VID-EVAL.SET in the folder A:\PROD-TST on the CompactFlash card (TDS2MEM and TPS2000B/TPS2000 Series only), or on the USB flash drive (TBS1000B/EDU, TBS1000, TDS2000C, TDS1000C-EDU, TDS2000B, and TDS1000B Series only).

SAVE:WAVEform (No Query Form)

Stores a waveform in one of the nonvolatile reference memory locations, or to a file on the CompactFlash card (TDS2MEM and TPS2000B/TPS2000 Series only), or on the USB flash drive (TBS1000B/EDU, TBS1000, TDS2000C, TDS1000C-EDU, TDS2000B, and TDS1000B Series only). This command is equivalent to selecting the Save Waveform option in the Save/Recall Waveform menu.

Group Save and Recall

Syntax `SAVE:WAVEform <wfm>, {REF<x> | <file path>}`

Arguments `<wfm>` is CH<y> (one of the allowable channels) or MATH. This is the waveform that will be saved. For TBS1000B/EDU models, `<wfm>` can be FFT. For TDS2MEM module and TPS2000B/TPS2000 Series, `<wfm>` can also be a reference waveform location (for example REF4) if the destination is `<file path>`.

`REF<x>` is one of the allowable reference waveform storage locations.

`<file path>` (TBS1000B/EDU, TBS1000, TDS2000C, TDS1000C-EDU, TDS2000B, TDS1000B, TDS2MEM, TPS2000B, and TPS2000 Series only) is a quoted string that defines the path and name of the waveform file to save on the CompactFlash card (TDS2MEM and TPS2000B/TPS2000 Series only), or on the USB flash drive (TBS1000B/EDU, TBS1000, TDS2000C, TDS1000C-EDU, TDS2000B, and TDS1000B Series only). Use the extension .CSV for saved waveform files. Waveform data is saved as self-documented comma-separated ASCII values.

If you do not specify a path to a folder, the TDS2MEM creates the waveform file in the current working folder. The current folder refers to the name of a folder as returned by the FILESystem:CWD query.

Examples `SAVE:WAVEFORM MATH, REFB` saves the math waveform in stored waveform memory location REFB.

For non-TBS1000B/EDU models:

SAVE:WAVEFORM CH1, "A:\PROD-TST\FRQTST03.CSV" saves the channel 1 waveform data to the file FRQTST03.CSV in the folder A:\PROD-TST on the CompactFlash card (TDS2MEM and TPS2000B/TPS2000 Series only), or on the USB flash drive (TBS1000, TDS200C, TDS1000C-EDU, TDS2000B, and TDS1000B Series only).

For TBS1000B/EDU models:

SAVE:WAVEFORM CH1, "/usb0/PROD-TST/FRQTST03.CSV" saves the channel 1 waveform data to the file FRQTST03.CSV in the folder /usb0/PROD-TST on the USB flash drive.

SElect? (Query Only)

Returns the display status of all waveforms.

Group	Vertical
Syntax	SElect?
Returns	Waveform display status
Examples	<p>SELECT? returns SELECT:CH1 0;CH2 1;MATH 1;REFA 0;REFB 1, for 2-channel models with CH2, Math and REFB waveforms displayed</p> <p>SELECT? returns SELECT:CH1 1;CH2 1;CH3 1;CH4 1;MATH 0;REFA 1;REFB 0;REFC 0;REFD 1, for 4-channel models with CH1 through CH4 displayed, Math disabled, REFA displayed, and REFD displayed.</p> <p>For the TBS1000B/EDU, SELECT? might return: SELECT:FFT 0;CH1 1;CH2 1;MATH 0;REFA 0;REFB 0</p>

SElect:<wfm>

Controls the display of waveforms. This command is equivalent to activating or deactivating a waveform from the oscilloscope front panel.

Group	Vertical
Syntax	<pre>SElect:<wfm> { OFF ON <NR1> } SElect:<wfm>?</pre>

Arguments OFF or <NR1> = 0 deactivates the display of the specified waveform.
ON or <NR1> ≠ 0 activates the display of the specified waveform.
<wfm> can be CH<x>, MATH, or REF<y>.

Examples SELECT:CH2 ON displays channel 2.
SELECT:REFA? returns either 0 or 1, indicating whether the REFA waveform is displayed.

SElect:FFT

Sets or queries the FFT display state.

Conditions TBS1000B/EDU models only.

Group FFT

Syntax SElect:FFT
SElect:FFT?

SET? (Query Only)

Returns most oscilloscope settings. You can send these responses back to the oscilloscope to return the oscilloscope to the state it was in when you sent SET. This query is identical to the *LRN? query.

NOTE. *The SET? query always returns command headers, regardless of the setting of the HEADER command. This is because the returned data is intended to be able to be sent back to the oscilloscope as concatenated commands. The VERBose command can still be used to specify whether the returned headers should be abbreviated or full length.*

Group Miscellaneous

Syntax SET?

Related Commands [HEADER](#), [*LRN?](#)

Returns Most oscilloscope settings. See *Appendix B: Factory Setup*.

Examples SET? might return a partial string like the following: ACQUIRE:STOPAFTER
RUNSTOP;STATE 1;MODE SAMPLE; NUMAVG 16;:HEADER
1;:VERBOSE 1;:DISPLAY:FORMAT YT;STYLE VECTORS;PERSISTENCE
500.0E-3;CONTRAST 50;:LOCK NONE;:HARDCOPY:FORMAT EPSON;PORT
RS232;LAYOUT PORTRAIT;

*SRE (No Query Form)

(Service Request Enable) sets and queries the bits in the Service Request Enable Register (SRER). Refer to the *Status and Events* section for more information.

Group Status and Error

Syntax *SRE <NR1>
*SRE?

Related Commands [*CLS](#), [DESE](#), [*ESE](#), [*ESR?](#), [EVENT?](#), [EVMsg?](#), [FACTory](#), [*PSC](#)

Arguments <NR1> is an integer value in the range from 0 to 255. The binary bits of the SRER are set according to this value. Using an out-of-range value causes an execution error. The power-on default for SRER is 0 if *PSC is 1. If *PSC is 0, the SRER maintains its value through a power cycle.

Examples *SRE 48 sets the bits in the SRER to 00110000 binary.

*SRE? might return a value of 32, showing that the bits in the SRER have the binary value 00100000.

*STB? (Query Only)

(Read Status Byte) query returns the contents of the Status Byte Register (SBR) using the Master Summary Status (MSS) bit. Refer to the *Status and Events* section for more information.

Group Status and Error

Syntax *STB?

Related Commands *CLS, DESE, *ESE, *ESR?, EVENT?, EVMsg?, FACtory

Returns <NR1>

Examples *STB? might return the value 96, showing that the SBR contains the binary value 01100000.

SWLoss?

Returns the current Switching Loss measurement settings.

Conditions This command applies to the TPS2000B/TPS2000 Series with TPS2PWR1 Power Analysis Module only.

Group Power Measurement

Syntax SWLoss?

Examples SWLOSS? might return the following: SWLOSS:ACQUIRE CONTINUOUS;ENABLE ON;SOURCES CH1CH2;STOPAFTER 10 ;TONSTART 90;TONEND 10;TOFFSTART 10;TOFFEND 10;VSAT 4.300000190735E0;UNITS WATTS

SWLoss:ACQuire

Sets or queries the type of acquisition used for Switching Loss measurements.

Conditions This command applies to the TPS2000B/TPS2000 Series with TPS2PWR1 Power Analysis Module only.

Group Power Measurement

Syntax SWLoss:ACQuire { STOPAAfter | CONTINUOUS }
SWLoss:ACQuire?

Arguments STOPAAfter instructs the oscilloscope to perform measurements on N acquisitions and then stop.

CONTINUOUS instructs the oscilloscope to continuously acquire waveforms and display measurements.

Examples SWLOSS:ACQUIRE might return SWLOSS:ACQUIRE CONTINUOUS, indicating that the oscilloscope is continuously taking switching loss measurements.

SWLoss:AVERage:CONDUCTION? (Query Only)

Returns the power loss of the device under test when the device is conducting in its on state. The oscilloscope reports this measurement in the Avg. column of the Switching Loss display.

You must enter the saturation voltage of the device under test using the SWLoss:VSAT command.

NOTE. This command returns error 221 (settings conflict) if the Switching Loss menu is not active.

Conditions This command applies to the TPS2000B/TPS2000 Series with TPS2PWR1 Power Analysis Module only.

Group Power Measurement

Syntax SWLoss:AVERage:CONDUCTION?

Returns <NR3>

Examples SWLOSS:AVERAGE:CONDUCTION? might return 6.0880498608E-2.

SWLoss:AVERage:N? (Query Only)

Returns the number of measurements used to calculate the AVG. (averaged) measurement value for switching loss measurements.

NOTE. This command returns error 221 (settings conflict) if the Switching Loss menu is not active.

Conditions This command applies to the TPS2000B/TPS2000 Series with TPS2PWR1 Power Analysis Module only.

Group	Power Measurement
Syntax	SWLoss:AVERage:N?
Returns	<NR1>
Examples	SWLOSS:AVERAGE:N? might return 185, indicating that the oscilloscope used 185 measurements to calculate the average.

SWLoss:AVERage:TOTAL? (Query Only)

Returns the sum of the Turn-On, Turn-Off, and Conduction switching losses. The oscilloscope reports this measurement in the Avg column of the Switching Loss display.

NOTE. This command returns error 221 (settings conflict) if the Switching Loss menu is not active.

Conditions	This command applies to the TPS2000B/TPS2000 Series with TPS2PWR1 Power Analysis Module only.
Group	Power Measurement
Syntax	SWLoss:AVERage:TOTAL?
Returns	<NR3>
Examples	SWLOSS:AVERAGE:TOTAL? might return 9.1715589532E-2.

SWLoss:AVERage:TURNOFF? (Query Only)

Returns the power loss of the device under test when the device is transitioning between its on and off state. The oscilloscope reports this measurement in the Avg column of the Switching Loss display.

You must enter the saturation voltage of the device under test using the SWLoss:VSAT command.

NOTE. This command returns error 221 (settings conflict) if the Switching Loss menu is not active.

Conditions	This command applies to the TPS2000B/TPS2000 Series with TPS2PWR1 Power Analysis Module only.
Group	Power Measurement
Syntax	SWLoss:AVERage:TURNOFF?
Returns	<NR3>
Examples	SWLOSS: AVERAGE: TURNOFF? might return 1.3790115628E-2.

SWLoss:AVERage:TURNON? (Query Only)

Returns the power loss of the device under test when the device is transitioning between its off and on state. The oscilloscope reports this measurement in the Avg column of the Switching Loss display.

You must enter the saturation voltage of the device under test using the SWLoss:VSAT command.

NOTE. This command returns error 221 (settings conflict) if the Switching Loss menu is not active.

Conditions	This command applies to the TPS2000B/TPS2000 Series with TPS2PWR1 Power Analysis Module only.
Group	Power Measurement
Syntax	SWLoss:AVERage:TURNON?
Returns	<NR3>
Examples	SWLOSS: AVERAGE: TURNON? might return 1.698264356E-2.

SWLoss:ENABLE

Sets or queries the switching loss menu, on or off.

Conditions	This command applies to the TPS2000B/TPS2000 Series with TPS2PWR1 Power Analysis Module only.
Group	Power Measurement
Syntax	SWLoss:ENABLE { ON OFF } SWLoss:ENABLE?
Arguments	ON enables the switching loss menu. OFF disables the switching loss menu.
Examples	SWLOSS:ENABLE ON sets the switching loss measurement to on.

SWLoss:LEVELS (No Query Form)

Returns the Switching Loss measurement levels to factory default values for the following commands:

SWLoss:TONSTART SWLoss:TONEND SWLoss:TOFFSTART
SWLoss:TOFFEND

Conditions	This command applies to the TPS2000B/TPS2000 Series with TPS2PWR1 Power Analysis Module only.
Group	Power Measurement
Syntax	SWLoss:LEVELS { DEFauLt }
Arguments	DEFauLt sets Switching Loss measurement levels to default values.
Examples	SWLOSS:LEVELS DEFAULT returns Switching Loss measurement levels to default values.

SWLoss:LOG:CONDUCTION? (Query Only)

Returns the Conduction Loss for the switching loss measurement specified by the SWLoss:LOG:INDEX command.

NOTE. *The oscilloscope generates error 221 if the SWLoss:LOG:INDEX? command returns a number greater than that reported by SWLoss:AVerage:N? This indicates that insufficient measurements have been taken to generate a log report.*

Conditions	This command applies to the TPS2000B/TPS2000 Series with TPS2PWR1 Power Analysis Module only.
Group	Power Measurement
Syntax	SWLOSS:LOG:CONDUCTION?
Returns	<NR3>
Examples	SWLOSS:LOG:CONDUCTION? might return 6.0524113476E-2.

SWLoss:LOG:INDEX

Sets or queries which measurement to return for the following commands: SWLoss:LOG:CONDUCTION, SWLoss:LOG:TOTAL, SWLoss:LOG:TURNON, and SWLoss:LOG:TURNOFF.

NOTE. *The SWLoss:AVerage:N command returns the number of measurements currently accumulated in the log.*

Conditions	This command applies to the TPS2000B/TPS2000 Series with TPS2PWR1 Power Analysis Module only.
Group	Power Measurement
Syntax	SWLOSS:LOG:INDEX <NR1> SWLOSS:LOG:INDEX?

Arguments <NR1> The default value is 1.

Examples SWLOSS:LOG:INDEX? might return 5.

SWLoss:LOG:TOTAL? (Query Only)

Returns the Total Loss for a switching loss measurement specified by the SWLoss:LOG:INDEX command.

NOTE. The oscilloscope generates error 221 if the SWLoss:LOG:INDEX? command returns a number greater than that reported by SWLoss:AVERage:N? This indicates that insufficient measurements have been taken to generate a log report.

Conditions This command applies to the TPS2000B/TPS2000 Series with TPS2PWR1 Power Analysis Module only.

Group Power Measurement

Syntax SWLOSS:LOG:TOTAL?

Returns <NR3>

Examples SWLOSS:LOG:TOTAL? might return 9.0796045959E-2.

SWLoss:LOG:TURNOFF? (Query Only)

Returns the Turn-Off Loss for a switching loss measurement specified by the SWLoss:LOG:INDEX command.

NOTE. The oscilloscope generates error 221 if the SWLoss:LOG:INDEX? command returns a number greater than that reported by SWLoss:AVERage:N? This indicates that insufficient measurements have been taken to generate a log report.

Conditions This command applies to the TPS2000B/TPS2000 Series with TPS2PWR1 Power Analysis Module only.

Group	Power Measurement
Syntax	SWLOSS:LOG:TURNOFF?
Returns	<NR3>
Examples	SWLOSS:LOG:TURNOFF? might return 1.3477193192E-2.

SWLoss:LOG:TURNON? (Query Only)

Returns the Turn-On Loss for a switching loss measurement specified by the SWLoss:LOG:INDEX command.

NOTE. *The oscilloscope generates error 221 if the SWLoss:LOG:INDEX? command returns a number greater than that reported by SWLoss:AVErage:N? This indicates that insufficient measurements have been taken to generate a log report.*

Conditions	This command applies to the TPS2000B/TPS2000 Series with TPS2PWR1 Power Analysis Module only.
Group	Power Measurement
Syntax	SWLOSS:LOG:TURNON?
Returns	<NR3>
Examples	SWLOSS:LOG:TURNON? might return 1.7111644149E-2.

SWLoss:SAVE

Saves the Switching Loss measurements to the oscilloscope CompactFlash card. Uses .CSV format.

NOTE. *You can view the contents of the saved file on your personal computer. You cannot recall saved Switching Loss files to the oscilloscope.*

Conditions	This command applies to the TPS2000B/TPS2000 Series with TPS2PWR1 Power Analysis Module only.
Group	Power Measurement
Syntax	SWLoss:SAVE <filename> SWLoss:SAVE?
Arguments	<filename> specifies the file name and full path to save switching loss measurement data.
Examples	SWLOSS:SAVE "A:\Data2.CSV" specifies the file name and path to save switching loss measurement data to the oscilloscope CompactFlash card.

SWLoss:SOURCES

Sets or queries the input sources for Switching Loss measurements.

Before taking measurements, you must use the CH<x>:YUNit command to set the units of the voltage and current sources.

Conditions	This command applies to the TPS2000B/TPS2000 Series with TPS2PWR1 Power Analysis Module only.
Group	Power Measurement
Syntax	SWLoss:SOURCES { CH1CH2 CH3CH4 } SWLoss:SOURCES?
Arguments	CH1CH2 specifies Channel 1 and Channel 2 as the input sources. CH3CH4 specifies Channel 3 and Channel 4 as the input sources.
	<hr/> NOTE. The "CH3CH4" argument is only valid for instruments with four channels. <hr/>
Examples	SWLOSS:SOURCES? might return CH1CH2.

SWLoss:STOPAfter

Sets or queries the number of measurements used for Switching Loss measurement.

Conditions This command applies to the TPS2000B/TPS2000 Series with TPS2PWR1 Power Analysis Module only.

Group Power Measurement

Syntax SWLoss:STOPAfter <NR1>
SWLoss:STOPAfter?

Related Commands [SWLoss:ACQuire](#)

Arguments <NR1> defines the number of measurements you want to include.

Examples SWLOSS:STOPAFTER? might return 15, indicating that the oscilloscope will take fifteen measurements and stop.

SWLoss:TOFFEND

Sets or queries a level on the first falling edge of the current waveform that occurs after the turn-off start point (SWLoss:TOFFSTART).

The Turn-Off loss measurement is calculated by integrating the math waveform between the turn-off start (SWLoss:TOFFSTART) and turn-off end (SWLoss:TOFFEND) points.

Conditions This command applies to the TPS2000B/TPS2000 Series with TPS2PWR1 Power Analysis Module only.

Group Power Measurement

Syntax SWLoss:TOFFEND <NR1>
SWLoss:TOFFEND?

Related Commands [SWLoss:TOFFSTART](#)

Arguments <NR1> in percent. Default value is 10.

Examples SWLOSS:TOFFEND? might return 10, indicating that Switching Loss Turn-off End is set to 10%.

SWLoss:TONEND

Sets or queries a level on the first falling edge of the voltage waveform.

The Turn-On loss measurement is calculated by integrating the math waveform between the turn-on start (SWLoss:TONSTART) and turn-on end (SWLoss:TONEND) points.

Conditions This command applies to the TPS2000B/TPS2000 Series with TPS2PWR1 Power Analysis Module only.

Group Power Measurement

Syntax SWLOSS:TONEND <NR1>
SWLOSS:TONEND?

Arguments <NR1> in percent. Default value is 10.

Examples SWLOSS:TONEND? might return 10, indicating that Switching Loss Turn-off Start is set to 10%.

SWLoss:TOFFSTART

Sets or queries a level on the rising edge of the voltage waveform.

The Turn-Off loss measurement is calculated by integrating the math waveform between the turn-off start (SWLoss:TOFFSTART) and turn-off end (SWLoss:TOFFEND) points.

Conditions This command applies to the TPS2000B/TPS2000 Series with TPS2PWR1 Power Analysis Module only.

Group Power Measurement

Syntax	<code>SWLOSS:TUFFSTART <NR1></code> <code>SWLOSS:TUFFSTART?</code>
Arguments	<NR1> in percent. Default value is 10.
Examples	<code>SWLOSS:TUFFSTART?</code> might return 10, indicating that Switching Loss Turn-on End is set to 10%.

SWLoss:TONSTART

Sets or queries a level on the falling edge of the voltage waveform.

The Turn-On loss measurement is calculated by integrating the math waveform between the turn-on start (SWLoss:TONSTART) and turn-on end (SWLoss:TONEND) points.

Conditions	This command applies to the TPS2000B/TPS2000 Series with TPS2PWR1 Power Analysis Module only.
Group	Power Measurement
Syntax	<code>SWLoss:TONSTART <NR1></code> <code>SWLoss:TONSTART?</code>
Arguments	<NR1> in percent. Default value is 90.
Examples	<code>SWLoss:TONSTART?</code> might return 80, indicating that Switching Loss Turn-on Start is set to 80%.

SWLoss:UNITs

Sets or queries the units for Switching Loss measurements.

Conditions	This command applies to the TPS2000B/TPS2000 Series with TPS2PWR1 Power Analysis Module only.
Group	Power Measurement

Syntax SWLoss:UNITS { WATTS | JOULES }
SWLoss:UNITS?

Arguments WATTS sets the measurement units to Watts.
JOULES sets the measurement units to Joules.

Examples SWLoss:UNITS? might return WATTS, indicating that the current measurement units are Watts.

NOTE. *If the units are Watts, the trigger type must be Edge and the trigger source must be a channel specified by SWLoss:SOURCES.*

SWLoss:VALue:CONDUCTION?

Returns the power loss of the device under test when the device is conducting in its on state. You must enter the saturation voltage of the device under test using the SWLoss:VSAT command.

This command returns an immediate-measurement value that does not depend of the current oscilloscope menu.

Conditions This command applies to the TPS2000B/TPS2000 Series with TPS2PWR1 Power Analysis Module only.

Group Power Measurement

Syntax SWLoss:VALue:CONDUCTION?

Examples SWLoss:VALue:CONDUCTION? might return 6.016666667E-2.

SWLoss:VALue:TOTAL? (Query Only)

Returns the sum of the Turn-On, Turn-Off, and Conduction switching losses.

This command returns an immediate-measurement value that does not depend of the current oscilloscope menu.

Conditions This command applies to the TPS2000B/TPS2000 Series with TPS2PWR1 Power Analysis Module only.

Group	Power Measurement
Syntax	SWLOSS:VALUE:TOTAL?
Returns	<NR3>
Examples	SWLOSS:VALUE:TOTAL? might return -5.74759710834346E2

SWLoss:VALue:TURNOff? (Query Only)

Returns the power loss of the device under test when the device is transitioning between its on and off state. You must enter the saturation voltage of the device under test using the SWLoss:VSAT command.

This command returns an immediate-measurement value that does not depend of the current oscilloscope menu.

Conditions	This command applies to the TPS2000B/TPS2000 Series with TPS2PWR1 Power Analysis Module only.
Group	Power Measurement
Syntax	SWLOSS:VALue:TURNOff?
Returns	<NR3>
Examples	SWLOSS:VALUE:TURNOff? might return -2.79999933043427E2

SWLoss:VALue:TURNOn? (Query Only)

Returns the power loss of the device under test when the device is transitioning between its off and on state. You must enter the saturation voltage of the device under test using the SWLoss:VSAT command.

This command returns an immediate-measurement value that does not depend of the current oscilloscope menu.

Conditions	This command applies to the TPS2000B/TPS2000 Series with TPS2PWR1 Power Analysis Module only.
-------------------	---

Group	Power Measurement
Syntax	SWLoss:VALUE:TURNON?
Returns	<NR3>
Examples	SWLOSS:VALUE:TURNON? might return -5.19999753093395E2

SWLoss:VSAT

Sets or queries the saturation voltage for the device under test.

Conditions	This command applies to the TPS2000B/TPS2000 Series with TPS2PWR1 Power Analysis Module only.
Group	Power Measurement
Syntax	SWLoss:VSAT <NR3> SWLoss:VSAT?
Arguments	<NR3> specifies the saturation voltage.
Examples	SWLOSS:VSAT might return 4.800000667572E0, indicating that the saturation voltage is set to 4.80 volts.

TIME

Sets or queries the oscilloscope time value. The oscilloscope uses the time and date values to time stamp files saved to the CompactFlash card (TDS2MEM and TPS2000B/TPS2000 Series only), or to the USB flash drive (TBS1000B/EDU, TBS1000, TDS2000C, TDS1000C-EDU, TDS2000B, and TDS1000B Series only), as well as show the time and date on the oscilloscope display.

Conditions	This command applies to the TBS1000B/EDU, TBS1000, TDS2000C, TDS1000C-EDU, TDS2000B, TDS1000B, TDS2MEM, TPS2000B, and TPS2000 Series only.
Group	Miscellaneous

Syntax	TIME <QString> TIME?
Arguments	<QString> is a time in the form "hh:mm:ss", based on a 24-hour clock (00:00:00 through 23:59:59).
Examples	TIME "14:45:00" sets the time to 2:45 pm.

TRENDPLOT? (Query Only)

Returns all the trend plot parameters.

Conditions	TBS1000B models only.
Group	Trend plot
Syntax	TRENDPLOT?

TRENDPLOT:STATE

Sets or returns the running state of the trend plot.

Conditions	TBS1000B models only.
Group	Trend plot
Syntax	TRENDPLOT:STATE { RUN STOP } TRENDPLOT:STATE?

TRENDPLOT:TIME

Returns the elapsed time since starting the plot function.

Conditions	TBS1000B models only.
Group	Trend plot

Syntax TRENDPLOT:TIME?

TRENDPLOT:TP<x>:AVG? (Query Only)

Queries the current statistical average value. Returns the average value of all acquired measured value corresponding to the channel x, which is either 1 or 2.

Conditions TBS1000B models only.

Group Trend plot

Syntax TRENDPLOT:TP<x>:AVG?

TRENDPLOT:TP<x>:MAX? (Query Only)

Queries the current statistical maximum value. Returns the maximum value of all acquired measured value corresponding the selected channel. x is either 1 or 2.

Conditions TBS1000B models only.

Group Trend plot

Syntax TRENDPLOT:TP<x>:MAX?

TRENDPLOT:TP<x>:MIN? (Query Only)

Queries the current statistical minimum value. Returns the minimum value of all acquired measured value corresponding the selected channel. x is either 1 or 2.

Conditions TBS1000B models only.

Group Trend plot

Syntax TRENDPLOT:TP<x>:MIN?

TRENDPLOT:TP<x>:SCALE? (Query Only)

Queries the current per div scale.

Conditions TBS1000B models only.

Group Trend plot

Syntax TRENDPLOT:TP<x>:SCALE?

TRENDPLOT:TP<x>:SCALEMAX? (Query Only)

Queries the maximum value to plot of the display in the current range.

Conditions TBS1000B models only.

Group Trend plot

Syntax TRENDPLOT:TP<x>:SCALEMAX?

TRENDPLOT:TP<x>:SCALEMIN? (Query Only)

Queries the minimum value to plot of the display in the current range.

Conditions TBS1000B models only.

Group Trend plot

Syntax TRENDPLOT:TP<x>:SCALEMIN?

TRENDPLOT:TP<x>:SOURCE

Sets or returns the trend plot source.

Conditions TBS1000B models only.

Group Trend plot

Syntax TRENDPLOT:TP<x>:SOURCE { CH1 | CH2 | MATH | CH1CH2 | CH2CH1
| CH1MATH | MATHCH1 | CH2MATH | MATHCH2 }
TRENDPLOT:TP<x>:SOURCE?

TRENDPLOT:TP<x>:TYPE

Sets or returns the trend plot type. z is 1 or 2.

Conditions TBS1000B models only.

Group Trend plot

Syntax TRENDPLOT:TP<x>:TYPE { CRMs | FALL | FREQuency | MAXImum |
MEAN | MINImum | NONE | NWidth | PERIOD | PK2pk | PWidth |
RIse | RMS | CURSORRms | PDUTy | PHAsE | DELAYRR | DELAYRF |
DELAYFR | DELAYFF | AmpLitUDe | CMEAN | High | LOW | NDUTy |
POVERshoot | NOVERshoot | CURSORMean | BURSTWIDTH | AREA |
CAREA | PPULSECount | NPULSECount | REDGECount | FEDGECount
}
TRENDPLOT:TP<x>:TYPE?

*TRG (No Query Form)

(Trigger) Executes commands that are defined by *DDT.

Group Miscellaneous

Syntax *TRG

Examples *TRG immediately executes all commands defined by *DDT.

TRIGger

Forces a trigger event to occur. When used as a query, TRIGger? returns the current trigger settings.

Group Trigger

Syntax	TRIGger FORCE TRIGger?
Arguments	FORCE creates a trigger event. If TRIGger:STATE is REAdy, the acquisition will complete; otherwise this command will be ignored. This is equivalent to selecting FORCE TRIGOn the front panel.
Examples	TRIGGER FORCE forces a trigger event to occur. TRIGGER? might return the following string: TRIGGER:MAIN:MODE AUTO;TYPE EDGE;LEVEL 0.0E0;HOLDOFF:VALUE 5.0E-7;:TRIGGER:MAIN:EDGE:SOURCE CH1;COUPLING DC;SLOPE RISE;:TRIGGER:MAIN:VIDEO:SOURCE CH1;SYNC FIELD;POLARITY NORMAL

TRIGger:MAIn

Sets the oscilloscope trigger level to 50% of the minimum and maximum values of the signal. Returns the current main trigger settings when used as a query.

Group	Trigger
Syntax	TRIGger:MAIn SETLevel TRIGger:MAIn?
Arguments	SETLevel sets the main trigger level to half way between the MIN and MAX amplitudes of the trigger source input. This is equivalent to pressing the front-panel SET LEVEL TO 50% button. If the oscilloscope acquisition state is STOP and you send TRIGger:MAIn SETLevel, the oscilloscope ignores the command and generates event 221 (Settings conflict).
Examples	TRIGGER:MAIN SETLEVEL sets the main trigger level mid way between MAX and MIN.

TRIGger:MAIn:EDGE? (Query Only)

Returns the trigger coupling, source, and slope settings for the edge trigger.

Group	Trigger
--------------	---------

Syntax	TRIGger:MAIn:EDGE?
Returns	Trigger coupling, source, and slope settings for the main edge trigger
Examples	TRIGGER:MAIN:EDGE? might return SOURCE CH1;COUPLING DC;SLOPE RISE

TRIGger:MAIn:EDGE:COUPling

Sets or queries the type of coupling for the edge trigger. This is equivalent to setting the Coupling option in the Trigger menu.

Group	Trigger
Syntax	TRIGger:MAIn:EDGE:COUPling { AC DC HFRej LFRej NOISerej } TRIGger:MAIn:EDGE:COUPling?
Arguments	<p>AC selects AC trigger coupling.</p> <p>DC selects DC coupling.</p> <p>HFRej coupling removes the high-frequency components of the DC signal.</p> <p>LFRej coupling removes the low-frequency components of the AC signal.</p> <p>NOISerej selects DC low sensitivity. It requires added signal amplitude for more stable, less false triggering.</p>
Examples	TRIGGER:MAIN:EDGE:COUPLING DC sets the main edge trigger coupling to DC.

TRIGger:MAIn:EDGE:SLOpe

Selects a rising or falling slope for the edge trigger. This is equivalent to setting the Slope option in the Trigger menu.

Group	Trigger
Syntax	TRIGger:MAIn:EDGE:SLOpe { FALL RISE } TRIGger:MAIn:EDGE:SLOpe?

Arguments	FALL specifies to trigger on the falling or negative edge of a signal. RISe specifies to trigger on the rising or positive edge of a signal.
Examples	TRIGGER:MAIN:EDGE:SLOPE RISE sets the main edge trigger to occur on the rising slope.

TRIGger:MAIn:EDGE:SOUrce

Sets or queries the source for the edge trigger. This is equivalent to setting the Source option in the Trigger menu.

Group	Trigger
Syntax	TRIGger:MAIn:EDGE:SOUrce { CH<x> EXT EXT5 EXT10 LINE } TRIGger:MAIn:EDGE:SOUrce?
Arguments	<p>CH<x> specifies one of the allowable input channels. The value of <x> can vary from 1 through 4 for 4-channel instruments or 1 through 2 for 2-channel instruments.</p> <p>EXT specifies the external input (not available with TDS224 oscilloscopes).</p> <p>EXT5 specifies that the external input is attenuated by a factor of 5 (not available with TDS224 oscilloscopes).</p> <p>EXT10 specifies that the external input is attenuated by a factor of 10 (TPS2000B/TPS2000 Series only).</p> <p>LINE specifies the power line signal as a trigger source (not available with TPS2000B/TPS2000 Series oscilloscopes).</p>
Examples	<p>TRIGGER:MAIN:EDGE:SOURCE CH1 specifies channel 1 as the edge trigger source.</p> <p>TRIGGER:MAIN:EDGE:SOURCE? might return CH2 for the edge trigger source.</p>

TRIGger:MAIn:FREQuency? (Query Only)

Returns the edge or pulse width trigger frequency. This is the same as the readout in the lower right corner of the screen.

If the trigger frequency is less than 10 Hz, the query returns 9.9e37 and generates error 2207 (Measurement error, Measurement overflow).

If the trigger type is video, the query returns 9.9e37 and generates event 221 (Settings conflict).

Group	Trigger
Syntax	TRIGger:MAIn:FREQUency?
Returns	Edge or pulse width trigger frequency
Examples	TRIGGER:MAIN:FREQUENCY? might return TRIGGER:MAIN:FREQUENCY 1.0E3

TRIGger:MAIn:HOLDOff? (Query Only)

Returns the trigger holdoff value.

Group	Trigger
Syntax	TRIGger:MAIn:HOLDOff?
Returns	Main trigger holdoff value
Examples	TRIGGER:MAIN:HOLDOFF? might return TRIGGER:MAIN:HOLDOFF:VALUE 5.0E-7

TRIGger:MAIn:HOLDOff:VALue

Sets or queries the oscilloscope trigger holdoff value.

Group	Trigger
Syntax	TRIGger:MAIn:HOLDOff:VALue <NR3> TRIGger:MAIn:HOLDOff:VALue?
Arguments	<NR3> is the main trigger holdoff value. The range is 500 ns to 10 s.

Examples TRIGGER:MAIN:HOLDOFF:VALUE 10 sets the holdoff value to 10 s.

TRIGger:MAIn:LEVel

Sets the oscilloscope edge (all models) and pulse width (TBS1000B/EDU, TBS1000, TDS2000C, TDS1000C-EDU, TDS2000B, TDS1000B, TDS2000, TDS1000, TPS2000B, and TPS2000 Series only) trigger level. This command is equivalent to adjusting the front-panel TRIGGER LEVEL knob.

NOTE. When the edge trigger source is set to AC LINE, the oscilloscope ignores the set form of the command and generates event 221 (Settings conflict).

When the edge trigger source is set to AC LINE, the query form of the command returns zero.

Group Trigger

Syntax TRIGger:MAIn:LEVel <NR3>
TRIGger:MAIn:LEVel?

Arguments <NR3> the main trigger level, in volts.

Examples TRIGGER:MAIN:LEVEL might return 1.4, indicating that the main edge trigger is set to 1.4 V.

TRIGger:MAIn:MODE

Sets or queries the trigger mode for the Edge (all models) and Pulse width (TBS1000B/EDU, TBS1000, TDS2000C, TDS1000C-EDU, TDS2000B, TDS1000B, TDS2000, TDS1000, TPS2000B, and TPS2000 Series only) trigger types.

Group Trigger

Syntax TRIGger:MAIn:MODE { AUTO | NORMal }
TRIGger:MAIn:MODE?

Related Commands [ACQuire:STOPAfter](#)

- Arguments** AUTO generates a trigger if a trigger is not detected within a specific time period. AUTO also enables scan mode for sweep speeds of 100 ms/div and slower.
- NORMAL waits for a valid trigger event.
- Examples** TRIGGER:MAIN:MODE AUTO specifies that a trigger event is automatically generated.

TRIGger:MAIn:PULse? (Query Only)

Returns the current Pulse Trigger settings.

- Group** Trigger
- Syntax** TRIGger:MAIn:PULse?
- Examples** TRIGGER:MAIN:PULSE? might return the following string:
TRIGGER:MAIN:PULSE:SOURCE CH1;WIDTH:POLARITY POSITIVE;WHEN
EQUAL;WIDTH 1.0E-3

TRIGger:MAIn:PULse:SOURce

Sets or queries the source for the pulse trigger. This is equivalent to setting the Source option in the Trigger menu.

- Conditions** This command applies to the TBS1000B/EDU, TBS1000, TDS2000C, TDS1000C-EDU, TDS2000B, TDS1000B, TDS2000, TDS1000, TPS2000B, and TPS2000 Series only.
- Group** Trigger
- Syntax** TRIGger:MAIn:PULse:SOURce { CH<x> | EXT | EXT5 | EXT10 }
TRIGger:MAIn:PULse:SOURce?
- Arguments** CH<x> specifies one of the allowable input channels. The value of <x> can be 1 through 4 on four channel oscilloscopes, or 1 or 2 on two channel oscilloscopes.
- EXT specifies the external input (not available with TDS224 oscilloscopes).
- EXT5 specifies the external input attenuated by a factor of 5 (not available with TDS224 oscilloscopes).

EXT10 specifies the external input attenuated by a factor of 10 (TPS2000B/TPS2000 Series only).

TRIGger:MAIn:PULse:WIDth? (Query Only)

Returns the pulse trigger width settings.

Group Trigger

Syntax TRIGger:MAIn:PULse:WIDth?

Examples TRIGGER:MAIN:PULSE:WIDTH? might return the following string:
TRIGGER:MAIN:PULSE:WIDTH:POLARITY POSITIVE;WHEN EQUAL;WIDTH
1.0E-3

TRIGger:MAIn:PULse:WIDth:POLarity

Sets or queries the polarity for the pulse trigger. This is equivalent to setting the Polarity option in the Pulse Trigger menu.

Conditions This command applies to the TBS1000B/EDU, TBS1000, TDS2000C, TDS1000C-EDU, TDS2000B, TDS1000B, TDS2000, TDS1000, TPS2000B, and TPS2000 Series only.

Group Trigger

Syntax TRIGger:MAIn:PULse:WIDth:POLarity { POSITIVE | NEGative }
TRIGger:MAIn:PULse:WIDth:POLarity?

Arguments POSITIVE polarity specifies pulses with a rising leading edge.
NEGative polarity specifies pulses with a falling leading edge.

TRIGger:MAIn:PULse:WIDth:WHEN

Sets or queries the trigger conditions for the pulse trigger. This is equivalent to setting the When option in the Pulse Trigger menu.

Conditions	This command applies to the TBS1000B/EDU, TBS1000, TDS2000C, TDS1000C-EDU, TDS2000B, TDS1000B, TDS2000, TDS1000, TPS2000B, and TPS2000 Series only.
Group	Trigger
Syntax	TRIGger:MAIn:PULse:WIDth:WHEN { EQUal NOTEQual INSide OUTSide } TRIGger:MAIn:PULse:WIDth:WHEN?
Arguments	<p>EQUal triggers on the trailing edge of pulses of the specified width.</p> <p>NOTEQual triggers when a pulse trailing edge occurs before the specified width, or a pulse continues longer than the specified width without a trailing edge.</p> <p>INSide < triggers on the trailing edge of any pulses that are narrower than the specified width.</p> <p>OUTSide (greater than; also called time-out trigger) triggers when a pulse continues longer than the specified width.</p>

TRIGger:MAIn:PULse:WIDth:WIDth

Sets or queries the width for the pulse trigger. This is equivalent to setting the Width option by using the Pulse Trigger menu and the TRIGGER knob.

Conditions	This command applies to the TBS1000B/EDU, TBS1000, TDS2000C, TDS1000C-EDU, TDS2000B, TDS1000B, TDS2000, TDS1000, TPS2000B, and TPS2000 Series only.
Group	Trigger
Syntax	TRIGger:MAIn:PULse:WIDth:WIDth <NR3> TRIGger:MAIn:PULse:WIDth:WIDth?
Arguments	<NR3> specifies the time, in seconds. Range is 33 ns to 10 s. Resolution varies. Value is forced to nearest achievable value.
Examples	TRIGGER:MAIN:PULSE:WIDTH:WIDTH .000000123 followed by TRIGGER:MAIN:PULSE:WIDTH:WIDTH? might return 1.155E-7.

TRIGger:MAIn:TYPE

Sets or queries the type of oscilloscope trigger. This is equivalent to setting the Type option in the Trigger menu.

Group	Trigger
Syntax	TRIGger:MAIn:TYPE { EDGE VIDEo PULse } TRIGger:MAIn:TYPE?
Arguments	<p>EDGE is a normal trigger. A trigger event occurs when a signal passes through a specified voltage level in the specified direction and is controlled by the TRIGger:MAIn:EDGE commands.</p> <p>VIDEo specifies that a trigger occurs when a specified signal is found and is controlled by the TRIGger:MAIn:VIDEo commands.</p> <p>PULse specifies that a trigger occurs when the specified signal meets the pulse width criteria that is controlled by the TRIGger: MAIn:PULse commands (not available with TDS200 Series oscilloscopes).</p>
Examples	TRIGGER:MAIN:TYPE might return VIDEO, indicating that the main trigger type is a video trigger.

TRIGger:MAIn:VIDEo? (Query Only)

Returns the main video trigger settings.

Group	Trigger
Syntax	TRIGger:MAIn:VIDEo?
Examples	TRIGGER:MAIN:VIDEo? might return TRIGGER:MAIN:VIDEo:SOURCE CH1;SYNC FIELD;POLARITY NORMAL

TRIGger:MAIn:VIDEo:LINE

Sets or queries the line number for the video trigger when TRIGger:MAIn:VIDEo:SYNC is set to LINENUM. This is equivalent to selecting a line number in the Trigger/Video menu.

Conditions	This command applies to the TBS1000B/EDU, TBS1000, TDS2000C, TDS1000C-EDU, TDS2000B, TDS1000B, TDS2000, TDS1000, TPS2000B, and TPS2000 Series only.
Group	Trigger
Syntax	TRIGger:MAIn:VIDeo:LINE <NR1> TRIGger:MAIn:VIDeo:LINE?
Arguments	<NR1> specifies the line number. The minimum is 1. The maximum is 525 for NTSC, 625 for PAL and SECAM.
Examples	The following command sequence sets the oscilloscope to trigger on video line 123: TRIGGER:MAIN:TYPE VIDEO TRIGGER:MAIN:VIDEO:SYNC LINENUM TRIGGER:MAIN:VIDEO:LINE 123

TRIGger:MAIn:VIDeo:POLarity

Sets or queries the video trigger polarity. This is equivalent to selecting the Polarity option in the Trigger/Video menu.

Group	Trigger
Syntax	TRIGger:MAIn:VIDeo:POLarity { INVERT NORMAl } TRIGger:MAIn:VIDeo:POLarity?
Arguments	INVERT specifies a positive sync pulse. NORMAl specifies a negative sync pulse.
Examples	TRIGGER:MAIN:VIDEO:POLARITY NORMAL selects negative synchronization polarity for the video trigger.

TRIGger:MAIn:VIDeo:SOURce

Sets or queries the source for the video trigger. This is equivalent to selecting the Source option in the Video trigger menu.

Group	Trigger
Syntax	TRIGger:MAIn:VIDeo:SOURCE { CH<x> EXT EXT5 EXT10 } TRIGger:MAIn:VIDeo:SOURCE?
Arguments	<p>CH<x> specifies one of the allowable input channels. The value of <x> can vary from 1 through 4 for 4-channel instruments or 1 through 2 for 2-channel instruments.</p> <p>EXT specifies the external input (not available with TDS224 oscilloscopes).</p> <p>EXT5 specifies the external input, attenuated by a factor of 5 (not available with TDS224 oscilloscopes).</p> <p>EXT10 specifies the external input attenuated by a factor of 10 (TPS2000B/TPS2000 Series only).</p>
Examples	TRIGGER:MAIN:VIDEO:SOURCE CH1 selects channel 1 as the source for the main video trigger.

TRIGger:MAIn:VIDeo:STANdard

Sets or queries the video trigger standard. This is equivalent to selecting the Standard option in the Trigger/Video menu.

Conditions	This command applies to the TBS1000B/EDU, TBS1000, TDS2000C, TDS1000C-EDU, TDS2000B, TDS1000B, TDS2000, TDS1000, TPS2000B, and TPS2000 Series only.
Group	Trigger
Syntax	TRIGger:MAIn:VIDeo:STANdard { NTSc PAL } TRIGger:MAIn:VIDeo:STANdard?
Arguments	<p>NTSC (default) specifies the NTSC video standard.</p> <p>PAL specifies the PAL or SECAM video standard.</p>
Examples	TRIGGER:MAIN:VIDEO:STANDARD NTSC selects the NTSC standard for the video trigger.

TRIGger:MAIn:VIDeo:SYNC

Sets or queries the type for the video trigger sync. This is equivalent to selecting the Sync option in the Trigger/Video menu.

Group	Trigger
Syntax	TRIGger:MAIn:VIDeo:SYNC { FIELD LINE ODD EVEN LINENum } TRIGger:MAIn:VIDeo:SYNC?
Arguments	<p>FIELD specifies that triggering occur on the vertical sync pulse.</p> <p>LINE specifies that triggering occur on the horizontal sync pulse.</p> <p>ODD specifies triggering on odd fields (TBS1000B/EDU, TBS1000, TDS2000C, TDS1000C-EDU, TDS2000B, TDS1000B, TDS2000, TDS1000, TPS2000B, and TPS2000 Series only.).</p> <p>EVEN specifies triggering on even fields (TBS1000B/EDU, TBS1000, TDS2000C, TDS1000C-EDU, TDS2000B, TDS1000B, TDS2000, TDS1000, TPS2000B, and TPS2000 Series only.).</p> <p>LINENum sets the oscilloscope to trigger on a specific line number, which is specified through TRIGger:MAIn:VIDeo:LINE (TBS1000B/EDU, TBS1000, TDS2000C, TDS1000C-EDU, TDS2000B, TDS1000B, TDS2000, TDS1000, TPS2000B, and TPS2000 Series only.).</p>
Examples	TRIGGER:MAIN:VIDEO:SYNC FIELD selects the vertical synchronization pulse for the video trigger sync.

TRIGger:STATE? (Query Only)

Returns the current state of the triggering system.

NOTE. *Accurate real time reporting of the trigger state within any single waveform acquisition is limited by several factors, including horizontal sweep speed, and communications and task latencies. To check for the completion of a single sequence acquisition, use the *OPC? query.*

Group	Trigger
Syntax	TRIGger:STATE?

Returns ARMED indicates that the oscilloscope is acquiring pretrigger information. All triggers are ignored when TRIGger:STATE is ARMed.

READY indicates that all pretrigger information has been acquired and the oscilloscope is ready to accept a trigger.

TRIGGER indicates that the oscilloscope has seen a trigger and is acquiring the posttrigger information.

AUTO indicates that the oscilloscope is in auto mode and acquires data even in the absence of a trigger.

SAVE indicates that acquisition is stopped or that all channels are off.

SCAN indicates that the oscilloscope is in scan mode.

Examples TRIGGER:STATE? might return READY, indicating that pretrigger data has been acquired and the oscilloscope is waiting for a trigger.

*TST? (Query Only)

(Self-Test) Tests the GPIB interface and always returns a 0.

Group Miscellaneous

Syntax *TST?

Returns 0

UNLock (No Query Form)

Unlocks the front panel. This command is equivalent to LOCK NONE.

NOTE. *If the oscilloscope is in the Remote With Lockout State (RWLS), the UNLock command has no effect. For more information refer to ANSI-IEEE Std. 488.1-1987, Standard Digital Interface for Programmable Instrumentation, section 2.8.3, on RL State descriptions.*

Group Miscellaneous

Syntax UNLock ALL

- Arguments** ALL specifies all front-panel buttons.
- Examples** UNLOCK ALL unlocks all front-panel buttons and knobs so they can be used.

VERBoSe

Sets and queries the Verbose state that controls the length of keywords on query responses. Keywords can be both headers and arguments. This command does not affect IEEE Std 488.2-1987 Common Commands (those starting with an asterisk).

- Group** Miscellaneous
- Syntax** VERBoSe { OFF | ON | <NR1> }
VERBoSe?
- Related Commands** [HEADer](#), [*LRN?](#)
- Arguments** ON or <NR1> ≠ 0 sets the Verbose state true, which returns full-length keywords for applicable setting queries.
OFF or <NR1> = 0 sets the Verbose state false, which returns minimum-length keywords for applicable setting queries.
- Examples** VERBOSE ON sets the Verbose state true.
VERBOSE? might return the value 1, showing that the Verbose state is true.

*WAI (No Query Form)

Prevents the oscilloscope from executing further commands or queries until all pending commands that generate an OPC message are complete. This command allows you to synchronize the operation of the oscilloscope with your application program. (See page 3-7, *Synchronization Methods*.)

The *WAI command will stop execution until certain oscilloscope operations are complete. (See Table 3-3 on page 3-7.)

- Group** Status and Error
- Syntax** *WAI

Related Commands [BUSY?](#), [*OPC](#)

Examples *WAI prevents the oscilloscope from executing any further commands or queries until all pending commands that generate an OPC message are complete.

WAVEFORMANALYSIS:SOURce

Sets or queries the Waveform Analysis source. This command is equivalent to setting the Sources option in the Waveform Analysis menu.

Conditions This command applies to the TPS2000B/TPS2000 Series with TPS2PWR1 Power Analysis Module only.

Group Power Measurement

Syntax WAVEFORMANALYSIS:SOURce { CH1 | CH2 | CH3 | CH4 | MATH }
WAVEFORMANALYSIS:SOURce?

Arguments CH1, CH2, CH3, or CH4 specifies one of the input channels as the waveform analysis source.

NOTE. The "CH3 and CH4" options are only valid for instruments with four channels.

MATH specifies the math waveform as the analysis source.

Examples WAVEFORMANALYSIS:SOURCE CH2 specifies Channel 2 as the waveform analysis source.

WAVFrm? (Query Only)

Returns WFMPre? and CURVe? data for the waveform specified by the DATA:SOURce command. This command is equivalent to sending WFMPre; CURVe. If the waveform specified by the DATA:SOURce command is not displayed, the oscilloscope returns only the waveform transmission parameters (BYT_Nr, BIT_Nr, ENCdg, BN_Fmt, BYT_Or).

Group Waveform

Syntax WAVFrm?

Related Commands [CURVe](#), [DATA:SOURce](#), [WFMPre?](#)

Returns See WFMPre? and CURVe? commands.

WFMPre? (Query Only)

Returns waveform transmission and formatting settings for the waveform specified by the DATA:SOURce command.

If the waveform specified by the DATA:SOURce command is not displayed, the oscilloscope returns only the waveform transmission parameters (BYT_Nr, BIT_Nr, ENCdg, BN_Fmt, BYT_Or).

Group Waveform

Syntax WFMPre?

Related Commands

Returns The format of the response when the DATA:SOURce waveform is activated is:

```
BYT_Nr <NR1>;BIT_Nr <NR1>;ENCdg { ASC | BIN }; BN_Fmt { RI | RP
};BYT_Or { LSB | MSB };NR_Pt <NR1>; WFID <Qstring>;PT_FMT {ENV |
Y};XINcr <NR3>; PT_Off <NR1>;XZERo <NR3>;XUNit<QString>;YMUlt
<NR3>; YZero <NR3>;YOFF <NR3>;YUNit <QString>
```

WFMPre, Additional Commands for Compatibility

The set form of these additional commands is ignored. The query form generates event messages 100 (Command Error) and 420 (Query Unterminated). These commands are included for compatibility purposes only.

Table 2-36: Additional commands for compatibility

Command	Argument	Description
WFMPre:XMUlt	<NR3>	Horizontal (X-axis) scale factor
WFMPre:XOFF	<NR3>	Horizontal (X-axis) offset
WFMPre:ZMUlt	<NR3>	Z-axis scale factor
WFMPre:ZOFF	<NR3>	Z-axis offset

Table 2-36: Additional commands for compatibility (cont.)

Command	Argument	Description
WFMPre:ZUNit	<QString>	Z-axis units
WFMPre:ZZero	<NR3>	Z-axis origin offset

WFMPre:<wfm>? (Query Only)

Returns the waveform formatting data for the waveform specified by <wfm>, if that waveform is active or displayed. If that waveform is not active or displayed, the query fails and the oscilloscope generates event message 420 (Query unterminated) and 2244 (waveform requested is not active).

Group Waveform

Syntax WFMPre:<wfm>?

Returns Returns the response in the following format:

```
WFMPre:<wfm>:WFID <Qstring>;PT_FMT { ENV | Y }; XINcr <NR3>;PT_Off
<NR1>;XZero <NR3>;XUNit <QString>; YMUlt <NR3>;YZero <NR3>;YOFF
<NR3>;YUNit <QString>; NR_Pt <NR1>
```

WFMPre:<wfm>:YZero

Same as WFMPre:YOFF, except that <wfm> specifies the source/destination waveform instead of DATA:SOURCE and DATA:DESTINATION.

For set commands, if <wfm> is not a reference waveform, the oscilloscope generates error 2241.

Group Waveform

Syntax WFMPre:<wfm>:YZero
WFMPre:<wfm>:YZero?

WFMPre:BIT_Nr

Sets or queries the number of bits per waveform point for the waveform to be transferred. Changing the value of WFMPre:BIT_Nr also changes the values of WFMPre:BYT_Nr and DATA:WIDTH.

Group	Waveform
Syntax	WFMPre:BIT_Nr <NR1> WFMPre:BIT_Nr?
Arguments	<NR1> is either 8 or 16, and is equivalent to WFMPre:BYT_Nr * 8 and DATA:WIDTH * 8.
Examples	WFMPRE:BIT_NR might return 8, indicating that there are 8 bits per waveform point.

WFMPre:BN_Fmt

Sets or queries the format of binary data for the waveform to be transferred. Changing the value of WFMPre:BN_Fmt also changes the value of DATA:ENCdg.

Group	Waveform
Syntax	WFMPre:BN_Fmt { RI RP } WFMPre:BN_Fmt?
Arguments	RI specifies signed integer data-point representation. RP specifies positive integer data-point representation.
Examples	WFMPRE:BN_FMT RP specifies that the binary waveform data are positive integer data-points. WFMPRE:BN_FMT? returns either RI or RP as the current waveform data format.

WFMPre:BYT_Nr

Sets or queries the data width for the waveform to be transferred. This command is equivalent to DATA:WIDTH. Changing WFMPre:BYT_Nr also changes WFMPre:BIT_Nr and DATA:WIDTH.

Group	Waveform
Syntax	WFMPre:BYT_Nr <NR1> WFMPre:BYT_Nr?

Arguments <NR1> is an integer in the range of 1 to 2 that sets the number of bytes per point.

Examples WFMPRE:BYT_NR specifies that there are 2 bytes per waveform data point.

WFMPre:BYT_Or

Sets or queries which byte of binary waveform data is transmitted first during a waveform data transfer when DATA:WIDTH or WFMPre:BYT_Nr is set to 2, or WFMPre:BIT_Nr is set to 16. Changing WFMPre:BYT_Or changes DATA:ENCdg.

Group Waveform

Syntax WFMPre:BYT_Or { LSB | MSB }
WFMPre:BYT_Or?

Arguments LSB selects the least significant byte to be transmitted first.
MSB selects the most significant byte to be transmitted first.

Examples WFMPRE:BYT_OR MSB specifies that the most significant byte in the waveform data is transferred first.
WFMPRE:BYT_OR? returns either MSB or LSB depending on which data byte is transferred first.

WFMPre:ENCdg

Sets or queries the type of encoding for waveform data transferred with the CURVe command. Changing WFMPre:ENCdg also changes DATA:ENCdg.

Group Waveform

Syntax WFMPre:ENCdg { ASC | BIN }
WFMPre:ENCdg?

Arguments ASC specifies ASCII curve data.
BIN specifies binary curve data.

Examples `WFMPRE:ENCDG ASC` specifies that the waveform data is in ASCII format.

`WFMPRE:ENCDG?` might return `BIN`, indicating that the waveform data is in binary format.

WFMPre:NR_Pt? (Query Only)

Returns the number of points that are in the transmitted waveform record, as specified by `DATA:SOURce`. The number of points depends on `DATA:START`, `DATA:STOP`, and whether `DATA:SOURce` is `YT` or `FFT`. `NR_Pt` is at most 2500 for `YT` and 1024 for `FFT`. `NR_Pt` is always at least one.

When the `DATA:SOURce` is not displayed, the TDS210 and TDS220 (firmware below V 2.00) with a TDS2CMA communications module will return a value. All other oscilloscope, firmware version, and module combinations will generate an error and will return event code 2244.

Group Waveform

Syntax `WFMPre:NR_Pt?`

Related Commands [DATA:ENCDg](#), [DATA:SOURce](#), [DATA:START](#)

Examples `WFMPRE:NR_PT?` might return 1024, which is the number of data points. If `DATA:WIDTH` is 2, then there are 2048 bytes in the curve.

WFMPre:<wfm>:NR_Pt? (Query Only)

NOTE. *This query is not available when using a TDS210 or TDS220 oscilloscope (firmware below V 2.00) with a TDS2CMA communications module.*

Returns the number of points that are in the transmitted waveform record. The number of points depends on `DATA:START`, `DATA:STOP`, and whether `DATA:SOURce` is `YT` or `FFT`. `NR_Pt` is at most 2500 for `YT` and 1024 for `FFT`. `NR_Pt` is always at least one.

When the `DATA:SOURce` is not displayed, the oscilloscope will generate an error and return event code 2244.

Group Waveform

Syntax WFMPre:<wfm>:NR_Pt?

Related Commands [DATA:SOUrce](#), [DATA:STARt](#)

Examples WFMPre:CH1:NR_Pt

Returns <NR1>, which is the number of data points. If DATA:WIDTH is 2, then there are <NR1>*2 bytes in the curve.

WFMPre:PT_Fmt

The set form of this command sets the format (Y or ENV) of the reference waveform specified by the DATA:DESTination command.

The query form returns the format of the waveform specified by the DATA:SOUrce command, if that waveform is on or displayed. If the waveform is not displayed, the query form of this command generates an error and returns event code 2244.

Group Waveform

Syntax WFMPre:PT_Fmt { ENV | Y }
WFMPre:PT_Fmt?

Related Commands [CURVe](#)

Arguments Y specifies a normal waveform where one ASCII or binary data point is transmitted for each point in the waveform record.

For Y format, the time (absolute coordinate) of a point, relative to the trigger, can be calculated using the following formula. N ranges from 0 to 2499.

$$X_n = XZEro + XINcr (n - PT_OFf)$$

For Y format, the magnitude (usually voltage, relative to ground) (absolute coordinate) of a point can be calculated:

$$Y_n = YZEro + YMUIty (y_n - YOFf)$$

ENV specifies that the oscilloscope transmit the waveform as minimum and maximum point pairs. Peak detect waveforms use ENV format. Peak Detect mode specifies a maximum of 1250 (minimum, maximum) pairs, with the time between pairs being 2*XINcr.

The magnitudes and times of ENV format waveform points can be calculated using the same formulas used for Y format, if you recognize that the points

consist of (minimum, maximum) pairs, where each pair was collected over a time period of $2 * XINcr$.

Thus, the samples for $n=0$ (a minimum) and $n=1$ (a maximum), the first (minimum, maximum) pair, were collected over a time interval of width $2 * XINcr$, that began at the time found by setting n to zero in the formula. The next pair were collected over the interval that began at the time found by setting n to 2 in the formula, and so on.

Examples `WFMPRE:PT_FMT Y` sets the waveform data point format to Y.

`WFMPRE:PT_FMT?` returns either Y or ENV

WFMPre:<wfm>:PT_Fmt

Same as `WFMPre:PT_Fmt`, except that <wfm> specifies the source/destination waveform instead of `DATA:SOURce` and `DATA:DESTINATION`. For set commands, if <wfm> is not a reference waveform, the oscilloscope generates error 2241.

WFMPre:PT_Off

The set form this command is ignored.

The query form always returns a 0, unless the `DATA:SOURce` waveform is not displayed, in which case the query generates an error and returns event code 2244.

This command is included for compatibility with other Tektronix oscilloscopes.

NOTE. Use the `WFMPre:XINcr`, `WFMPre:XUNit`, and `WFMPre:XZEr0` queries to determine the trigger position.

Group Waveform

Syntax `WFMPre:PT_Off`

Arguments Arguments are ignored.

WFMPre:<wfm>:PT_Off

Same as `WFMPre:PT_Off`, except that <wfm> specifies the source/destination waveform instead of `DATA:SOURce` and `DATA:DESTINATION`.

For set commands, if <wfm> is not a reference waveform, the oscilloscope generates error 2241.

Otherwise, the set form of this command is ignored.

WFMPre:WFId? (Query Only)

Returns a descriptive string from the waveform specified in the DATA:SOURce command, if that waveform is active or displayed. If that waveform is not active or displayed, the query fails and the oscilloscope generates an execution error with event code 2244 (waveform requested is not active).

Group	Waveform
Syntax	WFMPre:WFId?
Examples	<p>For a YT waveform. WFMPRE:WFID? might return: WFMPRE:WFID "Ch1, DC coupling, 1.0E0 V/div, 5.0E-4 s/div, 2500 points, Sample mode"</p> <p>For a Math waveform, WFMPRE:WFID? might return: WFMPRE:WFID "Math, DC coupling, 1.0E0 V/div, 5.0E-4 s/div, 2500 points, Sample mode"</p> <p>For an FFT spectrum: (TBS1000, TDS2000C, TDS1000C-EDU, TDS2000B, TDS1000B, TDS2000, and TDS1000 Series and TDS200 Series with a TDS2MM measurement module only). WFMPRE:WFID? might return: WFMPRE:WFID "Math, DC coupling, 1.0E1 dB/div, 2.52525253E4 Hz/div, 1024 points, Sample mode"</p> <p>For TBS1000B/EDU. WFMPRE:WFID? might return: "FFT, DC coupling, 1.0E1 dB/div, 2.52525253E4 Hz/div, 1024 points, Sample mode"</p>

WFMPre:<wfm>:WFId?

Same as WFMPre:WFId, except that <wfm> specifies the source waveform instead of DATA:SOURce.

WFMPre:XINcr

The set form of this command specifies the interval (seconds per point for nonFFT, Hertz per point for FFT) between samples of the reference waveform specified by

the DATA:DESTINATION command. The oscilloscope uses this value to calculate the seconds/division or Hertz/division units shown in the status bar and cursor readouts when displaying a reference waveform.

The query form returns the interval between samples of the waveform specified by the DATA:SOURCE command, if that waveform is active or displayed. If that waveform is inactive or not displayed, the query fails and the oscilloscope generates an execution error with event code 2244 (waveform requested is not active).

NOTE. For waveform records acquired in Peak Detect mode, even though there is a pair of samples for each conceptual time period, the XINcr is such that $(XINcr * recl) = \text{the total time over which the data was collected}$.

Group	Waveform
Syntax	WFMPre:XINcr <NR3> WFMPre:XINcr?
Arguments	<NR3> is the interval between points in the waveform record, in the units specified by WFMPre:XUNit. Note that at some fast sweeps, some points in the waveform record are produced by interpolation.
Examples	DATA:SOURCE CH1; WFMPre:XINCR? might return WFMPre:XINCR 2.0E-6

WFMPre:<wfm>:XINcr

Same as WFMPre:XINcr, except that <wfm> specifies the source/destination waveform instead of DATA:SOURCE and DATA:DESTINATION.

For set commands, if <wfm> is not a reference waveform, the oscilloscope generates error 2241.

WFMPre:XUNit

For all model and firmware combinations except the TDS200 Series with a TDS2CMA communications module, the set form of this command specifies the horizontal units ("s" for seconds and "Hz" for Hertz) for the reference waveform specified by the DATA:DESTINATION command. Setting a reference waveform to Hz causes the oscilloscope to display the waveform as an FFT waveform.

NOTE. For TDS200 oscilloscopes used with a TDS2CMA communications module, the set form is ignored. Waveform commands: *WFMPRE:XUNIT*
WFMPRE:XUNIT

The query form returns the horizontal units for the waveform specified by DATA:SOURce. If the waveform specified by DATA:SOURce is not displayed, the query generates event message 2244.

Group	Waveform
Syntax	WFMPre:XUNit <Qstring> WFMPre:XUNit?
Arguments	<Qstring> is "s" or "Hz"

WFMPre:<wfm>:XUNit

Same as WFMPre:XUNit, except that <wfm> specifies the source/destination waveform instead of DATA:SOURce and DATA:DESTINATION.

WFMPre:XZEro

The set form of this command specifies the position, in XUNits, of the first sample of the reference waveform specified by the DATA:DESTINATION command, relative to the trigger.

The query form returns the position of the first sample of the waveform specified by the DATA:SOURce command, if that waveform is active or displayed.

If that waveform is not active or displayed, the query fails and the oscilloscope generates an execution error with event code 2244 (waveform requested is not active).

The oscilloscope sets WFMPre:XZEro to zero when:

- The display mode is set to XY.
- The DATA:SOURce is set to MATH FFT when the waveform is acquired.

NOTE. The oscilloscope uses XZEro when calculating cursor readouts.

Group	Waveform
--------------	----------

Syntax `WFMPre:XZErO <NR3>`
`WFMPre:XZErO?`

Arguments `<NR3>` is the position, in XUNits, of the first waveform sample.

WFMPre:<wfm>:XZErO

Same as `WFMPre:XZErO`, except that `<wfm>` specifies the source/destination waveform instead of `DATA:SOURce` and `DATA:DESTINATION`.

For set commands, if `<wfm>` is not a reference waveform, the oscilloscope generates error 2241.

WFMPre:YMUIt

YMUIt is a value, expressed in YUNits per digitizer level, used to convert waveform record values to YUNit values using the following formula (where `dl` is digitizer levels):

$$\text{value_in_YUNits} = ((\text{curve_in_dl} - \text{YOFF_in_dl}) * \text{YMUIt}) + \text{YZERO_in_YUNits}$$

The set form of this command sets the vertical scale factor of the reference waveform specified by the `DATA:DESTINATION` command, expressed in YUNits per digitizing level.

The query form returns a value for the waveform specified by the `DATA:SOURce` command, if that waveform is active or displayed. If that waveform is not active or displayed, the query fails and the oscilloscope generates an execution error with event code 2244 (waveform requested is not active).

Group Waveform

Syntax `WFMPre:YMUIt <NR3>`
`WFMPre:YMUIt?`

Arguments `<NR3>` is the vertical scale factor, in YUNits (usually volts) per sample value.

Returns A query result of zero has special meaning. A zero indicates the waveform has unknown vertical scaling. This is possible in the TBS1000B/EDU, TBS1000, TDS2000C, TDS1000C-EDU, TDS2000B, TDS1000B, TDS2000, TDS1000, or TDS200 Series. The TPS2000B/TPS2000 Series will never return zero.

An example of unknown vertical scaling is a math waveform of CH1+CH2 where CH1 vertical scaling is different from CH2 vertical scaling. In this case, WFMPre:YUNit? returns U. (Does not apply to the TPS2000B/TPS2000 Series.)

WFMPre:<wfm>:YMUlt

Same as WFMPre:YMUlt, except that <wfm> specifies the source/destination waveform instead of DATA:SOURce and DATA:DESTINATION.

For set commands, if <wfm> is not a reference waveform, the oscilloscope generates error 2241.

WFMPre:YOff

YOff is a value, expressed in digitizer levels, used to convert waveform record values to YUNit values using the following formula (where dl is digitizer levels):

$$\text{value_in_YUNits} = ((\text{curve_in_dl} - \text{YOff_in_dl}) * \text{YMUlt}) + \text{YZERO_in_YUNits}$$

The set form of this command stores a value for the reference waveform specified by the DATA:DESTINATION command. This value does not affect how the oscilloscope displays the waveform, but does affect the cursor readouts.

The query form returns a value for the waveform specified by the DATA:SOURce command, in digitizer levels, if that waveform is active or displayed. If that waveform is not active or displayed, the query fails and the oscilloscope generates an execution error with event code 2244 (waveform requested is not active).

Group Waveform

Syntax WFMPre:YOff <NR3>
WFMPre:YOff?

Arguments <NR3> is a value expressed in digitizing levels.

WFMPre:<wfm>:YOff

Same as WFMPre:YOff, except that <wfm> specifies the source/destination waveform instead of DATA:SOURce and DATA:DESTINATION.

For set commands, if <wfm> is not a reference waveform, the oscilloscope generates error 2241.

WFMPre:YUNit

For all model and firmware combinations except the TDS200 Series with a TDS2CMA communications module or a TDS2MM measurement module, the set form of this command sets the vertical units for the reference waveform specified by DATA:DESTination.

NOTE. You can set a combination of WFMPre:XUNit and WFMPre:YUNit for a reference waveform that is inconsistent (for example, seconds with dB or Hertz with volts). The oscilloscope will not warn you of this condition. The oscilloscope uses WFMPre:XUNit to determine whether the waveform is a YT or an FFT.

For TDS200 oscilloscopes used with a TDS2CMA communications or a TDS2MM measurement module, the set form is ignored. Refer to the WFMPre:YMULT command for equivalent functionality.

The query form returns the vertical units of the waveform specified by the DATA:SOURce command, if that waveform is active or displayed. If that waveform is not active or displayed, the query fails and the oscilloscope generates an execution error with event code 2244 (waveform requested is not active).

Group Waveform

Syntax WFMPre:YUNit <Qstring>
WFMPre:YUNit?

Arguments <Qstring> is "Volts", "U", or "dB".

The TBS1000B/EDU, TBS1000, TDS2000C, TDS1000C-EDU, TDS2000B, TDS1000B, TPS2000B, and TPS2000 Series have the following additional arguments:

- "A" for amperes
- "VA" for volt × amperes
- "AA" for amperes × amperes
- "VV" for volts × volts

Returns The query returns the following:

- **volts** for volts
- **U** for unknown units (divisions)
- **dB** for decibels
- **?** for unknown mask waveforms units

For the TBS1000B/EDU, TBS1000, TDS2000C, TDS1000C-EDU, TDS2000B, TDS1000B, TPS2000B, and TPS2000 Series, the query can return the following additional values:

- **A** for amperes
- **VA** for volt × amperes
- **AA** for amperes × amperes
- **VV** for volts × volts

WFMPre:<wfm>:YUNit

Same as WFMPre:YUNit, except that <wfm> specifies the source/destination waveform instead of DATA:SOURce and DATA:DESTINATION.

For set commands, if <wfm> is not a reference waveform, the oscilloscope generates error 2241.

WFMPre:YZero

For all model and firmware combinations except the TDS210 or TDS220 oscilloscope (firmware below V 2.00) with a TDS2CMA communications module, YZero is a value, expressed in YUNits, used to convert waveform record values to YUNit values using the following formula (where dl is digitizer levels):

$$\text{value_in_YUNits} = ((\text{curve_in_dl} - \text{YOFF_in_dl}) * \text{YMULt}) + \text{YZERO_in_YUNits}$$

YZero is used when calculating cursor readouts.

The set form of this command affects the reference waveform specified by DATA:DESTINATION.

The query form of this command returns a value for the waveform specified by DATA:SOURce. If that waveform is not active or displayed, the query fails and the oscilloscope generates an execution error with event code 2244 (waveform requested is not active).

NOTE. For the TDS210 or TDS220 oscilloscope (firmware below V 2.00) with a TDS2CMA communications module, the set form is ignored. The query always returns zero.

Group Waveform

Syntax WFMPre:YZero <NR3>
WFMPre:YZero?

Arguments <NR3> is a value, expressed in YUNits.

ZOOM? (Query Only)

Returns all zoom parameters.

Conditions TBS1000B/EDU models only.

Group Zoom

Syntax ZOOM?

ZOOM:FACTOR

Sets or queries the zoom factor of a particular zoom box.

Conditions TBS1000B/EDU models only.

Group Zoom

Syntax ZOOM:FACTOR { X1 | X2 | X5 | X10 }
ZOOM:FACTOR?

Examples ZOOM:FACTOR X5 indicates that the specified zoom range is 20% of the acquired waveform.

ZOOM:HORizontal:POSition

Sets or returns the horizontal position of a particular zoom box.

Conditions TBS1000B/EDU models only.

Group Zoom

Syntax ZOOM:HORizontal:POSition <NR3>
ZOOM:HORizontal:POSition?

Arguments NR3 is 1 to 100. It is the percent of the upper window that is to the left of the screen center.

Examples ZOOM:HORizontal:POSition 50.00 indicates that the zoom reference pointer is current set at 50% of the acquired waveform.

ZOOM:HORizontal:SCALE? (Query Only)

Returns the zoom windows current time scale.

Conditions TBS1000B/EDU models only.

Group Zoom

Syntax ZOOM:HORizontal:SCALE?

ZOOM:MODE

Sets or queries the zoom mode as SCALE/POSition.

Conditions TBS1000B/EDU models only.

Group Zoom

Syntax ZOOM:MODE { SCALE | POSITION }
ZOOM:MODE?

ZOOM:STATE

Sets or queries the zoom on/off state.

Conditions TBS1000B/EDU models only.

Group Zoom

Syntax ZOOM:STATE { ON | OFF }
ZOOM:STATE?

Status and Events

Status and Events

The oscilloscope provides a status and event reporting system for the GPIB, RS-232, and USB interfaces. This system informs you of certain significant events that occur within the oscilloscope.

The oscilloscope status reporting system consists of five 8-bit registers and two queues. This section describes these registers and components, and explains how the event handling system operates.

Registers

Overview

The registers in the event handling system fall into two functional groups:

- Status Registers contain information about the status of the oscilloscope. They include the Standard Event Status Register (SESR).
- Enable Registers determine whether selected types of events are reported to the Status Registers and the Event Queue. They include the Device Event Status Enable Register (DESER), the Event Status Enable Register (ESER), and the Service Request Enable Register (SRER).

Status Registers

The Standard Event Status Register (SESR) and the Status Byte Register (SBR) record certain types of events that may occur while the oscilloscope is in use. IEEE Std 488.2-1987 defines these registers.

Each bit in a Status Register records a particular type of event, such as an execution error or message available. When an event of a given type occurs, the oscilloscope sets the bit that represents that type of event to a value of one. (You can disable bits so that they ignore events and remain at zero. See Enable Registers). Reading the status registers tells you what types of events have occurred.

The Standard Event Status Register (SESR). The SESR records eight types of events that can occur within the oscilloscope. Use the *ESR? query to read the SESR register. Reading the register clears the bits of the register so that the register can accumulate information about new events.

7	6	5	4	3	2	1	0
PON	URQ	CME	EXE	DDE	QYE	RQC	OPC

Figure 3-1: The Standard Event Status Register (SESR)

Table 3-1: SESR bit functions

Bit	Function	
7 (MSB)	PON	Power On. Shows that the oscilloscope was powered on. On completion, the diagnostic self tests also set this bit.
6	URQ	User Request. Indicates that an application event has occurred. *See note.
5	CME	Command Error. Shows that an error occurred while the oscilloscope was parsing a command or query.
4	EXE	Execution Error. Shows that an error executing a command or query.
3	DDE	Device Error. Shows that a device error occurred.
2	QYE	Query Error. Either an attempt was made to read the Output Queue when no data was present or pending, or that data in the Output Queue was lost.
1	RQC	Request Control. This is not used.
0 (LSB)	OPC	operation complete. Shows that the operation is complete. This bit is set when all pending operations complete following an *OPC command.

The Status Byte Register (SBR). Records whether output is available in the Output Queue, whether the oscilloscope requests service, and whether the SESR has recorded any events.

Use a Serial Poll or the *STB? query to read the contents of the SBR. The bits in the SBR are set and cleared depending on the contents of the SESR, the Event Status Enable Register (ESER), and the Output Queue. When you use a Serial Poll to obtain the SBR, bit 6 is the RQS bit. When you use the *STB? query to obtain the SBR, bit 6 is the MSS bit. Reading the SBR does not clear the bits.

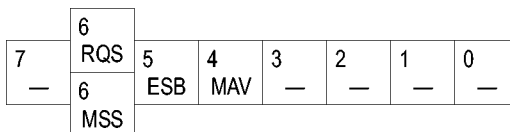

Figure 3-2: The Status Byte Register (SBR)

Table 3-2: SBR bit functions

Bit	Function	
7 (MSB)	—	Not used.
6	RQS	Request Service. Obtained from a serial poll. Shows that the oscilloscope requests service from the GPIB controller.
6	MSS	Master Status Summary. Obtained from *STB? query. Summarizes the ESB and MAV bits in the SBR.
5	ESB	Event Status Bit. Shows that status is enabled and present in the SESR.

Table 3-2: SBR bit functions (cont.)

Bit	Function
4	MAV Message Available. Shows that output is available in the Output Queue.
3	———— Not used.
2	———— Not used.
1-0	———— Not used.

Enable Registers

DESER, ESER, and SRER allow you to select which events are reported to the Status Registers and the Event Queue. Each Enable Register acts as a filter to a Status Register (the DESER also acts as a filter to the Event Queue) and can prevent information from being recorded in the register or queue.

Each bit in an Enable Register corresponds to a bit in the Status Register it controls. In order for an event to be reported to a bit in the Status Register, the corresponding bit in the Enable Register must be set to one. If the bit in the Enable Register is set to zero, the event is not recorded.

Various commands set the bits in the Enable Registers. The Enable Registers and the commands used to set them are described below.

The Device Event Status Enable Register (DESER). This register controls which types of events are reported to the SESR and the Event Queue. The bits in the DESER correspond to those in the SESR.

Use the DESE command to enable and disable the bits in the DESER. Use the DESE? query to read the DESER.

7	6	5	4	3	2	1	0
PON	URQ	CME	EXE	DDE	QYE	RQC	OPC

Figure 3-3: The Device Event Status Enable Register (DESER)

The Event Status Enable Register (ESER). This register controls which types of events are summarized by the Event Status Bit (ESB) in the SBR. Use the *ESE command to set the bits in the ESER. Use the *ESE? query to read it.

7	6	5	4	3	2	1	0
PON	URQ	CME	EXE	DDE	QYE	RQC	OPC

Figure 3-4: The Event Status Enable Register (ESER)

The Service Request Enable Register (SRER). This register controls which bits in the SBR generate a Service Request and are summarized by the Master Status Summary (MSS) bit.

Use the *SRE command to set the SRER. Use the *SRE? query to read the register. The RQS bit remains set to one until either the Status Byte Register is read with a Serial Poll or the MSS bit changes back to a zero.

7	6	5	4	3	2	1	0
—	—	ESB	MAV	—	—	—	—

Figure 3-5: The Service Request Enable Register (SRER)

***PSC Command** The *PSC command controls the Enable Registers contents at power-on. Sending *PSC 1 sets the Enable Registers at power on as follows:

- DESER 255 (equivalent to a DESe 255 command)
- ESER 0 (equivalent to an *ESE 0 command)
- SRER 0 (equivalent to an *SRE 0 command)

Sending *PSC 0 lets the Enable Registers maintain their values in nonvolatile memory through a power cycle.

NOTE. To enable the PON (Power On) event to generate a Service Request, send *PSC 0, use the DESe and *ESE commands to enable PON in the DESER and ESER, and use the *SRE command to enable bit 5 in the SRER. Subsequent power-on cycles will generate a Service Request.

Queues

The *PSC command controls the Enable Registers contents at power-on. Sending *PSC 1 sets the Enable Registers at power on as follows:

Output Queue The oscilloscope stores query responses in the Output Queue and empties this queue each time it receives a new command or query message after an <EOM>. The controller must read a query response before it sends the next command (or query) or it will lose responses to earlier queries.



CAUTION. When a controller sends a query, an <EOM>, and a second query, the oscilloscope normally clears the first response and outputs the second while reporting a Query Error (QYE bit in the ESER) to indicate the lost response. A fast controller, however, may receive a part or all of the first response as well. To avoid this situation, the controller should always read the response immediately after sending any terminated query message or send a DCL (Device Clear) before sending the second query.

Event Queue The Event Queue stores detailed information on up to 20 events. If than 20 events stack up in the Event Queue, the 20th event is replaced by event code 350, "Queue Overflow."

Read the Event Queue with the `EVENT?` query (which returns only the event number), with the `EVMSG?` query (which returns the event number and a text description of the event), or with the `ALLEV?` query (which returns all the event numbers with a description of the event). Reading an event removes it from the queue.

Before reading an event from the Event Queue, you must use the `*ESR?` query to read the summary of the event from the SESR. This makes the events summarized by the `*ESR?` read available to the `EVENT?` and `EVMSG?` queries, and empties the SESR.

Reading the SESR erases any events that were summarized by previous `*ESR?` reads but not read from the Event Queue. Events that follow an `*ESR?` read are put in the Event Queue but are not available until `*ESR?` is used again.

Event Handling Sequence

The following figure shows how to use the status and event handling system. In the explanation that follows, numbers in parentheses refer to numbers in the figure.

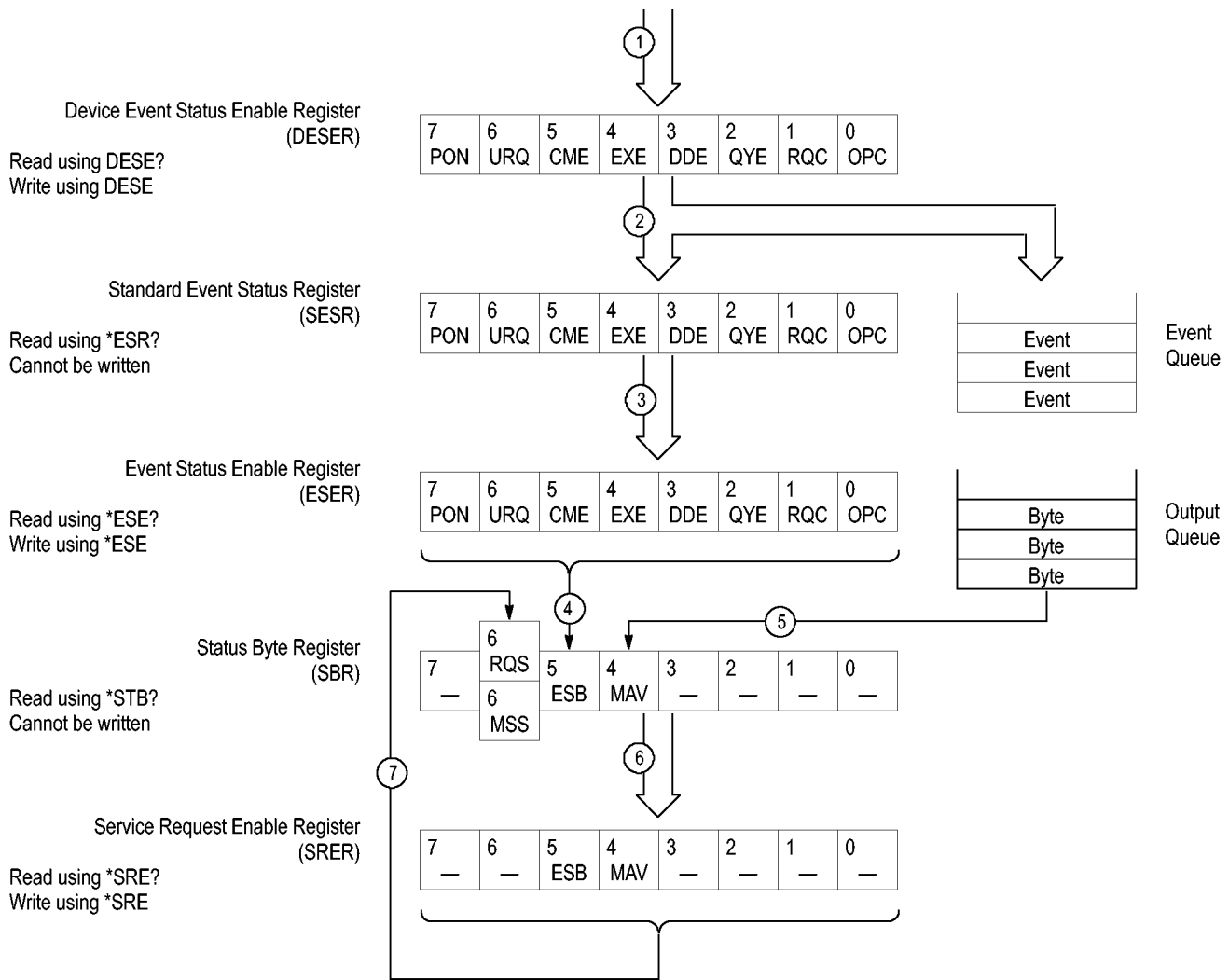

Figure 3-6: Status and Event Handling Process

When an event occurs, a signal is sent to the DESER (1). If that type of event is enabled in the DESER (that is, if the bit for that event type is set to 1), the appropriate bit in the SESR is set to one, and the event is recorded in the Event Queue (2). If the corresponding bit in the ESER is also enabled (3), then the ESB bit in the SBR is set to one (4).

When output is sent to the Output Queue, the MAV bit in the SBR is set to one (5).

When a bit in the SBR is set to one and the corresponding bit in the SRER is enabled (6), the MSS bit in the SBR is set to one and a service request is generated (7).

Synchronization Methods

Overview Although most commands are completed almost immediately after being received by the oscilloscope, some commands start a process that requires time. For example, once a single sequence acquisition command is executed, depending upon the applied signals and trigger settings, it may take an extended period of time before the acquisition is complete. Rather than remain idle while the operation is in process, the oscilloscope will continue processing other commands. This means that some operations will not be completed in the order that they were sent.

Sometimes the result of an operation depends on the result of an earlier operation. A first operation must complete before the next one is processed. The oscilloscope status and event reporting system is designed to accommodate this process.

The Operation Complete (OPC) bit of the Standard Event Status Register (SESR) can be programmed to indicate when certain oscilloscope operations have completed and, by setting the Event Status Enable Register (ESER) to report OPC in the Event Status Bit (ESB) of the Status Byte Register (SBR) and setting the Service Request Enable Register (SRER) to generate service request upon a positive transition of the ESB, a service request (SRQ) interrupt can be generated when certain operations complete as described in this section.

The following oscilloscope operations can generate an OPC:

Table 3-3: Oscilloscope operations that can generate OPC

Command	Conditions
ACQuire:STATE ON or ACQuire:STATE RUN	Only when ACQuire:STOPAfter is set to SEQuence
*CAL?	
CALibrate:CONTINUE	
CALibrate:FACTory	
CALibrate:INTERNAL	
FACTory	
HARDCopy START	
RECALL:SETUp <file as quoted string>	
RECALL:WAVEform <file as quoted string>	
*RST	
SAVE:IMAGe <file as quoted string>	
SAVE:SETUp <file as quoted string>	
SAVE:WAVEform <file as quoted string>	

For example, a typical application might involve acquiring a single-sequence waveform and then taking a measurement on the acquired waveform. You could use the following command sequence to do this:

```

/** Set up conditional acquisition **/
ACQUIRE:STATE OFF
SELECT:CH1 ON
HORIZONTAL:RECORDLENGTH 1000
ACQUIRE:MODE SAMPLE
ACQUIRE:STOPAFTER SEQUENCE
/** Acquire waveform data **/
ACQUIRE:STATE ON
/** Set up the measurement parameters **/
MEASUREMENT:IMMED:TYPE AMPLITUDE
MEASUREMENT:IMMED:SOURCE CH 1
/** Take amplitude measurement **/
MEASUREMENT:MEAS1:VALUE?
    
```

The acquisition of the waveform requires extended processing time. It may not finish before the oscilloscope takes an amplitude measurement (see the following figure). This can result in an incorrect amplitude value.

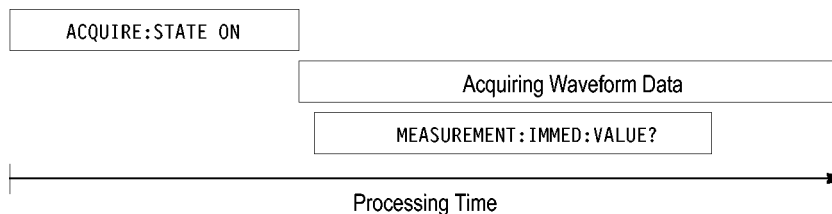

Figure 3-7: Command processing without using synchronization

To be sure the oscilloscope completes waveform acquisition before taking the measurement on the acquired data, you can synchronize the program.

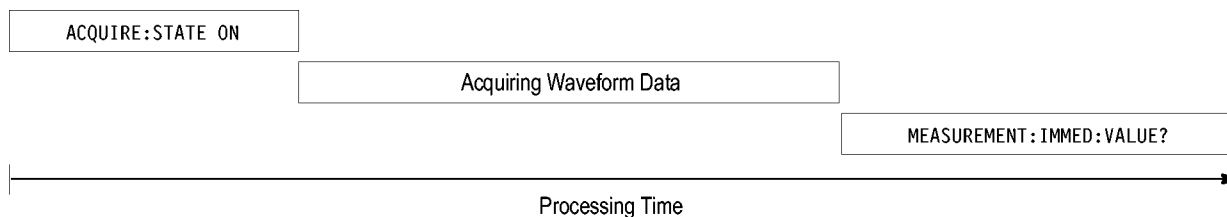

Figure 3-8: Processing sequence with synchronization

You can use four commands to synchronize the operation of the oscilloscope with your application program: *WAI, BUSY, *OPC, and *OPC?

Using the *WAI Command

The *WAI command forces completion of previous commands that generate an OPC message. No commands after the *WAI are processed before the OPC message(s) are generated

The same command sequence using the *WAI command for synchronization looks like this:

```

/* Set up conditional acquisition */
ACQUIRE:STATE OFF
SELECT:CH1 ON
ACQUIRE:MODE SAMPLE
ACQUIRE:STOPAFTER SEQUENCE
/* Acquire waveform data */
ACQUIRE:STATE ON
/* Set up the measurement parameters */
MEASUREMENT:IMMED:TYPE AMPLITUDE
MEASUREMENT:IMMED:SOURCE CH1
/* wait until the acquisition is complete before taking
the measurement*/
*/
*WAI
/* Take amplitude measurement */
MEASUREMENT:IMMED:VALUE?

```

The controller can continue to write commands to the input buffer of the oscilloscope, but the commands will not be processed by the oscilloscope until all in-process OPC operations are complete. If the input buffer becomes full, the controller will be unable to write commands to the buffer. This can cause a time-out.

Using the BUSY Query

The BUSY? query allows you to find out whether the oscilloscope is busy processing a command that has an extended processing time such as single-sequence acquisition.

The same command sequence, using the BUSY? query for synchronization, looks like this:

```

/* Set up conditional acquisition */
ACQUIRE:STATE OFF
SELECT:CH1 ON
ACQUIRE:MODE SAMPLE
ACQUIRE:STOPAFTER SEQUENCE
/* Acquire waveform data */
ACQUIRE:STATE ON
/* Set up the measurement parameters */
MEASUREMENT:IMMED:TYPE AMPLITUDE
MEASUREMENT:IMMED:SOURCE CH1
/* wait until the acquisition is complete before taking
the measurement */
while BUSY? keep looping
/* Take amplitude measurement */
MEASUREMENT:IMMED:VALUE?

```

This sequence lets you create your own wait loop rather than using the *WAI command. The BUSY? query helps you avoid time-outs caused by writing too

many commands to the input buffer. The controller is still tied up though, and the repeated BUSY? query will result in bus traffic.

Using the *OPC Command

If the corresponding status registers are enabled, the *OPC command sets the OPC bit in the Standard Event Status Register (SESR) when an operation is complete. You achieve synchronization by using this command with either a serial poll or service request handler.

Serial Poll Method: Enable the OPC bit in the Device Event Status Enable Register (DESER) and the Event Status Enable Register (ESER) using the DESE and *ESE commands.

When the operation is complete, the OPC bit in the Standard Event Status Register (SESR) will be enabled and the Event Status Bit (ESB) in the Status Byte Register will be enabled.

The same command sequence using the *OPC command for synchronization with serial polling looks like this:

```

/* Set up conditional acquisition */
ACQUIRE:STATE OFF
SELECT:CH1 ON
ACQUIRE:MODE SAMPLE
ACQUIRE:STOPAFTER SEQUENCE
/* Enable the status registers */
DESE 1
*ESE 1
*SRE 0
/* Acquire waveform data */
ACQUIRE:STATE ON
/* Set up the measurement parameters */
MEASUREMENT:IMMED:TYPE AMPLITUDE
MEASUREMENT:IMMED:SOURCE CH1
/* wait until the acquisition is complete before taking the
measurement.*/
*OPC
while serial poll = 0, keep looping
/* Take amplitude measurement */
MEASUREMENT:IMMED:VALUE?
    
```

This technique requires less bus traffic than did looping on BUSY.

Service Request Method: Enable the OPC bit in the Device Event Status Enable Register (DESER) and the Event Status Enable Register (ESER) using the DESE and *ESE commands.

You can also enable service requests by setting the ESB bit in the Service Request Enable Register (SRER) using the *SRE command. When the operation is complete, the oscilloscope will generate a Service Request.

The same command sequence using the *OPC command for synchronization looks like this

```

/* Set up conditional acquisition */
ACQUIRE:STATE OFF
SELECT:CH1 ON
ACQUIRE:MODE SAMPLE
ACQUIRE:STOPAFTER SEQUENCE
/* Enable the status registers */
DESE 1
*ESE 1
*SRE 32
/* Acquire waveform data */
ACQUIRE:STATE ON
/* Set up the measurement parameters */
MEASUREMENT:IMMED:TYPE AMPLITUDE
MEASUREMENT:IMMED:SOURCE CH1
/* wait until the acquisition is complete before taking the
measurement*/
*OPC

```

The program can now do different tasks such as talk to other devices. The SRQ, when it comes, interrupts those tasks and returns control to this task.

```

/* Take amplitude measurement */
MEASUREMENT:IMMED:VALUE?

```

Using the *OPC? Query

The *OPC? query places a 1 in the Output Queue once an operation that generates an OPC message is complete. The *OPC? query does not return until all pending OPC operations have completed. Therefore, your time-out must be set to a time at least if the longest expected time for the operations to complete.

The same command sequence using the *OPC? query for synchronization looks like this:

```

/* Set up single sequence acquisition */
ACQUIRE:STATE OFF
SELECT:CH1 ON
ACQUIRE:MODE SAMPLE
ACQUIRE:STOPAFTER SEQUENCE
/* Acquire waveform data */
ACQUIRE:STATE ON
/* Set up the measurement parameters */
MEASUREMENT:IMMED:TYPE AMPLITUDE
MEASUREMENT:IMMED:SOURCE CH1
/* wait until the acquisition is complete before taking the
measurement*/
*OPC?

```

Wait for read from Output Queue.

```
/* Take amplitude measurement */
MEASUREMENT:IMMED:VALUE?
```

This is the simplest approach. It requires no status handling or loops. However, you must set the controller time-out for longer than the acquisition operation.

Messages

The information contained in the topic tabs above covers all the programming interface messages the oscilloscope generates in response to commands and queries.

For most messages, a secondary message from the oscilloscope gives detail about the cause of the error or the meaning of the message. This message is part of the message string and is separated from the main message by a semicolon.

Each message is the result of an event. Each type of event sets a specific bit in the SESR and is controlled by the equivalent bit in the DESER. Thus, each message is associated with a specific SESR bit. In the message tables, the associated SESR bit is specified in the table title, with exceptions noted with the error message text.

No Event

The following table shows the messages when the system has no events or status to report. These have no associated SESR bit.

Table 3-4: No Event messages

Code	Message
0	No events to report; queue empty
1	No events to report; new events pending *ESR?

Command Error

The following table shows the command error messages generated by improper syntax. Check that the command is properly formed and that it follows the rules in the section on command Syntax.

Table 3-5: Command error messages (CME bit 5)

Code	Message
100	Command error
101	Invalid character
102	Syntax error
103	Invalid separator
104	Data type error
105	GET not allowed
108	Parameter not allowed
109	Missing parameter
110	Command header error
112	Program mnemonic too long

Table 3-5: Command error messages (CME bit 5) (cont.)

Code	Message
113	Undefined header
120	Numeric data error
121	Invalid character in numeric
123	Exponent too large
124	Too many digits
130	Suffix error
131	Invalid suffix
134	Suffix too long
140	Character data error
141	Invalid character data
144	Character data too long
150	String data error
151	Invalid string data
152	String data too long
160	Block data error
161	Invalid block data
170	Command expression error
171	Invalid expression

Execution Error The following table lists the execution errors that are detected during execution of a command.

Table 3-6: Execution error messages (EXE bit 4)

Code	Message
200	Execution error
221	Settings conflict
222	Data out of range
224	Illegal parameter value
241	Hardware missing
250	Mass storage error
251	Missing mass storage
252	Missing media
253	Corrupt media
254	Media full
255	Directory full
256	File name not found

Table 3-6: Execution error messages (EXE bit 4) (cont.)

Code	Message
257	File name error
258	Media protected
259	File name too long
270	Hardcopy error
271	Hardcopy device not responding
272	Hardcopy is busy
273	Hardcopy aborted
274	Hardcopy configuration error
280	Program error
282	Insufficient network printer information
283	Network printer not responding
284	Network printer server not responding
286	Program run time error
287	Print server not found
2200	Measurement error, Measurement system error
2201	Measurement error, Zero period
2202	Measurement error, No period, second waveform
2203	Measurement error, No period, second waveform
2204	Measurement error, Low amplitude, second waveform
2205	Measurement error, Low amplitude, second waveform
2206	Measurement error, Invalid gate
2207	Measurement error, Measurement overflow
2208	Measurement error, No backward Mid Ref crossing
2209	Measurement error, No second Mid Ref crossing
2210	Measurement error, No Mid Ref crossing, second waveform
2211	Measurement error, No backward Mid Ref crossing
2212	Measurement error, No negative crossing
2213	Measurement error, No positive crossing
2214	Measurement error, No crossing, target waveform
2215	Measurement error, No crossing, second waveform
2216	Measurement error, No crossing, target waveform
2217	Measurement error, Constant waveform
2219	Measurement error, No valid edge - No arm sample
2220	Measurement error, No valid edge - No arm cross
2221	Measurement error, No valid edge - No trigger cross
2222	Measurement error, No valid edge - No second cross
2223	Measurement error, Waveform mismatch

Table 3-6: Execution error messages (EXE bit 4) (cont.)

Code	Message
2224	Measurement error, WAIT calculating
2225	Measurement error, No waveform to measure
2226	Measurement error, Null Waveform
2227	Measurement error, Positive and Negative Clipping
2228	Measurement error, Positive Clipping
2229	Measurement error, Negative Clipping
2230	Measurement error, High Ref < Low Ref
2231	Measurement error, No statistics available
2233	Requested waveform is temporarily unavailable
2235	Math error, invalid math description
2240	Invalid password
2241	Waveform requested is invalid
2244	Source waveform is not active
2245	Saveref error, selected channel is turned off
2250	Reference error, the reference waveform file is invalid
2253	Reference error, too many points received
2254	Reference error, too few points received
2259	File too big
2260	Calibration error
2270	Alias error
2271	Alias syntax error
2273	Illegal alias label
2276	Alias expansion error
2277	Alias redefinition not allowed
2278	Alias header not found
2285	TekSecure(R) Pass
2286	TekSecure(R) Fail
2301	Cursor error, Off screen
2302	Cursor error, Cursors are off
2303	Cursor error, Cursor source waveform is off
2500	Setup error, file does not look like a setup file
2501	Setup warning, could not recall all values from external setup
2620	Mask error, too few points received
2760	Mark limit reached
2761	No mark present
2762	Search copy failed

Device Error The following table lists the device errors that can occur during oscilloscope operation. These errors may indicate that the oscilloscope needs repair.

Table 3-7: Device error messages (DDE bit 3)

Code	Message
310	System error
311	Memory error
312	PUD memory lost
314	Save/recall memory lost

System Event The following table lists the system event messages. These messages are generated whenever certain system conditions occur.

Table 3-8: System event messages

Code	Message
400	Query event
401	Power on (PON bit 7 set)
402	Operation complete (OPC bit 0 set)
403	User request (URQ bit 6 set)
404	Power fail (DDE bit 3 set)
405	Request control
410	Query INTERRUPTED (QYE bit 2 set)
420	Query UNTERMINATED (QYE bit 2 set)
430	Query DEADLOCKED (QYE bit 2 set)
440	Query UNTERMINATED after indefinite response (QYE bit 2 set)
468	Knob/Keypad value changed
472	Application variable changed

Execution Warning The following table lists warning messages that do not interrupt the flow of command execution. They also notify you of a possible unexpected results.

Table 3-9: Execution warning messages (EXE bit 4)

Code	Message
528	Parameter out of range
532	Curve data too long, Curve truncated
533	Curve error, Preamble values are inconsistent
540	Measurement warning, Uncertain edge
541	Measurement warning, Low signal amplitude
542	Measurement warning, Unstable histogram

Table 3-9: Execution warning messages (EXE bit 4) (cont.)

Code	Message
543	Measurement warning, Low resolution
544	Measurement warning, Uncertain edge
545	Measurement warning, Invalid in minmax
546	Measurement warning, Need 3 edges
547	Measurement warning, Clipping positive/negative
548	Measurement warning, Clipping positive
549	Measurement warning, Clipping negative

Table 3-10: Execution warning messages (EXE bit 4)

Code	Message
540	Measurement warning
541	Measurement warning, Low signal amplitude
542	Measurement warning, Unstable histogram
543	Measurement warning, Low resolution
544	Measurement warning, Uncertain edge
545	Measurement warning, Invalid min max
546	Measurement warning, Need 3 edges
547	Measurement warning, Clipping positive/negative
548	Measurement warning, Clipping positive
549	Measurement warning, Clipping negative

Internal Warning

The following table shows internal errors that indicate an internal fault in the oscilloscope.

Table 3-11: Internal warning messages

Code	Message
600	Internal warning

Programming Examples

Programming Examples

The following series of commands and queries illustrate many of the most common commands and techniques.

To use these commands and queries over USB, you must use a program or routines that interface to the USBTMC driver on your PC. You can also use the PC Communications software that came on the CD with your oscilloscope to get the same data without having to write programs. For operating information, you can launch the PC Communications software and refer to the online help.

To use these commands and queries over GPIB, you must use a program or routines that interface to the GPIB hardware in your computer. The software is usually supplied by the GPIB hardware manufacturer.

To use these commands and queries over RS-232, you must use a communications program on your computer, such as tip in the Unix environment, or Hyperterminal in the Microsoft Windows environment.

In these examples, data sent from the controller computer to the oscilloscope is prefaced with the > symbol. Replies from the oscilloscope have no preface.

```
> REM "Check for any messages, and clear them from the queue."  
> *ESR?  
128  
> ALLEV ?  
:ALLEV 401,"Power on; "  
> REM "Set the oscilloscope to the default state."  
> FACTORY  
> REM "Set the oscilloscope parameters that differ from the defaults."  
> CH1:VOLTS 2.0  
> HOR:MAIN:SCALE 100e-6  
> TRIG:MAIN:LEVEL 2.4  
> REM "Start a single sequence acquisition."  
> ACQUIRE:STOPAFTER SEQUENCE  
> ACQUIRE:STATE ON  
> REM "Wait for the acquisition to complete."  
> REM "Note: your controller program time-out must be set long enough to  
handle the wait."  
> *OPC?
```

```
1
> REM "Use the oscilloscope built-in measurements to measure the waveform
you acquired."
> MEASU:IMMED:TYPE MEAN
> MEASU:IMMED:VALUE?
:MEASUREMENT:IMMED:VALUE 2.4631931782E0
> REM "Be sure to use the *esr? query to check for measurement errors."
> MEASU:IMMED:TYPE FREQ
> MEASU:IMMED:VALUE?
:MEASUREMENT:IMMED:VALUE 9.9E37
> *ESR?

16
> ALLEV?
:ALLEV 2202,"Measurement error, No period found; "
> REM "Query out the waveform points, for later analysis on your controller
computer." > data:encdg ascii
> CURVE?
:CURVE 7,6,5,5,5,6,6,6,8 [...]
> REM "Query out the parameters used for calculating the times and voltages of
the waveform points."
> WFMPRE?
:WFMPRE:BYT_NR 1;BIT_NR 8;ENCDG ASC;BN_FMT RP;BYT_OR
MSB;NR_PT 2500; [...]
```

Appendices

Appendix A: ASCII Code Chart

B7 B6 B5 BITS B4 B3 B2 B1	0 0	0 0 1	0 1 0	0 1 1	1 0 0	1 0 1	1 1 0	1 1 1
	CONTROL		NUMBERS SYMBOLS		UPPER CASE		LOWER CASE	
0 0 0 0	0 NUL	20 DLE	40 SP	60 0	100 @	120 P	140 SA0	160 SA16
0 0 0 1	1 SOH	21 DC1	41 !	61 1	101 A	121 Q	141 SA1	161 SA17
0 0 1 0	2 STX	22 DC2	42 "	62 2	102 B	122 R	142 SA2	162 SA18
0 0 1 1	3 ETX	23 DC3	43 #	63 3	103 C	123 S	143 SA3	163 SA19
0 1 0 0	4 EOT	24 DC4	44 \$	64 4	104 D	124 T	144 SA4	164 SA20
0 1 0 1	5 ENQ	25 NAK	45 %	65 5	105 E	125 U	145 SA5	165 SA21
0 1 1 0	6 ACK	26 SYN	46 &	66 6	106 F	126 V	146 SA6	166 SA22
0 1 1 1	7 BEL	27 ETB	47 '	67 7	107 G	127 W	147 SA7	167 SA23
1 0 0 0	8 BS	30 CAN	50 (70 8	110 H	130 X	150 SA8	170 SA24
1 0 0 1	9 HT	31 EM	51)	71 9	111 I	131 Y	151 SA9	171 SA25
1 0 1 0	A LF	32 SUB	52 *	72 :	112 J	132 Z	152 SA10	172 SA26
1 0 1 1	B VT	33 ESC	53 +	73 ;	113 K	133 [153 SA11	173 SA27
1 1 0 0	C FF	34 FS	54 ,	74 <	114 L	134 \	154 SA12	174 SA28
1 1 0 1	D CR	35 GS	55 -	75 =	115 M	135]	155 SA13	175 SA29
1 1 1 0	E SO	36 RS	56 .	76 >	116 N	136 ^	156 SA14	176 SA30
1 1 1 1	F SI	37 US	57 /	77 ?	117 O	137 _	157 SA15	177 RUBOUT (DEL)
	ADDRESSED COMMANDS	UNIVERSAL COMMANDS	LISTEN ADDRESSES	TALK ADDRESSES	SECONDARY ADDRESSES OR COMMANDS			

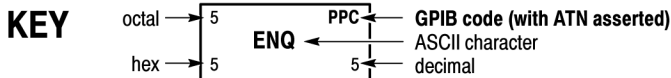

Tektronix
 REF: ANSI STD X3.4-1977
 IEEE STD 488.1-1987
 ISO STD 646-2973

Appendix B: Factory Setup

The following listing is the instrument response to the concatenated command FACTory;SET. This response describes the factory default setup in detail. (Carriage returns have been inserted for clarity.)

Items enclosed in () parentheses are returned by the SET? query response, but are not changed by the FACTory command.

TBS1000, TDS2000C, TDS1000C-EDU, TDS2000B, and TDS1000B Series Oscilloscopes

This is a typical response for 2 channel models with a monochrome display.

```
:HEADER 1;:VERBOSE 1;
:DATA:ENCDG RIBINARY;DESTINATION REFA;SOURCE CH1;START
1;STOP 2500;WIDTH 1;
:LOCK NONE;
:DISPLAY:FORMAT YT;STYLE VECTORS;PERSISTENCE 0;CONTRAST
50;INVERT OFF;
:ACQUIRE:MODE SAMPLE;NUMAVG 16;STATE 1;STOPAFTER RUNSTOP;
:CH1:PROBE 1.0E1;CURRENTPROBE 1.0E1;SCALE 1.0E0;POSITION
0.0E0;COUPLING DC;BANDWIDTH OFF;INVERT OFF;YUNIT "V";
:CH2:PROBE 1.0E1;CURRENTPROBE 1.0E1;SCALE 1.0E0;POSITION
0.0E0;COUPLING DC;BANDWIDTH OFF;INVERT OFF;YUNIT "V";
:HORIZONTAL:VIEW MAIN;MAIN:SCALE 5.0E-4;POSITION 0.0E0;
:HORIZONTAL:DELAY:SCALE 5.0E-5;POSITION 0.0E0;
:TRIGGER:MAIN:MODE AUTO;TYPE EDGE;HOLDOFF:VALUE
5.0E-7;
:TRIGGER:MAIN:EDGE:SOURCE CH1;COUPLING DC;SLOPE RISE;
:TRIGGER:MAIN:VIDEO:SOURCE CH1;SYNC LINE;POLARITY
NORMAL;LINE 1;STANDARD NTSC;
:TRIGGER:MAIN:PULSE:SOURCE CH1;WIDTH:POLARITY
POSITIVE;WHEN EQUAL;WIDTH 1.0E-3;
:TRIGGER:MAIN:LEVEL 0.0E0;:SELECT:CH1 1;CH2 0;MATH 0;REFA
0;REFB 0;
:CURSOR:FUNCTION OFF;SELECT:SOURCE CH1;
:CURSOR:VBARS:UNITS SECONDS;POSITION1 -2.0E-3;POSITION2
2.0E-3;
```

```

:CURSOR:HBARS:POSITION1 3.2E0;POSITION2 -3.2E0;
:MEASUREMENT:MEAS1:TYPE NONE;SOURCE CH1;
:MEASUREMENT:MEAS2:TYPE NONE;SOURCE CH1;
:MEASUREMENT:MEAS3:TYPE NONE;SOURCE CH1;
:MEASUREMENT:MEAS4:TYPE NONE;SOURCE CH1;
:MEASUREMENT:MEAS5:TYPE NONE;SOURCE CH1;
:MEASUREMENT:IMMED:TYPE PERIOD;SOURCE1 CH1;
:MATH:DEFINE "CH1 - CH2";VERTICAL:POSITION 0.0E0;SCALE 2.0E0;
:MATH:FFT:HORIZONTAL:POSITION 5.0E1;SCALE 1.0E0;
:MATH:FFT:VERTICAL:POSITION 0.0E0;SCALE 1.0E0;
:HARDCOPY:BUTTON PRINTS;FORMAT JPEG;PORT USB;LAYOUT
PORTRAIT;INKSAVER ON;
:PICTBRIDGE:PAPERSIZE DEFLT;IMAGESIZE DEFLT;PAPERTYPE
DEFLT;PRINTQUAL DEFLT;DATEPRINT DEFLT;IDPRINT DEFLT;
:LANGUAGE ENGLISH;
:AUTORANGE:SETTINGS BOTH;
:SAVE:IMAGE:FILEFORMAT JPEG

```

TPS2000 Series Oscilloscopes

Items enclosed in < > brackets are present only when the TPS2PWR1 Power Application Module software key is installed.

This is a typical response for 2 channel models.

```

:HEADER 1;:VERBOSE 1;
:DATA:ENCDG RIBINARY;DESTINATION REFA;SOURCE CH1;START
1;STOP 2500;WIDTH 1;
:LOCK NONE;
:DISPLAY:FORMAT YT;STYLE VECTORS;PERSISTENCE 0;BRIGHTNESS
30;CONTRAST 50;INVERT OFF;
:ACQUIRE:MODE SAMPLE;NUMAVG 16;STATE 1;STOPAFTER RUNSTOP;
:CH1:PROBE 1.0E1;CURRENTPROBE 1.0E1;SCALE 1.0E0;POSITION
0.0E0;COUPLING DC;BANDWIDTH OFF;INVERT OFF;YUNIT "V";
:CH2:PROBE 1.0E1;CURRENTPROBE 1.0E1;SCALE 1.0E0;POSITION
0.0E0;COUPLING DC;BANDWIDTH OFF;INVERT OFF;YUNIT "V";

```



```
:HORIZONTAL:VIEW MAIN;MAIN:SCALE 5.0E-4;POSITION 0.0E0;
:HORIZONTAL:DELAY:SCALE 5.0E-5;POSITION 0.0E0;
:TRIGGER:MAIN:MODE AUTO;TYPE EDGE;HOLDOFF:VALUE 5.0E-7;
:TRIGGER:MAIN:EDGE:SOURCE CH1;COUPLING DC;SLOPE RISE;
:TRIGGER:MAIN:VIDEO:SOURCE CH1;SYNC LINE;POLARITY
NORMAL;LINE 1;STANDARD NTSC;
:TRIGGER:MAIN:PULSE:SOURCE CH1;WIDTH:POLARITY
POSITIVE;WHEN EQUAL;WIDTH 1.0E- 3;
:TRIGGER:MAIN:LEVEL 0.0E0;;SELECT:CH1 1;CH2 0;MATH 0;REFA
0;REFB 0;
:CURSOR:FUNCTION OFF;SELECT:SOURCE CH1;
:CURSOR:VBARS:UNITS SECONDS;POSITION1 -2.0E-3;POSITION2
2.0E-3;
:CURSOR:HBARS:POSITION1 3.2E0;POSITION2 -3.2E0;
:MEASUREMENT:MEAS1:TYPE NONE;SOURCE CH1;
:MEASUREMENT:MEAS2:TYPE NONE;SOURCE CH1;
:MEASUREMENT:MEAS3:TYPE NONE;SOURCE CH1;
:MEASUREMENT:MEAS4:TYPE NONE;SOURCE CH1;
:MEASUREMENT:MEAS5:TYPE NONE;SOURCE CH1;
:MEASUREMENT:IMMED:TYPE PERIOD;SOURCE1 CH1;<SOURCE2
CH2;>
:MATH:DEFINE "CH1 - CH2";VERTICAL:POSITION 0.0E0;SCALE 2.0E0;
:MATH:FFT:HORIZONTAL:POSITION 5.0E1;SCALE 1.0E0;
:MATH:FFT:VERTICAL:POSITION 0.0E0;SCALE 1.0E0;
:HARDCOPY:BUTTON PRINTS;FORMAT EPSON;PORT
CENTRONICS;LAYOUT PORTRAIT;INKSAVER ON;
:LANGUAGE ENGLISH;
:AUTORANGE:SETTINGS BOTH;
:SAVE:IMAGE:FILE FORMAT BMP;
<:POWERANALYSIS:SOURCES CH1CH2;>
<:WAVEFORMANALYSIS:SOURCE CH1;>
<:HARMONICS:ENABLE OFF;SETUP AUTOMATIC;SHOW ALL;SELECT
1;SOURCE CH1;>
```

```
<:SWLOSS:ACQUIRE CONTINUOUS;ENABLE OFF;SOURCES
CH1CH2;STOPAFTER 50;TONSTART 90;TONEND 10;TOFFSTART
10;TOFFEND 10;VSAT 1.0E0;UNITS WATTS>
```

TPS2000B Series Oscilloscopes

Items enclosed in < > brackets are present only when the TPS2PWR1 Power Application Module software key is installed.

This is a typical response for 2 channel models.

```
:HEADER 1;:VERBOSE 1;

:DATA:ENCDG RIBINARY;DESTINATION REFA;SOURCE CH1;START
1;STOP 2500;WIDTH 1;

:LOCK NONE;

:DISPLAY:FORMAT YT;STYLE VECTORS;PERSISTENCE 0;BRIGHTNESS
30;CONTRAST 50;INVERT OFF;

:ACQUIRE:MODE SAMPLE;NUMAVG 16;STATE 1;STOPAFTER RUNSTOP;

:CH1:PROBE 1.0E1;CURRENTPROBE 1.0E1;SCALE 1.0E0;POSITION
0.0E0;COUPLING DC;BANDWIDTH OFF;INVERT OFF;YUNIT "V";

:CH2:PROBE 1.0E1;CURRENTPROBE 1.0E1;SCALE 1.0E0;POSITION
0.0E0;COUPLING DC;BANDWIDTH OFF;INVERT OFF;YUNIT "V";

:HORIZONTAL:VIEW MAIN;MAIN:SCALE 5.0E-4;POSITION 0.0E0;

:HORIZONTAL:DELAY:SCALE 5.0E-5;POSITION 0.0E0;

:TRIGGER:MAIN:MODE AUTO;TYPE EDGE;HOLDOFF:VALUE 5.0E-7;

:TRIGGER:MAIN:EDGE:SOURCE CH1;COUPLING DC;SLOPE RISE;

:TRIGGER:MAIN:VIDEO:SOURCE CH1;SYNC LINE;POLARITY
NORMAL;LINE 1;STANDARD NTSC;

:TRIGGER:MAIN:PULSE:SOURCE CH1;WIDTH:POLARITY
POSITIVE;WHEN EQUAL;WIDTH 1.0E- 3;

:TRIGGER:MAIN:LEVEL 0.0E0;:SELECT:CH1 1;CH2 0;MATH 0;REFA
0;REFB 0;

:CORSOR:FUNCTION OFF;SELECT:SOURCE CH1;

:CORSOR:VBARS:UNITS SECONDS;POSITION1 -2.0E-3;POSITION2
2.0E-3;

:CORSOR:HBARS:POSITION1 3.2E0;POSITION2 -3.2E0;

:MEASUREMENT:MEAS1:TYPE NONE;SOURCE CH1;
```

```

:MEASUREMENT:MEAS2:TYPE NONE;SOURCE CH1;
:MEASUREMENT:MEAS3:TYPE NONE;SOURCE CH1;
:MEASUREMENT:MEAS4:TYPE NONE;SOURCE CH1;
:MEASUREMENT:MEAS5:TYPE NONE;SOURCE CH1;
:MEASUREMENT:IMMED:TYPE PERIOD;SOURCE1 CH1;<SOURCE2
CH2;>
:MATH:DEFINE "CH1 - CH2";VERTICAL:POSITION 0.0E0;SCALE 2.0E0;
:MATH:FFT:HORIZONTAL:POSITION 5.0E1;SCALE 1.0E0;
:MATH:FFT:VERTICAL:POSITION 0.0E0;SCALE 1.0E0;
:HARDCOPY:BUTTON PRINTS;FORMAT EPSON;PORT
CENTRONICS;LAYOUT PORTRAIT;INKSAVER ON;
:LANGUAGE ENGLISH;
:AUTORANGE:SETTINGS BOTH;
:SAVE:IMAGE:FILE FORMAT BMP;
<:POWERANALYSIS:SOURCES CH1CH2;>
<:WAVEFORMANALYSIS:SOURCE CH1;>
<:HARMONICS:ENABLE OFF;SETUP AUTOMATIC;SHOW ALL;SELECT
1;SOURCE CH1;>
<:SWLOSS:ACQUIRE CONTINUOUS;ENABLE OFF;SOURCES
CH1CH2;STOPAFTER 50;TONSTART 90;TONEND 10;TOFFSTART
10;TOFFEND 10;VSAT 1.0E0;UNITS WATTS>

```

TDS1000 and TDS2000 Series Oscilloscopes

Items enclosed in < > angle brackets are present only when the TDS2MEM module is installed.

Responses for channel 3 and 4 apply only to 4-channel models.

```

:HEADER 1;(:VERBOSE 1;)
:DATA:ENCDG RIBINARY;DESTINATION REFA;SOURCE CH1;START
1;STOP 2500;WIDTH 1;
(:LOCK NONE;)
:DISPLAY:FORMAT YT;STYLE VECTORS;PERSISTENCE 0;(CONTRAST
50);(INVERT OFF);
:ACQUIRE:MODE SAMPLE;NUMAVG 16;STATE 1;STOPAFTER RUNSTOP;

```

```

:CH1:PROBE 10;SCALE 1.0E0;POSITION 0.0E0;COUPLING
DC;BANDWIDTH OFF;INVERT OFF;

:CH2:PROBE 10;SCALE 1.0E0;POSITION 0.0E0;COUPLING
DC;BANDWIDTH OFF;INVERT OFF;

:CH3:PROBE 10;SCALE 1.0E0;POSITION 0.0E0;COUPLING
DC;BANDWIDTH OFF;INVERT OFF;

:CH4:PROBE 10;SCALE 1.0E0;POSITION 0.0E0;COUPLING
DC;BANDWIDTH OFF;INVERT OFF;

:HORIZONTAL:VIEW MAIN;MAIN:SCALE 5.0E-4;POSITION 0.0E0;

:HORIZONTAL:DELAY:SCALE 5.0E-5;POSITION 0.0E0;

:TRIGGER:MAIN:MODE AUTO;TYPE EDGE;HOLDOFF:VALUE 5.0E-7;

:TRIGGER:MAIN:EDGE:SOURCE CH1;COUPLING DC;SLOPE RISE;

:TRIGGER:MAIN:VIDEO:SOURCE CH1;SYNC LINE;POLARITY
NORMAL;LINE 1;STANDARD NTSC;

:TRIGGER:MAIN:PULSE:SOURCE CH1;WIDTH:POLARITY
POSITIVE;WHEN EQUAL;WIDTH 1.0E-3;

:TRIGGER:MAIN:LEVEL 0.0E0;

:SELECT:CH1 1;CH2 0;CH3 0;CH4 0;MATH 0;REFA 0;REFB 0;REFC 0;REFD
0;

:CURSOR:FUNCTION OFF;SELECT:SOURCE CH1;

:CURSOR:VBARS:UNITS SECONDS;POSITION1 -2.0E-3;POSITION2
2.0E-3;

:CURSOR:HBARS:POSITION1 -3.2E0;POSITION2 3.2E0;

:MEASUREMENT:MEAS1:TYPE NONE;SOURCE CH1;

:MEASUREMENT:MEAS2:TYPE NONE;SOURCE CH1;

:MEASUREMENT:MEAS3:TYPE NONE;SOURCE CH1;

:MEASUREMENT:MEAS4:TYPE NONE;SOURCE CH1;

:MEASUREMENT:MEAS5:TYPE NONE;SOURCE CH1;

:MEASUREMENT:IMMED:TYPE PERIOD;SOURCE CH1;

:MATH:DEFINE "CH1 - CH2";FFT:HORIZONTAL:POSITION 5.0E1;SCALE
1.0E0;

:MATH:FFT:VERTICAL:POSITION 0.0E0;SCALE 1.0E0;

(:HARDCOPY:<BUTTON PRINTS;>FORMAT EPSON;PORT
CENTRONICS;LAYOUT PORTRAIT;INKSAVER ON;)

```

```
(<SAVE:IMAGE:FILEFORMAT BMP;>)
(:LANGUAGE ENGLISH)
```

TDS210 and TDS220 Oscilloscopes

Items enclosed in < > brackets are present only when the TDS2MM module is installed.

```
:HEADER 1;(:VERBOSE 1;)
:DATA:ENCDG RIBINARY;DESTINATION REFA;SOURCE CH1; START
1;STOP 2500;WIDTH 1;
(:LOCK NONE;)
:DISPLAY:FORMAT YT;STYLE VECTORS;PERSISTENCE 0; CONTRAST
50;
:ACQUIRE:MODE SAMPLE;NUMAVG 16;STATE 1; STOPAFTER RUNSTOP;
:CH1:PROBE 10;SCALE 1.0E0;POSITION 0.0E0; COUPLING
DC;BANDWIDTH OFF;<INVERT OFF;>
:CH2:PROBE 10;SCALE 1.0E0;POSITION 0.0E0; COUPLING
DC;BANDWIDTH OFF;<INVERT OFF;>
:HORIZONTAL:VIEW MAIN; MAIN:SCALE 5.0E-4;POSITION 0.0E0;
:HORIZONTAL:DELAY:SCALE 5.0E-5;POSITION 0.0E0;
:TRIGGER:MAIN:MODE AUTO;TYPE EDGE; HOLDOFF:VALUE 5.0E-7;
:TRIGGER:MAIN:EDGE:SOURCE CH1;COUPLING DC;SLOPE RISE;
:TRIGGER:MAIN:VIDEO:SOURCE CH1;SYNC LINE;POLARITY NORMAL;
:TRIGGER:MAIN:LEVEL 0.0E0;
:SELECT:CH1 1;CH2 0;MATH 0;REFA 0;REFB 0;
:CURSOR:FUNCTION OFF;SELECT:SOURCE CH1;
:CURSOR:VBARS:UNITS SECONDS; POSITION1 -2.0E-3; POSITION2
2.0E-3;
:CURSOR:HBARS:POSITION1 -3.2E0; POSITION2 3.2E0;
:MEASUREMENT:MEAS1:TYPE NONE;SOURCE CH1;
:MEASUREMENT:MEAS2:TYPE NONE;SOURCE CH1;
:MEASUREMENT:MEAS3:TYPE NONE;SOURCE CH1;
:MEASUREMENT:MEAS4:TYPE NONE;SOURCE CH1;
:MEASUREMENT:IMMED:TYPE PERIOD;SOURCE CH1;
```

```
:MATH:DEFINE "CH1 + CH2";  
<FFT:HORIZONTAL:POSITION 5.0E1;SCALE 1.0E0;>  
<:MATH:FFT:VERTICAL:POSITION 0.0E0;SCALE 1.0E0;>  
(:HARDCOPY:FORMAT EPSON;PORT CENTRONICS; LAYOUT  
PORTRAIT;)  
(:LANGUAGE ENGLISH)
```

TDS224 Oscilloscopes

Items enclosed in < > brackets are present only when the TDS2MM module is installed.

```
:HEADER 1;(:VERBOSE 1;)  
:DATA:ENCDG RIBINARY;DESTINATION REFA;SOURCE CH1; START  
1;STOP 2500;WIDTH 1;  
(:LOCK NONE;)  
:DISPLAY:FORMAT YT;STYLE VECTORS;PERSISTENCE 0; CONTRAST  
50;  
:ACQUIRE:MODE SAMPLE;NUMAVG 16;STATE 1;STOPAFTER RUNSTOP;  
:CH1:PROBE 10;SCALE 1.0E0;POSITION 0.0E0;COUPLING  
DC;BANDWIDTH OFF;INVERT OFF;  
:CH2:PROBE 10;SCALE 1.0E0;POSITION 0.0E0;COUPLING  
DC;BANDWIDTH OFF;INVERT OFF;  
:CH3:PROBE 10;SCALE 1.0E0;POSITION 0.0E0;COUPLING  
DC;BANDWIDTH OFF;INVERT OFF;  
:CH4:PROBE 10;SCALE 1.0E0;POSITION 0.0E0;COUPLING  
DC;BANDWIDTH OFF;INVERT OFF;  
:HORIZONTAL:VIEW MAIN;MAIN:SCALE 5.0E-4;POSITION 0.0E0;  
:HORIZONTAL:DELAY:SCALE 5.0E-5; POSITION 0.0E0;  
:TRIGGER:MAIN:MODE AUTO;TYPE EDGE; HOLDOFF:VALUE 5.0E-7;  
:TRIGGER:MAIN:EDGE:SOURCE CH1;COUPLING DC;SLOPE RISE;  
:TRIGGER:MAIN:VIDEO:SOURCE CH1;SYNC LINE;POLARITY NORMAL;  
:TRIGGER:MAIN:LEVEL 0.0E0;  
:SELECT:CH1 1;CH2 0;CH3 0;CH4 0;MATH 0;REFA 0; REFB 0;REFC  
0;REFD 0;  
:CURSOR:FUNCTION OFF;SELECT:SOURCE CH1;
```

```
:CURSOR:VBARS:UNITS SECONDS;POSITION1 -2.0E-3; POSITION2
2.0E-3;
:CURSOR:HBARS:POSITION1 -3.2E0;POSITION2 3.2E0;
:MEASUREMENT:MEAS1:TYPE NONE;SOURCE CH1;
:MEASUREMENT:MEAS2:TYPE NONE;SOURCE CH1;
:MEASUREMENT:MEAS3:TYPE NONE;SOURCE CH1;
:MEASUREMENT:MEAS4:TYPE NONE;SOURCE CH1;
:MEASUREMENT:IMMED:TYPE PERIOD;SOURCE CH1;
:MATH:DEFINE "CH1 - CH2";
<FFT:HORIZONTAL:POSITION 5.0E1;SCALE 1.0E0;>
<:MATH:FFT:VERTICAL:POSITION 0.0E0;SCALE 1.0E0;>
(:HARDCOPY:FORMAT EPSON;PORT CENTRONICS; LAYOUT
PORTRAIT;)
(:LANGUAGE ENGLISH)
```

Appendix C: Reserved Words

*CAL	BANdwidth	DC	FINE
*CLS	BATTERIES	DCLine	FIRST
*DDT	BAud	DEF	FLAg
*ESE	BIN	DEFINE	FORCe
*ESR	BIT_Nr	DEFLT	FORMat
*IDN	BMP	DEFault	FREESpace
*LRN	BN_Fmt	DELay	FRENch
*OPC	BOTH	DELEte	FREQuency
*PSC	BRIGHTness	DELTA	FREQuency
*RCL	BUBBLEJet	DELay	FUNction
*RST	BUSY	DESE	GASgauge
*SAV	BUTTON	DESKJet	GERMan
*SRE	BUTTONLIGHT	DESTination	GND
*STB	BYT_Nr	DIAG	GPIb
*TRG	BYT_Or	DIR	HAGAKIPC
*TST	Block	DISplay	HAGAKIPCARD
*WAI	CALibrate	DOTs	HARDCopy
A0	CARD	DPU3445	HARDFlagging
A1	CENtronics	DPU411	HARmonics
A2	CH1	DPU412	HBArs
A3	CH1CH2	DRAFT	HDELTA
A4	CH2	DURAtion	HDR
A5	CH3	E	HEADer
A6	CH3CH4	EDGE	HERtz
A7	CH4	ENABle	HFRej
A8	CM10BY15	ENCdg	HOLDoff
A9	CM13BY18	ENGLISH	HORizonta1
ABOrt	CM15BY21	ENV	HRMS
AC	CM18BY24	EPSC60	ID
ACLINe	CM6BY8	EPSC80	IDPRINT
ACQuire	CM7BY10	EPSIMAGE	IMAGESIZE
ALL	CM9BY13	EPSON	IMAgE
ALLEV	COMpare	EQuAl	IMMed
ASC	CONDUCTION	ERRLOG	IN11BY17
ASCIi	CONTINUE	EVEN	IN2P5BY3P25
AUTO	CONTINUOUS	EVENT	IN4BY6
AUTOMATIC	CONTRast	EVMsg	IN8BY10
AUTORange	COUPling	EVQty	INDEX
AUTOSet	CR	EXECute	INF
AVERage	CRLf	EXT	INIT
B0	CRMS	EXT10	INKSaver
B1	CURRENTPRObe	EXT5	INTERLEAF
B2	CURSOr	FACTory	INTERNAL
B3	CURSORMs	FALL	INVERT
B4	CURVe	FALLINGedge	INVert
B5	CWD	FASTPHOTO	INside
B6	DATALOGging	FFT	ITALian
B7	DATE	FIELD	JAPANEse
B8	DATEPRINT	FILEFormat	JOULES
B9	DATA	FILESytem	JPEG

Appendix C: Reserved Words

JPG	PAL	RUN	TONEND
KOREan	PAPERSIZE	RUNSTop	TONSTART
L	PAPERTYPE	SAMPl	TOTAL
L2	PARity	SAVESAll	TRADitionalchinese
L4	PCX	SAVESImage	TRANSMit
LANGUage	PEAKdetect	SAVE	TRIGger
LANdscap	PERCent	SAVEIMAge	TRUEPOWER
LASERJet	PERIod	SAVEWFM	TURNOff
LAYout	PERSistence	SCAl	TURNON
LETTER	PFPHASE	SECOnds	TYPE
LEVELS	PHase	SECdiv	UNITs
LEVel	PHOTO	SELEct	UNLock
LF	PICTBridge	SEQuence	USB
LFcr	PK2pk	SET	VAlue
LFrej	PLAIN	SETLev	VAR
LIMit	POLarity	SETTings	VBAr
LINE	PORT	SETUp	VDELTA
LINENum	PORTRait	SHOW	VECTors
LOCK	PORTUguese	SIGNAL	VERBose
LOG	POSITIVe	SIMPlifiedchinese	VERTical
LSB	POSITio	SINGLECYcle	VIDEo
MAIn	POWERFACTOR	SLOpe	VIEW
MANUAL	Power	SOFTFlagging	VIOLation
MATH	PowerANALYSIS	SOURCE	VOLTs
MAXImum	PRESENT	SOURCE1	VSAT
MEAN	PRINTQUAL	SOURCE2	WATTS
MEASurement	PRINTS	SOURc	WAVEform
MINImum	PRObe	SOURces	WAVEFORMANALYSIS
MKDir	PT_Fmt	SPANish	WAVEform
MM100BY150	PT_off	SRIBinary	WAVFrm
MM54BY86	PULse	SRPbinary	WFCREST
MODE	PWIdth	STANDARD	WFCYCRMS
MSB	RECAll	START	WFFREQ
MULTICycle	RECOrdlength	STATE	WFID
N	REFx	STATUS	WFMPre
NEGAtive	REM	STOP	WHEN
NEXT	REName	STOPAfter	WIDth
NOISerej	RESUl	STYle	WINDOW
NONE	RI	SWLoss	XINcr
NONE	RIBinary	SYNC	XUNit
NORMAl	RISINGedge	TARGet	XY
NOTEqual	RISe	TEMPLate	XZEr
NRMAL	RLE	TERMinator	Y
NR_Pt	RMDir	THDF	YMUl
NTSc	RMS	THDR	YOff
NUMACq	ROLL100MM	THINKjet	YT
NUMAVg	ROLL127MM	TIFF	YUNit
NWIdth	ROLL210MM	TIME	YZEr
ODD	ROLL89MM	TIME	ZONE
OFF	RP	TOFFEND	
ON	RPBinary	TOFFSTART	
OUTside	RS232	TOLerance	

Glossary

Glossary

ASCII

Acronym for the American Standard Code for Information Interchange. Controllers transmit commands to the digitizing oscilloscope using ASCII character encoding.

Address

A 7-bit code that identifies an instrument on the communication bus. The digitizing oscilloscope must have a unique address for the controller to recognize and transmit commands to it.

Backus-Naur Form (BNF)

A standard notation system for command syntax. The syntax in this manual use BNF notation.

Controller

A computer or other device that sends commands to and accepts responses from the digitizing oscilloscope.

EOI

A mnemonic referring to the control line "End or Identify" on the GPIB interface bus. One of the two possible end-of-message terminators.

EOM

A generic acronym referring to the end-of-message terminator. For GPIB, the end-of-message terminator is either an EOI or the ASCII code for line feed (LF). For RS-232, the end-of-message terminator is the ASCII code for line feed (LF). For USB, the end-of-message terminator is the EOM bit in a USBTMC message.

GPIB Address

When communicating with a TBS1000B/EDU, TBS1000, TDS2000C, TDS1000C-EDU, TDS2000B, or TDS1000B Series oscilloscope using a TEK-USB-488 adapter, you can set a unique GPIB address for the oscilloscope in the UTILITY" Options " GPIB Setup option.

IEEE

Acronym for the Institute of Electrical and Electronics Engineers.

RS-232

A serial, full-duplex, asynchronous communication port that follows ANSI/EIA/TIA-562-1989[1], ANSI/EIA/TIA-574-1990[2], and CCITT V.24-1989[3] standards.

Serial Poll

A device (such as an oscilloscope) on the GPIB bus can request service from the GPIB Controller by asserting the GPIB SRQ line (a Hardware line that is only present on the GPIB communications bus). A device on the USB bus can request service from the host by sending an SRQ packet on the Interrupt-IN endpoint. When a controller or a USB host acknowledges the SRQ, it "serial polls" each open device on the bus to determine which device on the bus requested service.

Any device requesting service returns a status byte with bit 6 set and then unasserts the SRQ line (GPIB only). Devices not requiring service return a status byte with bit 6 cleared.

USB

An acronym for Universal Serial Bus.

USBTMC

An acronym for USB Test and Measurement Class.

USB488

The USBTMC subclass specification that implements an IEEE488-like interface over USB.

Index

Symbols and Numbers

, 2-74

A

ACquire?, 2-39
ACquire:MODE, 2-40
ACquire:NUMACq?, 2-41
ACquire:NUMAVg, 2-41
ACquire:STATE, 2-42
ACquire:STOPAfter, 2-43
Acquisition commands, 2-11
ALLEv?, 2-43
Arguments, 2-7
ASCII, 2-1
 code chart, A-1
AUTORange, 2-44
AUTORange:SETTings, 2-45
AUTORange:STATE, 2-44
AUTOSet, 2-45
AUTOSet:ENABLE, 2-46
AUTOSet:SIGNAL?, 2-46
AUTOSet:VIEW, 2-47

B

BNF (Backus Naur form), 2-1
BUSY?, 2-48

C

*CAL?, 2-48
CALibrate:ABOrt, 2-49
CALibrate:CONTINUE, 2-49
CALibrate:FACTory, 2-50
CALibrate:INTERNAL, 2-50
CALibrate:STATUS?, 2-51
Calibration and Diagnostic commands, 2-11
CH<x>?, 2-51
CH<x>:BANdwidth, 2-52
CH<x>:COUPling, 2-53
CH<x>:CURRENTPRObe, 2-53
CH<x>:INVert, 2-54
CH<x>:POSition, 2-55
CH<x>:PRObe, 2-56

CH<x>:SCAle, 2-56
CH<x>:VOLts, 2-57
CH<x>:YUNit, 2-57
*CLS, 2-58
Command and Query Structure, 2-2
Command Groups, 2-11
Command syntax,
 BNF (Backus Naur form), 2-1
Command,
 syntax, 2-1
 syntax:BNF (Backus Naur form), 2-1
communications modules,
 references to, vii
Conventions, vii
COUNTERFreq?, 2-58
COUNTERFreq:CH1Level, 2-59
COUNTERFreq:CH1State, 2-59
COUNTERFreq:CH1Value?, 2-59
COUNTERFreq:CH2Level, 2-59
COUNTERFreq:CH2State, 2-60
COUNTERFreq:CH2Value?, 2-60
Cursor commands, 2-12
CURSor?, 2-60
CURSor:FUNCTion, 2-61
CURSor:HBArs?, 2-61
CURSor:HBArs:DELTA?, 2-62
CURSor:HBArs:POSITION<x>, 2-62
CURSor:HBArs:UNIts?, 2-63
CURSor:SElect:SOUrce, 2-64
CURSor:VBArS?, 2-64
CURSor:VBArS:DELTA?, 2-64
CURSor:VBArS:HDELTA?, 2-65
CURSor:VBArS:HPOS<x>?, 2-65
CURSor:VBArS:POSITION<x>, 2-66
CURSor:VBArS:SLOPE?, 2-67
CURSor:VBArS:UNIts, 2-67
CURSor:VBArS:VDELTA?, 2-68
CURVe, 2-68

D

DATA, 2-69
DATA:DESTination, 2-70
DATA:ENCdg, 2-70

DATA:SOURce, 2-72
DATA:START, 2-72
DATA:STOP, 2-73
DATA:TARget, 2-73
DATA:WIDth, 2-74
DATALOGging?, 2-74
DATALOGging:DURAtion, 2-74
DATALOGging:SOURCE, 2-75
DATALOGging:STATE, 2-76
DATE, 2-76
*DDT, 2-77
DESE, 2-77
DIAG:RESUlT:FLAg?, 2-78
DIAG:RESUlT:LOG?, 2-79
Display commands, 2-13
DISplay?, 2-79
DISplay:BACKLight, 2-79
DISplay:BRIGHtness, 2-80
DISplay:CONTRast, 2-80
DISplay:FORMat, 2-81
DISplay:INVert, 2-81
DISplay:PERsistence, 2-82
DISplay:STYle, 2-82
Documentation, iv

E

ERRLOG:FIRSt?, 2-83
ERRLOG:NEXt?, 2-83
*ESE, 2-84
*ESR?, 2-84
Event handling, 3-1
EVENT?, 2-85
EVMsg?, 2-85
EVQty?, 2-86
Example programming, 4-1
Examples,
 Programming, 4-1

F

Factory setup,
 detailed description, B-1
FACTory, 2-86
FFT?, 2-94
FFT:HORizontal:POSition, 2-94
FFT:HORizontal:SCAle, 2-94
FFT:SOURce, 2-95

FFT:SRCWFM, 2-95
FFT:VERTical:POSition, 2-95
FFT:VERTical:SCAle, 2-95
FFT:WIN, 2-96
File system commands, 2-15
FILESystem?, 2-88
FILESystem:CWD, 2-88
FILESystem:DELEte, 2-89
FILESystem:DIR?, 2-90
FILESystem:FORMat, 2-90
FILESystem:FREESpace?, 2-91
FILESystem:MKDir, 2-91
FILESystem:REName, 2-92
FILESystem:RMDir, 2-93

H

Hard copy commands, 2-17
HARDCopy, 2-96
HARDCopy:BUTTON, 2-97
HARDCopy:FORMat, 2-98
HARDCopy:INKSaver, 2-100
HARDCopy:LAYout, 2-100
HARDCopy:PORT, 2-101
HARmonics?, 2-102
HARmonics:ENABle, 2-102
HARmonics:FREquency?, 2-103
HARmonics:HRMS?, 2-103
HARmonics:PERCent?, 2-104
HARmonics:PHAsE?, 2-104
HARmonics:RMS?, 2-104
HARmonics:SAVe, 2-104
HARmonics:SElect, 2-105
HARmonics:SETUp, 2-106
HARmonics:SHOW, 2-106
HARmonics:SOURce, 2-107
HARmonics:THDF?, 2-107
HARmonics:THDR?, 2-108
HDR, 2-108
HEADer, 2-108
Horizontal commands, 2-17
HORizontal?, 2-109
HORizontal:DELay?, 2-109
HORizontal:DELay:POSition, 2-110
HORizontal:DELay:SCAle, 2-110
HORizontal:DELay:SECdiv, 2-111
HORizontal:MAIn?, 2-111
HORizontal:MAIn:POSition, 2-112

HORizontal:MAIn:SCAle, 2-112
 HORizontal:MAIn:SECdiv, 2-113
 HORizontal:POSition, 2-113
 HORizontal:RECOrdlength?, 2-113
 HORizontal:SCAle, 2-114
 HORizontal:SECdiv, 2-114
 HORizontal:VIEW, 2-114

I

ID?, 2-115
 *IDN?, 2-116
 IEEE Std. 488.2-1987, 2-1

L

LANGuage, 2-117
 LIMit?, 2-118
 LIMit:COMpare, 2-118
 LIMit:RESUlt:FAIL?, 2-119
 LIMit:RESUlt:PASS?, 2-119
 LIMit:RESUlt:TOTAL?, 2-120
 LIMit:SAVEIMAge, 2-120
 LIMit:SAVEWFM, 2-121
 LIMit:SOUrce, 2-121
 LIMit:STATE, 2-122
 LIMit:STOPAfter:MODe, 2-122
 LIMit:STOPAfter:TIMe, 2-123
 LIMit:STOPAfter:VIOLation, 2-124
 LIMit:STOPAfter:WAVEform, 2-124
 LIMit:TEMPLate, 2-125
 LIMit:TEMPLate:DESTination, 2-125
 LIMit:TEMPLate:DUALSOUrce, 2-126
 LIMit:TEMPLate:SAVEFIRSource, 2-126
 LIMit:TEMPLate:SAVESECSource, 2-127
 LIMit:TEMPLate:SAVESOUrce, 2-127
 LIMit:TEMPLate:SOUrce, 2-127
 LIMit:TEMPLate:TOLerance:HORizontal, 2-128
 LIMit:TEMPLate:TOLerance:VERTical, 2-129
 LOCK, 2-129
 *LRN?, 2-130

M

Manual Conventions, 2-39
 Manuals, iv
 Math commands, 2-20
 MATH?, 2-130
 MATH:DEFINE, 2-130

MATH:FFT?, 2-132
 MATH:FFT:HORizontal:POSition, 2-132
 MATH:FFT:HORizontal:SCAle, 2-133
 MATH:FFT:VERTical:POSition, 2-134
 MATH:FFT:VERTical:SCAle, 2-134
 MATH:VERTical?, 2-135
 MATH:VERTical:POSition, 2-135
 MATH:VERTical:SCAle, 2-136
 Measurement commands, 2-22
 MEASUrement?, 2-136
 MEASUrement:CLEARSNAPSHOT, 2-137
 MEASUrement:GATing, 2-137
 MEASUrement:IMMed?, 2-137
 MEASUrement:IMMed:SOUrce[1], 2-138
 MEASUrement:IMMed:SOURCE2, 2-138
 MEASUrement:IMMed:TYPe, 2-139
 MEASUrement:IMMed:UNIts?, 2-143
 MEASUrement:IMMed:VALue?, 2-143
 MEASUrement:MEAS<x>?, 2-144
 MEASUrement:MEAS<x>:SOUrce, 2-145
 MEASUrement:MEAS<x>:TYPe, 2-145
 MEASUrement:MEAS<x>:UNIts?, 2-149
 MEASUrement:MEAS<x>:VALue?, 2-149
 MEASUrement:SNAPSHOT, 2-150
 MEASUrement:SNAPSOUrce, 2-151
 Message,
 handling, 3-1
 Miscellaneous commands, 2-23
 Mnemonics, 2-6

O

*OPC, 2-151

P

PictBridge commands, 2-24
 PICTBridge:DATEPRINT, 2-152
 PICTBridge:DEF, 2-152
 PICTBridge:IDPRINT, 2-153
 PICTBridge:IMAGESIZE, 2-153
 PICTBridge:PAPERSIZE, 2-154
 PICTBridge:PAPERTYPE, 2-155
 PICTBridge:PRINTQUAL, 2-155
 Power and Battery-Related commands, 2-25
 Power Measurement commands, 2-25
 POWER?, 2-156
 POWer:AC:PRESENT?, 2-156

POWer:BATTERIES:TIME?, 2-157
 POWer:BATTErY<x>:GASgauge?, 2-156
 POWer:BATTErY<x>:STATUS?, 2-157
 POWer:BUTTONLIGHT, 2-158
 POWerANALYSIS:SOURces, 2-158
 Programming examples, 4-1
 Programming,
 examples, 4-1
 *PSC, 2-159

R

*RCL, 2-160
 RECALL:SETUp, 2-160
 RECALL:WAVEForm, 2-161
 REM, 2-162
 RS-232 commands, 2-28
 RS232?, 2-162
 RS232:BAUd, 2-162
 RS232:HARDFlagging, 2-163
 RS232:PARity, 2-164
 RS232:SOFTFlagging, 2-164
 RS232:TRANsmit:TERMinator, 2-165
 *RST, 2-166

S

*SAV, 2-167
 Save and Recall commands, 2-28
 SAve:IMAge, 2-167
 SAve:IMAge:FILEFormat, 2-168
 SAve:SETUp, 2-169
 SAve:WAVEform, 2-170
 SELEct?, 2-171
 SELEct:<wfm>, 2-171
 SELEct:FFT, 2-172
 SET?, 2-172
 Setups,
 factory: TBS1000, TDS2000C, TDS1000C-EDU,
 TDS2000B and TDS1000B, B-1
 factory:TDS1000, B-5
 factory:TDS1000B, B-1
 factory:TDS2000, B-5
 factory:TDS210, B-7
 factory:TDS220, B-7
 factory:TDS224, B-8
 factory:TPS2000, B-2, B-4
 *SRE, 2-173

Status and error commands, 2-29
 Status, 3-1
 *STB?, 2-173
 SWLoss?, 2-174
 SWLoss:ACQuire, 2-174
 SWLoss:AVErAge:CONDUCTION?, 2-175
 SWLoss:AVErAge:N?, 2-175
 SWLoss:AVErAge:TOTAL?, 2-176
 SWLoss:AVErAge:TURNOff?, 2-176
 SWLoss:AVErAge:TURNON?, 2-177
 SWLoss:ENABLe, 2-178
 SWLoss:LEVELS, 2-178
 SWLoss:LOG:CONDUCTION?, 2-179
 SWLoss:LOG:INDEX, 2-179
 SWLoss:LOG:TOTAL?, 2-180
 SWLoss:LOG:TURNOff?, 2-180
 SWLoss:LOG:TURNON?, 2-181
 SWLoss:SAVE, 2-181
 SWLoss:SOURCES, 2-182
 SWLoss:STOPAfter, 2-183
 SWLoss:TOFFEND, 2-183
 SWLoss:TOFFSTART, 2-184
 SWLoss:TONEND, 2-184
 SWLoss:TONSTART, 2-185
 SWLoss:UNITs, 2-185
 SWLoss:VALue:CONDUCTION?, 2-186
 SWLoss:VALue:TOTAL?, 2-186
 SWLoss:VALue:TURNOff?, 2-187
 SWLoss:VALue:TURNON?, 2-187
 SWLoss:VSAT, 2-188
 Syntax,
 BNF (Backus Naur form), 2-1
 command, 2-1

T

TDS2CM communications module,
 see TDS2CMA, vii
 TDS2CMA communications module,
 where to find installation information, 1-1
 TDS2MM measurement module,
 where to find installation information, 1-1
 TIME, 2-188
 TRENDPLOT?, 2-189
 TRENDPLOT:STATE, 2-189
 TRENDPLOT:TIME, 2-189
 TRENDPLOT:TP<x>:AVG?, 2-190
 TRENDPLOT:TP<x>:MAX?, 2-190

TRENDPLOT:TP<x>:MIN?, 2-190
 TRENDPLOT:TP<x>:SCALE?, 2-191
 TRENDPLOT:TP<x>:SCALEMAX?, 2-191
 TRENDPLOT:TP<x>:SCALEMIN?, 2-191
 TRENDPLOT:TP<x>:SOURCE, 2-191
 TRENDPLOT:TP<x>:TYPE, 2-192
 *TRG, 2-192
 Trigger commands, 2-30
 TRIGger, 2-192
 TRIGger:MAIn, 2-193
 TRIGger:MAIn:EDGE?, 2-193
 TRIGger:MAIn:EDGE:COUPling, 2-194
 TRIGger:MAIn:EDGE:SLOpe, 2-194
 TRIGger:MAIn:EDGE:SOUrce, 2-195
 TRIGger:MAIn:FREQuency?, 2-195
 TRIGger:MAIn:HOLDOff?, 2-196
 TRIGger:MAIn:HOLDOff:VALue, 2-196
 TRIGger:MAIn:LEVel, 2-197
 TRIGger:MAIn:MODE, 2-197
 TRIGger:MAIn:PULse?, 2-198
 TRIGger:MAIn:PULse:SOUrce, 2-198
 TRIGger:MAIn:PULse:WIDth?, 2-199
 TRIGger:MAIn:PULse:WIDth:POLarity, 2-199
 TRIGger:MAIn:PULse:WIDth:WHEN, 2-199
 TRIGger:MAIn:PULse:WIDth:WIDth, 2-200
 TRIGger:MAIn:TYPE, 2-201
 TRIGger:MAIn:VIDeo?, 2-201
 TRIGger:MAIn:VIDeo:LINE, 2-201
 TRIGger:MAIn:VIDeo:POLarity, 2-202
 TRIGger:MAIn:VIDeo:SOUrce, 2-202
 TRIGger:MAIn:VIDeo:STANDard, 2-203
 TRIGger:MAIn:VIDeo:SYNC, 2-204
 TRIGger:STATE?, 2-204
 *TST?, 2-205

U

UNLock, 2-205

V

VERBose, 2-206

Vertical commands, 2-32

W

*WAI, 2-206
 Waveform commands, 2-32
 WAVEFORMANALYSIS:SOUrce, 2-207
 WAVFrm?, 2-207
 WFMPre,
 Additional Commands for Compatibility, 2-208
 WFMPre?, 2-208
 WFMPre:<wfm>?, 2-209
 WFMPre:<wfm>:NR_Pt?, 2-212
 WFMPre:<wfm>:YZEro, 2-209
 WFMPre:BIT_Nr, 2-209
 WFMPre:BN_Fmt, 2-210
 WFMPre:BYT_Nr, 2-210
 WFMPre:BYT_Or, 2-211
 WFMPre:ENCdg, 2-211
 WFMPre:NR_Pt?, 2-212
 WFMPre:PT_Fmt, 2-213
 WFMPre:PT_Off, 2-214
 WFMPre:WFId?, 2-215
 WFMPre:XINcr, 2-215
 WFMPre:XUNit, 2-216
 WFMPre:XZEro, 2-217
 WFMPre:YMUlt, 2-218
 WFMPre:YOff, 2-219
 WFMPre:YUNit, 2-220
 WFMPre:YZEro, 2-221

Z

ZOOM?, 2-222
 ZOOM:FACTOR, 2-222
 ZOOM:HORizontal:POSition, 2-223
 ZOOM:HORizontal:SCALE?, 2-223
 ZOOM:MODE, 2-223
 ZOOM:STATE, 2-224