

# TekExpress® Ethernet Tx Compliance Solution

## Printable Application Help





**TekExpress® Ethernet Tx Compliance Solution**  
**Printable Application Help**

Copyright © Tektronix. All rights reserved. Licensed software products are owned by Tektronix or its subsidiaries or suppliers, and are protected by national copyright laws and international treaty provisions. Tektronix products are covered by U.S. and foreign patents, issued and pending. Information in this publication supersedes that in all previously published material. Specifications and price change privileges reserved.

TEKTRONIX and TEK are registered trademarks of Tektronix, Inc.

### **Contacting Tektronix**

Tektronix, Inc.  
14150 SW Karl Braun Drive  
P.O. Box 500  
Beaverton, OR 97077  
USA

For product information, sales, service, and technical support:

- In North America, call 1-800-833-9200.
- Worldwide, visit [www.tek.com](http://www.tek.com) to find contacts in your area.

---

# Table of Contents

Welcome .....	v
---------------	---

## Getting help and support

Related documentation .....	1
Conventions .....	2
Technical support .....	2

## Getting started

Minimum system requirements .....	5
Supported Probes .....	6
Installing the software .....	7
View software version .....	7
Application directories .....	8
File name extensions .....	9

## Operating basics

Launch the application .....	11
Application panels overview .....	12
Global application controls .....	13
Application controls .....	13
Options menu overview .....	15
TekExpress instrument control settings .....	17
View connected instruments .....	17
Configure email settings .....	19
Setup panel .....	20
Setup panel overview .....	20
Set DUT parameters .....	21
Select tests .....	23
Set acquisition tab parameters .....	24
Set configuration tab parameters .....	26
Set preferences tab parameters .....	30
Status panel overview .....	31
Results panel .....	32
Results panel overview .....	32
View test-related files .....	33

Reports panel .....	34
Reports panel overview .....	34
Select report options .....	35
View a report .....	37
Report contents .....	37

## Running tests

Equipment setup .....	39
Equipment connection setup - Differential Source (SMA Probe) .....	39
Equipment connection setup - Single-Ended Source (SMA Cable) .....	41
Equipment connection setup - Jitter-Slave SMA Probe (Differential Source) .....	42
Equipment connection setup - Jitter-Slave SMA Cable (Single-Ended Source) .....	43
Equipment connection setup - Return Loss Calibration .....	44
Equipment connection setup - Return Loss Setup .....	47
Prerequisite .....	48
Compensate the signal path .....	48
Deskew .....	48
Running tests .....	50

## Saving and recalling test setup

Test setup files overview .....	51
Save a test setup .....	51
Open (load) a saved test setup .....	52
Create a test setup from default settings .....	52
Create a test setup using an existing one .....	52

## TekExpress Ethernet Tx measurements

Maximum output droop .....	53
Transmitter timing Jitter-Master .....	54
Transmitter timing Jitter-Slave .....	56
Transmitter Power Spectral Density and Power level .....	58
Transmitter clock frequency .....	60
Transmitter non-linear distortion .....	61
MDI return loss .....	63

## SCPI commands

About SCPI command .....	69
--------------------------	----

---

Socket configuration for SCPI commands .....	69
TEKEXP:*IDN? .....	79
TEKEXP:*OPC? .....	79
TEKEXP:ACQUIRE_MODE .....	80
TEKEXP:ACQUIRE_MODE? .....	80
TEKEXP:EXPORT .....	81
TEKEXP:INFO? .....	81
TEKEXP:INSTRUMENT .....	82
TEKEXP:INSTRUMENT? .....	83
TEKEXP:LASTERROR? .....	83
TEKEXP:LIST? .....	84
TEKEXP:MODE .....	85
TEKEXP:MODE? .....	85
TEKEXP:POPUP .....	86
TEKEXP:POPUP? .....	86
TEKEXP:REPORT .....	87
TEKEXP:REPORT? .....	87
TEKEXP:RESULT? .....	88
TEKEXP:SELECT .....	89
TEKEXP:SELECT? .....	90
TEKEXP:SETUP .....	90
TEKEXP:STATE .....	91
TEKEXP:STATE? .....	91
TEKEXP:VALUE .....	92
TEKEXP:VALUE? .....	93
Command parameters list .....	94





# Welcome

Welcome to the TekExpress® Ethernet Tx Conformance Solution. The application provides turnkey testing & characterization solution for 10GBASE-T measurements as outlined in IEEE 802.3 Section 55, and for 5GBASE-T and 2.5GBASE-T as outlined in NBASE-T Phy Layer Spec 1.1 and IEEE P802.3bz Section 126. Automation options help the customers to meet their conformance testing needs and generate detailed reports. User-defined Mode lets customers make changes to the test limits and perform margin testing as part of extended product characterization.

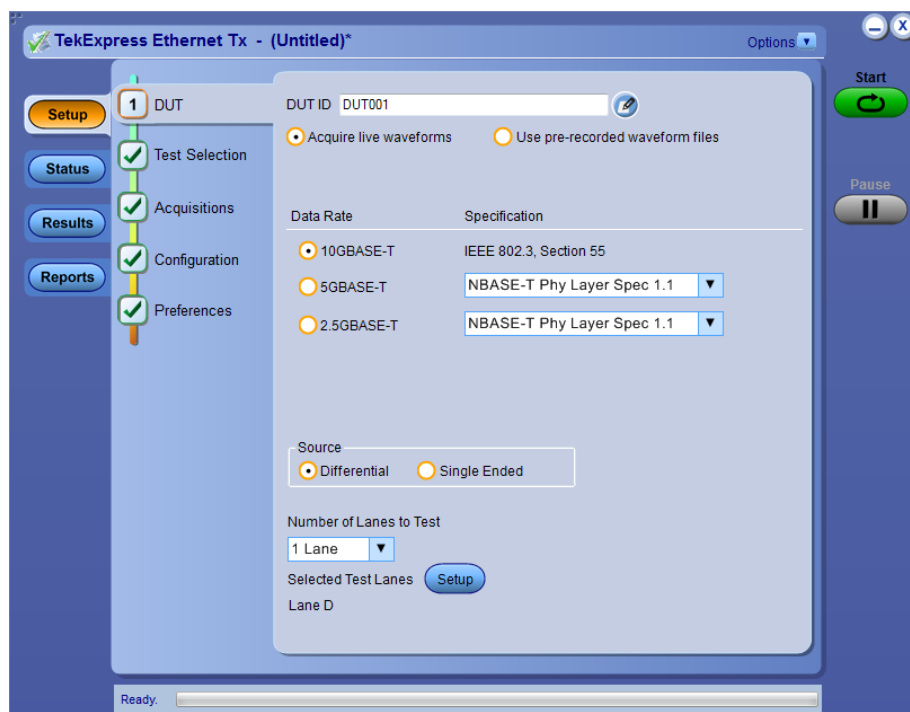

## Key features of TekExpress Ethernet Tx include:

- Comprehensive automated solution for NBASE-T, 2.5GBASE-T, 5GBASE-T and 10GBASE-T PHY testing
- One-button selection of multiple tests and four-channel support
- Detailed test reports with margin and statistical information aid analysis
- User-defined mode enables flexible parameter control for characterization and margin analysis
- Single instrument analysis of time- and frequency-domain measurements
- Signal acquisition and analysis support for differential probes or direct SMA cabling





---

# Getting help and support

## Related documentation

The following documentation is available as part of the TekExpress® Ethernet Tx Solution application.

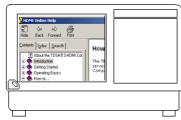
**Table 1: Product documentation**

Item	Purpose	Location
Help	Application operation and User Interface help	
PDF of the help	Printable version of the compiled help	 PDF file that ships with TekExpress Ethernet Tx Solution software distribution ( <i>TekExpress Ethernet-Tx-Automated-Test-Solution-Software-Printable-Help-EN-US.pdf</i> ).



**See also** [Technical support](#)

## Conventions

Help uses the following conventions:

- The term "Application," and "Software" refers to the TekExpress Ethernet Tx Solution application.
- The term “DUT” is an abbreviation for Device Under Test.
- The term “select” is a generic term that applies to the two methods of choosing a screen item (button, control, list item): using a mouse or using the touch screen.

**Table 2: Icon descriptions**

Icon	Meaning
	This icon identifies important information.
	This icon identifies conditions or practices that could result in loss of data.
	This icon identifies additional information that will help you use the application more efficiently.

## Technical support

Tektronix values your feedback on our products. To help us serve you better, please send us your suggestions, ideas, or comments on your application or oscilloscope. Contact Tektronix through mail, telephone, or the Web site, [www.tektronix.com](http://www.tektronix.com).

When you contact Tektronix Technical Support, please include the following information (be as specific as possible):

### General Information

- All instrument model numbers
- Hardware options, if any
- Probes used
- Your name, company, mailing address, phone number, FAX number
- Please indicate if you would like to be contacted by Tektronix about your suggestion or comments.

**Application Specific Information**

- Software version number
- Description of the problem such that technical support can duplicate the problem
- If possible, save the setup files for all the instruments used and the application.
- If possible, save the TekExpress setup files, log.xml, \*.TekX (session files and folders), and status messages text file.
- If possible, save the waveform on which you are performing the measurement as a .wfm file.



---

# Getting started

## Minimum system requirements

The following table shows the minimum system requirements to install and run the TekExpress Ethernet Tx application.

**Table 3: System requirements**

Component	Description	
Oscilloscope	<b>Supported Scopes</b>	<b>Data Rate</b>
	DPO7254C	2.5GBASE-T and 5GBASE-T
	DPO7354C DPO/DSA/MSO70000C DPO/MSO70000DX DPO/DSA70000D DPO/DPS70000SX	2.5GBASE-T, 5GBASE-T, and 10GBASE-T
Processor	Same as the oscilloscope	
Operating System	Windows 7	
Memory	Same as the oscilloscope	
Hard Disk	Same as the oscilloscope	
Display	Super VGA resolution or higher video adapter (800 x 600 minimum video resolution for small fonts or 1024 x 768 minimum video resolution for large fonts). The application is best viewed at 96 dpi display settings <sup>1</sup>	
Firmware	<ul style="list-style-type: none"><li>■ TekScope 7.6.5 or above</li></ul>	
Software	<ul style="list-style-type: none"><li>■ IronPython 2.7.3 installed</li><li>■ PyVisa 1.0.0.25 installed</li><li>■ Microsoft .NET 4.0 Framework</li><li>■ Microsoft Internet Explorer 7.0 SP1 or greater, or other Web browser for viewing reports</li><li>■ Adobe Reader software 7.0 or greater for viewing portable document format (PDF) files</li></ul>	
Other Devices	<ul style="list-style-type: none"><li>■ Microsoft compatible mouse or compatible pointing device.</li><li>■ Two USB ports (four USB ports recommended).</li></ul>	

---

<sup>1</sup> If TekExpress is running on an instrument that has a video resolution less than 800x600, connect and configure a second monitor to the instrument.

## Supported Probes

The table gives the list of probes recommended for the TekExpress Ethernet Tx application.

Oscilloscope Model	For Droop, PSD, Linearity, Clock Frequency, Jitter-Master and Jitter Slave measurements	For Return Loss measurement
DPO7354	P6330 – Minimum of one and maximum of four are required	P6330 – Minimum of two are required
	TDP3500 – Minimum of one and maximum of four are required	TDP3500 – Minimum of two are required
	SMA Cables – Minimum of two are required	NA
DPO70000 and MSO70000	P6330 – Minimum of one and a maximum of four are required	P6330 – Minimum of two are required
	P7330 , P7340A, P7350, P7360A, P7380A and P7313 – Minimum of one and maximum of four are required	P7330 , P340A, P7350, P7360A, P7380A and P7313 – Minimum of two are required
	Trimode probes (P7504, P7506, P7508, P7513A, P7516 & P7520A) – A minimum of one and maximum of four are required	Trimode probes (P7504, P7506, P7508, P7513A, P7516 & P7520A) – Minimum of two are required
	P7350SMA, P7380SMA and P7313SMA – Minimum of one and maximum of four are required	NA
	SMA cables – Minimum of two are required	NA



## Installing the software

Follow the steps to download and install the latest TekExpress Ethernet Tx Solution. See [Minimum system requirements](#) for compatibility.

1. Type the URL [www.tek.com](http://www.tek.com) in the address bar of web browser and click Software Downloads
2. Enter **TekExpress Ethernet Tx Solution** in the *Enter your keywords* field, and click **Search**
3. Select the latest version of software and follow the instructions to download. Copy the executable file into the oscilloscope.
4. Double-click the executable and follow the on-screen instructions. The software is installed at C:\Program Files\Tektronix\TekExpress\TekExpress Ethernet Tx\
5. Select **Analyze > TekExpress Ethernet Tx** from the TekScope menu to [launch the application](#).

## View software version

Use the following instructions to view version information for the application and for the application modules such as the Programmatic Interface and the Programmatic Interface Client.

To view version information for Ethernet Tx, click  button in the TekExpress application and select **About TekExpress**.

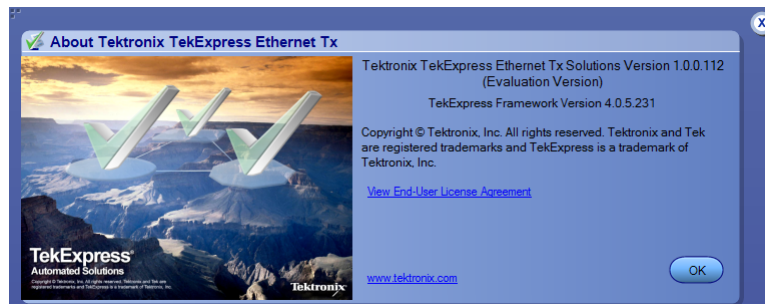

**NOTE.** This example shows a typical Version Details dialog box, and may not reflect the actual values as shown when you open this item in the application.

## Application directories

### TekExpress Ethernet Tx application

The TekExpress Ethernet Tx application files are installed at the following location:

C:\Program Files\Tektronix\TekExpress\TekExpress Ethernet Tx

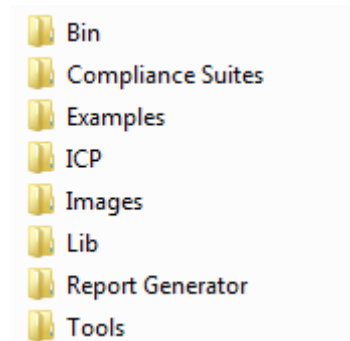

The following table lists the application directory names and their purpose.

**Table 4: Application directories and usage**

Directory names	Usage
Bin	Contains TekExpress Ethernet Tx application libraries
Compliance Suites	Contains compliance-specific files
Examples	Contains various support files
ICP	Contains instrument and TekExpress Ethernet Tx application-specific interface libraries
Images	Contains images of the TekExpress Ethernet Tx application
Lib	Contains utility files specific to the TekExpress Ethernet Tx application
Report Generator	Contains style sheets for report generation
Tools	Contains instrument and TekExpress Ethernet Tx application-specific files

**See also** [View test-related files](#)  
[File name extensions](#)

## File name extensions

The TekExpress Ethernet Tx application uses the following file name extensions:

File name extension	Description
.TekX	Application session files (the extensions may not be displayed)
.py	Python sequence file
.xml	Test-specific configuration information (encrypted) files Application log files
.wfm	Test waveform files
.mht	Test result reports (default) Test reports can also be saved in HTML format
.pdf	Test result reports Application help document
.xslt	Style sheet used to generate reports

**See also** [View test-related files](#)  
[Application directories](#)



# Operating basics

## Launch the application

To launch the TekExpress Ethernet Tx Solution, select **Analyze > TekExpress Ethernet Tx** from the TekScope menu.

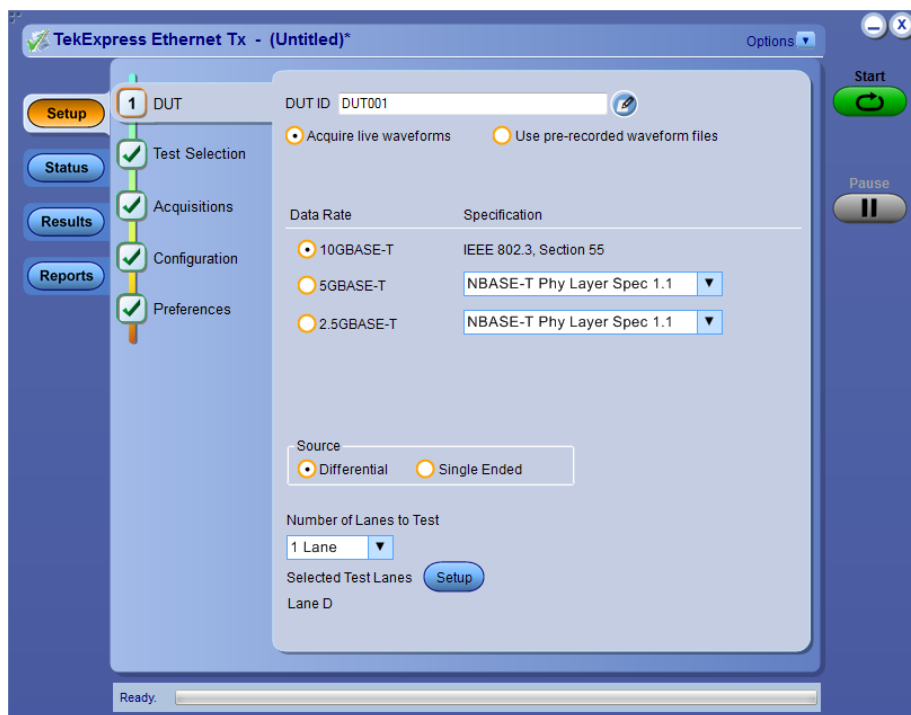

When you launch the application for the first time, the file C:\Users\

If the application goes behind the oscilloscope application, click **Application > Ethernet Tx** to bring it to the front. To keep the Ethernet Tx application window on top, select **Keep On Top** from the Ethernet Tx *Options menu*.

See also [Application controls](#)  
[Application panel overview](#)

## Application panels overview

TekExpress Ethernet Tx Solution uses panels to group related configuration, test, and results settings. Click any button to open the associated panel. A panel may have one or more tabs that list the selections available in that panel. Controls in a panel can change depending on settings made in that panel or another panel.

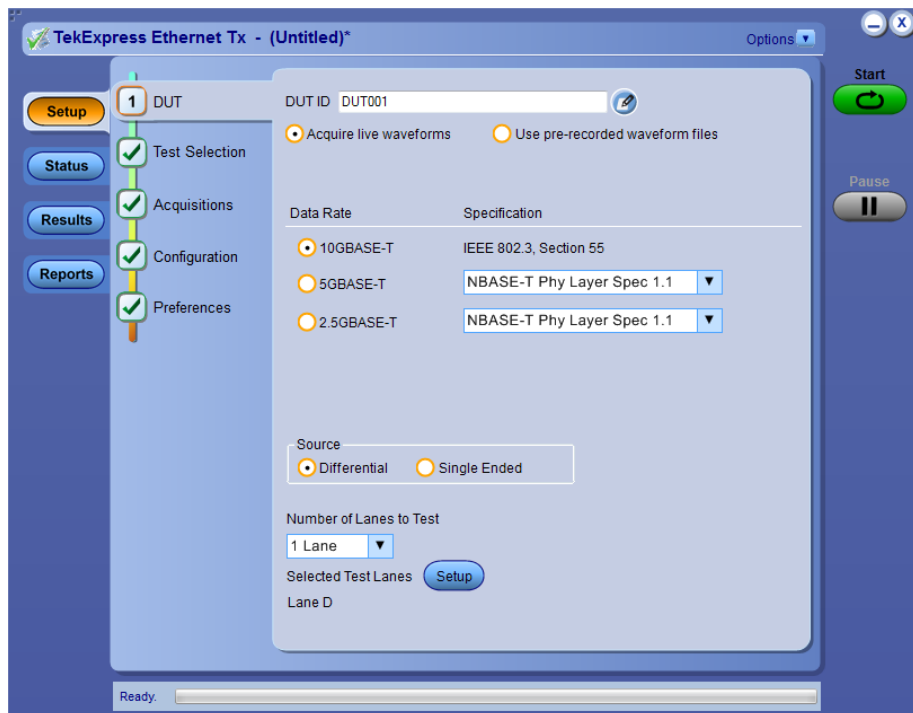

**Table 5: Application panels overview**





Panel Name	Purpose
<a href="#">Setup panel</a>	The Setup panel shows the test setup controls. Click the <b>Setup</b> button to open this panel. Use this panel to: <ul style="list-style-type: none"> <li>■ <a href="#">Set DUT tab parameters</a></li> <li>■ <a href="#">Select tests</a></li> <li>■ <a href="#">Set acquisition tab parameters</a></li> <li>■ <a href="#">Set configuration tab parameters</a></li> <li>■ <a href="#">Set preferences tab parameters</a></li> </ul>
<a href="#">Status panel</a>	View the progress and analysis status of the selected tests, and view test logs.
<a href="#">Results panel</a>	View a summary of test results and select result viewing preferences.
<a href="#">Reports panel</a>	Browse for reports, save reports as specific file types, specify report naming conventions, select report content to include (such as summary information, detailed information, user comments, setup configuration, application configuration), and select report viewing options.

See also [Application controls](#)



## Global application controls

**Application controls** This section describes the application controls.

**Table 6: Application controls description**

Item	Description
<p><i>Options menu</i></p> 	<p>Menu to display global application controls.</p>
<p><i>Test Panel buttons</i></p> 	<p>Controls that open panels for configuring test settings and options.</p>
<p>Start / Stop button</p> 	<p>Use the Start button to start the test run of the measurements in the selected order. If prior acquired measurements are not cleared, then new measurements are added to the existing set. The button toggles to the Stop mode while tests are running. Use the Stop button to abort the test.</p>
<p>Pause / Continue button</p> 	<p>Use the Pause button to temporarily pause the acquisition. When a test is paused, this button changes to "Continue."</p>
<p>Clear button</p> 	<p>Use the Clear button to clear all existing measurement results. Adding or deleting a measurement, or changing a configuration parameter of an existing measurement, also clears measurements. This is to prevent the accumulation of measurement statistics or sets of statistics that are not coherent. This button is available only on <a href="#">Results panel</a>.</p>



Item	Description
<p data-bbox="545 275 743 338">Application window move icon</p> 	<p data-bbox="781 275 1500 369">Place the cursor over the three-dot pattern in the upper left corner of the application window. When the cursor changes to a hand, drag the window to the desired location.</p>
<p data-bbox="545 611 688 642">Minimize icon</p> 	<p data-bbox="781 611 1110 642">Click to minimize the application.</p>
<p data-bbox="545 863 656 894">Close icon</p> 	<p data-bbox="781 863 1073 894">Click to close the application.</p>

**See also.** [Application panel overview](#)

**Options menu overview**

To access Options menu, click  in the upper-right corner of the application. It has the following:

**Options menu**

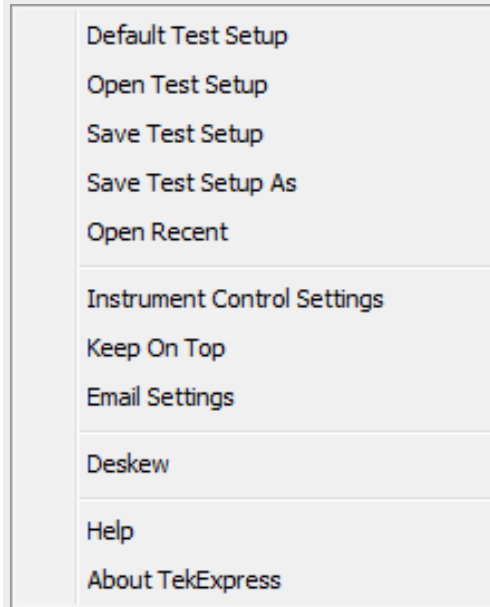

Menu	Function
Default Test Setup	Opens an untitled test setup with defaults selected Acquire Live Waveforms <b>Data Rate:</b> 10GBASE-T <b>Specification:</b> IEEE 802.3, Section 55 <b>Source:</b> Differential <b>Number of Lanes to Test:</b> 1 Lane
Open Test Setup	Opens a saved test setup
Save Test Setup	Saves the current test setup
Save Test Setup As	Saves the current test setup with a different file name or file type
Open Recent	Displays the recently opened test setups to open
<a href="#">Instrument Control Settings</a>	Detects, lists, and refreshes the connected instruments found on specified connections (LAN, GPIB, USB, and so on)
Keep On Top	Keeps the TekExpress Ethernet Tx application on top in the desktop
<a href="#">Email Settings</a>	Use to configure email options for test run and results notifications
Deskew	Allows the user to deskew the probes
Help	Displays the TekExpress Ethernet Tx help
<a href="#">About TekExpress</a>	<ul style="list-style-type: none"> <li>■ Displays application details such as software name, version number, and copyright</li> <li>■ Provides a link to the end-user license agreement</li> <li>■ Provides a link to the Tektronix Web site</li> </ul>

**See also.** [Application controls](#)

## TekExpress instrument control settings

Use TekExpress Instrument Control Settings dialog box to search the instruments (resources) connected to the application. You can use the Search Criteria to search the connected instruments depending on the connection type. The details of the connected instrument is displayed in the Retrieved Instruments window.

You can access this dialog box from the **Options** menu.

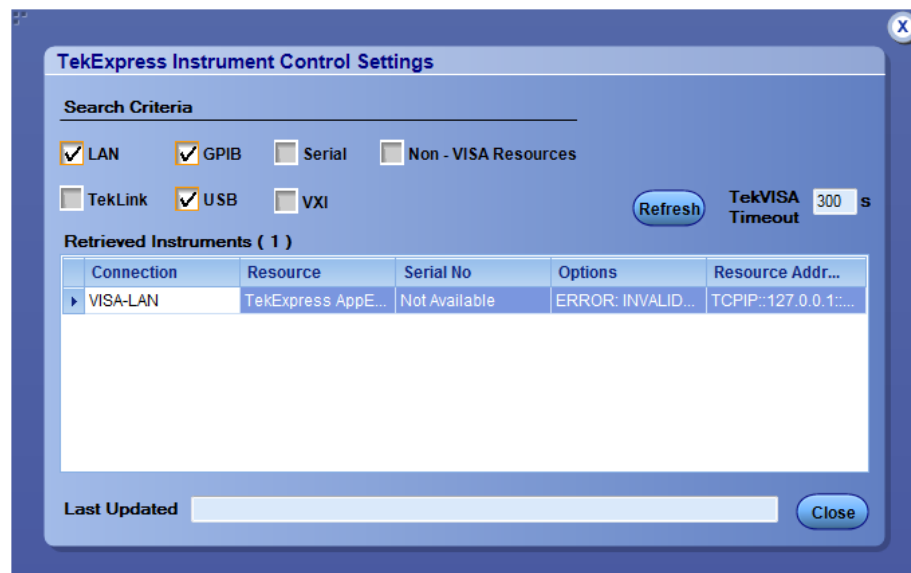

The connected instruments displayed here can be selected for use under Global Settings in the test configuration section.

---

**NOTE.** Under *Instrument Control Settings*, select *GPIB Option (Default setting)*, when using *TekExpress Ethernet Tx application*.

---

**See also.** [Options menu overview](#)

## View connected instruments

Use TekExpress Instrument Control Settings dialog box to search the instruments (resources) connected to the application. The application uses TekVISA to discover the connected instruments.

---

**NOTE.** *The correct instruments required for the test setup must be connected and recognized by the application before running the test.*

---

To refresh the list of connected instruments:

1. From the Options menu, select **Instrument Control Settings**.
2. In the **Search Criteria** section of the Instrument Control Settings dialog box, select the connection types of the instruments to search.

Instrument search is based on the VISA layer, but different connections determine the resource type, such as LAN, GPIB, and USB. For example, if you choose LAN, the search will include all the instruments supported by TekExpress that are communicating over the LAN.

3. Click **Refresh**. TekExpress searches for connected instruments.

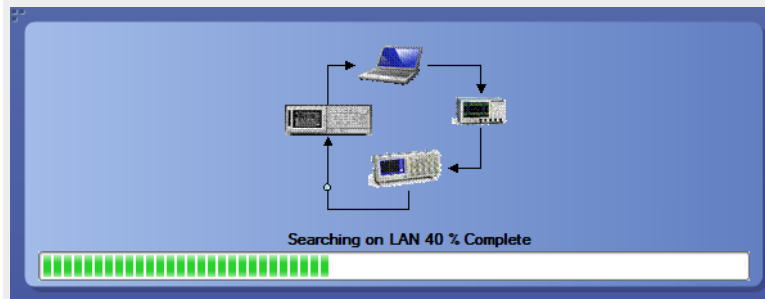

4. After searching, the dialog box lists the instrument-related details based on the search criteria. For example, For the Search Criteria as LAN and GPIB, the application displays all LAN and GPIB instruments connected to the application.

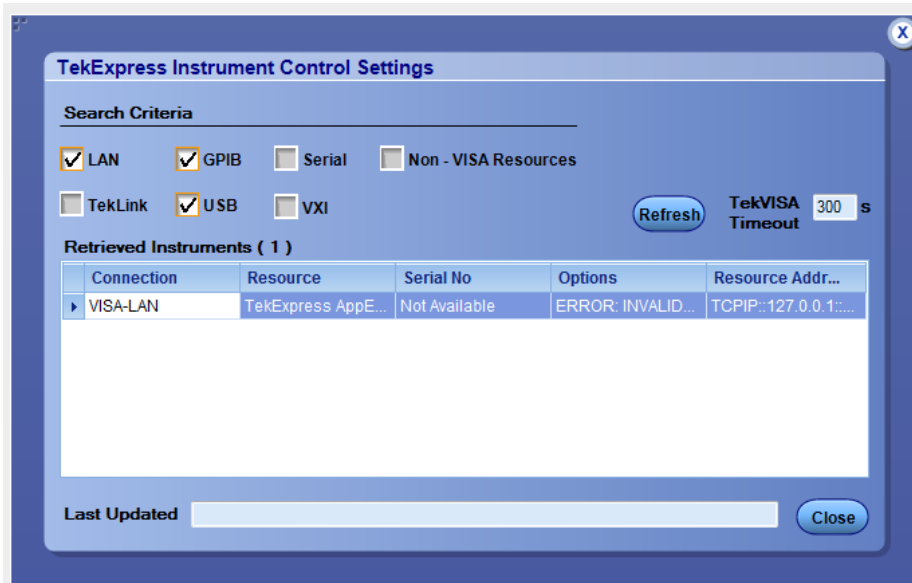

The details of the instruments are displayed in the Retrieved Instruments table. The time and date of instrument refresh is displayed in the Last Updated field.

## Configure email settings

Use the Email Settings utility to get notified by email when a measurement completes, or produces any error condition. Follow the steps to configure email settings:

1. Select **Options > Email Settings** to open the Email Settings dialog box.
2. (Required) For Recipient email Address(es), enter one or more recipient email addresses. To include multiple addresses, separate the addresses with commas.
3. (Required) For Sender's Address, enter the email address used by the instrument. This address consists of the instrument name, followed by an underscore, followed by the instrument serial number, then the @ symbol, and the email server ID. For example:  
DSA8300\_B130099@yourcompany.com.
4. (Required) In the Server Configuration section, type the SMTP Server address of the Mail server configured at the client location, and the SMTP Port number, in the corresponding fields.

If this server requires password authentication, enter a valid login name, password, and host name in the corresponding fields.

---

**NOTE.** *If any of the above required fields are left blank, the settings will not be saved and email notifications will not be sent.*

---

5. In the Email Attachments section, select from the following options:
  - **Reports:** Select to receive the test report with the notification email.
  - **Status Log:** Select to receive the test status log with the notification email. If you select this option, then also select whether you want to receive the full log or just the last 20 lines.
6. In the Email Configuration section:
  - Enter a maximum file size for the email message. Messages with attachments larger than this limit will not be sent. The default is 5 MB.
  - Enter the number in the Number of Attempts to Send field, to limit the number of attempts that the system makes to send a notification. The default is 1. You can also specify a timeout period.
7. Select the **Email Test Results When complete or on error** check box. Use this check box to quickly enable or disable email notifications.
8. To test your email settings, click **Test Email**.
9. To apply your settings, click **Apply**.
10. Click **Close** when finished.

## Email Settings

**Email Settings**

Recipient e-mail Address(es)   
*Note: Separate Email addresses with a comma*

Sender's Address

Email Attachments

Reports

Status Log    Last 20 Lines    Full Log

Server Configuration

SMTP Server  SMTP Port

Login

Password

Host Name

Email Configuration

Max Email Size (MB)    Number of Attempts to Send

Timeout (Sec)

Email Test Results When complete or on error

## Setup panel

### Setup panel overview

The Setup panel contains sequentially ordered tabs that help you guide through the test setup and execution process.

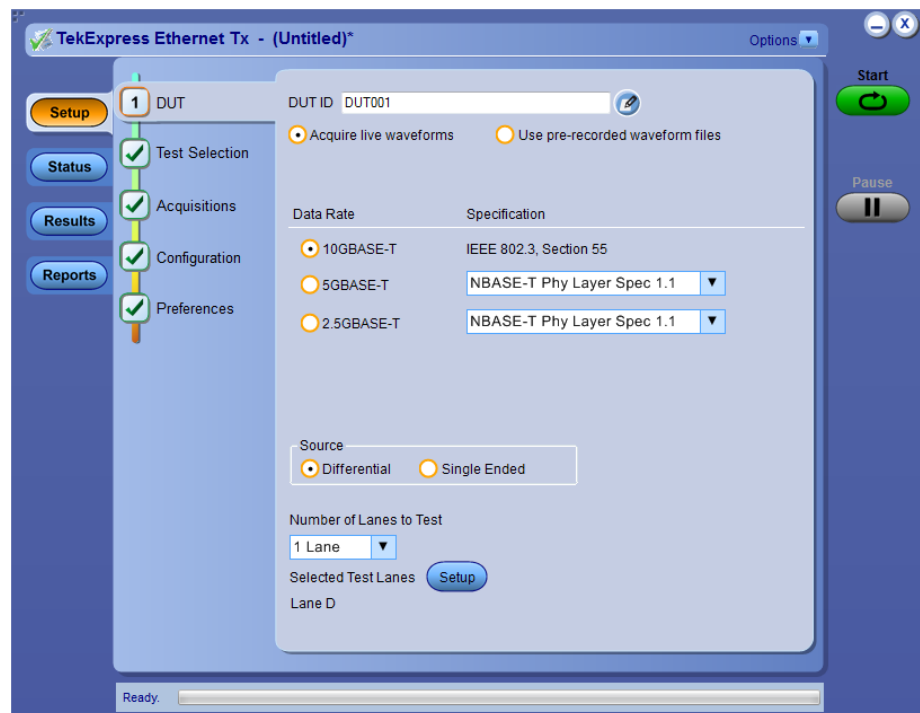

### Set DUT parameters

Use the DUT tab to select parameters for the device under test. These settings are global and apply to all tests for the current session. DUT settings also affect the list of available tests in the Test Selection tab.





Setting	Description
2.5GBASE-T	Specification <ul style="list-style-type: none"> <li>■ NBASE-T Phy Layer Spec 1.1</li> <li>■ IEEE P802.3bz, Section 126</li> </ul>
<b>Source</b>	
Differential	Select the source as Differential
Single Ended	Select the source as Single Ended
Number of Lanes to Test	Select the number of lanes to test.
Setup	Click to select the lanes to test.
Selected Test Lanes	Displays the selected lanes.

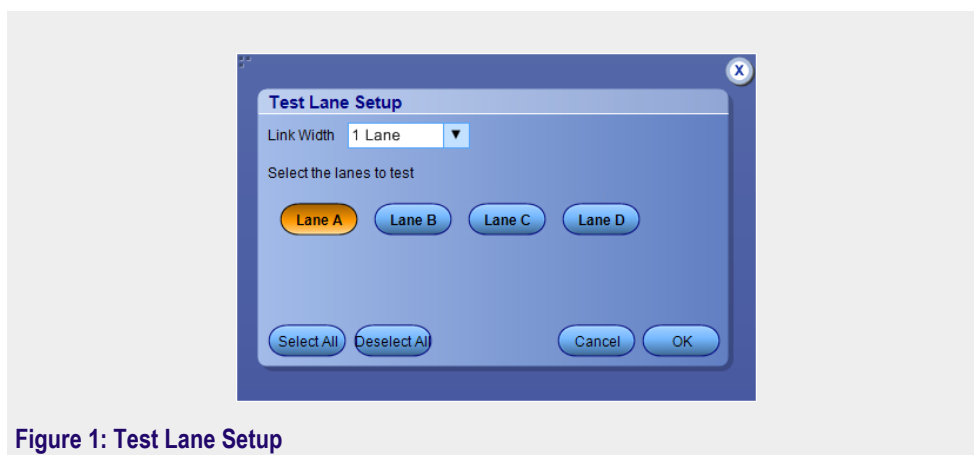
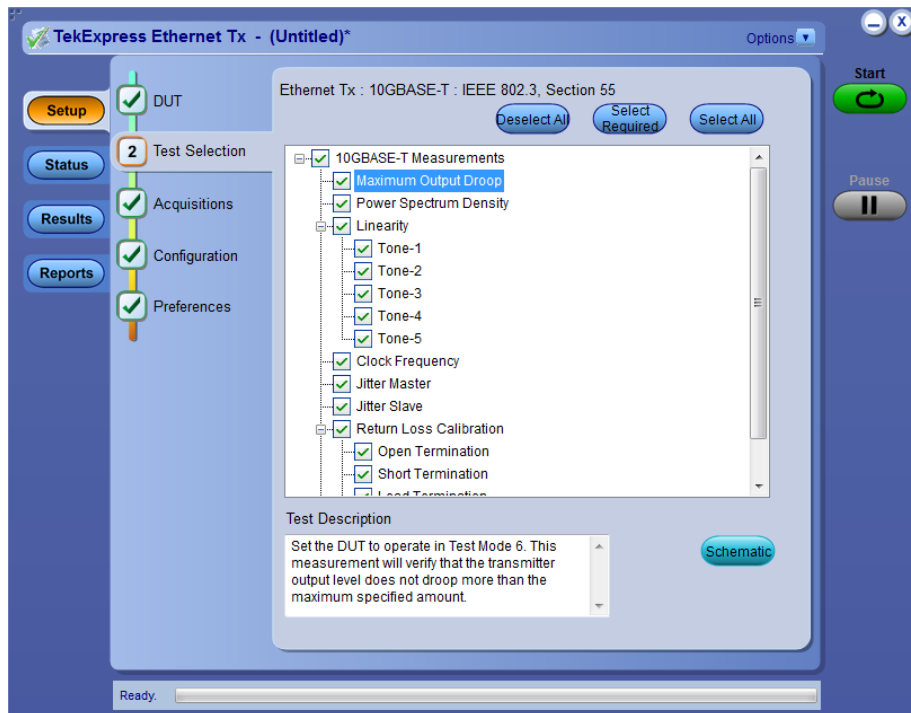

Figure 1: Test Lane Setup

See also. [Select a test](#)

**Select tests** Use the Test Selection tab to select the TekExpress Ethernet Tx tests.



**Table 8: Test Selection tab settings**

Setting	Description
Tests	Click on a test to select or unselect. Highlight a test to show details in the Test Description pane.
Test Description	Shows a brief description of the highlighted test in the Test field.

**See also.** [Set acquisition tab parameters](#)

**Set acquisition tab parameters**

Use the Acquisitions tab to view test acquisition parameters. The contents displayed on this tab depends on the DUT type and the tests selected.

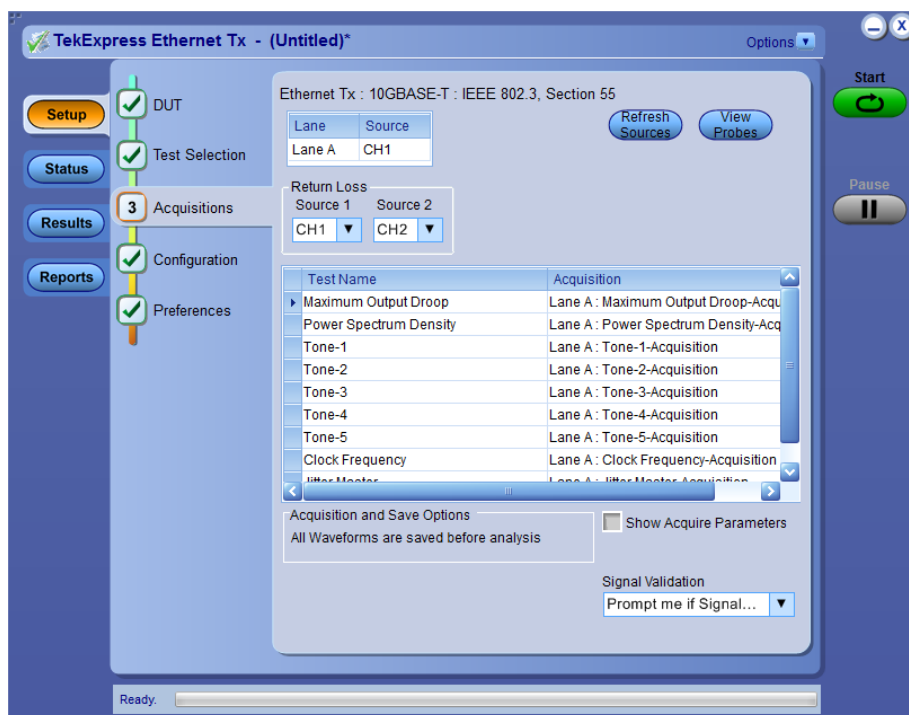
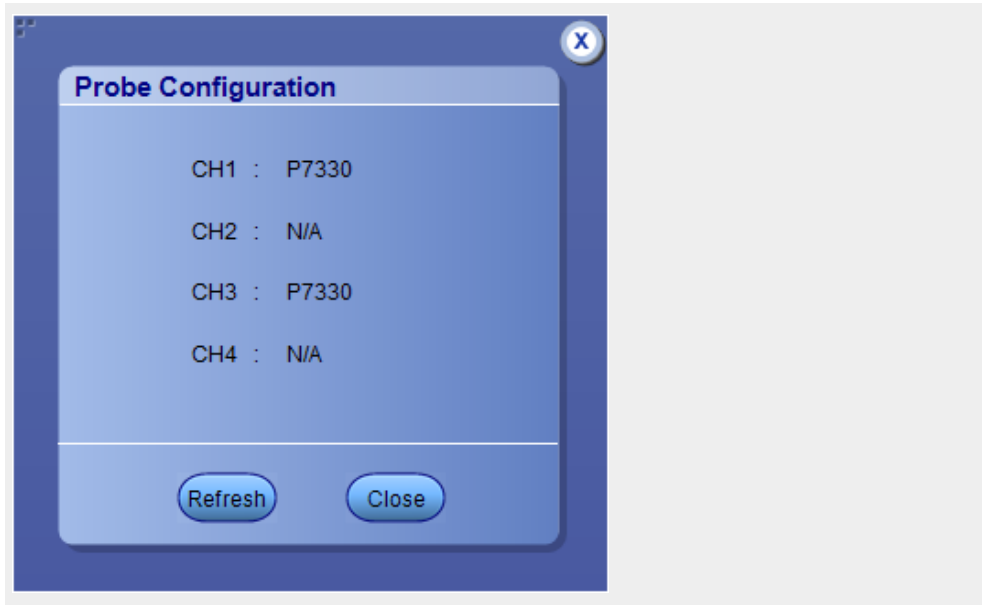

Table 9: Acquisitions tab settings

Setting	Description
View Probes	Click to view the probe configuration
Show Acquire Parameters	Select to view the acquisition parameters.
Signal Validation	Select the signal validation type <ul style="list-style-type: none"> <li>■ Prompt me if Signal Validation Fails</li> <li>■ Skip test if Signal Validation Fails</li> <li>■ Use signal as is - Don't Validate</li> </ul>



TekExpress Ethernet Tx saves all acquisition waveforms to files by default. Waveforms are saved in a unique folder for each session (a session starts when you click the Start button). The folder path is X:\Ethernet Tx\Untitled Session \<dutid>\<date>\_<time>. Images created for each analysis, CSV files with result values, reports, and other information specific to that particular execution are also saved in this folder.

Saving a session moves the session file contents from the Untitled Session folder to the specified folder name, and changes the session name to the specified name.

**Set configuration tab parameters**

Use the Configuration tab to view the instruments detected (Global Settings).

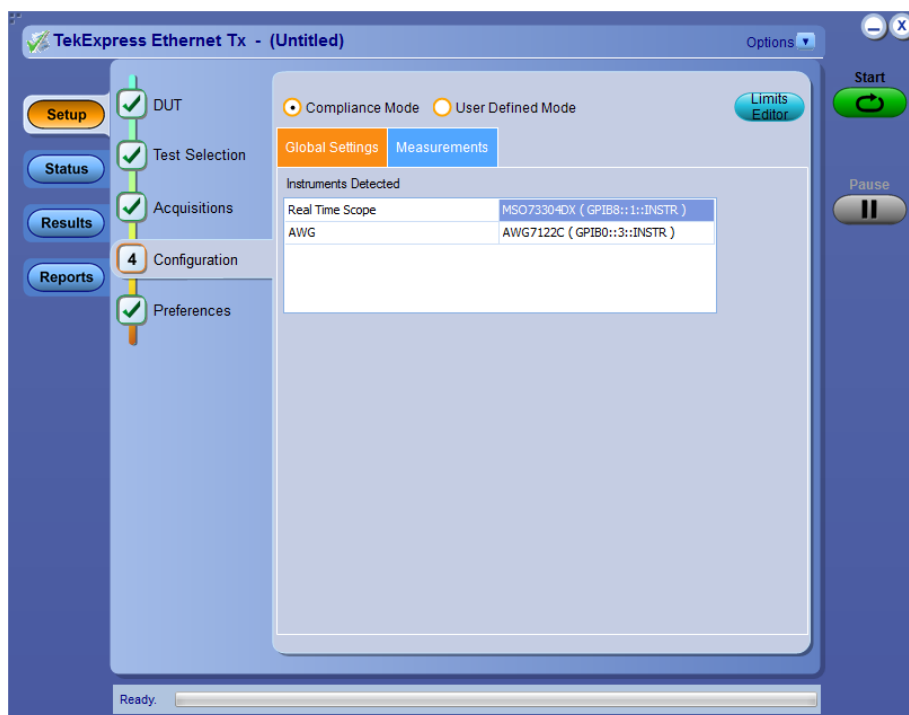

Figure 2: Configuration tab: Global Settings

Table 10: Configuration tab settings

Setting	Description
Compliance Mode	Select to view compliance mode. By default Compliance Mode is selected.
User Defined Mode	Select to view user defined mode
<b>Global Settings</b>	
Instruments Detected	Displays the instruments connected to this application. Click on the instrument name to open a list of available (detected) instruments. Select <b>Options &gt; Instrument Control Settings</b> and click Refresh to update the instrument list.  <b>NOTE.</b> Verify that the <b>GPIB</b> search criteria (default setting) in the Instrument Control Settings is selected when using TekExpress Ethernet Tx application.
<b>Measurements</b>	

Setting		Description
Maximum Output Droop	Acquire	Population
	Analyze	Ref Level Mid Level Hysteresis Start Time End Time
Power Spectrum Density	Acquire	Acquisition Average
	Analyze	Start Frequency Stop Frequency Resolution Bandwidth Power Level Start Frequency Power Level Stop Frequency Smoothing Average
Tone-1	Acquire	Acquisition Average
	Analyze	Start Frequency Stop Frequency Resolution Bandwidth
Tone-2	Acquire	Acquisition Average
	Analyze	Start Frequency Stop Frequency Resolution Bandwidth
Tone-3	Acquire	Acquisition Average
	Analyze	Start Frequency Stop Frequency Resolution Bandwidth
Tone-4	Acquire	Acquisition Average
	Analyze	Start Frequency Stop Frequency Resolution Bandwidth
Tone-5	Acquire	Acquisition Average
	Analyze	Start Frequency Stop Frequency Resolution Bandwidth
Clock Frequency	Acquire	Population
	Analyze	Ref Level Mid Level Hysteresis
Jitter Master	Acquire	Acquisition Duration
	Analyze	Ref Level Mid Level Hysteresis
Jitter Slave	Acquire	Acquisition Duration
	Analyze	Ref Level Mid Level Hysteresis

Setting		Description
Open Termination	Acquire	Acquisition Average
	Analyze	Smoothing Average Calibration files path
Short Termination	Acquire	Acquisition Average
	Analyze	Smoothing Average Calibration files path
Load Termination	Acquire	Acquisition Average
	Analyze	Smoothing Average Calibration files path
Return Loss	Acquire	Acquisition Average
	Analyze	Smoothing Average Calibration files path

**Population.** Specifies a limit to the amount of waveform data that is analyzed

**Ref Level. Absolute** Use to manually set the reference levels.

**Percentage** Use to set the reference levels as a percentage.

**Mid Level.** A reference voltage level that defines when the waveform state transition occurs at a given threshold.

**Hysteresis.** Used to prevent small amounts of noise in a waveform from producing multiple threshold crossings. Use when the rising and falling thresholds for a given reference voltage level are set to the same value.

**Start Time.** Specifies the Droop measurement start time (Time from the zero crossing).

**End Time.** Specifies the Droop measurement end time (Time from the zero crossing).

**Acquisition Average.** Specifies the number of waveforms over which averaging is done.

**Start Frequency.** Specifies the PSD curve start frequency.

**Stop Frequency.** Specifies the PSD curve stop frequency.

**Resolution Bandwidth.** Determines the smallest frequency difference that can be resolved in the frequency domain output data.

**Power Level Start Frequency.** Specifies the power level start frequency.

**Power Level Stop Frequency.** Specifies the power level stop frequency.

**Smoothing Average.** Specifies the window size in terms of number of samples used for smoothing.

**Acquisition Duration.** Specifies the waveform acquired time.

**Set preferences tab parameters**

Use the Preferences tab to set the application action on completion of a measurement.

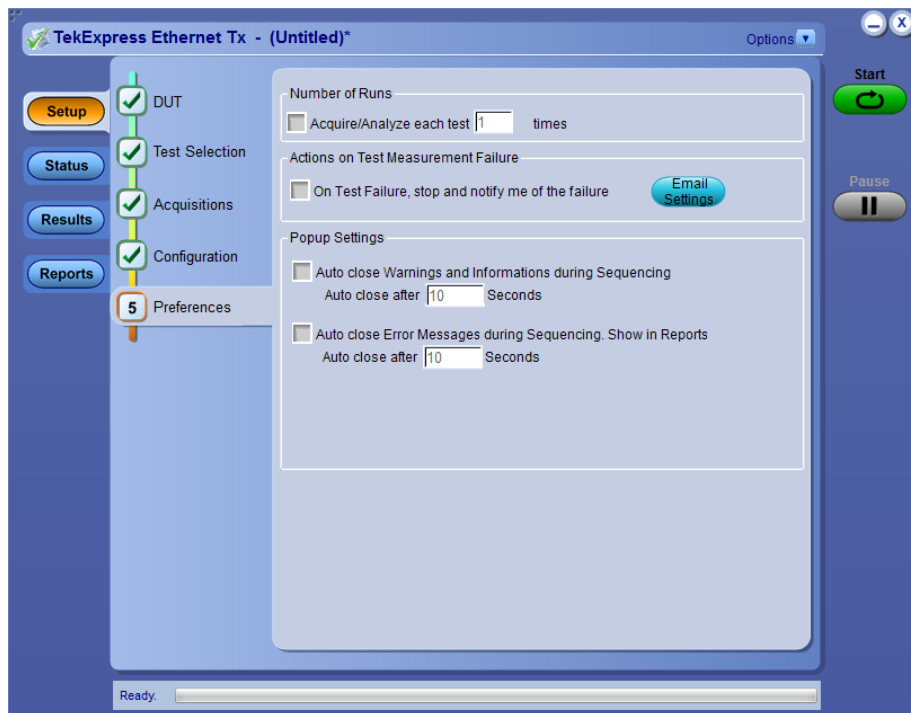

**Table 11: Preferences tab settings**

Setting	Description
<b>Number of Runs</b>	
Acquire/Analyze each test <no> times (not applicable to Custom Tests)	Select to repeat the test run by setting the number of times. By default, it is selected with 1 run.
<b>Actions on Test Measurement Failure</b>	
On Test Failure, stop and notify me of the failure	Select to stop the test run on Test Failure, and to get notified via email. By default, it is unselected. Click Email Settings to configure.
<b>Popup Settings</b>	



Setting	Description
Auto close Warnings and Informations during Sequencing Auto close after <no> Seconds	Select to auto close warnings/informations during sequencing. Set the Auto close time. By default it is unselected.
Auto close Error Messages during Sequencing. Show in Reports Auto close after <no> Seconds	Select to auto close Error Messages during Sequencing. Set the Auto close time. By default it is unselected.

## Status panel overview

The Status button accesses the Test Status and Log View tabs, which provide status on test acquisition and analysis (Test Status tab) and a listing of test tasks performed (Log View tab). The application opens the Test Status tab when you start a test run. You can select the Test Status or the Log View tab to view these items while tests are running.

### Test status view

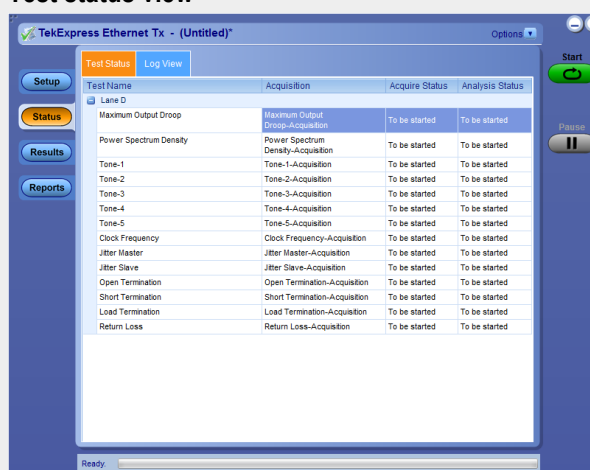

### Log view

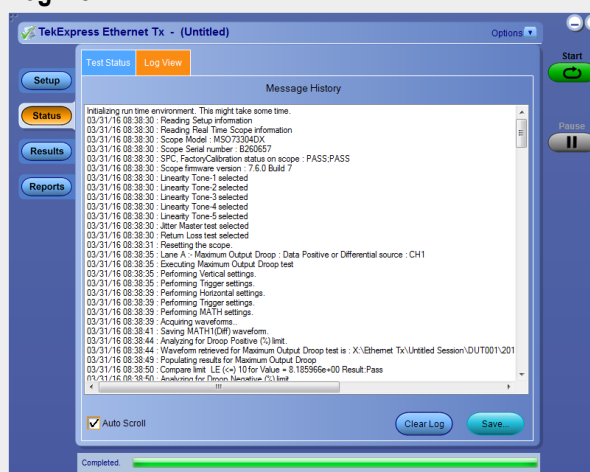

**Table 12: Status panel Log View controls**

Control	Description
Message History	Lists all executed test operations and timestamp information.
Auto Scroll	Enables automatic scrolling of the log view as information is added to the log during the test.
Clear Log	Clears all messages from the log view.
Save	Saves the log file to a text file. Use the standard Save File window to navigate to and specify the folder and file name to which to save the log text.

See also [Application panel overview](#)

## Results panel

**Results panel overview** When a test finishes, the application automatically opens the **Results** panel to display a summary of test results.

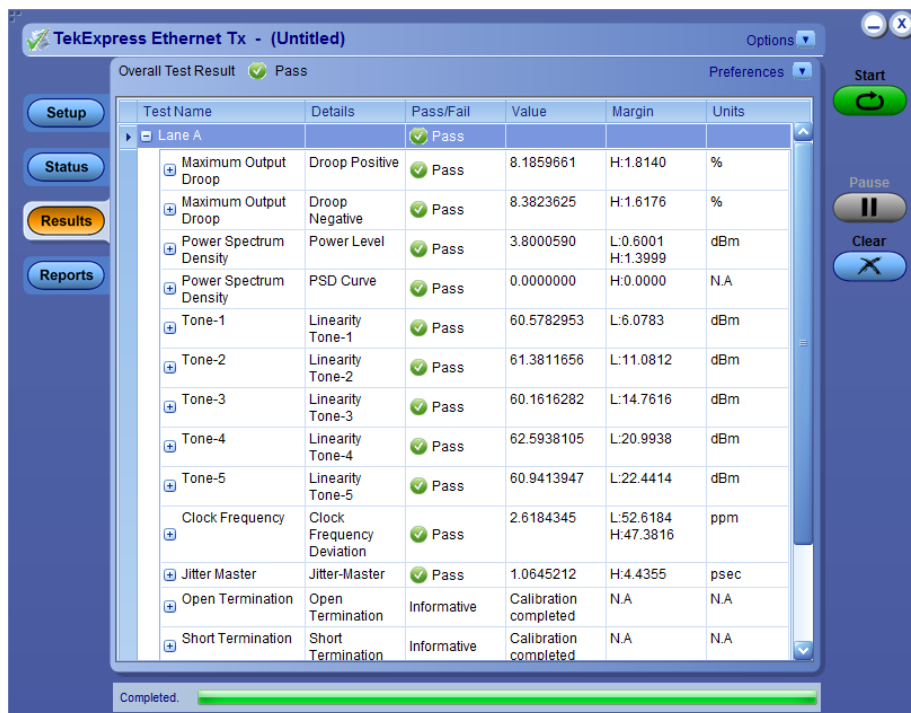

**See also.** [View a report](#)

[Application panels overview](#)

### View test-related files

Files related to tests are stored in My TekExpress\Ethernet Tx\ . Each test setup in this folder has both a test setup *file* and a test setup *folder*, both with the test setup name.

The test setup file is preceded by the TekExpress icon and usually has no visible file name extension.

Inside the test setup folder is another folder named for the DUT ID used in the test sessions. The default is DUT001.

Inside the DUT001 folder are the session folders and files. Each session also has a folder and file pair, both named for the test session using the naming convention (date)\_(time). Each session file is stored outside its matching session folder:

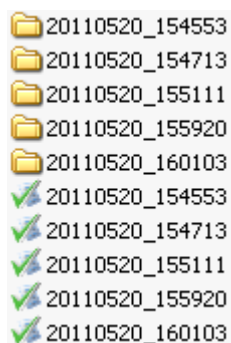

Each session folder contains image files of any plots generated from running the test session. If you selected to save all waveforms or ran tests using prerecorded waveform files, these are included here.

The first time you run a new, unsaved session, the session files are stored in the Untitled Session folder located at ..\My TekExpress\Ethernet Tx\. When you name and save the session, the files are placed in a folder with the name that you specify. A copy of the test files stay in the Untitled Session folder until you run a new test or until you close the Ethernet Tx application.

**See also.** [File name extensions](#)

## Reports panel

**Reports panel overview** Use the Reports panel to browse for reports, name and save reports, select test content to include in reports, and select report viewing options.

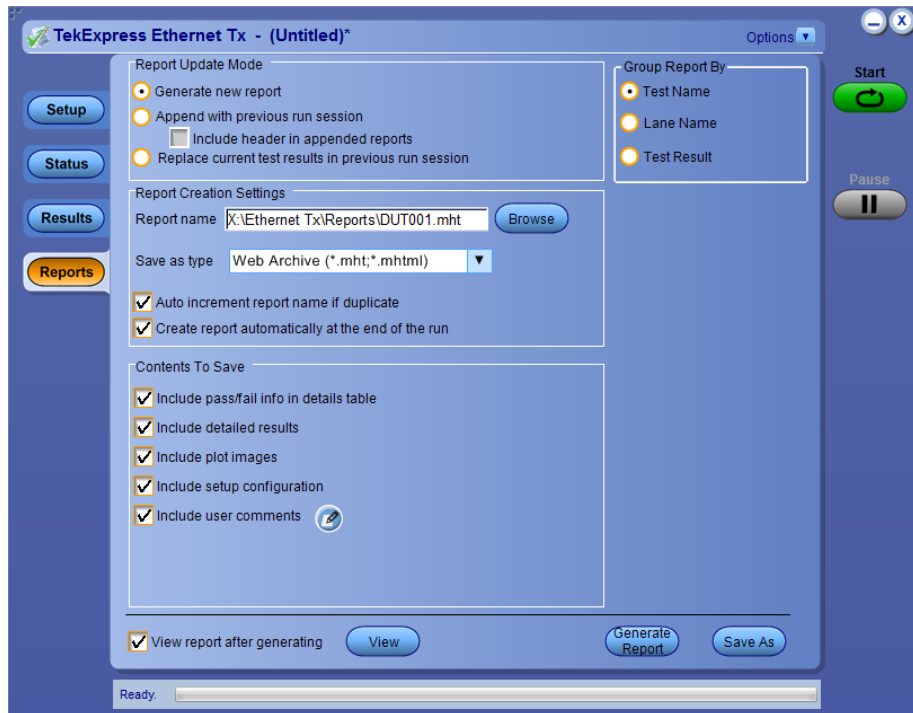

For information on setting up reports, see [Select report options](#). For information on viewing reports, see [View a report](#).

**See also.** [Applications panel overview](#)

**Select report options** Click the **Reports** button and use the Reports panel controls to select which test result information to include in the report, and the naming conventions to use for the report. For example, always give the report a unique name or select to have the same name increment each time you run a particular test.

Select report options before running a test or when creating and saving test setups. Report settings are included in saved test setups.

In the Reports panel, select from the following report options:

**Table 13: Report options**

Setting	Description
<b>Report Update Mode</b>	
Generate new report	Creates a new report. The report can be in either .mht or .pdf file formats.
Append with previous run session	Appends the latest test results to the end of the current test results report.
Replace current test in previous run session	Replaces the previous test results with the latest test results. Results from newly added tests are appended to the end of the report.
<b>Report Creation Settings</b>	
Report name	<p>Displays the name and location from which to open a Ethernet Tx report. The default location is at <i>My TekExpress\Ethernet Tx\Untitled Session</i>. The report file in this folder gets overwritten each time you run a test unless you specify a unique name or select to auto increment the report name.</p> <p>Change the report name or location.</p> <p>Do one of the following:</p> <ul style="list-style-type: none"> <li>■ In the Report Path field, type over the current folder path and name.</li> <li>■ Double-click in the Report Path field and then make selections from the popup keyboard and click the <b>Enter</b> button.</li> </ul> <p>Be sure to include the entire folder path, the file name, and the file extension. For example: C:\Documents and Settings\your user name\My Documents\My TekExpress\Ethernet Tx\DUT001.mht.</p> <p><b>NOTE.</b> You cannot set the file location using the <i>Browse</i> button.</p> <p>Open an existing report.</p> <p>Click <b>Browse</b>, locate and select the report file and then click <b>View</b> at the bottom of the panel.</p>

Setting	Description
Save as type	Saves a report in the specified file type, selected from the drop-down list.  <b>NOTE.</b> If you select a file type different from the default, be sure to change the report file name extension in the Report Name field to match.
Auto increment report name if duplicate	Sets the application to automatically increment the name of the report file if the application finds a file with the same name as the one being generated. For example: DUT001, DUT002, DUT003. This option is enabled by default.
Create report automatically at the end of the run	Creates report at the end of the run.
<b>Contents To Save</b>	
Include pass/fail info in details table	Includes pass/fail info in the details table of the report.
Include detailed results	Includes detailed results in the report.
Include plot images	Includes plot images in the report.
Include setup configuration	Sets the application to include hardware and software information in the summary box at the top of the report. Information includes: the oscilloscope model and serial number, the oscilloscope firmware version, and software versions for applications used in the measurements.
Include complete application configuration	Includes complete application configuration in the report.
Include user comments	Select to include any comments about the test that you or another user added in the DUT tab of the Setup panel. Comments appear in the Comments section, under the summary box at the beginning of each report.
<b>Group Report By</b>	
Test Name	Select to group the tests in the report by test name.
Test Result	Select to group the tests in the report by test results
View report after generating	Automatically opens the report in a Web browser when the test completes. This option is selected by default.
View	Click to view the most current report.
Generate Report	Generates a new report based on the current analysis results.
Save As	Specify a name for the report.

**View a report** The application automatically generates a report when test analysis is completed and displays the report in your default Web browser (unless you cleared the **View Report After Generating** check box in the Reports panel before running the test). If you cleared this check box, or to view a different test report, do the following:

1. Click the **Reports** button.
2. Click the **Browse** button and locate and select the report file to view.
3. In the Reports panel, click **View**.

For information on changing the file type, file name, and other report options, see [Select report options](#).

**Report contents** A report shows detailed results and plots, as set in the Reports panel.

 <b>TekExpress Ethernet Tx</b> 10GBASE-T Test Report			
<b>Setup Information</b>			
DUT ID	DUT001	Scope Information	MSO73304DX, B260657
Date/Time	2016-03-31 08:38:30	SPC, FactoryCalibration	PASS:PASS
Device Type	Ethernet Tx	Scope F/W Version	7.6.0 Build 7
TekExpress Ethernet Tx Version	1.0.0.143	Channel1 Probe	P7330, B025431
TekExpress Framework Version	4.0.6.266	Return-Loss Probe1	P7330, B025431
Execution Mode	Live	Return-Loss Probe2	P7330, B025531
Probing Type	Differential		
Compliance Mode	True		
Overall Test Result	Pass		
Overall Execution Time	0:11:51		
DUT COMMENT:	General comment		
<b>Test Name Summary Table</b>			
<a href="#">Maximum Output Droop</a>			Pass
<a href="#">Power Spectrum Density</a>			Pass
<a href="#">Tone-1</a>			Pass
<a href="#">Tone-2</a>			Pass
<a href="#">Tone-3</a>			Pass
<a href="#">Tone-4</a>			Pass
<a href="#">Tone-5</a>			Pass
<a href="#">Clock Frequency</a>			Pass
<a href="#">Jitter Master</a>			Pass
<a href="#">Open Termination</a>			Pass
<a href="#">Short Termination</a>			Pass
<a href="#">Load Termination</a>			Pass
<a href="#">Return Loss</a>			Pass

### Setup configuration information

The summary box at the beginning of the report lists setup configuration information. This information includes the oscilloscope model and serial number, optical module model and serial number, and software version numbers of all associated applications.

To exclude this information from a report, clear the **Include Setup Configuration** check box in the Reports panel before running the test.

### User comments

If you selected to include comments in the test report, any comments you added in the DUT tab are shown at the top of the report.

**See also.** [Results panel overview](#)

[View test-related files](#)



---

# Running tests

## Equipment setup

Click **Setup** > **Test Selection** > **Schematic** to view the equipment setup diagram(s).

### Equipment connection setup - Differential Source (SMA Probe)

This section describes the equipment connection setup to perform Differential Source (SMA Probe) Calibration. (For details, see [Minimum system requirements](#)).

Equipment connection setup - Differential Source (SMA Probe) applies to all tests except Jitter-Slave and Return Loss.

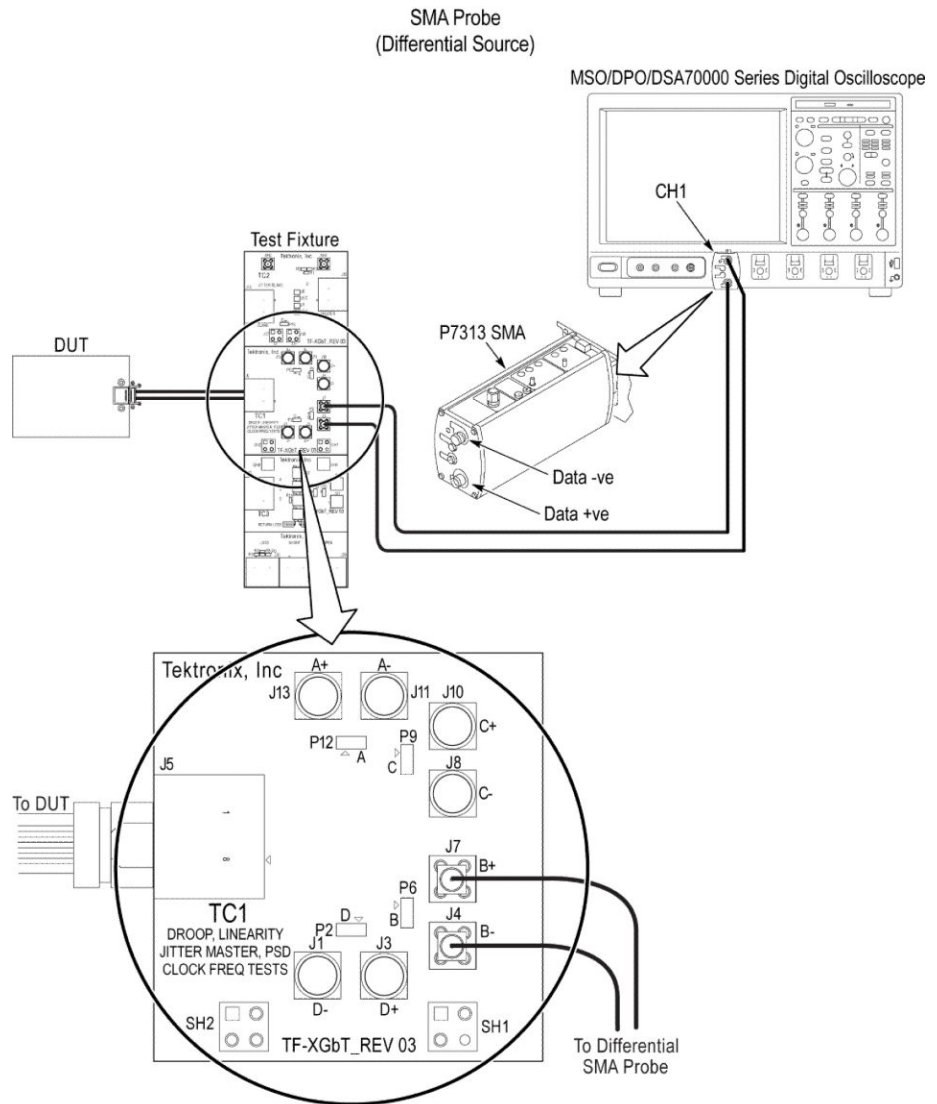

Note: When using high input impedance differential probe, ensure that each of the single ended lanes is terminated with 50 Ω.

1253-008

**Equipment connection setup - Single-Ended Source (SMA Cable)**

This section describes the equipments required and the connection setup to perform Single-Ended Source Calibration. (For details, see [Minimum system requirements](#)).

Equipment connection setup - Single-Ended Source (SMA Cable) applies to all tests except Jitter-Slave and Return Loss.

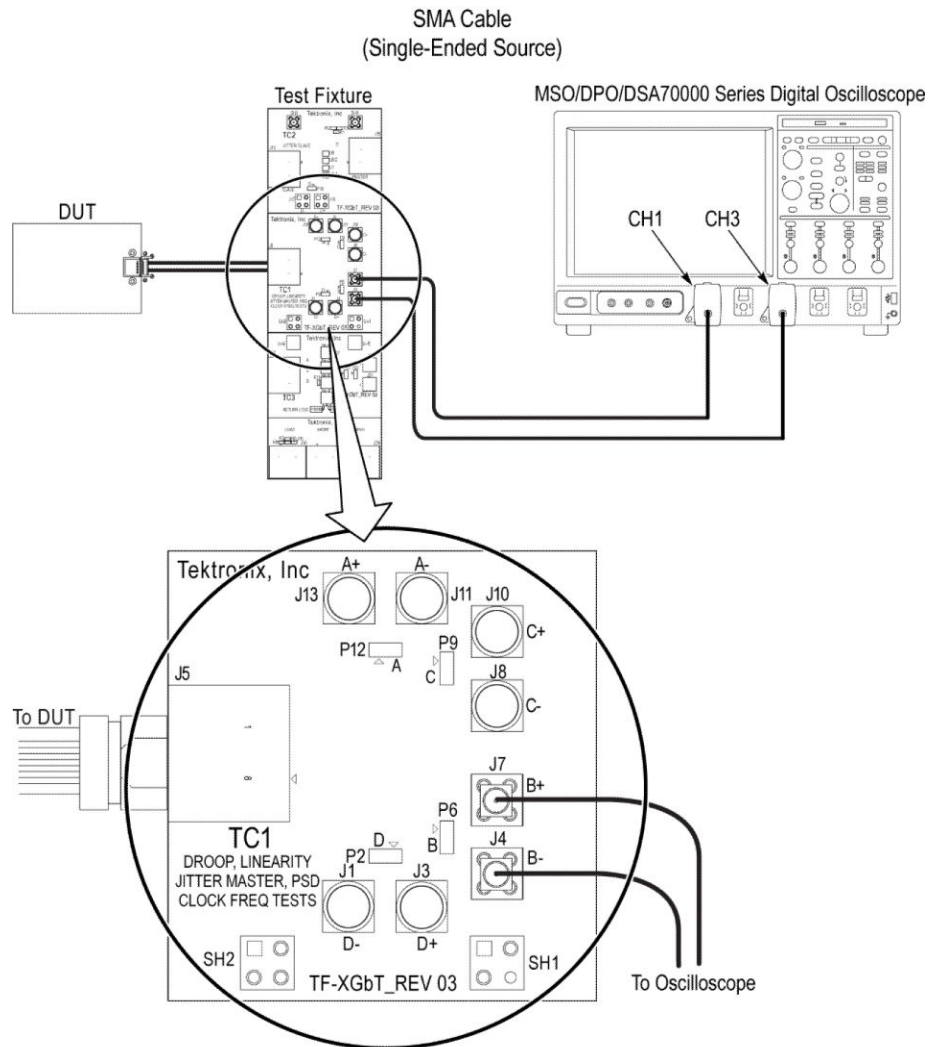

Note: When using high input impedance differential probe, ensure that each of the single ended lanes is terminated with 50 Ω.

1253-009

**Equipment connection setup - Jitter-Slave SMA Probe (Differential Source)**

This section describes the equipments required and the connection setup to perform Jitter-Slave (Differential Source) Calibration. (For details, see [Minimum system requirements](#)).

Equipment connection setup - Jitter-Slave SMA Probe (Differential Source) applies to Jitter-Slave measurement.

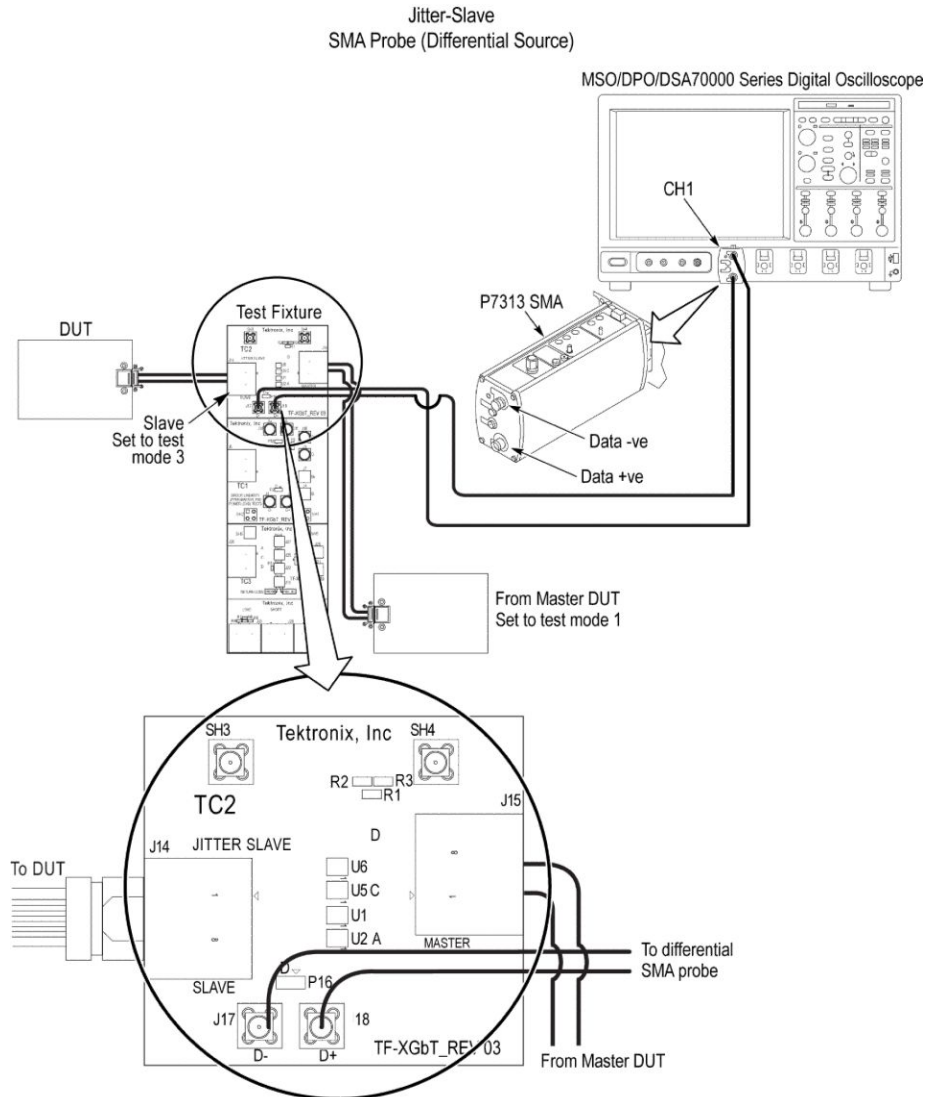

Note: When using high input impedance differential probe, ensure that each of the single ended lanes is terminated with 50 Ω.

1253-010

**Equipment connection setup - Jitter-Slave SMA Cable (Single-Ended Source)**

This section describes the equipments required and the connection setup to perform Jitter-Slave (Single-Ended Source) calibration. (For details, see [Minimum system requirements](#)).

Equipment connection setup - Jitter-Slave SMA Probe (Single-Ended Source) applies to Jitter-Slave measurement.

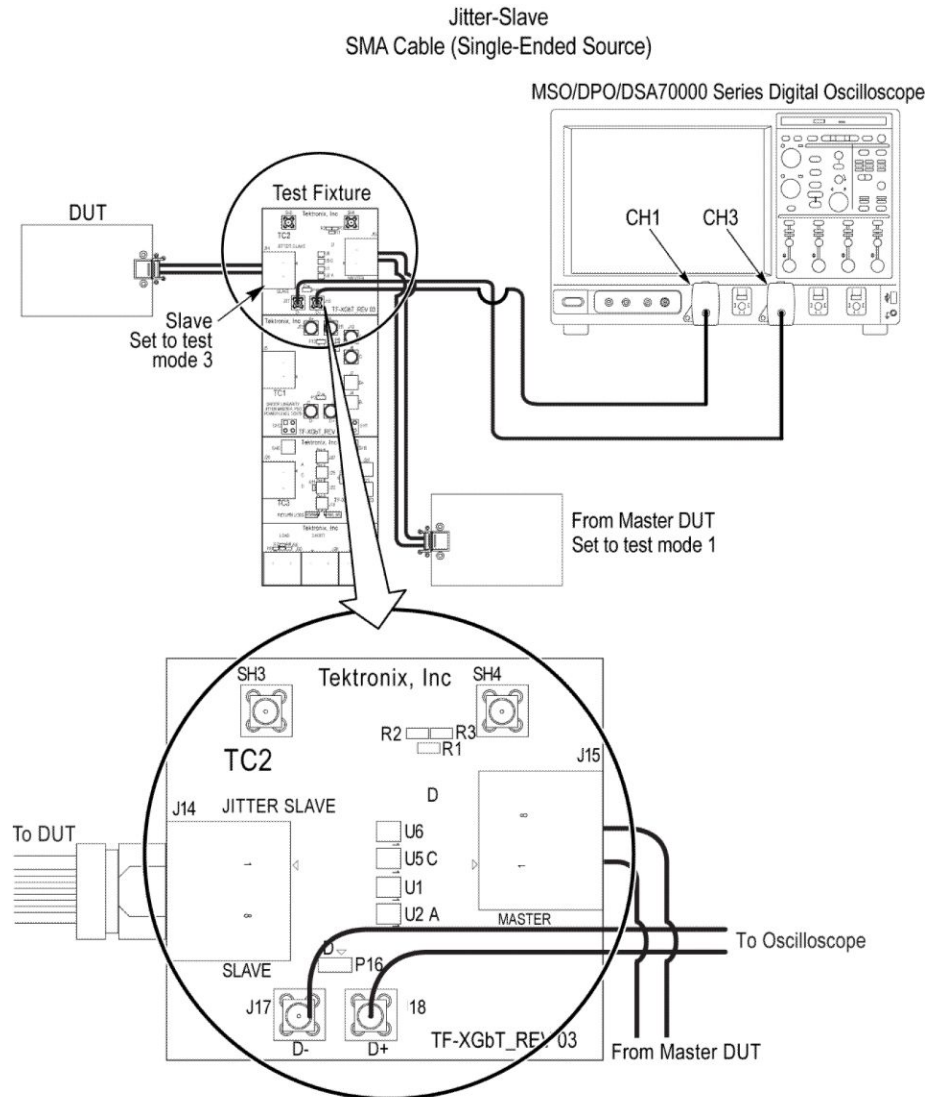

Note: When using high input impedance differential probe, ensure that each of the single ended lanes is terminated with 50 Ω.

1253-011

**Equipment connection setup - Return Loss Calibration**

This section describes the equipments required and the connection setup to perform Return Loss Calibration. (For details, see [Minimum system requirements](#)).

Equipment connection setup - Return Loss Calibration applies to Open Termination, Short Termination and Load Termination measurement.

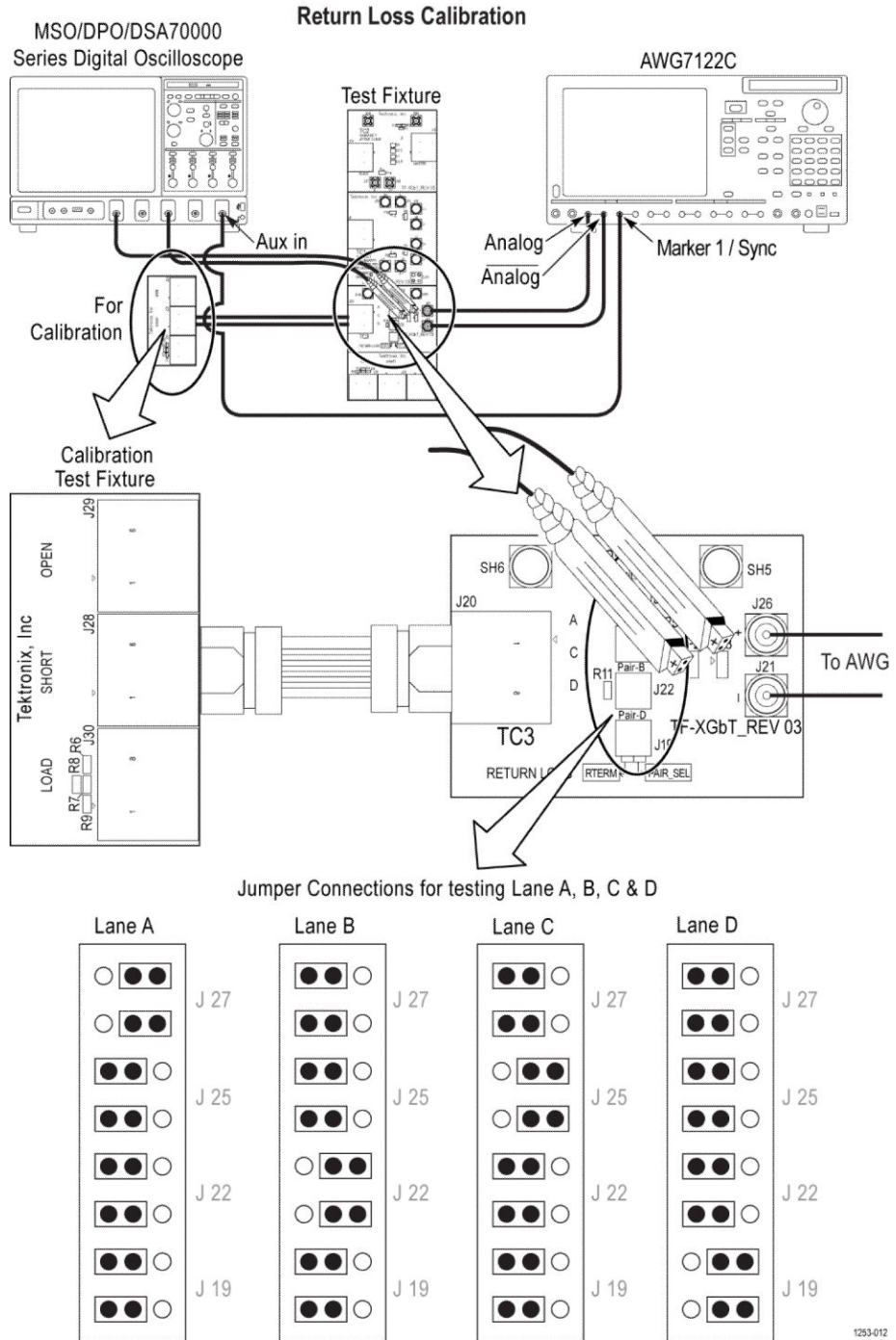

**Figure 3: Open Termination**

1293-012

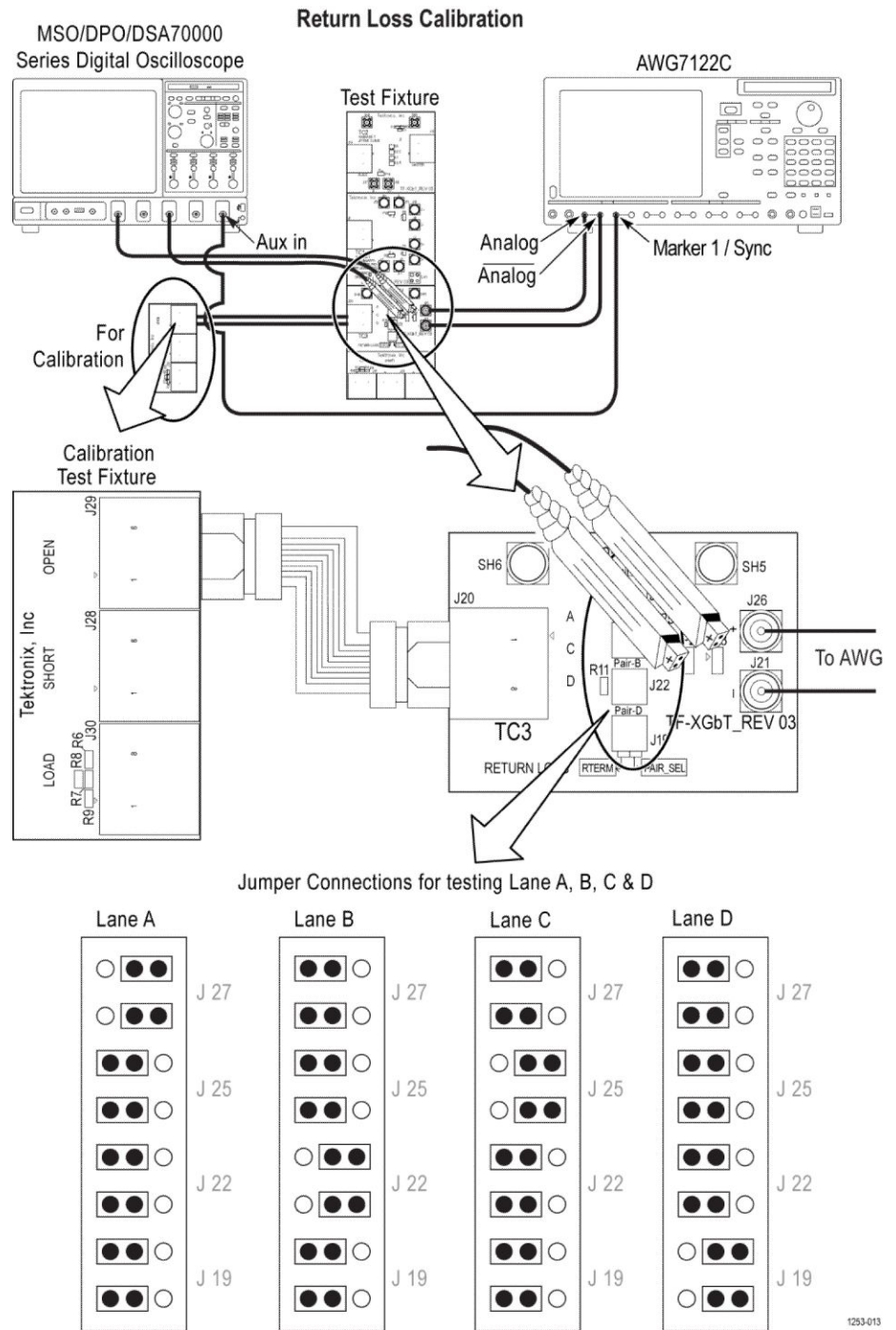

Figure 4: Short Termination

1293-013



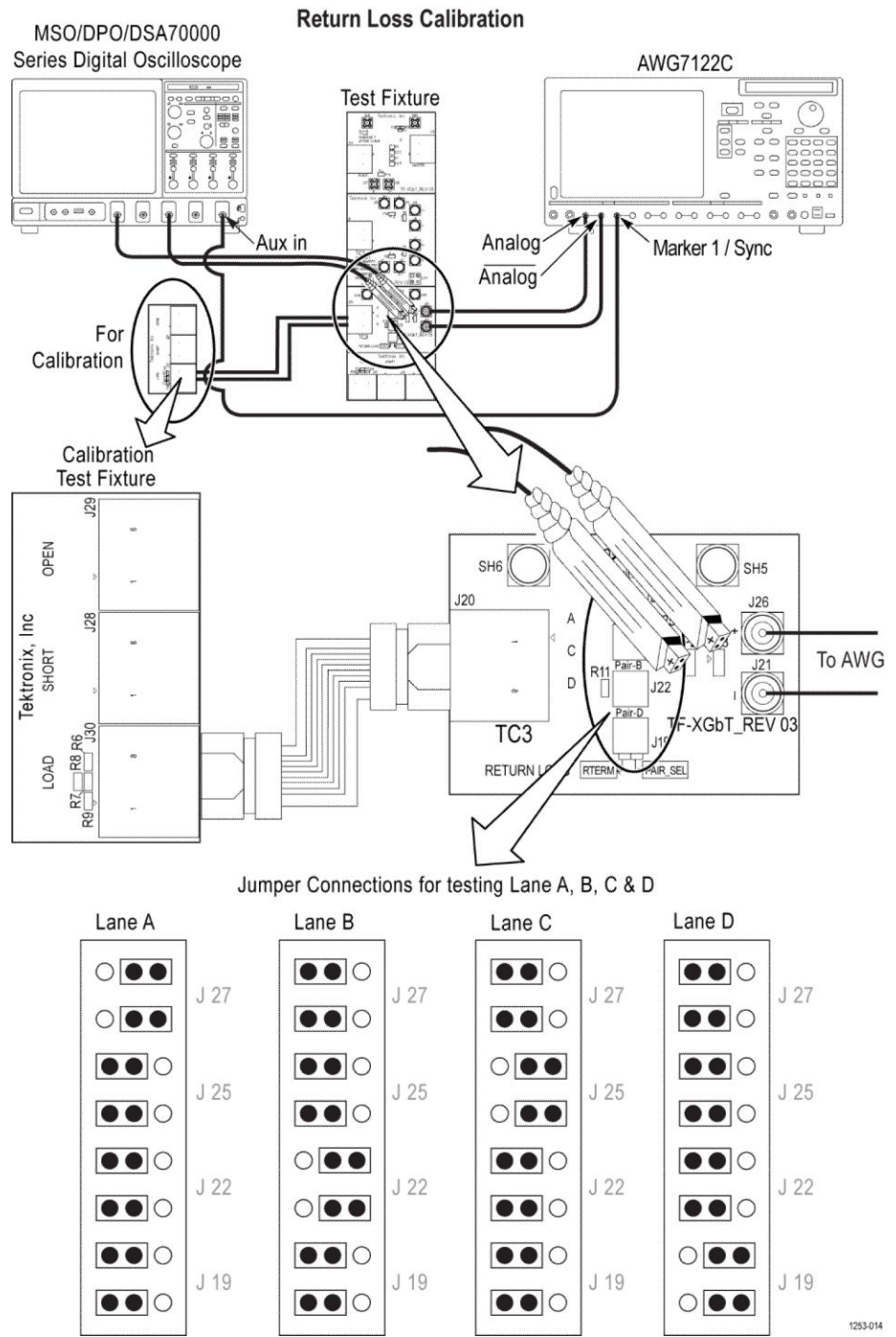

Figure 5: Load Termination



**Equipment connection setup - Return Loss Setup**

This section describes the equipments required and the connection setup to perform Return Loss Setup. (For details, see [Minimum system requirements](#)).

Equipment connection setup - Return Loss Setup applies to Return Loss measurement

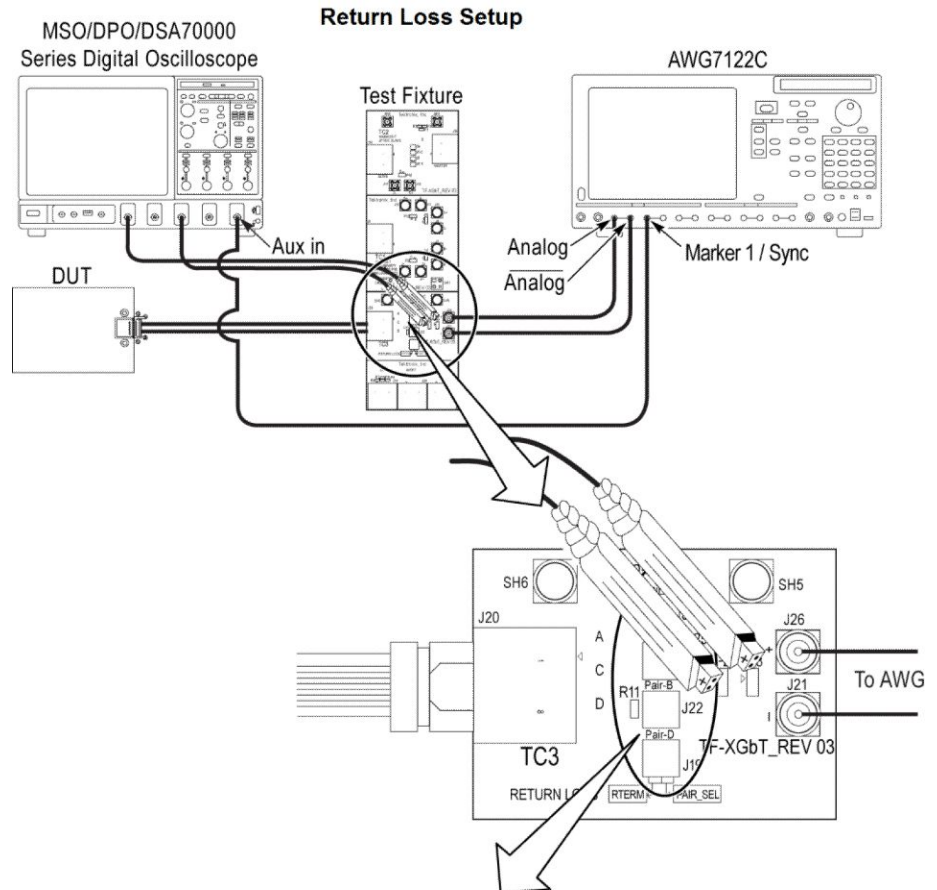

Jumper Connections for testing Lane A, B, C & D

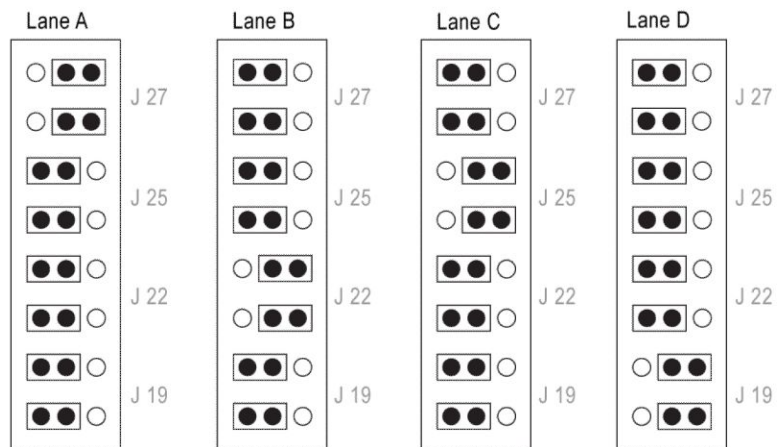

1253-015

## Prerequisite

### Compensate the signal path

Use the following procedure to compensate the internal signal acquisition path. Perform this procedure if the ambient temperature has changed more than 5 °C (9 °F) since you performed the last signal path compensation. Perform the signal path compensation once a week. Failure to do so may result in the instrument not meeting warranted performance levels.

1. Power on and wait for the instrument to complete its warm up period before continuing with this procedure.
2. Disconnect any probes you have connected to the input channels.
3. Set the instrument to Menu mode.
4. Select Instrument Calibration from the Utilities menu.
5. Note any instructions that appear in the resulting control window.
6. Click Run SPC to begin the procedure. The procedure may take several minutes to complete.
7. Verify that the Status changes to Compensated after the procedure is complete. If the Calibration Status field indicates anything other than Compensated, see Signal Path Compensation Status for information on the readout and recommended action.

---

**NOTE.** *When making measurements at vertical scale settings less than or equal to 5 mV, you should perform the signal path compensation at least once a week. Failure to do so may result in the instrument not meeting warranted performance levels at those volts/div settings.*

---

### Deskew

If skew is present between positive and negative channels, then the channels need to be deskewed before being used for waveform measurements. TekExpress Ethernet Tx provides support for channel deskew using the following method:

1. Determine what the skew is for each channel.
2. From the TekScope menu, select Vertical > Deskew.
3. In the Deskew/Attenuation window, click the channel (1 – 4) button for the first channel to be deskewed.
4. Click in the Ch(x) Deskew Time entry field and enter the skew. The skew can be +ve or –ve.
5. Click the channel button for the next channel and repeat step 4.
6. After entering the skew for all the channels that require it, from the Options menu in TekExpress Ethernet Tx, select Deskew.

7. In the Deskew dialog box, select the desired level:
  - Less than 100 mV signal amplitude: Select this if the signal amplitude is such that the oscilloscope's vertical setting is less than 100 mV/division.
  - 100 mV or greater signal amplitude: Select this if the signal amplitude is such that the oscilloscope's vertical setting is greater than 100 mV/division.

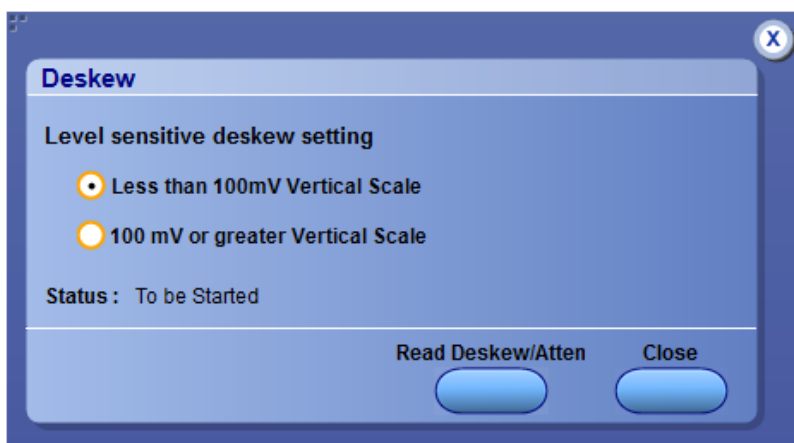

**Figure 6: Deskew**

8. Click Read Deskew/Attn.
9. When the status in the dialog box indicates the deskew is finished, click Close.

Each input channel has its own deskew settings. Deskew compensates individual channels for probes or cables of different lengths. The instrument applies the delay values after each completed acquisition. The deskew values are saved as part of the instrument setup. The deskew values for the selected channel are retained until you change the probe, you restore a saved setup, or you recall the factory setup.

## Running tests

*Select tests, set acquisition parameters, set configuration parameters, set preferences parameters*, and click **Start** to run the tests. While tests are running, you cannot access the Setup or Reports panels. To monitor the test progress, switch between the Status panel and the Results panel.

While the tests are running, other applications may display windows in the background. The TekScope application takes precedence over other applications, but you can switch to other applications by using **Alt + Tab** key combination. To keep the TekExpress Ethernet Tx application on top, select **Keep On Top** from the TekExpress Options menu.

The application displays report when the tests execution is complete.

- Prerun checklist**
1. Make sure that the instruments are warmed up (approximately 20 minutes) and stabilized.
  2. Perform compensation: In the oscilloscope main menu, select **Utilities > Instrument Compensation**. Click **Help** in the compensation window for steps to perform instrument compensation.

---

# Saving and recalling test setup

## Test setup files overview

Saved test setup information (such as the selected oscilloscope, general parameters, acquisition parameters, measurement limits, waveforms (if applicable), and other configuration settings) is saved under the setup name at **X:\Ethernet Tx**.

Use test setups to:

- Run a new session, acquiring live waveforms, using a saved test configuration.
- Create a new test setup based on an existing one.
- View all the information associated with a saved test, including the log file, the history of the test status as it executed, and the results summary.
- Run a saved test using saved waveforms.

**See also** [Save a test setup](#)  
[Open \(load\) a saved test setup](#)

## Save a test setup

You can save a test setup before or after running a test. You can create a test setup from [already opened test setup](#), or using [default test setup](#). When you select the default test setup, the parameters are set to the application's default value.

Select **Options > Save Test Setup** to save the opened setup.

Select **Options > Save Test Setup As** to save the setup with different name.

## Open (load) a saved test setup

To Open (load) a saved test setup, do the following:

1. Select **Options > Open Test Setup**.
2. Select the setup from the list and click **Open**. Setup files are located at **X:\Ethernet Tx\**.

**See also** [Create a test setup using an existing one](#)  
[Create a test setup from default settings](#)

## Create a test setup from default settings

To create a test setup using default settings, follow the steps:

1. Select **Options > Default Test Setup**. For default test setup, the parameters are set to the application's default value.
2. Click application [Setup](#) and set the parameters
3. Click application [Reports](#) and set the report options
4. Optional: Click **Start** to run the test and verify that it runs correctly and captures the specified test information and reports. If it does not, then edit the parameters and repeat this step until the test runs to your satisfaction
5. Select **Options > Save Test Setup**. Enter the file name and click Save. The application saves the file to X:\Ethernet Tx\*<session\_name>*

## Create a test setup using an existing one

To create a test setup using an existing one, follow the steps:

1. Select **Options > Open Test Setup**
2. Select a setup from the list and then click **Open**
3. Click application [Setup](#) and modify the parameters
4. Click application [Reports](#) and modify the report options
5. Select **Options > Save Test Setup As**
6. Enter test setup name, and click **Save**

---

# TekExpress Ethernet Tx measurements

## Maximum output droop

This section verifies that the transmitter output level does not drop more than the maximum specified amount.

### **Required test equipment**

*Minimum system requirements*

*Supported Probes*

*Equipment connection diagram*

### **Inputs**

- DUT shall be configured to transmit test mode 6 waveform
- If acquisition is single ended, then provide Data+ and Data- waveforms. If acquisition is differential, then provide differential data waveform as input to the measurement.
- REFLEVEL, MIDLEVEL and HYSTERESIS for edge finding
- START TIME and STOP TIME
- POPULATION
- Number of ACQUISITION AVERAGES

**Measurement procedure**

1. If acquisition is single ended, then compute differential waveform (scope math) using acquired single ended signals.
2. Compute edges of differential signal using midlevel and hysteresis dialed by the user in the user interface.
3. If Droop type is "POSITIVE" then
  - a. Consider rising edges for further computation. Waveform Edges = rising edgesElse
  - a. Consider falling edges for further computation. Waveform Edges = falling edges
4. For every edge in Waveform Edges,
  - a. Compute average value of NAVERAGE points around the edge Position + start time. This gives High Voltage.
  - b. Compute average value of NAVERAGE points around the edge Position + stop time. This gives Low Voltage.
  - c. Compute Droop in % =  $((\text{High Voltage} - \text{Low Voltage}) / \text{High Voltage}) * 100$ .
  - d. Store High Voltage, Low Voltage, Edge Position and Droop in %.
5. Compute Maximum, Minimum, Mean and number of Droops from the collected result in step 4.
6. Maximum droop in % will be used for comparing with limits given in specification.

## Transmitter timing Jitter-Master

This section verifies that the transmitter timing jitter - master of the PMA is within the conformance limits.

**Required test equipment**

*Minimum system requirements*

*Supported Probes*

*Equipment connection diagram*

**Inputs**

- DUT shall be configured to transmit test mode 2 waveform
- If acquisition is single ended, then provide Data+ and Data- waveforms. If acquisition is differential then provide differential data waveform as input to measurement.
- REFLEVEL, MIDLEVEL and HYSTERESIS for edge finding



- Acquisition duration
- Apply Band Pass Filter – Yes or No

### Measurement procedure

1. If Acquisition is SINGLE\_ENDED then
  - a. If APPLY FILTER is YES then, APPLY the band pass filter with Fc as (200 MHz/S) with band width as 20 KHz on single ended signals.
  - b. Compute Differential signal (scope math) using acquired single ended signals

Else

  - a. If APPLY FILTER is YES then, APPLY the band pass filter with Fc as (200 MHz/S) with band width as 20 KHz on differential signal.
  - b. Acquire Differential signal
2. Compute edges of differential signal using midlevel and hysteresis dialed by the user in the user interface.
3. Determine the direction of first edge
  - a. If first edge direction is rise, then consider only the rising edges for further computation. Waveform Edges = rising edges
  - b. If first edge direction is fall, then consider only the falling edges for further computation. Waveform Edges = falling edges
4. Do a least square fit using Waveform Edges. X being edge number and Y being edge position.
 

Compute slope and intercept. Intercept gives starting edge position. Slope gives ideal duration between Waveform Edges.

Using Slope and Intercept, reconstruct the ideal position of Waveform Edges.
5. For every Waveform Edge, Compute TIE.
 

$TIE = \text{Actual position of Waveform Edges} - \text{Ideal position of Waveform Edges}$
6. Compute RMS of TIE.
7. RMS of TIE will be used for comparing with limits given in specification

## Transmitter timing Jitter-Slave

This section verifies that the transmitter-slave of the PMA is within the conformance limits.

### **Required test equipment**

*Minimum system requirements*

*Supported Probes*

*Equipment connection diagram*

### **Inputs**

- DUT shall be configured to transmit test mode 6 waveform
- If acquisition is single ended, then provide Data+ and Data- waveforms. If acquisition is differential then provide differential data waveform as input to measurement.
- REFLEVEL, MIDDLEVEL and HYSTERESIS for edge finding
- Acquisition duration
- Apply Band Pass Filter – Yes or No

**Measurement procedure**

1. If Acquisition is SINGLE\_ENDED then,
  - a. If APPLY FILTER is YES, then APPLY the band pass filter with Fc as (200 MHz/S) with band width as 20 KHz on single ended signals.
  - b. Compute Differential signal(scope math) using acquired single ended signalsElse
  - a. If APPLY FILTER is YES then, APPLY the band pass filter with Fc as (200 MHz/S) with band width as 20 KHz on differential signal.
  - b. Acquire Differential signal
2. Compute edges of differential signal using midlevel and hysteresis dialed by the user in the user interface.
3. Determine the direction of first edge.
  - a. If first edge direction is rise, then consider only rising edges for further computation. Waveform Edges = rising edges
  - b. If first edge direction is fall, then consider only falling edges for further computation. Waveform Edges = falling edges
4. Do a least square fit using Waveform Edges. X being edge number and Y being edge position.

Compute slope and intercept. Intercept gives starting edge position. Slope gives ideal duration between Waveform Edges.

Using Slope and Intercept, reconstruct the ideal position of Waveform Edges.
5. For every Waveform Edge, Compute TIE.

$TIE = \text{Actual position of Waveform Edges} - \text{Ideal position of Waveform Edges}$ .
6. Compute RMS of TIE.
7. RMS of TIE will be used for comparing with limits given in specification

## Transmitter Power Spectral Density and Power level

This section verifies that the transmitter Power Spectral Density (PSD) and transmit power level are within the conformance limits.

### Required test equipment

*Minimum system requirements*

*Supported Probes*

*Equipment connection diagram*

### Inputs

- DUT shall be configured to transmit test mode 6 waveform
- If acquisition is single ended, then provide Data+ and Data- waveforms. If acquisition is differential then provide differential data waveform as input to measurement.
- START FREQUENCY, RESOLUTION BANDWIDTH, STOP FREQUENCY for configuring SPECTRAL MAGNITUDE MATH function
- ACQUISITION AVERAGES
- SMOOTHING AVERAGES – the window size used for smoothing the PSD curve

**Measurement procedure**

1. If acquisition is single ended, then compute differential waveform (scope math) using acquired single ended signals.
2. Compute the mean of the differential signal, the DC component.
3. Remove the DC component from the differential signal.  

$$\text{MATH2} = \text{Differential signal} - \text{Mean (Differential Signal)}$$
Mean is computed using scope measurement.
4. Compute the average of spectral magnitude of MATH2  

$$\text{MATH3} = \text{AVG (SpectralMag (MATH2))}$$
SpectralMag settings are as follows:
  - Center Frequency: STOP FREQUENCY/2
  - Frequency Span: STOP FREQUENCY
  - Window Type: GAUSSIAN
  - Vertical Axis Scale: Linear
  - MATH3 averages: ACQUISITION AVERAGES
  - Resolution Bandwidth: RESOLUTION BANDWIDTH
    - Gate position = 0
    - Gate Duration = (2/Resolution Bandwidth in Hz)
Factor of 2 is because of Gaussian window
5. Do a moving average of spectral signal with number of averages equal to SMOOTHING AVERAGES dialed by user in user interface.
6. Compute linear power spectrum of moving averaged signal. Determine the area under the linear power spectrum.
7. Compute the offset/correction value.  
Offset/correction value = function (Resolution Bandwidth configured by user, termination resistance of 100 Ohm, dB to dBm conversion factor, constant factor of 1.05)  

$$\text{Offset/correction value} = 10 \cdot \log_{10}(\text{dB to dBm conversion factor}) - 10 \cdot \log_{10}(\text{Resolution Bandwidth}) - 10 \cdot \log_{10}(\text{termination resistance}) + \text{constant factor}$$

$$\text{Offset/correction value} = 10 \cdot \log_{10}(1000) - 10 \cdot \log_{10}(\text{Resolution Bandwidth}) - 10 \cdot \log_{10}(100) + 1.05$$

$$\text{Offset/correction value} = 11.05 - 10 \cdot \log_{10}(\text{Resolution Bandwidth})$$
8. Power in dBm =  $10 \cdot \log_{10}(\text{Area under the linear power spectrum}) + \text{Offset value}$
9. Convert power spectrum in linear scale to dB scale.
10. Compute power spectrum in dBm/Hz

$$\text{Power Spectrum in dBm/Hz} = \text{power spectrum in dB} + \text{Offset value}$$

11. Power in dBm is compared with limits given in specification
12. PSD curve is compared with limit curve given in specification

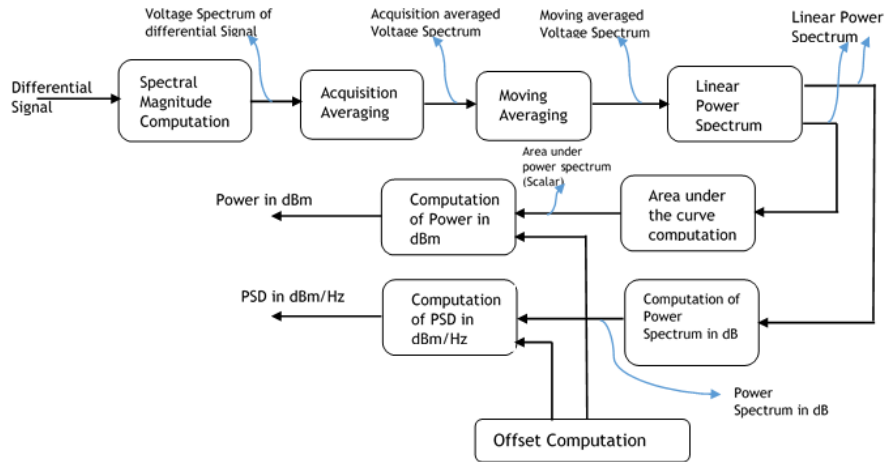

## Transmitter clock frequency

This section verifies that the frequency of the transmit clock is within the conformance limits.

### Required test equipment

*Minimum system requirements*

*Supported Probes*

*Equipment connection diagram*

### Inputs

- DUT shall be configured to transmit test mode 6 waveform
- If acquisition is single ended, then provide Data+ and Data- waveforms. If acquisition is differential then provide differential data waveform as input to measurement.
- REFLEVEL, MIDLEVEL and HYSTERESIS for edge finding.

**Measurement procedure**

1. If acquisition is single ended, then compute differential waveform (scope math) using acquired single ended signals.
2. Compute edges of differential signal using midlevel and hysteresis dialed by the user in the user interface.
3. Compute edge to edge duration
4. Determine the mean, maximum and minimum edge to edge duration
5. Determine the mean deviation, maximum deviation and minimum deviation in terms of ppm from the nominal frequency (edge to edge frequency of test mode 2 signal).

Mean deviation in terms of ppm =  $((1/\text{mean edge to edge duration}) - \text{Expected edge to edge period}) * 1e6 / \text{Expected edge to edge period}$

Maximum deviation in terms of ppm =  $((1/\text{minimum edge to edge duration}) - \text{Expected edge to edge period}) * 1e6 / \text{Expected edge to edge period}$

Minimum deviation in terms of ppm =  $((1/\text{maximum edge to edge duration}) - \text{Expected edge to edge period}) * 1e6 / \text{Expected edge to edge period}$

6. Mean deviation in ppm is compared with limits.

**Transmitter non-linear distortion**

This section verifies that the output of the transmitter conforms to the transmitter linearity requirements.

**Required test equipment**

*Minimum system requirements*

*Supported Probes*

*Equipment connection diagram*

**Inputs**

- DUT shall be configured to transmit test mode 6 waveform
- If acquisition is single ended, then provide Data+ and Data- waveforms. If acquisition is differential then provide differential data waveform as input to measurement.
- START FREQUENCY, RESOLUTION BANDWIDTH, STOP FREQUENCY for configuring SPECTRAL MAGNITUDE MATH function
- ACQUISITION AVERAGES

### Measurement procedure

1. If acquisition is single ended, then compute differential waveform (scope math) using acquired single ended signals.
2. Compute the average of spectral magnitude of differential signal  
$$\text{MATH3} = \text{AVG}(\text{SpectralMag}(\text{Differential Signal}))$$

SpectralMag settings are as follows:

  - Center Frequency:  $\text{STOP FREQUENCY}/2$
  - Frequency Span:  $\text{STOP FREQUENCY}$
  - Window Type: GAUSSIAN
  - Vertical Axis Scale: dB
  - MATH3 averages: ACQUISITION AVERAGES
  - Resolution Bandwidth: RESOLUTION BANDWIDTH
  - Gate position = 0
  - Gate Duration =  $(2/\text{Resolution Bandwidth in Hz})$   
Factor of 2 is because of Gaussian window
3. Determine the peaks (two) and their corresponding frequencies in the spectrum.
4. Check whether peaks correspond to the tone pair (based on the sub-test selected). If not then exit the test.
5. Intermodulation frequencies for above found peak frequencies and their corresponding amplitudes up to 20th order are found using the spectrum
6. Determine the intermodulation distortion.  
$$\text{Intermodulation distortion} = \frac{\text{Sum (Amplitudes of IMF for above found peak frequencies up to 5th order)}}{\text{Sum (Amplitudes of peak frequencies)}}$$
$$\text{Intermodulation distortion in \%} = \text{Intermodulation distortion} * 100$$
7. Spurious Frequency Dynamic Range (SFDR) = Minimum (Amplitudes of peak frequencies) – Maximum (Amplitudes of IMF).
8. SFDR is compared with limits given in specification.



## MDI return loss

This section verifies that the return loss of the DUT is within conformable limits.

### Required test equipment

*Minimum system requirements*

*Supported Probes*

*Equipment connection diagram*

Return loss is a measure of the signal power that is reflected due to the impedance mismatch.

Return loss =  $20 \cdot \log_{10} (\text{Reflected} / \text{Incident})$

Return loss describes the degree of mismatch between a load and characteristic impedance of a transmission system.

Return loss measurement setup involves fixture, AWG, AWG signal, probes, DUT and oscilloscope. Return loss measurement can be divided into 3 steps

- Return Loss calibration
- Computation of error coefficients
- Computation of return loss

### 1. Return Loss Calibration

#### Inputs

- Wide band calibration signal transmitted from AWG.
- Let RJ45 patch chord be connected to open impedance.
- Waveform acquired using a probe connected to input of reference impedance – waveform1
- Waveform acquired using a probe connected to input of DUT cable under test – waveform2
- ACQUISITION AVERAGES → Used for averaging acquired time domain signal
- SMOOTHING AVERAGES → Used internally by C# module for smoothing the return loss curve

**Calibration procedure**

- a. Incident Signal = Waveform2 + (Waveform1 – Waveform2) = Waveform1
- b. Reflected Signal = Waveform2 – (Waveform1 – Waveform2) = 2\*Waveform2 – Waveform1
- c. Compute FFT of incident signal and FFT reflected signal  
 Real Part of FFT of Incident Signal = (SpectralReal (Waveform1))  
 Imaginary Part of FFT of Incident Signal = (SpectralImag (Waveform1))  
 Real Part of FFT of Reflected Signal = (SpectralReal (2\*Waveform2 – Waveform1))  
 Imaginary Part of FFT of Reflected Signal = (SpectralImag (2\*Waveform2 – Waveform1))
- d. Compute Gamma (return loss without error correction) as complex division of reflected signal by incident signal  
 Gamma = Complex (Real Part of FFT of Reflected Signal, Imaginary Part of FFT of Reflected Signal) / Complex (Real Part of FFT of Incident Signal, Imaginary Part of FFT of Incident Signal)
- e. Repeat steps 1.a to 1.d with waveform1 and waveform2 captured using short and load impedance (100 Ohm).

**2. Computation of Error Coefficients**

**Inputs**

- a. Gamma (Complex) values computed with different loads – open, short and load ( $\Gamma_{m1}$ ,  $\Gamma_{m2}$ ,  $\Gamma_{m3}$ )

**Procedure/Steps:**

- a. Compute error coefficients a, b and c using  $\Gamma_{m1}$ ,  $\Gamma_{m2}$  and  $\Gamma_{m3}$  values

$$a = \Gamma_{m2} - \Gamma_{m3} + \frac{\Gamma_{m1} - \Gamma_{m2}}{\Gamma_{m2} + \Gamma_{m1}} \cdot \Gamma_{m2}$$

$$b = \Gamma_{m3}$$

$$c = \frac{\Gamma_{m1} - \Gamma_{m2}}{\Gamma_{m2} + \Gamma_{m1}}$$

**3. Computation of Return Loss**

**Inputs**

- a. Wide band calibration signal transmitted from AWG.
- b. Let RJ45 patch chord be connected to DUT.
- c. Waveform acquired using a probe connected to input of reference impedance – waveform1
- d. Waveform acquired using a probe connected to input of DUT cable under test – waveform2
- e. Error coefficients a, b and c
- f. ACQUISITION AVERAGES → Used for averaging acquired time domain signal
- g. SMOOTHING AVERAGES → Used internally by C# module for smoothing the return loss curve

**Procedure/Steps:**

- a. Incident Signal = Waveform2 + (Waveform1 – Waveform2) = Waveform1
- b. Reflected Signal = Waveform2 – (Waveform1 – Waveform2) = 2\*Waveform2 – Waveform1
- c. Compute FFT of incident signal and FFT reflected signal  
 Real Part of FFT of Incident Signal = (SpectralReal (Waveform1))  
 Imaginary Part of FFT of Incident Signal = (SpectralImag (Waveform1))  
 Real Part of FFT of Reflected Signal = (SpectralReal (2\*Waveform2 – Waveform1))  
 Imaginary Part of FFT of Reflected Signal = (SpectralImag (2\*Waveform2 – Waveform1))
- d. Compute Gamma (return loss/reflection coefficient without error correction) as complex division of reflected signal by incident signal ( $\Gamma_m$ )  
 Gamma = Complex (Real Part of FFT of Reflected Signal, Imaginary Part of FFT of Reflected Signal) / Complex (Real Part of FFT of Incident Signal, Imaginary Part of FFT of Incident Signal)
- e. Compute error corrected reflection coefficient

$$\Gamma_A = \frac{\Gamma_m - b}{a - c\Gamma_m}$$

- f. Compute return loss in dB scale as Return Loss = 20\*log10 (Absolute ( $\Gamma_A$ ))
- g. Re-normalize the return loss to 85 Ohm and 115 Ohm.

$$\text{Gamma at } Z_1 \text{ Ohm} = \frac{\beta + \Gamma_A}{1 + \beta \cdot \Gamma_A}$$

$$\text{where } \beta = \frac{Z_A - Z_1}{Z_A + Z_1}$$

$Z_A \rightarrow 100 \text{ Ohm}$

$Z_1 \rightarrow 85 \text{ Ohm or } 115 \text{ Ohm}$

$\Gamma_A \rightarrow$  Reflection coefficient with 100 Ohm impedance

Return Loss at Z1 Ohm =  $20 \cdot \log_{10} (\text{Absolute} (\text{Gamma at Z1 Ohm}))$

- h.** Return Loss curve is compared with limits given in specification.



# SCPI commands

## About SCPI command

You can use Standard Commands for Programmable Instruments (SCPI) to communicate with the TekExpress application.

## Socket configuration for SCPI commands

This section describes the steps for TCP/IP socket configuration and TekVISA configuration to execute the SCPI commands.

### TCP/IP socket configuration

1. Click **Start > Control Panel > System and Security > Windows Firewall > Advanced settings**

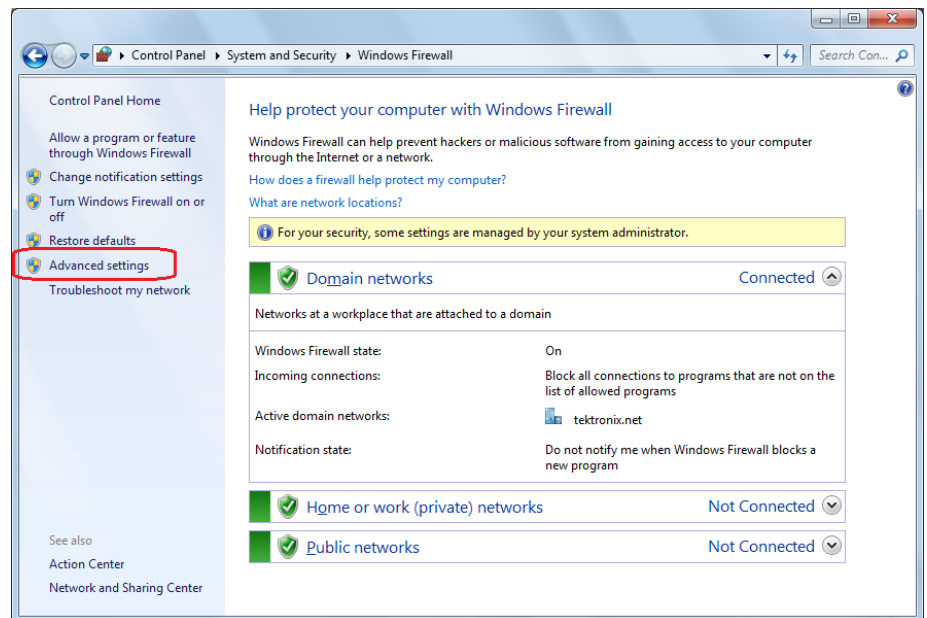

2. In Windows Firewall with Advanced Security menu, select **Windows Firewall with Advanced Security on Local Computer > Inbound Rules** and click New Rule...

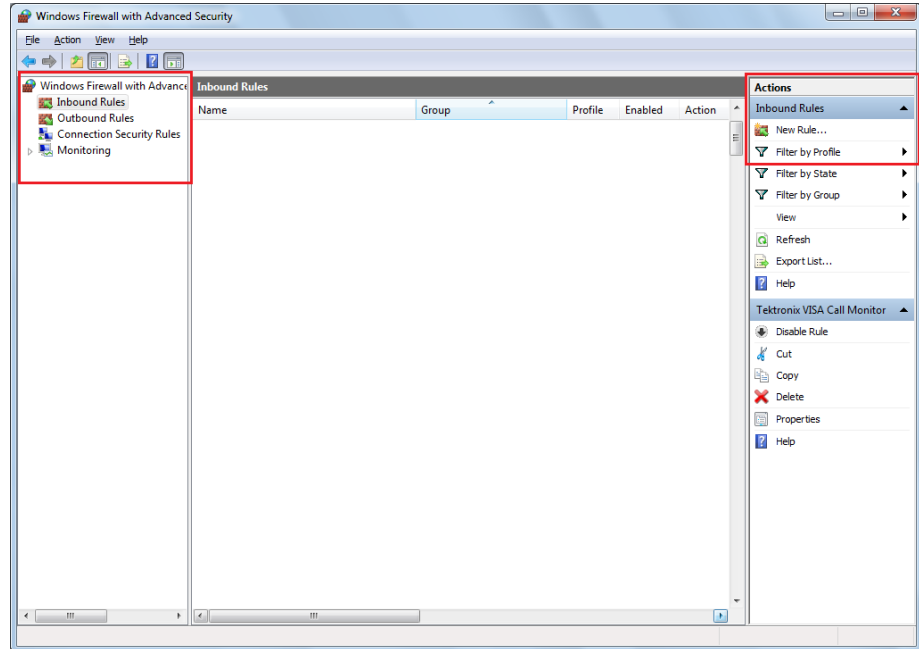

3. In New Inbound Rule Wizard menu



a. Select **Port** and click **Next**

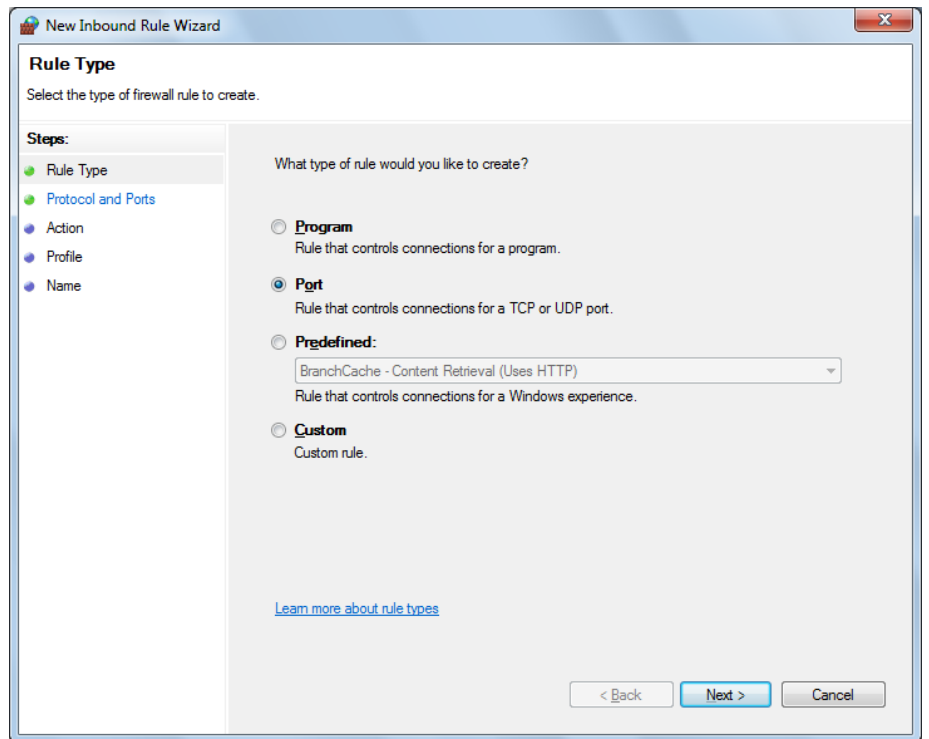

- b. Select **TCP** as rule apply and enter 5000 for **Specific local ports** and click **Next**

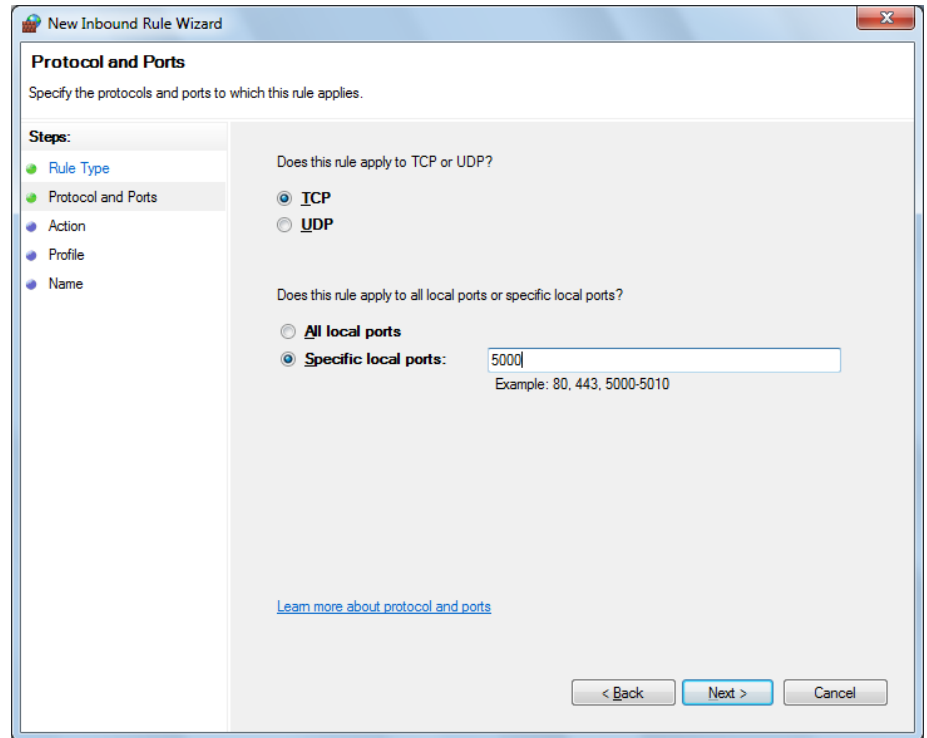

c. Select **Allow the connection** and click **Next**

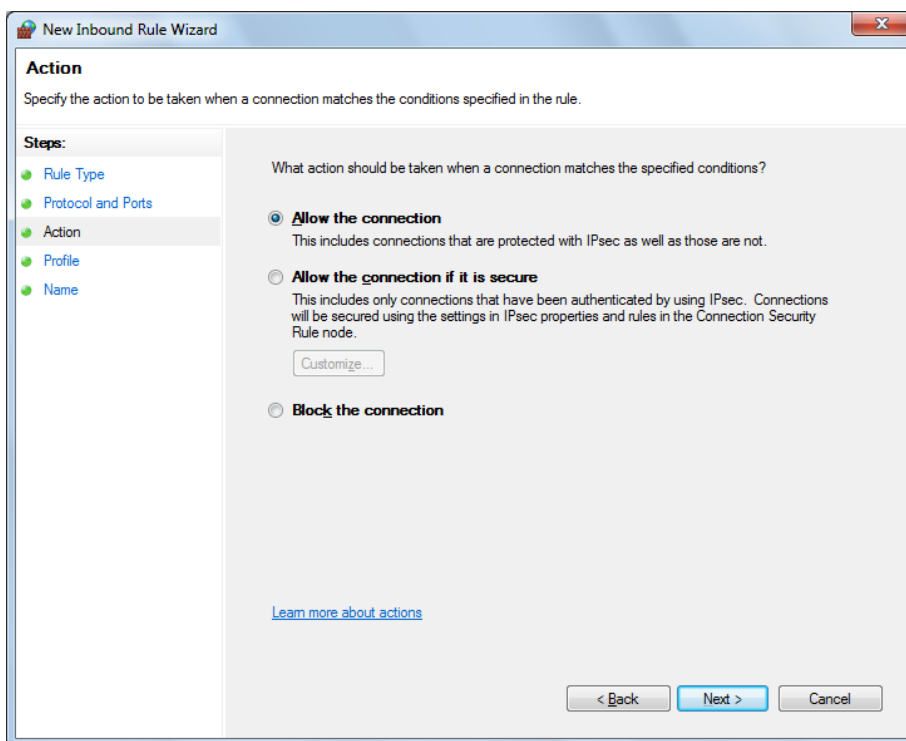

d. Select **Domain**, **Private**, **Public** and click **Next**

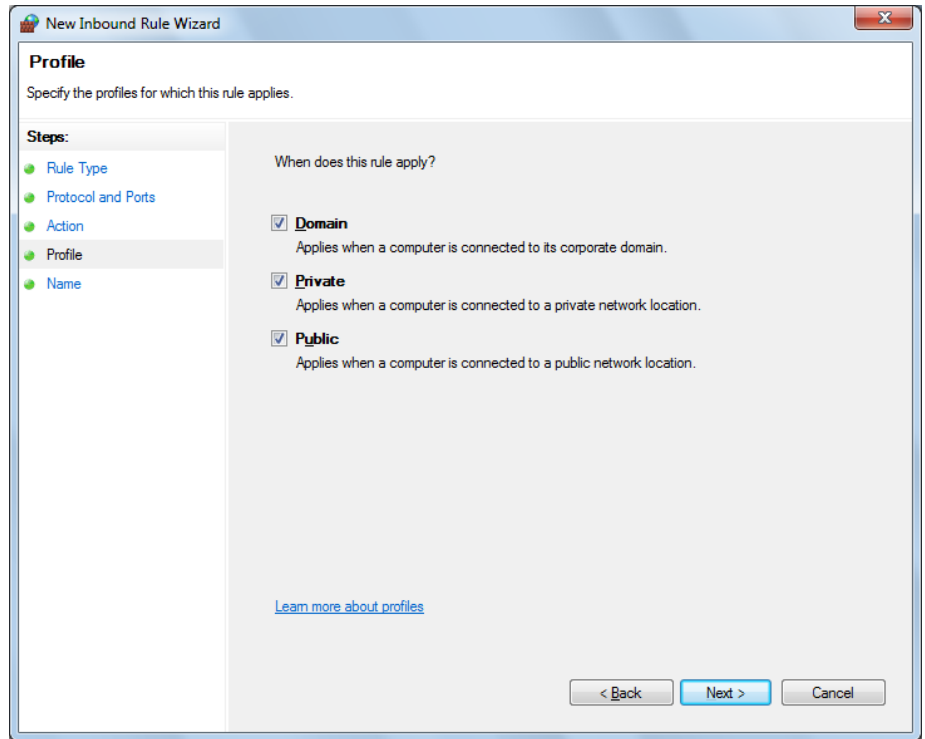

- e. Enter **Name**, Description (optional), and click **Finish**

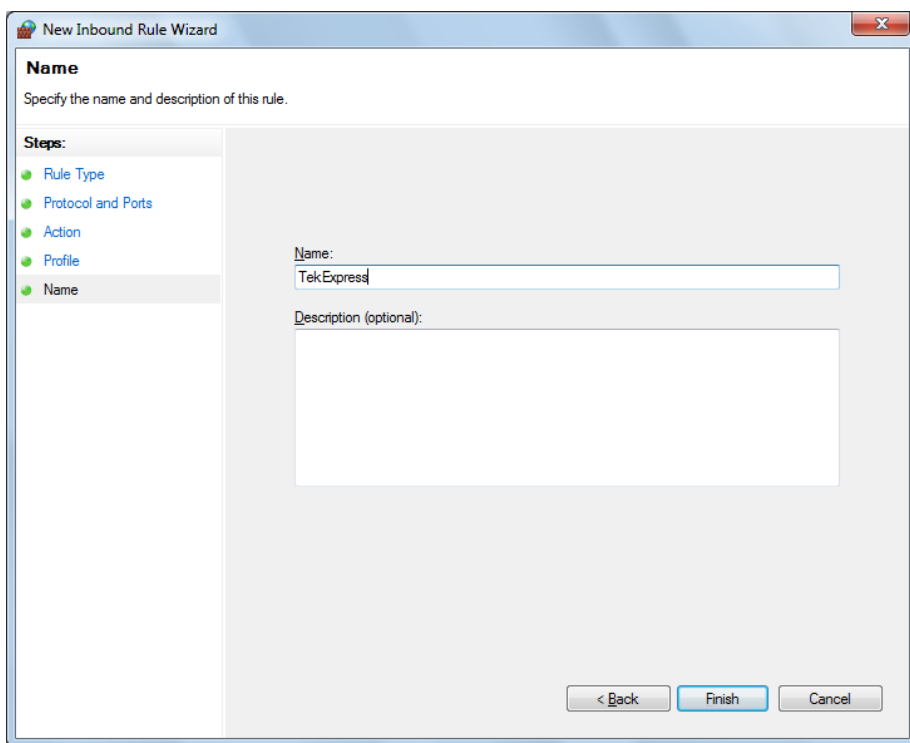

4. Check whether the Rule name is displayed in **Windows Firewall with Advanced Security menu > Inbound Rules**

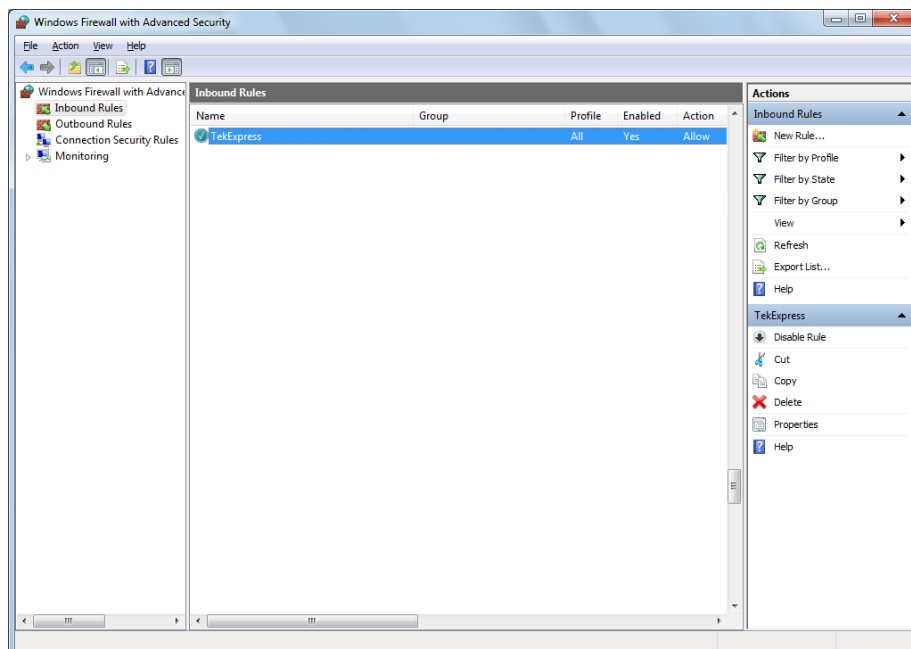

- TekVISA configuration**
1. Click **Start > All Programs > TekVISA > OpenChoice Instrument Manager**

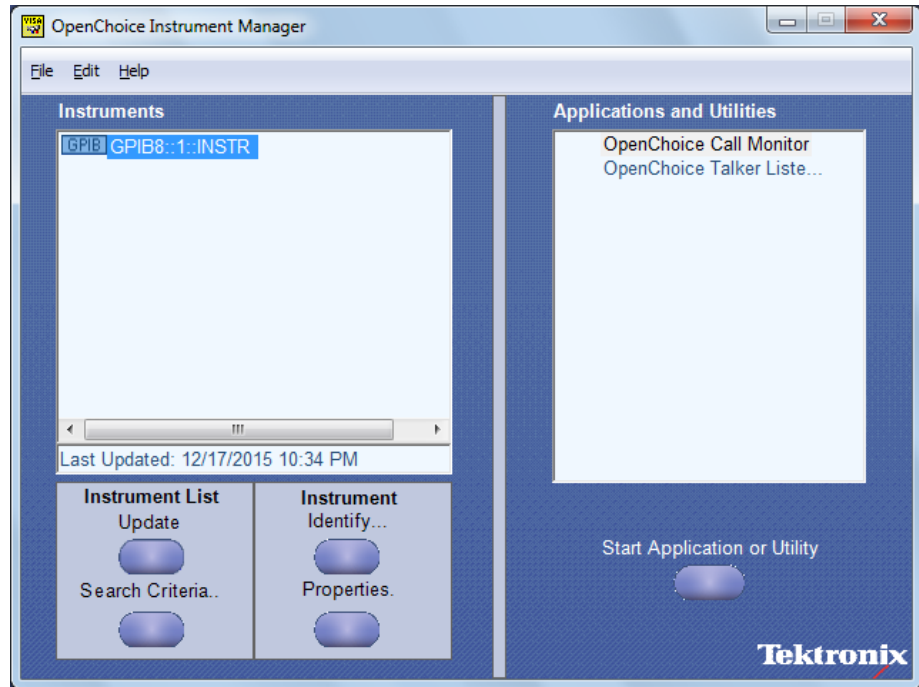

2. Click **Search Criteria**. In Search Criteria menu, click **LAN** to Turn-on. Select **Socket** from the drop-down list, enter the IP address of the

TekExpress device in **Hostname** and type **Port** as 5000. Click  to configure the IP address with Port.

Enter the Hostname as 127.0.0.1 if the TekVISA and TekExpress application are in the same system, else enter the IP address of the TekExpress application system.

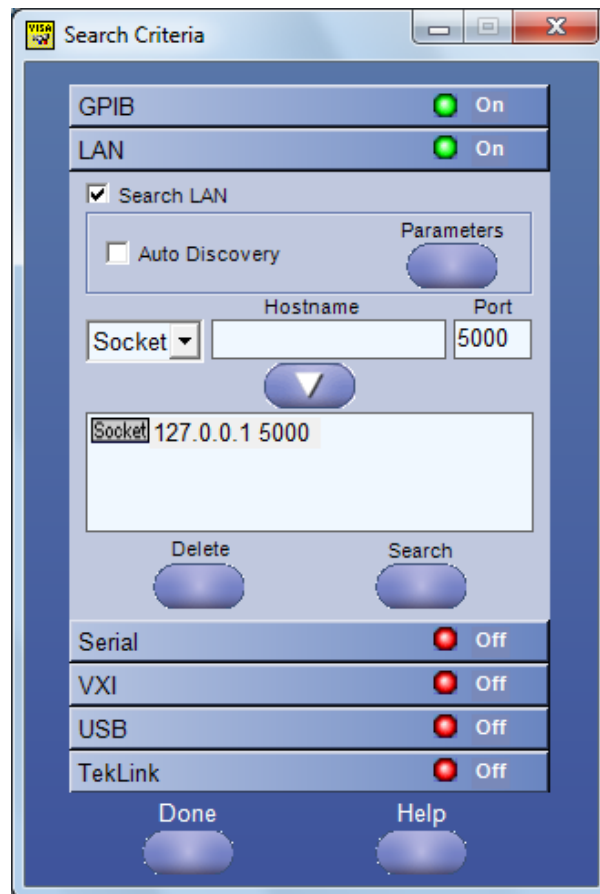

- Click **Search** to setup the TCPIP connection with the host. Check whether the TCPIP host name is displayed in **OpenChoice Instrument Manager > Instruments**

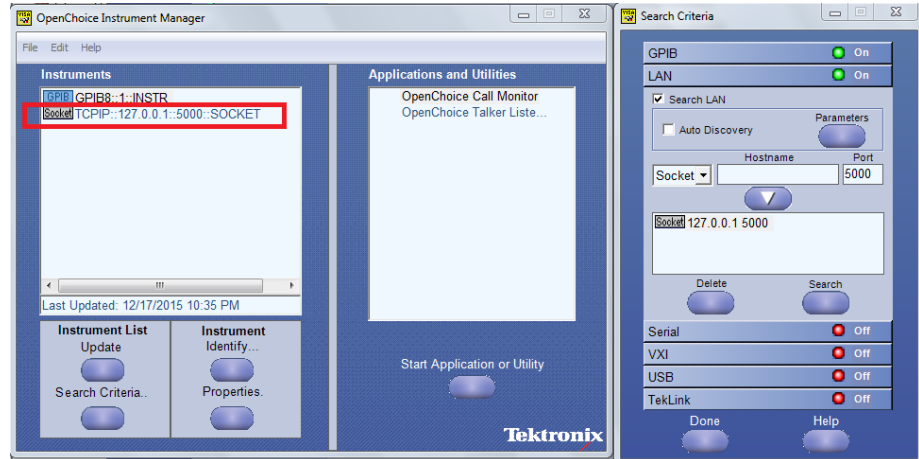

- Double-click **OpenChoice Takler Listener** and enter the Command **\*IDN?** in command entry field and click **Query**. Check that the Operation is successful and Talker Listener Readout displays the Command / Data.

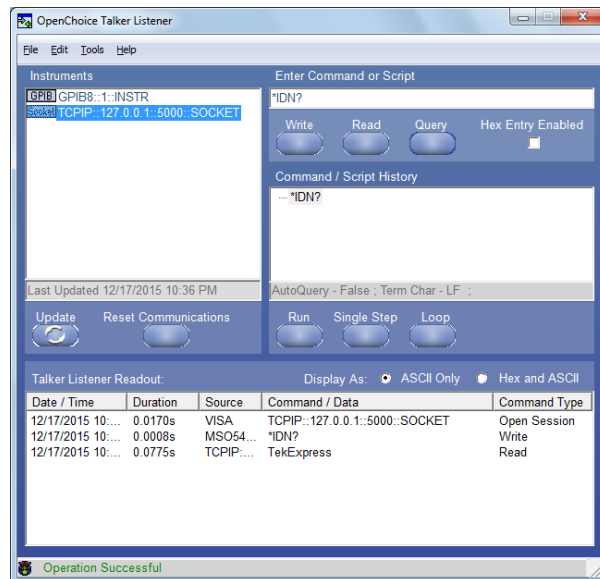



## TEKEXP:\*IDN?

This command queries the active TekExpress application name running on the scope.

**Syntax**    TEKEXP:\*IDN?\n

**Inputs**    NA

**Outputs**   Returns active TekExpress application name running on the scope

**Example**    If TEKEXP:\*IDN?\n Returns "TekExpApp", then TekExpApp is the name of the active TekExpress application running on the scope.

## TEKEXP:\*OPC?

This command queries the execution status of the last executed command.

**Syntax**    TEKEXP:\*OPC?\n

**Inputs**    NA

**Outputs**    0 - last command execution is not complete  
1 - last command execution is complete

**Example** If `TEKEXP:*OPC?` returns 0, then the last command execution is not complete.

## TEKEXP:ACQUIRE\_MODE

This command sets the acquire mode as live or pre-recorded.

**Syntax** `TEKEXP:ACQUIRE_MODE {LIVE | PRE-RECORDED}\n`

**Inputs** {LIVE | PRE-RECORDED}

**Outputs** NA

**Example** `TEKEXP:ACQUIRE_MODE PRE-RECORDED\n` sets the acquire mode as pre-recorded.

## TEKEXP:ACQUIRE\_MODE?

This command queries the acquire mode type.

**Syntax** `TEKEXP:ACQUIRE_MODE?\n`

**Inputs** NA

**Outputs** {LIVE | PRE-RECORDED}

**Example** If `TEKEXP:ACQUIRE_MODE?` returns "LIVE", then acquire mode is set to live.

## TEKEXP:EXPORT

This command returns all the bytes of data to the specified file.

Syntax	Outputs
<code>TEKEXP:EXPORT REPORT</code>	Returns the report file in bytes
<code>TEKEXP:EXPORT WFM,"&lt;FileName&gt;"</code>	Returns the specified waveform file in bytes
<code>TEKEXP:EXPORT IMAGE,"&lt;FileName&gt;"</code>	Returns the specified image file in bytes

**Inputs** FileName - Specifies the file name

**Example** `TEKEXP:EXPORT REPORT` returns the report file in bytes. This can be written into another file for further analysis.

---

**NOTE.** This command can be executed through scripts only as this command requires FileName parameter to be parsed from `TEKEXP:INFO?` command.

---

## TEKEXP:INFO?

This command queries the information about the file(s).

Syntax	Outputs
<code>TEKEXP:INFO? REPORT</code>	<ReportFileSize>,"<ReportFileName.mht>"
<code>TEKEXP:INFO? WFM</code>	<WfmFile1Size>,"<WfmFileName1.wfm>";<WfmFile2Size>,"<WfmFileName2.wfm>";...
<code>TEKEXP:INFO? IMAGE</code>	<Image1FileSize>,"<Image1FileName>";<Image2FileSize>,"<Image2FileName>" ;...

**Example** If TEKEXP:INFO? REPORT\n returns “100”, “ReportFileName.mht”, then 100 bytes is the filesize and ReportFileName is the filename.  
 If TEKEXP:INFO? WFM\n returns “100”, “WfmFileName1.wfm”; “200”, “WfmFileName2.wfm”.

## TEKEXP:INSTRUMENT

This command sets the value for the selected instrument type.

**Syntax** TEKEXP:INSTRUMENT "<InstrumentType>",<Value>"\n

**Inputs** InstrumentType  
 Value



---

**TIP.** Check [Command parameters list](#) for InstrumentType and Value parameters.

---

**Outputs** NA

**Example** TEKEXP:INSTRUMENT "<Real Time Scope>",<111>"\n sets the instrument value as 111 for the selected instrument type XXX.

## TEKEXP:INSTRUMENT?

This command queries the instrument selected for the specified instrument type.

**Syntax**    `TEKEXP:INSTRUMENT? "<InstrumentType>"\n`

**Inputs**    `InstrumentType`



---

**TIP.** Check [Command parameters list](#) for `InstrumentType` parameters.

---

**Outputs**    Returns the instrument selected for the specified instrument type

**Example**    If `TEKEXP:INSTRUMENT? "Real Time Scope"\n` returns "InstrumentA", then InstrumentA is the selected instrument for the instrument type Real Time Scope.

## TEKEXP:LASTERROR?

This command queries the last error string occurred for the current TCP session. If there are no errors since startup, or since the last call to `TEKEXP:LASTERROR?\n`, this command returns an empty string.

**Syntax**    `TEKEXP:LASTERROR?\n`

**Inputs**    NA

**Outputs** <string>

**Example** If TEKEXP:LASTERROR?\n returns "ERROR: ErrorA", then ErrorA is the last error occurred.

## TEKEXP:LIST?

This command queries the list of available device, suite, test, version or instrument.

Syntax	Outputs
TEKEXP:LIST? DEVICE\n	Returns the list of available device(s) as comma separated values.
TEKEXP:LIST? SUITE\n	Returns the list of available suite(s) as comma separated values.
TEKEXP:LIST? TEST\n	Returns the list of available test(s) as comma separated values.
TEKEXP:LIST? VERSION\n	Returns the list of available version(s) as comma separated values.
TEKEXP:LIST? INSTRUMENT,"<InstrumentType>\n	Returns the list of available instruments' for the given Instrument type as comma separated values.

**Inputs** InstrumentType



**TIP.** Check [Command parameters list](#) for InstrumentType parameters.

**Example** If TEKEXP:LIST? DEVICE\n returns "TX-Device,RX-Device" then TX-Device, RX-Device are the available device.

If TEKEXP:LIST? INSTRUMENT,"Real Time Scope"\n returns Instrument1, Instrument2 then Instrument1, Instrument2 are the list of available instruments.

## TEKEXP:MODE

This command sets the execution mode as compliance or user defined.

**Syntax**    `TEKEXP:MODE {COMPLIANCE | USER-DEFINED}\n`

**Inputs**    `{COMPLIANCE | USER-DEFINED}`

**Outputs**   `NA`

**Example**    `TEKEXP:MODE COMPLIANCE\n` to set the execution mode as compliance

## TEKEXP:MODE?

This command queries the execution mode type.

**Syntax**    `TEKEXP:MODE?\n`

**Inputs**    `NA`

**Outputs**   `{COMPLIANCE | USER-DEFINED}`

**Example**    If `TEKEXP:MODE?\n` returns `COMPLIANCE`, then the execution mode is compliance.

## TEKEXP:POPUP

This command sets the response to the active popup shown in the application.

**Syntax** TEKEXP:POPUP "<PopupResponse>"\n

**Inputs** PopupResponse

**Outputs** NA

**Example** TEKEXP:POPUP "PopupResponseA"\n sets PopupResponseA as the response to active popup in the application.

## TEKEXP:POPUP?

This command queries the active popup information shown in the application.

**Syntax** TEKEXP:POPUP?\n

**Inputs** NA

**Outputs** Returns the active popup information in the application.

**Example** If TEKEXP:POPUP?\n returns "PopupMessageA", then PopupMessageA is the active popup information shown in the application.



## TEKEXP:REPORT

This command generates the report for the current session.

**Syntax**    TEKEXP:REPORT GENERATE\n

**Inputs**    GENERATE

**Outputs**   NA

**Example**    TEKEXP:REPORT GENERATE\n generates report for the current session.

## TEKEXP:REPORT?

This command queries the queried header field value in the report.

**Syntax**    TEKEXP:REPORT? "<HeaderField>"\n

**Inputs**    HeaderField - Specifies to return the measured value for the indicated test.



---

**TIP.** Check **Report** for HeaderField parameters.

---

**Outputs**   Returns the queried header field value in the report

**Example** If TEKEXP:REPORT? “Master Scope Information”\n returns "DPO73304SX", then DPO73304SX is the scope model.

If TEKEXP:REPORT? “DUT ID”\n returns "DNI\_DUTID", then DNI\_DUTID is the DUT ID.

## TEKEXP:RESULT?

This command queries the result available in report summary/details table.

Syntax	Outputs
TEKEXP:RESULT? "<TestName>"\n	Return Pass/Fail status of the test.
TEKEXP:RESULT? "<TestName>",<ColumnName>"\n	Returns all the row values of the specified column for the test.
TEKEXP:RESULT? "<TestName>",<ColumnName>,<RowNumber>"\n	Returns the column value for the specified row number.

**Inputs**

- TestName - Specifies the name of the test for which to obtain the test result value.
- ColumnName - Specifies the column name for the measurement
- RowNumber - Specifies the row number of the measurement



**TIP.** Check *Report* for TestName, ColumnName, and RowNumber parameters.

---

**Example** If TEKEXP:RESULT? "Period using SCOPE (Acquire-Analyze Combined)"\n returns Pass, then the test result is Pass.

If TEKEXP:RESULT? "Period using SCOPE (Acquire-Analyze Combined)","Margin",1\n returns "L:-50.000ps H:2000.000ps", then L:-50.000ps H:2000.000ps is the value.

If TEKEXP:RESULT? "Measured Value","Clock Frequency",1\n returns "2.9600413", then 2.9600413 is the value.

## TEKEXP:SELECT

This command selects the device, suite, version, or test.

**Syntax**    `TEKEXP:SELECT <string1>,<string2>,<string4>\n`  
`TEKEXP:SELECT TEST,<string3>,<string4>\n`

**Inputs**    `<string1> = {DEVICE | SUITE | VERSION}`  
`<string2> = {DeviceName | SuiteName | VersionName}`  
`<string3> = {"<TestName>" | ALL | REQUIRED }`  
`<string4> = {TRUE | FALSE}`



---

**TIP.** Check [Command parameters list](#) for *DeviceName*, *SuiteName*, *VersionName*, and *TestName* parameters.

---

**Outputs**    NA

**Example**    `TEKEXP:SELECT DEVICE, DeviceA, "TestNameA"\n` selects DeviceA, TestNameA.

## TEKEXP:SELECT?

This command queries the name of the selected device, suite, version, or test.

**Syntax**    `TEKEXP:SELECT? {DEVICE | SUITE | TEST | VERSION}\n`

**Inputs**    `{DEVICE | SUITE | TEST | VERSION}`

**Outputs**    Returns the name of the selected device, suite, version, or test.

**Example**    If `TEKEXP:SELECT? DEVICE\n` returns "TX-Device", then TX-Device is the type of the selected device.

## TEKEXP:SETUP

This command sets the value of the current setup.

Syntax	Outputs
<code>TEKEP:SETUP DEFAULT\n</code>	Restore to default Setup
<code>TEKEP:SETUP OPEN,"&lt;SessionName&gt;\n</code>	Open the session
<code>TEKEXP:SETUP SAVE\n</code>	Save the session
<code>TEKEXP:SETUP SAVE,"&lt;SessionName&gt;\n</code>	Save the session

**Inputs**    SessionName - The name of the session

**Example**    `TEKEP:SETUP DEFAULT\n` restore to default setup.

## TEKEXP:STATE

This command sets the execution state of the application.

**Syntax**    `TEKEXP:STATE {RUN | STOP | PAUSE | RESUME}\n`

**Inputs**    `{RUN | STOP | PAUSE | RESUME}`

**Outputs**   `NA`

**Example**    `TEKEXP:STATE STOP\n` sets the execution state of the application to stop.

## TEKEXP:STATE?

This command queries the current setup state.

Syntax	Outputs
<code>TEKEXP:STATE?</code>	<code>RUNNING   PAUSED   WAIT   ERROR   READY   STOPPED</code>
<code>TEKEXP:STATE? SETUP</code>	<code>SAVED   NOT_SAVED</code>

**Example**    If `TEKEXP:STATE?\n` returns as `READY`, then the application is ready to run next measurement.

If `TEKEXP:STATE? SETUP\n` returns as `NOT_SAVED`, then the current setup is not saved.

## TEKEXP:VALUE

This command sets the value of parameters of type General, Acquire, Analyze, or DUTID.

**Syntax**    `TEKEXP:VALUE GENERAL,"<ParameterName>","<Value>"\n`  
`TEKEXP:VALUE ACQUIRE,"<AcquireType>", "<ParameterName>",`  
`"<Value>"\n`  
`TEKEXP:VALUE ANALYZE,"<ParameterName>". "<Value>"\n`  
`TEKEXP:VALUE DUTID,"<Value>"\n`

**Inputs**    `ParameterName` - Specifies the parameter name  
`AcquireType` - Specifies the acquire type  
`Value` - Specifies the value to set



---

**TIP.** Check [Command parameters list](#) for `ParameterName`, `AcquireType`, and `Value` parameters.

---

**Outputs**    NA

**Example**    `TEKEXP:VALUE GENERAL,"Signal Type"\n` sets the parameter name as Signal Type for GENERAL.

## TEKEXP:VALUE?

This command queries the value of the parameter for type General, Acquire, Analyze, or DUTID.

Syntax	Outputs
TEKEXP:VALUE? GENERAL,"<ParameterName>"\n	Returns the value of Parameter for type GENERAL
TEKEXP:VALUE? ACQUIRE,"<AcquireType>","<ParameterName>" \n	Returns the value of Parameter for type ACQUIRE
TEKEXP:VALUE? ANALYZE,"<ParameterName>"\n	Returns the value of Parameter for type ANALYZE
TEKEXP:VALUE? DUTID\n	Returns the DUTID value

**Inputs** ParameterName - Specifies the parameter name  
AcquireType - Specifies the acquire type



**TIP.** Check [Command parameters list](#) for ParameterName and AcquireType parameters.

**Outputs** Returns the value of Parameter for type GENERAL | ACQUIRE | ANALYZE | DUTID.

**Example** If TEKEXP:VALUE? GENERAL,"Signal Type"\n returns "N1N0", then N1N0 is the value of parameter Signal Type for GENERAL.

## Command parameters list

This section provides the parameters list for the SCPI commands.

Parameters	Description
InstrumentType	<p>Specifies the instrument type. Valid values are:</p> <ul style="list-style-type: none"> <li>■ AWG</li> <li>■ Real Time Scope</li> </ul>
Value	<p>Specifies the value parameters.</p> <ul style="list-style-type: none"> <li>■ For InstrumentType, valid values are: <ul style="list-style-type: none"> <li>■ Do not use</li> <li>■ MSO71254C ( GPIB8::1::INSTR )</li> </ul> </li> <li>■ For DUTID, valid value is: <ul style="list-style-type: none"> <li>■ Comment</li> </ul> </li> </ul>
DeviceName	<p>Specifies the device name. Valid value is <b>Ethernet Tx</b></p>
SuiteName	<p>Specifies the suite name. Valid values are:</p> <ul style="list-style-type: none"> <li>■ 10GBASE-T</li> <li>■ 5GBASE-T</li> <li>■ 2.5GBASE-T</li> </ul>



Parameters	Description
VersionName	Specifies the version name. Valid value is <b>Spec 1.0</b>
TestName	Specifies the test measurement name. Valid values are: <ul style="list-style-type: none"> <li>■ Maximum Output Droop</li> <li>■ Power Spectrum Density</li> <li>■ Tone-1</li> <li>■ Tone-2</li> <li>■ Tone-3</li> <li>■ Tone-4</li> <li>■ Tone-5</li> <li>■ Clock Frequency</li> <li>■ Jitter Master</li> <li>■ Jitter Slave</li> <li>■ Open Termination</li> <li>■ Short Termination</li> <li>■ Load Termination</li> <li>■ Return Loss</li> </ul>

### ParameterName and Value for General, Acquire and Analyze

Specifies the ParameterName and Value for General, Acquire and Analyze. The configuration parameters available are not same for measurements.

**Table 14: ParameterName and Value for General**

ParameterName	Value
Report Update Mode	<ul style="list-style-type: none"> <li>■ New</li> <li>■ Append</li> <li>■ Replace</li> </ul>
Auto increment report name if duplicate	TRUE or FALSE
Include Pass/Fail Results Summary	TRUE or FALSE
Include Detailed Results	TRUE or FALSE
Include Plot Images	TRUE or FALSE
Include Setup Configuration	TRUE or FALSE
Include User Comments	TRUE or FALSE

ParameterName	Value
Save As Type	<ul style="list-style-type: none"> <li>■ Web Archive (*.mht;*.mhtml)</li> <li>■ PDF (*.pdf;)</li> </ul>
View Report After Generating	TRUE or FALSE
Report Group Mode	<ul style="list-style-type: none"> <li>■ Test Name</li> <li>■ Lane Name</li> <li>■ Test Result</li> <li>■ Equalization</li> </ul>
Create report at the end	<ul style="list-style-type: none"> <li>■ Included</li> <li>■ Excluded</li> </ul>
DUTID Comment	User comment
Number of retries for instrument IO errors	0 to 5
Run Test More than Once	TRUE or FALSE
Number of Runs	1 to 200
On Failure Rerun	TRUE or FALSE
Number of Reruns On Failure	1 to 100
Time between retries (seconds)	5 to 60
Timer Warning Info Message Popup	<ul style="list-style-type: none"> <li>■ "True"</li> <li>■ "FALSE"</li> </ul>
Timer Warning Info Message Popup Duration	0 to 20
Timer Error Message Popup	<ul style="list-style-type: none"> <li>■ "True"</li> <li>■ "False"</li> </ul>
Timer Error Message Popup Duration	0 to 20
On Failure Stop and Notify	TRUE or FALSE
Specification Details	<ul style="list-style-type: none"> <li>■ NBASE-T Phy Layer Spec 1.1</li> <li>■ IEEE P802.3bz, Section 126</li> </ul>
Probing Type	<ul style="list-style-type: none"> <li>■ SINGLE ENDED</li> <li>■ Differential</li> </ul>

ParameterName	Value
Link Widths	<ul style="list-style-type: none"> <li>■ 1 Lane</li> <li>■ 2 Lanes</li> <li>■ 3 Lanes</li> <li>■ 4 Lanes</li> </ul>
Signal Validation	<ul style="list-style-type: none"> <li>■ Prompt me if Signal Validation Fails</li> <li>■ Skip Test if Signal Validation Fails</li> <li>■ Use signal as is - Don't Validate</li> </ul>
Lane A Connected to:Lane A:Differential	<ul style="list-style-type: none"> <li>■ CH1</li> <li>■ CH2</li> <li>■ CH3</li> <li>■ CH4</li> </ul>
Lane B Connected to:Lane B:Differential	
Lane C Connected to:Lane C:Differential	
Lane D Connected to:Lane D:Differential	
Lane A Connected to:Lane A+:Single Ended	
Lane A Connected to:Lane A-:Single Ended	
Lane B Connected to:Lane B+:Single Ended	
Lane B Connected to:Lane B-:Single Ended	

**Table 15: ParameterName and Value for Acquire**

Test Name	AcquireType	ParameterName	Value
Maximum Output Droop	Maximum Output Droop-Acquisition	Population	100 to 5000 (units - clock cycles)
Power Spectrum Density	Power Spectrum Density-Acquisition	AcquisitionAverage	2 to 256
Tone-1	Tone-1-Acquisition	AcquisitionAverage	2 to 100
Tone-2	Tone-2-Acquisition	AcquisitionAverage	2 to 100
Tone-3	Tone-3-Acquisition	AcquisitionAverage	2 to 100
Tone-4	Tone-4-Acquisition	AcquisitionAverage	2 to 100
Tone-5	Tone-5-Acquisition	AcquisitionAverage	2 to 100
Clock Frequency	Clock Frequency-Acquisition	Population	10000 to 2000000 (clock cycles) for data rate - 10G 100 to 2000000 (clock cycles) for data rate - 5G and 2.5G

Test Name	AcquireType	ParameterName	Value
Jitter Master	Jitter Master-Acquisition	AcquisitionDuration	0.1 ms to 10 ms
Jitter Slave	Jitter Slave-Acquisition	AcquisitionDuration	0.1 to 10
Open Termination	Open Termination-Acquisition	AcquisitionAverage	2 to 128
Short Termination	Short Termination-Acquisition	AcquisitionAverage	2 to 128
Load Termination	Load Termination-Acquisition	AcquisitionAverage	2 to 128
Return Loss	Return Loss-Acquisition	AcquisitionAverage	0 to 10 2 to 1280 to 10

**Table 16: ParameterName and Value for Analyze**

Test Name	ParameterName	Value
Maximum Output Droop	RefLevel	<ul style="list-style-type: none"> <li>■ Percentage</li> <li>■ Absolute</li> </ul>
	MidLevel	If Ref Level is Percentage then 20 to 80 If Ref Level is Absolute then -10 mV to 10 mV
	Hysteresis	If Ref Level is Percentage then 2 to 20 If Ref Level is Absolute then -2 to 2
	StartTime	5 ns to 15 ns
	EndTime	<ul style="list-style-type: none"> <li>■ For 10GBASE-T, 85 ns to 95 ns</li> <li>■ For 5GBASE-T, 160 ns to 180 ns</li> <li>■ For 2.5GBASE-T, 320 ns to 340 ns</li> </ul>
Power Spectrum Density	StartFrequency	1 MHz to 1500 MHz
	StopFrequency	1600 MHz to 4000 MHz
	ResolutionBandwidth	1 MHz to 5 MHz
	PowerLevelStartFrequency	1 MHz to 1500 MHz
	PowerLevelStopFrequency	1600 MHz to 4000 MHz
	Smoothing Average	1 to 100
Tone-1	StartFrequency	1 kHz to 30000 kHz
	StopFrequency	350000 kHz to 800000 kHz
	ResolutionBandwidth	20 kHz to 500 kHz
Tone-2	StartFrequency	1 kHz to 30000 kHz
	StopFrequency	350000 kHz to 800000 kHz
	ResolutionBandwidth	20 kHz to 500 kHz

Test Name	ParameterName	Value
Tone-3	StartFrequency	1 kHz to 30000 kHz
	StopFrequency	350000 kHz to 800000 kHz
	ResolutionBandwidth	20 kHz to 500 kHz
Tone-4	StartFrequency	1 kHz to 30000 kHz
	StopFrequency	350000 kHz to 800000 kHz
	ResolutionBandwidth	20 kHz to 500 kHz
Tone-5	StartFrequency	1 kHz to 30000 kHz
	StopFrequency	350000 kHz to 800000 kHz
	ResolutionBandwidth	20 kHz to 500 kHz
Clock Frequency	RefLevel	<ul style="list-style-type: none"> <li>■ Percentage</li> <li>■ Absolute</li> </ul>
	MidLevel	If Ref Level is Percentage then 20 to 80 If Ref Level is Absolute then -10 mV to 10 mV
	Hysteresis	If Ref Level is Percentage then 2 to 20 If Ref Level is Absolute then 0 mV to 4 mV
Jitter Master	RefLevel	<ul style="list-style-type: none"> <li>■ Percentage</li> <li>■ Absolute</li> </ul>
	MidLevel	If Ref Level is Percentage then 20 to 80 If Ref Level is Absolute then -10 mV to 10 mV
	Hysteresis	If Ref Level is Percentage then 2 to 20 If Ref Level is Absolute then 0 mV to 4 mV
Jitter Slave	RefLevel	<ul style="list-style-type: none"> <li>■ Percentage</li> <li>■ Absolute</li> </ul>
	MidLevel	If Ref Level is Percentage then 20 to 80 If Ref Level is Absolute then -10 mV to 10 mV
	Hysteresis	If Ref Level is Percentage then 20 to 80 If Ref Level is Absolute then 0 mV to 4 mV
Open Termination	SmoothingAverage	1 to 10
Short Termination	SmoothingAverage	1 to 10
Load Termination	SmoothingAverage	1 to 10
Return Loss	SmoothingAverage	1 to 10



---

# Index

## A

- Acquire parameters
  - including in test reports, 35
  - viewing in reports, 37
- Acquisition tab, 24
- Analysis options, 30
- Application panels overview, 12
- Application version (show), 7

## B

- Button
  - clear log, 31
  - Email settings, 30
  - save, 31

## C

- Compensate the signal path, 48
- Configuration tab, 20
- Configuration tab parameter
  - instruments detected, 26
- Configuration tab parameters
  - global settings, 26
- Connected instruments
  - searching for, 17
- Connection requirements, 39
- Create a test setup from default settings, 52
- Create a test setup using an existing one, 52

## D

- DUT ID, 22
- DUT parameter
  - device, 22
  - device profile, 22
  - optical module settings, 22
  - optical power, 22
- DUT type
  - device, 22
- DUT-instrument setup, 39

## E

- Email notification and setup, 19

- Equipment setup, 39
- Extensions, file names, 9

## F

- File name extensions, 9

## G

- GPIB, 17

## H

- Help conventions, 2

## I

- Installing the software
  - TekExpress Ethernet Tx Solution, 7
- Instrument-DUT setup, 39
- Instruments
  - discovering connected, 17
  - viewing connected, 17
- Instruments detected, 26

## K

- Keep on top, 11

## L

- LAN, 17
- License agreement (show), 7
- Live waveforms, 22
- Loading a test setup, 52
- Log view
  - save file, 31

## M

- Maximum output droop, 53
- Menus
  - Options, 15
- Minimum system requirements, 5

My TekExpress folder  
files stored in, 33

## N

Names, file extensions, 9  
Non-VISA, 17

## O

Opening a saved test setup, 52  
Options menu  
Instrument control settings, 17  
keep on top, 11  
Oscilloscope compensation, 48

## P

Panels, 12  
Pattern, 22  
Pattern type, 22  
Preferences menu, 32  
Preferences tab  
send an Email, 30  
setup panel, 30

## R

Recalling a test setup, 52  
Recommended probes, 6  
Related documentation, 1  
Report contents, 37  
Report name, 35  
Report options, 35  
Report sections, 37  
Reports  
receiving in email notifications, 19  
Reports panel, 12, 34  
Resource file, 11  
Results panel  
summary of test results, 32  
test name, 32  
Running tests, 50

## S

Save log file, 31

Saving tests, 33  
Schematic button (DUT-instrument setup), 39  
SCPI commands  
Command parameters list, 94  
TEKEXP:\*IDN?, 79  
TEKEXP:\*OPC?, 79  
TEKEXP:ACQUIRE\_MODE, 80  
TEKEXP:ACQUIRE\_MODE?, 80  
TEKEXP:EXPORT, 81  
TEKEXP:INFO?, 81  
TEKEXP:INSTRUMENT, 83  
TEKEXP:INSTRUMENT?, 82  
TEKEXP:LASTERROR?, 83  
TEKEXP:LIST?, 84  
TEKEXP:MODE, 85  
TEKEXP:MODE?, 85  
TEKEXP:POPUP, 86  
TEKEXP:POPUP?, 86  
TEKEXP:REPORT, 87  
TEKEXP:REPORT?, 87  
TEKEXP:RESULT?, 88  
TEKEXP:SELECT, 89  
TEKEXP:SELECT?, 90  
TEKEXP:SETUP, 90  
TEKEXP:STATE, 91  
TEKEXP:STATE?, 91  
TEKEXP:VALUE, 92  
TEKEXP:VALUE?, 93  
Search for connected instruments, 17  
Selecting test report contents, 35  
Selecting tests, 23  
Serial, 17  
Session folders and files, 33  
Setting up equipment, 39  
Setup  
acquisition tab, 24  
Setup files, 51  
Setup panel  
DUT parameter, 20  
preferences tab, 20  
test selection, 20  
Signal conditioning  
bandwidth, 22  
filter, 22



Software installation  
  TekExpress Ethernet Tx Solution, 7  
Source, 22  
Status panel  
  log view, 31  
  message history, 31  
  test status tab, 31  
System requirements, 5

## T

Technical support, 2  
Tek Link, 17  
Test reports, 37  
Test results  
  send by email, 19  
Test selection  
  Clock Frequency, 23  
  Jitter Master, 23  
  Jitter Slave, 23  
  Linearity, 23  
  Maximum Output Droop, 23  
  Power Spectrum Density, 23  
  Return Loss, 23  
Test selection controls, 23  
Test setup files, 33, 51  
Test setups  
  load, 52  
  open, 52

  recalling, 52  
Test status  
  acquire status, 31  
  analysis status, 31  
  auto scroll, 31  
Test-related files, 33  
Tests  
  running, 50  
  selecting, 23

## U

USB, 17  
User Comments  
  including in reports, 36

## V

View a report, 37  
View application license agreement, 7  
View application software version, 7  
VXI, 17

## W

Waveform files  
  locating and storing, 33  
Wavelength, 22

