



**Advanced Power Analysis  
Printed Application Help**







**Advanced Power Analysis  
Printed Application Help**

Copyright © Tektronix. All rights reserved. Licensed software products are owned by Tektronix or its subsidiaries or suppliers, and are protected by national copyright laws and international treaty provisions. Tektronix products are covered by U.S. and foreign patents, issued and pending. Information in this publication supersedes that in all previously published material. Specifications and price change privileges reserved.

TEKTRONIX and TEK are registered trademarks of Tektronix, Inc.

### **Contacting Tektronix**

Tektronix, Inc.  
14150 SW Karl Braun Drive  
P.O. Box 500  
Beaverton, OR 97077  
USA

For product information, sales, service, and technical support:

- In North America, call 1-800-833-9200.
- Worldwide, visit [www.tek.com](http://www.tek.com) to find contacts in your area.

---

# Table of Contents

Welcome .....	ix
<b>General safety summary</b>	
General safety summary .....	1
<b>Introduction</b>	
Online help and related documentation .....	3
Printing from online help .....	3
Related documentation .....	4
Conventions .....	4
Feedback .....	4
<b>Getting started</b>	
Introduction and product description .....	7
Compatibility .....	8
Requirements and restrictions .....	9
Current probes .....	9
Voltage probes .....	10
Updates through the web site .....	12
Installing the application .....	12
<b>Operating basics</b>	
About basic operations .....	13
About basic operations .....	13
Application interface .....	13
Application interface menu controls .....	13
Basic application functions .....	14
Application directories and file names .....	14
File name extensions .....	14
Returning to the application .....	15
Saving and recalling setups .....	15
Saving a setup .....	15
Recalling a saved setup .....	16
Recalling the default setup .....	16

Utilities .....	17
DeGauss .....	17
Auto Zero .....	17
Preferences setup .....	18
Deskew .....	19
Deskewing probes and channels .....	22

## Advanced power measurement and analysis

Setting up DPOPWR to take measurements .....	29
Setting up the software .....	29
Table of options-Source configuration .....	30
Table of measurements and configurations-Timing analysis .....	33
Table of measurements and configurations-Magnetics .....	35
Table of measurements and configurations-Input analysis .....	37
Table of measurements and configurations-Output analysis .....	40
Table of measurements and configurations-Amplitude .....	42
Taking a new measurement .....	43
About taking measurements .....	43
Viewing results .....	43
Plot components and features .....	45
Viewing plots .....	51
Reports .....	54
Selecting a measurement .....	57
Source configuration .....	58
Selecting and configuring measurements .....	61
Configuring global settings .....	64
Configuring options .....	65
Configuring edges .....	65
Control panel .....	66
Switching measurement and analysis .....	67
Switching loss .....	67
Hi-Power finder .....	85
RDS(on) .....	90
di-dt .....	94
dv-dt .....	97
Safe operating area .....	100
Safe operating area X-Y .....	107
Timing measurement and analysis .....	109
Pulse width .....	109

Duty cycle .....	112
Period .....	114
Frequency .....	116
Skew .....	118
Magnetics measurement and analysis .....	121
Inductance .....	121
Magnetic property .....	124
Magnetic loss .....	131
I vs (integral-of)V .....	132
Input measurement and analysis .....	135
Power quality .....	135
Current harmonics .....	138
Voltage harmonics .....	151
Total power quality .....	154
Inrush current .....	163
Input capacitance .....	165
Output measurement and analysis .....	167
Line ripple .....	167
Spectral analysis .....	169
Switching ripple .....	175
Turn-On time .....	177
Amplitude .....	179
Cycle min .....	179
Cycle max .....	182
Cycle peak-to-peak (Pk-Pk) .....	185
High .....	188
Low .....	190
High-low .....	193

## Tutorial

Introduction to the tutorial .....	195
Reference waveform and mask files .....	195
Starting the application .....	196
Setting up the oscilloscope .....	196
Measuring Switching Loss .....	197
Measuring Magnetics .....	199

## Application examples

About application examples .....	203
To increase efficiency in a switching power supply .....	203
Measure Switching Loss .....	203
Measure Hi-Power finder .....	205
Measure magnetic loss .....	207

## GPIB commands

DPOPWR LAUnch .....	211
DPOPWR:ADDMeas .....	211
DPOPWR:CLEARALLMeas .....	214
DPOPWR:CLEARALLPlots .....	214
DPOPWR:FRERun .....	214
DPOPWR:GENREPAS .....	215
DPOPWR:GENREPort .....	215
DPOPWR:LASTError? .....	216
DPOPWR:MEAS(x):ACCMAX? .....	216
DPOPWR:MEAS(x):ACCMEAN? .....	217
DPOPWR:MEAS(x):ACCMIN? .....	217
DPOPWR:MEAS(x):ACCPKTOPK? .....	218
DPOPWR:MEAS(x):ACCPULATION? .....	218
DPOPWR:MEAS(x):ACCREST? .....	219
DPOPWR:MEAS(x):ACCSTDDEV? .....	219
DPOPWR:MEAS(x):ACQMODE .....	220
DPOPWR:MEAS(x):ADDPLOT .....	220
DPOPWR:MEAS(x):AUTOZERO .....	222
DPOPWR:MEAS(x):BWLIMIT .....	222
DPOPWR:MEAS(x):COUPLING .....	223
DPOPWR:MEAS(x):CURGATING .....	223
DPOPWR:MEAS(x):CURRENTMAX? .....	224
DPOPWR:MEAS(x):CURRENTMEAN? .....	224
DPOPWR:MEAS(x):CURRENTMIN? .....	225
DPOPWR:MEAS(x):CURRENTPKTOPK? .....	225
DPOPWR:MEAS(x):CURRENTPULATION? .....	226
DPOPWR:MEAS(x):CURRENTREST? .....	226
DPOPWR:MEAS(x):CURRENTSTDDEV? .....	227
DPOPWR:MEAS(x):CUSTOMNAME? .....	227



DPOPWR:MEAS(x):DEGauss .....	228
DPOPWR:MEAS(x):GATESOURce .....	228
DPOPWR:MEAS(x):ISOURce .....	229
DPOPWR:MEAS(x):NAME? .....	229
DPOPWR:MEAS(x):SELEctmeas .....	230
DPOPWR:MEAS(x):SOURCEAPPLYAll .....	230
DPOPWR:MEAS(x):SOURCEAutoset .....	231
DPOPWR:MEAS(x):VSOURce .....	232
DPOPWR:OPC? .....	232
DPOPWR:RECalc .....	233
DPOPWR:SELECTEDMeas? .....	233
DPOPWR:SINgle .....	234
DPOPWR:Stop .....	234
DPOPWR:VERsion? .....	234

## Reference

Error codes for DPOPWR .....	235
Error codes for DPOPWR cont. ....	239
Correlation of measurement to configurations .....	260
Correlation of measurement to plots .....	262
Parameters .....	264
About application parameters .....	264
Sequencer parameters .....	264
Measurement menu parameters .....	264
Configure measurements menu parameters .....	265
Source configuration parameters .....	265
Configure Hi-Power finder and switching loss parameters .....	265
Configure magnetics parameters .....	267
Configure SOA parameters .....	268
SOA mask .....	268
Configure di-dt parameters .....	268
Configure dv-dt parameters .....	268
Configure current harmonics parameters .....	269
Configure voltage harmonics parameters .....	269
Configure total power quality parameters .....	270
Configure line ripple parameters .....	270
Configure switching ripple parameters .....	271
Configure Turn-On time parameters .....	271
Configure pulse width timing analysis parameters .....	271

Configure period timing analysis parameters .....	272
Configure duty cycle timing analysis parameters .....	272
Configure frequency parameters .....	272
Utilities menu .....	273
Static deskew .....	274
Prevailing switch mode power supply (SMPS) .....	276
Switching loss (PFC) .....	278
Switch current spikes during turn ON .....	278
Cursor placement .....	278
REF level computation for noisy VG source .....	281
How to compare between plot and result .....	282

## Algorithms

About Algorithms .....	285
Options configuration .....	285
Switching analysis .....	286
Switching loss .....	286
Benefits of Vg Source and SWL configuration .....	292
Switching loss - PFC .....	296
Hi-Power finder .....	300
Safe operating area .....	300
RDS(on) .....	302
di-dt .....	302
dv-dt .....	302
Timing analysis .....	303
Skew .....	305
Magnetics .....	306
Input analysis .....	308
Power quality .....	308
Current/Voltage harmonics .....	311
Total power quality .....	315
In-Rush current .....	315
Input capacitance .....	316
Output analysis .....	316
Ripple line and ripple switching .....	316
Spectral analysis .....	316
Turn-On time .....	319
Amplitude .....	319
High .....	319

---

Low .....	319
High-Low .....	320
Cycle min .....	320
Cycle max .....	320
Cycle peak-to-peak (Pk-Pk) .....	320

## Appendix

Appendix A .....	321
Appendix B .....	322

## Glossary

AC signal .....	323
Electrical power dissipation .....	324
Harmonics .....	324
In rush .....	327
Input capacitance .....	327
RMS value (voltage)(voltage) .....	327
Transfer impedance .....	328



---

# Welcome

Advanced Power Measurement and Analysis software allows power supply designers to configure multiple measurements with custom defined settings, measure and analyze power dissipation in switching devices, and measure and analyze magnetic parameters in a single acquisition. The addition of new measurements such as Inrush current, Capacitance, and Reactive power provides more insight into the input / output characterization of power supplies. Designers who otherwise spend a lot of time manually analyzing power dissipations per cycle can now, with the Switching loss plot and the Time trend plot, measure power dissipation at all switching cycles graphically. A single .mht format with the append feature provides an easy way to generate reports that include measurements, test results, and plot images. This solution elevates your productivity to a new level and helps SMPS designers meet pre-compliance requirements.

Advanced Power Measurement and Analysis software with version > 2.0.0 runs on DPO/DSA7000C, MSO/DPO5000/B, MSO/DSA/DPO70000C, DPO/DSA700000D, and MSO/DPO/DSA70000DX series oscilloscopes with Windows 7 64-bit OS. For WinXP series oscilloscopes DPOPWR solution version is 1.0.13.

## Features and benefits

The software includes the following key features:

- New measurements such as Inrush current, Capacitance, Reactive power and Switching loss trajectory plot which provide more insight to Input/output characterization.
- Custom source Autoset for vertical and horizontal sets the scope parameters automatically, increasing your productivity and measurement repeatability.
- Automatic computation of line frequency provide more accurate results to Voltage and current Harmonics.
- Automatic detection of PFC circuit waveforms and prompts the user to use VG for noisy/ringing switching waveforms.
- Multiple measurements can be run at same time for single acquisition, providing correlated power measurements.
- Synchronization of Time trend plot with actual waveform allow you to observe the variation of measurements over time.
- Automatic detection of probes, AutoZero / Degauss, and de-skew utilities.
- Reference waveform helps you to do post analysis now available for all measurements.
- Seamless integration of the application with the oscilloscope allows you to switch between application and scope easily and debug more effectively.

- Global configuration features such as acquisition mode (HiRes), cursor gating, coupling, and BW limits are applied uniformly across a group of measurements.
- Programmatic interface command support.

## Key measurements

The key measurements of DPOPWR include the following:

- Switching Loss measurement computes TON, TOFF, and total loss values and trajectory plot of ON and OFF values for all switching cycles.
- Hi Power Finder identifies all the peaks in the power waveform (MATH) and has interactive detail results. It allows traversing between the peak values and the result shows energy and loss values for each ON-ON switching cycle.
- RDS(on) and SOA, measures dynamic internal resistance and customizable Safe Operating Area mask testing with linear and log scales. SOA X-Y RDS(on) does not support reference waveforms.
- Magnetics measurements compute total magnetic loss, inductance of core and shows graph of relationship between B and H.
- Power Quality measurement, computes THD, True Power, Apparent Power, Power Factor, and Crest Factor. All these analysis outputs are shown in a quick view in the Summary results table.
- Current Harmonics enables all precompliance testing to cover EN61000-3-2, EN61000-3-2 AM14, and MIL 1399 (400 Hz) standards. User defined mode displays up to the 100th harmonic in both table and bar graph formats.
- Voltage Harmonics provide a frequency-domain view of the AC voltage, such as at the output of an inverter.
- Inrush current measurement identifies the peak currents based on configured threshold level.
- Capacitance measurement computes peak capacitance value above configured threshold value.
- Timing/Modulation analysis displays a time-trend plot of the cycle-to-cycle variations in the modulated switching signal based on positive and negative pulse width, positive and negative duty cycle, frequency, period, and skew measurements.
- Amplitude measurement computes High, Low, High-Low, Cycle Min, Cycle Max and Cycle Pk-Pk. All these analysis outputs are shown in the Results table, Time trend, and Histogram plots.

## What do you want to do?

[Study online help and related documentation](#)

[Read product description](#)

[Go to installation procedures](#)

---

# General safety summary

## General safety summary

Review the following safety precautions to avoid injury and prevent damage to the measurement instrument or any products connected to it. To avoid potential hazards, use the software and measurement instrument only as specified.

While using this software, you may need to access other parts of the system. Read the general safety summary and specification sections in other equipment manuals for warnings, cautions, and ratings related to operating the system with this software.

### To avoid fire and personal injury

**Connect and disconnect properly.** Connect the probe output to the measurement instrument before connecting the probe to the circuit under test. Disconnect the probe input and the probe ground from the circuit under test before disconnecting the probe from the measurement instrument.

**Observe all terminal ratings.** To avoid fire or shock hazard, observe all ratings and markings on the measurement instrument and other equipment used with this software. Consult the individual product manuals for further ratings information before making connections to the circuit under test.

**Do not operate with suspected failures.** If you suspect there is damage to the measurement instrument or other equipment being used with this software, have it inspected by qualified service personnel.

### Terms in this manual

These terms may appear in this manual:

**WARNING.** Warning statements identify conditions or practices that could result in injury or loss of life.

**CAUTION.** Caution statements identify conditions or practices that could result in damage to the measurement instrument or other property.

**Terms in the application**

When launched from the oscilloscope menu, the application displays a caution dialog box, warning you to use only appropriately rated voltage and current probes, accessories, and other equipment. Click OK.

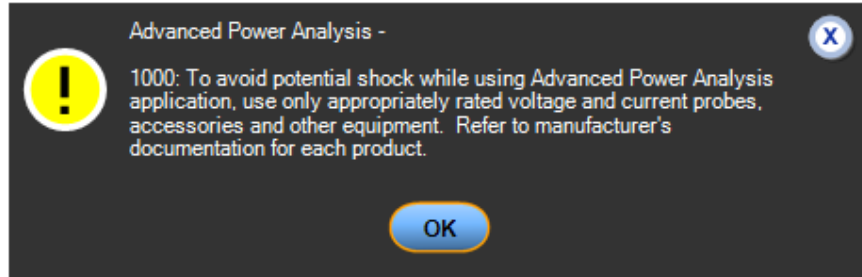



---

# Introduction

## Online help and related documentation

Access the information on how to operate the application with the oscilloscope through the following related documents and online help.

**What do you want to do?**

[\*Conventions\*](#)

[\*Related Documentation\*](#)

[\*Contact Tektronix\*](#)

[\*Provide feedback on this Tektronix product\*](#)

## Printing from online help

Some online help topics have color in the examples of the displayed application. To print this type of topic on a monochrome printer, some information may not print because of certain colors. Instead, you should print the topic from the PDF (portable document format) file that corresponds to the online help.

## Related documentation

In addition to the online help, you can access other information on how to operate the oscilloscope through the following related documents:

- Oscilloscope Information: The user manual and user online help for your oscilloscope provide general information on how to operate the oscilloscope.



**TIP.** You can download PDF versions of many user manuals from the Tektronix Web site.

---

- Programmer Information: The online programmer guide for your oscilloscope provides details on how to use GPIB commands to control the oscilloscope.

## Conventions

Online help uses the following conventions:

- Refers to the DPOPWR Power Measurements solution as Advanced Power Analysis Application.
- When steps require a sequence of selections using the application interface, the ">" delimiter marks each transition between a menu and an option. For example, one of the steps to save a setup file would appear as File> Save.
- The Source Configuration Panel is common to many measurements.
- GP knob refers to the general-purpose knob.

## Feedback

Tektronix values your feedback on our products. To help us serve you better, please send us your suggestions, ideas, or comments on your oscilloscope.

Direct your feedback using e-mail to

techsupport@tektronix.com or FAX at (503) 627-5695

and include the following information. Please be as specific as possible.

- General information:**
- Oscilloscope model number and hardware options, if any
  - Probes used
  - Your name, company, mailing address, phone number, FAX number
  - Please indicate if you would like to be contacted by Tektronix about your suggestion or comments

- Application specific information:**
- Software version number
  - Description of the problem such that technical support can duplicate the problem
  - If possible, save the oscilloscope and application setup files as .set files
  - If possible, save the waveform on which you are performing the measurement as a .wfm file

Once you have gathered this information, contact technical support by phone or through e-mail. If using e-mail, be sure to enter in the subject line "DPOPWR Problem," and attach the .set and .wfm files.



---

# Getting started

## Introduction and product description

Advanced Power Measurement and Analysis software (DPOPWR) with version > 2.0.0 runs on DPO/DSA7000C, MSO/DPO5000/B, MSO/DSA/DPO70000C, DPO/DSA700000D, and MSO/DPO/DSA70000DX series oscilloscopes with Windows 7 64-bit OS. For WinXP series oscilloscopes DPOPWR solution version is 1.0.13. It allows you to acquire, measure, and analyze various switching power supply signals at multiple test points. The application provides simple and direct way to obtain results about switching devices, magnetic components, and compliance tests to EN 61000-3-2 standard for Switch mode Power supply. The features of DPOPWR are:

- **Switching Analysis:** It analyzes the switching devices in the power supply, such as FET (Field Effect Transistor), BJT (BiPolar Junction Transistor), and IGBT (Integrated Gated BiPolar Junction Transistor). The measurements include Switching Loss, Trajectory plot with ON and OFF values for all switching cycles, Hi-Power Finder, Safe Operating Area (SOA), SOA X-Y (DPX), Dynamic Resistance RDS(on), di/dt, and dv/dt.
- **Timing Analysis:** It analyzes the switching devices in the power supply, such as FET, BJT, and IGBT. The measurements include Pulse Width modulation, Period modulation, Duty Cycle modulation, Frequency measurement, and Skew.
- **Magnetics:** It measures Inductance, Magnetic Property, Magnetic Loss, and  $I \text{ vs } \int V$ .
- **Input Analysis:** It measures Power Quality, Current Harmonics (upto 100th harmonic value is displayed in table and bar graph format), Voltage Harmonics, Total Power Quality, In Rush Current, and Capacitance.
- **Output Analysis:** It measures Line Ripple, Switching Ripple, Turn-On Time, and Spectral Analysis. Spectral Analysis analyses the electromagnetic interference frequency and measures the noise/ripple frequency range at output DC voltage. Support of POE specification filter in Spectral Measurement.
- **Amplitude:** It measures High, Low, High-Low, Cycle Min, Cycle Max and Cycle Pk-Pk for periodic waveforms.
- A Report tool with append capability to create and print custom reports in .mht format.
- **SOA Overlay, Deskew, Auto detect of probes, DeGauss Autoset, Autocalc loss without Vg, and SOA Mask Editor** utilities.

- What do you want to do? [Current probes](#)  
[Compatibility](#)  
[Requirements and restrictions](#)  
[Installing the application](#)

## Compatibility

To view number of channels required for any measurement, click Help > About TekScope. The oscilloscope displays the channel dependencies in option panel.

Measurement Name	Number of Channels
Switching Analysis	
di /dt	1
dv /dt	1
Hi-Power Finder	2 - 3
RDS(On)	2
SOA	2
SOA X-Y (DPX)	2
Switching Loss	2 - 3
Timing Analysis	
Duty Cycle	1
Frequency	1
Period	1
Pulse Width	1
Skew	2
Magnetics	
I vs $\int V$	2
Magnetic Loss	2
Magnetic Property	2 - 4
Inductance	2
Input Analysis	
In Rush Current	1
Input Capacitance	2
Current Harmonics	2
Power Quality	2
Total Power Quality	2
Voltage Harmonics	1
Output Analysis	
Line Ripple	1
Switching Ripple	1

Measurement Name	Number of Channels
Spectral Analysis	1
Turn-On time	2 to 4
Amplitude	
High	1
Low	1
High Low	1
Cycle Min	1
Cycle Max	1
Cycle Pk-Pk	1

## Requirements and restrictions

Install Microsoft .NET Framework Version 4.0 as a prerequisite prior to installing DPOPWR application. Microsoft Windows Internet browser is required to view report.

## Current probes

The application supports the following probes:

- AM503B series with A6302
- AM503B series with A6302XL
- AM503B series with A6303
- AM503B series with A6303XL
- AM503B series with A6304XL
- AM503 Series with A6312
- TCP0020
- TCP0030
- TCP0030A
- TCP0150
- TCP202
- TCP2020
- TCP202A
- TCP202A and TPA-BNC
- TCPA300 with TCP303
- TCPA300 with TCP303 and TPA-BNC

- TCPA300 with TCP305
- TCPA300 with TCP305 and TPA-BNC
- TCPA300 with TCP305A
- TCPA300 with TCP305A and TPA-BNC
- TCPA300 with TCP312
- TCPA300 with TCP312 and TPA-BNC
- TCPA300 with TCP312A
- TCPA300 with TCP312A and TPA-BNC
- TCPA400 with TCP404XL
- TCPA400 with TCP404XL and TPA-BNC
- TekVPI TCP0030

## Voltage probes

The application supports the following probes:

- P5050
- P5050B
- P5100
- P5100A
- P5200A
- P5200A
- P5202A
- P5205
- P5205A
- P5210
- P5210A
- P6015A (10 ft)
- P6015A (25 ft)
- P6021A
- P6131 (1.3 m)
- P6131 (2 m)
- P6138A
- P6139A
- P6139B
- P6158



- P6243
- P6245
- P6246
- P6247
- P6248
- P6250
- P6251
- TAP1500
- TAP2500
- TDP0500
- TDP1000
- TDP1500
- TDP3500
- TekVPI TAP1500
- TekVPI TAP2500
- TekVPI TPA-BNC
- THDP0100
- THDP0200
- TMDP0200
- TPP0500
- TPP0500B
- TPP0502
- TPP0850
- TPP1000

**Voltage probes**

The application supports the Deskew Fixture (Tektronix part number: 067-1686-XX).

---

**NOTE.** For further information about probes visit [www.tek.com/probes](http://www.tek.com/probes).

---

---

**NOTE.** If you are using external fixtures to measure Turn-On Time and Ripple, then enter the external attenuation factor values in the Vertical > External Attenuation menu for accurate results.

---

## Updates through the web site

Find information about DPOPWR and other applications at the Tektronix Inc. Web site, [www.tektronix.com](http://www.tektronix.com). Check this site for updates and free applications.

To install an application update, you must download it from the Tektronix Web site to the oscilloscope hard disk.

---

**NOTE.** *Refer to the Readme.txt file on the web site for steps to install and more information.*

---

## Installing the application

Your instrument comes with the application preinstalled on the hard drive.

---

**NOTE.** *If you install the new Advanced Power Analysis application, the old DPOPWR application is uninstalled.*

---

# Operating basics

## About basic operations

**About basic operations** This section contains information on:

*Application interface*

Using basic oscilloscope functions

*Setting up the software*

*Saving and recall setups*

**Application interface** The application uses a Microsoft Windows interface.

*Application directories and file names*

*Application interface menu controls*

---

**NOTE.** *The oscilloscope application shrinks to half size and appears in the top half of the display when the application is running.*

---

### Application interface menu controls

Item	Description
Menu bar	Located at the top of the oscilloscope that is used to start the application
Tab	Labeled group of options containing similar items
Area	Enclosed visual frame with a set of related options
Option button	Button that defines a particular command or task
Drop-Down List box	Box that contains a list of items from which you can select one item
Field	Box that you use to type in text, or to enter a value with the Keypad or a Multipurpose knob
Check Boxes	Square box that you use to select or clear preferences
Scroll bar	Vertical or horizontal bar at the side or bottom of a display area that is used for moving around in that area
Browse	Displays a window where you can look through a list of directories and files
Command button	Button that initiates an immediate action

Item	Description
Keypad	Appears when you select the box and enter a value
MP / GP knob	Select the multipurpose ( MP or GP ) knob to display a line between the knob and the box; turn the knob on the oscilloscope to select a value

## Basic application functions

### Application directories and file names

The application uses directories to save and recall setup files and uses file name extensions to identify the file type.

The following table lists default directory names.

Directory	Used For
C:\Users\Public\Tektronix\TekApplications\Advanced Power Analysis\Waveforms\	Stores the waveforms used for the tutorial
C:\User\ <current user="">\Tektronix\TekApplicaitons\Advanced Power Analysis\Reports\</current>	Stores the default reports
C:\User\Public\Tektronix\TekApplicaitons\Advanced Power Analysis\SOA Mask\	Stores the SOA mask data as a comma separated value file
C:\User\ <current user="">\Tektronix\TekApplicaitons\Advanced Power Analysis\SwitchingLoss\</current>	Stores the per cycle loss information of Switching loss in csv format

### See also.

[File name extensions](#)

### File name extensions

Extension	Description
.csv	Is a file that uses a “comma separated variable” format
.ini	Is an application setup file
.set	Is an oscilloscope setup file saved and recalled with an .ini file; both the files will have the same file name
.wfm	Is a waveform file that can be recalled into a reference memory
.mht	Is the file format for reports
.jpg	Is the format of the image file of the various plots
.msk	Is the format of the SOA mask file

**Returning to the application**

When you access oscilloscope functions, the oscilloscope fills the display. Access oscilloscope functions in the following ways:

- Choose the Menu on the oscilloscope and access the application
- Push front-panel buttons

## Saving and recalling setups

**Saving a setup**

To save the application state and the oscilloscope settings to a setup file, follow these steps:

1. Select File> Save As> Setup.

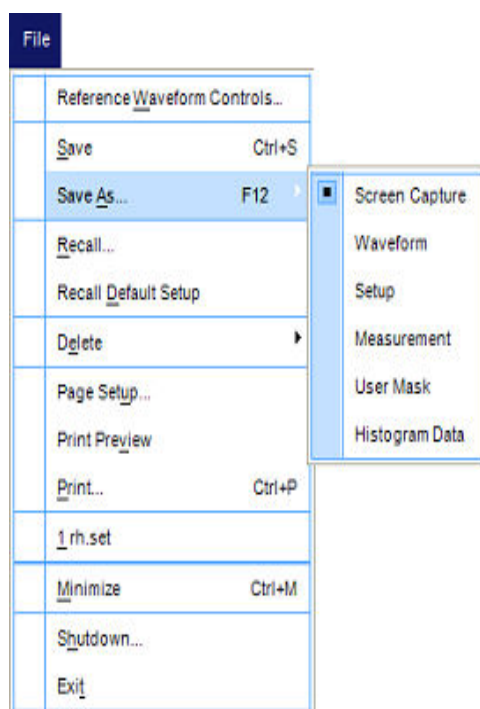

2. Select the Save menu.
3. Select the directory to save the setup file.
4. Select or enter a file name. The application appends an ".xml" extension to the name of setup files.
5. Choose Save.

---

**NOTE.** While saving a Report, the application does not validate for the available size in the drive.

---

### Recalling a saved setup

To recall the application setup and the oscilloscope settings from a saved setup file, follow these steps:

1. Select File> Recall.
2. Select the directory from which you can recall the application settings.
3. Select or enter a file name.

---

**NOTE.** *The application also recalls the oscilloscope setup from a ".xml" file when you recall an application setup.*

---

### Recalling the default setup

To recall the application settings from the Default setup file Select File> Recall Default Setup.

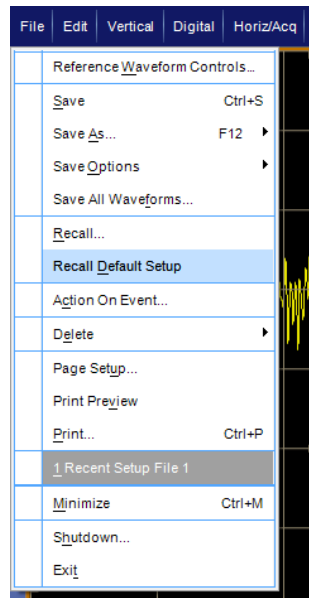

## Utilities

**DeGauss** Degaussing is a mandatory operation for current probes. Every current probe must be degaussed before using it.

Degaussing a current probe requires:

- Current probe jaws should be closed before it is degaussed
- Probe should not be connected to any active point or no signal in the probe

The application checks the DeGauss status of each probe at the beginning of every autoset and the application prompts to degauss the probe if necessary. Select a measurement, and launch the source control window, select the De-Gauss button. This will guide you through the De-Gauss process.

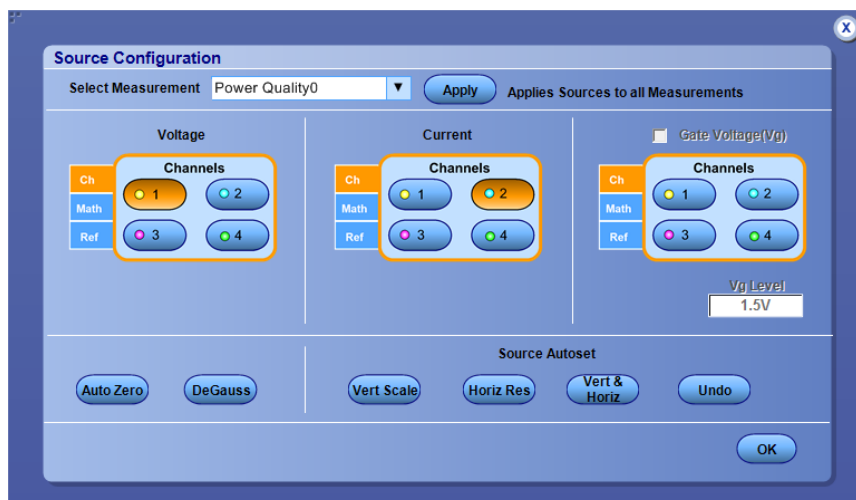

Alternatively, you can do it manually by pressing the degauss button on the current probe.

**Auto Zero** AutoZero is a feature which computes vertical zero-volt error (DC offset) and compensates during acquisition. When AutoZero button is pressed the scope makes acquisitions and measurements, to adjust the offset. AutoZero is useful for voltage probes which are used to measure current.

To perform AutoZero, connect the voltage probe and short the input terminals together.

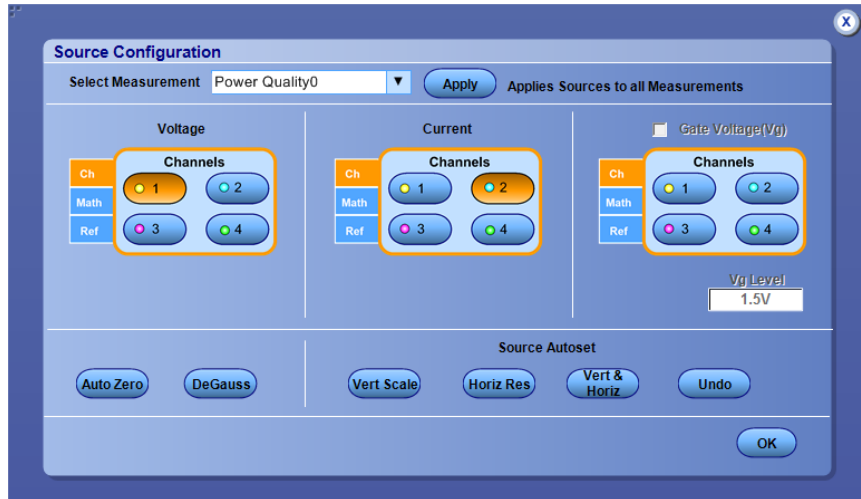

---

**NOTE.** Ensure no input signals are connected to probe tips.

---



---

**NOTE.** Auto Zero is applicable for voltage probes.

---

**Preferences setup**

- Click I-Probe Settings to display TCP, Shunt, Custom and AM503S Settings. Click the TCP button if you are using TCP series probes.

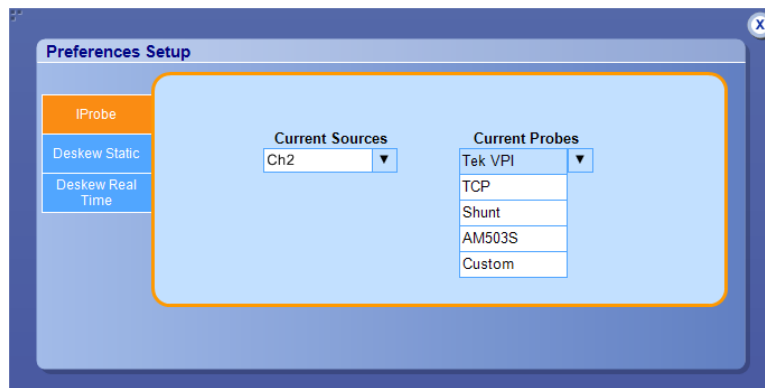

---

**NOTE.** If you are using a TCA-IMEG probe, terminate the input side with 50 Ohms for a current probe that does not automatically change the termination. If you are using a TCA to BNC probe, you do not have to terminate the input side.

---



**Deskew** MSO/DPO5000/B series oscilloscopes: Deskewing Probes and Channels

To ensure accurate results, deskew the probes before taking measurements from your device under test.

The application provides you two deskew options. They are:

- Static deskew
- Real time deskew using TEK-DPG (Deskew Pulse Generator) or an external source

Deskew can be accessed using the Preferences dialog box.

---

**NOTE.** For THDP probes, it is recommended that you use static deskew because of Noise.

---

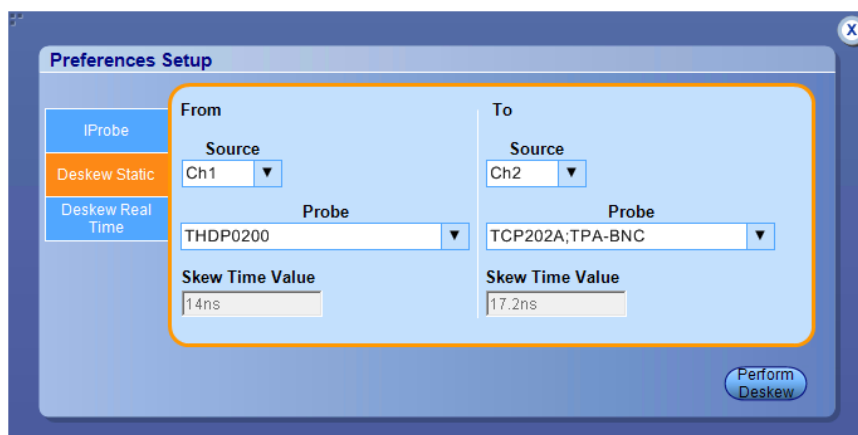

---

**NOTE.** Connect the probes to the fastest transition while using the external signal mode.

---

To deskew a current probe perform these steps:

1. Select the IProbe tab.
2. Select the current sources and probes by selecting the source and probe from the Current Sources and Current Probes drop-down lists.
3. After configuring the current probe, select Deskew Static or Deskew Real Time tab and click Perform Deskew to start the deskew procedure.

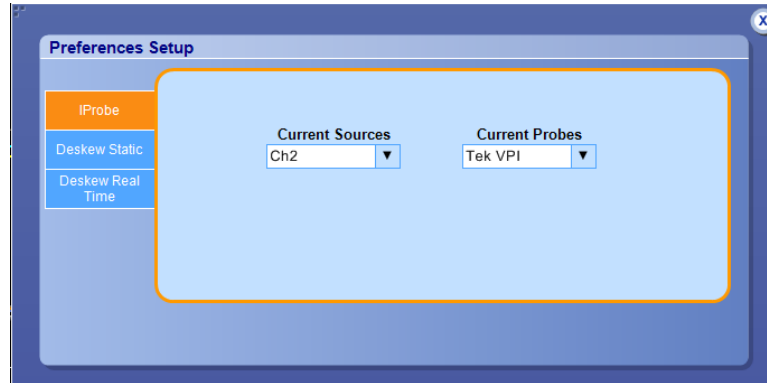

To perform a static deskew perform these steps:

1. Select the Deskew Static tab.
2. Select the To and From sources by selecting the sources from the Source drop-down lists.
3. Select the To and From probes by selecting the probes from the Probe drop-down lists.
4. Click Perform Deskew to start the deskew procedure.

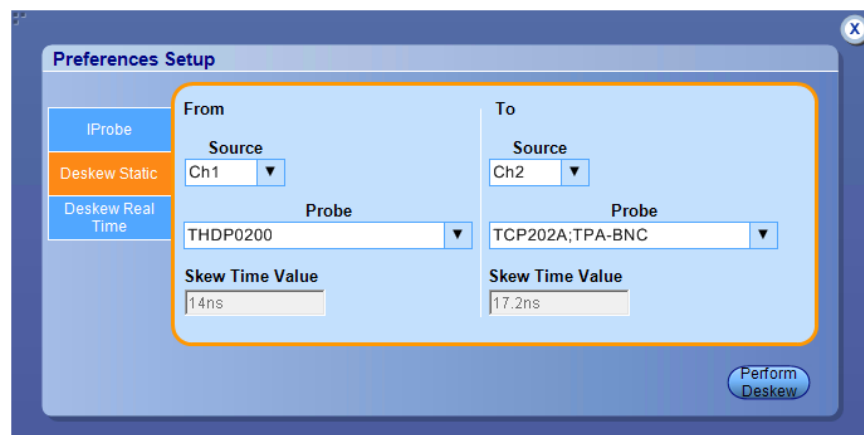

To perform a real time deskew perform these steps:

1. Select the Deskew Real Time tab.
2. Select the To and From sources by selecting the sources from the Source drop-down lists.
3. To change the reference level or hysteresis values, double click the text box and enter the desired value using the pop up keyboard.
4. Select the Slope as either Rise or Fall.
5. Select the Source as Tektronix DeSkew Fixture and Pulse generator (TEK-DPG).
6. Set Ch1 to Voltage, Ch2 to Current.
7. Connect the probe tips to the Deskew fixture, and connect the TEK-DPG to Ch3.
8. Select Output enable on the TEK-DPG probe.
9. Click Perform Deskew to start the deskew procedure.

A popup asks whether you want to do an autoset or not. Click Yes to allow the application to set up the oscilloscope for deskew; click No if you have already set up the oscilloscope and just want to perform deskew.

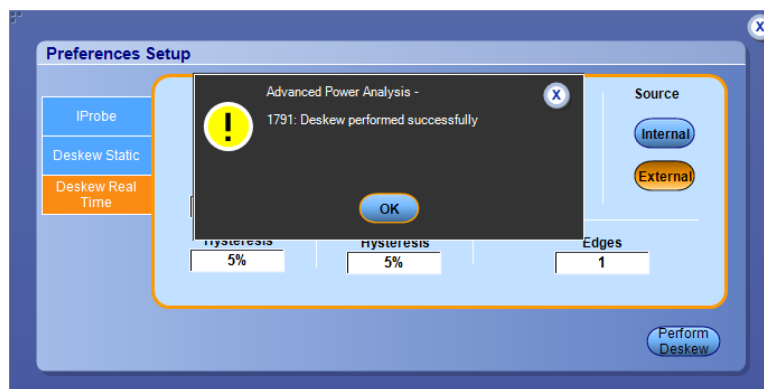

**Deskewing probes and channels**

**Static deskew.** Static deskew automatically sets the deskew based on the probe type supported. The propagation values of the probes are fixed. You do not need an external deskew fixture to deskew the channels.

The application supports the following combination between any two-channel probes for DPO/DSA7000C, MSO/DPO5000/B, MSO/DSA/DPO70000C, DPO/DSA70000D, and MSO/DPO/DSA70000DX series oscilloscopes:

Probe Model	Skew in ns
AM503B w/ A6302	30.1
AM503B w/ A6303	55.0
AM503B w/ A6312	30.1
AM503B w/ A6302XL	60.3
AM503B w/ A6303XL	105.0
AM503B w/ A6304XL	105.0
P5050	5.5
P5050B	6.0
P5100	14.9
P5100A	6.0
P5200	20.0
P5200A	21.0
P5202A	18.0
P5205	17.3
P5205A	18.0
P5210	20.3
P5210A	18.0
P6015A (10 ft)	14.7
P6015A (25 ft)	33.3
P6021A	9.0
P6131 (1.3 m)	6.3
P6131 (2 m)	9.1
P6138A	6.3
P6139A	6.3
P6139B	6.0
P6158	5.0
P6243	5.3
P6245	5.3
P6246	7.7
P6247	7.3
P6248	6.8
P6250	6.5
P6251	6.5

Probe Model	Skew in ns
TAP1500	5.3
TAP2500	5.3
TCP0020	16.6
TCP0030	14.6
TPP1000	5.67
TCP0030A	14.5
TCP0150	21.0
TCP202	17.3
TCP202A	17.2
TCP2020	17.0
TCP202A;TPA-BNC	17.2
TCPA300 w/ TCP303	40.0
TCPA300 w/ TCP303 + TPA-BNC	40.3
TCPA300 w/ TCP305	19.0
TCPA300 w/ TCP305 + TPA-BNC	19.3
TCPA300 w/ TCP305A	19.0
TCPA300 w/ TCP305A + TPA-BNC	19.3
TCPA300 w/ TCP312	17.0
TCPA300 w/ TCP312 + TPA-BNC	17.3
TCPA300 w/ TCP312A	17.0
TCPA300 w/ TCP312A + TPA-BNC	17.3
TCPA400 w/ TCP404XL	80.0
TCPA400 w/ TCP404XL + TPA-BNC	80.3
TDP0500	6.5
TDP1000	6.5
TDP1500	5.4
TDP3500	5.3
TekVPI TCP0030	14.6
TekVPI TAP1500	5.3
TekVPI TAP2500	5.3
TekVPI TPA-BNC	0.25
THDP0100	16.0
THDP0200	14.0
TMDP0200	14.0
TPP0500	5.3
TPP0500B	5.3
TPP0502	5.3
TPP0850	6.1

Follow these steps to perform the Static Deskew:

1. Select Analyze> Advanced Power Analysis, and then select Preferences.
2. Click the Deskew Static tab.
3. In the From panel, select the Source and the corresponding Probe type.
4. In the To panel, select the Source and the corresponding Probe type.

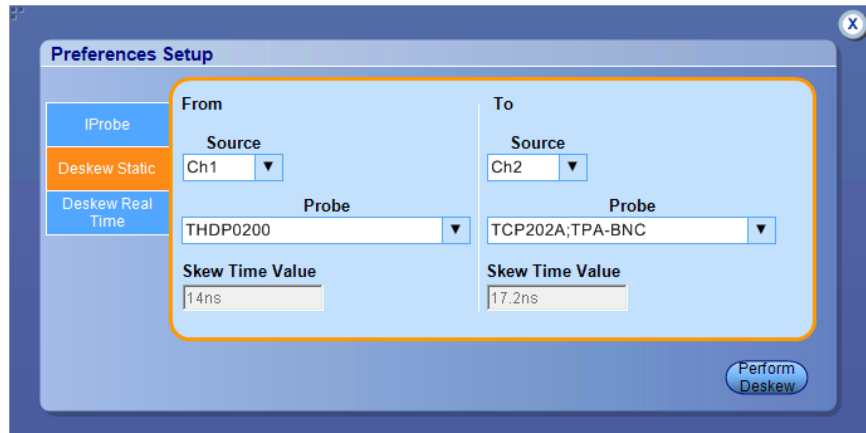

5. Click Perform Deskew to deskew the selected probe.

---

**NOTE.** Static deskew is performed between any two channels of your choice. Retain the From panel parameters and change the To panel parameters to perform deskew for more than two channels. If you are using a Custom probe, the application adjusts the deskew and sets the value when you perform static deskew.

---

**DPO70000 series oscilloscopes.** DPO/DSA7000C, MSO/DSA/DPO70000C, DPO/DSA70000D, and MSO/DPO/DSA70000DX series oscilloscopes.

Use the Aux Output signal (DPO7000C) and the Deskew fixture (Tektronix part number: 067-1686-XX) to deskew the probes and channels.

Follow these steps to deskew with an internal source:

1. Connect the AUX OUT of the oscilloscope to the B side input of the deskew fixture to deskew the voltage probe and current probe.
2. Follow the instructions for the Probe Calibration and Deskew fixture to make the connections.
3. Set up the oscilloscope as follows:
  - Use the Horizontal Scale knob to set the oscilloscope to an acquisition rate so that there are two or more samples on the deskew edge.
  - Use the Vertical Scale and Position knobs to adjust and display the signals on the screen.
  - Set the Record Length so that there are more samples for the edges in the acquisition. It is recommend that you set the record length to 25000 points.
4. To start the application, select Analyze > Advanced Power Analysis, and then select Preferences.
5. Select the Deskew Real Time tab. Click the Internal Source button in the Source panel.
6. In the From panel, set the Source to Ch1. The remaining channels are deskewed to the Source waveform, which is the reference point.
7. In the To panel, set the Source to Ch2, the channel to be deskewed.
8. To start the deskew utility, click the Perform Deskew button and confirm the operation.

- Use Ch1 as the reference point and deskew the remaining channels. The following figure shows a waveform before and after deskew.

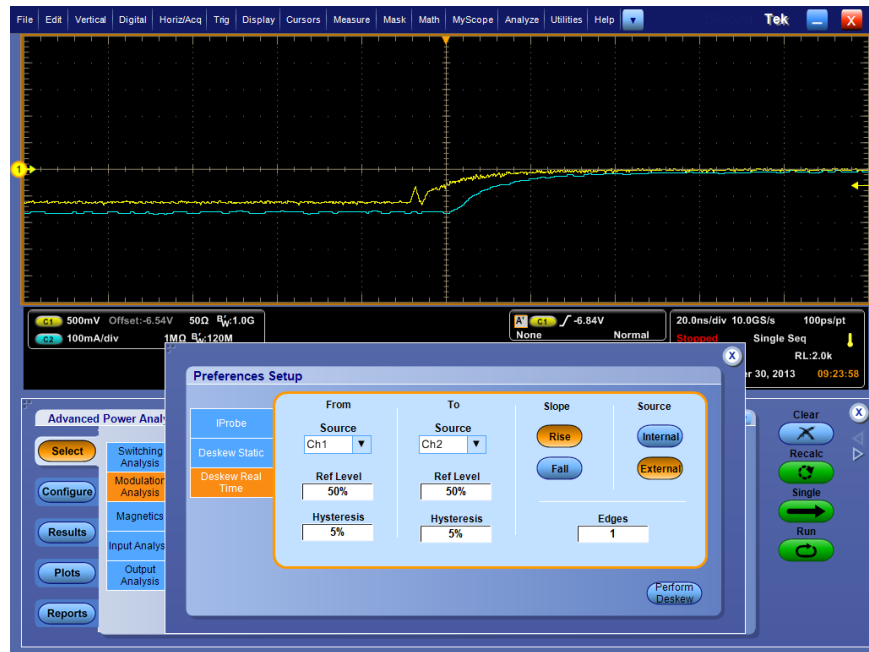

Figure 1: Waveform before deskew

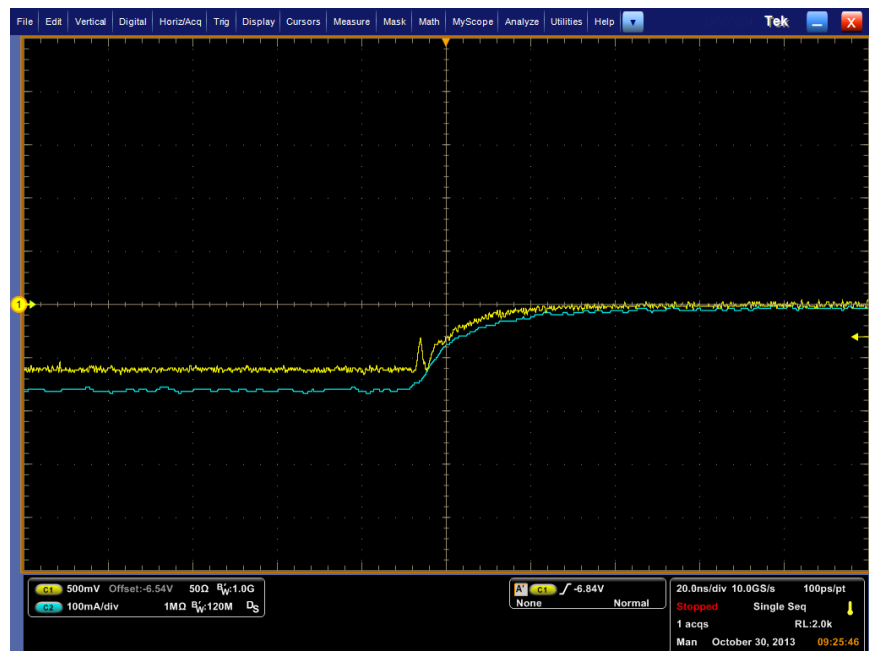

Figure 2: Waveform after deskew

- Only 1 edge is displayed on the screen, and you can see that the skew has been removed.



---

**NOTE.** *The oscilloscope setup is saved before deskew and recalled after deskew. If the acquisition setup is in Stop condition before saving the setup, the setup with the stop condition is recalled. When deskew recalls this setup, the application does not display the waveform. To view the waveform, push the Run or the Stop button in the oscilloscope application.*

---

**See also.**

[Static deskew](#)

[Deskewing using a power deskew fixture](#)

**Deskewing using a power deskew fixture.** The Power Measurements Deskew Fixture with Tektronix part number (067-1686-XX), supports up to 150 A AC/DC current probes.

Follow these steps to deskew:

- Connect the AUX OUT of the oscilloscope to the J1, J2 ( Cal signal input) input of the deskew fixture to deskew the voltage probe and current probe.
- Follow the steps 2-10 in the topic Deskewing in DPO/DSA7000C, MSO/DSA/DPO70000C, DPO/DSA700000D, and MSO/DPO/DSA70000DX series oscilloscope to complete the procedure.



---

# Advanced power measurement and analysis

## Setting up DPOPWR to take measurements

**Setting up the software**     Setup the application to view waveform analysis results in table format. You can also view the results in 2D plot format or save as report for later analysis.

The following are the categories of measurements. Click the link for measurements in that category:

1. [\*Switching analysis\*](#)
2. [\*Timing analysis\*](#)
3. [\*Magnetics\*](#)
4. [\*Input analysis\*](#)
5. [\*Output analysis\*](#)
6. [\*Amplitude\*](#)

**Table of options-Source configuration**

Area	Option	Description
Source selection panel	Current (I) Voltage (V) Gate Voltage(Vg)	<p>Current Source</p> <ul style="list-style-type: none"> <li>■ Select Ch1-Ch4 for live waveform</li> <li>■ Select Ref1- Ref4 for the Ref waveform</li> </ul> <p>Voltage Source</p> <ul style="list-style-type: none"> <li>■ Select Ch1-Ch4 for live waveform</li> <li>■ Select Math1- Math4 for the Ref waveform</li> </ul> <p>Gate Voltage</p> <ul style="list-style-type: none"> <li>■ Select Ch1-Ch4 for live waveform</li> <li>■ Select Math1- Math4 for the Ref waveform</li> </ul> <p>Gate selection is applicable for the selected measurements. It will sync with gate or edge source selection under the configuration of the selected measurements.</p> <hr/> <p><b>NOTE.</b> Availability of Ch3, Ch4, Ref3, Ref4 depends on the oscilloscope.</p>

**Table of measurements and configurations-Switching analysis.**

Measurement	SubType/Configurations	Description
<b>Switching Analysis</b>		
Switching Analysis		Analyzes the power dissipated in the switching cycles across a switching device.
Switching Loss		Measures the instantaneous minimum and maximum average energy consumed across the switching device. The loss is measured on each cycle of the acquired waveform. The results include minimum, maximum and the average loss and energy for the complete cycles in a single record.
	Type	PWM Type Device PFC Type <sup>1</sup>
	OnOffLevel	Autocalc loss without Vg Units Device V-Level I-Level Math Destination
	Options	Units Ref Level Hysteresis Filter Current Signal Condition Log Switching Cycles
	Global	Coupling BW Limit Cursor Gating Acquisition Mode

<sup>1</sup> Acquires atleast one cycle of input line frequency and turns on cursor gating.

Measurement	SubType/Configurations	Description
Hi-Power Finder		Hi Power Finder analyzes the power loss in switching components, ensuring that the instantaneous power remains within the specified limits.
	PWMType	Fixed Variable
	OnOffLevel	Units Device V-Level I-Level Math Destination
	Edges	Units Ref Level Hysteresis Filter Current
	Global	Coupling BW Limit Cursor Gating Acquisition Mode
Safe Operating Area (SOA)		Plots the Voltage and Current waveform in a single record in XY mode. The Enable mask check box is enabled only for SOA Normal. Use the Mask Editor to apply the mask to the SOA Plot only for SOA Normal option.
	Mask Editor	Enable X Co-ord. Y Co-ord. Add Update Clear Clear All Save Recall Graph Preview
	Global	Coupling BW Limit Cursor Gating Acquisition Mode
SOA X-Y (DPX)		Sets up the oscilloscope in XY mode with infinite persistence for the voltage and current waveforms.
RDS(on)	Method	V/I dV/dI
	Global	Coupling BW Limit Cursor Gating Acquisition Mode

Measurement	SubType/Configurations	Description
dv/dt	Measures the differentiation of the voltage dv/dt	
	Options	Units Ref Level Hysteresis Ref High Ref Low
	Global	Coupling BW Limit Cursor Gating Acquisition Mode
di/dt	Measures the differentiation of the current di/dt	
	Options	Units Ref Level Hysteresis Ref High Ref Low
	Global	Coupling BW Limit Cursor Gating Acquisition Mode

**Table of measurements and configurations-Timing analysis**

Measurement	SubType/Configurations	Description
<b>Modulation Analysis</b>		
Pulse Width	Is a trend plot of the pulse width variation for the acquired waveform. It is the time difference between the leading and the trailing edge of a pulse.	
	Edges	Polarity <ul style="list-style-type: none"> <li>■ Positive</li> <li>■ Negative</li> </ul>
	Options	Units Ref Level Hysteresis
	Global	Coupling BW Limit Cursor Gating Acquisition Mode

Measurement	SubType/Configurations	Description
Period		Is a trend plot of the variation of the period measured from a leading edge to a leading edge or a trailing edge to a trailing edge.
	Edges	Edge Type <ul style="list-style-type: none"> <li>■ Rise</li> <li>■ Fall</li> </ul>
	Options	Units Ref Level Hysteresis
	Global	Coupling BW Limit Cursor Gating Acquisition Mode
Duty Cycle		Measures the duty cycle of the waveform and is a trend plot. The duty cycle can be a positive or a negative duty cycle.
	Edges	Edge Type <ul style="list-style-type: none"> <li>■ Rise</li> <li>■ Fall</li> </ul>
		Polarity <ul style="list-style-type: none"> <li>■ Positive</li> <li>■ Negative</li> </ul>
	Options	Units Ref Level Hysteresis
Global	Coupling BW Limit Cursor Gating Acquisition Mode	
Frequency		Is a trend plot of the variation of the frequency of the signal.
	Edges	Edge Type <ul style="list-style-type: none"> <li>■ Rise</li> <li>■ Fall</li> </ul>
	Options	Units Ref Level Hysteresis
	Global	Coupling BW Limit Cursor Gating Acquisition Mode
<b>Time Analysis</b>		



Measurement	SubType/Configurations	Description
Skew	The Skew measurement calculates the difference in time between the designated edge on a principle waveform to the designated edge on another waveform.	
	Edges	From Edge <ul style="list-style-type: none"> <li>■ Rise</li> <li>■ Fall</li> <li>■ Both</li> </ul> To Edge <ul style="list-style-type: none"> <li>■ Same as From</li> <li>■ Inverse of From</li> </ul>
	Options	Units Ref Level Hysteresis
	Global	Coupling BW Limit Cursor Gating Acquisition Mode

**Table of measurements and configurations-  
Magnetics**

Measurement	SubType /Configurations	Description
Inductance	Edges	Edge Source
	Options	Units Ref Level Hysteresis
	Global	Coupling BW Limit Cursor Gating Acquisition Mode

Measurement	SubType /Configurations	Description
Magnetic Property	Source	Voltage Source Freq and Duty <ul style="list-style-type: none"> <li>■ Fixed</li> <li>■ Variable</li> </ul>
	Physical Chars1	Units Cross Section Area Magnetic Length
	Physical Chars2	Primary Winding: <ul style="list-style-type: none"> <li>■ Single</li> <li>■ Multiple</li> </ul> # of Turns (Primary Winding) Secondary Windings: <ul style="list-style-type: none"> <li>■ # of Winding                             <ul style="list-style-type: none"> <li>■ Two</li> <li>■ More</li> </ul> </li> <li>■ Magnetizing Current</li> <li>■ Winding1 Source:                             <ul style="list-style-type: none"> <li>■ # of Turns</li> </ul> </li> <li>■ Winding 2 Source:                             <ul style="list-style-type: none"> <li>■ # of Turns</li> </ul> </li> </ul>
	Options	Units Ref Level Hysteresis
	Global	Coupling BW Limit Cursor Gating Acquisition Mode
Magnetic Loss	Global	Coupling BW Limit Cursor Gating Acquisition Mode
I vs $\int V$	Plots the integral of the voltage waveform and the current waveform in a XY plot. Integral of V is proportional to B and the current waveform I is proportional to H.	
	Global	Coupling BW Limit Cursor Gating Acquisition Mode

**Table of measurements and configurations-Input analysis**

Measurement	SubType / Configurations	Description
Select input analysis		
Power quality	Measures the effects of distortions caused by nonlinear loads, including the power supply itself.	
	Global	Coupling BW limit Cursor gating Acquisition mode
Current harmonics	Captures the predefined limit values for the harmonics. This will be used to compare the measured value of the harmonics.	
	Standard	Type <ul style="list-style-type: none"> <li>■ 61000-3-2</li> <li>■ AM - 14</li> <li>■ MIL 1399</li> </ul>
		Line Frequency <ul style="list-style-type: none"> <li>■ Auto: Calculates input signal frequency automatically.</li> <li>■ 50 Hz</li> <li>■ 60 Hz</li> <li>■ Custom: User is allowed to set the Line frequency in range 1 Hz to 4000 Hz using numerical keypad.</li> </ul>
		Harmonics Order <ul style="list-style-type: none"> <li>■ For 61000-3-2 and AM 14 type, range is 40 to 100 harmonics.</li> <li>■ For MIL 1399, range is 50 to 100 harmonics.</li> </ul>
	I-Probe impedance	Impedance table
		Edit
	Harmonics	Class
		Harmonic
Edit		
Input power		
Power factor		
Filter check box		
Global	Fundamental current	
	Coupling BW limit Cursor gating Acquisition mode	

Measurement	SubType / Configurations	Description
Voltage harmonics	Captures the predefined limit values for the harmonics. This will be used to compare the measured value of the harmonics.	
	Line Frequency	<ul style="list-style-type: none"> <li>■ Auto: Calculates input signal frequency automatically.</li> <li>■ 50 Hz</li> <li>■ 60 Hz</li> <li>■ Custom: User is allowed to set the Line frequency in range 1 Hz to 4000 Hz using numerical keypad.</li> </ul>
	Global	Coupling BW limit Cursor gating Acquisition mode

Measurement	SubType /Configurations	Description
Total Power Quality	Measures and displays: <ul style="list-style-type: none"> <li>■ RMS value of the current and voltage</li> <li>■ True power</li> <li>■ Apparent power</li> <li>■ Crest factor of current and voltage, Current harmonics</li> <li>■ Reactive Power</li> <li>■ Power factor</li> <li>■ Total harmonic distortion</li> </ul> It is a combination of Power Quality and Current Harmonics measurement.	
	Standard	Type <ul style="list-style-type: none"> <li>■ 61000-3-2</li> <li>■ AM - 14</li> <li>■ MIL 1399</li> </ul> Line Frequency <ul style="list-style-type: none"> <li>■ Auto: Calculates input signal frequency automatically.</li> <li>■ 50 Hz</li> <li>■ 60 Hz</li> <li>■ Custom: User is allowed to set the Line frequency in range 1 Hz to 4000 Hz using numerical keypad.</li> </ul>
	I Probe	The impedance of the current probe and the frequency can be edited in this table and is used to calculate the current harmonics value. In the default state, I-probe is not enabled. Impedance table Edit
	Harmonics Table	Class Harmonic Edit Input Power Power Factor Filter check box Fundamental Current
	Global	Coupling BW Limit Cursor Gating Acquisition Mode

Measurement	SubType /Configurations	Description
In Rush Current		Measures both positive and negative peaks of inrush current for a switching power supply during in-circuit operation.
	Options	Units Ref Level Hysteresis Peak (Amps)
	Global	Coupling BW Limit Cursor Gating Acquisition Mode
Input Capacitance		Measures capacitance above Ref Level using input current and voltage for switching power supply during in-circuit operation.
	Options	Units Ref Level Hysteresis Peak (Amps)
	Global	Coupling BW Limit Cursor Gating Acquisition Mode

Table of measurements and configurations-Output analysis

Measurement	SubType /Configurations	Description
<b>Select Output Analysis</b>		
Line Ripple		Measures the amount of AC-output signal related to the input line frequency
	Line Ripple Freq	Measures the: <ul style="list-style-type: none"> <li>■ AC component voltage present on a DC.</li> <li>■ Low frequency AC voltage in the peak-to-peak voltage.</li> </ul> 50 Hz 60 Hz 400 Hz
	Global	Coupling Bandwidth Limit Cursor Gating Acquisition Mode
Switching Ripple		Measures the maximum AC voltage present on a DC
	Ripple Freq	Switching Ripple Frequency
	Global	Coupling BW Limit Cursor Gating Acquisition Mode

Measurement	SubType /Configurations	Description
<b>Select Spectral Analysis</b>		
Spectral Analysis		Analyzes, measures and displays the frequency component in a signal based on the selected Start, Stop and RBW values.
	Spectral Config	Frequency Start Frequency Stop Window Type Res BW Update Auto Setup DC Block Log Results Filter type (POE Specific Filter) : <ul style="list-style-type: none"> <li>■ PoE 500 Hz</li> <li>■ PoE 500 Hz-150 KHz</li> <li>■ PoE 150 KHz-500 KHz</li> <li>■ PoE 500 KHz- 1 MHz</li> </ul> Filter Source
	Global	Coupling BW Limit Cursor Gating Acquisition Mode

Measurement	SubType /Configurations	Description
Turn On Time		Measures the time delay difference between the input voltage applied to the system and the time to develop the steady state output voltage.
	Input	Convertor DC-DC AC-DC Frequency Source Maximum Voltage Trigger Level Max Turn on Time
	Output	Source1 On Off Max Voltage Source2 On Off Max Voltage Source3 On Off Max Voltage
	Global	Coupling BW Limit Cursor Gating Acquisition Mode

Table of measurements and configurations- Amplitude

Measurement	SubType /Configurations	Description
High Low High-Low	Edge	Measure the Center X% of the signal Methods
	Options	Units Ref Level Hysteresis
	Global	Coupling BW Limit Cursor Gating Acquisition Mode



Measurement	SubType /Configurations	Description
Cycle Min Cycle Max Cycle Pk-Pk	Signal Type	AC DC
	Options	Units Ref Level Hysteresis
	Global	Coupling BW Limit Cursor Gating Acquisition Mode

## Taking a new measurement

### About taking measurements

To take measurements:

1. Connect the required voltage and the current probe to the DUT.
2. Set the Current source and the Voltage source on the Source Configuration panel.
3. Select and run the measurements to view the acquired waveform results. You can also view the results in 2D plot format or save as report for later analysis.



**WARNING.** When connecting to a circuit with hazardous voltages, see the warnings for the individual products and verify that the probes and other components used are within their ratings. Also refer to the for more information.

**NOTE.** When you run any measurement, select Real Time Sampling Mode.

### Viewing results

Summary result and detailed result are displayed for successfully completed measurement. Select Results > Detailed to view detailed result. The details displayed vary for the measurements.

Select the Detailed Results tab to view details of the results. Details vary depending on the displayed measurements.

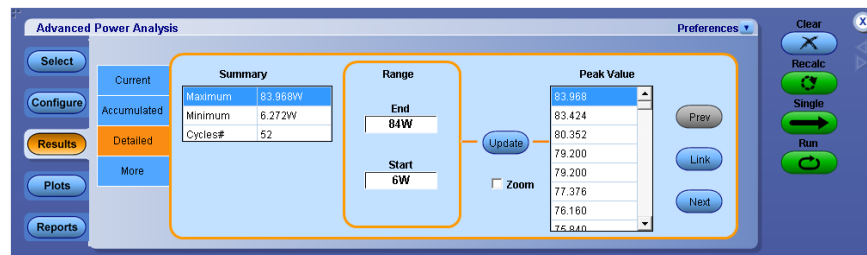

Summary results can be current and accumulated. Current shows the results for the current acquisition. Accumulated shows the statistics of all acquisitions (previous and current). Select the Accumulated tab to view the summary of the measurement.

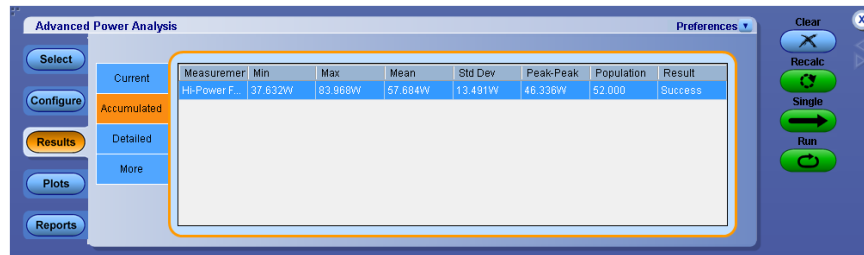

The application displays the statistics for selected measurements in the results menu. The statistics displayed are the following:

- **Max:** The maximum value calculated using  $\text{Max}(X) = \text{Most Positive Value of } X$ .
- **Min:** The minimum value calculated using  $\text{Min}(X) = \text{Most Negative Value of } X$ .
- **Mean:** The mean value calculated using the following equation:

$$\text{Mean}(X) = X_{\text{mean}} = \frac{1}{N} \sum_{n=1 \text{ to } N} X_n$$

- **Std Dev** The standard deviation value calculated using the following equation:

$$\text{StdDev}(X) = \sqrt{\frac{1}{N-1} \sum_{n=1 \text{ to } N} X - X_{\text{mean}}}$$

- **Peak-Peak:** . The peak to peak value calculated using the following equation:

$$p - p(X) = \text{Max}(X) - \text{Min}(X)$$

- **Population.** Population is the total number of events or observations over which the other statistics were calculated. The Population (X) will represent the number of cycles of the waveform, and for measurements where cycles are not meaningful, Population shows as number of acquisitions.
- **Result.** This field indicates whether the measurement is success or fail. If there was any error during the analysis, then fail is displayed. When the measurement is in RUN state, Not Available is displayed and changes to Success or Failure depending on the measurement outcome.

**NOTE.** Modifying the configuration clears the previously calculated results in table.

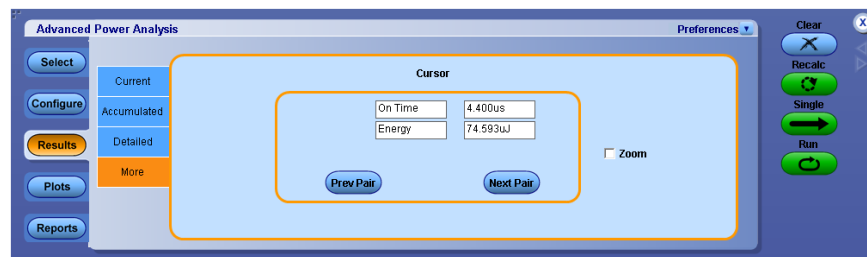

Select the More tab to view additional measurement results. The details displayed vary for the measurements.





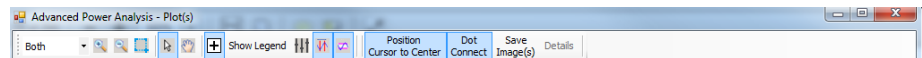

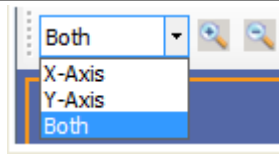

### Plot components and features

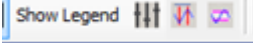
Use the plots menu bar to control plot details and features.

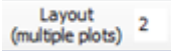

Menu item	Description
	Select X or Y or both axes to enable the zoom in and zoom out of the selected axis.
	Reset the plot window to the initial state.
	Use hand option to pan the plot window and move around the displayed waveform.
Position Cursor to Center	Moves the plot cursors to the center of the display area.

Menu item	Description
	Set Plot cursors as horizontal, vertical, or both. Show Legend will display the cursor position.
	Connects the plot data points using linear interpolation.
	Saves the plot image in .png format. The default directory is C:\Users\ <users&gt;\tektronix\tekapplications\advanced analysis\images\<="" power="" td=""> </users&gt;\tektronix\tekapplications\advanced>
	Displays additional details about the plot like traversing between peaks, different vertical scale.
 2  	If there is more than one plot, the Layout button is enabled. Use the Summary Layout to arrange the plots either horizontally or vertically. A maximum of 4 plots are displayed at a time

**Plot view.** When you have multiple plots, select either a Grid and Flow view from the Layout (multiple plots) view selector.

**Multiple plot options.**

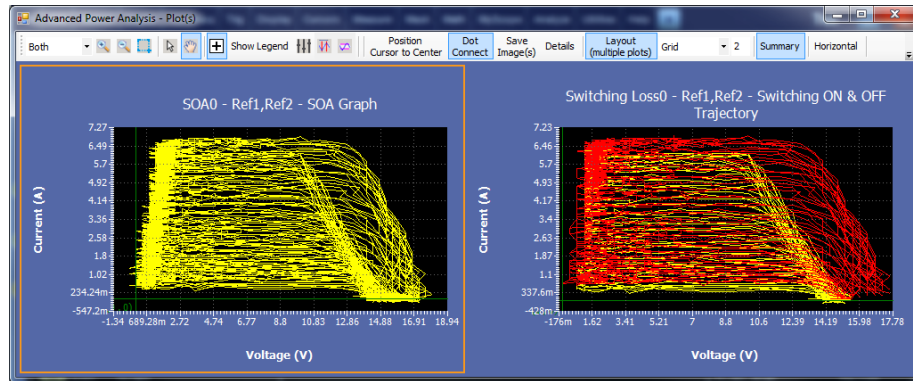

**Multiple plot options.**

**Grid view.** Multiple plots can viewed and compared simultaneously. Grid view is recommended to view and compare plots side by side. By default Grid view is selected. The number adjacent to Grid specify the number of plots to display side by side for each row. The maximum number allowed is 4.

- Grid 1 (1\*1): Displays one plot in row.

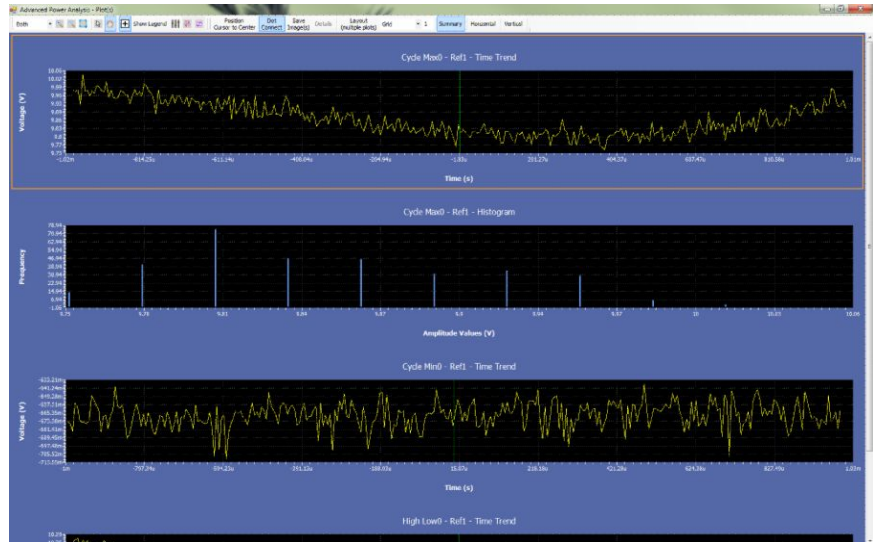

- Grid 2 (1\*2): Displays two plots side by side in row.

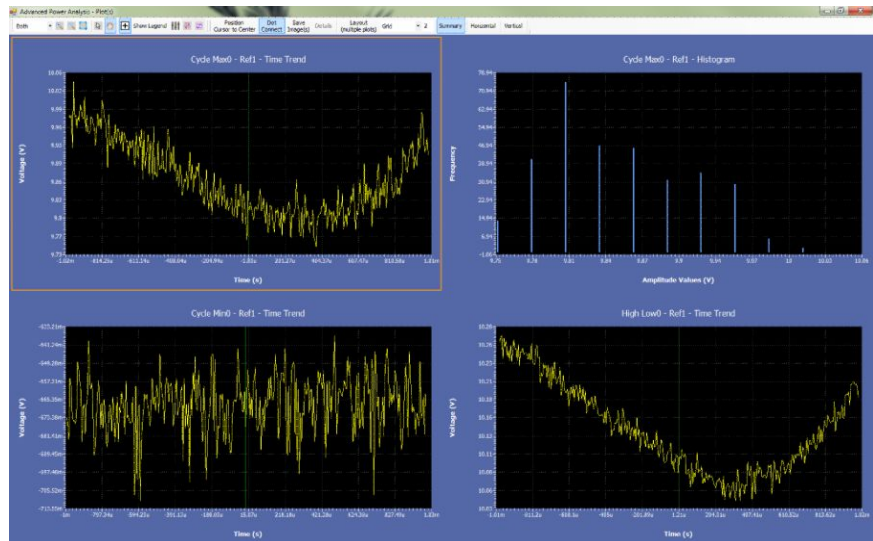

- Grid 3 (1\*3): Displays three plots side by side in row.

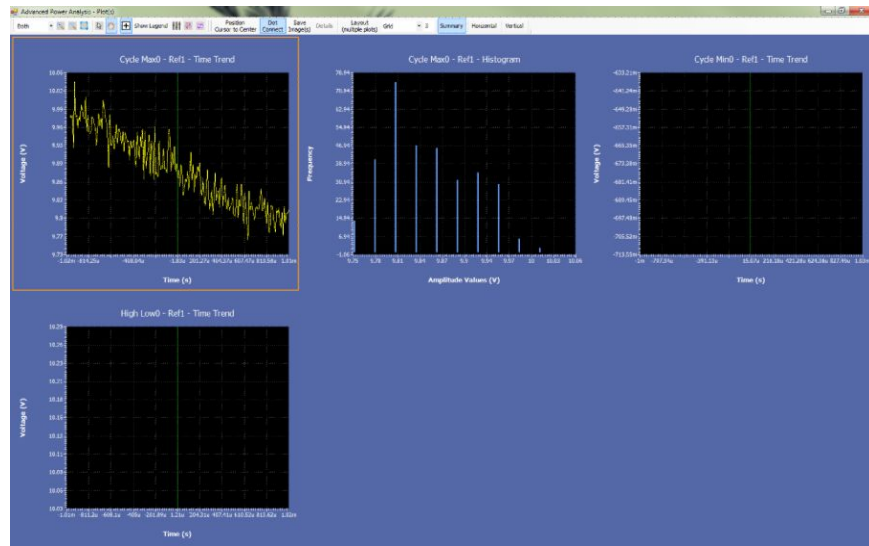

- Grid 4 (1\*4): Displays four plots side by side in row.

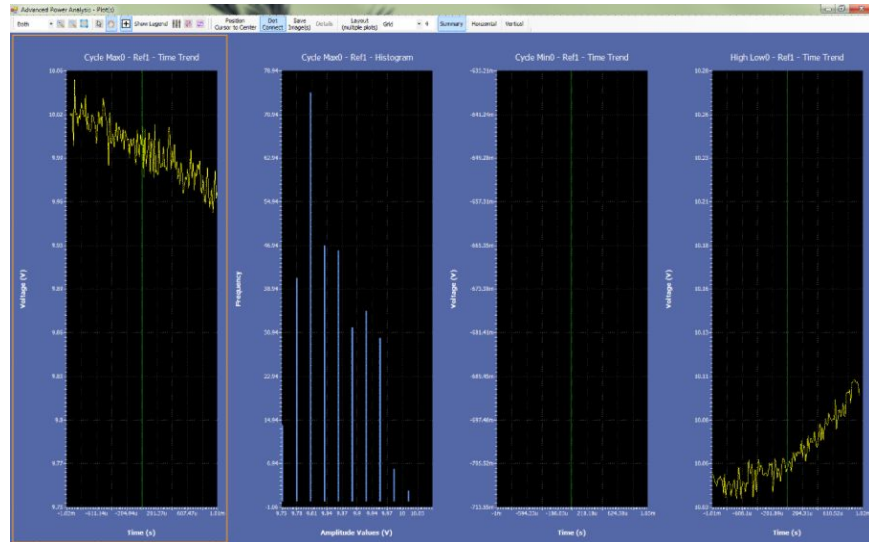

**Flow view.** The plot window arranges plots based on the size. By default plots are aligned in single row. You can adjust the size of the plot window to change the configuration to see the selected plots. For example below Flow view displays four plots arranged in single row (4\*1). Flow view is useful to view one plot at a time.

**Flow view.**

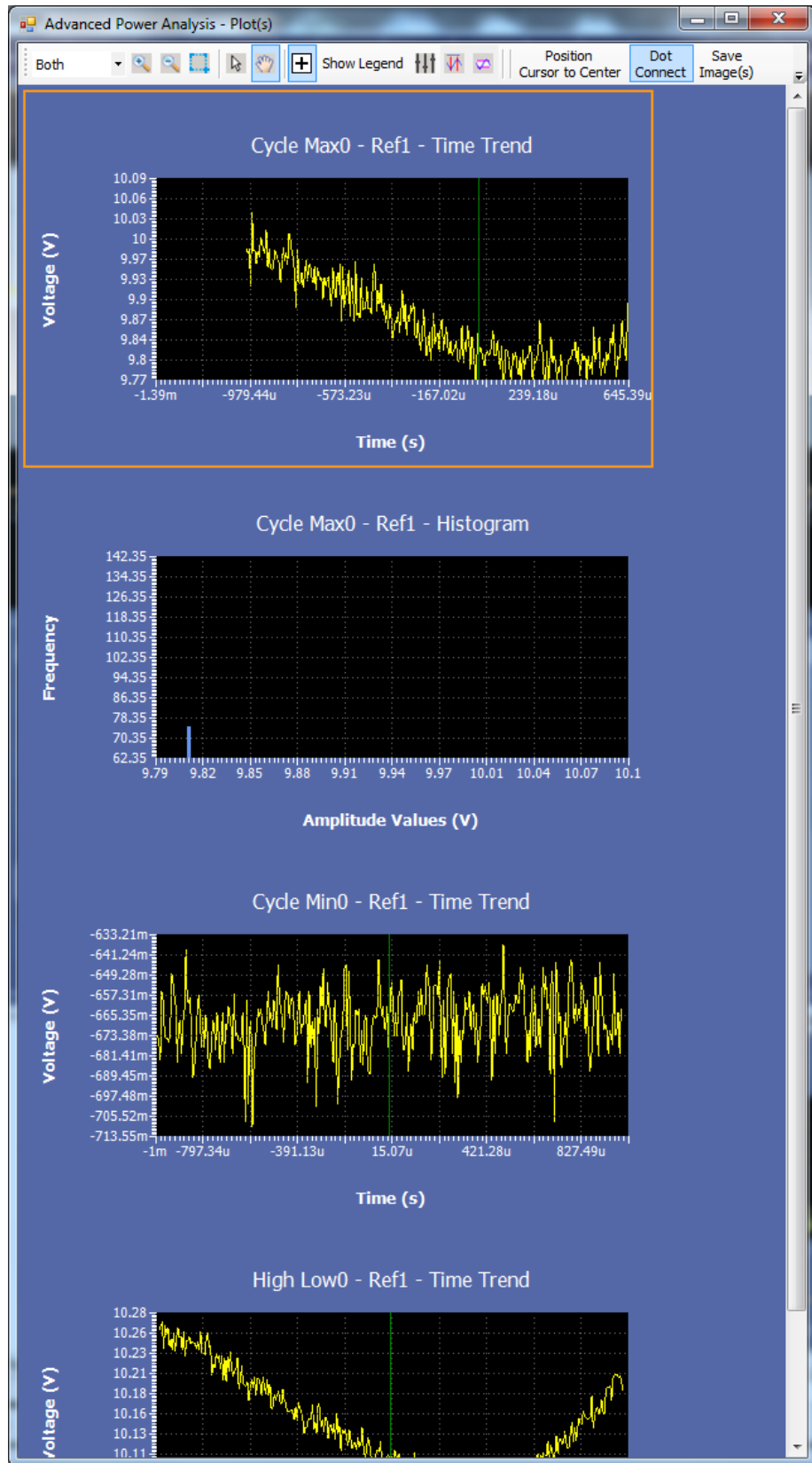



Flow view.

Viewing plots

Successful completion of measurements generate plots. Select Analysis > Advanced Power Analysis, and then select the Plots navigation tab to configure and view the plots for the selected measurements.

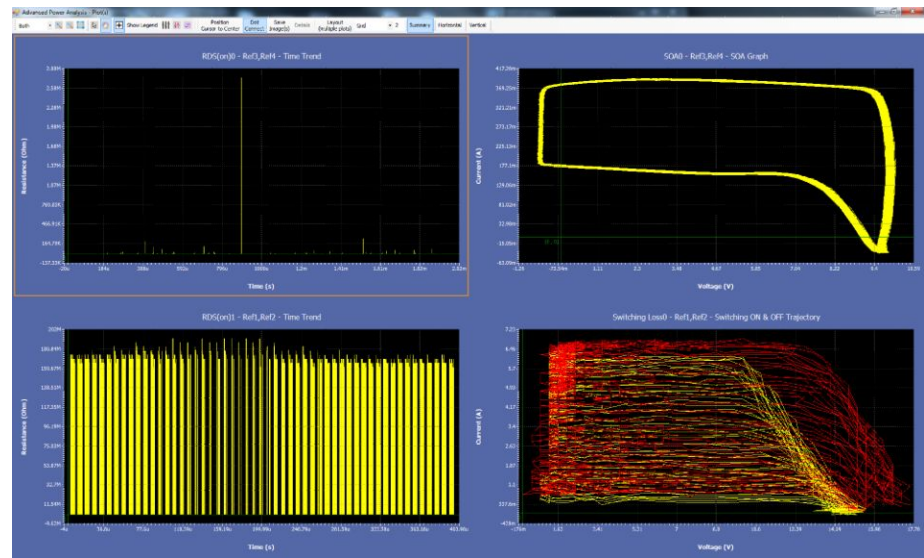

**NOTE.** A maximum of four plots can be added, and they are displayed in a single window. Double-clicking the plot will toggle between full screen and compact size. See [Plot components and features](#) for additional details.

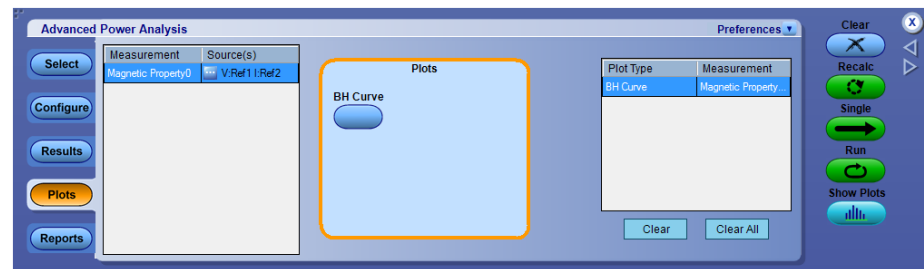

Click Plot button to add the plot to the plots table. Click Clear button to remove the selected plot and click Clear All to remove all plots from the table. Click Show Plots button to display the plots.

A Magnetic BH Curve plot is shown in this example.

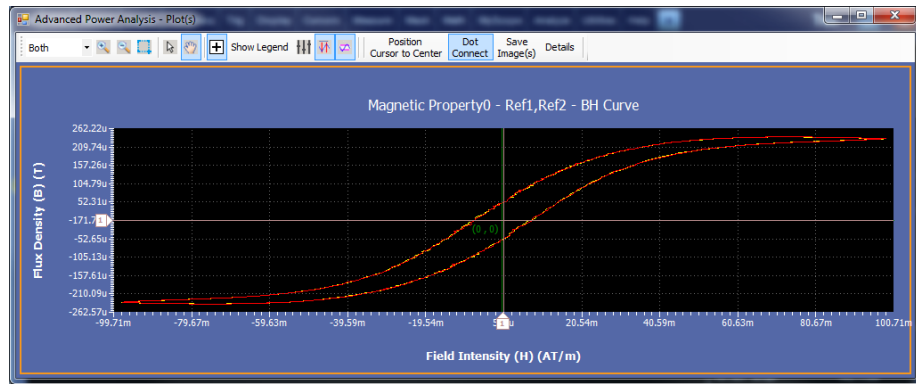

Double click the plot to show added detailed results. Click a point on the plot to show detail for that point.

**NOTE.** The plot operation may become slow with higher record length updates. Do not perform any operation on the application user interface during record length updates. During FREE RUN, the application uses large amount of plot data for longer record lengths. To stop the FREE RUN, Click Stop on the RUN/ STOP button of the oscilloscope. Continue sequencing by pressing the RUN.

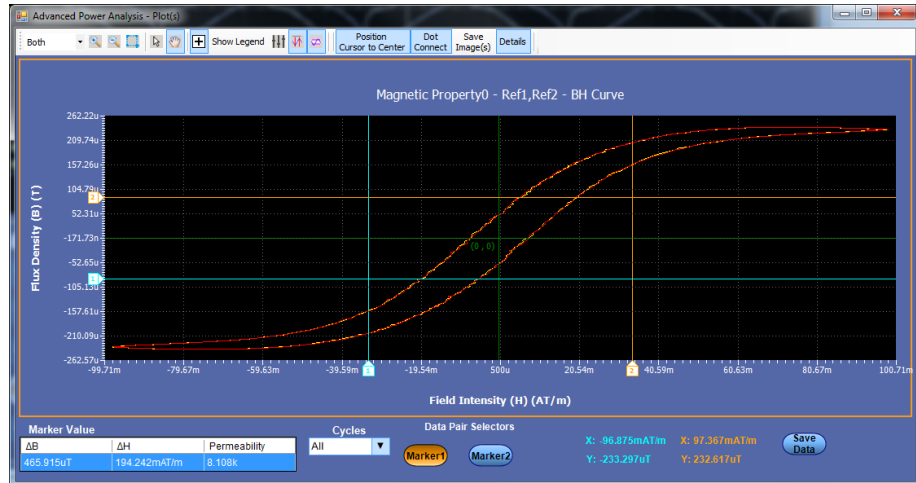

**Plot autoscale.** By default, the plots will autoscale based on the selected mask range. For example, if a mask violation happens, then only the region of violation is shown when the plot is displayed. To view the complete data on the plot window, click the Reset button in the plot tool box.

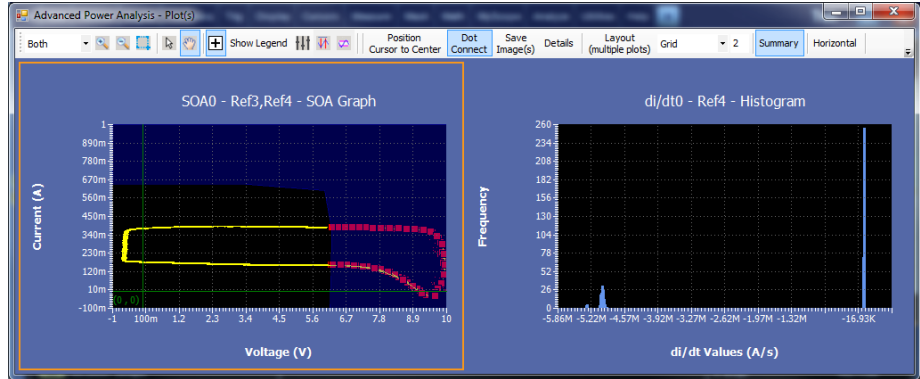

Figure 3: Plot with violation

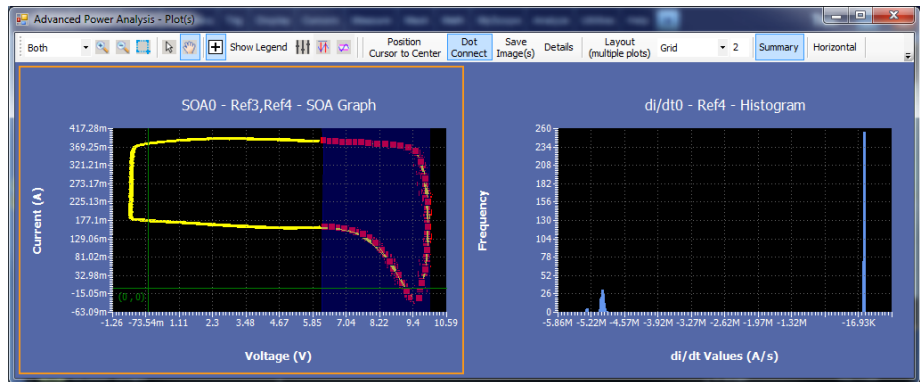
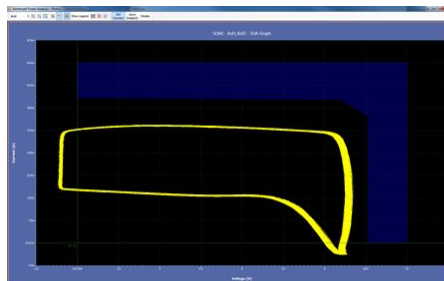
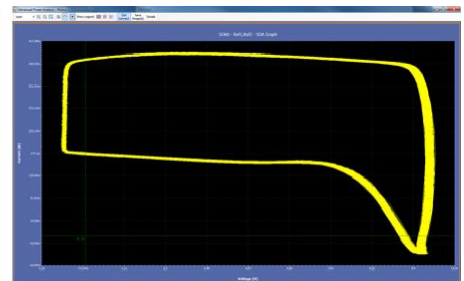

Figure 4: Reset to get the complete rendering

**NOTE.** If there is no mask violation, then resetting will render the plot to complete display area.



Plot without violation



Complete rendering of plot when reset

**Position cursors to center.** This is used to position the cursors to center. The close-up view of the waveform will make the cursor lines move out of the screen. Position cursors to center helps to move the cursors to center of the display area.

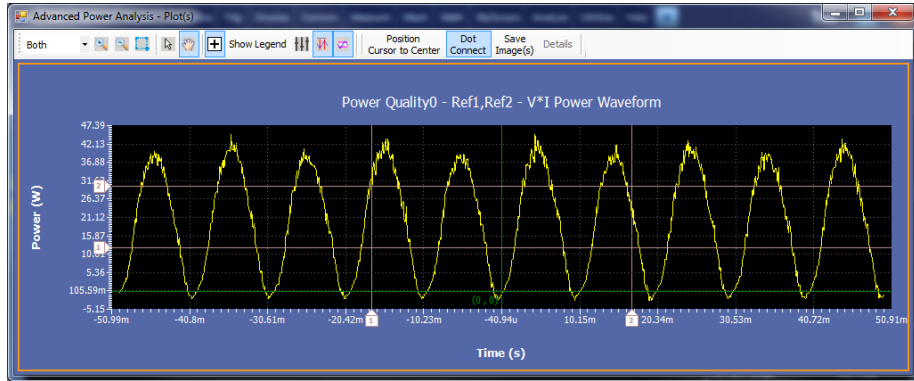

Figure 5: Plot with cursor enabled

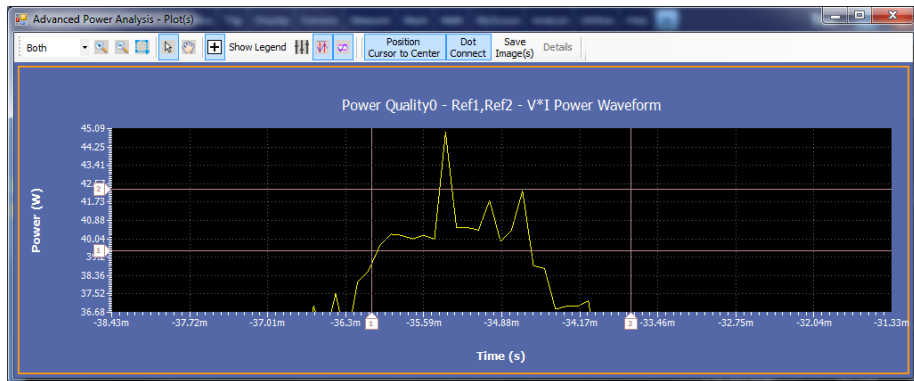
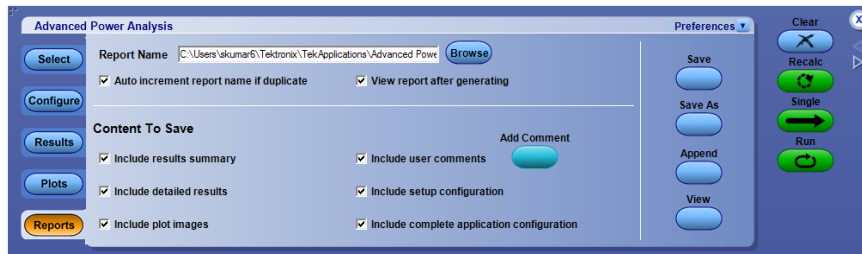

Figure 6: Plot cursors positioned to center

**Reports** Successful completion of measurements generate reports. Select Reports to set up and view the report.



To design your report do the following steps:

1. In the Report Name pane, click browse, navigate to the directory and select the report or double-click in the field, enter the path and the file name using the pop-up keyboard.
2. Check the Auto increment report name if duplicate box to auto increment the report name if its already exists. The auto generated report name is of YYMMDD\_HHMMSS\_savedfile.mht format.
3. Check View report after generating to open the generated report.
4. In the Content To Save pane, check the items you want included in your report.
  - Include results summary includes the results summary status in the generated report.
  - Included detailed results includes the measurement result details in the generated report.
  - Include plot images includes the plot images like measurement plots and the oscilloscope waveform in the generated report.
  - Include user comments includes any comments in the generated report. To add comments, click the Add Comment button.
  - Include setup configuration includes setup information like DPOPWR version, oscilloscope version, and status in the generated report.
  - Include complete application configuration includes the complete configuration details in the generated report.
5. Click the Append button to add the current settings to an existing report.
6. Click the Save or Save As buttons to save the report changes in the default report directory. The report name is modified based on Auto increment report name if duplicate option.
7. Click the View button to display the report. An example report is shown in the following images.

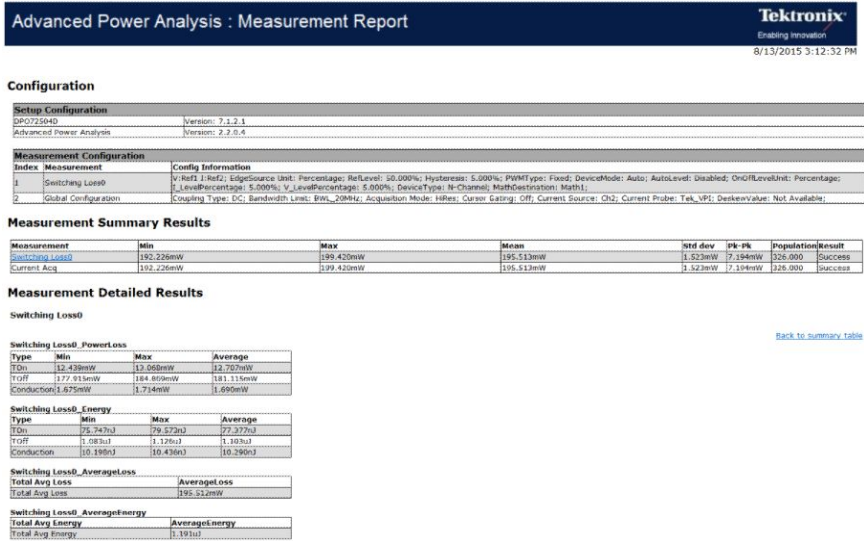

Figure 7: Report

**Images**

Plot

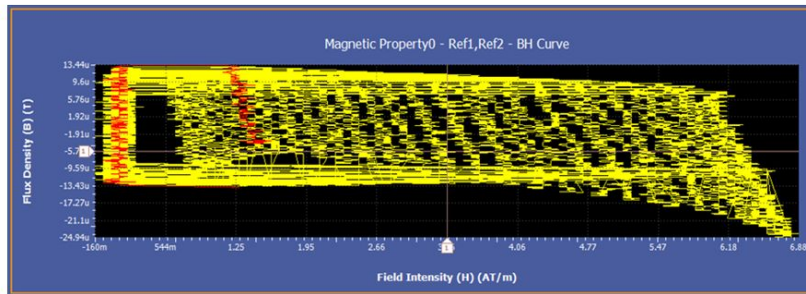

Figure 8: Plot

Oscilloscope Waveform

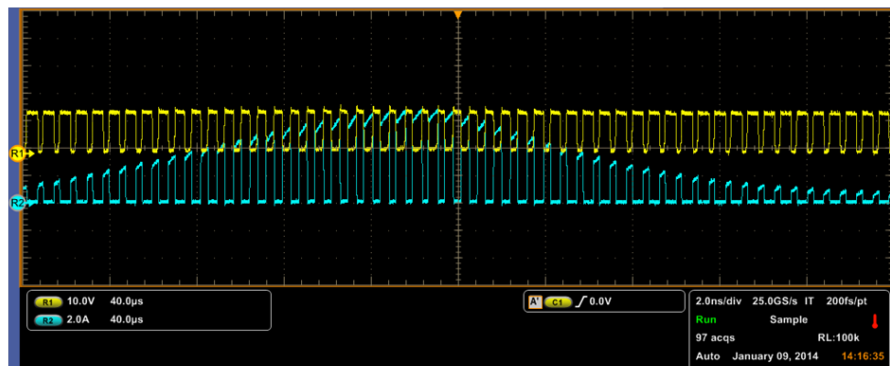

Figure 9: Oscilloscope Waveform

**Selecting a measurement**

To take a measurement, select Analyze > Advanced Power Analysis. The application launches with the Select tab (default) displaying the category of measurements.

There are six categories of measurements:

- Switching analysis
- Timing analysis
- Magnetics
- Input analysis
- Output analysis
- Amplitude

The measurements in each category are shown in the following table:

Switching analysis	Timing analysis	Magnetics	Input analysis	Output analysis	Amplitude
Switching Loss	Pulse Width	Inductance	Power Quality	Line Ripple	High
Hi-Power Finder	Period	Magnetic Loss	Current Harmonics	Switching Ripple	Low
SOA	Duty Cycle	Magnetic Property	Total Power Quality	Spectral Analysis	High Low
SOA X-Y (DPX)	Frequency	I vs $\dot{V}$	In Rush Current	Turn-On Time	Cycle Min
dv/dt	Skew		Input Capacitance		Cycle Max
di/dt			Voltage Harmonics		Cycle Pk-Pk
RDS(on)					

Select the measurements and configure the measurement settings, the waveform source, and the probe settings. Click the Results tab for statistical results.

**Source configuration** **Source configuration panel.** The following image shows the source configuration panel.

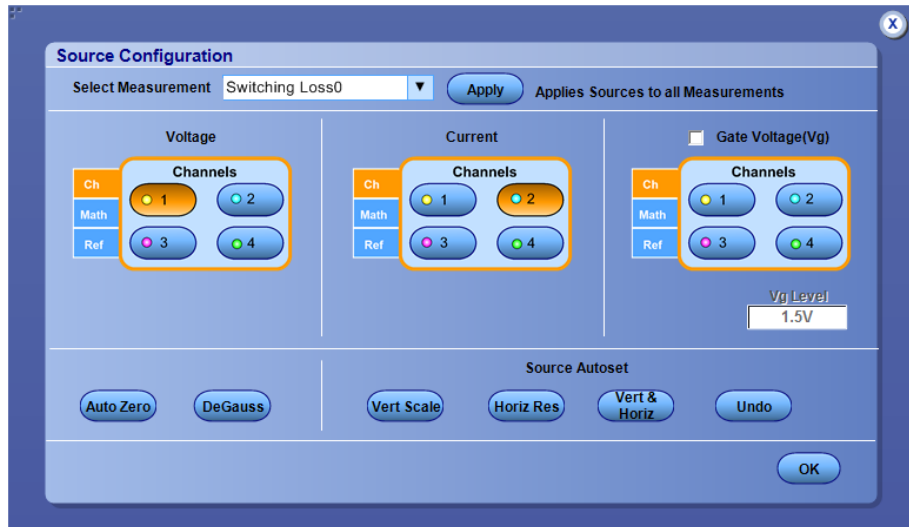

**WARNING.** When connecting to a circuit with hazardous voltages, see the warnings for the individual products and verify that the probes and other components are used within their ratings. Refer to the General Safety Summary.

Follow these steps to configure the options in the source configuration panel:

1. Select the Ref option to use a reference waveform of the oscilloscope. Select the Ch option to acquire the waveform from the unit under test. The default selection is Ch1.
  - If you select the Live source, the default Voltage source is Ch1 and the Current source is Ch2. The available selections are: Ch1, Ch2, Ch3, Ch4, Math1, Math2, Math3 and Math4. The Math selections are available only if you select Live and not Ref channels. Use the buttons in the Voltage and the Current field to select specific channels. Ripple supports REF. Except for SOA X-Y( DPX) all measurements support both REF and Live channels. You do not have the Math selections here.



- If you select the Ref option, the default Voltage source is Ref1 and the Current source is Ref2. Use the buttons in the Voltage and the Current field to select specific channels.

---

**NOTE.** *When Math is chosen as a voltage source, it should be independent of the selected math destination. The math destination is defined with a predefined function only if the selected math destination is independent of any selected measurement or any math definition. User cannot select the same channel source in the Voltage and Current field. Example: If you select Ch1 in the Voltage field and Ch1 in the Current field and select Run, the application displays an error message "Conflict in selection of voltage source and current source." The Voltage and Current source selection is dependent on the measurement selected.*

---

Double-click the Vg Level field and use the keypad that appears to enter the values. The acceptable range of Vg values are 0 V to 50 V and the default value is 1.5 V, if you have selected the Vg option in Source configuration window. You can change the default value of the start of switch ON when you select the gate voltage. The default value is 5% of the maximum of Vg or 1.5 V of Vg, whichever is lower.

2. Press the Vert Scale, Horiz Res, or Vert & Horiz buttons in the Source Autoset panel to automatically set the scale and resolution to the best settings for the measurement.
3. Press Undo in the Source Autoset panel to revert to the last autoset operation.

**Source autoset.** Source Autoset automatically adjust the oscilloscope vertical and/or horizontal settings according to the measurement group for the live sources (Ch1-Ch4). The Source Autoset panel includes the following buttons:

- Vert Scale
- Horiz Res
- Vert & Horiz
- Undo

Clicking Vertical Scale automatically checks the peak-to-peak level of live sources. The vertical scale and offset of the signals with peak-to-peak value less than six divisions are adjusted to eight divisions. If the maximum or minimum value of a signal is clipped, the vertical scale and offset are adjusted so that the peak-to-peak value is eight or higher divisions. An error message is displayed when clipping is detected.

Clicking the Horiz Res adjusts the time base for live channels so that at least 10 complete cycles for very low frequency (200 Hz) and more cycles for higher signal frequencies are displayed. The measurements in Switching Loss, Modulation Analysis and Magnetic Property set up the oscilloscope in similar way. The measurements such as Spectral, Line Ripple, and Switching Ripple under Input and Output Analysis set up differently, Since the horizontal time base is set based on the Resolution Bandwidth (RBW) and ripple frequency.

Clicking Vert & Horiz defines the vertical and the horizontal settings for all channel sources. It also applies autoset on each channel before performing the vertical scale and horizontal resolution autoset.

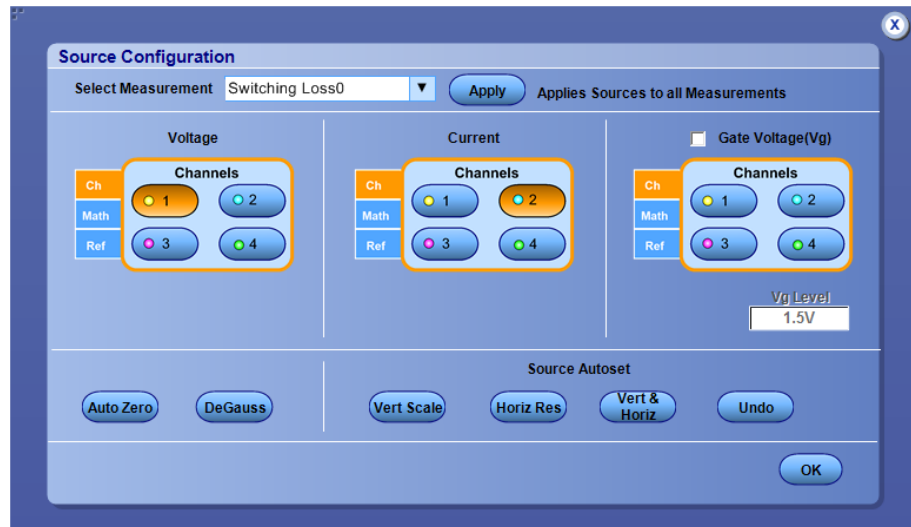

**NOTE.** Autoset accounts for the deskew value. If the deskew value is less than the sample interval set by autoset, then the deskew value is rounded to 0.0 s by the oscilloscope. This can be seen in the Vertical > Deskew menu. In this situation, it is recommended that you use a higher sample rate.

## Selecting and configuring measurements

1. From the oscilloscope menu bar, select Analyze > Advanced Power Analysis. The application launches with the Select tab (default) displaying the category of measurements.
2. Click SOA in Switching Analysis tab.

Follow the steps to use the SOA Mask Editor:

1. Select the Enable check box in the Mask pane to apply the mask to the SOA plot.

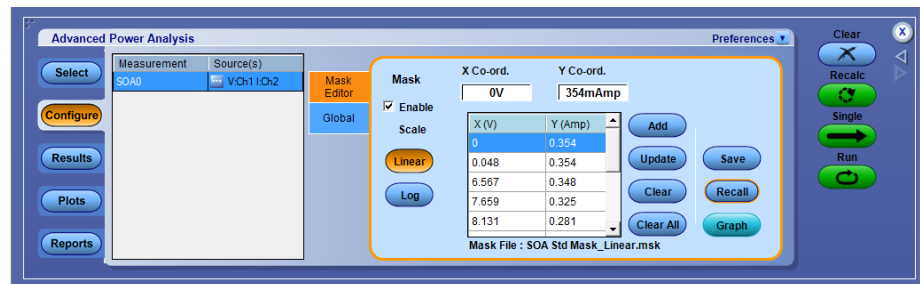

2. Double-click the Mask X and Mask Y fields and use the keypad that appears to set the XY coordinates of mask values.
  - Click the Add button to add the mask values as a new mask point.
  - Click the Update button to update the selected mask point with the new mask values.
  - Click the Recall button to retrieve a saved mask from the default directory or the directory where you have saved the mask.

3. Click the Graph button to preview the mask.

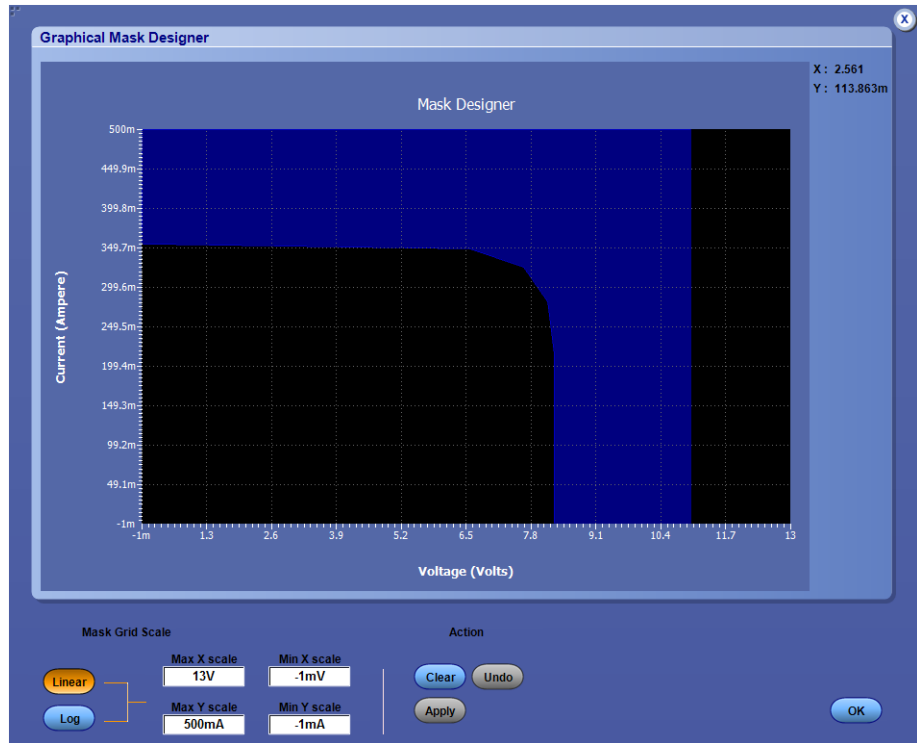

4. Configure SOA and click Run to display the SOA Plot with the mask in the background.

5. Select scale as Log and follow steps 1 to 4 to generate a mask for log.

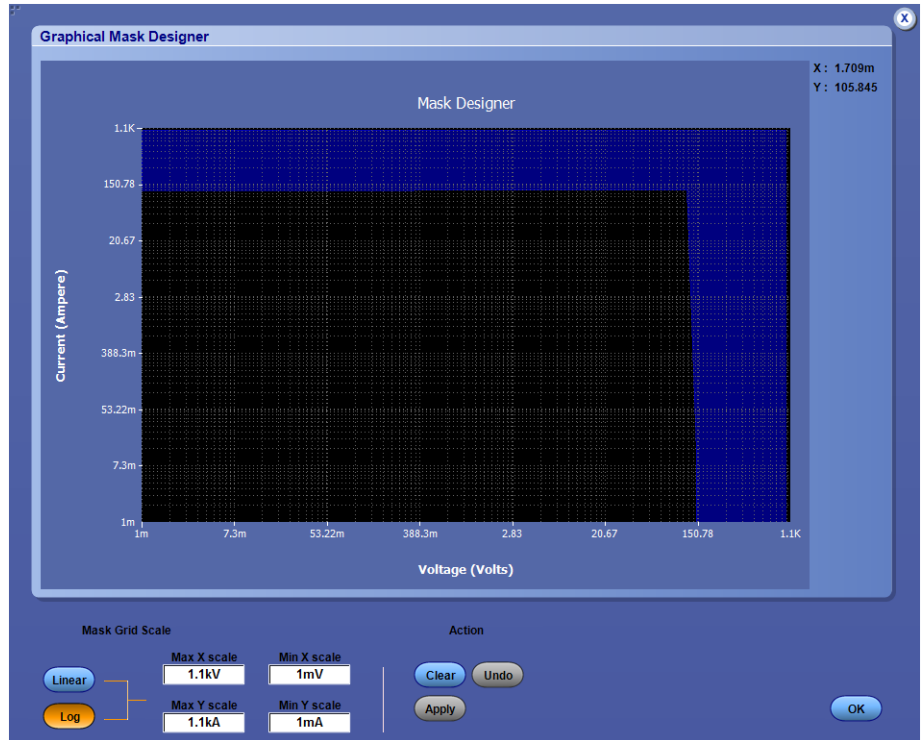
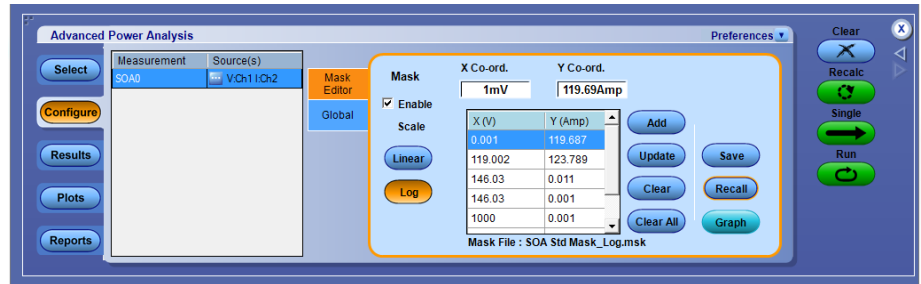

6. Click the Save button to save the mask in .msk file. The default directory is C:\User\Public\Tektronix\TekApplications\Advanced Power Analysis\SOA Mask\. The SOA plot displays the Pass/Fail region in different colors.
7. Mask can be created graphically by clicking Graph button or by entering coordinates in the mask editor.

In Graph mode, you can construct the graph by free hand drawing using mouse clicks. Once the drawing is completed click Apply.

8. Click the close button and you can observe the mask editor is filled with mask points which are from the Graph.
9. You can switch between Log and Linear Mask creation, by selecting the appropriate buttons.

You can set the Mask Values and define a mask. Select the Clear button to remove the selected mask point, select the Clear All button to remove all mask points.

### Configuring global settings

The Global tab settings apply to all measurements.

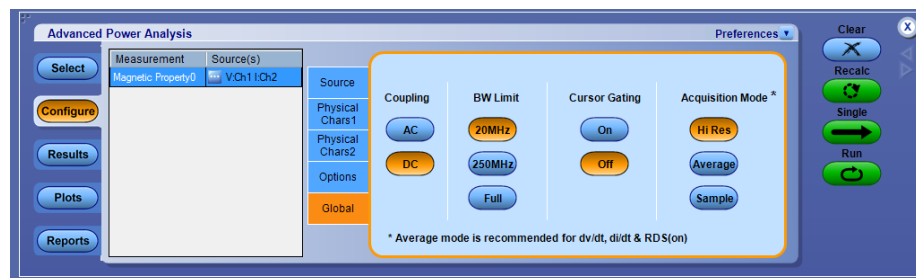

In the Global tab make the following settings:

- Set the coupling: AC or DC.
- Select the bandwidth limit from the Bandwidth limit pane: 20 MHz, 250 MHz or the Full option. The Full option refers to the maximum bandwidth available in an oscilloscope. These options may not be available on all supported oscilloscopes. Please refer to your oscilloscope bandwidth options.
- Turn cursor gating On or Off: Select On to enable gated measurement to analyze a specific section of the waveform. When you enable Cursor Gating and then click Run or Single, the application displays a message "Place the cursors at the appropriate region of the waveform". Position the cursor as required. If you select Yes, the application analyzes and plots the time trend of the selected section of the waveform between the cursors.
- Select the acquisition mode: Hi Res, Average, or Sample mode. When average mode is selected, you can change the average value (in the oscilloscope Horizontal acquisition menu). By default the average value is set to 16.

**Configuring options**

To set the Units, Ref Level, Hysteresis, Log Switching Cycles, Signal Condition, and Filter Current, select the Options tab.

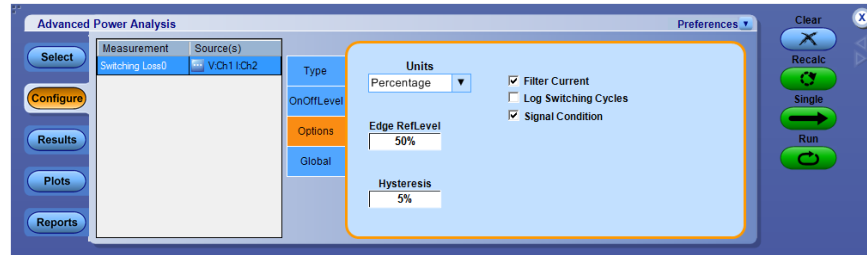

1. Enable the Signal Condition option. If you enable the Signal Condition option, the application resets the switch current to zero after the switch OFF to the next switch ON. If you select the Filter Current option, the switch current has ringing at the low levels during switch ON.
2. Enable the Filter Current option. If you select the Filter Current option, the switch current has ringing at the low levels during switch ON. The default value is 5% of the maximum of  $V_g$  or 1.5 V of  $V_g$ , whichever is lower.
3. Enable the Log Switching cycles to log the switching cycles in a .csv file.
4. Select the Percentage option in the Units drop-down menu to set the Ref Level, Hysteresis, V-Level, and I-Level values as a percentage or the Absolute option to set the absolute value of the peak-to-peak signal.
5. Double-click the Ref Level field and use the keypad that appears to set the absolute or the percentage of the ref level value.
6. Double-click the Hysteresis field and use the keypad that appears to set the absolute or the percentage of the hysteresis value.

**Configuring edges**

To set the edge polarity, select the Edges tab and select either Positive or Negative polarity.



**Control panel** The Control Panel appears on the right of the application window. Using this panel, you can start or stop the sequence of processes for the application and the oscilloscope to acquire information from the waveform.

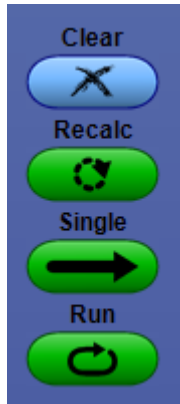

The control panel includes Show Plots when a plot is selected:



The following list describes each of these controls:

- Clear clears the current result display and resets any statistical results and autoselected reference levels
- Recalc runs the selected measurements on the current acquisition
- Single initiates a new acquisition and runs the selected measurements
- Run initiates a new acquisition and runs the selected measurements repeatedly until Stop is clicked. Run is used only for live sources
- Show Plots displays the plot summary window. This button appears in the control panel only when a plot is selected



## Switching measurement and analysis

### Switching loss **Selecting and configuring measurements-Switching loss.**

1. From the oscilloscope menu bar, Select Analyze > Advanced Power Analysis, and then press the Select navigation tab to display the default screen.
2. Click Switching Analysis to display the Switching Analysis screen.
3. Click Switching Loss in the Switching Analysis pane. Click Configure.

---

**NOTE.** Perform vertical and horizontal source Autoset for optimal signals.

---

**NOTE.** We recommend you to use the Hi-Res acquisition mode to analyze switching loss.

---

1. The Switching Loss option calculates the amount of power dissipated across the switching device under the steady state of operation. The results vary according to the selected measurement.
2. Configure the parameters by clicking the Type, On-Off Level, Options, and Global tabs.

### Switching loss

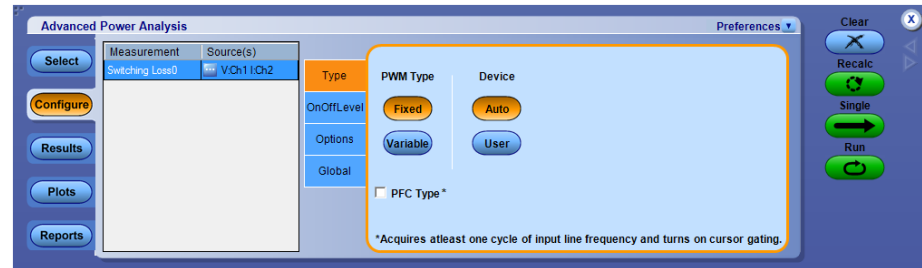

### **Switching loss edge source.**

In the Edge Source pane, follow the steps given to configure the Switching Loss Control Signal parameters:

1. The Edge Source is the Voltage source configured in the Source Configuration Panel.

The application identifies:

- The edges on the switch voltage
  - The Switch On and Switch Off portions using the switch voltage and switch current
2. Select the Percentage option in the Units drop-down menu to set the Ref Level and Hysteresis values as a percentage or the Absolute option to set the absolute value of the peak-to-peak signal.
  3. Double-click the Ref Level field and use the keypad that appears to set the absolute or the percentage of the ref level value or double-click the Hysteresis field and use the keypad that appears to set the absolute or the percentage of the hysteresis value.

If the measurement is successful, the application automatically displays the results.

**Switching loss type.** In the Type tab, use the following steps to configure the Switching Loss parameters:

1. In the Device pane, click the User button to enable the switching device type options. Select either the MOSFET or the BJT / GBT switching device. If you select MOSFET, double-click the RDS field and use the keypad that appears to enter the RDS value that is available in the data sheet, for the specified temperature of operation. If you select the Auto button, the application calculates the total power loss and energy using the switch voltage and current and checks for the vertical scale of the switch voltage. If the switch voltage scale is greater than ten volts per division, the application displays a warning message: "Vertical Scale of Switch Voltage > 10 V and the user defined RDSon is not selected. So the calculated energy and loss may not be accurate."

When PFC is selected, application sets up the oscilloscope to acquire at least 20 milliseconds duration or at least two cycles of line frequency (50 or 60 Hz). For more details about PFC type, [Click here](#)

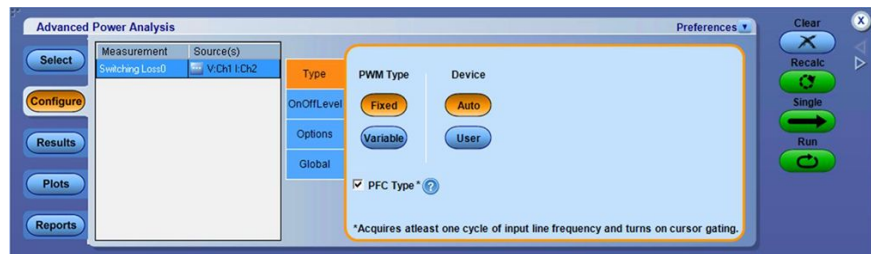

If the measurement is successful, the application automatically displays the results.

---

**NOTE.** When PFC type is selected, it turns ON the Cursor gating. When PFC type is unchecked, the cursors will retain the previous state. Users can use Global configuration to control the cursors ON and OFF.

---

**Switching loss TOn and TOff ref levels.** In the TOn and TOff Levels pane, follow the steps to configure the Switching Loss TOn and TOff RefLevel (V-level and I-level) parameters:

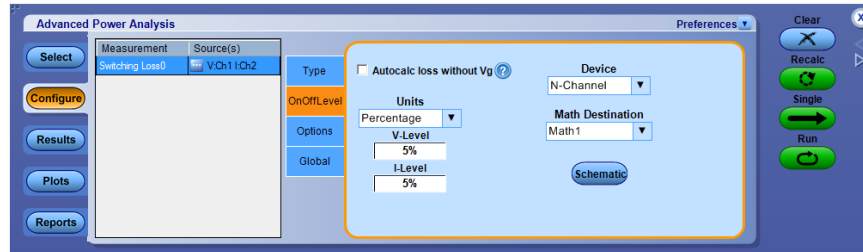

1. Select the semiconductor type (DUT) from the Device drop-down menu. The available options are: N-Channel and P-Channel. In an N-Channel device, the Switch Voltage, Switch Current and the Gate Voltage are positive. In a P-Channel device, the Gate Voltage can either be positive and negative or only negative.
2. Select the Percentage option in the Units drop-down menu to set the Ref Level and Hysteresis values as a percentage or the Absolute option to set the absolute value of the peak-to-peak signal.
3. Double-click the V-Level field and use the keypad that appears to set the absolute or the percentage of the V-level value. The V-Level value for the Start of TOn is five percent of the switch current and for Stop of TOn is five percent of the maximum switch voltage.
4. Double-click the I-Level field and use the keypad that appears to set the absolute value or the percentage of the I-level value.
5. Select the math destination from the drop-down menu. The default destination is Math1.

---

**NOTE.** When switching current or voltage amplitude varies in an envelope shape. The TOn and TOff levels should be in Absolute Units for accurate results.

---

If the measurement is successful, the application automatically displays the results.

**Switching loss - Autocalc loss without Vg.** Select **Autocalc loss without Vg** for automatic computation of switching loss without using gate voltage source. User can configure V-Level and I-Level in OnOffLevel tab (percentage units) to define the start and stop of loss regions. The V and I levels is updated in Absolute Units and Optimal Reflevel in Options tab, after the Run.

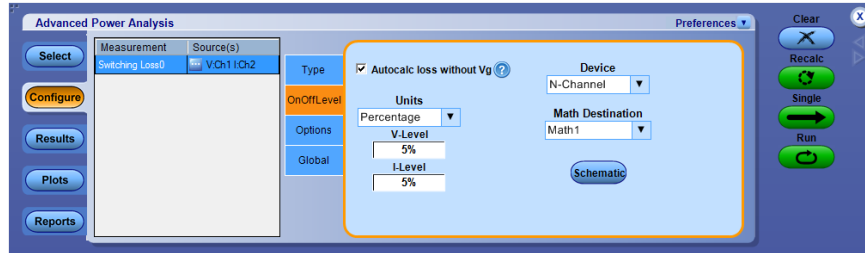

**Table 1: Settings disabled when Autocalc loss without Vg is selected**

Configuration tab	Settings
OnOffLevel	V-Level when Units is Absolute
	I-Level when Units is Absolute
Options	Units
	Edge RefLevel
	Filter Current
	Signal Condition
Type	PFC Type

**NOTE.** Make sure the record length is 10K, having 10 switching cycles.

**NOTE.** Gate Voltage(Vg) in source configuration is disabled when Autocalc is selected.

**NOTE.** This method is not recommended for PFC type.

This method is recommended, when switching voltage is ringing in nature and switching current has spikes. However when both voltage and current have very bad ringing as shown in the following figure, then it is suggested to use gate voltage source for correct results.

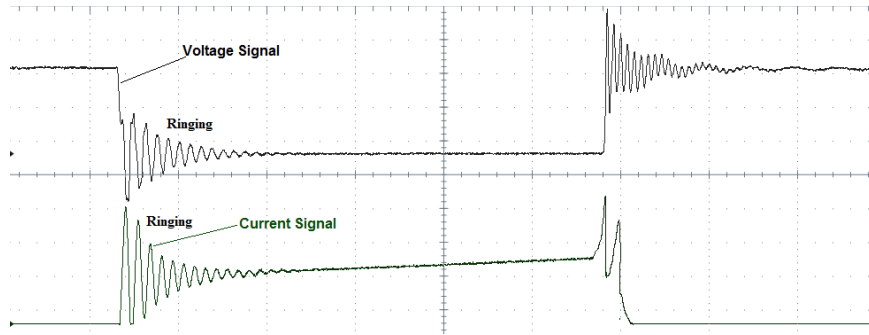

**Switching loss options.** In the Options tab, follow the steps to configure the Switching Loss Options parameters:

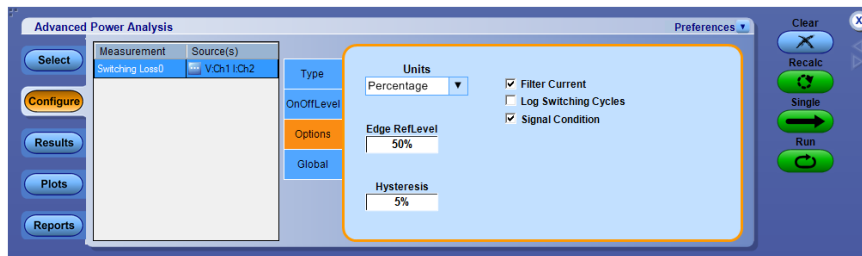

1. If current signal has ringing at low level during Switch-ON, enable the Signal Condition and Filter Current Options. The default value is 5% of the maximum of  $V_g$  or 1.5 V of  $V_g$ , whichever is lower.
2. Select the Percentage option in the Units drop-down menu to set the Ref Level and Hysteresis values as a percentage or the Absolute option to set the absolute value of the peak-to-peak signal.
3. Double-click the Ref Level field and use the keypad that appears to set the absolute or the percentage of the ref level value.
4. Double-click the Hysteresis field and use the keypad that appears to set the absolute or the percentage of the hysteresis value.
5. To globally set the coupling, bandwidth limit, cursor gating, and acquisition mode, see [Configuring global settings](#).
6. Press Run to acquire the data.

If the measurement is successful, the application automatically displays the results.

**NOTE.**

- *It is not recommend to use cursor position in SW Cycle in case of noisy VG source and plot may not place the cursors properly.*
- *It is recommend for Switching loss measurement for PFC and other topologies to have at least 10 complete switching cycles to measure properly.*

**Switching loss - PFC.** This section describes the flow when you run the measurement with PFC selected.

1. Application allows you to place cursors for region of interest.

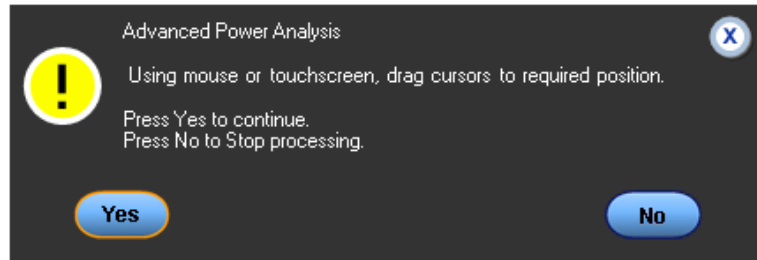

2. It suggests using gate voltage for PFC signals.

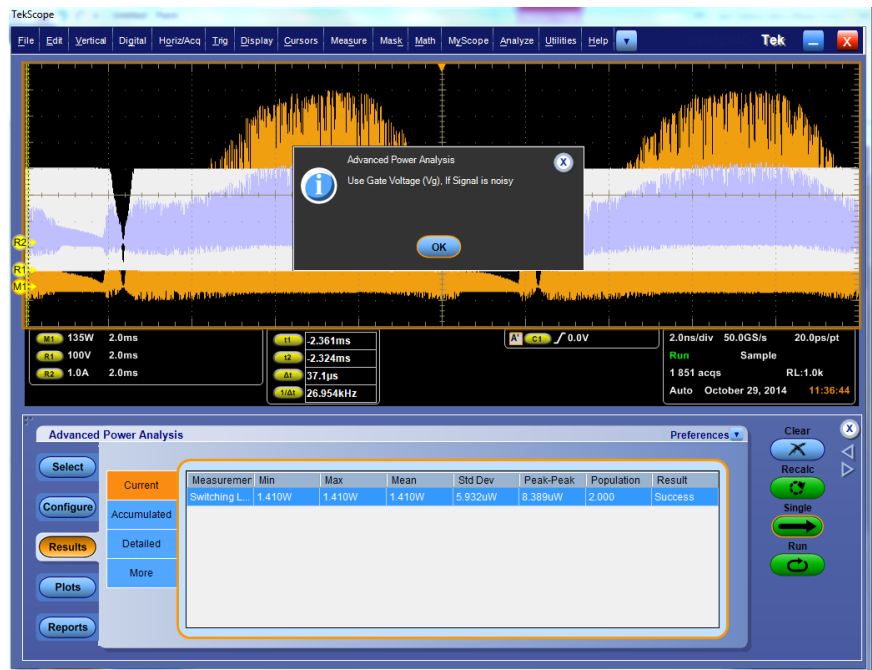

3. If the application detects ringing with  $V_g$  and pops up error message, then adjust REF level as described in [REF level computation for noisy  \$V\_G\$  source](#).

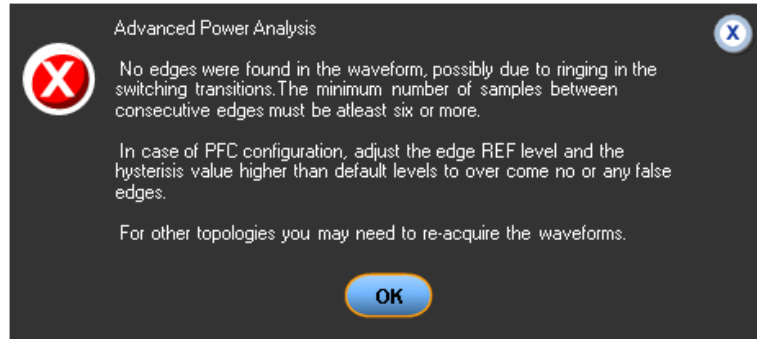

4. By observation Switch voltage is good, so change to  $V_{ds}$  and then run the measurement.



**Switching Loss PFC - Cursor gating.** Cursor gating is used to ensure that the switching loss measurements represent the losses across all of the switching cycles within an integer number of line-voltage-half-cycles, usually one half-cycle of line period frequency. For AC/DC switching power supply, designers design heat sink to remove all heat energy dissipated by the device under steady state operation. This dissipated heat is proportional to the measured loss across the device. During initial phase, the current will be very low and the switching voltage is in DC mode. So the average loss is measured for region of interest that is for one line period of the acquired waveform.

The cursors should be placed near the zero crossings of the line voltage such that time duration of half cycle of 50/60 Hz is covered. Place the cursors, by zooming the switching waveforms and observe where the current goes to zero. By placing the cursors near the zero crossing of the line voltage, the exact cursor placement is less critical because the switching losses are lowest around the line voltage zero crossings, and any measurement errors are minimized. You can make sure half a cycle region of 100/120 Hz between the cursors.

#### Switching waveforms where the current goes to zero

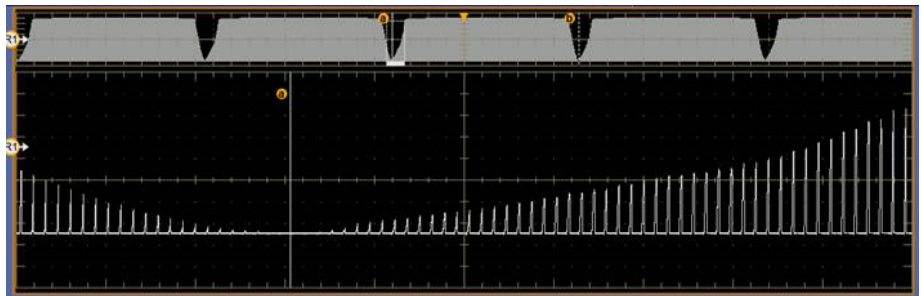

#### Switching waveforms with cursors near zero crossing

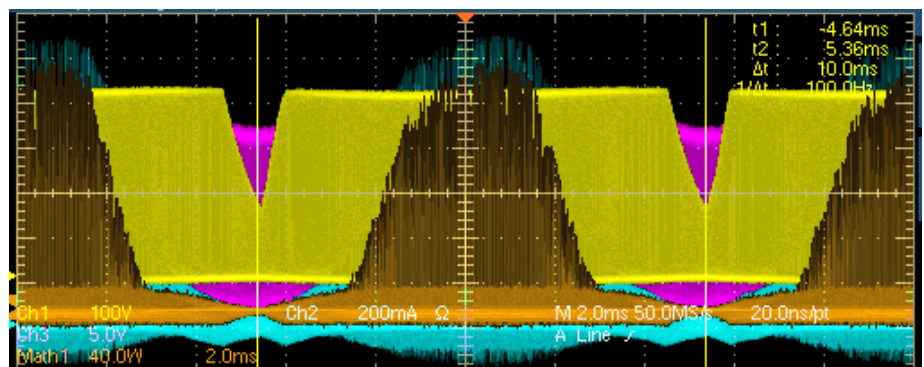

It is recommended to use gate voltage as edge source in case of PFC topology for post-processing. The switch voltage can vary in duty cycle and operating frequency as shown in the following image. The switch voltage can operate in

both continuous conduction mode and discontinuous conduction modes, hence switching cycle cannot be identified using the switch voltage. So the gate drive signal is used to identify the correct switching cycles and also the gate voltage will be a clean pulse and does not have ringing as it is from IC.

The following figure shows the duty and frequency variation. Ref1 is the switch voltage captured across the switching device and Ref2 is the gate drive signal. Ref1 goes into discontinuous conduction mode within the switching cycle.

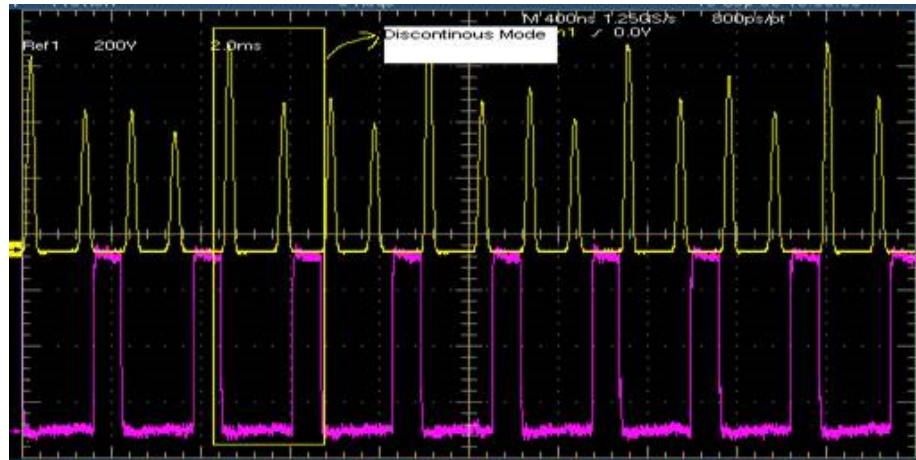

**Viewing results-Switching loss.** Do not disturb the oscilloscope settings during the post analysis of the results. Changing settings will put the oscilloscope into Preview mode. This could lead to incorrect interpretation of results.

Select Analyze > Advanced Power Analysis > Results, from the oscilloscope menu bar, and then press Current for current results. Current results show statistics of Total Average Loss values,

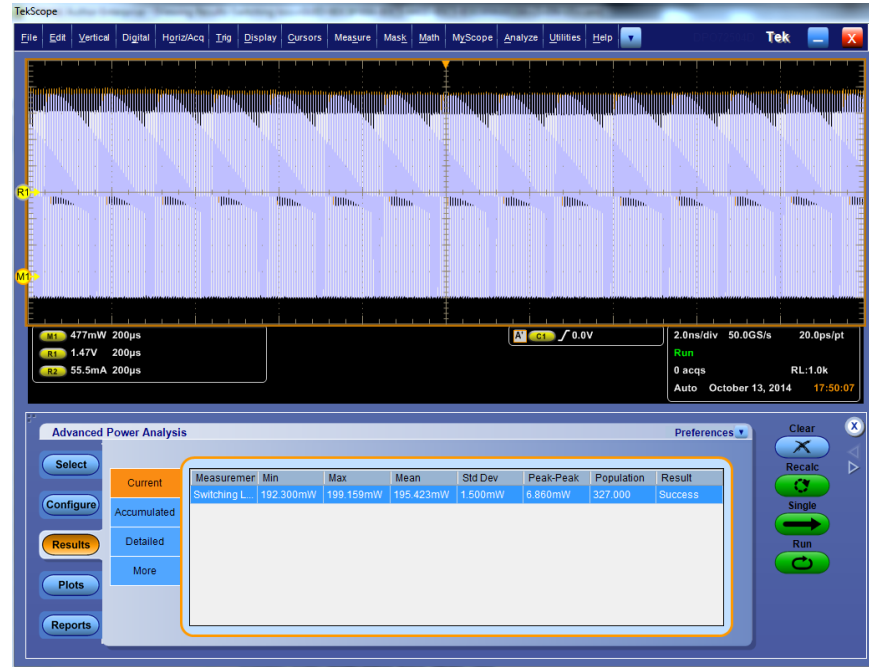

Select Analyze > Advanced Power Analysis > Results, from the oscilloscope menu bar, and then press Detailed for detailed results. Detailed result shows TON, TOFF and Conduction loss and energy statistics.



The application displays the results for the Switching Loss measurement in two panes: Power Loss and Energy.

1. In the Power Loss column, the Min field displays the minimum loss in the acquisition in Watts. The Max displays the maximum loss in the acquisition in Watts. The Average Loss is the sum of TOn average, TOff average and the Conduction Loss.
2. In the Energy column, the Min field displays the minimum of all the energy values calculated for each cycle. The Max field displays the maximum of all the energy values calculated for each cycle in Watts. The Average energy displays the sum of TOn energy, TOff energy and the Conduction energy in Joules.

---

**NOTE.** Total Avg in the Detailed result tab includes conduction loss and is computed result for entire acquisition.

---

**NOTE.** Negative switching loss results may be due to the DC offset in the voltage and current probes used. To avoid this, compensate the probes for DC offset and also run Signal Path Compensation option (SPC) on the oscilloscope before starting the application. Make sure to use only DC coupling.

---

**NOTE.** Gate voltage is recommended as edge source for PFC and topologies such as Flyback technologies as application is not able to compute edges on Switching Voltage and Current waveforms due to ringing which leads to false edges.

---

**NOTE.** The  $T_{On}$  and  $T_{Off}$  definitions for switching loss measurements when gate voltage is selected are as follows:

- $T_{On}$  is defined as the time from the gating signal turns on to the time that the switching device turns on.
- $T_{Off}$  is defined as the time from the gating signal turns off to the time that the switching device turns off.

**Switching loss plots.** If the Switching ON OFF plot is selected, click Show Plots to display the plot.

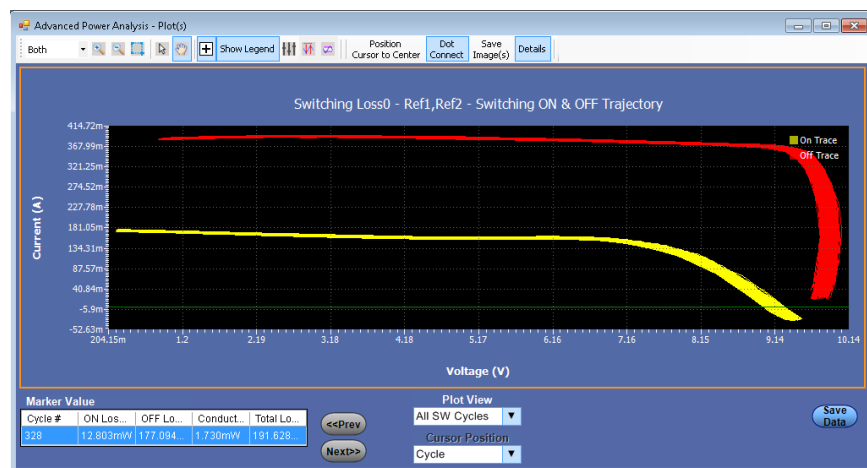

The Plot View allows you to view the plots for all cycle and single cycle based table values.

- All SW Cycles: Displays the plots for all cycle table values.
- SW Cycle: Displays the plots for the selected Cursor Position:
  - Cycle: The selected switching cycle is zoomed and the scope cursors are placed between start of Turn-on and stop of Turn-off.

**Switching Loss plot when Cursor Position > Cycle is selected**



- OnLoss: The selected switching cycle Turn-on loss is zoomed and the scope cursors are placed between start and stop of Turn-on loss region. .

**Switching Loss plot when Cursor Position > OnLoss is selected**



- OffLoss: The selected switching cycle Turn-off loss is zoomed and the scope cursors are placed between start and stop of Turn-off loss region. .

**Switching Loss plot when Cursor Position > OffLoss is selected**



- ConductionLoss: The selected switching cycle conduction Loss is zoomed and the scope cursors are placed between stop of Turn-on and start of Turn-off. .

**Switching Loss plot when Cursor Position > ConductionLoss is selected**



---

**NOTE.** *The Plot View and the Marker Value table for Switching loss plots is displayed in Details view.*

---

**NOTE.** *Sometimes plot view for selected cycles show either ON or OFF region only. This happens with PFC waveforms when you select 50 / 60Hz region. Load PFC waveforms, and select cursors at 120Hz region, RUN the measurement, to get plot and results. In plot view to individual cycles, observe that only OFF cycle is present since there is no ON loss or zero ON loss on the time domain waveform or vice versa. So you will not see ON-OFF pair in the plot.*

---

**See also.**

[\*Selecting and configuring measurements-Switching loss\*](#)

[\*Plot components and features\*](#)



### Troubleshooting switching loss results.

The figure on the left shows the current waveform of a switching device. The figure on the right shows the zoomed signal. During Turn On of the switch current, a spike occurs as shown in the previous figures. If you configure the I-value in the TOn and TOff tab to 5 %, during analysis, the application converts the 5% value to the absolute as the product of (5/100) and maximum of the switch current. The maximum of the switch current indicates the spike in the signal. This is valid only during TOn. The calculated maximum switch current value is used to identify the stop of Turn Off. Since you are using the maximum spike values to calculate TOn and TOff, the stop of TOn value is inaccurate. To overcome this, enter the reference value only in Absolute units.

What do you do when you get zero values in the switching loss results?

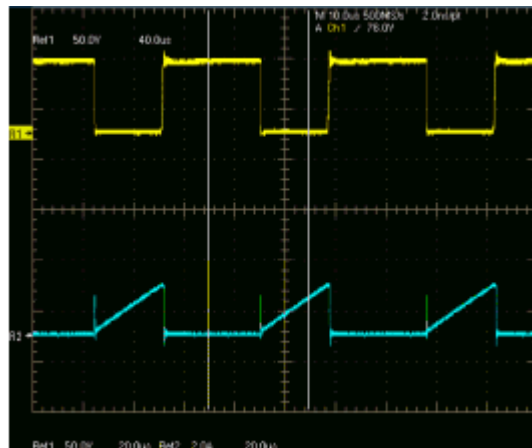

- When you clear the Filter Current check box in the Options tab, and the switching current waveform is similar to the one in the previous figure, the application finds the start of TOn from the cursor 2 position. The algorithm searches from the cursor 2 position for the configured level and logs on to the first level. In this case, the start of TOn is calculated after the stop of Ton and the energy and loss is zero.
- When the configured I-level is out of the signal range, the TOn and TOff energy and the loss is zero, the application displays a warning message.



- If you select the Vg option button in the Edge Finder tab, the gate voltage should be a clean pulse without any glitch or ringing as shown in the previous figure. The gate voltage is used to identify the edges, TOn or TOff portions. When a glitch occurs, the application displays incorrect results. This type of signal can result in multiple edges (wrong edges) within a switching cycle.

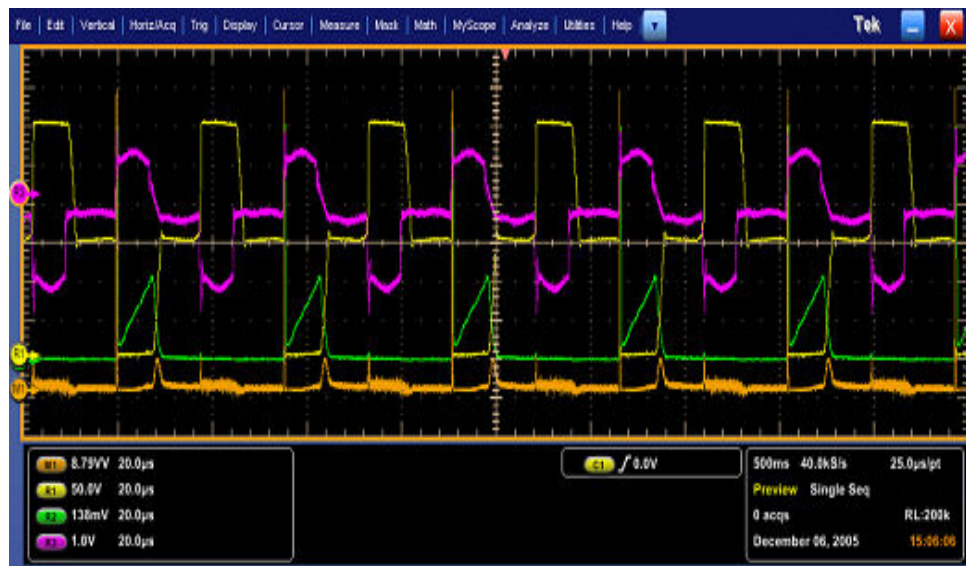

If the signal (Push Pull device) is similar to the one shown in the previous figures, configure the Ref level only at the switching portion of the voltage. The switching occurs only at the lower portion of the switch voltage. Enter the Ref value as 30% which falls midway between the lower switching portion.

If you have selected the P-channel device, the switching voltage and current is negative and the gate voltage is negative or positive and negative. The application inverts the waveform and analyzes it like the one on an N-channel

device. Select the Vertical Setup > Invert option in the oscilloscope menu to invert the switch voltage, current, gate, and set the device to N-channel.

### Hi-Power finder **Selecting and configuring measurements-Hi-Power finder.**

1. From the oscilloscope menu bar, Select Analyze > Advanced Power Analysis, and then press the Select navigation tab to display the default screen.
2. Click Switching Analysis to display the switching analysis measurements screen.
3. Click Hi-Power Finder in the Switching analysis pane. Hi-Power Finder calculates the instantaneous peak power on the switching waveform. The results vary according to the selected measurement.
4. Click Configure. You can configure the parameters by clicking the PWM Type, On-Off Level, Edges, and Global tabs.

---

**NOTE.** *The waveform height should be >8 divisions, which is possible by using vertical Autoset, divisions to take the measurements. It is recommend that you use the Hi-Res acquisition mode to analyze Hi-Power Finder.*

---

### Hi-Power finder.

#### Hi-Power finder edge source.

Follow the steps given below to configure the Hi-Power finder parameters in the Edge Source pane:

1. The Edge Source is the Voltage source configured in the Source Selection Panel.  
The application identifies:
  - The edges on the switch voltage
  - The Switch On and Switch Off portions using the switch voltage and switch current
2. Select the Percentage option in the Units drop-down box to set the Ref Level and Hysteresis values as a percentage or the Absolute option to set the absolute value of the peak-to-peak signal.
3. Double-click the Ref Level field and use the keypad that appears to set the absolute or the percentage of the ref level value or double-click the Hysteresis field and use the keypad that appears to set the absolute or the percentage of the hysteresis value.

If the measurement is successful, the application automatically displays the results.

**Hi-Power finder type.** Follow the steps given below to configure the Hi-Power Finder parameters in the Type tab:

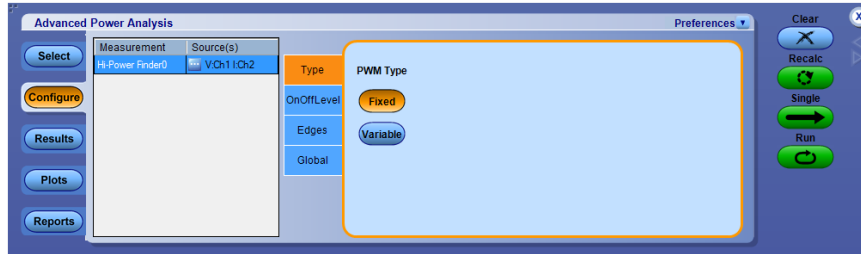

1. Click the Variable button if a switching device operates with a variable Duty Cycle with or without Discontinuous Conduction Mode. If the Variable option is selected, the voltage edge source selection in the On-Off Level tab switches to  $V_g$  (gate drive signal). If the Fixed option is selected, the application measures the switching loss for all the topologies with a constant duty cycle.

If the measurement is successful, the application automatically displays the results.

**Hi-Power finder ton and toff ref levels.** Follow the steps given below to configure the Hi-Power Finder parameters in the OnOff Level pane:

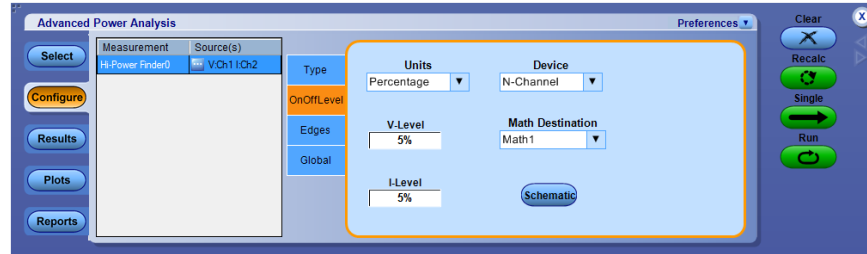

1. Select the semiconductor type (DUT) from the Device drop-down menu. The available options are: N-Channel and P-Channel. In an N-Channel device, the Switch Voltage, Switch Current and the Gate Voltage are positive. In a P-Channel device, the Gate Voltage can either be positive and negative or only negative.
2. Select the Percentage option in the Units drop-down box to set the V-Level and I-Level values in percentage of the peak-to-peak signal or select the Absolute option to set the absolute value of V-Level and I-Level in amperes. The V-level and I-level values should be less than the sum of the Ref Level and Hysteresis divided by two.
3. Double-click the V-Level field and use the keypad that appears to set the absolute or the percentage of the v-level value. The V-Level value for the Start of Ton is five percent of the switch current and for Stop of Ton is five percent of the maximum switch voltage.
4. Double-click the I-Level field and use the keypad that appears to set the absolute or the percentage of the I-level value.
5. To globally set the coupling, bandwidth limit, cursor gating, and acquisition mode, see [Configuring global settings](#).
6. Press Run to acquire the data.

If the measurement is successful, the application automatically displays the results.

**Viewing results-Hi-Power finder.** Do not change or touch the oscilloscope settings during the post analysis of the results. This could lead to incorrect interpretation of results.

Follow these steps to view the results:

1. From the oscilloscope menu bar, select Analyze> Advanced Power Analysis, and then press Results.
2. The application displays the results for Hi-Power Finder measurement as shown below.
3. View the results of the Peak Finder and Switching Finder options.

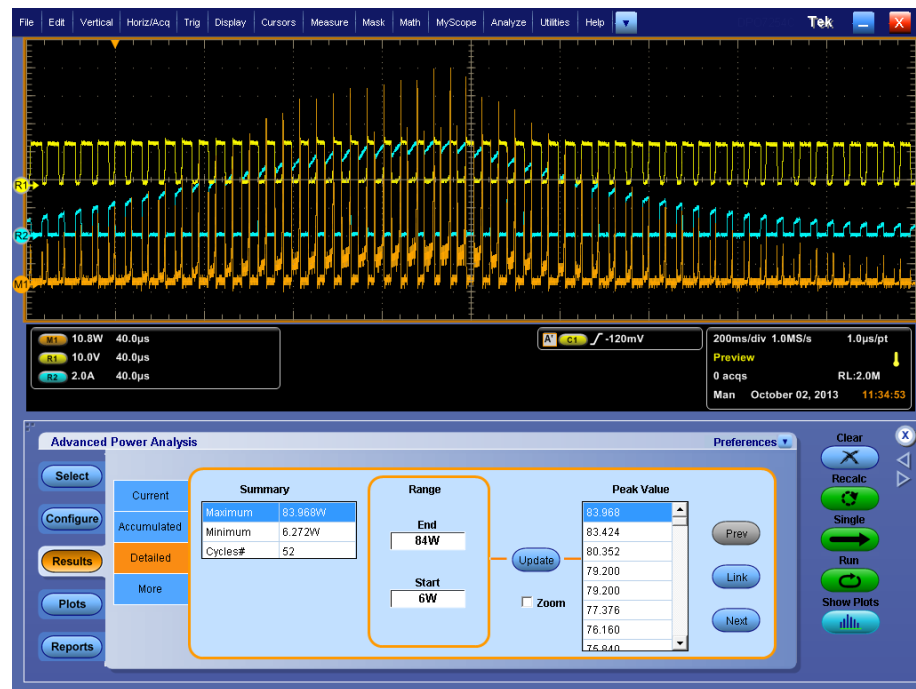

In the Peak Finder tab options:

- The Summary displays maximum and minimum value of the power waveform peaks. It also displays the occurrences or positions of the On type and Off type peaks in a single waveform.
- In the Range panel, End and Start fields display the peaks between a range. Double-click these fields and use the keypad that appears to enter the numeric inputs. Click Update.
- The Peak Value panel displays the peaks between End range and Start range in descending order. Click Link to identify the peak portion in the voltage and current waveform. Use the Prev button to move the cursor position to the previous peak from the linked position. Use the Next button to move the cursor position to the next peak from the linked position. By default, the application positions the cursors on the first peak.

- Select the Zoom to zoom in at the cursor location.

In the More tab location:

- The application displays On Time and Energy results between the cursors. Energy is the amount of energy dissipated from On to Off of the waveform.
- On Time is the conduction time for any switching device. You can move the Peak Pair Cursors depending on the order of their placement.
- Use the Prev Pair button to move the cursor to the previous cursors and the Next Pair button to move the cursors to the next pair of cursors.

---

**NOTE.** *The value displayed in population column under Current and Accumulated result tab for Hi-Power finder is the count of number of peaks. Number of cycles count is displayed in the Detailed result tab.*

---

---

**NOTE.** *To get effect of clicking a value in the results table, select the Link button to associate the cursors with the time domain waveform on the oscilloscope screen. The same steps are expected for the Zoom function to work properly. Select the Zoom check box and then Link button to see the zoom-in operation.*

---

---

**NOTE.** *If the current waveform is less than a division high, the application displays an error message, "Unable to find the correct edges." This is because the variation of data points with in single division is very high and the hysteresis band is insufficient to find the correct edges. Therefore, for the voltage waveform, the vertical range should be greater than one division.*

---

---

**NOTE.** *Negative Switching loss results may be due to the DC offset in the voltage and current probes used. To avoid this, compensate the probes for DC offset and also run the Signal Path Compensation option ( SPC ) on the oscilloscope before starting the application.*

---

**See also.**

[Selecting and configuring measurements-Hi-Power finder](#)

**RDS(on) Selecting and configuring measurements- RDS(on).**

1. Select Analyze > Advanced Power Analysis, from the oscilloscope menu bar, and then click the Select navigation tab.
2. Click Switching Analysis to display the switching analysis measurements screen.
3. Click RDS(on) in the Switching Analysis pane. Now, click the Configure button.
4. The following diagram shows equipment setup for RDS(on).



**WARNING.** When connecting to a circuit with hazardous voltages, see the warnings for the individual products and verify that the probes and other components used are within their ratings. Also refer to the topic [General safety summary](#) for more information.

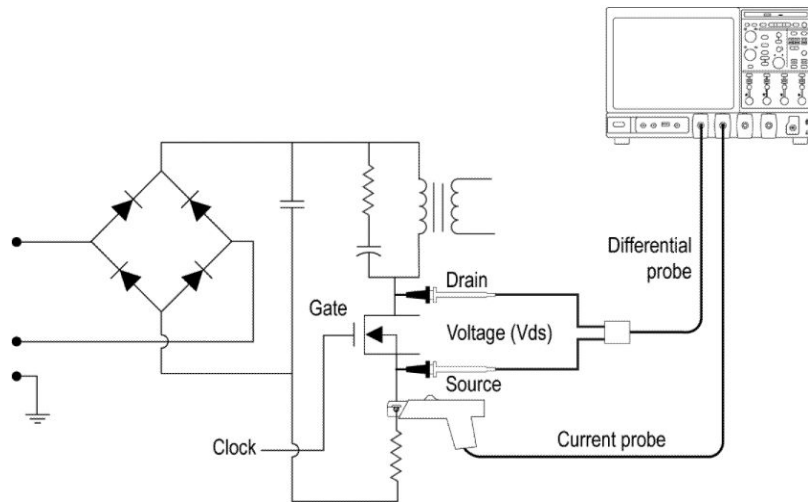

**Figure 10: Equipment setup for RDS(on)**

**Configuring measurements.** Follow the steps to configure the selected measurement:

**NOTE.** The Ref and Deskew options are disabled in the Source Configuration panel as dynamic resistance measures live signals.



1. Configure the options in the Source Configuration Panel.

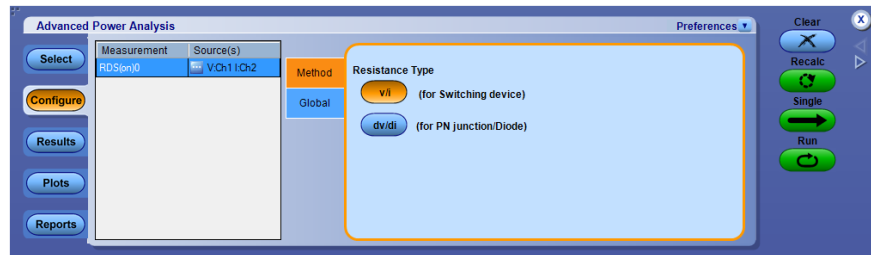

2. There are two methods, first method is  $V/I$ , which is a ratio of instantaneous voltage and current samples. This is suitable for switching devices. The second method is  $dV/dI$ , which is ratio of rate of change of voltage and current. This is suitable for PN junctions and diodes.

The zeros and infinity values of resistance have been interpolated for both methods.

The default method is  $V/I$ .

3. To globally set the coupling, bandwidth limit, cursor gating, and acquisition mode, see [Configuring global settings](#).
4. Press Run to acquire the data.

If the measurement is successful, the application automatically displays the results.

**Viewing results-RDS(on).** Follow these steps to view the results:

1. Select Analyze > Advanced Power Analysis, from the oscilloscope menu bar, and then press Results, to view the results for the Instantaneous RDS(on) and the Average RDS(on). Use the cursor button in the oscilloscope panel to place the cursor.

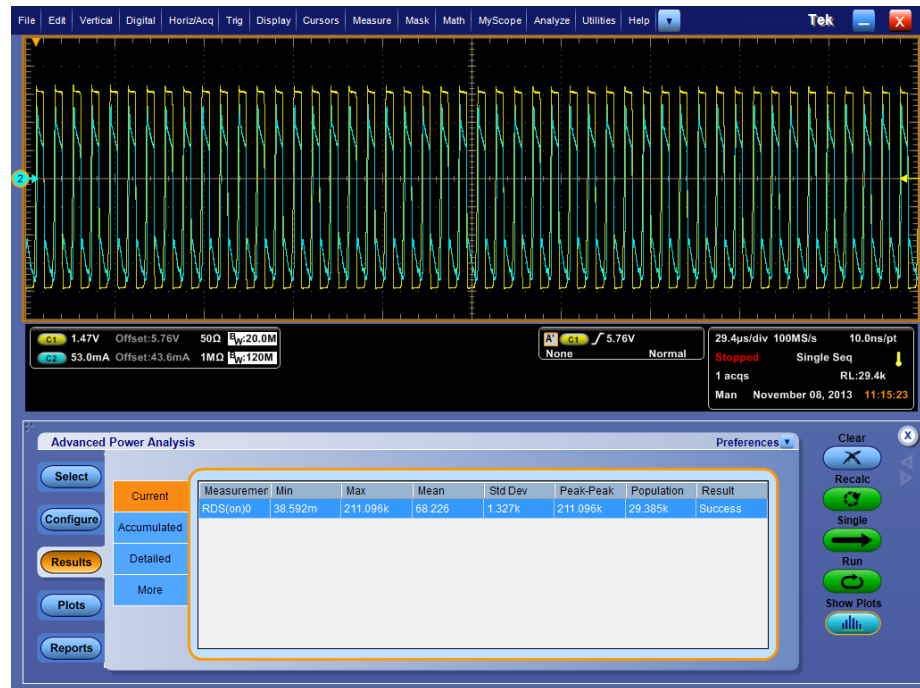

**NOTE.** In some instances, the application may display the result screen with no values. In this happens, use cursor gating to identify the region of interest.

2. Click **Configure** > **Global** and Cursor Gating On button to enable cursor gating.
3. Click Single to measure. When prompted, manually place the cursors in the conduction region to select the desired region of the waveform and click OK. This causes the application to measure the on-resistance only in the selected portion of the waveform.
4. The application displays the Destination, the Minimum, the Maximum and the Average values of the Instantaneous RDS(on). If you select the Run mode, the application automatically updates the resistance values in the table.

If the Time Trend plot is selected, click Show Plots to display the plot.

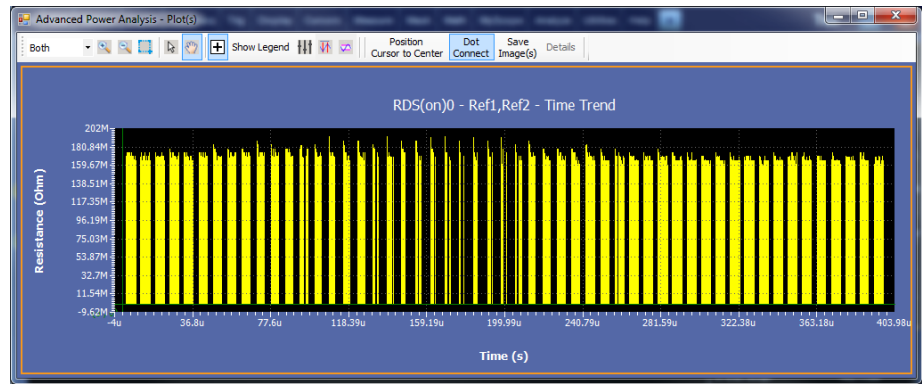

**See also.**

*Selecting and configuring measurements-RDS(on)*

*Plot components and features*

**di-dt** **Selecting and configuring measurements-di-dt.** To select and configure Power Quality Measurement, follow these steps:

1. Select Analyze> Advanced Power Analysis, from the oscilloscope menu bar, and then press the Select navigation tab.
2. Click the Switching Analysis tab to display Switching Analysis screen.
3. Click di /dt in the Switching Analysis pane. Now, click the Configure button.
4. The next figure shows a typical equipment setup for di /dt.



**WARNING.** *Warning: When connecting to a circuit with hazardous voltages, see the warnings for the individual products and verify that the probes and other components used are within their ratings. Also refer to the topic [General safety summary](#) for more information.*

**Configuring the measurement.** Follow the steps to configure the selected measurement:

**NOTE.** *The Ref source, Deskew and Voltage in the Source Configuration panel is disabled. You can configure only the Current options.*

1. Configure the Current options in the [Source configuration panel](#).

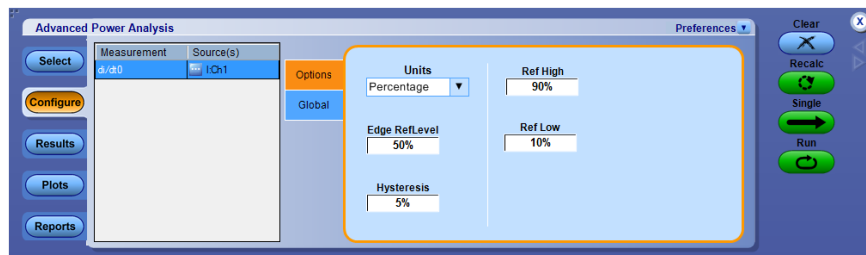

2. Select the Percentage option in the Units combo box to set the Ref Level and Hysteresis values in percentage of the peak-to-peak signal. Select the Absolute option in the Units combo box to set the absolute value of Ref Level and Hysteresis values in amperes. The Ref Level is set to 50% and Hysteresis is set to 5% by default. Configure the high and low level of the edges using Ref High and Ref Low. Default values are set to 90% and 10%.
3. To globally set the coupling, bandwidth limit, cursor gating, and acquisition mode, see [Configuring global settings](#). Ref High and Low set the start and stop regions on the rising and falling edges where this measurement will occur.
4. Press Single to measure.
5. If the measurement is successful, the application automatically displays the results.

**Viewing results-di-dt.** To view the results, follow these steps:

1. From the oscilloscope menu bar, select Analyze > Advanced Power Analysis, and then press Results.
2. All the edge results are displayed in the results table, Rise & Fall edges are tabulated separately.

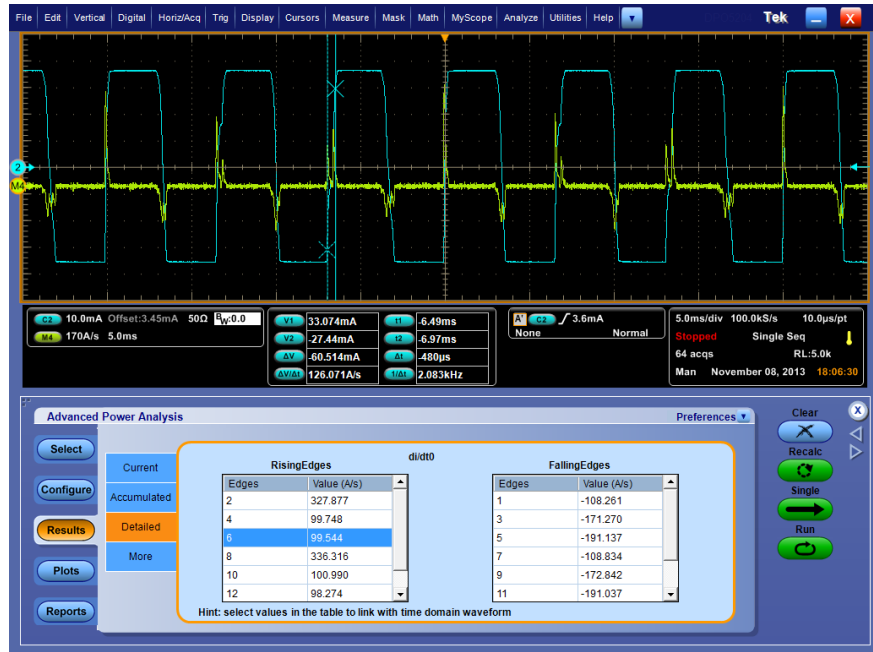

3. Click an edge in the detailed results to associate the edge with the cursors.

### Viewing plots-di-dt

If Time Trend and Histogram plots are selected, click Show Plots to display the plot.

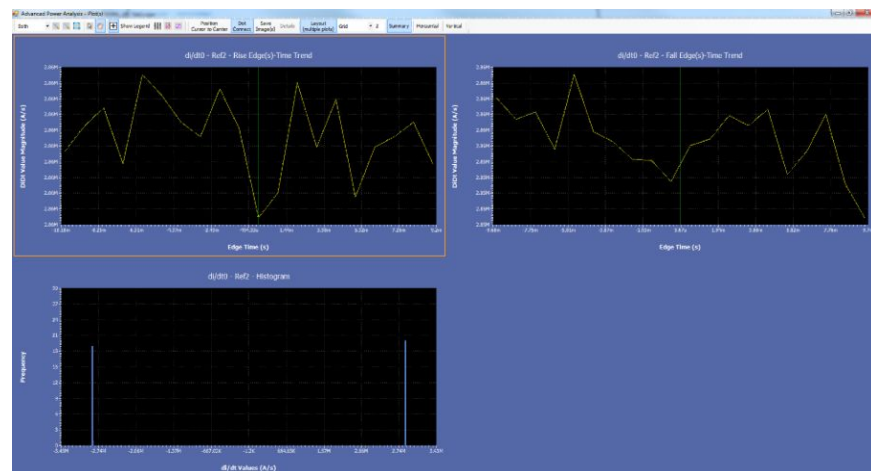

**See also.**

*Selecting and configuring measurements-di-dt*

*Plot components and features*

**dv-dt    Selecting and configuring measurements-dv-dt.**

1. From the oscilloscope menu bar, select Analyze> Advanced Power Analysis, and then press the Select navigation tab.
2. Click Switching Analysis to display the Switching Analysis screen.
3. Click dv/dt in the Measurements pane.
4. Click the Configure button.



**WARNING.** When connecting to a circuit with hazardous voltages, see the warnings for the individual products and verify that the probes and other components used are within their ratings. Also refer to the topic [General safety summary](#) for more information.

**Configuring the measurement.** Follow the steps to configure the selected measurement:

**NOTE.** Ref, Current, Deskew and I-Probe Settings in the Source Configuration panel is disabled. You can configure only the Voltage options.

1. Configure the Voltage options in the [Source configuration panel](#).

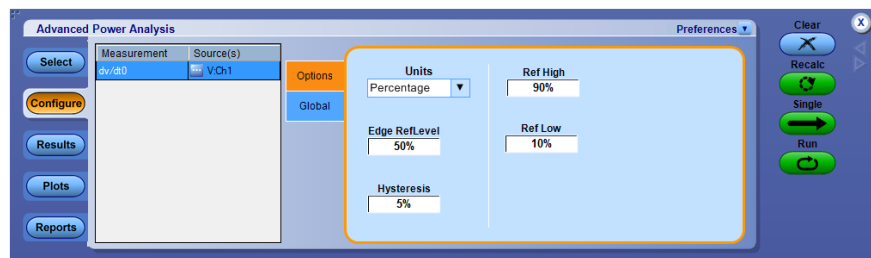

2. Select Percentage from the Units combo box to set the Ref Level and Hysteresis values in percentage of the peak-to-peak signal. Select Absolute from the Units combo box to set the absolute value of Ref Level and Hysteresis values in volts. Configure the high and low level of the edges using Ref High and Ref Low. Default values are set to 90% and 10%.
3. To globally set the coupling, bandwidth limit, cursor gating, and acquisition mode, see [Configuring global settings](#).
4. Press Single to measure.

If the measurement is successful, the application automatically displays the results.

**Viewing results-dv-dt.** To view the results, follow these steps:

1. All the edge results are displayed in the results table, Rise & Fall edges are tabulated separately.
2. Click an edges number to position the oscilloscope cursors on the High and Low levels of the waveform and on the edge you have set. This displays the updated results for the selected edge.

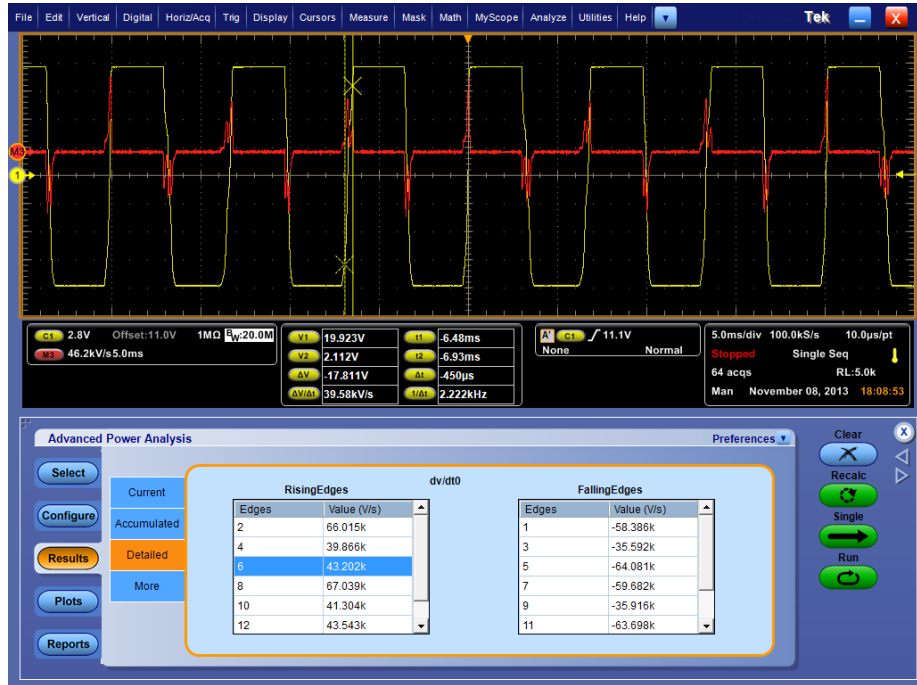

3. The application displays the results, which is a differential of the voltage waveform with respect to time in units of volts per microsecond.

**NOTE.** If you observe the cursor positions on the oscilloscope screen in the following figure, the absolute values of the signal level read by the cursor does not match with the entered high and low levels in the result panel. This is because the values entered in Low and High levels may lie in between the samples of the waveform. This happens for di/dt and dv/dt measurements.

### Viewing plots-dv-dt

If a Rise Edge, Fall Edge, or Histogram plot is selected, click Show Plots to display the plot.





See also.

*Selecting and configuring measurements-dv-dt*

*Plot components and features*

**Safe operating area**      **Selecting and configuring measurements-Safe operating area.**

1. From the oscilloscope menu bar, select Analyze > Advanced Power Analysis, and then click the Select tab.
2. From the Switching Analysis tab, select the Safe Operating Area (SOA) measurement. Select the Configure option.

The next figure shows a typical equipment setup for Safe Operating Area.

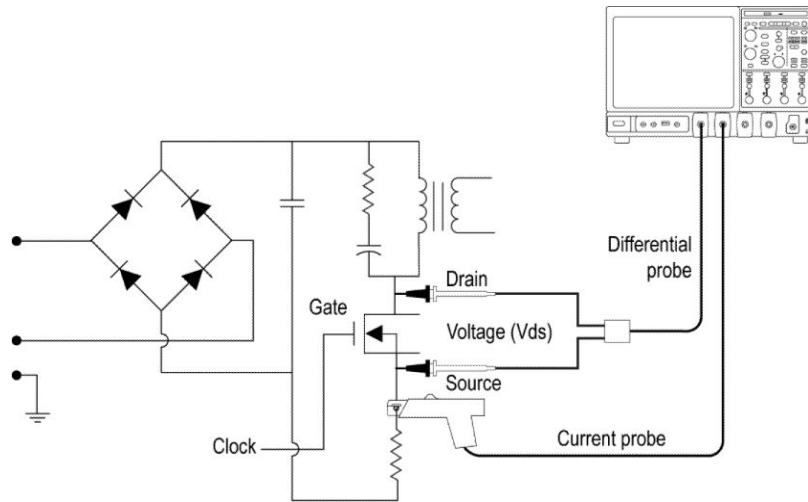

**Figure 11: Equipment setup for Safe Operating Area**



**WARNING.** When connecting to a circuit with hazardous voltages, see the warnings for the individual products and verify that the probes and other components used are within their ratings. Also refer to the [General safety summary](#) topic for more information.

**Configuring measurements.** Follow the steps to configure the selected measurement:

1. Select SOA.

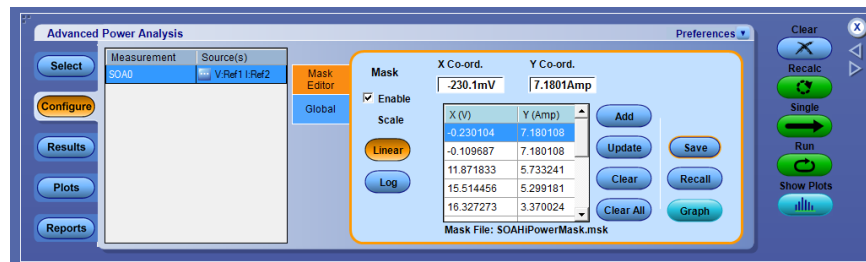

**Figure 12: SOA configuration**

2. Configure the options in the Source Configuration Panel.

---

**NOTE.** Make sure there are waveforms on the oscilloscope or the application displays an error message.

---

Plot Type	Description
SOA	Plots the Voltage and Current waveform in a single record in XY mode

3. Double-click the Mask X and Mask Y fields and use the keypad that appears to set the XY coordinates of mask values.
4. Click the Add button to add the mask values as a new mask point.
5. Click the Update button to update the selected mask point with the new mask values.
6. Click the Clear button to remove the selected mask point.
7. Click Clear All to remove all mask points.
8. Click the Save button to save the mask.
9. Click the Recall button to retrieve a saved mask from the default directory or the directory where you have saved the mask.
10. Click Graph to display a preview of the mask.
11. In the Global tab, click On or Off in the Cursor Gating panel to enable cursor gating. Press the Run or Single button. If Cursor Gating is on, the message "Set cursors to required position" is displayed. Select OK to display the results for the selected portion of the waveform.
12. In the Mask Pane of the Config tab, select Enable to define and apply masks on the SOA plot. If the Enable is selected and there is no mask defined, selecting the Run button displays a warning message, "SOA Mask is enabled, but not defined. Do you wish to continue?". Select Yes to continue without the mask.
13. Press Run to display the SOA plot.
14. Place the cursor on the plot to display the following results:
  - Voltage value
  - Current value
  - Power value

**Viewing results-Safe operating area.** The SOA Measurement plots the current and waveform results in the SOA Plot. Follow these steps to view the results:

1. From the oscilloscope menu bar, select Analyze > Advanced Power Analysis, and then click Results.
2. The application displays the SOA results as shown below:

### SOA results



3. Click Plot to display the SOA0 plot.

### SOA plots

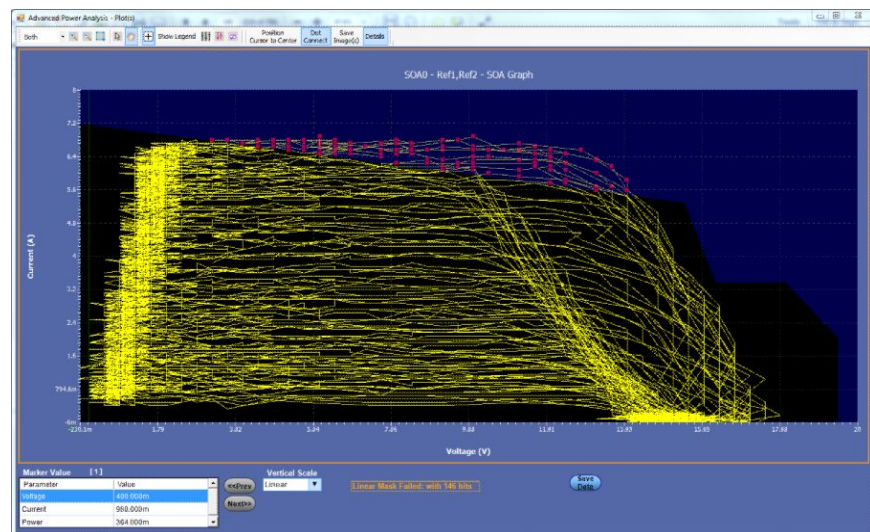

SOA Plot gives information about current vs voltage waveforms and mask. When user selects the point on SOA plot, it creates the list of points nearby region and updates the Marker value Table. It also zoom the region on scope, where this points present in time domain. User can travels through Marker Value Table points in various cycles. It allows to analyze waveform region on oscilloscope, where waveform violates the mask coordinates.

4. In the Global tab, click On or Off in the Cursor Gating panel to enable cursor gating. Press the Run button to display the message, "Set cursors to required position."
5. Select Yes to run the application. The Cursor Linkage allows you to locate the point in a SOA plot to the time domain waveform and link the data index of the waveform. Place the cursor at the region of the waveform you want to plot SOA and display the plotted area.
6. Select the Detailed tab. Click Plot to display the plot.
7. Click Save to save the plot data in .csv format. The default directory and the file name is C: \User\Public\ TekApplications \Advanced Power Analysis\.

---

**NOTE.** When you change from Linear to Log-Log, the mask does not get converted between Linear and Log-Log scales. However plot data does get converted when Linear to Log or Log to Linear is changed.

---



---

**NOTE.** If the Cursor control button is enabled, the zoom buttons are disabled.

---

8. Place the Cursor to select any data point in the plot.
9. Click the + button to zoom in. Drag the mouse to define the area of interest. Click the – button to zoom out. You can use the + and – buttons until the application reaches the maximum and the minimum zoom limit. You can use the Zoom buttons in three different ways:
  - Dragged zoom-in: where the area is selected by dragging on the displayed window
  - Single-clicked zoom-in: when a point is clicked on the displayed window, the resulting window is equal to 1/4th of the displayed window.
  - Single-clicked zoom-out: when a point is clicked on the displayed window, the resulting plot is the previous zoom state of the displayed window.
10. Select the Reset Display option to restore the plot to its original display after zooming.
11. Use the cursor in the oscilloscope and the Link button to link the waveform from the SOA plot. When you select the Link button, the plot automatically resizes to the half screen mode. The Link Cursor Position field displays the number of occurrences of the particular data points. Here minimum is 1 and maximum is the number of occurrences of data points.

12. Place the cross hair cursor at the point of interest on the plot and press the Link button. This enables the cursor on the oscilloscope and places it on the waveform corresponding to the selected data point in the plot panel.
13. In case of multiple occurrences, select the Prev button to select the previous data point and the Next button to select the next data point.
14. You can view the plot and the time domain waveform simultaneously. Select the Link check box to select the data point to link the waveform in the oscilloscope to the SOA Plot. Place the cross hair cursor on the plot and enter the values in the Cursor Linkage Occurrences field. Use the Zoom button to zoom the area of interest in the plot and display in the oscilloscope.

---

**NOTE.** *You can view the result either in the half screen mode or in the full screen mode.*

---

15. The application displays the result for Voltage, Current, Power, Mean Power and Standard Deviation at the cursor location.

**See also.**

*Selecting and configuring measurements-Safe operating area*

*Plot components and features*

**SOA overlay.** Select the Save Plot button in the SOA Graph plot from the Detailed results window to save the plot as a . plt file before using this utility.

**Purpose:** Plot, view, and compare SOA Plots of the device operating at various load conditions. The SOA Overlay utility helps you to overlay multiple SOA plots simultaneously. Use this feature to view multiple plots on the same grid.

Initially, the application adjusts the SOA scale according to the selected plot(s) but you can also observe the plot for the voltage and current range of operation under various conditions.

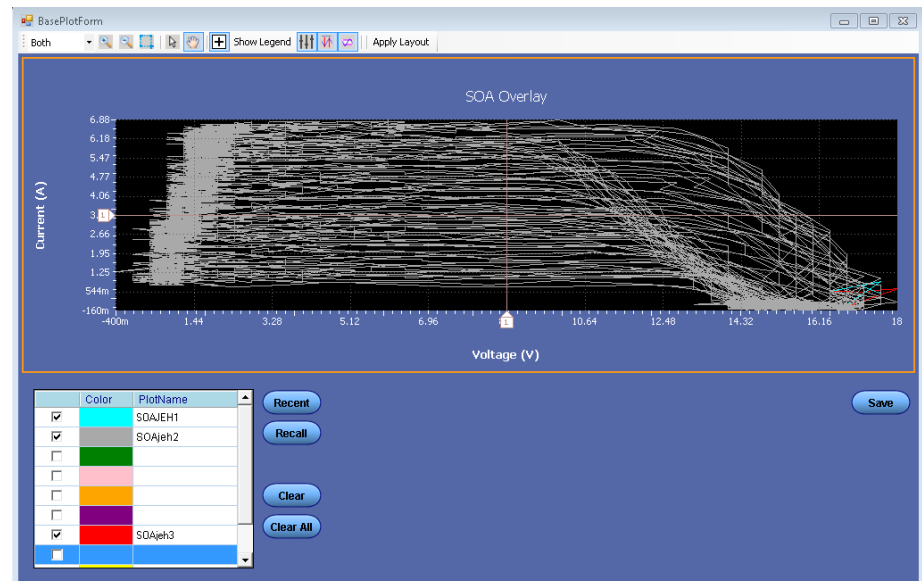

The X-axis represents the voltage values in volts and the Y-axis represents the current in amperes.

Follow these steps to perform SOA Overlay:

1. Click the Recent button to automatically load the SOA plots saved in the current run of the application.

You can load only the last ten plots. Select the Recall button to manually load the SOA plots from any folder or from the default folder C: \Users\Public \Tektronix\TekApplications\Advanced Power Analysis\SOA\Data directory. You can load any of the ten plots.

2. Click the Plot selection check box next to the plot name to display the SOA plot on the grid area of the screen. When the utility displays the first plot, it automatically scales the plot. Continue this procedure to overlay and display all the plots. SOA Overlay displays the plot based on the color set in the Plot Name pane. The most recently selected plot is drawn over the previously selected plots. You can simultaneously view and compare different SOA plots under multiple conditions.
3. Click the Plot Name and then the Clear button to remove the plot from the grid area.

4. Click the Clear All button to clear all the plots from the grid area.
5. Select the Save button to save the plot as a .csv file to any folder of your choice or to the default folder C: \User\Public\ Tektronix\TekApplications \Advanced Power Analysis\.
6. Click OK to close the display window.

**SOA Saving waveforms when mask fails.** In Free Run mode, if there are any violation of SOA Mask, the failed incidents with their corresponding V, I waveforms will be saved. The first run will save SOA mask fails at *C:\Users\Public\TekApplications\Advanced Power Analysis\MaskFail Waveforms\ Run1*. Each mask failure will save two waveforms in the RUN folder and the folder can have maximum twenty waveform files (ten failures).

For the first twenty five runs, folders will be created and the failed incidents will be saved to respective folder. The twenty sixth run will overwrite the first run folder saved data i.e. Run1 with user approval and so on.

---

**NOTE.** Waveforms will not be saved if there is no enough available space to waveform. User need to make sure there is enough available space in C drive.

---

#### **Example**

*C:\Users\Public\TekApplications\Advanced Power Analysis\MaskFail Waveforms\ Run1* corresponds to first run which has mask failed waveforms saved in it.



## Safe operating area X-Y

## Selecting and configuring measurements-Safe operating area X-Y.

1. From the oscilloscope menu bar, select Analyze > Advanced Power Analysis, and then press the Select navigation tab.
2. From the Switching Analysis tab, select the SOA X-Y measurement. Select the Configure option.

The next figure shows equipment setup for Safe Operating Area X-Y.

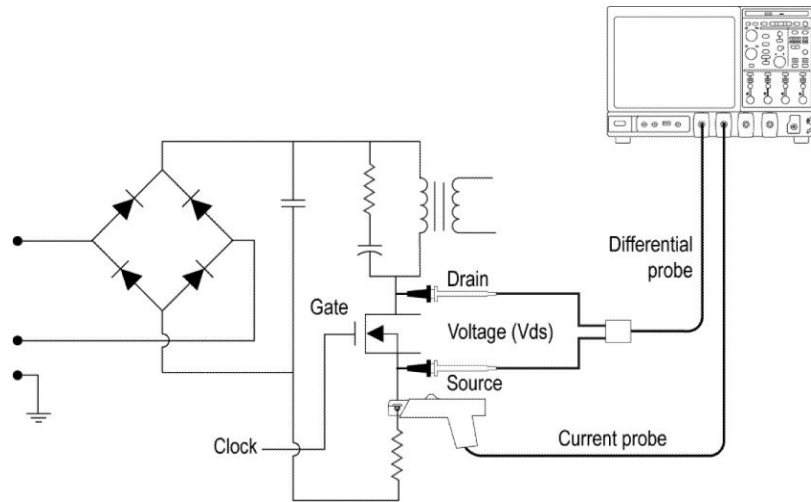

Figure 13: Equipment setup for Safe Operating Area X-Y



**WARNING.** When connecting to a circuit with hazardous voltages, see the warnings for the individual products and verify that the probes and other components used are within their ratings. Also refer to the topic [General safety summary](#) for more information.

**Configuring measurements.** Follow the steps to configure the selected measurement:

1. Select SOA X-Y.

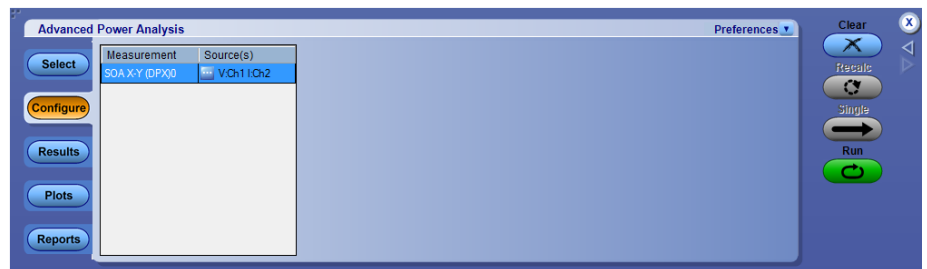

- Configure the options in the Source Configuration Panel.

**NOTE.** Make sure that there are waveforms on the oscilloscope or the application displays an error message.

Plot Type	Description
SOA X-Y (DPX)	Measures and plots the voltage and current waveforms using the XY mode display of the oscilloscope. Use this option to measure multiple acquisitions of the same waveform in real time testing

- Press Run to display the SOA X-Y plot.

**Viewing results-Safe operating area X-Y.** The SOA Measurement plots the current and waveform results in the SOA Plot. Follow these steps to view the results.

**Viewing Results for SOA X-Y (DPX).** You can view the result in the oscilloscope as a real time plot.

**NOTE.** For frequencies  $<4$  GHz, select the paired channels as Ch1 and Ch2 or Ch3 and Ch4. For frequencies  $\geq 4$  GHz, select the paired channels as Ch1 and Ch3 or Ch2 and Ch4.



**See also.**

[Selecting and configuring measurements-Safe operating area X-Y](#)

[Plot components and features](#)

## Timing measurement and analysis

### Pulse width **Selecting and configuring measurements-Pulse width.**

1. From the oscilloscope menu bar, select Analyze > Advanced Power Analysis. The application launches with the Select tab (default) displaying the category of measurements.
2. Select Timing Analysis; click Pulse Width in the measurement pane.
3. Click Configure to configure the measurement.

The following figure shows equipment setup for Pulse Width analysis.

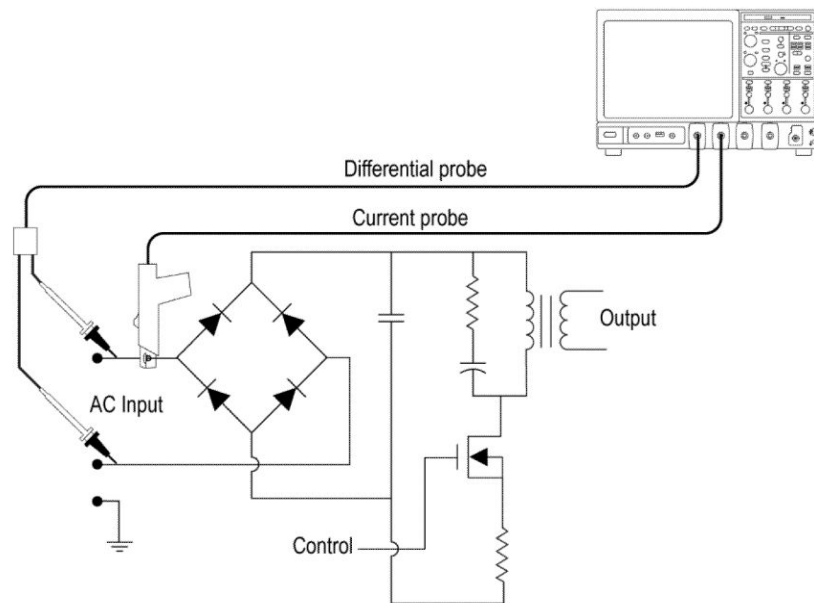

**Figure 14: Equipment setup for Pulse Width analysis**



**WARNING.** When connecting to a circuit with hazardous voltages, see the warnings for the individual products and verify that the probes and other components used are within their ratings. Also refer to the topic [General safety summary](#) for more information.

### Configuring the measurement.

Follow the steps to configure the Pulse Width measurement:

1. Configure the [Source configuration](#) for the measurement. Click  for the measurement for source configuration.
2. Configuration under Edge tab:
  - Select the Polarity by clicking either Positive or Negative.

3. Configuration under Options tab:

- Set the Units to Absolute or Percentage. If you select Absolute, the application displays the Ref Level and Hysteresis in Volts.
- Set Ref level value within the range 100 mV to 5.99 KV for absolute units and 1% to 99% for units as percentage. The Default value is 0V and 50%.
- Set Hysteresis value within the range 0V to 3 KV for absolute units and 1% to 99% for units as percentage. The Default value is 6V and 5%.

4. Configuration under Global tab:

See [Configuring global settings](#) to set the coupling, bandwidth limit, cursor gating and acquisition mode.

5. Click Run to acquire the data. If the measurement is successful, the application displays the results.

---

**NOTE.** *The application replaces any data in the selected ref destination when you analyze and measure timing analysis. You do not get a warning message here.*

---

**Viewing results-Pulse width.** Click Results to view the result for the selected Pulse Width measurement.



**Viewing plots-Pulse width.** Click Plots and select Time Trend to view the plots for the selected Pulse Width measurement.

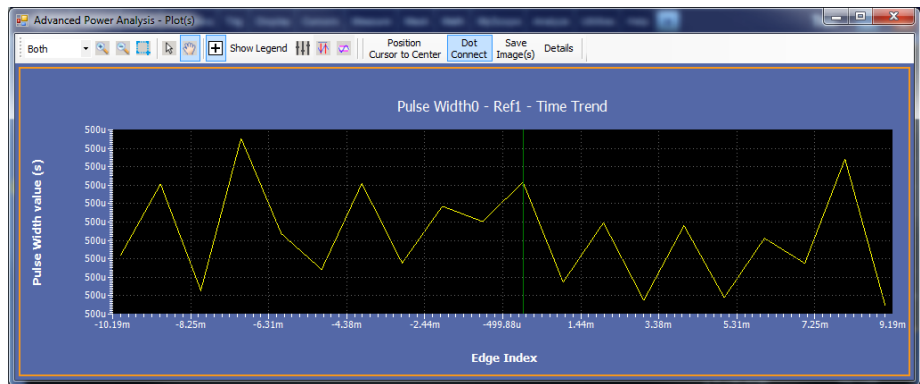

**See also.**

[Selecting and configuring measurements-Pulse width](#)

[Plot components and features](#)

**Duty cycle    Selecting and configuring measurements-Duty Cycle.**

1. From the oscilloscope menu bar, select Analyze > Advanced Power Analysis. The application launches with the Select tab (default) displaying the category of measurements.
2. Select Timing Analysis; click Duty Cycle in the measurement pane.
3. Click Configure to configure the measurement.

**Configuring the measurement.**

Follow the steps to configure the Duty Cycle measurement:

1. Configure the *Source configuration* for the measurement. Click  for the measurement for source configuration.
2. Configuration under Edge tab:
  - Select the Edge Type by clicking either Rise or Fall.
  - Select the Polarity by clicking either Positive or Negative.
3. Configuration under Options tab:
  - Set the Units to Absolute or Percentage. If you select Absolute, the application displays the Ref Level and Hysteresis in Volts.
  - Set Ref level value within the range 100 mV to 5.99 KV for absolute units and 1% to 99% for units as percentage. The Default value is 0V and 50%.
  - Set Hysteresis value within the range 0V to 3 KV for absolute units and 1% to 99% for units as percentage. The Default value is 6V and 5%.
4. Configuration under Global tab:

See *Configuring global settings*. to set the coupling, bandwidth limit, cursor gating and acquisition mode.
5. Click Run to acquire the data. If the measurement is successful, the application displays the results.

---

**NOTE.** *The application replaces any data in the selected ref destination when you analyze and measure timing analysis. You do not get a warning message here.*

---

**Viewing results-Duty cycle.** Click Results to view the result for the selected Duty Cycle measurement.

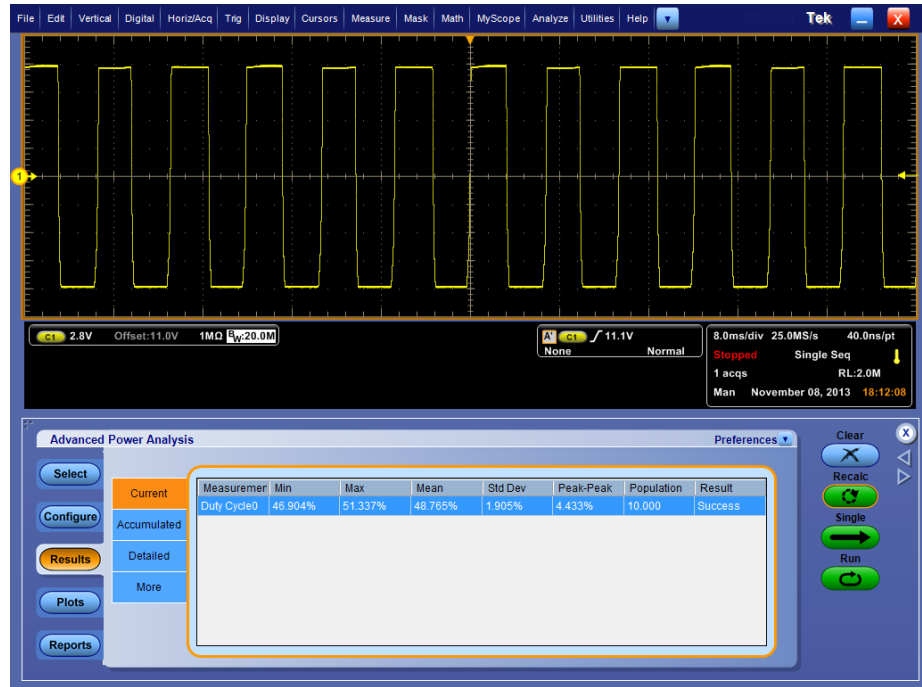

**Viewing plots-Duty cycle.** Click Plots and select Time Trend to view the plots for the selected Duty Cycle measurement.

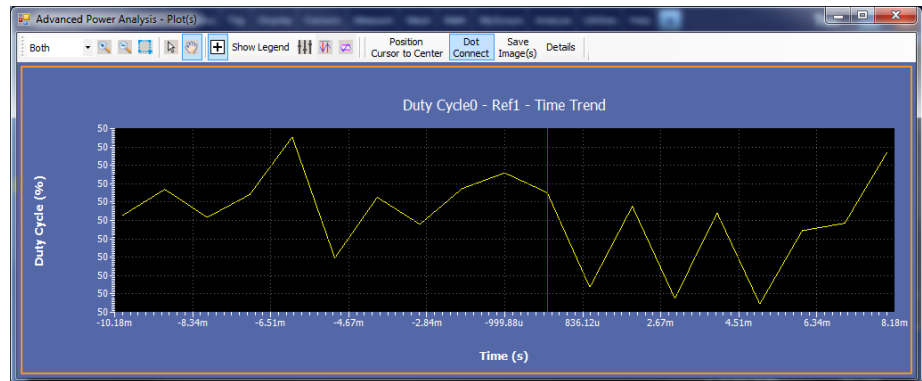

**See also.**

*Selecting and configuring measurements-Duty cycle*  
*Plot components and features*

**Period    Selecting and configuring measurements-Period.**

1. From the oscilloscope menu bar, select Analyze > Advanced Power Analysis. The application launches with the Select tab (default) displaying the category of measurements.
2. Select Timing Analysis; click Period in the measurement pane.
3. Click Configure to configure the measurement.

**Configuring the measurement.**

Follow the steps to configure the Period measurement:

1. Configure the *Source configuration* for the measurement. Click  for the measurement for source configuration.
2. Configuration under Edge tab:
  - Select the Edge Type by clicking either Rise or Fall.
3. Configuration under Options tab:
  - Set the Units to Absolute or Percentage. If you select Absolute, the application displays the Ref Level and Hysteresis in Volts.
  - Set Ref level value within the range 100 mV to 5.99 KV for absolute units and 1% to 99% for units as percentage. The Default value is 0V and 50%.
  - Set Hysteresis value within the range 0V to 3 KV for absolute units and 1% to 99% for units as percentage. The Default value is 6V and 5%.
4. Configuration under Global tab:

See *Configuring global settings*. to set the coupling, bandwidth limit, cursor gating and acquisition mode.
5. Click Run to acquire the data. If the measurement is successful, the application displays the results.

---

**NOTE.** *The application replaces any data in the selected ref destination when you analyze and measure modulation. You do not get a warning message here.*

---



**Viewing results-Period.** Click Results to view the result for the selected Period measurement.



**Viewing plots-Period.** Click Plots and select Time Trend to view the plots for the selected Period measurement.

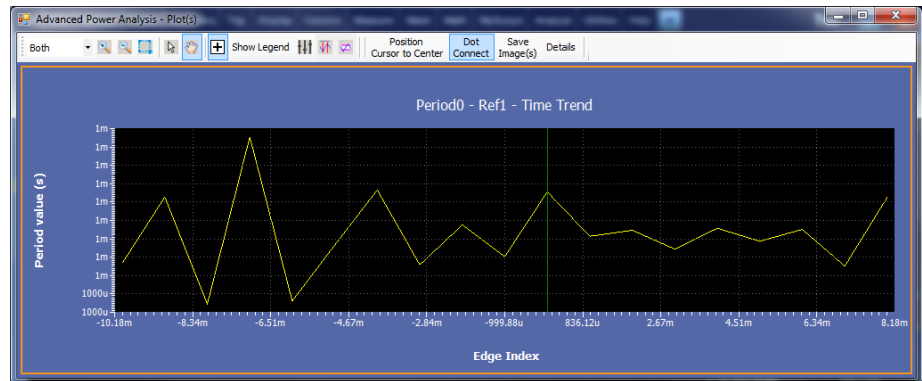

**See also.**

*Selecting and configuring measurements-Period*  
*Plot components and features*

## Frequency **Selecting and configuring measurements-Frequency.**

1. From the oscilloscope menu bar, select Analyze > Advanced Power Analysis. The application launches with the Select tab (default) displaying the category of measurements.
2. Select Timing Analysis; click Frequency in the measurement pane.
3. Click Configure to configure the measurement.

### **Configuring the measurement.**

Follow the steps to configure the Frequency measurement:

1. Configure the *Source configuration* for the measurement. Click  for the measurement for source configuration.
2. Configuration under Edge tab:
  - Select the Edge Type by clicking either Rise or Fall.
3. Configuration under Options tab:
  - Set the Units to Absolute or Percentage. If you select Absolute, the application displays the Ref Level and Hysteresis in Volts.
  - Set Ref level value within the range 100 mV to 5.99 KV for absolute units and 1% to 99% for units as percentage. The Default value is 0V and 50%.
  - Set Hysteresis value within the range 0V to 3 KV for absolute units and 1% to 99% for units as percentage. The Default value is 6V and 5%.
4. Configuration under Global tab:

See *Configuring global settings*. to set the coupling, bandwidth limit, cursor gating and acquisition mode.
5. Click Run to acquire the data. If the measurement is successful, the application displays the results.

---

**NOTE.** *The application replaces any data in the selected ref destination when you analyze and measure modulation. You do not get a warning message here.*

---

**Viewing results-Frequency.** Click Results to view the result for the selected Frequency measurement.



**Viewing plots-Frequency.** Click Plots and select Time Trend to view the plots for the selected Frequency measurement.

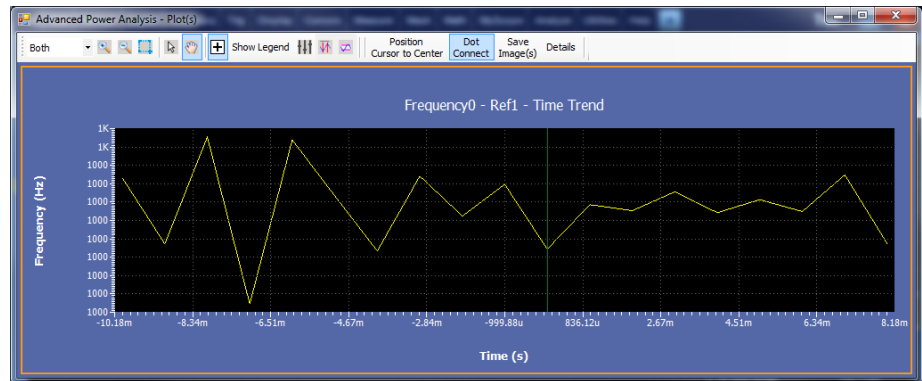

**See also.**

*Selecting and configuring measurements-Frequency*  
*Plot components and features*

**Skew Selecting and configuring measurements-Skew.**

1. From the oscilloscope menu bar, select Analyze > Advanced Power Analysis. The application launches with the Select tab (default) displaying the category of measurements.
2. Select Timing Analysis; click Skew in the measurement pane.
3. Click Configure to configure the measurement.

**Configuring the measurement.**

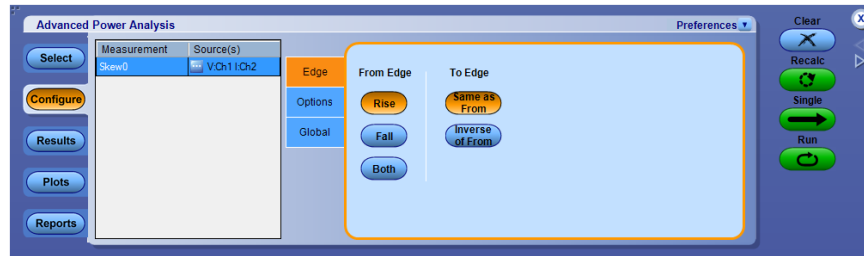

Follow the steps to configure the Skew measurement:

1. Configure the *Source configuration* for the measurement. Click  for the measurement for source configuration.
2. Configuration under Edge tab:
  - Click From Edge as Rise, Fall or Both.
  - Click From Edge as Rise, Fall or Both and To Edge as Same as From or Inverse of From
3. Configuration under Options tab:
  - Set the Units to Absolute or Percentage. If you select Absolute, the application displays the Ref Level and Hysteresis in Volts.
  - Set Ref level value within the range 100 mV to 5.99 KV for absolute units and 1% to 99% for units as percentage. The Default value is 0V and 50%.
  - Set Hysteresis value within the range 0V to 3 KV for absolute units and 1% to 99% for units as percentage. The Default value is 6V and 5%.

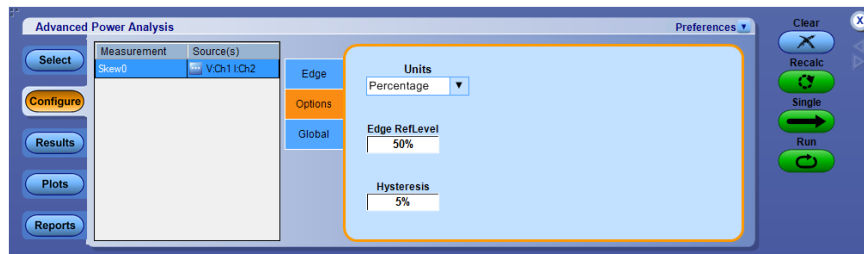

4. Configuration under Global tab:

See [Configuring global settings](#) to set the coupling, bandwidth limit, cursor gating and acquisition mode.

5. Click Run to acquire the data. If the measurement is successful, the application displays the results.

---

**NOTE.** *The application replaces any data in the selected ref destination when you analyze and measure modulation. You do not get a warning message here.*

---

**See also.**

[Viewing results-Skew](#)

**Viewing results-Skew.** Click Results to view the result for the selected Skew measurement.

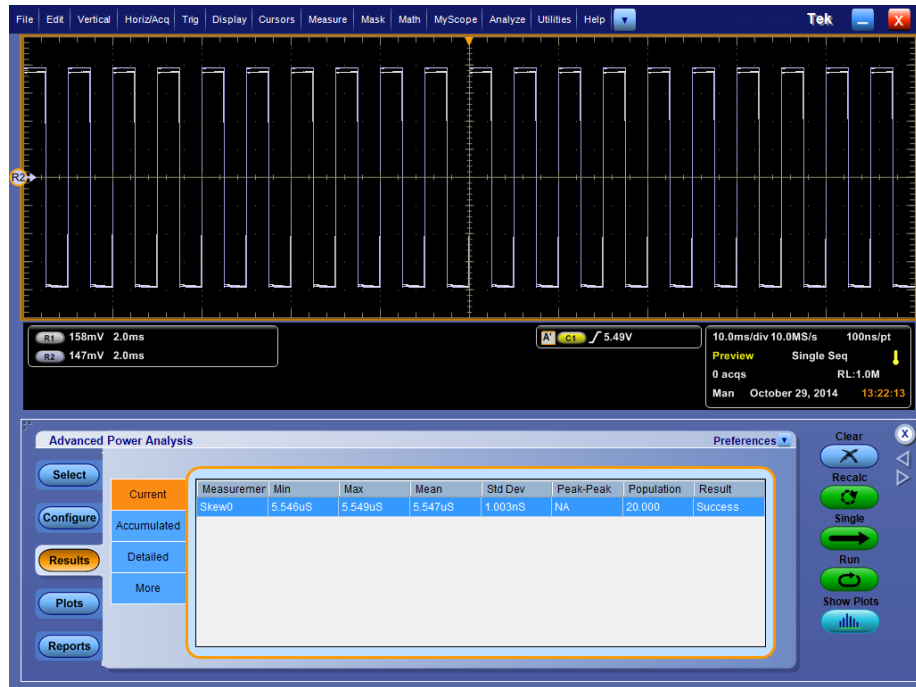

**Viewing plots-Skew.** Click Plots and select Time Trend and/or Histogram to view the plots for the selected Skew measurement.

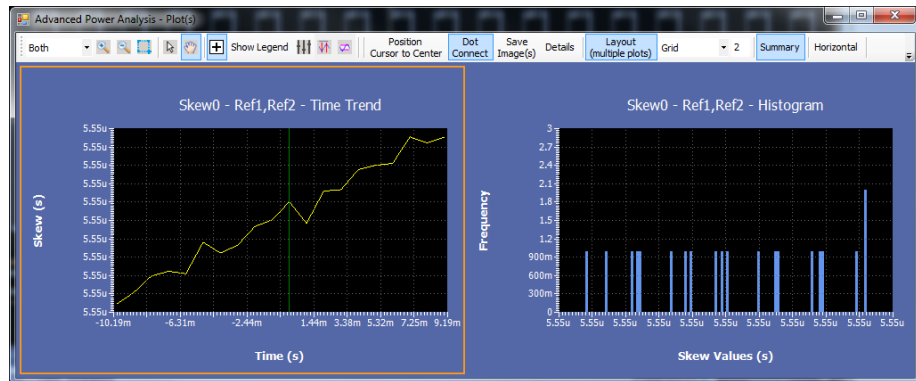

**See also.**

[Selecting and configuring measurements-Skew](#)

[Plot components and features](#)

## Magnetics measurement and analysis

### Inductance **Selecting and configuring measurements-Inductance.**

1. From the oscilloscope menu bar, select Analyze > Advanced Power Analysis. The application launches with the Select tab (default) displaying the category of measurements.
2. Select Magnetics; click Inductance in the measurement pane.
3. Click Configure to configure the measurement.

**NOTE.** When you are measuring the inductance of a transformer, do not load the secondary winding. The measurement of the inductance at the primary winding under no load condition is as good as measuring the inductance for a single winding. When you are measuring the inductance of the coupled inductor with multiple windings on the same core, the measured value of the inductance will deviate from the actual value due to the influence of the current on other winding. You can use this measured value to calculate the Ripple current.

**Configuring the measurement.** Follow the steps to configure the Inductance measurement:

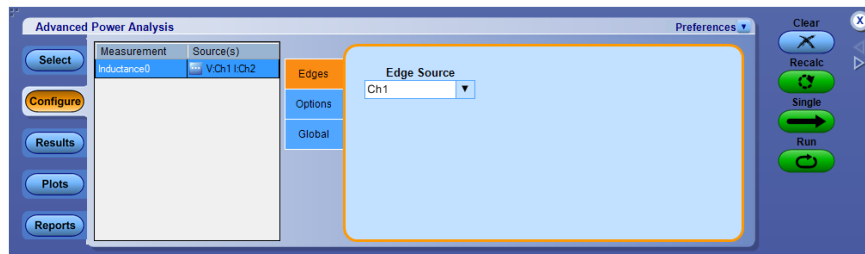

1. Configure the *Source configuration* for the measurement. Click  for the measurement for source configuration.
2. Configuration under Edges tab:
  - Select the Edge Source from the drop-down list.
3. Configuration under Options tab:
  - Set the Units to Absolute or Percentage. If you select Absolute, the application displays the Ref Level and Hysteresis in Volts.
  - Set Ref level value within the range -5.99 kV mV to 5.99 kV for absolute units and 1% to 99% for units as percentage. The Default value is 50V and 50%.

- Set Hysteresis value within the range 0V to 3 KV for absolute units and 1% to 99% for units as percentage. The Default value is 5V and 10%.

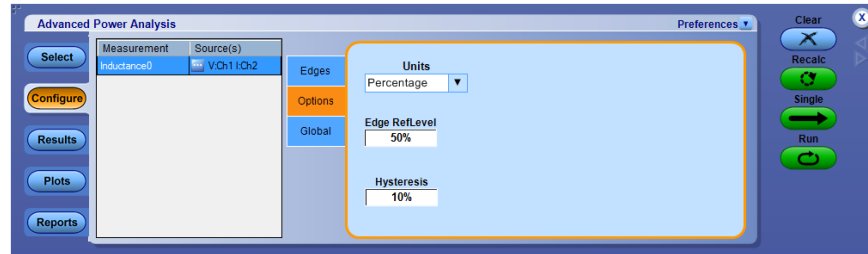

4. Configuration under Global tab:

See [Configuring global settings](#). to set the coupling, bandwidth limit, cursor gating and acquisition mode.

5. Click Run to acquire the data. If the measurement is successful, the application displays the results.

---

**NOTE.** The application replaces any data in the selected ref destination when you analyze and measure Magnetics. You do not get a warning message here.

---



**Viewing results-Inductance.** Click Results to view the result for the selected Inductance measurement.



**Viewing plots-Inductance.** Click Plots and select Inductance curve to view the plots for the selected Inductance measurement.

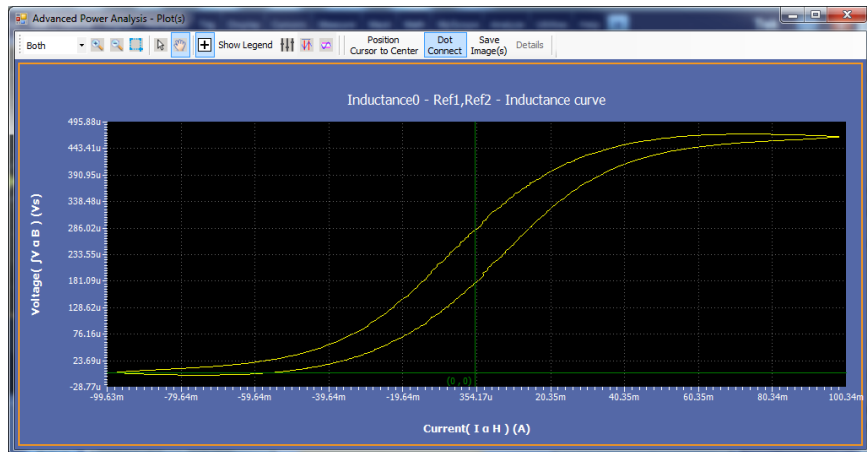

**See also.**

[Selecting and configuring measurements-Inductance](#)

**Magnetic property    Selecting and configuring measurements-Magnetic property.**

1. From the oscilloscope menu bar, select Analyze > Advanced Power Analysis. The application launches with the Select tab (default) displaying the category of measurements.
2. Select Magnetics, and then click Magnetic Property in the measurement pane.
3. Click Configure to configure the measurement.

**Configuring the measurement.** Follow the steps to configure the Magnetic Property measurement:

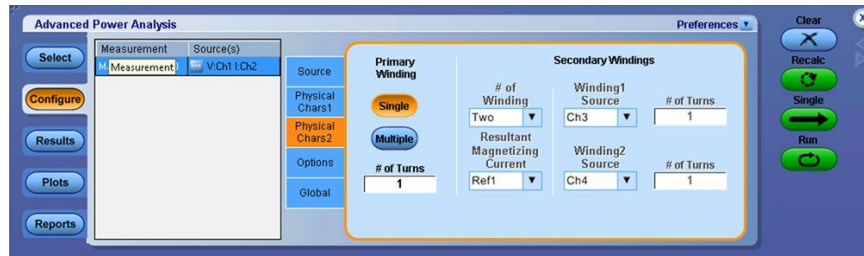

1. Configure the *Source configuration* for the measurement. Click  for the measurement for source configuration.
2. Configuration under Source tab:
  - Select the Voltage Source from the drop-down list and select the **Freq and Duty** as Fixed or Variable.

---

**NOTE.** For the Variable operation, connect the gated drive signal to the edge source because the amplitude of the voltage acquired across the inductor will vary with time.

---

3. Configuration under Physical Chars1 tab:
  - Select the Units as SI or CGS from the drop-down list. If you select SI, the dimensions of the component are measured in meters and units of magnetics in Tesla and Amperes or Turns per meter. If you select CGS, the unit of measurement is centimeter and the result units are in Gauss and Oersted.
  - Double-click the Cross Section Area field and use the keypad that appears to set the cross section dimensions of the magnetic component. The acceptable ranges of the Cross Section Area values are:
    - 1 nm<sup>2</sup> to 1 Mm<sup>2</sup> for SI
    - 1 ncm<sup>2</sup> to 1 Mcm<sup>2</sup> for CGS
  - Double-click the Magnetic Length field and use the keypad that appears to set the cross section dimensions of the magnetic length component. The acceptable ranges of the Cross Section Area values are:
    - 0 m to 1 Mm if you have selected SI
    - 0 cm to 1 Mcm if you have selected CGS

#### 4. Configuration under Physical Chars2 tab:

- Click the Single button for a single winding and enter the number of primary turns.
- Go the step 5 for further configuration.
- Click the Multiple button to configure the "Secondary Windings"

---

**NOTE.** *Magnetic Property with "Multiple" winding configuration cannot be group to run with other measurements. Only one instant of the measurement allow to add with this configuration.*

---

- Configure for the Two "#of winding" : Measure the magnetic property of the components having windings like a coupled inductor or transformer that has multiple windings on the same core.

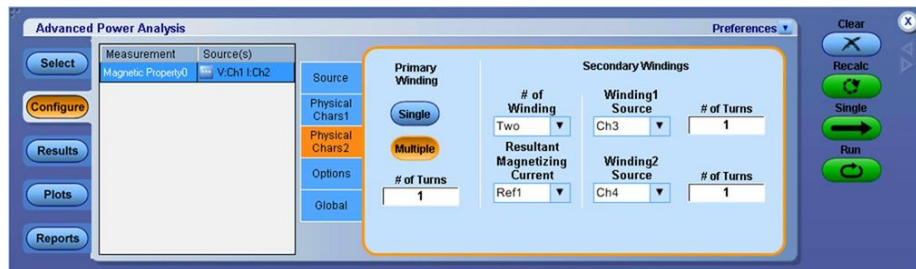

- Select the Secondary Winding1 Source from the drop-down menu and enter the number of turns in the "# of Turns" field.
- Select the Secondary Winding2 Source from the drop-down menu and enter the number of turns in the "# of Turns" field or select Unused from the Winding2 Source drop-down menu in case of having single winding on secondary side.
- Follow the connection combinations of the voltage and current probe at the primary or the main winding at the secondary or the other windings to the · dot as shown in the next figure. The

voltage probe should be connected so that the voltage is read as positive when the current rises.

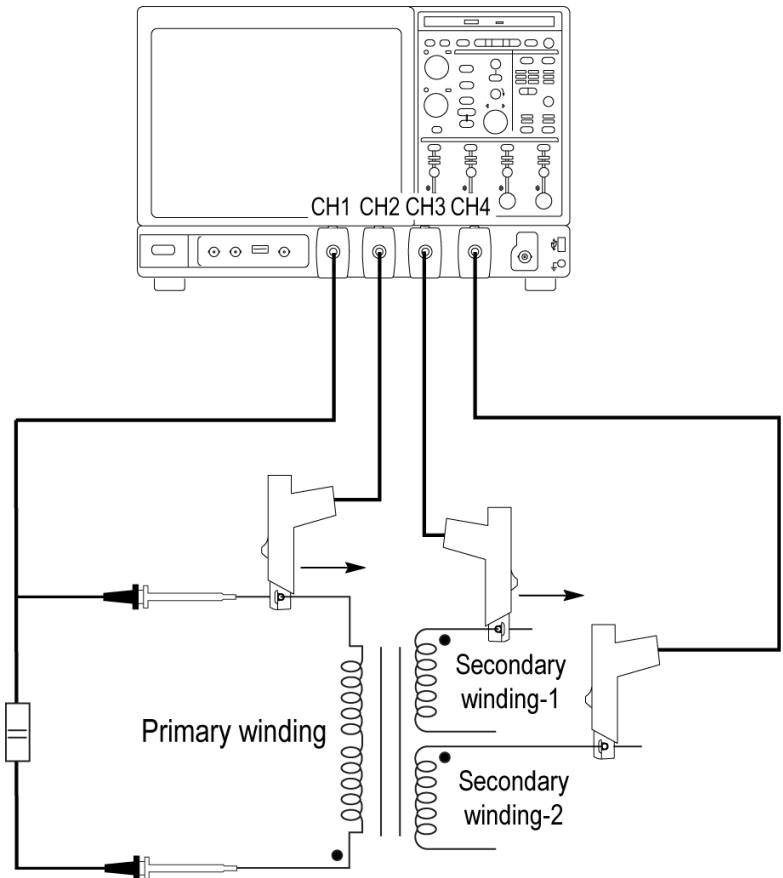

**WARNING.** When connecting to a circuit with hazardous voltages, see the warnings for the individual products and verify that the probes and other components used are within their ratings. Also refer to the topic [General safety summary](#) for more information.

- In the Magnetising Current combo box, select the Ref channel to view the net magnetizing current.

**NOTE.** In case of Ref configuration, selected net "Magnetising Current" source displays over the Ref source on the Oscilloscope. In free Run, the net Magnetising Current gets disabled.

- Configure for the More "#of winding": If you do not have a current probe to acquire the waveform simultaneously on two windings,

select the Multiple Windings pane and follow the procedures given below:

- Select More from the "# of Winding" drop-down menu. This disables the "Secondary Windings" sources.
  - Press the Run button in the application.
- The application acquires the voltage and current waveform of the main winding and prompts you to select a current probe to the Secondary winding. Click Next button if you have another winding.
- Connect the current probe to the other secondary winding. Set # of Turn in the pop up message box and click Next button.
  - Click Ignore button, if you want to ignore the selected secondary winding. This RUN the measurement.
  - In the Magnetising Current combo box, select the Ref channel to view the net magnetizing current.

---

**NOTE.** In case of Ref configuration, selected net "Magnetising Current" source displays over the Ref source on the Oscilloscope.

---

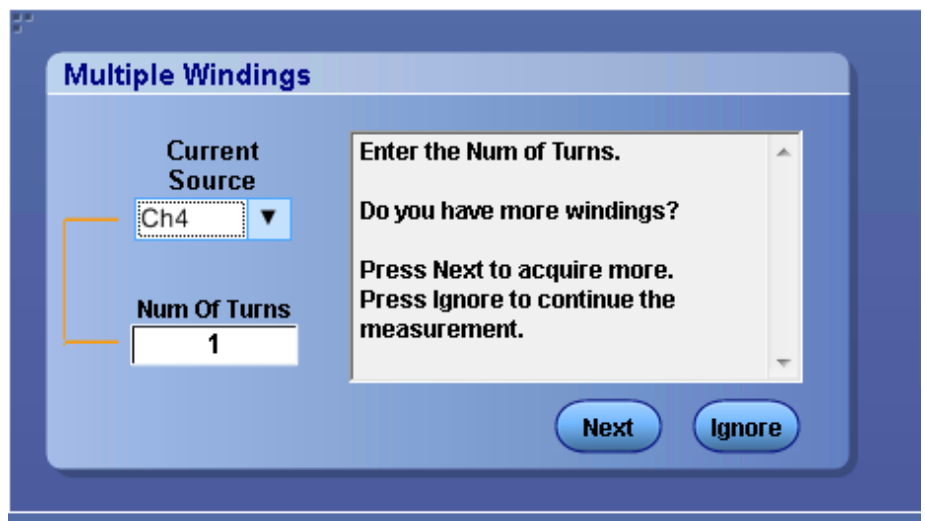
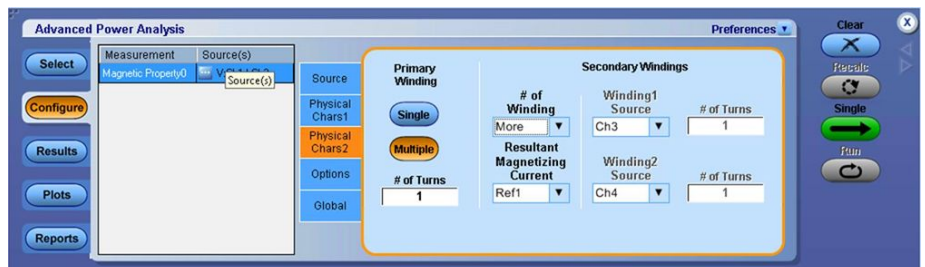

---

**NOTE.** *Selecting Variable duty cycle enables Cursor Gating even if the Cursor Gating selection is Off.*

---

5. Configuration under Options tab:

- Set the Units to Absolute or Percentage. If you select Absolute, the application displays the Ref Level and Hysteresis in Volts.
- Set Ref level value within the range -5.99 kV mV to 5.99 kV for absolute units and 1% to 99% for units as percentage. The Default value is 50V and 50%.
- Set Hysteresis value within the range 0V to 3 KV for absolute units and 1% to 99% for units as percentage. The Default value is 5V and 10%.

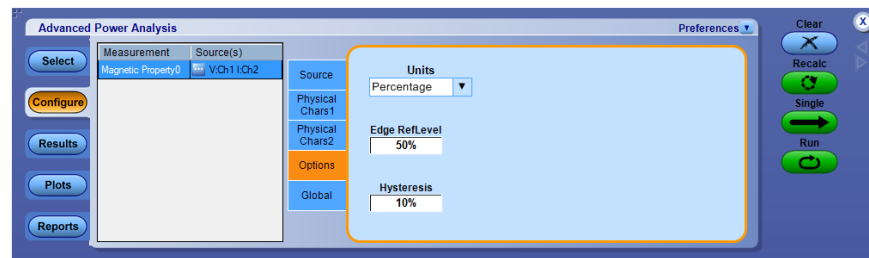

6. Configuration under Global tab:

See [Configuring global settings](#). to set the coupling, bandwidth limit, cursor gating and acquisition mode.

7. After configuration, navigate to the Source Configuration dialog box and then click Vert&Horiz button. It setups the scope channels as per the configuration.
8. Click Run to acquire the data. If the measurement is successful, the application displays the results.

---

**NOTE.** *The application replaces any data in the selected ref destination when you analyze and measure Magnetics. You do not get a warning message here.*

---

**Viewing results-Magnetic property.** Click Results to view the result for the selected Magnetic property measurement.



Field	Description
Bpeak	The maximum magnetic flux density induced in a magnetic component.
Br	The induced magnetic flux density (B) that remains in the material after the externally applied magnetic field (H) is returned to zero while generating the hysteresis loop. Here the maximum value of the Br on the Bpeak cycle is measured.
Hc	The value of H at the intersection of the H-axis and the hysteresis loop. This represents the external field required to cause the induced flux density (B) to reach zero during while measuring a hysteresis loop. Hc is symmetrical with the positive and the negative H-axis.
Hmax	The maximum value of H at the intersection of the H-axis and the hysteresis loop.
I-ripple	The peak-to-peak value of the current.
$\Delta H$	The magnetic field strength
$\Delta B$	The magnetic flux density
Permeability	The measure of the ability of a material to support the formation of its Magnetic field in electromagnetism.

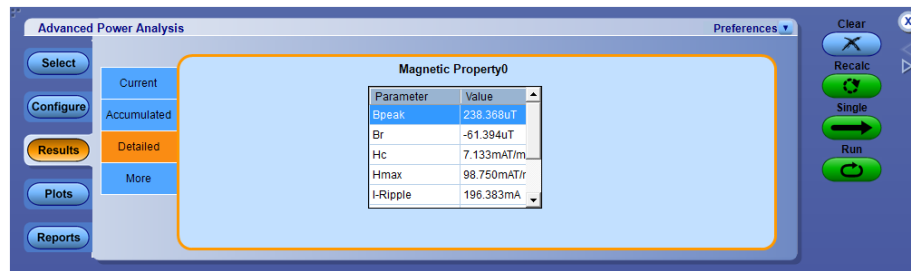

**Viewing plots-Magnetic property.** Click Plots and select BH curve to view the plots for the selected Magnetic property measurement.

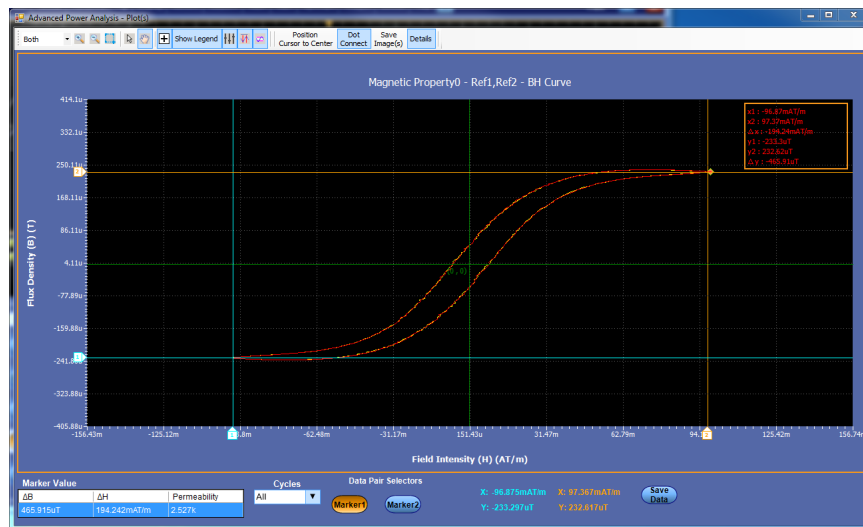

1. Use the Cursor buttons to place the cursor on the maximum flux density curve. Cursor1 and Cursor2 help you calculate the permeability,  $\Delta B$ ,  $\Delta H$  on the region of interest on the maximum flux density curve.
2. The Bpeak button toggles between Bpeak Cycles and All Cycles. When the Bpeak is selected, you can see only the two Bpeak cycles that have the maximum flux density. If the Bpeak is not selected, you can see all the cycles for the component.
3. Click the + button to zoom in. You can zoom up to five times the normal view. Drag the mouse to define the area of interest. Click the - button to zoom out. You can use the + and - buttons until the application reaches the maximum and the minimum zoom limit. You can use the Zoom buttons in three different ways:
  - Dragged zoom-in: where the area is selected by dragging on the displayed window.
  - Single-clicked zoom-in: when a point is clicked on the displayed window, the resulting window is equal to 1/4th of the displayed window.



- Single-clicked zoom-out: when a point is clicked on the displayed window, the resulting plot is the previous zoom state of the displayed window.

---

**NOTE.** *If the current waveform is less than a division high, the application displays an error message, "Unable to find the correct edges". This is because of the variation of data points within single division is very high and hysteresis band is insufficient to find the correct edges. Therefore, for the current waveform, the vertical range should be greater than one division.*

---

4. Select the Reset option to restore the plot to its original display after zooming.

**See also.**

[Selecting and configuring measurements-Inductance](#)

## Magnetic loss **Selecting and configuring measurements - Magnetic loss.**

1. From the oscilloscope menu bar, select Analyze > Advanced Power Analysis. The application launches with the Select tab (default) displaying the category of measurements.
2. Select Magnetics; click Magnetic Loss in the measurement pane.
3. Click Configure to configure the measurement.

**Configuring the measurement.** Follow the steps to configure the Magnetic loss measurement:

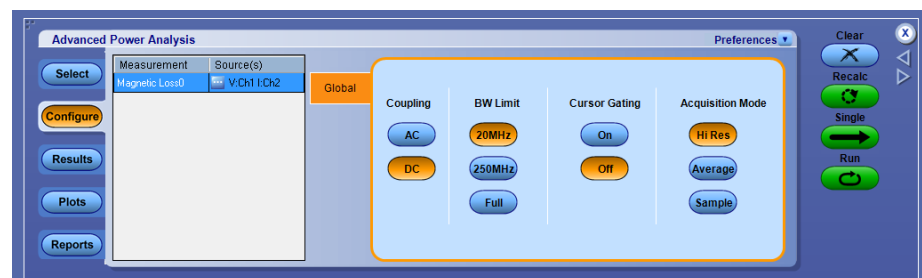

1. Configure the [Source configuration](#) for the measurement. Click  for the measurement for source configuration.
2. Configuration under Global tab:  
See [Configuring global settings](#). to set the coupling, bandwidth limit, cursor gating and acquisition mode.
3. Click Run to acquire the data. If the measurement is successful, the application displays the results.

---

**NOTE.** *The application replaces any data in the selected ref destination when you analyze and measure Magnetics. You do not get a warning message here.*

---

**Viewing results-Magnetic loss.** Click Results to view the result for the selected Magnetic loss measurement.

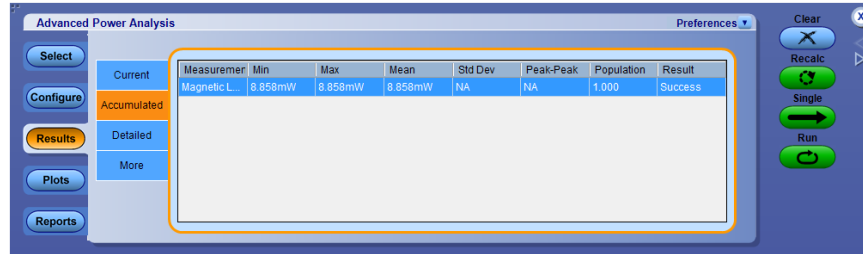

### I vs (integral-of)V Selecting and configuring measurements - I vs $\int V$ .

1. From the oscilloscope menu bar, select Analyze > Advanced Power Analysis. The application launches with the Select tab (default) displaying the category of measurements.
2. Select Magnetics; click I vs  $\int V$  in the measurement pane.
3. Click Configure to configure the measurement.

**Configuring the measurement.** Follow the steps to configure the Magnetic Property measurement:

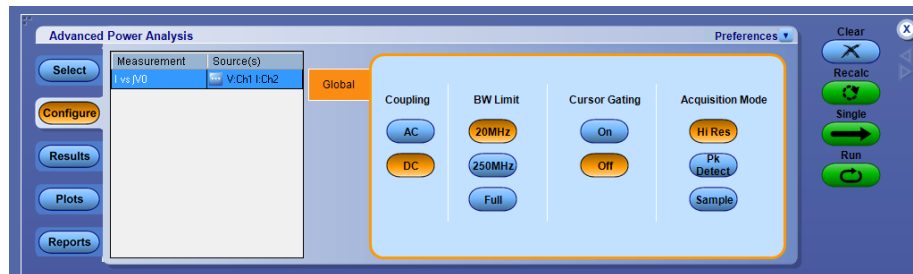

1. Configure the *Source configuration* for the measurement. Click for the measurement for source configuration.
2. Configuration under Global tab:  
See *Configuring global settings*. to set the coupling, bandwidth limit, cursor gating and acquisition mode.
3. Click Run to acquire the data. If the measurement is successful, the application displays the results.

---

**NOTE.** The application replaces any data in the selected ref destination when you analyze and measure Magnetics. You do not get a warning message here.

---

**Viewing results - I vs  $\int V$ .** Click Results to view the result for the selected I vs  $\int V$  measurement.



**Viewing plots - I vs  $\int V$ .** Click Plots and select I vs  $\int V$  to view the plots for the selected Magnetic property measurement.

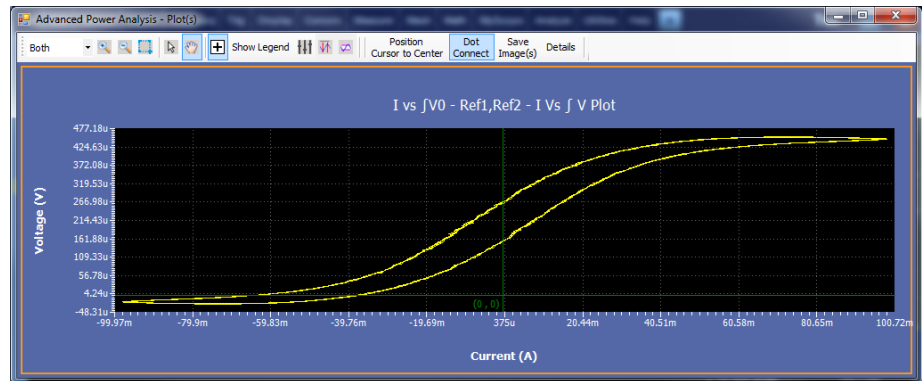

1. Click the + button to zoom in. Zoom up to five times the normal view. Drag the mouse to define the area of interest. Click the – button to zoom out. Use the Zoom In and Zoom Out buttons until the application reaches the maximum and the minimum zoom limit. You can use the Zoom buttons in three different ways:
  - Dragged zoom-in: Here the area is selected by dragging on the displayed window.

- Single-clicked zoom-in: When a point is clicked on the displayed window, the resulting window is equal to 1/4th of the displayed window.
  - Single-clicked zoom-out: When a point is clicked on the displayed window, the resulting plot is the previous zoom state of the displayed window.
2. Select the Reset option to restore the plot to its original display.
  3. Use the cursor in the Hits field to display the number of cursor hits at selected data points. When you place the cross hair icon on the I vs  $\int V$  plot and if multiple occurrences of the data points exist at the same position, the values are displayed in the Hits field.

## Input measurement and analysis

### Power quality

**Selecting and configuring measurements-Power quality.** To select and configure Power Quality Measurement, follow the steps:

1. From the oscilloscope menu bar, select Analyze > Advanced Power Analysis. The application launches with the Select tab (default) displaying the category of measurements.
2. Select Input Analysis; click Power Quality in the measurement pane.
3. Click Configure to configure the measurement.

The following figure shows equipment setup for Pulse Quality analysis.

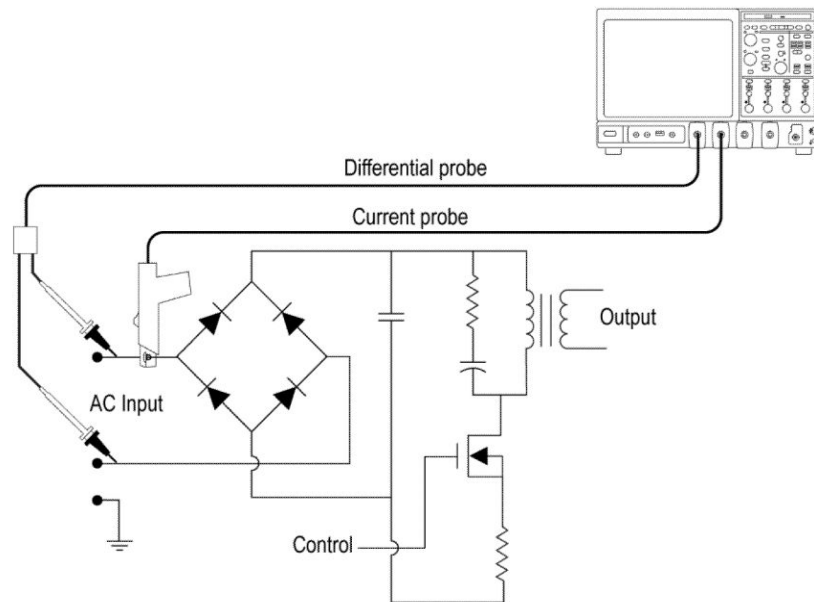

**Figure 15: Equipment setup for Pulse Quality analysis**



**WARNING.** When connecting to a circuit with hazardous voltages, see the warnings for the individual products and verify that the probes and other components used are within their ratings. Also refer to the topic [General safety summary](#) for more information.

**Configuring the measurement.** Follow the steps to configure the Power Quality measurement:

1. Configure the [Source configuration](#) for the measurement. Click  for the measurement for source configuration.

2. Configuration under Global tab:

See [Configuring global settings](#) to set the coupling, bandwidth limit, cursor gating and acquisition mode.

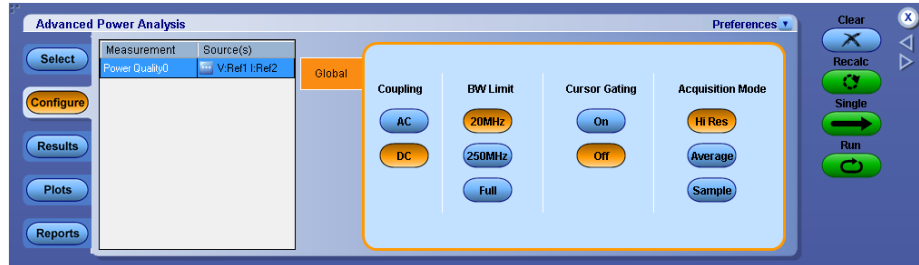

3. Click Run to acquire the data. If the measurement is successful, the application displays the results.

**Viewing results-Power quality.** Click Results to view the result for the selected Power Quality measurement.

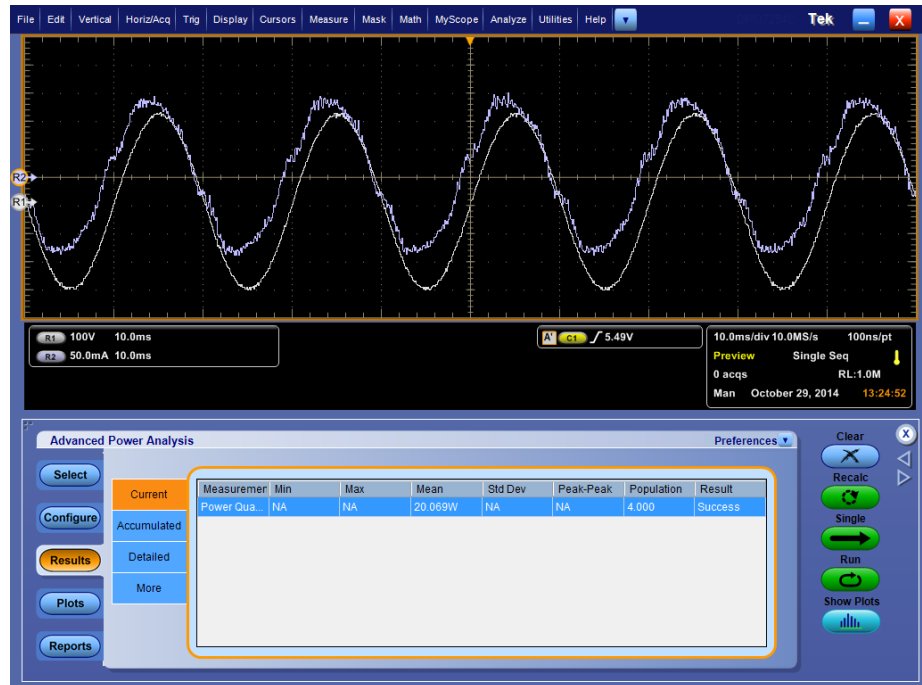

### Viewing plots-Power quality

Click Plots and select  $V \cdot I$  Power Waveform and/or  $\int (V \cdot I)$  Energy Waveform to view the plots for the selected Power Quality measurement.

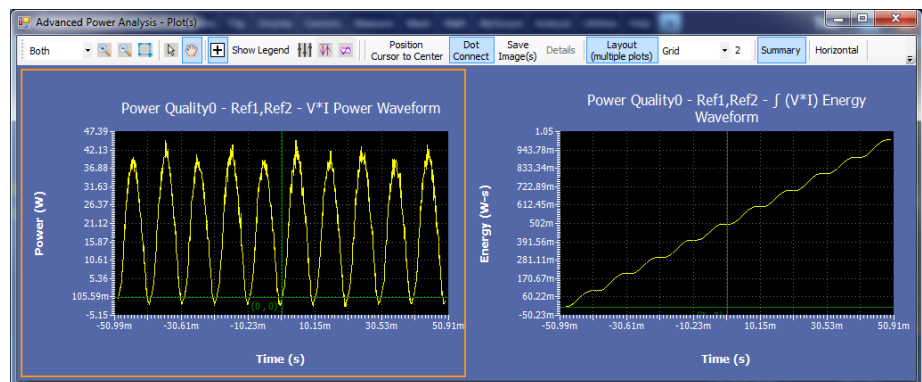

**See also.**

*Selecting and configuring measurements-Power quality*

*Plot components and features*

**Current harmonics**

**Selecting and configuring measurements-Current harmonics.** To select and configure Current Harmonics Measurement, follow these steps: Configuring the measurement

1. From the oscilloscope menu bar, select Analyze > Advanced Power Analysis. The application launches with the Select tab (default) displaying the category of measurements.
2. Select Input Analysis; click Current Harmonics in the measurement pane.
3. Click Configure to configure the measurement.



**WARNING.** When connecting to a circuit with hazardous voltages, see the warnings for the individual products and verify that the probes and other components used are within their ratings.

**NOTE.** If you are using the same voltage source as used for any previous measurement, you can skip the procedure for configuring the common configuration options.

Follow the steps to configure the Current Harmonics measurement:

1. Configure the *Source configuration* for the measurement. Click  for the measurement for source configuration.
2. Configuration under Standard tab:
  - Select the Type as international EMC (Electro Magnetic Compatibility) standards 61000-3-2, AM 14 and MIL 1399 for which you can perform compliance test.

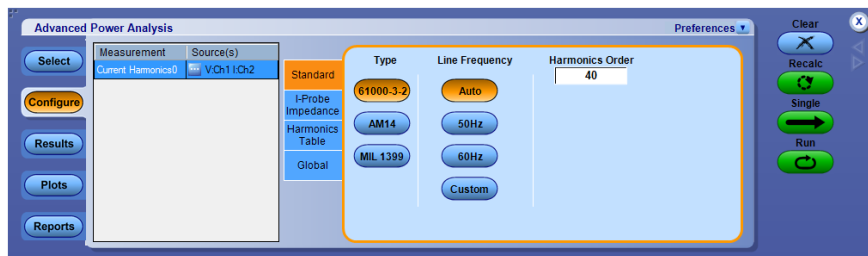

Click this hyperlink to see what the application does if you select the 61000-3-2 standard.

Follow these steps to configure the 61000-3-2 Standard configurations:

- a. Click the 61000-3-2 button in the Type pane. By default Line frequency is Auto which calculates input signal frequency automatically. Line frequency can be set to 50Hz, 60 Hz or Custom. Custom frequency value can be set



between 1 Hz and 4 KHz. Harmonics Order is 40 by default. Harmonics order can be set between 40 to 100.

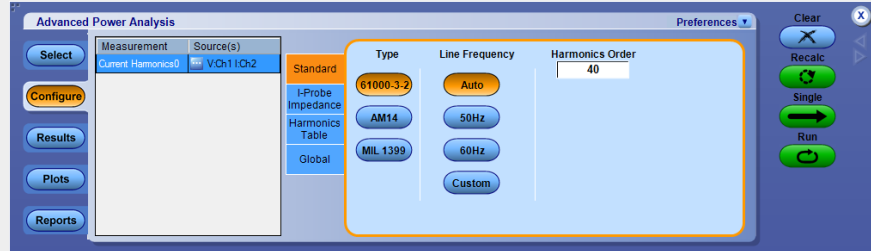

**NOTE.** Source Autoset takes input from Line Frequency and Harmonic Order. To set the minimum acquisition of ten cycles of line frequency, run the source autoset Vert & Horiz.

- b. In the Harmonics Table tab, use the Harmonics drop-down box to select the table and click the Edit button to edit the table. The values in these tables are used as Limit values.

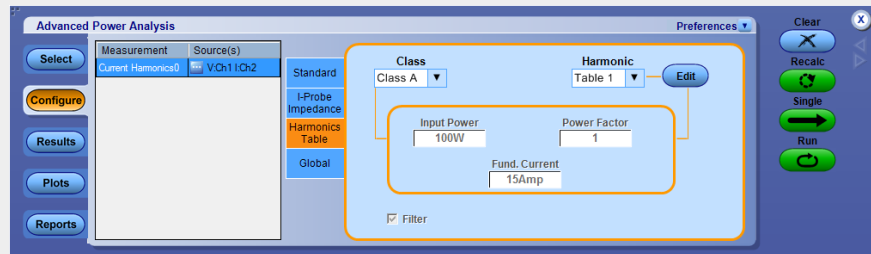

- c. Select any one of the ten available Tables. Table 1 is the default table. If you select the harmonic table, the application displays the class associated with it in the Class drop-down box. If you run the application for the first time, the application associates Class A with all the harmonic tables. If you change the Class settings, the application retains the change after you exit and rerun the application.
- d. Click the Edit button to display a table editor. The table editor displays the Harmonic Number from 1-40 for 61000-3-2 standard and 1-50 or 1-100 (based on the configuration parameter selected) for MIL

1399 standard, Harmonic Limits in milliamperes and the Harmonic Limits in decibel microamperes. Click OK to update the values in the table.

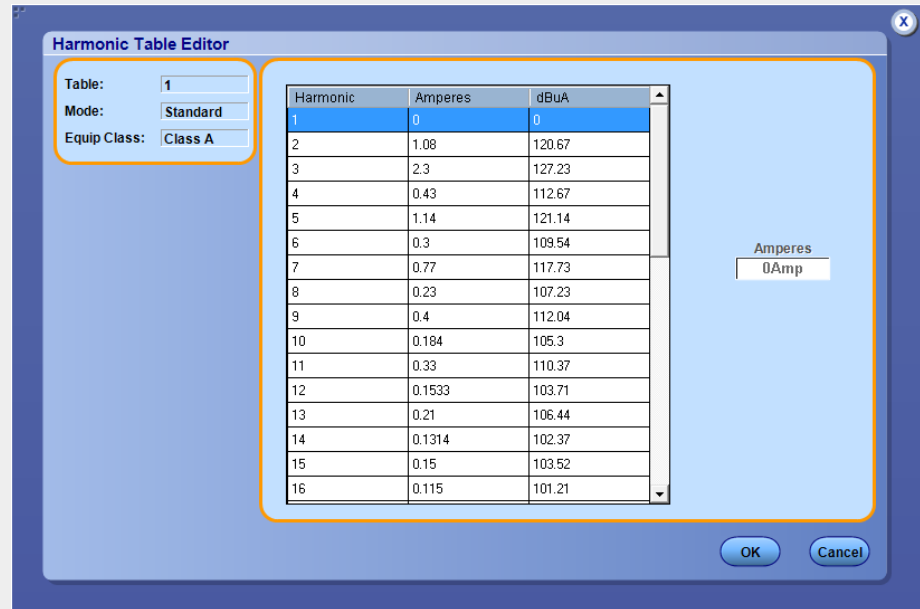

**NOTE.** You can edit only the Harmonic limits values Amperes table. The same change is updated in the db  $\mu$ a column.

- e. Select a Class using the drop-down arrow in the Class field. The available classes are: A to D.

**NOTE.** You can edit the harmonic table for Class A and B but not Class C and D.

If you select Class C, the application calculates the power factor limit and updates the limit table. If you select Class D, the application calculates the limit value of the harmonic from the true power of the unit under test.

- f. These tables are applicable only to 61000-3-2 standards and the AM 14 standards.

IEC issued an amendment (amendment 14) to the 61000-3-2 harmonics standard. This is documented as the 61000-3-2 amendment 14.

This amendment changes the class definitions, reclassifies many products to Class A and clearly defines what Class-D products are (Class D products are limited to personal computers + monitors < 600 W, television receivers <600W) and affects the newly defined Class-D. The Class C and D limits are based on Manufacturer's Ratings which must be verified by measurement.

Click this hyperlink to see what the application does if you select the AM 14 standard.

Follow these steps to configure the AM 14 configurations:

- a. Click the AM 14 button in the Type pane. By default Line frequency is Auto which calculates input signal frequency automatically. Line frequency can be set to 50Hz, 60 Hz or Custom. Custom frequency value can be set between 1 Hz and 4 KHz. Harmonics Order is 40 by default. Harmonics order can be set between 40 to 100.

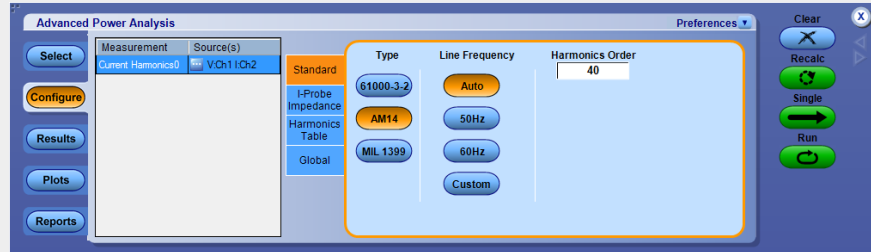

**NOTE.** Source Autoset takes input from Line Frequency and Harmonic Order. To set the minimum acquisition of sixty cycles of line frequency, run the source autoset Vert & Horiz.

- b. In the Harmonics Table tab, select the Table using the Harmonics drop-down box and click the Edit button to edit the table. Select any one of the ten available Tables. Table1 is the default table. If you set the harmonic table, the application displays the Class associated with in the Class combo box. If you run the application for the first time, the application associates Class A with all the harmonic tables. If you change the class settings, the application retains the change after you exit and rerun the application.

**NOTE.** You can edit the harmonic table for Class A and B but not Class C and D.

- c. Click the Edit button to display a table editor. The table editor displays the Harmonic Number from 1-40 for IEC standard, Harmonic Limits in

milliamperes and the Harmonic Limits in decibel microamperes. Click OK to update the values in the table.

- d. Select the Class using the Class drop-down box. The available classes are: A to D. The Controls option provides additional inputs only to Class C or D.

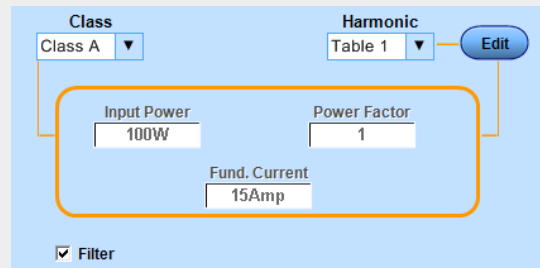

- e. Double-click the Input Power, Power Factor or Fundamental Current field and use the keypad that appears to enter the values and select OK. The acceptable ranges for:
  - Input Power is 0 W to 600 W. The default value is 100 W
  - Power Factor is 0 to 1. The default value is 1
- f. Fundamental Current is 0 A to 16 A. The default value is 15 A.
- g. Select the Filter check box to obtain filtered harmonic values.

**NOTE.** The signal is expected to be in steady state during the Tobs period where Tobs is the acquisition period for this measurement. This measurement is set for very short cycle  $T_{sv} = 3$  seconds.

Click this hyperlink to see what the application does if you select the MIL 1399 standard.

Click the MIL 1399 button in the Type pane. By default Line frequency is Auto which calculates input signal frequency automatically. Line frequency can be set to 50Hz, 60 Hz or Custom. Custom frequency value can be set between 1 Hz and 4 KHz. Harmonics Order is 50 by default. Harmonics order can be set between 50 to 100.

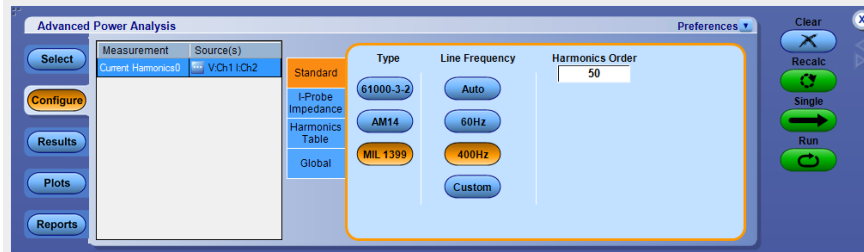

**NOTE.** Source Autoset takes input from Line Frequency and Harmonic Order. To set the minimum acquisition of ten cycles of line frequency, run the source autoset Vert & Horiz.

### 3. Configuration under I-Probe Impedance tab:

Enter the frequency derating of the custom probe that you are using for the current measurement. I-Probe is applicable for the selected current source where the frequency derating is compensated in measurements such as 61000-3-2, AM 14 and MIL 1399 standards. Use the drop-down arrow in the Impedance Table to select any one of the ten available tables. The Impedance table enables to enter frequency response of the probe. This helps you to measure the frequency component altered by the frequency response of the probe. Table 1 is the default table. Use the Edit button to edit the impedance table.

Use the Reset button in the Impedance Table Editor to reset the ratio and dB values to the default values.

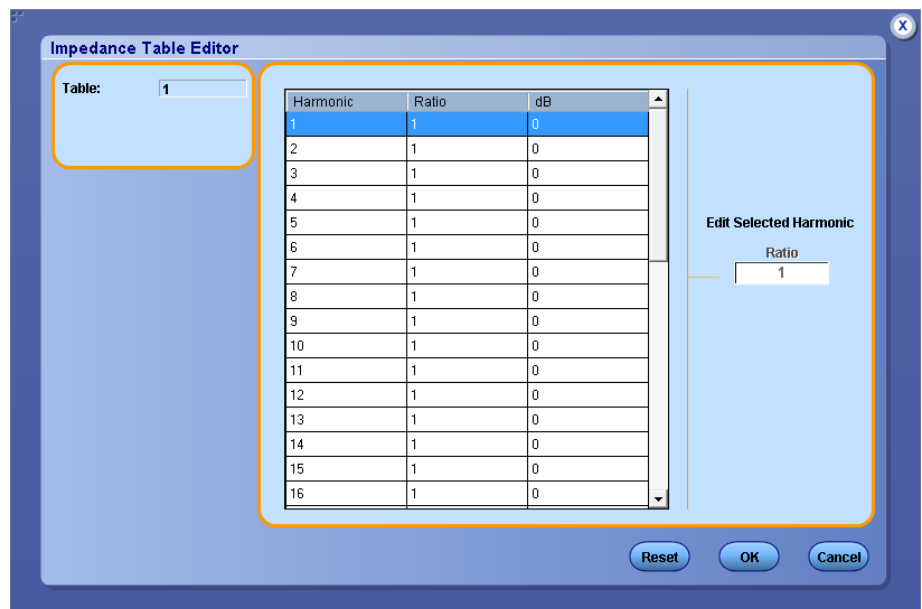

Use the Impedance table to set the transfer impedance of the probe at each harmonic frequency. The table editor displays the Harmonic Number from 1-40 for IEC standard and 1-50 or 1-100 (based on the configuration parameter selected) for MIL standard, the Impedance ratio and the Impedance ratio in decibels.

### 4. Configuration under Harmonics Table tab:

In the Harmonics Table tab, click the Edit button to display a table editor. The table editor displays the Harmonic Number from 1-40 for 61000-3-2 standard and 1-50 or 1-100 (based on the configuration parameter

selected) for MIL standard, the Impedance ratio in decibel units. You can edit only the Impedance ratio column in the table. Select OK.

---

**NOTE.** *You can edit the harmonic table for Class A and B but not Class C and D.*

---

**5.** Configuration under Global tab:

See [Configuring global settings](#) to set the coupling, bandwidth limit, cursor gating and acquisition mode.

**6.** Click Run to acquire the data. If the measurement is successful, the application displays the results.

---

**NOTE.** *Current harmonics works for any record length and time base combination for IEC61000-3-2 and AM14 type. For MIL1399 type it works for the time base set by the application Autose.*

---

**Viewing results-Current harmonics.** Click Results and then click View Results in Detailed, to view the result for the selected Current Harmonics measurement.

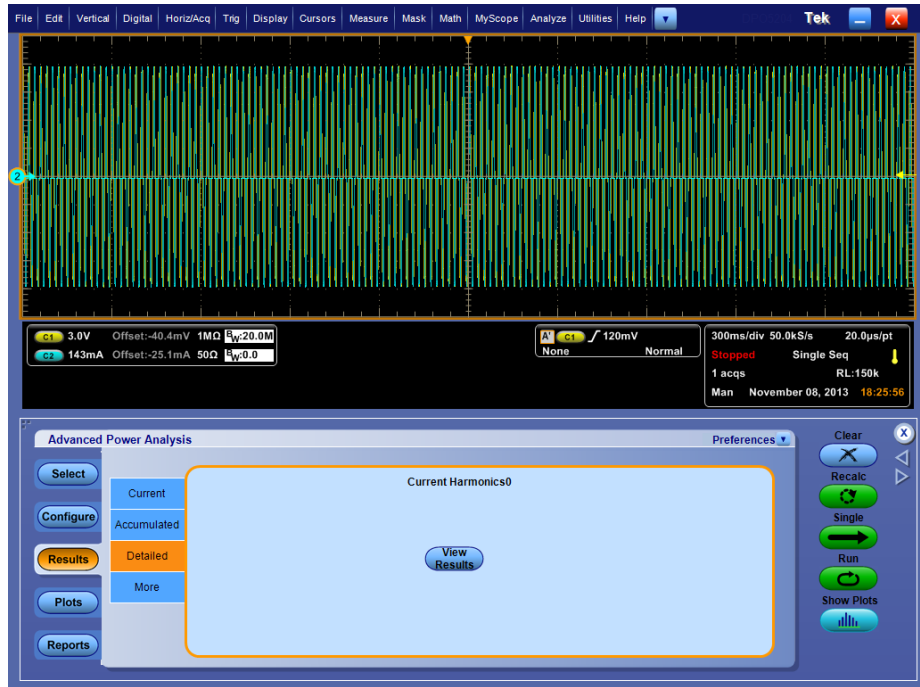

**61000-3-2 and MIL 1399 results.** If you have selected the 61000-3-2 or MIL 1399 standard, the Current Harmonic Results displays the following information:

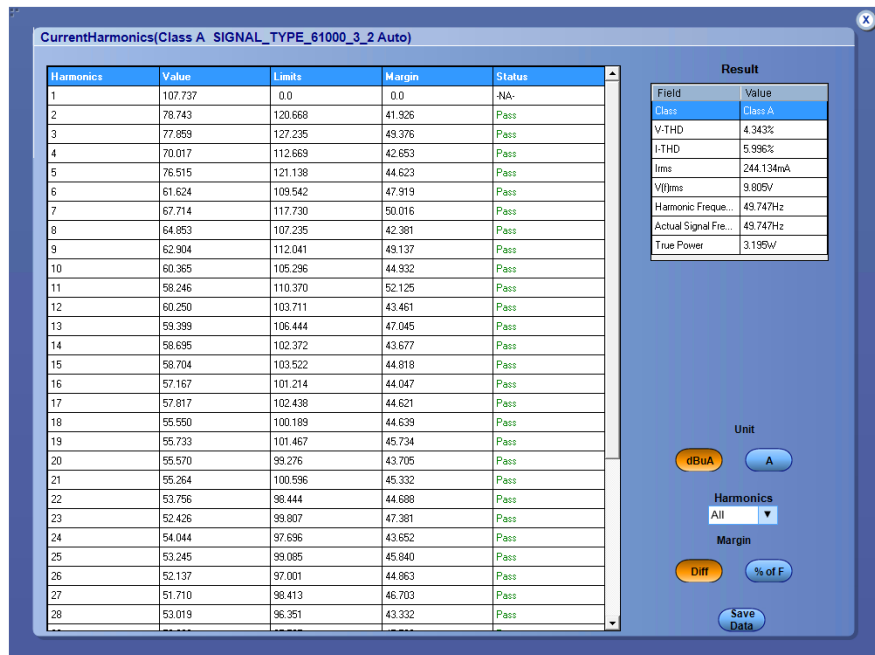

Option	Description
Harmonic	Displays the harmonic number
Value	Displays the measured value in dB $\mu$ A
Limit	Displays the harmonic limits in dB $\mu$ A
Margin	Displays the difference between the Value and Limit in dB $\mu$ A. The status depends on the positive or negative margin value
Status	Displays the status of the measurement - Pass or Fail

**Table 2: Result**

Field	Value
Class	Configured class
V-THD	Total harmonic distortions of voltage signal
I-THD	Total harmonic distortions of current signal
Irms	Root mean square of current signal
V(f)rms	Root mean square computed using harmonic frequencies
Harmonic Frequency	Configured line frequency
Actual Signal Frequency	Actual input line frequency
True Power	True power of the waveform

**Table 3: Customize result**

Field	Value
<b>Unit</b>	
dB $\mu$ A	Margin values are displayed in dB $\mu$ A measurement unit.
A	Margin values are displayed in A (Ampere) measurement unit.
<b>Harmonics</b>	
All	Harmonics with both odd and even values are displayed.
Odd	Harmonics with only odd values are displayed.
Even	Harmonics with only even values are displayed.
<b>Margin</b>	
Diff	Difference of Limit to Value is displayed in Margin.
% of F	% of difference of Limit to Value is displayed in Margin.
<b>Save Data</b>	Allows you to save the result in *.csv file format.

**AM 14 results.**

If you have selected the AM 14 standard, the Current Harmonic Results displays 40 harmonic values with the following information:



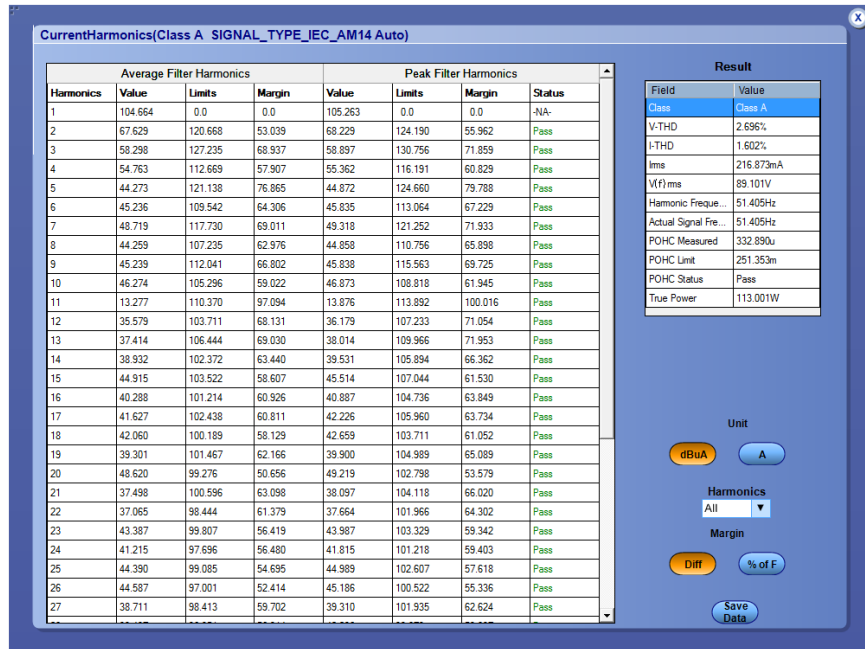

Option	Description
Harmonic	Displays the harmonic number.
Value	Displays the measured value in dB $\mu$ A.
Limit	Displays the harmonic limits in dB $\mu$ A.
Margin	Displays the difference between the Value and Limit in dB $\mu$ A. The Status depends on the positive or negative margin value.
Result	Displays the status of the measurement-Pass or Fail.

Table 4: Result

Field	Value
Class	Configured class
V-THD	Total Harmonic distortions of voltage signal.
I-THD	Total Harmonic distortions of current signal.
Irms	Root Mean Square of current signal.
Vrms	Root mean square of voltage signal
Harmonic Frequency	Configured line frequency
Actual Signal Frequency	Actual input Line frequency
POHC Measured	Partial odd harmonic current measured.
POHC Limit	Partial odd harmonic current limit.
POHC Status	Partial odd harmonic current status Pass/Fail.
True Power	True power of the waveform

**Table 5: Customize result**

Field	Value
<b>Unit</b>	
dB $\mu$ A	Margin values are displayed in dB $\mu$ A measurement unit.
A	Margin values are displayed in A (Ampere) measurement unit.
<b>Harmonics</b>	
All	Harmonics with both odd and even values are displayed.
Odd	Harmonics with only odd values are displayed.
Even	Harmonics with only even values are displayed.
<b>Margin</b>	
Diff	Difference of Limit to Value is displayed in Margin.
% of F	% of difference of Limit to Value is displayed in Margin.

If you have selected the AM 14 standard with Filter, the Current Harmonic Results displays 50 harmonic values with the following information:

Option	Description
Average Filtered Harmonics	Displays the average value of the individual harmonic currents taken over the entire test period ((measured average harmonics, limit average harmonics and margin (difference between limit and measured value)).
Peak Filtered Harmonics	Displays the maximum value for each filtered harmonics.
Value	Displays the measured value in dB $\mu$ A.
Limit	Displays the harmonic limits in dB $\mu$ A.
Margin	Displays the difference between the Value and Limit in dB $\mu$ A. The Status depends on the positive or negative margin value.
Result	Displays the status of the measurement-Pass or Fail.

**Table 6: Result**

Field	Value
Class	Configured class
V-THD	Total Harmonic distortions of voltage signal.
I-THD	Total Harmonic distortions of current signal.
Irms	Root Mean Square of current signal.
Vrms	Root mean square of voltage signal
Harmonic Frequency	Configured line frequency
Actual Signal Frequency	Actual input Line frequency
POHC Measured	Partial odd harmonic current measured.
POHC Limit	Partial odd harmonic current limit.
POHC Status	Partial odd harmonic current status Pass/Fail.

Field	Value
True Power	True power of the waveform

**Table 7: Customize result**

Field	Value
<b>Unit</b>	
dB $\mu$ A	Margin values are displayed in dB $\mu$ A measurement unit.
A	Margin values are displayed in A (Ampere) measurement unit.
<b>Harmonics</b>	
All	Harmonics with both odd and even values are displayed.
Odd	Harmonics with only odd values are displayed.
Even	Harmonics with only even values are displayed.
<b>Margin</b>	
Diff	Difference of Limit to Value is displayed in Margin.
% of F	% of difference of Limit to Value is displayed in Margin.

**Viewing plots-Current harmonics.** Click Plots and select Harmonics Bar Graph to view the plots for the selected Current Harmonics measurement.

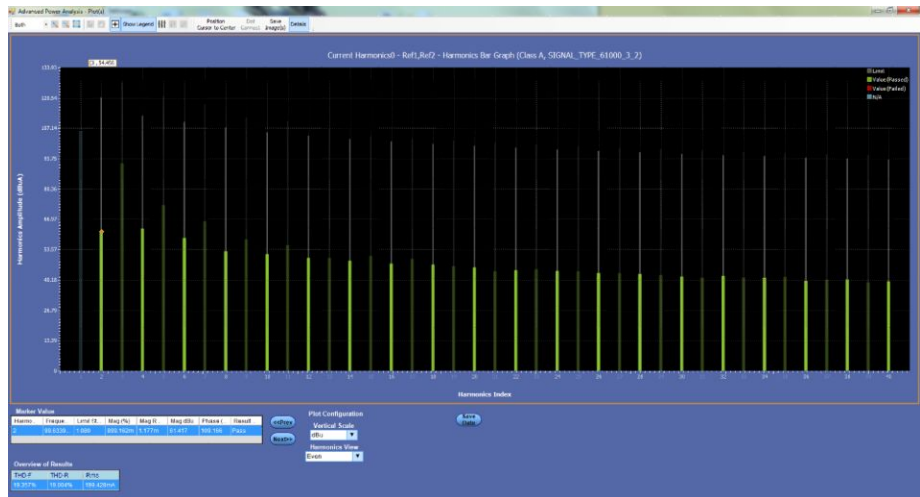

**Figure 16: Even harmonics bar graph**

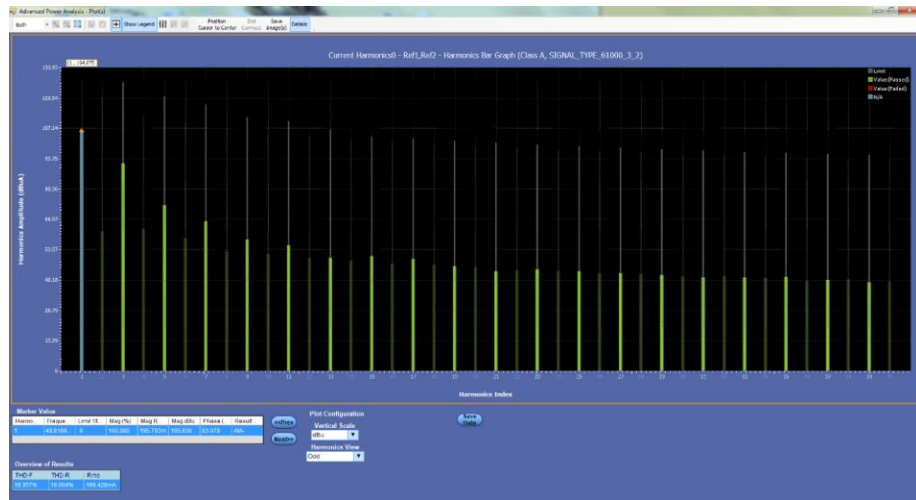

Figure 17: Odd harmonics bar graph

---

**NOTE.** Marker Value, Overview of Results table fields and information about calculation are explained in [Current/Voltage harmonics](#).

---

**See also.**

[Selecting and configuring measurements-Current harmonics](#)

[Plot components and features](#)

**Voltage harmonics**

**Selecting and configuring measurements-Voltage harmonics.** To select and configure Voltage Harmonics Measurement, follow these steps:

1. From the oscilloscope menu bar, select Analyze > Advanced Power Analysis. The application launches with the Select tab (default) displaying the category of measurements.
2. Select Input Analysis; click Voltage Harmonics in the measurement pane.
3. Click Configure to configure the measurement.



**WARNING.** When connecting to a circuit with hazardous voltages, see the warnings for the individual products and verify that the probes and other components used are within their ratings.

**NOTE.** If you are using the same voltage source as used for any previous measurement, skip the procedure for configuring the common configuration options.

**Configuring the measurement.** Follow the steps to configure the Voltage Harmonics measurement:

1. Configure the *Source configuration* for the measurement. Click  for the measurement for source configuration.
2. Configuration under Line Frequency tab:
  - Select Auto (Calculates the input signal frequency automatically), 50 Hz, 60 Hz, Custom (Set the Line frequency in range 1 Hz to 4000 Hz using numerical keypad).

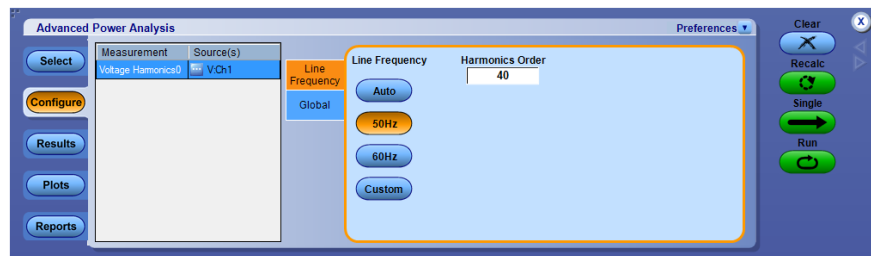

3. Configuration under Global tab:
 

See *Configuring global settings*. to set the coupling, bandwidth limit, cursor gating and acquisition mode.
4. Click Run to acquire the data. If the measurement is successful, the application displays the results.

**Viewing results-Voltage harmonics.** Click Results and then click View Results in Detailed, to view the result for the selected Voltage Harmonics measurement.

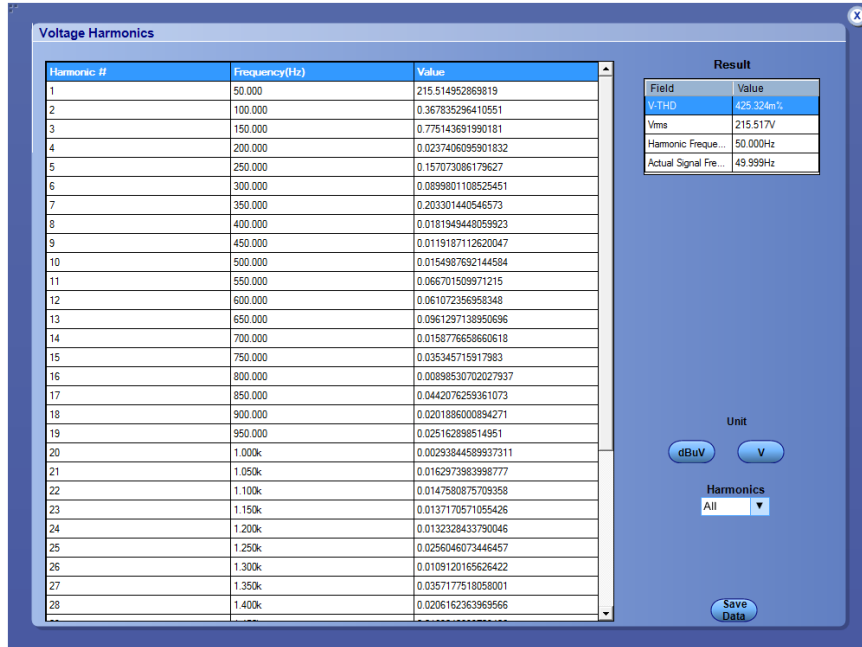

Option	Description
Harmonic	Displays the harmonic number
Frequency (Hz)	Displays the frequency in Hz
Value	Displays the value

**Table 8: Result**

Field	Value
V-THD	Total harmonic distortions of voltage signal.
Vrms	Root mean square of voltage signal
Harmonic Frequency	Configured line frequency
Actual Signal Frequency	Actual input line frequency

**Table 9: Customize result**

Field	Value
<b>Unit</b>	
dB $\mu$ V	Margin values are displayed in dB $\mu$ V measurement unit.
V	Margin values are displayed in V (Volt) measurement unit.
<b>Harmonics</b>	

Field	Value
All	Harmonics with both odd and even values are displayed.
Odd	Harmonics with only odd values are displayed.
Even	Harmonics with only even values are displayed.
Save Data	Allows you to save the result in *.csv file format.

**Viewing plots-Voltage harmonics.** Click Plots and select Harmonics Bar Graph to view the plots for the selected Voltage Harmonics measurement.

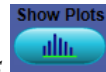
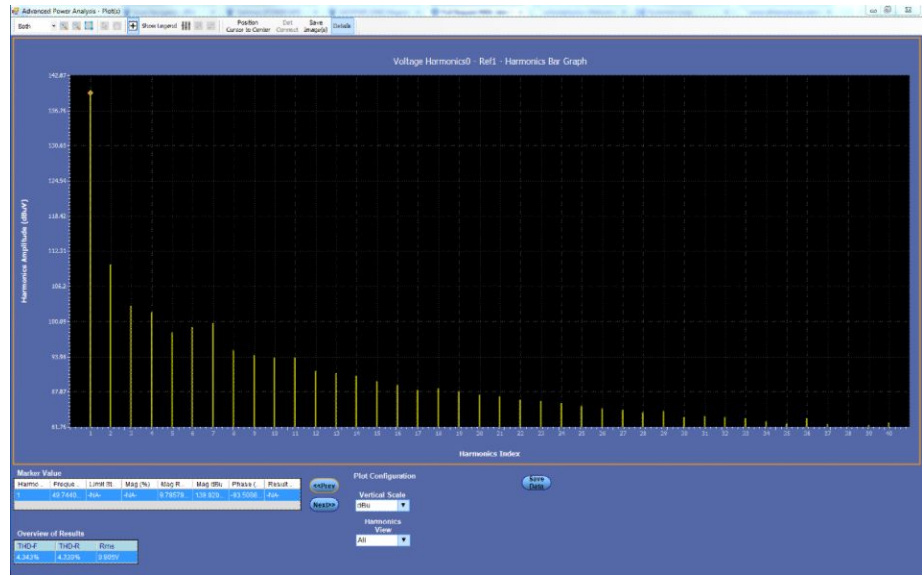

**TIP.** Click Show Plots to open the Plot(s) window, when closed.

**NOTE.** Marker Value, Overview of Results table fields and information about calculation are explained in [Current/Voltage harmonics](#).

**See also.**

[Selecting and configuring measurements-Voltage harmonics](#)

[Plot components and features](#)

**Total power quality**

**Selecting and configuring measurements-Total power quality.** Selecting and configuring measurements-Total Power QualityConfiguring the measurement

1. From the oscilloscope menu bar, select Analyze > Advanced Power Analysis. The application launches with the Select tab (default) displaying the category of measurements.
2. Select Input Analysis; click Total Power Quality in the measurement pane.
3. Click Configure to configure the measurement.



**WARNING.** When connecting to a circuit with hazardous voltages, see the warnings for the individual products and verify that the probes and other components used are within their ratings. Also refer to the topic [General safety summary](#) for more information.

**NOTE.** If you use the same voltage source as used for an earlier measurement, you can skip the procedure for configuring the source configuration options.

Follow the steps to configure the Total Power Quality measurement:

1. Configure the [Source configuration](#) for the measurement. Click  for the measurement for source configuration.
2. Configurations under Standard tab:
  - Select the Type as international EMC (Electro Magnetic Compatibility) standards 61000-3-2, AM 14 and MIL 1399 for which you can perform compliance test.

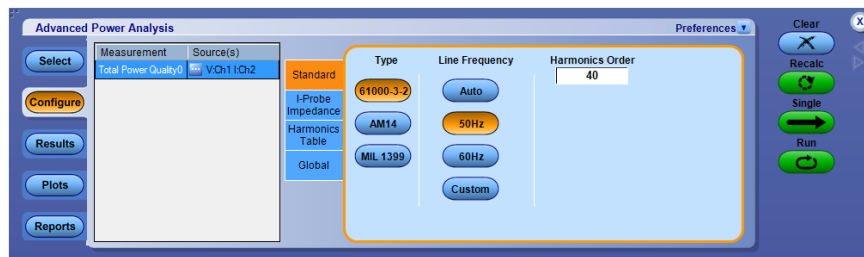

Click this [hyperlink](#) to see what the application does if you select the 61000-3-2 standard.

Follow these steps to configure the 61000-3-2 Standard configurations:

- a. In the Standard tab, select the 61000-3-2 button. Line Frequency is 50 Hz and Harmonics Order is 40 by default. Select Auto to automatically detect the input signal frequency. Click 60 Hz or Custom and set frequency within 1 Hz



to 4000 Hz range for line frequency. Harmonics order can be set between 40 to 100.

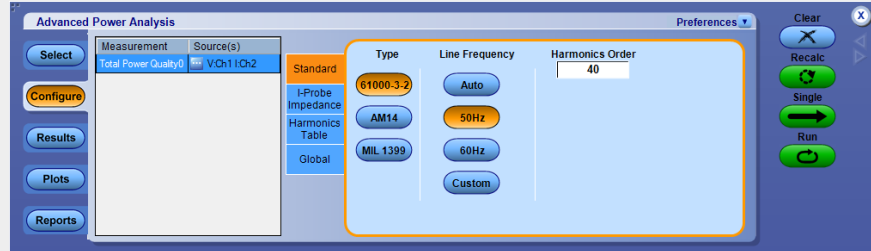

- b. In the Harmonics Table tab, click the Harmonic combo box to select the table and click the Edit button to edit the table.
- c. Select any one of the ten available Tables. Table 1 is the default table. If you set the harmonic table, application displays the Class associated with in the Class combo box. If you run the application for the first time, the application associates Class A with all the harmonic tables. If you change the Class settings, the application retains the change after you exit and rerun the application.
- d. Click the Edit button to display a table editor. The table editor displays the Harmonic Number from 1-40 for IEC standard and 1-50 or 1-100 (based on the configuration parameter selected) for MIL standard, Harmonic Limits in milliamperes and the Harmonic Limits in decibel microamperes. Click OK to update the values in the table.

**NOTE.** You can edit only the Harmonic Limits values mA table.

- e. Click the Class combo box to select a Class. The available Classes are: A to D.

**NOTE.** You can edit the harmonic table for Class A and B but not Class C and D.

- a. If you select the Class C, the application calculates the power factor limit and updates the limit table. If you select Class D, the application calculates the limit value of the harmonic from the true power of the unit under test.
- b. Click the Set button to set the Harmonic table to the selected standard.

IEC issued an amendment (amendment 14) to the 61000-3-2 harmonics standard. This is documented as the 61000-3-2 amendment 14.

This amendment changes the class definitions, reclassifies many products to Class A and clearly defines what Class-D products are (Class D products are limited to personal computers + monitors < 600 W, television receivers <600W).

Click this hyperlink to see what the application does if you select the AM 14 standard.

Follow these steps to configure the AM 14 Standard configurations:

- a. In the Standard tab, select the AM 14 button. Line Frequency is 50 Hz and Harmonics Order is 40 by default. Select Auto to automatically detect the input signal frequency. Click 60 Hz or Custom and set frequency within 1 Hz to 4000 Hz range for line frequency. Harmonics order can be set between 40 to 100.

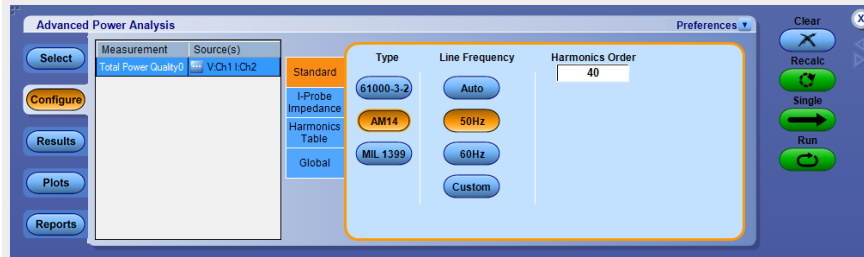

- a. In the Harmonics Table tab, click the Harmonic drop-down list to select the table and use the Edit button to edit the table.

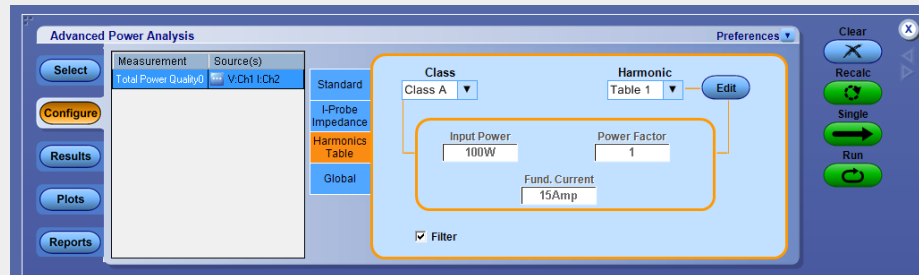

- b. Select any one of the ten available Tables. Table 1 is the default table. If you set the harmonic table, application displays the Class associated with in the Class combo box. If you run the application for the first time, the application associates Class A with all the harmonic tables. If you change the Class settings, the application retains the change after you exit and rerun the application.
- c. Click the Edit button to display a table editor. The table editor displays the Harmonic Number from 1-40 for IEC standard, Harmonic Limits in

- milliamperes and the Harmonic Limits in decibel microamperes. Click OK to update the values in the table.
- d. Use the Class combo box to select a Class. The available Classes are: A to D. The Controls option provides additional inputs only to Class C or D.
  - e. Select the Controls button to display the controls screen.
  - f. Double-click the Input Power, Power Factor or Fundamental Current field and use the keypad that appears to enter the values and select OK. The acceptable ranges for:
    - Input Power is 0 W to 2 KW. The default value is 100 W
    - Power Factor is 0 to 1. The default value is 1
    - Fundamental Current is 0 A to 16 A. The default value is 16 A
  - g. Set the Filter Off if you do not want to obtain filtered harmonic values.

Click this [hyperlink](#) to see what the application does if you select the MIL 1399 standard.

In the Standard tab, select the MIL 1399 button. Line Frequency is 400 Hz and Harmonics Order is 50 by default. Select Auto to automatically detect the input signal frequency. Click 60 Hz or Custom and set frequency within 1 Hz to 4000 Hz range for line frequency. Harmonics order can be set between 50 to 100.

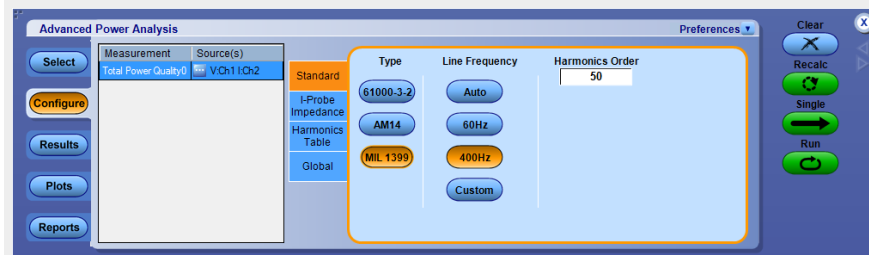

### 3. Configuration under I-Probe Impedance tab:

Enter the frequency derating of the custom probe that you are using for the current measurement. I-Probe is applicable for the selected current source where the frequency derating is compensated in measurements such as 61000-3-2, AM 14 and MIL 1399 standards. Use the drop-down arrow in the Impedance Table to select any one of the ten available tables. The Impedance table enables to enter frequency response of the probe. This helps you to measure the frequency component altered by the frequency response of the

probe. Table 1 is the default table. Use the Edit button to edit the impedance table.

Use the Reset button in the Impedance Table Editor to reset the ratio and dB values to the default values.

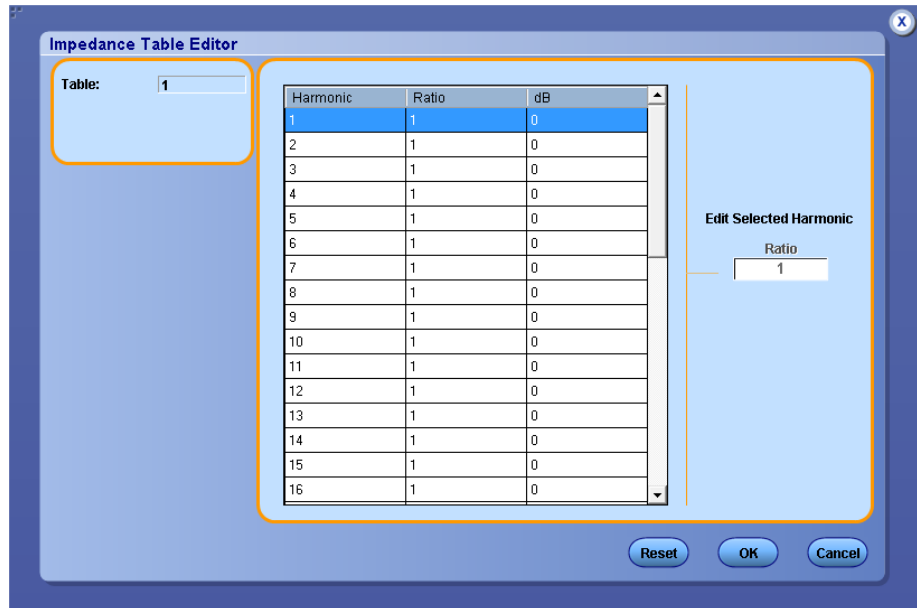

Use the Impedance table to set the transfer impedance of the probe at each harmonic frequency. The table editor displays the Harmonic Number from 1-40 for IEC standard and 1-50 or 1-100 (based on the configuration parameter selected) for MIL standard, the Impedance ratio and the Impedance ratio in decibels.

4. Configuration under Harmonics Table tab:

In the Harmonics Table tab, click the Edit button to display a table editor. The table editor displays the Harmonic Number from 1-40 for 61000-3-2 standard and 1-50 or 1-100 (based on the configuration parameter selected) for MIL standard, the Impedance ratio in decibel units. You can edit only the Impedance ratio column in the table. Select OK.

---

**NOTE.** You can edit the harmonic table for Class A and B but not Class C and D.

---

5. Configuration under Global tab:

See [Configuring global settings](#) to set the coupling, bandwidth limit, cursor gating and acquisition mode.

6. Click Run to acquire the data. If the measurement is successful, the application displays the results.

**Viewing results-Total power quality.**

1. Click Results to view the result for the selected Total Power Quality measurement.

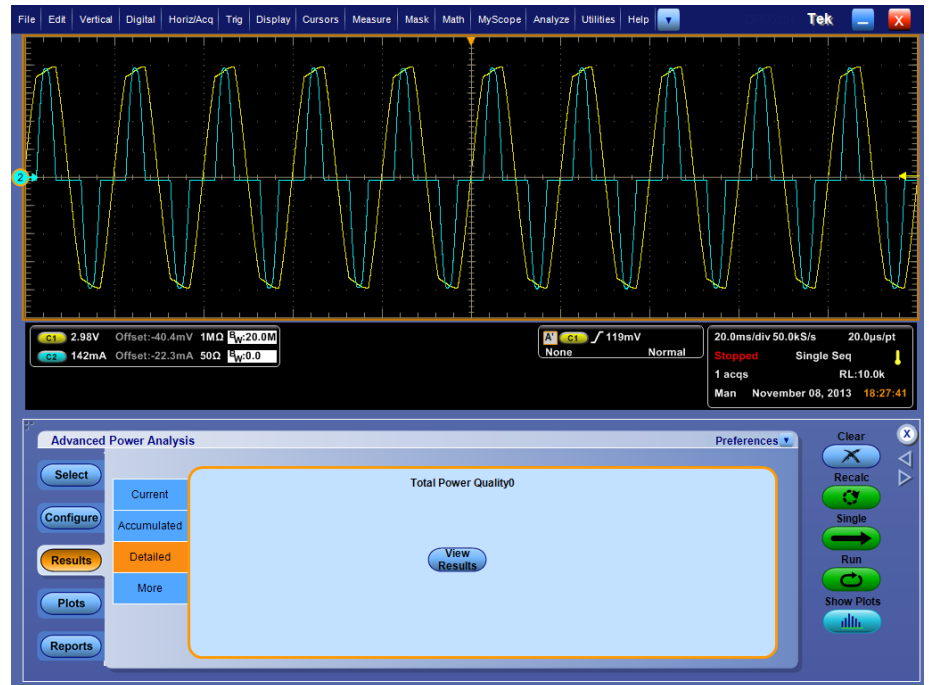

**NOTE.** Since the measurement is a combination of Power Quality and Current Harmonics measurements, the results also reflect the same combination.

2. Select the View button to display the following results:

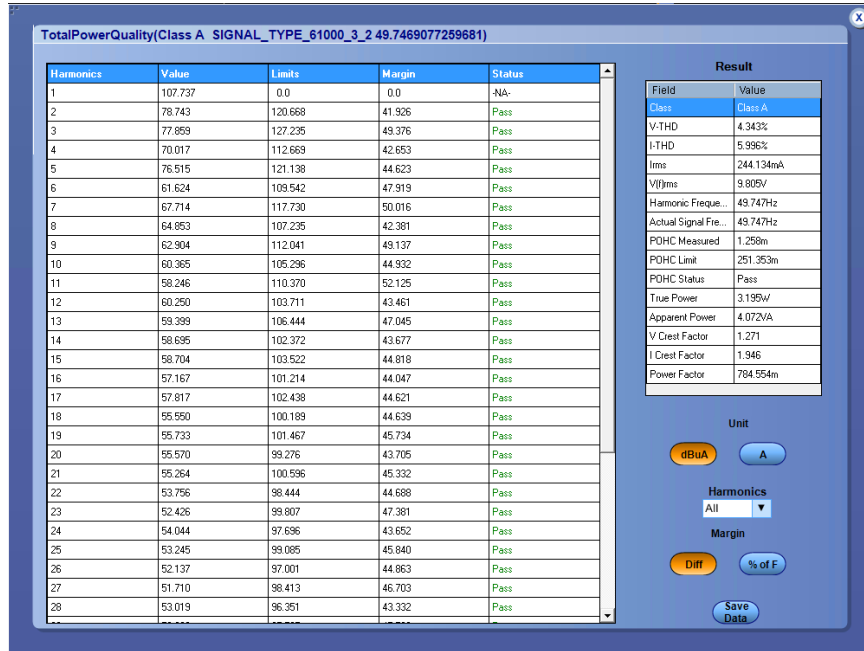

Option	Description
Harmonic	Displays the harmonic number
Value	Displays the measured value
Limit	Displays the IEC standard limits or the user defined limits set by you
Margin	Displays the difference between the Value and Limit
Result	Displays the status of the measurement-Pass or Fail

Table 10: Result

Field	Value
Class	Specifies the class
V-THD	Total harmonic distortions of voltage signal
I-THD	Total harmonic distortions of current signal
Irms	Root mean square of current signal
V(f)rms	Root mean square computed using harmonic frequencies
Harmonic Frequency	Specified configure Line frequency
Actual Signal Frequency	Actual input line frequency
POHC Measured	Partial odd harmonic current measured
POHC Limit	Partial odd harmonic current limit
POHC Status	Partial odd harmonic current status Pass/Fail

Field	Value
True Power	Specifies true power of the waveform
Apparent Power	Specifies apparent power of the waveform
V Crest Factor	Specifies V Crest factor of the waveform
I Crest Factor	Specifies I Crest factor of the waveform
Power Factor	Specifies the power factor of the waveform

---

**NOTE.** *Class, POHC measured, POHC limit and POHC status filed will not be displayed in result table for MIL 1399 standard type.*

---

If you have selected MIL 1399 standard, the application displays 50 or 100 harmonic values depending on the configuration set. In the Field and Value table, the Class value is displayed as NA, Mode displays MIL Standard, Line Frequency value in Hz and Total Harmonic Distortion in percentage.

3. Select the Table or Graph option from the View pane. If you have set the MIL Standard, the mask option is not available in the View field. The Mask option is available only if the harmonic table has Class A or D device. In the Mask results, Red indicates the mask boundary, yellow indicates one half cycle of the input current waveform. X-axis displays the waveform angle in degrees. Y-axis indicates the  $i/i$  peak where  $i$  is the current and  $i$  peak is the peak of the current in one half cycle.
4. In the bar graph, the red indicates Fail status, green indicates Pass and gray is for set limits. The mask option displays the True Power and the class of the device detected.
5. Select the drop-down arrow in the Harmonics field to display the harmonics in three modes -All, Even and Odd. All harmonics displays the complete set of harmonic values. Even harmonics display the even numbered values from 2-40. Odd harmonics display the odd numbered values from 1-39.
6. Click dB  $\mu$ A or A in Units pane to set the units to decibel microamperes or amperes. The default units is dB  $\mu$ A.

---

**NOTE.** *Any change in the units reflects in the Value, Limit and Margin fields of the table and the bar graph. Export the .csv file only if you select the table format.*

---

### Viewing results-Total power quality

If the Harmonics Bar Graph plot is selected, click Show Plots to display the plot.

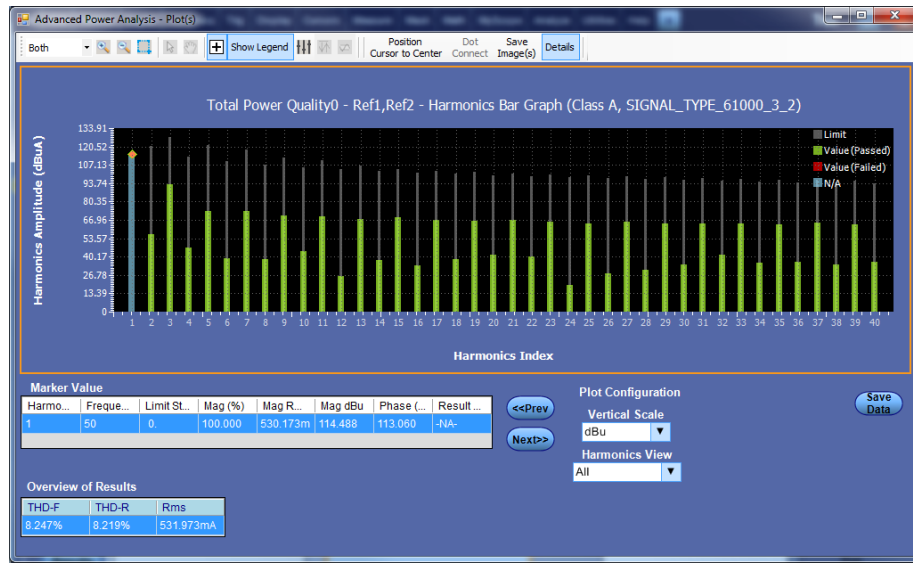

**See also.**

*Selecting and configuring measurements-Total power quality*

*Plot components and features*



**Inrush current**

**Selecting and configuring measurements-Inrush current.** Selecting and configuring measurements-Inrush currentConfiguring the measurement

1. From the oscilloscope menu bar, select Analyze > Advanced Power Analysis. The application launches with the Select tab (default) displaying the category of measurements.
2. Select Input Analysis; click In Rush Current in the measurement pane.
3. Click Configure to configure the measurement.



---

**WARNING.** *When connecting to a circuit with hazardous voltages, see the warnings for the individual products and verify that the probes and other components used are within their ratings. Also refer to the topic [General safety summary](#) for more information.*

---



---

**NOTE.** *If you use the same voltage source as used for an earlier measurement, you can skip the procedure for configuring the source configuration options.*

---

Follow the steps to configure the In Rush Current measurement:

1. Configure the [Source configuration](#) for the measurement. Click  for the measurement for source configuration.
2. Configuration under Options tab:
  - Select the Units as Percentage or Absolute to set the Ref Level and Hysteresis values in percentage or the absolute value of the peak-to-peak signal.
  - Set the Ref level value within the range -100 Amp to 100 Amp for absolute units and 1% to 99% for units as percentage.

The input current waveform can be divided into different regions. The region is defined as when a current waveform enters and exits the threshold level. The measurement computes the positive and negative peaks for each region. The REF Level is used to detect the first valid peak. After this other peaks are detected above and below the REF level.

  - Set the Hysteresis value within the range 0 Amp to 100 Amp for absolute units and 1% to 99% for units as percentage.

- Set the Peak (Amps) within the range -100 Amp to 100 Amp for absolute units and 1% to 99% for units as percentage.

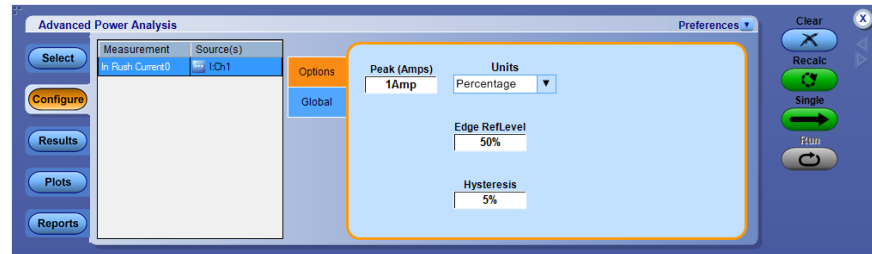

3. Configuration under Global tab:

See [Configuring global settings](#). to set the coupling, bandwidth limit, cursor gating and acquisition mode.

4. Click Run to acquire the data. If the measurement is successful, the application displays the results.

**Viewing results-In rush current.** Click Results to view the result for the selected In Rush Current measurement.

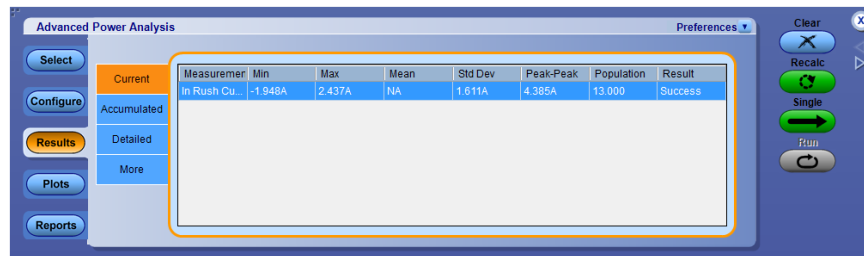

**In rush current detailed result**

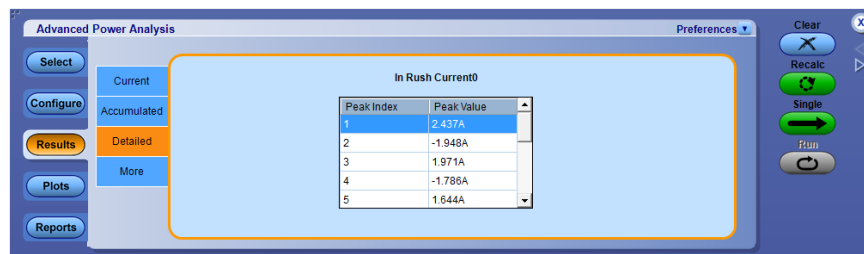

See also.

[Selecting and configuring measurements-In rush current](#)

**Input capacitance**

**Selecting and configuring measurements-Input capacitance.** Selecting and Configuring Measurements-Input CapacitanceConfiguring the measurement

1. From the oscilloscope menu bar, select Analyze > Advanced Power Analysis. The application launches with the Select tab (default) displaying the category of measurements.
2. Select Input Analysis; click Input Capacitance in the measurement pane.
3. Click Configure to configure the measurement.



**WARNING.** When connecting to a circuit with hazardous voltages, see the warnings for the individual products and verify that the probes and other components used are within their ratings. Also refer to the topic [General safety summary](#) for more information.

**NOTE.** If you use the same voltage source as used for an earlier measurement, you can skip the procedure for configuring the source configuration options.

Follow the steps to configure the Input Capacitance measurement:

1. Configure the [Source configuration](#) for the measurement. Click  for the measurement for source configuration.
2. Configuration under Options tab:
  - Select the Units as Percentage or Absolute to set the Ref Level and Hysteresis values in percentage or the absolute value of the peak-to-peak signal.
  - Set the Ref level value within the range -100 Amp to 100 Amp for absolute units and 1% to 99% for units as percentage.

The input current waveform can be divided into different regions. The region is defined as when a current waveform enters and exits the threshold level. The measurement computes the positive and negative peaks for each region. The REF Level is used to detect the first valid peak. After this other peaks are detected above and below the REF level.

- Set the Hysteresis value within the range 0 Amp to 100 Amp for absolute units and 1% to 99% for units as percentage.

- Set the Peak (Amps) within the range -100 Amp to 100 Amp for absolute units and 1% to 99% for units as percentage.

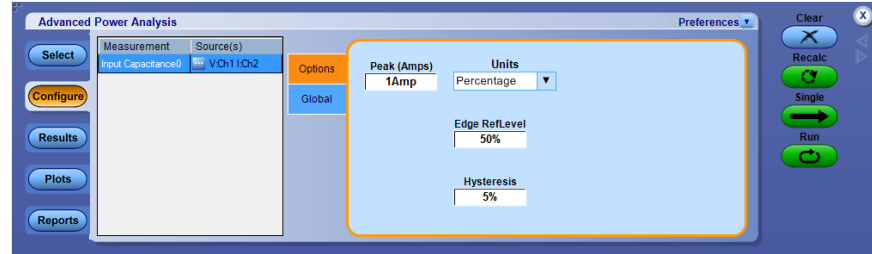

3. Configuration under Global tab:

See [Configuring global settings](#). to set the coupling, bandwidth limit, cursor gating and acquisition mode.

4. Click Run to acquire the data. If the measurement is successful, the application displays the results.

**Viewing results-Input capacitance.** Click Results to view the result for the selected Input Capacitance measurement.



See also.

[Selecting and configuring measurements-Input capacitance](#)

## Output measurement and analysis

**Line ripple** **Selecting and configuring measurements-Line ripple.** To select and configure Ripple Measurement, follow these steps:

1. From the oscilloscope menu bar, select Analyze > Advanced Power Analysis. The application launches with the Select tab (default) displaying the category of measurements.
2. Select Output Analysis; click Line Ripple in the measurement pane.
3. Click Configure to configure the measurement.

**Configuring the measurement.** Follow the steps to configure the Input Capacitance measurement:



1. Configure the *Source configuration* for the measurement. Click  for the measurement for source configuration.
2. Configuration under LineRipple Freq tab:
  - Set the Ripple Freq to 50 Hz, 60 Hz, or 400 Hz
3. Configuration under Global tab:
 

See *Configuring global settings*. to set the coupling, bandwidth limit, cursor gating and acquisition mode.
4. Click Run to acquire the data. If the measurement is successful, the application displays the results.

**Viewing results-Line ripple.** Click Results to view the result for the selected Line Ripple measurement

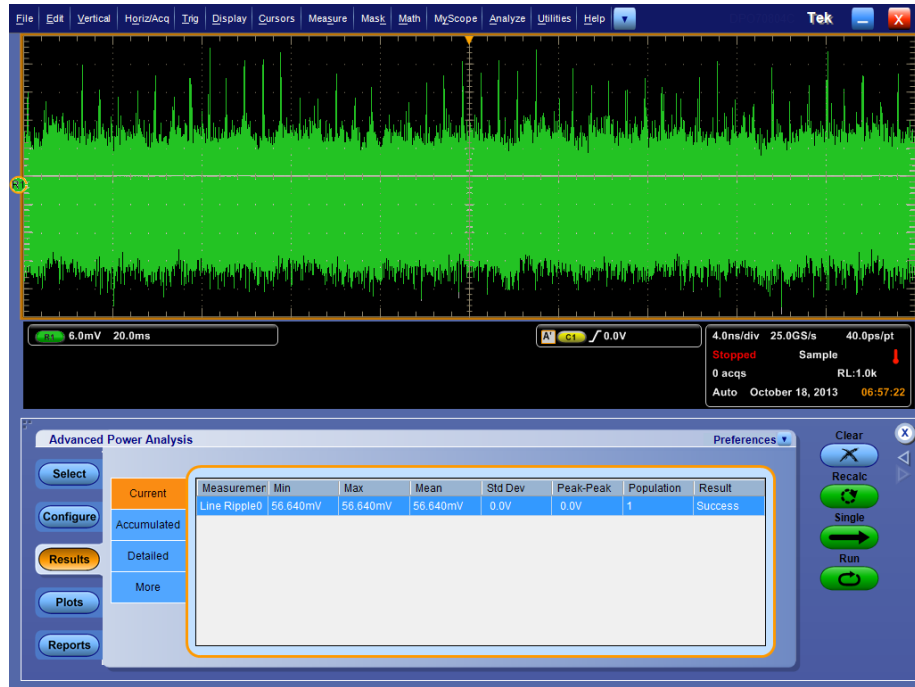

**NOTE.** The smaller the resolution bandwidth (RBW) the better the resolution for spectral measurement results. When Update button is selected, the RBW is computed based on the range (Start and Stop values), and an appropriate record length and sample rate are selected. The list of RBW values are displayed in the drop down list. You can configure specific RBW values based on the desired resolution, and to get the effect of RBW, check the Autoset box. This will enable the source Autoset and takes into account of RBW value and finally sets up the horizontal parameters on the oscilloscope. If the autoset is not performed then expect an error message indicating RBW does not have the required horizontal time base.

**See also.**

[Selecting and configuring measurements-Line ripple](#)

## Spectral analysis

**Selecting and configuring measurements-Spectral analysis. Purpose**

To analyze the frequency component that contributes to the electromagnetic interference and measure the noise/ripple at the output DC voltage frequency range. The result plot component plots the spectrum amplitude on Y-axis and Frequency (units: Hz) on X-axis. Follow these steps to use the Spectral Analysis tool:

1. From the oscilloscope menu bar, select Analyze > Advanced Power Analysis.

The application launches with the Select tab (default) displaying the category of measurements.

2. Select Output Analysis, and then click Spectral Analysis in the measurement pane.
3. Click Configure to configure the measurement.
4. Click  to open the Source Configure dialog box, and then configure the options in the Source Configuration dialog box.

The Source specifies the input source to which the DUT is connected. The available options are: Ch1-Ch4, Math1-Math4 and Ref1-Ref4. These selections depend on the number of channels in the oscilloscope.

5. Double-click in Start and Stop field to set the frequency.

The Start and Stop frequency define the frequency range values of the input signal to be analyzed. The Start and Stop field value can be set between 0 Hz to Scope supported Bandwidth. The default value is 50 Hz in Start and Scope supported bandwidth in Stop.

6. Check the Filter check box to set the filter type and math to the filter source.

Selecting the Frequency check box will automatically disable the controls: Start, Stop, Window type, Update button, Auto set, and Res BW (Hz) of the Spectral Config panel. For more information, refer [POI filter details](#).

---

**NOTE.** While adding the measurement, ensure that the Filter Source Math channel you select is not used for any other added measurements. If the Source configuration Vert & Horiz Autoset is not performed, then measurements will not set the required frequency resolution to perform the filter operation. Here Vert & Horiz Autoset configures the sampling frequency 3.125 MHz and 500k record length after the first run, other PoE filters can be run with the same acquisition by using the Recalc button.

---

7. Select Log Results check box to save the first 10 peak frequencies in .csv file. By default, it is selected.

A new CSV file is created for Single, Recalc and Freerun. The file is saved in C:\Users\

8. Click the Window Type combo box to set the window type.

The window type reduces the spectral leakage, excluding the Rectangular Window, when using the spectral analysis. The available window types are:

Rectangular, Hamming, Hanning, Black-Harris, Gaussian, Flattop2, Kaiser-Bessel and TekExp. In the Options pane, the Auto Setup is selected by default. The application automatically sets the record length and the time base for the given Start, Stop and Window Type inputs. In the Frequency Values pane, click the drop-down arrow to set the RBW(Resolution and Bandwidth) value. The application calculates the RBW values depending on the Start, Stop and Window Type inputs. Click the Update button to update the RBW values. If the Auto Setup check box is not selected, the Update button is disabled and the application runs with the existing record length and time base available in the oscilloscope.

If you have selected a live source in the Source field, enable the DC Block. Clicking the DC Block adjusts the vertical sensitivity of the signal and measures the frequency component of the noise at the output DC voltage.

9. To globally set the coupling, bandwidth limit, cursor gating, and acquisition mode, see [Configuring global settings](#).
10. Open the Source Configuration window, and then click Vert & Horiz button before running the measurements.
11. Select the Run button to acquire the data. If you have entered the Start and Stop frequency values, the application calculates the selected RBW value, sets it to the highest RBW and runs the measurement. If the measurement is successful, the application automatically displays the results.

**Configuring the measurement.** Follow the steps to configure the Spectral Analysis measurement:

- Configure the [Source configuration](#) for the measurement. Click  for the measurement for source configuration.
- Configuration under Options tab:
  - Set the Start and Stop frequency. The Start and Stop frequency define the frequency range values of the input signal to be analyzed. The Start and Stop field value can be set between 0 Hz to Scope supported Bandwidth. The default value is 50 Hz in Start and Scope supported bandwidth in Stop.
  - Select the Window Type from the drop-down list. The window type reduces the spectral leakage, excluding the Rectangular window, when using the spectral analysis. The available window types are: Rectangular, Hamming, Hanning, Black-Harris, Gaussian, Flattop2, Kaiser-Bessel and TekExp.

In the Options pane, the Auto Setup is checked by default. The application automatically sets the record length and the time base for the given Start, Stop and Window Type inputs.

If you have selected a live source in the Source field, enable the DC Block. Clicking the DC Block adjusts the vertical sensitivity of the signal and measures the frequency component of the noise at the output DC voltage.

Select Log Results to save the first 10 peak frequencies in .csv file. By default, it is selected. A new CSV file is created for Single, Recalc and



Freerun. The file is saved in C:\Users\

After setting up window type, start, and stop values, click Update button to automatically update the supported Res BW(Hz). Select from the drop-down list and perform Vert&Horiz "Autoset" from Source Configuration tab. If Autoset is not performed, highest RBW will be considered based on start, stop and horizontal resolution.

The supported Res BW(Hz) values after update is shown in the following image

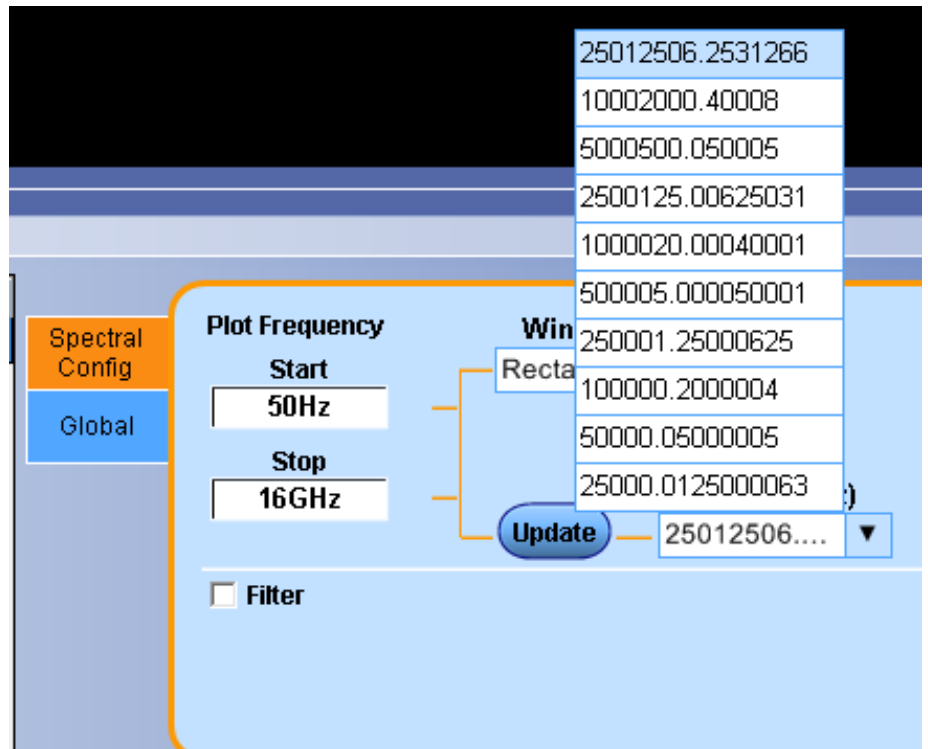

- Spectral config (Filter):

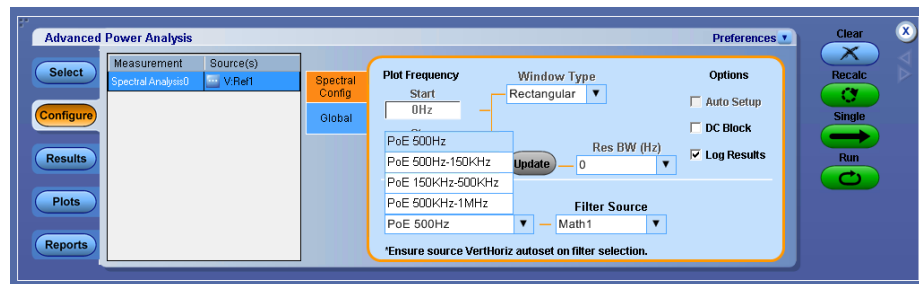
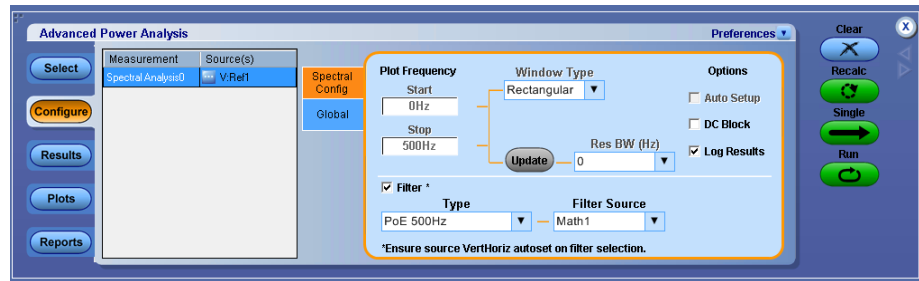

Select the Filter check box, and then select one PoE specific filter from Type drop-down and Math Filter Source. After selecting Filter, navigate to the Source configuration tab and perform the "Vert&Horiz" auto set.

- Configuration under Global tab:

See [Configuring global settings](#). to set the coupling, bandwidth limit, cursor gating and acquisition mode.

- Open the Source Configuration dialog box, and then click Vert & Horiz button before running the measurements.
- Click Run to acquire the data. If the measurement is successful, the application displays the results.

**Viewing results-Spectral analysis.** Click Results to view the result for the selected Spectral Analysis measurement.

Click Results > Detailed to view the first ten peak frequencies, RBW, PeakToPeak and DC value. Click the file name to view the logged result log file. The file is saved in C:\Users\

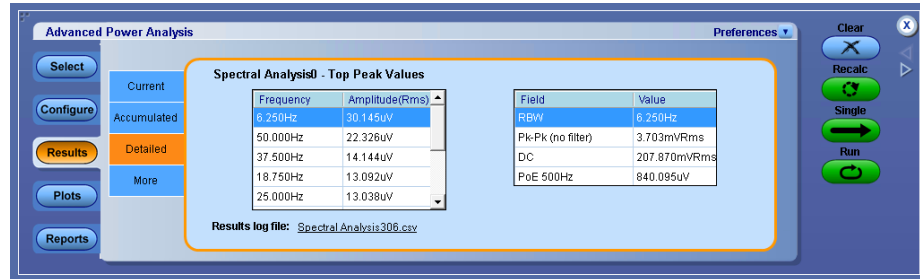

**NOTE.** The result summary shows the statistics of all peaks. The Results detail shows the top 10 peaks.

### Viewing plots-Spectral analysis

1. Click Plots, and then the Spectrum. Click the Single button to view the spectrum plot as below.

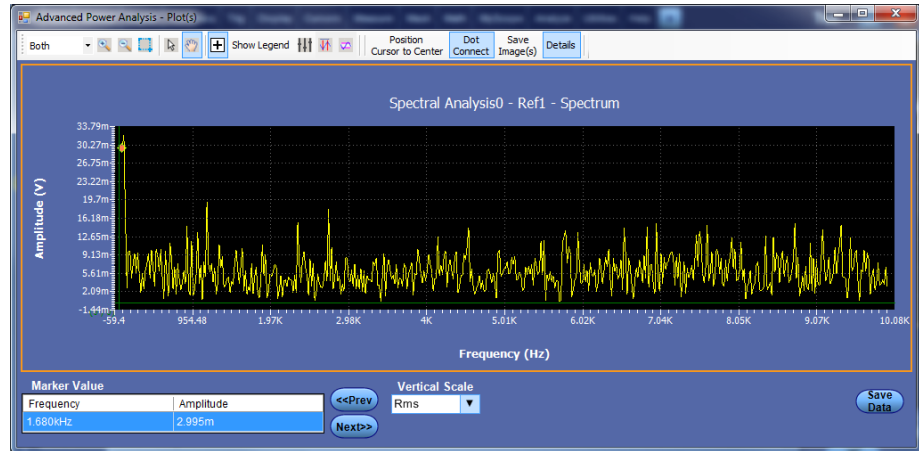

The application plots the Frequency values on the X axis and the Amplitude on the Y axis.

In the Vertical Scale pane, you can switch the plot between the different vertical scale values like dB and Rms.

Select Details in plot menu to display the Marker Value, Vertical Scale and Save Data options.

---

**NOTE.** Use the Next button to move the cursor position to the next peak from the listed position. By default, the application positions the cursor on the first peak. You can travel through the first 500 peak in plot market table or Min based on RL.

---

2. Click the Zoom In button and place the cursor on the specific region to zoom the plot. You can also use the Zoom Out button to zoom out.
3. Click the Save button to save the plot in .csv format in the default directory C:\Users\Public\Tektronix\TekApplications\Advanced Power Analysis\.

**See also.**

[Selecting and configuring measurements-Spectral analysis](#)

[Plot components and features](#)

**Troubleshooting spectral analysis error messages.** If the minimum record length required to configure the Start and Stop values is greater than the maximum record length supported by the application, the application displays the error message "Frequency Range higher than range supported."

## Switching ripple

**Selecting and configuring measurements-Switching ripple.** To select and configure Ripple Measurement, follow these steps:

1. From the oscilloscope menu bar, select Analyze > Advanced Power Analysis. The application launches with the Select tab (default) displaying the category of measurements.
2. Select Output Analysis; click Spectral Ripple in the measurement pane.
3. Click Configure to configure the measurement.

**Configuring the measurement.** Follow the steps to configure the Switching Ripple measurement:

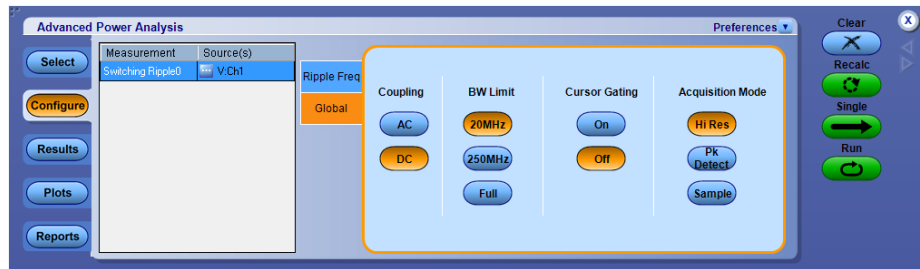

1. Configure the *Source configuration* for the measurement. Click  for the measurement for source configuration.
2. Configuration under Ripple Freq tab:
  - Double-click the Switching Ripple Frequency field and use the keypad that appears to select a switching frequency. The default value is 10 KHz.

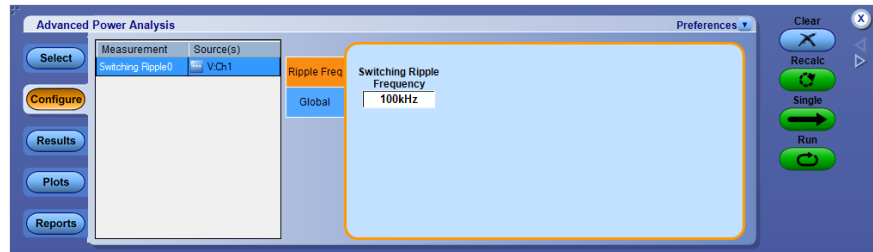

3. Configuration under Global tab:
 

See *Configuring global settings*. to set the coupling, bandwidth limit, cursor gating and acquisition mode.
4. Click Run to acquire the data. If the measurement is successful, the application displays the results.

**Viewing results-Switching ripple.** Click Results to view the result for the selected Switching Ripple measurement.

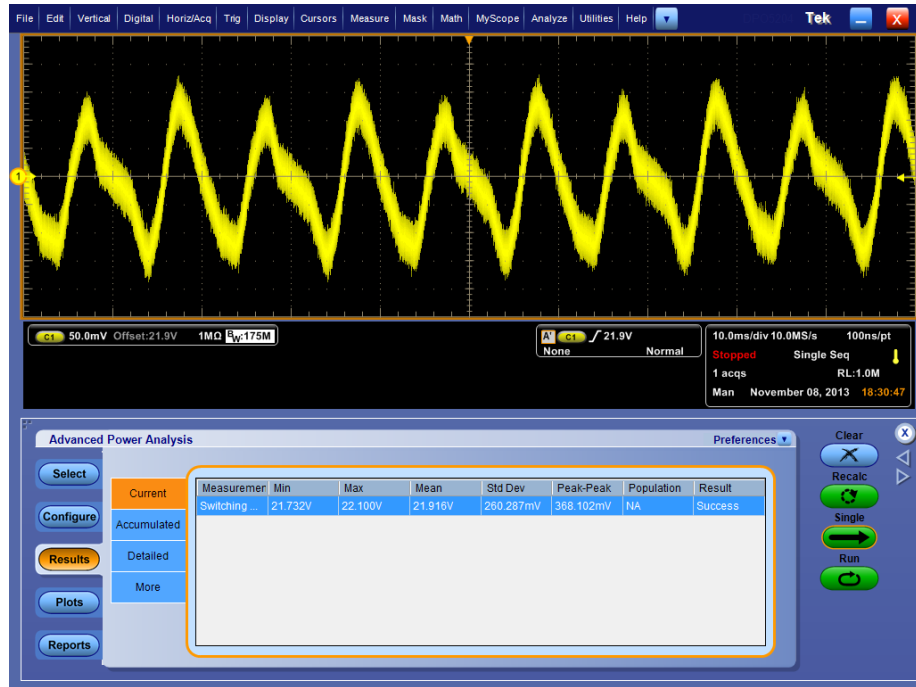

**See also.**

*Selecting and configuring measurements-Switching ripple*

**Turn-On time**

**Selecting and configuring measurements-Turn-On time.** To select and configure Turn-On Time Measurement, follow these steps:

1. From the oscilloscope menu bar, select Analyze > Advanced Power Analysis. The application launches with the Select tab (default) displaying the category of measurements.
2. Select Output Analysis; click Turn On Time in the measurement pane.
3. Click Configure to configure the measurement.



**WARNING.** When connecting to a circuit with hazardous voltages, see the warnings for the individual products and verify that the probes and other components used are within their ratings. Also refer to the topic for more information.

**Configuring the measurement.** Follow the steps to configure the Turn On Time measurement:

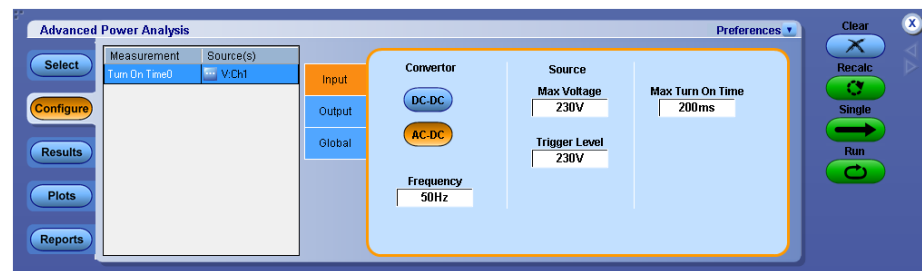

1. Configure the *Source configuration* for the measurement. Click for the measurement for source configuration.
2. Configuration under Input tab:
  - In the Convertor pane, select the type of convertor used: DC-DC or AC-DC. Select the AC-DC option to enable the Frequency option. Double-click the Frequency field and use the keypad that appears to set the line input frequency.
  - In the Source pane, enter the Max Voltage and Trigger Level (1 V to 500 V), by double-clicking the respective field and use the keypad that appears.
  - Double-click the Max Turn-On Time field and use the keypad that appears to enter the expected turn on time. This enables you to set the timing window of the oscilloscope.
3. Configuration under Output tab:
  - Click the ON button to enable Source1. Click the Source1 channel source from the drop-down list. Double-click the Max Voltage field and use the keypad that appears to enter the maximum voltage value.
  - Repeat previous step for Source 2 and Source 3 selections.
4. Switch on the device under test.
5. Configuration under Global tab:

See [Configuring global settings](#). to set the coupling, bandwidth limit, cursor gating and acquisition mode.

- Click Run to acquire the data. If the measurement is successful, the application displays the results.

**Viewing results-Turn-On time.** To view the results, follow these steps:

**NOTE.** To view the results when the application is running, turn off the power supply and turn on to display the results.

- From the oscilloscope menu bar, select Analyze> Advanced Power Analysis, and then press Results.
- The application displays the results for the Turn-On Time measurement with the following data.



See also.

[Selecting and configuring measurements-Turn-on time](#)



## Amplitude

**Cycle min** **Select and configure measurement-Cycle Min.** To select and configure Cycle Min measurement, follow these steps:

1. From the oscilloscope menu bar, select Analyze > Advanced Power Analysis. The application launches with the Select tab (default) displaying the category of measurements.
2. Select Amplitude; click Cycle Min in the measurement pane.
3. Click Configure to configure the measurement.

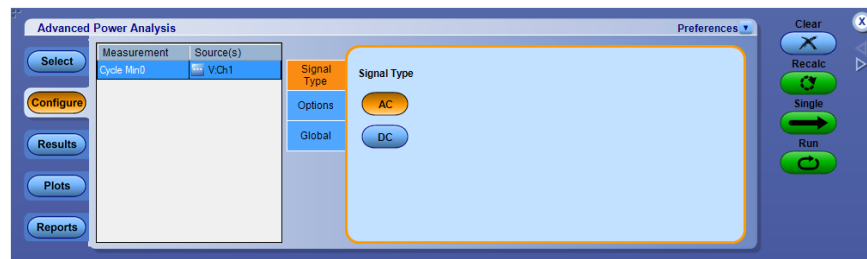

### Configuring the measurement

Follow the steps to configure the Cycle Min measurement:

1. Configure the *Source configuration* for the measurement. Click  for the measurement for source configuration.
2. Configuration under Signal Type tab:
  - Select the signal type as AC or DC. The cycle measurements with DC signal type should be used for measuring signals with large DC components.

3. Configuration under Options tab:

- Select the Units as Percentage or Absolute to set the Ref Level and Hysteresis values in percentage or in absolute value.
- Set the Ref level value within the range --5.99 kV to 5.99 kV for absolute units and 1% to 99% for units as percentage.
- Set the Hysteresis value within the range 0 V to 3 kV for absolute units and 1% to 99% for units as percentage.

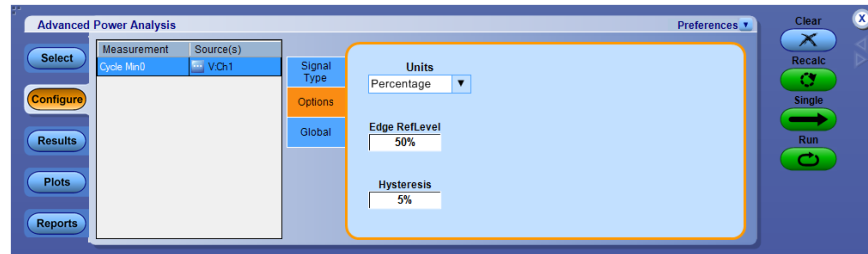

4. Configuration under Global tab:

See [Configuring global settings](#). to set the coupling, bandwidth limit, cursor gating and acquisition mode.

5. Click Run to acquire the data. If the measurement is successful, the application displays the results.

**See also.**

[Viewing results-cycle min](#)

[Source configuration panel](#)

[Source autoset](#)

**Viewing result-cycle min.** Click Results to view the result for the selected Cycle Min measurement.

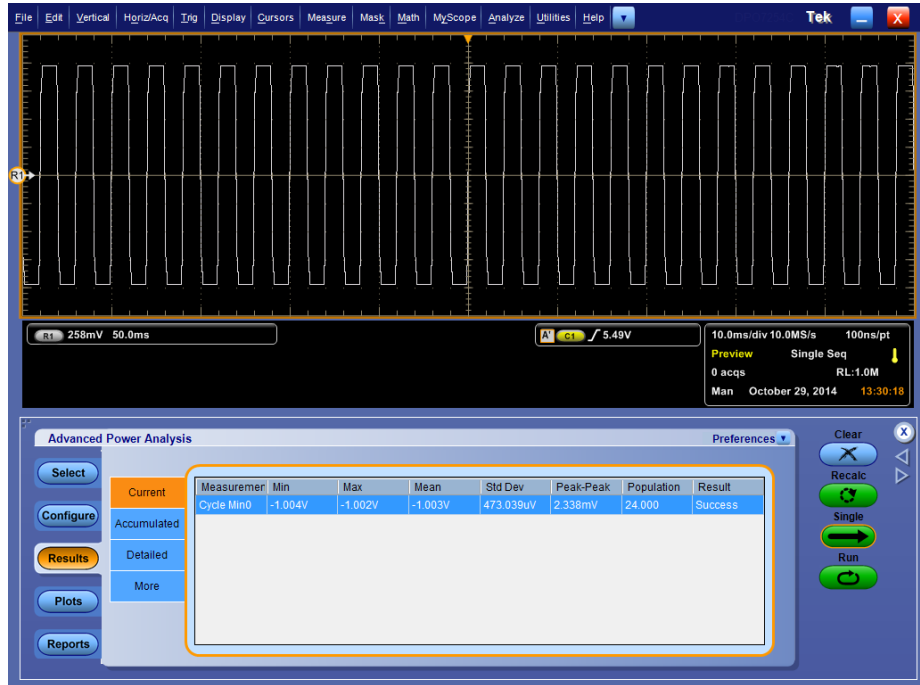

**Viewing plots-cycle min**

Click Plots and select Time Trend or Histogram to view the plots for the selected Cycle Min measurement

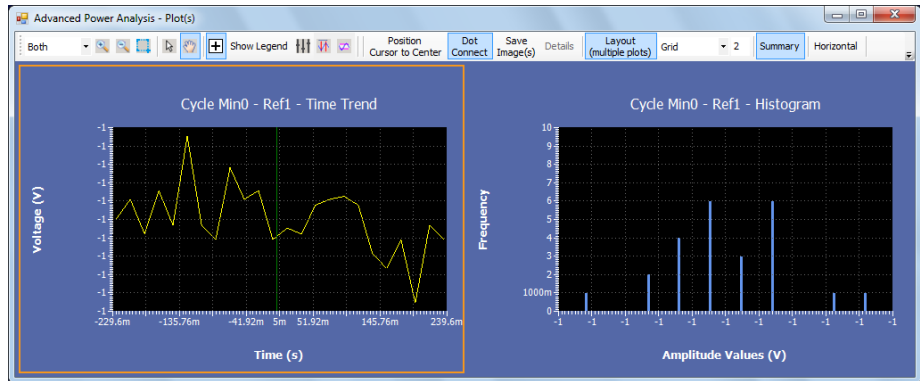

**See also.**

*Select and configure measurement - cycle min*

**Cycle max** **Select and configure measurement-Cycle Max.** To select and configure Cycle Max measurement, follow these steps:

1. From the oscilloscope menu bar, select Analyze > Advanced Power Analysis. The application launches with the Select tab (default) displaying the category of measurements.
2. Select Amplitude; click Cycle Max in the measurement pane.
3. Click Configure to configure the measurement.

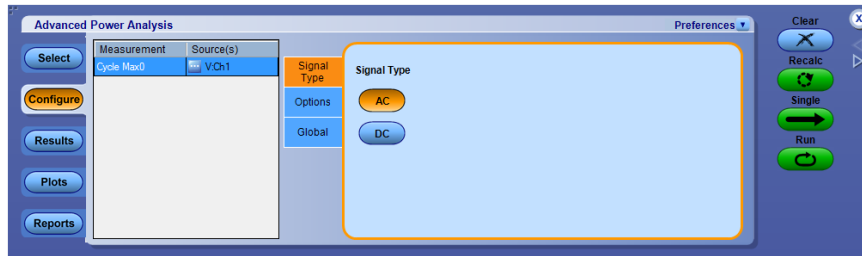

### Configuring the measurement

Follow the steps to configure the Cycle Max measurement:

1. Configure the *Source configuration* for the measurement. Click  for the measurement for source configuration.
2. Configuration under Signal Type tab:
  - Select the signal type as AC or DC. The cycle measurements with DC signal type should be used for measuring signals with large DC components.
3. Configuration under Options tab:
  - Select the Units as Percentage or Absolute to set the Ref Level and Hysteresis values in percentage or in absolute value.
  - Set the Ref level value within the range --5.99 kV to 5.99 kV for absolute units and 1% to 99% for units as percentage.
  - Set the Hysteresis value within the range 0 V to 3 kV for absolute units and 1% to 99% for units as percentage.

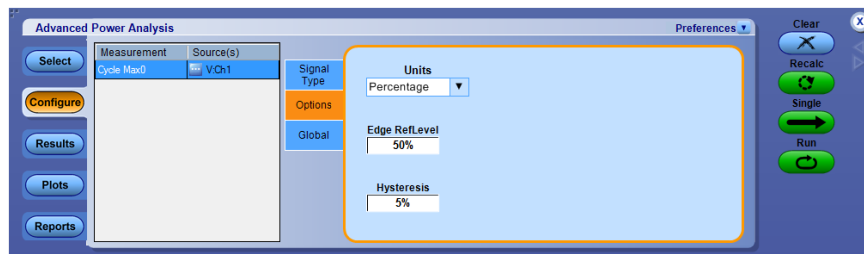

4. Configuration under Global tab:  
See [Configuring global settings](#). to set the coupling, bandwidth limit, cursor gating and acquisition mode.
5. Click Run to acquire the data. If the measurement is successful, the application displays the results.

**See also.**

[Viewing results-cycle max](#)

[Source configuration panel](#)

[Source autose](#)

**Viewing results-cycle max.** Click Results to view the result for the selected Cycle Max measurement.

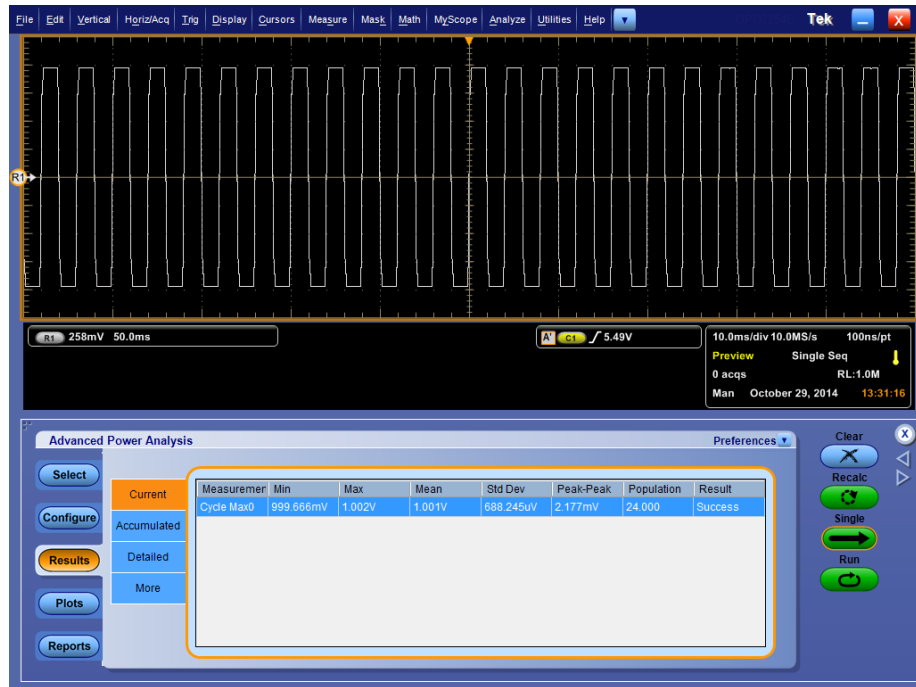

**Viewing plots-cycle max**

Click Plots and select Time Trend and/or Histogram to view the plots for the selected Cycle Max measurement

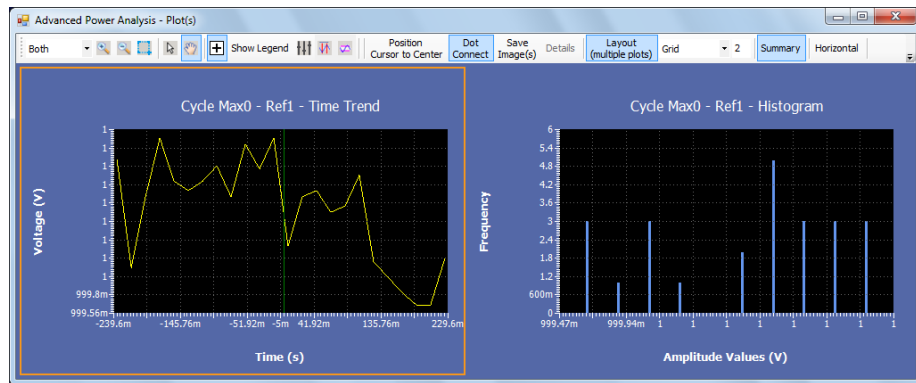

**See also.**

[Select and configure measurement - cycle max](#)

**Cycle peak-to-peak (Pk-Pk)**

**Select and configure measurement-Cycle peak-to-peak.** To select and configure Cycle peak-to-peak measurement, follow these steps:

1. From the oscilloscope menu bar, select Analyze > Advanced Power Analysis. The application launches with the Select tab (default) displaying the category of measurements.
2. Select Amplitude; click Cycle PkPk in the measurement pane.
3. Click Configure to configure the measurement.

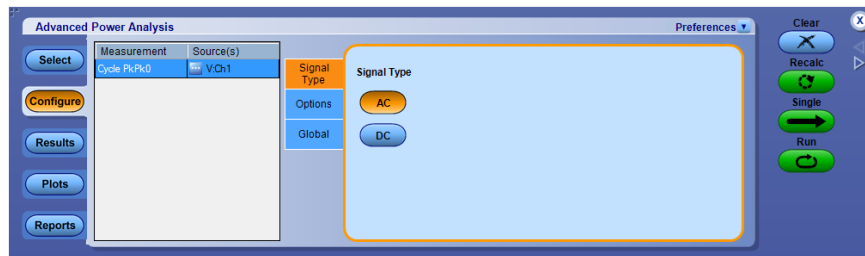
**Configuring the measurement**

Follow the steps to configure the Cycle PkPk measurement:

1. Configure the *Source configuration* for the measurement. Click  for the measurement for source configuration.
2. Configuration under Signal Type tab:
  - Select the signal type as AC or DC. The cycle measurements with DC signal type should be used for measuring signals with large DC components.
3. Configuration under Options tab:
  - Select the Units as Percentage or Absolute to set the Ref Level and Hysteresis values in percentage or in absolute value.
  - Set the Ref level value within the range --5.99 kV to 5.99 kV for absolute units and 1% to 99% for units as percentage.
  - Set the Hysteresis value within the range 0 V to 3 kV for absolute units and 1% to 99% for units as percentage.

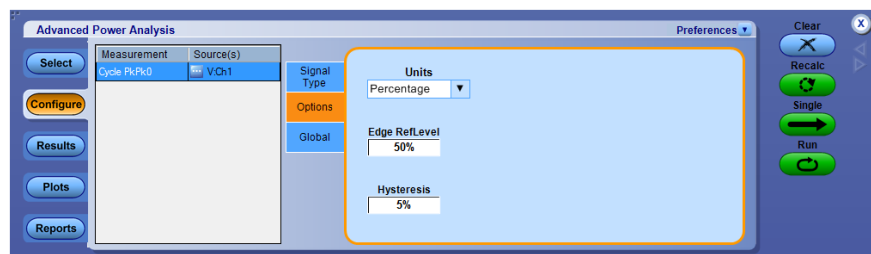

4. Configuration under Global tab:

See [Configuring global settings](#) to set the coupling, bandwidth limit, cursor gating and acquisition mode.

5. Click Run to acquire the data. If the measurement is successful, the application displays the results.

**See also.**

[Viewing results-cycle peak-to-peak](#)

[Source configuration panel](#)

[Source autose](#)



**Viewing results-Cycle peak-to-peak.** Click Results to view the result for the selected Cycle peak-to-peak measurement.

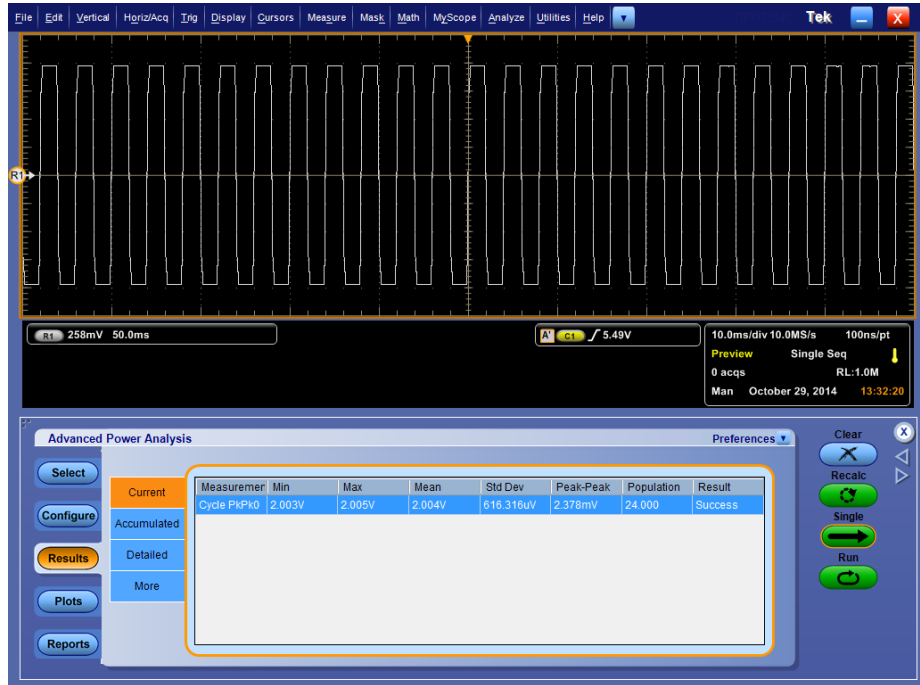

**Viewing plots-Cycle peak-to-peak**

Click Plots and select Time Trend and/or Histogram to view the plots for the selected Cycle PkPk measurement

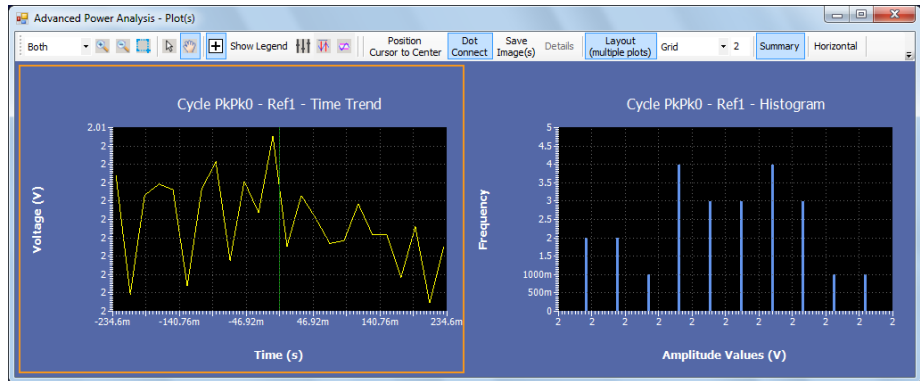

**See also.**

*Select and configure measurement - cycle peak-to-peak*

**High** **Select and configure measurement-Amplitude High.** To select and configure Amplitude High measurement, follow these steps:

1. From the oscilloscope menu bar, select Analyze > Advanced Power Analysis. The application launches with the Select tab (default) displaying the category of measurements.
2. Select Amplitude; click High in the measurement pane.
3. Click Configure to configure the measurement.

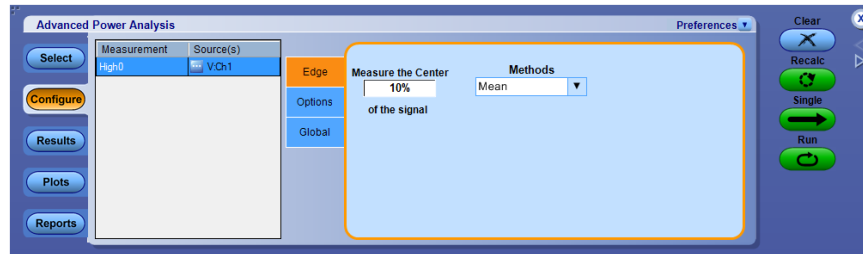

### Configuring the measurement

Follow the steps to configure the Amplitude High measurement:

1. Configure the *Source configuration* for the measurement. Click  for the measurement for source configuration.
2. Configuration under Edge tab:
  - Move the Center X% of the signal determines what % (1 to 100) of a unit interval, centered in the middle of the bit shall be admitted in each measurement. The waveform points selected by the % form a distribution (vertical histogram) from which a single value is extracted, based on the method control.
  - Method determines whether the Mean value or the Median of the selected distribution is used for the measurement value for each unit interval.
3. Configuration under Options tab:
  - Select the Units as Percentage or Absolute to set the Ref Level and Hysteresis values in percentage or in absolute value.
  - Set the Ref level value within the range --5.99 kV to 5.99 kV for absolute units and 1% to 99% for units as percentage.
  - Set the Hysteresis value within the range 0 V to 3 kV for absolute units and 1% to 99% for units as percentage.
4. Configuration under Global tab:
 

See *Configuring global settings*. to set the coupling, bandwidth limit, cursor gating and acquisition mode.
5. Click Run to acquire the data. If the measurement is successful, the application displays the results.

See also.

[Viewing results-Amplitude high](#)

[Source configuration panel](#)

[Source autoset](#)

**Viewing results-Amplitude High.** Click Results to view the result for the selected Amplitude High measurement.



**Viewing plots-Amplitude High**

Click Plots and select Time Trend or Histogram to view the plots for the selected Amplitude High measurement

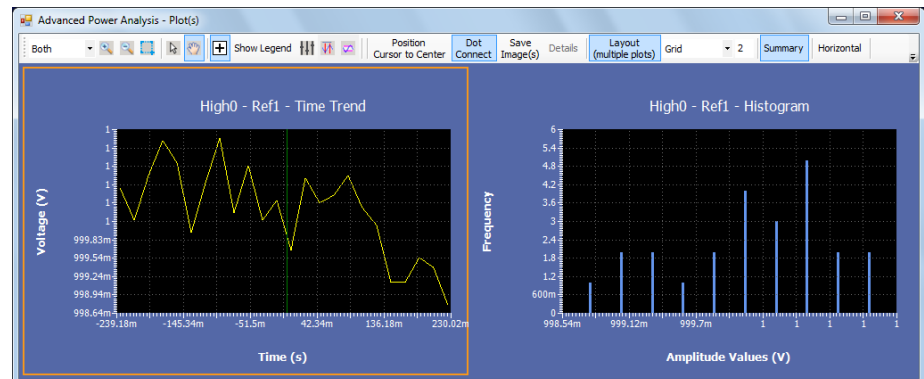

See also.

[Select and configure measurement - Amplitude high](#)

**Low** **Select and configure measurement-Amplitude Low.** To select and configure Amplitude Low measurement, follow these steps:

1. From the oscilloscope menu bar, select Analyze > Advanced Power Analysis. The application launches with the Select tab (default) displaying the category of measurements.
2. Select Amplitude; click Low in the measurement pane.
3. Click Configure to configure the measurement.

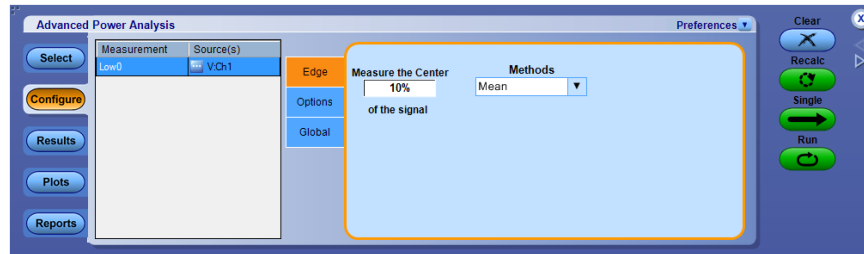

### Configuring the measurement

Follow the steps to configure the Amplitude Low measurement:

1. Configure the *Source configuration* for the measurement. Click  for the measurement for source configuration.
2. Configuration under Edge tab:
  - Move the Center X% of the signal determines what % (1 to 100) of a unit interval, centered in the middle of the bit shall be admitted in each measurement. The waveform points selected by the % form a distribution (vertical histogram) from which a single value is extracted, based on the method control.
  - Method determines whether the Mean value or the Median of the selected distribution is used for the measurement value for each unit interval.

### 3. Configuration under Options tab:

- Select the Units as Percentage or Absolute to set the Ref Level and Hysteresis values in percentage or in absolute value.
- Set the Ref level value within the range --5.99 kV to 5.99 kV for absolute units and 1% to 99% for units as percentage.
- Set the Hysteresis value within the range 0 V to 3 kV for absolute units and 1% to 99% for units as percentage.

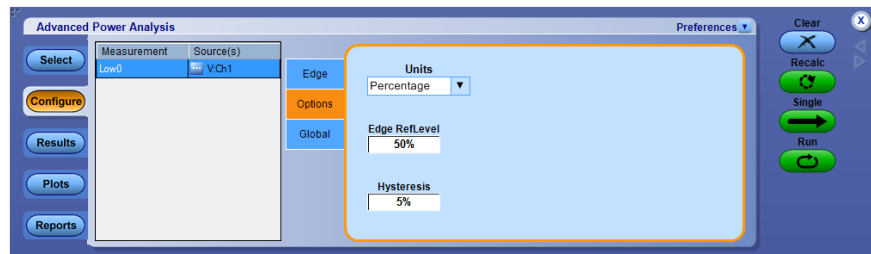

### 4. Configuration under Global tab:

See [Configuring global settings](#) to set the coupling, bandwidth limit, cursor gating and acquisition mode.

5. Click Run to acquire the data. If the measurement is successful, the application displays the results.

#### See also.

[Viewing results-Amplitude low](#)

[Source configuration panel](#)

[Source autose](#)

**Viewing results-Amplitude Low.** Click Results to view the result for the selected Amplitude Low measurement.

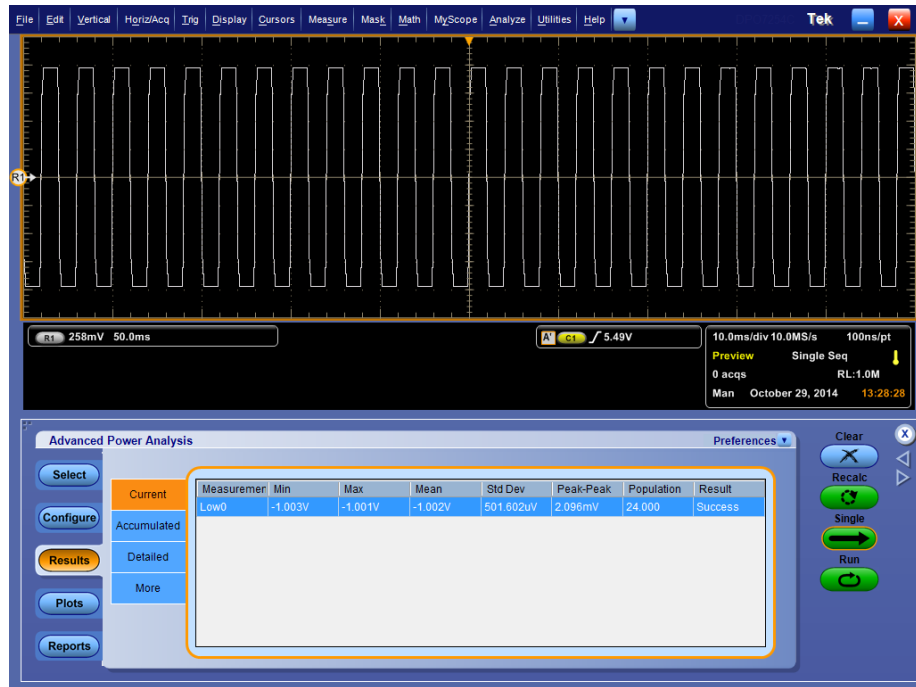

**Viewing plots-Amplitude Low**

Click Plots and select Time Trend or Histogram to view the plots for the selected Amplitude Low measurement

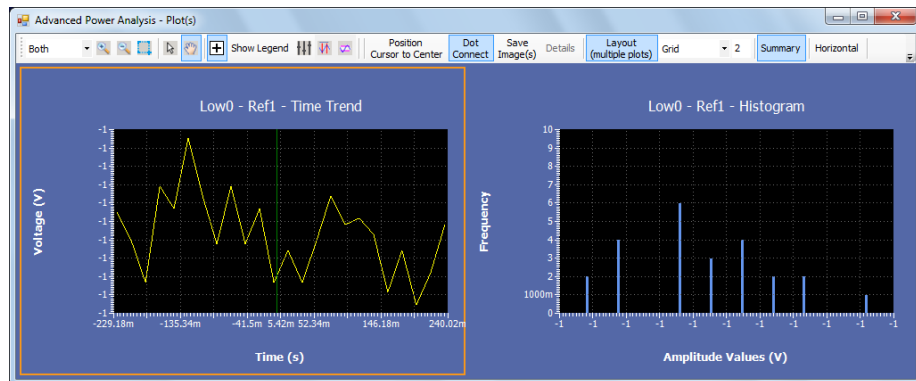

**See also.**

*Select and configure measurement - Amplitude low*

**High-low** **Select and configure measurement-Amplitude High Low.** To select and configure Amplitude High Low measurement, follow the steps:

1. From the oscilloscope menu bar, select Analyze > Advanced Power Analysis. The application launches with the Select tab (default) displaying the category of measurements.
2. Select Amplitude; click High Low in the measurement pane.
3. Click Configure to configure the measurement.

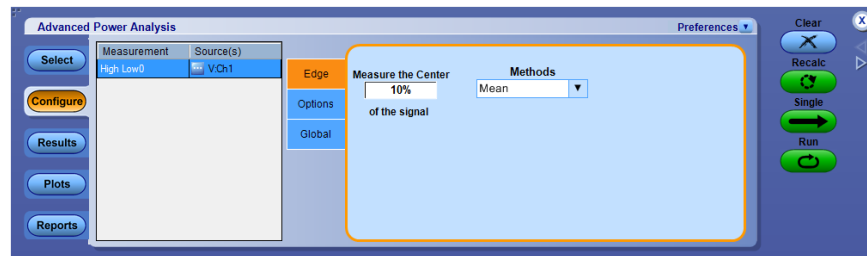

### Configuring the measurement

Follow the steps to configure the Amplitude High Low measurement:

1. Configure the *Source configuration* for the measurement. Click  for the measurement for source configuration.
2. Configuration under Edge tab:
  - Move the Center X% of the signal determines what % (1 to 100) of a unit interval, centered in the middle of the bit shall be admitted in each measurement. The waveform points selected by the % form a distribution (vertical histogram) from which a single value is extracted, based on the method control.
  - Method determines whether the Mean value or the Median of the selected distribution is used for the measurement value for each unit interval.
3. Configuration under Options tab:
  - Select the Units as Percentage or Absolute to set the Ref Level and Hysteresis values in percentage or in absolute value.
  - Set the Ref level value within the range --5.99 kV to 5.99 kV for absolute units and 1% to 99% for units as percentage.
  - Set the Hysteresis value within the range 0 V to 3 kV for absolute units and 1% to 99% for units as percentage.
4. Configuration under Global tab:
 

See *Configuring global settings*. to set the coupling, bandwidth limit, cursor gating and acquisition mode.
5. Click Run to acquire the data. If the measurement is successful, the application displays the results.

See also.

[Viewing results-Amplitude high-low](#)

[Source configuration panel](#)

[Source autoset](#)

**Viewing results-Amplitude High Low.** Click Results to view the result for the selected Amplitude High Low measurement.

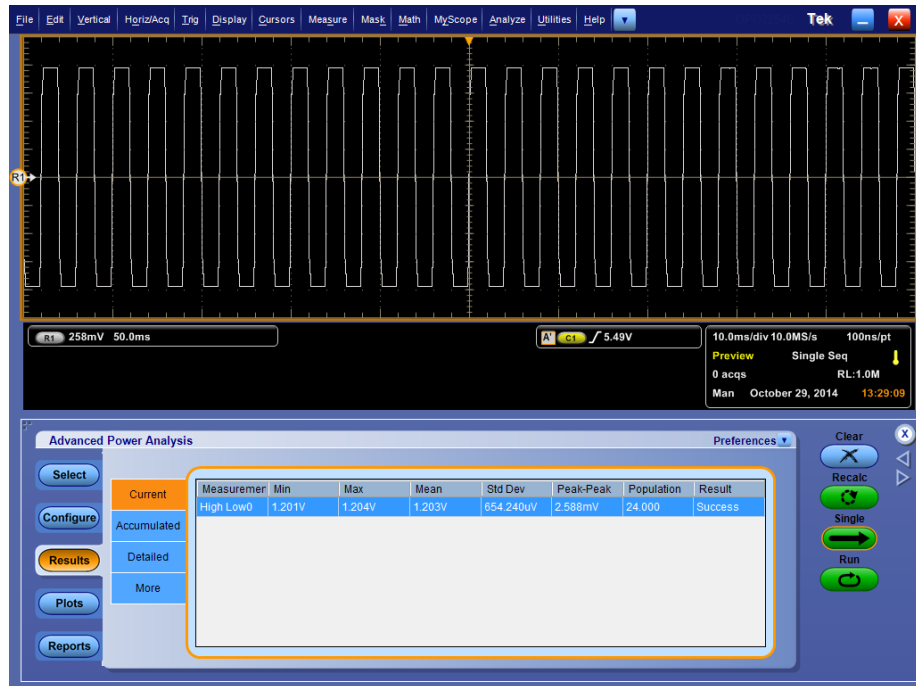

**Viewing plots-Amplitude High Low**

Click Plots and select Time Trend or Histogram to view the plots for the selected Amplitude High Low measurement

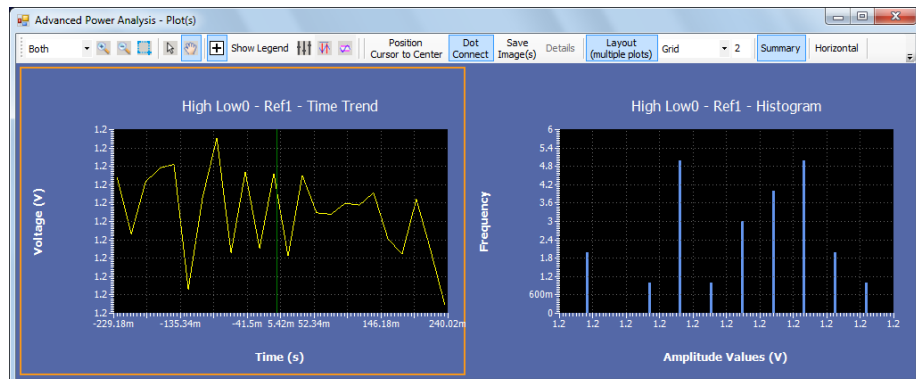

See also.

[Select and configure measurement - Amplitude high-low](#)



---

# Tutorial

## Introduction to the tutorial

This tutorial teaches you the following:

1. Reference waveform and mask files
2. Starting the Application
3. Setting Up the Oscilloscope
4. Measuring Switching Loss and viewing results
5. Measuring Magnetics and viewing results

## Reference waveform and mask files

Installing the application provides the reference waveform and mask files. The reference waveforms can be used to learn the application and the features. The reference mask can be used to learn the mask feature for the SOA measurement.

The waveform files are found at C:\Users\Public\Tektronix\TekApplications\Advanced Power Analysis\Waveforms\.

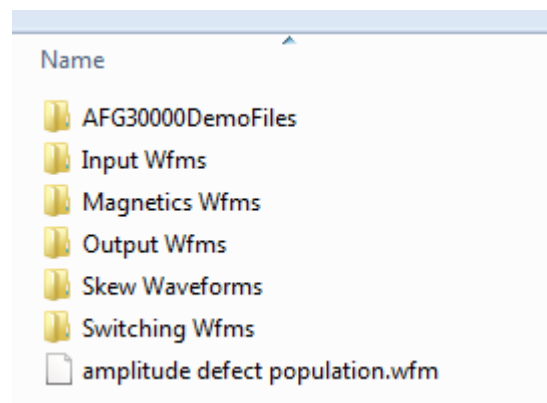

The mask files are found at C:\Users\Public\Tektronix\TekApplications\Advanced Power Analysis\SOA Mask\.

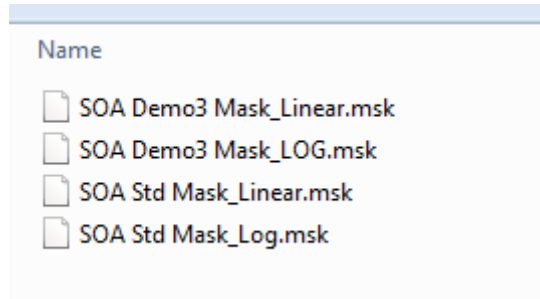

## Starting the application

To start the application, from the oscilloscope menu, select Analyze > Advanced Power Analysis.

## Setting up the oscilloscope

To set up the oscilloscope, select File > Default Setup. The oscilloscope is configured to default factory settings.

## Measuring Switching Loss

This section discusses how to measure switching loss, view the results and generate the report. To perform these tasks, *install the application* and enable the option key.

The following steps explain how to measure switching loss:

1. From the oscilloscope menu, select **File > Recall**.
2. In Recall window, select Waveform, set the Destination to Ref1, select SwitchingLossSteadyStateVoltage.wfm from C:\Users\Public\Tektronix\TekApplications\Advanced Power Analysis\Waveforms\Switching Wfms and click Recall.
3. From the oscilloscope menu, select File> Recall.
4. In Recall window, select Waveform, set the Destination to Ref2, select SwitchingLossSteadyStateCurrent.wfm from C:\Users\Public\Tektronix\TekApplications\Advanced Power Analysis\Waveforms\Switching Wfms and click Recall.
5. In DPOPWR application, select Switching Analysis tab. Click Switching Loss, then the Configure button.

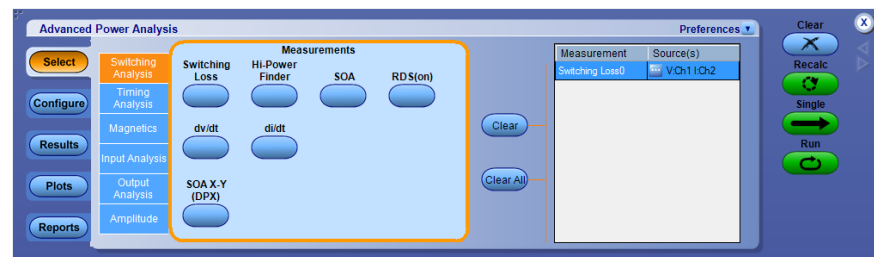

- In the source selection panel, set the Source to Ref, Voltage to Ref1 and Current to Ref2.

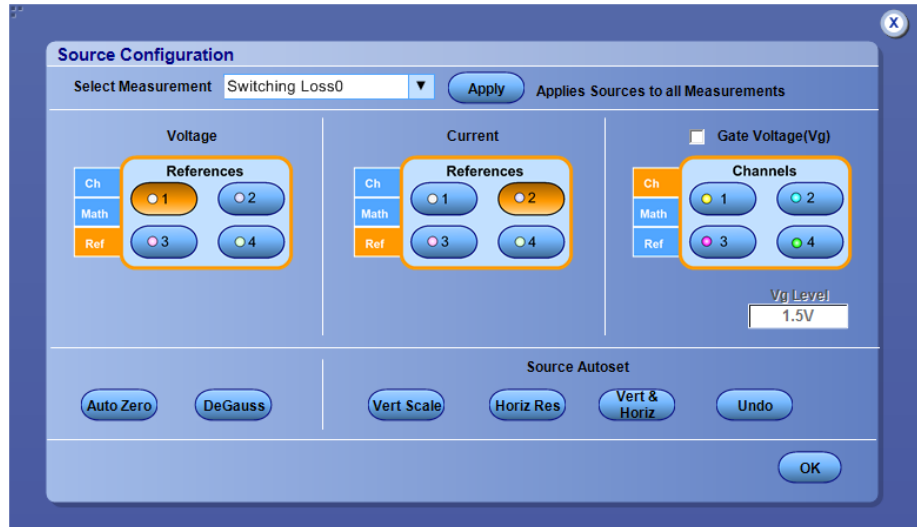

- Configure the options in the Type, On-Off Level, and the Options tabs. Press the Single button.

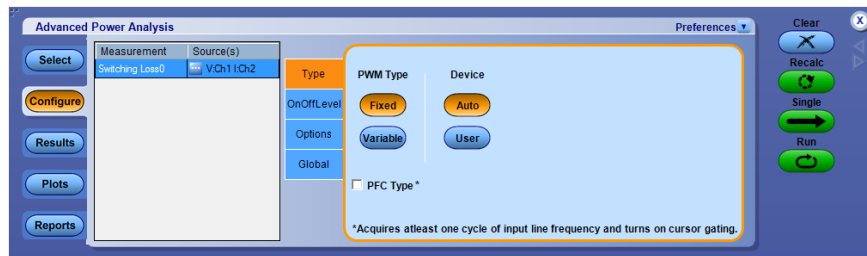

- The application displays the results as Turn-on Power Loss, Turn-off Power Loss and Power Loss.

- Click Results tab to view the statistical results.

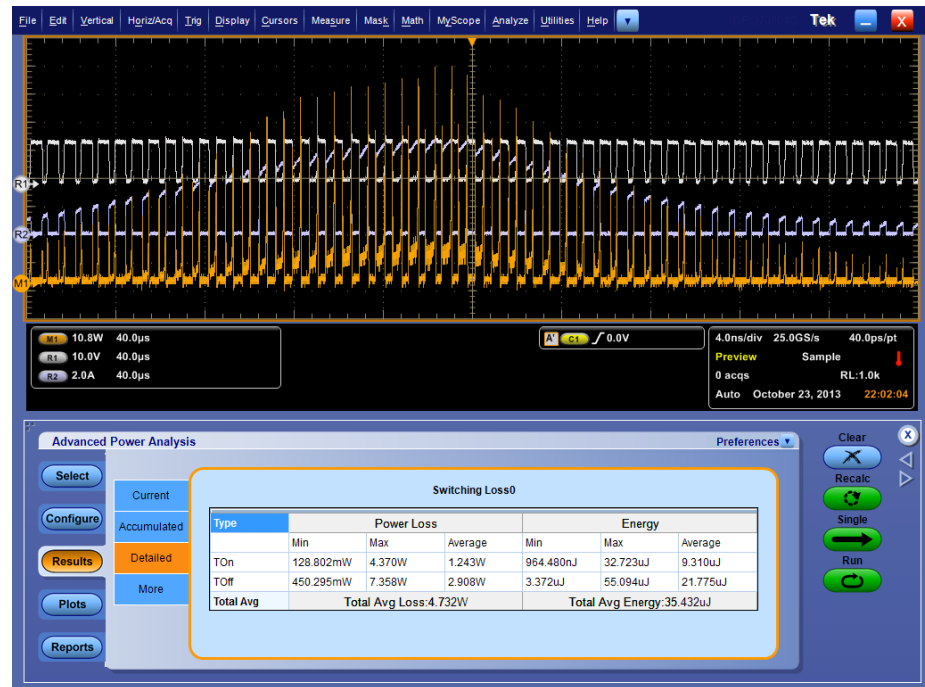

## Measuring Magnetics

This section discuss how to measure the Magnetics, view the results and generate the report. To perform these tasks, *Installing the application* and enable the option key.

The following steps explain how to measure magnetics:

- From the oscilloscope menu, select **File > Recall**.
- In Recall window, select Waveform, set the Destination to Ref1, select MagVoltage.wfm from C:\Users\Public\Tektronix\TekApplications\Advanced Power Analysis\Waveforms\Magnetic Wfms and click Recall.
- From the oscilloscope menu, select File > Recall.
- In Recall window, select Waveform, set the Destination to Ref1, select MagCurrent.wfm from C:\Users\Public\Tektronix\TekApplications\Advanced Power Analysis\Waveforms\Magnetic Wfms and click Recall.
- In DPOPWR application, select the Magnetics tab.

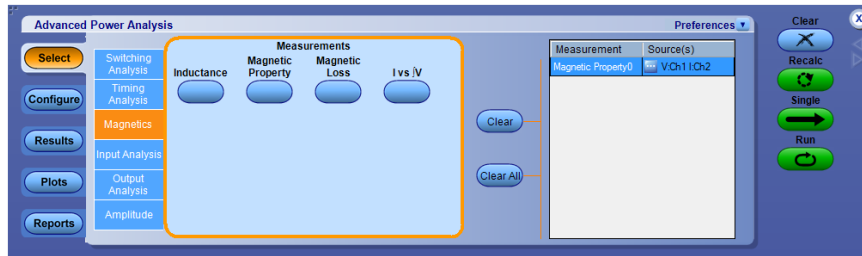

1. Select the Magnetic Property option and click Configure.

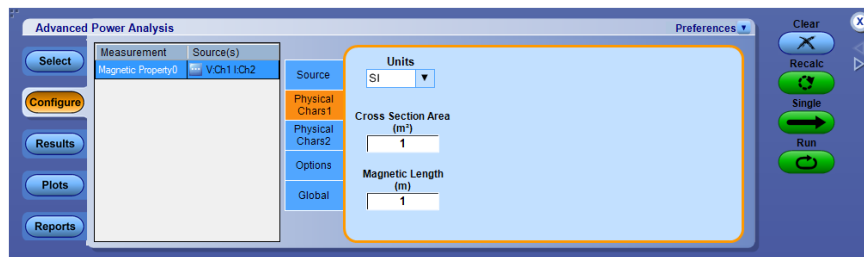

2. In the Source Configuration panel, set the Source to Ref, Voltage to Ref1 and Current to Ref2.

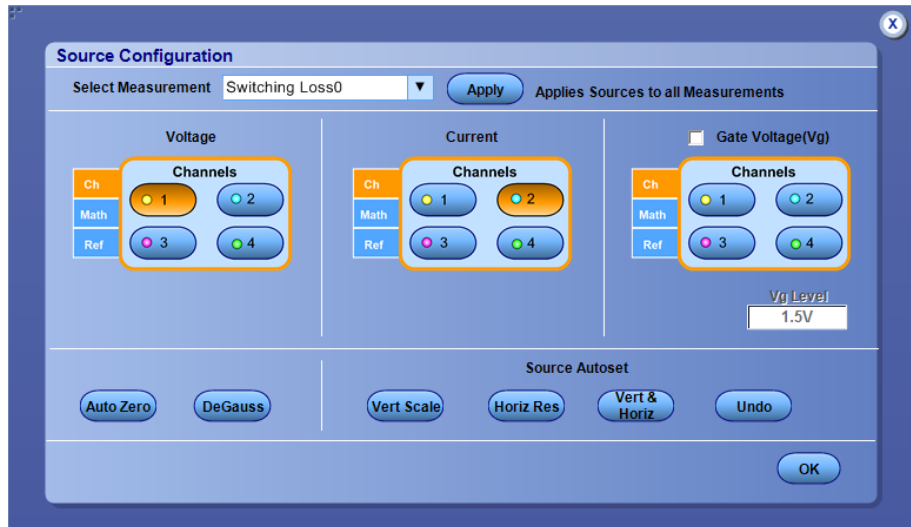

1. Select the Freq and Duty button, Cursor Gating Off button, # of Windings button from the Source, Global, and Physical Chars2 tab.
2. In the Physical Chars1 tab, select the SI Unit, set the Magnetic Length to 0.0265m, and the Cross section Area to .00001358m<sup>2</sup>. In the Physical Chars2 tab, set the # of Turns to 50.

3. Click Single to display the results in a B-H Curve format. The application displays the results for the Bpeak, Br, Hc, HMax and I-ripple.
4. Click Results tab to view the magnetic property results.







---

# Application examples

## About application examples

This section presents application examples. The simplified AC/DC circuit diagram example highlight the application measurements and give you the ideas on how to use the application to solve the test problems.

To run the application examples, install the application and enable the option key on the oscilloscope, connect the probes to the device under test and configure the device. To install the application, refer to [Installation procedures](#). For more information on compatible probes, refer to the section, [Compatibility](#) and [Current probes](#). To configure the application, refer to [Setting up the application](#).

### See also

[Measure switching loss](#)

[Measure Hi-Power finder](#)

[Measure magnetic loss](#)

## To increase efficiency in a switching power supply

### Measure Switching Loss

**Purpose:** To optimize the power loss at switching device and improve the efficiency of power supply.

**Specifying the equipment:**

1. Tektronix oscilloscope mentioned in the [Compatibility](#) section
2. DPOPWR application
3. Ccurrent probe and differential probe. Refer [Current probes](#) for details.

**Equipment setup:** *Refer to General Safety Summary before connecting to a circuit.*

1. To measure the voltage across the drain, connect the voltage probe and the current probe to the switching source of the MOSFET as shown in the following diagram.

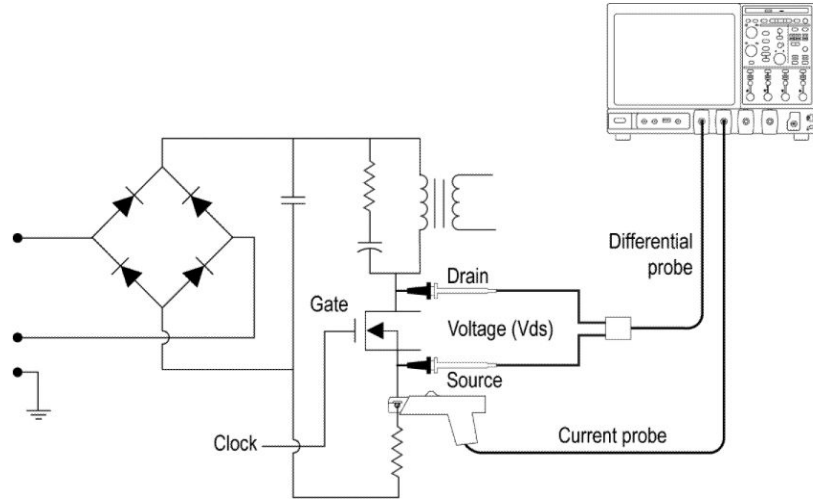

**Figure 18: Equipment connection setup for Switching loss**



**WARNING.** *When connecting to a circuit with hazardous voltages, see the warnings for the individual products and verify that the probes and other components used are within their ratings. Also refer to the topic [General Safety Summary](#) for more information.*

2. From the Oscilloscope menu, select Analyze > Advanced Power Analysis
3. Select the Switching Analysis tab and click Switching Loss.
4. Click the configure button. In the Preferences window, select the I-Probe Settings. Select the Perform Deskew button to deskew the probes and the channels.
5. Select Run to acquire data and click Results to view the results..

Result	Description
Minimum	Measures the minimum power loss or cycle in the acquired data
Maximum	Measures the maximum power loss or cycle in the acquired data
Average	Measures the variation in the power loss for multiple acquisitions

**Measure Hi-Power finder**

**Purpose:** To analyze the Hi-Power Finder in a switching device in a dynamic environment.

**Specifying the equipment:**

1. Tektronix oscilloscope mentioned in the [Compatibility](#) section
2. DPOPWR application
3. Current probe and differential probe. Refer [Current probes](#) for details.

**Equipment setup:** *Refer to General Safety Summary before connecting to a circuit.*

1. To measure the voltage across drain, connect the Tektronix differential and current probe to the switching source of the MOSFET as shown in the following diagram.

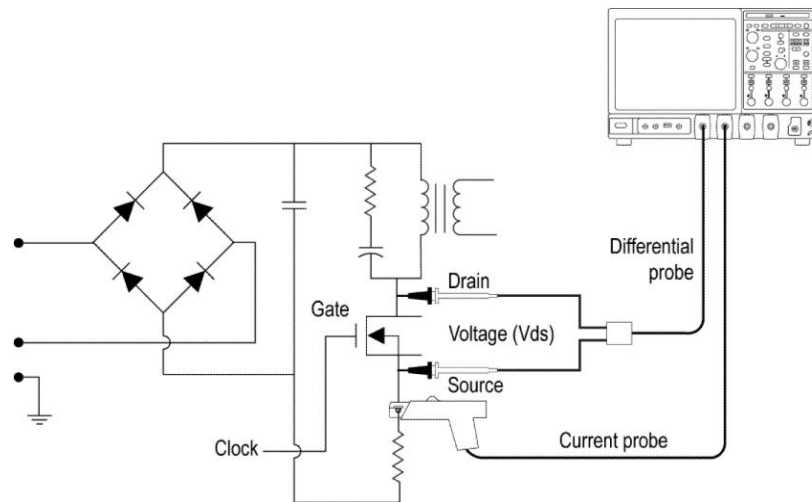

**Figure 19: Equipment connection setup for Hi-Power finder**



**WARNING.** *When connecting to a circuit with hazardous voltages, see the warnings for the individual products and verify that the probes and other components used are within their ratings. Also refer to the topic [General Safety Summary](#) for more information.*

2. From the Oscilloscope menu, select Analyze > Advanced Power Analysis
3. Select the Switching Analysis tab.
4. Select Hi-Power Finder option and press the Configure button.
5. In the common configuration panel, select the I-Probe Settings. In the preferences window, select the Deskew button to deskew probes and channels.
6. Select the Hi-Power Finder measurement.

7. Select the Deskew button to deskew. Select Run by setting the appropriate trigger related to the dynamic environment and display the results.

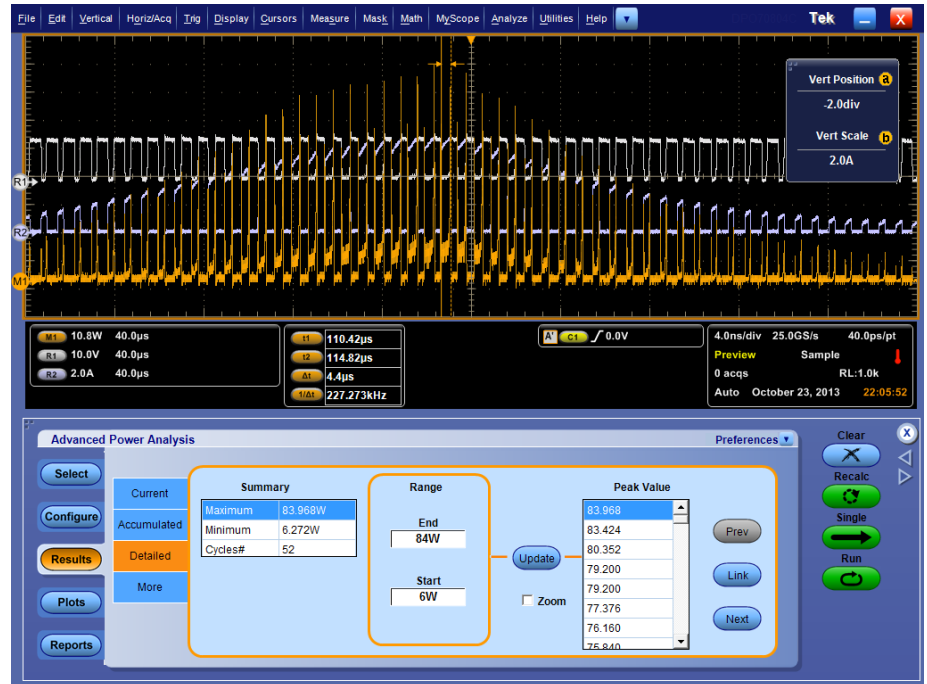

The results display the instantaneous peak power in the switching and the number of peaks in the acquired data. Select the range of interest to view the area of interest in the instantaneous peak power.

8. You can link the cursor by selecting the instantaneous peak power from the table.
9. Select the zoom button to view the detailed information around the cursor.

## Measure magnetic loss

**Purpose:** To measure Magnetic Loss.

### Specifying the equipment:

1. Tektronix oscilloscope mentioned in the *Compatibility* section
2. DPOPWR application
3. Current probe and differential probe. Refer the section *Current probes* for details.

**Equipment setup:** *Refer to General Safety Summary before connecting to a circuit*

1. Connect the Tektronix differential and current probe to the switching to measure the voltage across the inductor as shown in the following diagram.

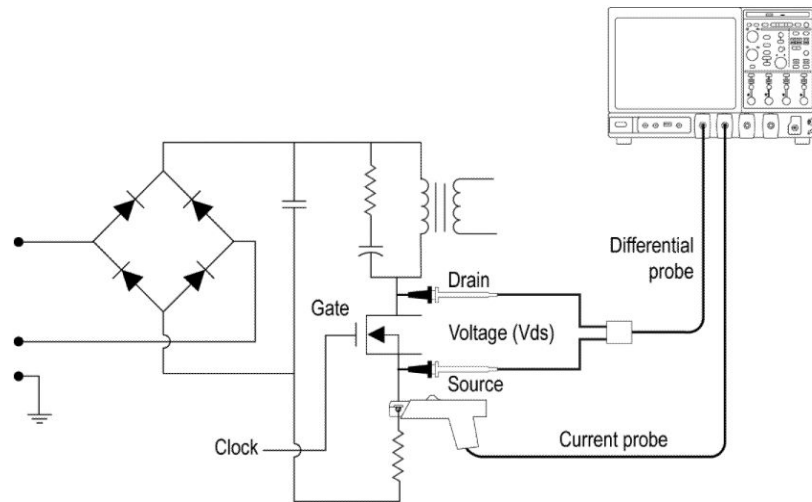

**Figure 20: Equipment connection setup for Magnetic loss**



**WARNING.** *When connecting to a circuit with hazardous voltages, see the warnings for the individual products and verify that the probes and other components used are within their ratings. Also refer to the topic [General Safety Summary](#) for more information.*

2. From the Oscilloscope menu, select Analyze > Advanced Power Analysis
3. Select the Magnetics tab.
4. Select Magnetic Loss measurement. Select Configure. In the Global tab, select the Cursor Gating option.
5. In the configuration tabs, set the appropriate I-Probe Settings. In the Preferences window, select the Deskew button to deskew the voltage and current signal.

6. Press Run to measure and display the result shown below:

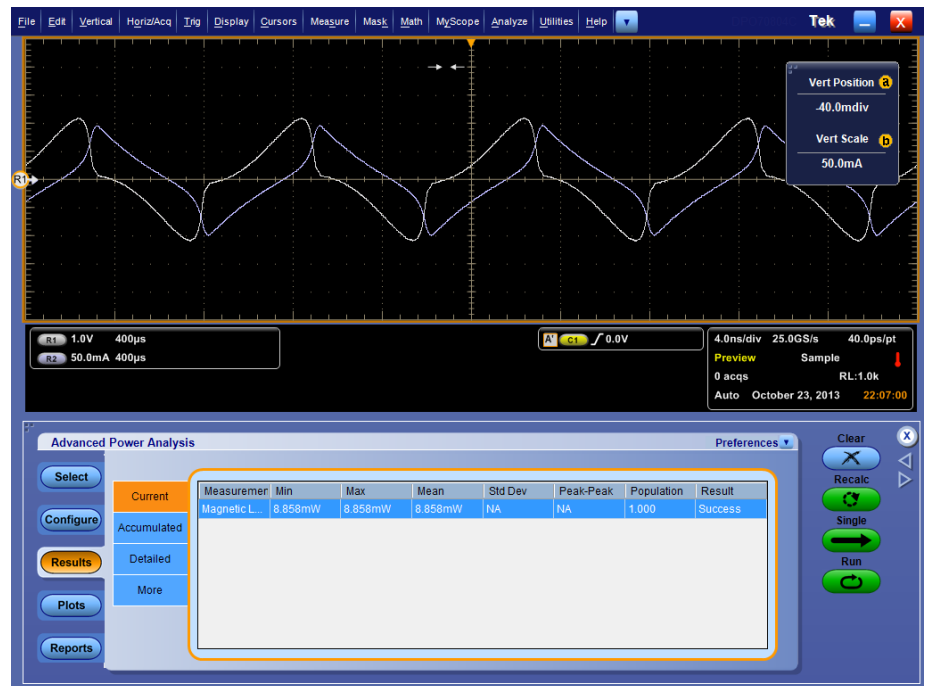

7. The result displays the power loss of the magnetic material.

**Result:** The results of the Switching Loss, Hi-Power Finder and Magnetic Loss help locate the power dissipation, reduce power loss and improve efficiency.





# GPIB commands

## DPOPWR LAUnch

This command allows you to launch advance power analysis application.

**Syntax** DPOPWR LAUnch

## DPOPWR:ADDMeas

This set-only command adds the specified measurement to the bottom of the current Advanced Power Analysis list of measurements and will appear in the results summary page.

### Syntax

DPOPWR:ADDMeas {SWITCHingloss | HIGHPOwerfinder | SOA | RDSon | DVDt | DIDt | SOAXY | PULSEWidth | DUTYCycle | PERIod | FREQuency | SKEw | INDuctance | MAGNeticproperty | MAGNETICLOSS | IV | PQuality | CURRENTHarmonics | TOTALPowerquality | INRUSHCurrent | INPUTCAPacitance | VOLTAGEHarmonics | LINERipple | SWITCHINGRipple | SPECTralanalysis | TURNontime | HIGH | LOW | HIGHLow | CYCLICMin | CYCLICMax | CYCLICPk}

Arguments	UI Name	Description
SWITCHingloss	Switching Loss	It measures the turn-on, turn-off and conduction losses of each cycle of voltage and current signals.
HIGHPOwerfinder	Hi-Power Finder	It measures the power peaks for turn-on and turn-off region, which are positions where maximum power dissipation is happening.
SOA	SOA	It measures Graphically represent the Safe Operating area of power semiconductor devices indicating the maximum operation voltage and current on the acquired waveform for the entire acquired record length.
RDSon	RDS(on)	It measures Dynamic resistance offered by the switching device while is in ON condition.
DVDt	dv/dt	It measures Transient response which represents the change of voltage during switching.
DIDt	di/dt	It measures Current Transient response which represents the rate of change of current during switching.

Arguments	UI Name	Description
SOAXY	SOA X-Y(DPX)	It is Plotting of the Voltage on the X-axis and Current on the Y -axis.
PULSEWidth	Pulse Width	The difference in time (positive or negative) between the leading edge and trailing edge of a pulse.
DUTYCycle	Duty Cycle	Calculate the ratio of the positive (or negative) portion of the cycle relative to the period.
PERIod	Period	Clock Period measurement which calculates the duration of a cycle as defined by a start and a stop edge.
FREQuency	Frequency	Clock Frequency measurement which calculates the inverse of the clock period for each cycle.
SKEw	Skew	To measure the delay between two periodic signals.
INDuctance	Inductance	The value of inductance will give the picture of the Core behavior while it is under operation.
MAGNeticproperty	Magnetic Property	It measures the parameters related to the magnetic material in a magnetic component used in an in-circuit operation.
MAGNETICLOSS	Magnetic Loss	Cycle of the data points of the integral waveform is identified using the cycle in current waveform as reference.
IV	$I \text{ vs } \int V$	It is an XY plot of integral of voltage against current.
PQuality	Power Quality	Power Quality, which provides a single table of measurements and measurement statistics for the AC input section of a power conversion circuit.
CURRENTHarmonics	Current Harmonics	It performs the harmonic calculation in dbA and RMS units based on fundamental harmonic frequency for various standards.
TOTALPowerquality	Total Power Quality	Provides power quality and current harmonics measurements in a single display.
INRUSHCurrent	In Rush Current	To perform Peak Inrush Current measurement and Capacitance value for switching power supply during in-circuit operation.
INPUTCAPacitance	Input Capacitance	Measures the capacitance value using switching voltage and current during turn on of the switching device.
VOLTAGEHarmonics	Voltage Harmonics	It performs the harmonic calculation for the voltage source channel based on fundamental harmonic frequency.
LINERipple	Line Ripple	It measures peak-to-peak ripple voltage present on a DC or low-frequency AC voltage stated for each cycle.

Arguments	UI Name	Description
SWITCHINGRipple	Switching Ripple	It Measures the amount of AC signal related to switching frequency.
SPECTralanalysis	Spectral Analysis	Spectral analysis measures frequency components of the output voltage of a power converter.
TURNonetime	Turn On Time	AC Turn ON time is the time difference between the input voltage applied to the system and the time to develop the output voltage.
HIGH	High	The High Amplitude measurement calculates the mean or mode of a selected portion of each unit interval.
LOW	Low	The Low Amplitude measurement calculates the mean or mode of a selected portion of each unit interval.
HIGHLow	High Low	The High–Low measurement calculates the change in voltage level across a transition in the waveform.
CYCLICMin	Cycle Min	Cycle Min measures negative peak of the waveform for all cycles. It is the minimum voltage for each cycle from the mid level of Fall to the Rise slope.
CYCLICMax	Cycle Max	Cycle Max measures positive peak for all cycles. It is the maximum voltage for each cycle from the mid level of rise to the fall slope.
CYCLICPkPk	Cycle PkPk	Cycle Pk-Pk measures the absolute difference between the maximum and minimum amplitude for every cycle of the waveform.

**Example**

DPOPWR:ADDMeas HIGH to add the High measurement to the measurement table list.

## DPOPWR:CLEARALLMeas

This clear only command allows you to clear all the added measurements.

**Syntax**

DPOPWR:CLEARALLMeas

**Example**

DPOPWR:CLEARALLMeas to clear all the added measurements.

## DPOPWR:CLEARALLPlots

This clear only command allows you to clear all the added plots.

**Syntax**

DPOPWR:CLEARALLPlots

**Example**

DPOPWR:CLEARALLPlots to clear all the added plots.

## DPOPWR:FREerun

This set only command allows you to start the continuous run on the list of measurements.

**Syntax**

DPOPWR:FREerun

**Example**

DPOPWR:FREerun to start the continuous run on the list of measurements.

## DPOPWR:GENREPAS

This command allows you to generate the report and save as specified string.

### Syntax

DPOPWR:GENREPAS <String>

### Arguments

<String> is the file name specified for the report and the argument must be in double quotes. The file name should not exceed 240 characters and cannot contain " , < > , | , # , \* , ? .

### Output

Report in \*.MHTML format is generated.

### Example

DPOPWR:GENREPAS "SwitchingLossPFC" to generate and save the report as SwitchingLossPFC.MHTML.

## DPOPWR:GENREPort

This command allows you to generate and open the report for the run or completed measurement list.

### Syntax

DPOPWR:GENREPort

### Example

DPOPWR:GENREPort to generate and open the report of completed measurement list.

## DPOPWR:LASTError?

This query only command returns last occurred error.

### **Syntax**

DPOPWR:LASTError?

### **Output**

Returns the error code and description of last occurred error.

### **Example**

DPOPWR:LASTError? to query the last error occurred.

## DPOPWR:MEAS(x):ACCMAx?

This command allows you to query the accumulated maximum value for the measurement.

### **Syntax**

DPOPWR:MEAS<x>:ACCMAx?

### **Arguments**

<x> defines the measurement row number. The value ranges from 1 to 10.

### **Output**

Returns the maximum value of accumulated result for the measurement.

### **Example**

DPOPWR:MEAS2:ACCMAx? to query the maximum value of accumulated result for the second measurement of the added list.

## DPOPWR:MEAS(x):ACCMEAn?

This command allows you to query the accumulated mean value for the measurement.

### Syntax

DPOPWR:MEAS<x>:ACCMEAn?

### Arguments

<x> defines the measurement row number. The value ranges from 1 to 10.

### Output

Returns the mean value of accumulated result for the measurement.

### Example

DPOPWR:MEAS2:ACCMEAn? to query the mean value of accumulated result for the second measurement of the added list.

## DPOPWR:MEAS(x):ACCMIn?

This command allows you to query the accumulated minimum value for the measurement..

### Syntax

DPOPWR:MEAS<x>:ACCMIn?

### Arguments

<x> defines the measurement row number. The value ranges from 1 to 10.

### Output

Returns the minimum value of accumulated result for the measurement.

### Example

DPOPWR:MEAS2:ACCMIn? to query the minimum value of accumulated result for the second measurement of the added list.

## DPOPWR:MEAS(x):ACCPKTopk?

This command allows you to query the accumulated peak to peak value for the measurement.

### Syntax

DPOPWR:MEAS<x>:ACCPKTopk?

### Arguments

<x> defines the measurement row number. The value ranges from 1 to 10.

### Output

Returns the peak-to-peak value of accumulated result for the measurement.

### Example

DPOPWR:MEAS2:ACCPKTopk? to query the peak-to-peak value of accumulated result for the second measurement of the added list.

## DPOPWR:MEAS(x):ACCPOPulation?

This command allows you to query the accumulated population value for the measurement.

### Syntax

DPOPWR:MEAS<x>:ACCPOPulation?

### Arguments

<x> defines the measurement row number. The value ranges from 1 to 10.

### Output

Returns the population value of accumulated result for the measurement.

### Example

DPOPWR:MEAS2:ACCPOPulation? to query population value of accumulated result for the second measurement of the added list.



## DPOPWR:MEAS(x):ACCRResult?

This command allows you to query the accumulated status value for the measurement.

### Syntax

DPOPWR:MEAS<x>:ACCRResult?

### Arguments

<x> defines the measurement row number. The value ranges from 1 to 10.

### Output

Success or Fail

### Example

DPOPWR:MEAS2:ACCRResult? to query status of accumulated result for the second measurement of the added list.

## DPOPWR:MEAS(x):ACCSTDdev?

This command allows you to query the accumulated standard deviation value for the measurement.

### Syntax

DPOPWR:MEAS<x>:ACCSTDdev?

### Arguments

<x> defines the measurement row number. The value ranges from 1 to 10.

### Output

Returns the standard deviation value of accumulated result for the measurement.

### Example

DPOPWR:MEAS2:ACCSTDdev? to query standard deviation value of accumulated result for the second measurement of the added list.

## DPOPWR:MEAS(x):ACQmode

This command allows you to query or set the acquisition mode as Sample, Hi Res or Average.

### Syntax

DPOPWR:MEAS<x>:ACQmode?

DPOPWR:MEAS<x>:ACQmode {SAMple | HIRes | AVErage}

### Arguments

<x> defines the measurement row number. The value ranges from 1 to 10.

SAMple: Set the acquisition mode as Sample.

HIRes: Set the acquisition mode as Hi-Res.

AVErage: Set the acquisition mode as Average.

### Output

Returns the configured acquisition mode for the measurement.

### Example

DPOPWR:MEAS2:ACQmode HIRes to set the acquisition mode as Hi Res for all added measurement..

DPOPWR:MEAS3:ACQmode? to query the configured acquisition mode for all added measurement..

## DPOPWR:MEAS(x):ADDPLOT

This set only command allows you to add plots for the measurements.

### Syntax

DPOPWR:MEAS<x>:ADDPLOT {SWITCHINGLOSS | TIMEtrend | RISEedge | FALLEdge | HISTogram | POWERTIMEtrend | ENERgytimetrend | BARgraph | SPECTrum | INDUctanceplot | BHPlot | IVPlot}

Arguments	UI Name	Description
SWITCHINGLOSS	Switching On OFF Trajectory	It is a trajectory plot of switching voltage versus current waveform for all ON and OFF cycles in the acquisition.
TIMEtrend	Time Trend	It is waveform trace of a measurement versus time. Each measurement value is placed precisely at the time at which the measurement took place.
RISEedge	Rise Edge(s)-Time Trend	It is a time trend plot of rise edge for di/dt and dv/dt measurements.
FALLEdge	Fall Edge(s)-Time Trend	It is a time trend plot of fall edge for di/dt and dv/dt measurements.

Arguments	UI Name	Description
HISTogram	Histogram	It displays the results such that the horizontal axis represents the measurement values and the vertical axis represents the number of times that each value occurred.
POWERTIMEtrend	V*I Power Waveform	It is power (V*I) waveform plot versus time.
ENERgytimetrend	$\int (V * I)$ Energy Waveform	Energy waveform plot is Integral of V * I.
BARgraph	Harmonics Bar Graph	It has x-axis a harmonic number and y-axis is harmonic value in dB or RMS.
SPECTrum	Spectrum	It is a plot in frequency domain, which Y-axis presents the magnitude in dB/RMS of frequency component on X-axis.
INDUctanceplot	Inductance curve	The property of an electric circuit as a result of which an electromotive force is created by a change of current in the same circuit (self-inductance) or in a neighbouring circuit (mutual-inductance). It is measured in henries and plot with respect to time.
BHPlot	BH Curve	The BH Plot of a magnetic material represents the relationship between its magnetic flux density B on y-axis as a function of the magnetic field intensity H on x-axis.
IVPlot	$I \text{ Vs } \int V$	

### Example

DPOWWR:MEAS2:ADDPLOT SWITCHINGLOSS to add Switching Loss plot for the second measurement of the added list.

---

**NOTE.** Adding plots will be successful only if the measurement supports the particular plot. For information about correlation of measurements to plots [Click here](#)

---

## DPOPWR:MEAS(x):AUTOZero

This set only command removes the DC offset, when the probe has no input signals.

### Syntax

DPOPWR:MEAS<x>:AUTOZero

### Inputs

<x> defines the measurement row number. The value ranges from 1 to 10.

### Example

DPOPWR:MEAS2:AUTOZero set only command removes the DC offset for second measurement of the added list.

## DPOPWR:MEAS(x):BWLimit

This command allows you to query or set the bandwidth to 20 MHz, 250 MHz or Full.

### Syntax

DPOPWR:MEAS<x>:BWLimit?

DPOPWR:MEAS<x>:BWLimit BWL20MHz

DPOPWR:MEAS<x>:BWLimit BWL250MHz

DPOPWR:MEAS<x>:BWLimit Full

### Inputs

<x> defines the measurement row number. The value ranges from 1 to 10.

BWL20MHz: To set the bandwidth limit to 20MHz

BWL250MHz: To set the bandwidth limit to 250 MHz

Full: To set the bandwidth limit to maximum value supported by scope.

### Output

Returns the configured bandwidth limit value for the measurement.

### Example

DPOPWR:MEAS2:BWLimit BWL20MHz to set the bandwidth limit to 20 MHz for all added measurement..

DPOPWR:MEAS3:BWLimit? to query the configured bandwidth limit value for all added measurement..

## DPOPWR:MEAS(x):COUPling

This command allows you to query or set the coupling to AC or DC.

### Syntax

DPOPWR:MEAS<x>:COUPling?

DPOPWR:MEAS<x>:COUPling {AC | DC}

### Arguments

<x> defines the measurement row number. The value ranges from 1 to 10.

AC | DC to set the signal coupling type as AC or DC

### Outputs

Returns the signal coupling type for the measurement.

### Example

DPOPWR:MEAS2:COUPling DC to set the signal coupling type as DC for all added measurement..

DPOPWR:MEAS3:COUPling? to query the signal coupling type for all added measurement.

## DPOPWR:MEAS(x):CURGATing

This command allows you to query or set the cursor gating to On or Off.

### Syntax

DPOPWR:MEAS<x>:CURGATing?

DPOPWR:MEAS<x>:CURGATing {ON | OFF}

### Arguments

<x> defines the measurement row number. The value ranges from 1 to 10.

ON | OFF to set the cursor gating On or Off

### Outputs

Returns the status of the cursor gating for the measurement.

### Example

DPOPWR:MEAS2:CURGATing ON to set the cursor gating as On for all added measurement..

DPOPWR:MEAS3:CURGATing? to query the cursor gating status for all added measurement..

## DPOPWR:MEAS(x):CURRENTMAX?

This command allows you to query the current maximum value for the measurement.

### Syntax

DPOPWR:MEAS<x>:CURRENTMAX?

### Arguments

<x> defines the measurement row number. The value ranges from 1 to 10.

### Output

Returns the maximum value of current result for the measurement.

### Example

DPOPWR:MEAS2:CURRENTMAX? to query maximum value of current result for the second measurement of the added list.

## DPOPWR:MEAS(x):CURRENTMEAN?

This command allows you to query the current mean value for the measurement.

### Syntax

DPOPWR:MEAS<x>:CURRENTMEAN?

### Arguments

<x> defines the measurement row number. The value ranges from 1 to 10.

### Output

Returns the mean value of current result for the measurement.

### Example

DPOPWR:MEAS2:CURRENTMEAN? to query mean value of current result for the second measurement of the added list.

## DPOPWR:MEAS(x):CURRENTMin?

This command allows you to query the current minimum value for the measurement.

### Syntax

DPOPWR:MEAS<x>:CURRENTMin?

### Arguments

<x> defines the measurement row number. The value ranges from 1 to 10.

### Output

Returns the minimum value of current result for the measurement.

### Example

DPOPWR:MEAS2:CURRENTMin? to query minimum value of current result for the second measurement of the added list.

## DPOPWR:MEAS(x):CURRENTPKTopk?

This command allows you to query the current peak to peak value for the measurement.

### Syntax

DPOPWR:MEAS<x>:CURRENTPKTopk?

### Arguments

<x> defines the measurement row number. The value ranges from 1 to 10.

### Output

Returns the peak-to-peak value of current result for the measurement.

### Example

DPOPWR:MEAS2:CURRENTPKTopk? to query peak-to-peak value of current result for the second measurement of the added list.

## DPOPWR:MEAS(x):CURRENTPOPulation?

This command allows you to query the current population value for the measurement.

### Syntax

DPOPWR:MEAS<x>:CURRENTPOPulation?

### Arguments

<x> defines the measurement row number. The value ranges from 1 to 10.

### Output

Returns the population value of current result for the measurement.

### Example

DPOPWR:MEAS2:CURRENTPOPulation? to query population value of current result for the second measurement of the added list.

## DPOPWR:MEAS(x):CURRENTResult?

This command allows you to query the current status value for the measurement.

### Syntax

DPOPWR:MEAS<x>:CURRENTResult?

### Arguments

<x> defines the measurement row number. The value ranges from 1 to 10.

### Output

Success or Fail

### Example

DPOPWR:MEAS2:CURRENTResult? to query the status of current result for the second measurement of the added list.



## DPOPWR:MEAS(x):CURRENTSTDdev?

This command allows you to query the current standard deviation value for the measurement.

### Syntax

DPOPWR:MEAS<x>:CURRENTSTDdev?

### Arguments

<x> defines the measurement row number. The value ranges from 1 to 10.

### Output

Returns the standard deviation value of current result for the measurement.

### Example

DPOPWR:MEAS2:CURRENTSTDdev? to query standard deviation value of current result for the second measurement of the added list.

## DPOPWR:MEAS(x):CUSTomname?

This command allows you to query the measurement instants name in the table. This command is useful when multiple instants of same measurements are added.

### Syntax

DPOPWR:MEAS<x>:CUSTomname?

### Arguments

<x> defines the measurement row number. The value ranges from 1 to 10.

### Output

Measurement instants name and number

### Example

DPOPWR:MEAS2:CUSTomname? to query the measurement instance of the second measurement in the list. For e.g. If second measurement in the list is Switching Loss1 then output will be Switching Loss1

## DPOPWR:MEAS(x):DEGauss

This set only command performs Degauss on current probe.

### Syntax

DPOPWR:MEAS<x>:DEGauss

### Inputs

<x> defines the measurement row number. The value ranges from 1 to 10.

### Example

DPOPWR:MEAS2:DEGauss set only command performs degauss on current probe for second measurement of the added list.

## DPOPWR:MEAS(x):GATESOURce

This command allows you to query or set the source of the selected measurement..

### Syntax

DPOPWR:MEAS<x>:GATESOURce?

DPOPWR:MEAS<x>:GATESOURce <source>

### Arguments

<x> defines the measurement row number. The value ranges from 1 to 10.

<source> = CH1, CH2, CH3, CH4, MATH1, MATH2, MATH3, MATH4, REF1, REF2, REF3, REF4.

### Outputs

Returns the gate source channel for the measurement.

### Example

DPOPWR:MEAS3:GATESOURce CH1 to set the gate source channel as CH1 for the third measurement of the added list.

DPOPWR:MEAS2:GATESOURce? to query the gate source channel for the second measurement of the added list.

## DPOPWR:MEAS(x):ISOURce

This command allows you to query or set the current source of the selected measurement..

### Syntax

DPOPWR:MEAS<x>:ISOURce?

DPOPWR:MEAS<x>:ISOURce <source>

### Input

<x> defines the measurement row number. The value ranges from 1 to 10.

<source> = CH1, CH2, CH3, CH4, MATH1, MATH2, MATH3, MATH4, REF1, REF2, REF3, REF4.

### Output

Returns the current source channel for the measurement.

### Example

DPOPWR:MEAS3:ISOURce CH1 to set the current source channel as CH1 for the third measurement of the added list.

DPOPWR:MEAS2:ISOURce? to query the current source channel for second measurement of the added list.

## DPOPWR:MEAS(x):NAME?

This command allows you to query the measurement name of the added list.

### Syntax

DPOPWR:MEAS<x>:NAME?

### Arguments

<x> defines the measurement row number. The value ranges from 1 to 10.

### Output

Measurement name

### Example

DPOPWR:MEAS3:NAME? to query the measurement name of the third measurement from the added list. For e.g. If third measurement in the list is Switching Loss1 then output will be Switching Loss

## DPOPWR:MEAS(x):SElectmeas

This command allows you to select the instant from the list of added measurement.

### Syntax

DPOPWR:MEAS<x>:SElectmeas

### Arguments

<x> defines the measurement row number. The value ranges from 1 to 10.

### Example

DPOPWR:MEAS1:SElectmeas to select the first measurement of the added measurement list.

## DPOPWR:MEAS(x):SOURCEAPPLYAll

This set only command allows you to apply the source configuration of measurement <x> to all the measurements in the added list.

### Syntax

DPOPWR:MEAS<x>:SOURCEAPPLYAll

### Inputs

<x> defines the measurement row number. The value ranges from 1 to 10.

### Example

DPOPWR:MEAS1:SOURCEAPPLYAll to apply the source configuration of measurement 1 to all the measurements in the added list.

## DPOPWR:MEAS(x):SOURCEAutoset

This command allows you to query or set the source autoset for the measurements.

### Syntax

DPOPWR:MEAS<x>:SOURCEAutoset?

DPOPWR:MEAS<x>:SOURCEAutoset {VERTical | HORizontal | Both | UNDO}

### Input

<x> defines the measurement row number. The value ranges from 1 to 10.

VERTical: To set the source autoset as vertical

HORizontal: To set the source autoset as horizontal

Both: To set the source autoset to both vertical and horizontal

UNDO: To remove the source autoset configuration.

### Output

Returns the source autoset for the measurement.

### Example

DPOPWR:MEAS2:SOURCEAutoset VERTical to set the source autoset as vertical for the second measurement of the added list.

DPOPWR:MEAS3:SOURCEAutoset? to query the source autoset for the third measurement of the added list.

---

**NOTE.** Source autoset will set the scale of the scope, which satisfy all the added measurement list.

---

## DPOPWR:MEAS(x):VSOURce

This command allows you to query or set the voltage source channel for the measurement.

### Syntax

DPOPWR:MEAS<x>:VSOURce?

DPOPWR:MEAS<x>:VSOURce <source>

### Arguments

<x> defines the measurement row number. The value ranges from 1 to 10.

<source> = CH1, CH2, CH3, CH4, MATH1, MATH2, MATH3, MATH4, REF1, REF2, REF3, REF4.

### Outputs

Returns the voltage source channel for the measurement.

### Example

DPOPWR:MEAS3:VSOURce CH1 to set the voltage source channel as CH1 for the third measurement of the added list.

DPOPWR:MEAS2:VSOURce? to query the voltage source channel for second measurement of the added list.

## DPOPWR:OPC?

This command allows you to query whether last performed operation is completed or not.

**Syntax**    DPOPWR:OPC?

**Output**    Returns 1 if the last performed operation is completed else 0.

**Example** DPOPWR:OPC? to query whether last performed operation is completed or not.

## DPOPWR:RECalc

This command recalculates the selected measurements on the current acquisition.

### **Syntax**

DPOPWR:RECalc

### **Example**

DPOPWR:RECalc to recalculate results the list of measurements for the acquired waveform.

## DPOPWR:SELECTEDMeas?

This query command displays the selected measurement information.

### **Syntax**

DPOPWR:SELECTEDMeas?

### **Output**

Returns the selected measurement name.

### **Example**

DPOPWR:SELECTEDMeas? to query the selected measurement name.

## DPOPWR:SINgle

This command allows you to perform single run for the list of added measurements.

### **Syntax**

DPOPWR:SINgle

### **Example**

DPOPWR:SINgle to perform single run for the list of measurements.

## DPOPWR:Stop

This set only command allows you to stop the continuous run on the list of measurements.

### **Syntax**

DPOPWR:Stop

### **Example**

DPOPWR:Stop to stop the continuous run on the list of measurements.

## DPOPWR:VERsion?

This command allows you to query version number of the installed advance power analysis application.

**Syntax** DPOPWR:VERsion?

**Output** Returns version number of installed advance power analysis application.



# Reference

## Error codes for DPOPWR

Error Codes	Error Message	Description	Possible Solutions
800	Selected point is not valid.	Error cause from unit testing.	Error solution from unit testing.
1000	To avoid potential shock while using " + DPOPowerConstants.ApplicationLongName + " application, use only appropriately rated voltage and current probes, accessories and other equipment. Refer to manufacturer's documentation for each product.	Check the probes are in working condition.	Check the probes are in working condition
1001	The maximum number of MATH dependent measurements has been reached.	All math channels have been consumed either to display or input the measurements.	Remove at least one math dependent measurement to run any other.
1002	Mismatch in measurements group detected. Press Yes to clear the list and add the new measurement. Press No to return without any modification.	Some measurements like SOA X-Y (DPX), Turn On Time, and similar measurements, cannot be run with other measurements as they need their own autose.	To run other measurements, remove these measurements from the list. Clicking Yes will clear the list and add the new measurement. Clicking No will retain the old one.
1003	Conflict in selection of Math Input and Destination in <Measurement Name>.	In measurements which have Math as both input and output, there should not be a conflict in the Math channels selected.	Change either one of Math input/output destinations to continue with the measurement.
1004	Empty waveform.	The waveform acquired has no samples.	Connect a valid signal to the channels selected, and the device should be turned On.

Error Codes	Error Message	Description	Possible Solutions
1005	Conflict in selection of output sources.	In Turn On Time measurement, 3 output sources can be selected. If any two of them are the same, this error is displayed.	Select different channels for all 3 outputs in Turn On Time.
1006	Conflict in selection of input and output sources.	In Turn On Time measurement, 1 input and a maximum 3 output sources can be selected. If the input source channel matches any of the output source channels, this error is displayed.	Select a different input channel from any of the output channels selected.
1007	Cannot select Live and Ref sources together in <Measurement Name>.	In Source OCW, for any particular measurement, Ref and Live sources cannot be selected as input. The measurement with the conflict is mentioned at the end of the error message.	Select either Ref or Live for both channels.
1008	Conflict in selection of sources in <Measurement Name>.	This error is generated if there is a conflict in any measurement where sources can be configured from the configuration panel, like Magnetic Property secondary Windings.	Select different channels as primary sources and secondary sources in Magnetic Property.
1009	Cannot select Ref as Input source and Live as Output source.	In Turn On Time measurement, input source has been selected as Ref and output source(s) as Live.	Select either both input and output as Ref or both as Live.
1010	Please disconnect probes on <Channel(s) Name> and click Ok to continue.	Pre Degauss message, shown to halt execution until probes are disconnected and Ok is clicked.	Disconnect the probes and click ok to continue with the Degauss procedure.
1011	DeGauss Done, reconnect the probes.	DeGauss Done	Reconnect the probes

Error Codes	Error Message	Description	Possible Solutions
1012	Positive and/or negative clipping detected. Please check the device and run again.	The waveform has positive or negative clipping and the measurement should not be run.	Make sure that the vertical scale is set properly and the device is working properly.
1013	Conflict in selection of Math destinations in <Measurement Name>.	In Switching Loss and High Power Finder, when run on different channels, same Math destination is configured for output.	Change the output Math destination in either one of the measurements selected.
1014	Set cursors to required position. Press Yes to continue. Press No to Stop processing.	Cursors need to be set before measurement continues.	Set cursors to required position. Press Yes to continue. Press No to Stop processing.
1015	Degauss hasn't been done. Please Degauss before autose.	Autoset is being performed without degaussing the current probe(s) connected. This will stop the autoset process.	Degauss the current probes first, before clicking any of the autoset methods.
1016	Degauss Failed.	Either the Jaw of the current probe(s) is open or it is still connected to the probing point with power.	Close the jaw properly and/or disconnect the current probe from the probing point.
1017	SOA is a plot dependent measurement and the maximum number of plots has been reached. Please clear a measurement or a plot and then add the SOA measurement for analysis.	A maximum of 4 plots can be added in the plots list, and SOA is a plot dependent measurement, so maximum of 4 instances of SOA can be run at once.	Remove at least one SOA measurement from the active list to run any other measurement with a plot.
1018	Unable to acquire the waveform. Run the measurement again.	Unable to trigger and acquire the waveform.	Set the trigger level properly, connect a valid signal to the probes, and run the measurement again.

Error Codes	Error Message	Description	Possible Solutions
1019	Magnetic Property cannot be analyzed with other measurements with More windings configuration.	With More windings configuration, only 1 instance of Magnetic Property can be run. Also, it cannot be grouped with other measurements in this case.	Run Magnetic Property with More windings configuration alone or change it to Two/Single winding to run it with other measurements.
1020	The maximum number of Current Harmonics or Total Power Quality measurements has been reached.	Only one instance at a time is allowed for current harmonics and power quality measurements.	Select only one instance at a time for current harmonics and total power quality.
1021	Unable to Degauss probe on <ChannelName>.	Degauss is taking too long, possibly the probe is faulty.	Check the probe and replace with a working probe if faulty.
1022	No Data available to plot in <MeasurementName>. Check the waveform(s) and configurations and then re-run the measurement.	The acquisition and/or measurement may have failed.	Acquire again and Rerun the measurement with appropriate configurations.
1023	No ON cycle data available to plotting. Check the waveform(s) and then re-run the measurement.	ON cycle(s) are not found in the selected area of the waveform (happens if the cursor gating is on and a narrow region of the waveform is selected) or this happens when coupling is set to AC in application Global parameter.	Adjust the scale to have at least one ON cycle and rerun the measurement or check coupling in application Global parameter, make sure appropriate coupling is set otherwise both Voltage and Current can go negative when DC rejection happens. Set the coupling to DC coupling and perform autose.
1024	No OFF cycle data available to plotting. Check the waveform(s) and then re-run the measurement.	OFF cycle(s) are not found in the selected area of the waveform (happens if the cursor gating is on and a narrow region of the waveform is selected).	Adjust the scale to have at least one OFF cycle and rerun the measurement.

## Error codes for DPOPWR cont.

Error Codes	Error Message	Description	Possible Solutions
1700	Unable to perform computation on the waveform data. Source waveforms have different time/div settings.	The voltage and current waveforms have different time/div settings.	Try to run the selected measurement with the voltage and current waveforms acquired simultaneously.
1701	Unable to perform computation on the waveform data. Source waveforms have different record lengths.	The voltage and current waveforms have different record lengths.	Try to run the selected measurement with the voltage and current waveforms acquired simultaneously with the same record length.
1702	Higher sample rate is required for accurate measurement.	The time/div settings for the selected waveform is too high. Alternatively, sampling rate is too low.	On the oscilloscope menu bar, click Horiz / Acq > Horizontal/ Acquisition Setup. In the Horizontal tab, decrease the time base or increase the record length value.
1703	Ensure that at least one complete cycle is available for analysis.	The signal has less than one cycle in the specified record length.	Decrease the time/div settings of the oscilloscope to have more cycles.
1704	Ensure that the cycle has more than 20 sample points.	Make sure that the cycle has more than 20 sample points.	Increase the record length value and/or decrease the time/div settings of the oscilloscope.
1705	Unable to get the frequency value when queried from the oscilloscope.	Unable to measure Frequency due to the non availability of a complete cycle.	Run the measurement again.
1706	Insufficient edges for the Modulation Analysis measurement.	Insufficient edges found on the source waveform. At least two edges are required to run the measurement.	<ol style="list-style-type: none"> <li>1) Decrease the horizontal scale to get complete cycles of the waveform.</li> <li>2) Select the source that has a signal cyclic in nature.</li> <li>3) Adjust the Ref and Hysteresis Levels of the signal to find the edge at the required level.</li> </ol>

Error Codes	Error Message	Description	Possible Solutions
1707	The Ref Level value is outside the voltage range of the waveform. Enter a proper Ref Level value.	Unable to locate the edges on the waveform at the transition because the voltage level does not fall in the transition of the waveform.	Enter the Ref Level value where the transition occurs on the waveform. Enter 50 percent of the level of the peak-to-peak transition level.
1708	Unable to plot SOA because of insufficient data points.	There are insufficient data points to plot.	Place the cursors on the waveform where at least two data points are present between the cursors.
1709	Change the time/div setting to 10 ms/div.	The current harmonics algorithm (IEC standard) requires the horizontal scale to be 10 ms.	Change the horizontal scale to 10 ms using the knobs on the oscilloscope front panel.
1710	Incorrect record length.	The current harmonics algorithm (IEC Standard) requires the record length value of the waveform to be 2500.	The record length availability for the set time base depends upon the number of active channels. Turn off the channels which are not required for the measurement. On the oscilloscope menu bar, click Horiz /Acq > Horizontal/Acquisition Setup. In the Horizontal tab, change the record length value to 2500.
1711	Calculated true power is negative.	This happens if: 1) The direction of current and voltage polarity is reversed. 2) The current has phase shift more than voltage by 90 degrees. 3) The frequency of the signal is not equal to the selected input frequency for the harmonic measurement.	Make sure that the direction of current and voltage polarity is right. Make sure that the frequency of the signal is equal to the selected frequency.
1712	Class D detected; Harmonic limits will be set to Class D.	Equipment Class A was selected; Class D is detected.	Configure Class D and run the measurement again.
1713	Class A detected; Harmonic limits will be set to Class A.	Equipment Class D was selected; Class D is not detected.	Configure Class A and run the measurement again.

Error Codes	Error Message	Description	Possible Solutions
1714	Set the horizontal scale to 200 ms and the record length value to 1 M.	The current harmonics algorithm (MIL standard) requires the horizontal scale to be 200 ms and the record length value to be 1 M.	1) Unable to set the required length and time base combination because the record length availability for the set time base depends upon the number of active channels. 2) Turn off the channels which are not required for the measurement. 3) Change the horizontal scale to 200 ms and the record length value to 1 M.
1715	Set the horizontal scale to 400 ms and the record length value to 2 M.	The current harmonics algorithm (MIL standard) requires the horizontal scale to be 400 ms and the record length value to be 2 M.	1) Unable to set the required length and time base combination because the record length availability for the set time base depends upon the number of active channels. 2) Turn off the channels which are not required for the measurement. 3) Change the horizontal scale to 400 ms using the oscilloscope front panel. Set the record length value to 2 M.
1716	Set the horizontal scale to 200 ms and the record length value to 125000.	The current harmonics algorithm (MIL standard) requires the horizontal scale to be 200 ms and the record length value to be 125000.	Change the horizontal scale to 200 ms and the record length value to 125000.
1717	Set the horizontal scale to 400 ms and the record length value to 1 M.	The current harmonics algorithm (IEC A14 standard) requires the horizontal scale to be 400 ms and the record length value to be 1 M.	Change the horizontal scale to 400 ms and the record length value to 1 M.

Error Codes	Error Message	Description	Possible Solutions
1718	Set the horizontal scale to 400 ms and the record length value to 125000.	The current harmonics algorithm (MIL standard) requires the horizontal scale to be 400 ms and the record length value to be 125000.	Change the horizontal scale to 400 ms and the record length value to 125000.
1719	Unable to calculate harmonics for the record length and sampling rate combination.	Current harmonics could not be run for the record length and sample rate combination.	Change the horizontal scale and the record length value.
1720	Calculated power is more than 25 W. Set the value greater than 25 W and enter the power factor and input current.	IEC Amendment 14 requires that the power factor and input current are entered by the user for Class C equipment when the power is more than 25 W.	Enter power greater than 25 W and enter the current and power factor values.
1721	Not enough samples available for analysis.	The slope calculation requires at least three samples.	On the oscilloscope menu bar, click Horiz / Acq > Horizontal/ Acquisition Setup. In the Horizontal tab, increase the record length value.
1722	Low level cannot be greater than high level.	The dv /dt low level cannot be greater than high level.	Enter levels such that low is lesser than high.
1723	Levels entered are not within the range of the waveform.	Unable to locate the edges on the waveform at the transition because the voltage level does not fall in the transition of the waveform.	Enter the Ref Level voltage where the transition occurs on the waveform. Enter the 50 percent of the level of the peak-to-peak transition level.
1724	Oscilloscope settings changed. Run the measurements di/dt and dv/dt again.	If you change any of the vertical or horizontal settings, then the oscilloscope goes into preview mode after running di/dt and dv /dt for edge analysis.	Do not change the settings after the results are obtained for di/dt and dv /dt.
1725	Unable to perform di/dt for the configured levels.	The configured levels are not found on the edge. The cursors are placed for maximum di/dt.	Reconfigure the levels. Run the measurement again.



Error Codes	Error Message	Description	Possible Solutions
1726	Unable to associate cursor to the selected data.	Unable to associate the cursor to the identified data of the power.	The oscilloscope settings have been altered. Run the measurement again.
1727	Unable to calculate $dv/dt$ for the configured levels.	Configured levels not found on the edge.	Reconfigure the levels.
1728	Set the coupling to 1 M Ohm.	Selected channel input coupling is set to 50 Ohm.	Use TCS-1M convertor to run the measurement with DC block enabled. Then, run the measurement with DC block disabled. Change the coupling to 1 M on the oscilloscope.
1729	Start frequency cannot be more than or equal to stop frequency.	The entered value of start frequency is higher than stop frequency.	The entered value of start frequency is higher than stop frequency.
1730	The frequency resolution (sample rate/record length) is more than the stop frequency.	The frequency resolution of the signal for the record length and sampling rate combination is more than the stop frequency component.	Increase the record length value or decrease the sampling rate such that the stop frequency is more than the frequency resolution (frequency resolution = sampling rate/record length) and run the measurement again.
1731	Configured sample rate is less than twice the stop frequency.	Sampling rate should be more than or equal to twice the stop frequency for accurate analysis to prevent aliasing.	Increase the sampling rate such that sampling rate is more than or equal to twice the stop frequency.
1732	Frequency resolution (sample rate/record length) is larger than the range of frequency.	The frequency resolution of the signal for the record length and sampling rate combination is more than the range of frequencies to be analyzed.	Decrease the stop frequency value to run or use the autosest option for automatic record length and time base settings.
1733	1 M Coupling required; DC block cannot be performed.	50 ohms coupling is required for the DC block operation.	Set coupling to 1 Meg.

Error Codes	Error Message	Description	Possible Solutions
1734	File path not available to save the Spectral Analysis plot.	Path entered for saving the plot is not valid.	Enter a valid path name.
1735	The RBW value was not updated. It will be set to the maximum value.	RBW values are not updated for the selected start, stop frequency, and window type.	Update RBW values after selecting start/stop frequency and window type before you run the measurement.
1736	The oscilloscope settings have changed. Cannot set the selected RBW value.	You might have changed the settings on the oscilloscope after updating the RBW values for the selected start/stop frequency window type.	Update RBW values after selecting start/stop frequency/window. Do not change the oscilloscope settings after updating RBW values.
1737	The configured frequency range is not supported by the spectral analysis measurement.	For the range selected, there are no RBW values available for the spectral analysis measurement.	Increase the start frequency value or decrease the stop frequency value. To run without autose, uncheck Auto Setup in the options pane.
1738	Timing synchronization of the previously acquired waveform is not matching the current acquisition.	Time domain synchronization is essential for the calculation of results even though the waveforms were not acquired simultaneously.	The synchronization is checked for the given trigger level, trigger position, and cursor position for the present waveform with the previously acquired waveform. Do not change these settings, which results in loss of synchronization. Run the Magnetic Property measurement again.
1739	Number of data points in a cycle is less than 10.	The number of data points in the identified cycle is less than 10. Increase hysteresis and Ref Level for the correct identification of edge source.	Use the switching device gate waveform as the edge source if the ringing is more on the voltage waveform across the magnetic component.

Error Codes	Error Message	Description	Possible Solutions
1740	Not enough samples for correct calculation of the DC flux density to position the Hysteresis curve on the plot.	The number of data points available for the calculation of DC value of flux density is insufficient in: 1) Number of data points in identified cycle 2) Lesser number of data points in identified integral number of cycles.	1) If you are using the current source as edge source, then increase the number of divisions of the current waveform. 2) If the current waveform is noisy, use Hires mode to remove noise. 3) Increase hysteresis and adjust the Ref Level for the correct identification of edge and integral number of cycles.
1741	Amplitude of each cycle is improper for computation.	The amplitude of the signal is very low.	Decrease the vertical scale of the voltage and current channels.
1742	The calculated skew value is more than the oscilloscope deskew range.	The skew computed is more than the oscilloscope deskew range. So, the deskew is done to the maximum range value.	The deskew is done to the maximum deskew value applicable to the oscilloscope.
1743	Edges on the waveform are lesser than the number of edges configured. Number of edges set by the user to deskew is not available on the waveform.	Configured value of the number of edges is not found on the waveform.	Make sure that the number of edges in the waveform and the display in the numeric input are same. Adjust the horizontal scale to increase the number of transitions that are required for adjusting the deskew.
1744	Edges on the waveform are more than the required number of edges for internal deskew.	Internal deskew expects only one edge in the waveform for deskew.	The waveform or the setup may be wrong. To make accurate connections, follow the procedure in the section Deskewing Probes and Channels of the online help.
1745	(Hysteresis Level/2 + Ref Level) cannot be more than 100 percent of the maximum signal level.	Level for finding the edge is more than the maximum level of the signal.	Adjust the Ref Level and Hysteresis Level such that it should not exceed the maximum level of the signal in percentage.

Error Codes	Error Message	Description	Possible Solutions
1746	Error in copying the delays.txt file.	File is corrupted to run the static deskew measurement.	Restart the application with the correct deskew file.
1747	Unable to find the required edges. Reacquire waveform.	The waveform may not be able to find the required edges due to the following reasons: 1) Noisy signal 2) Low hysteresis band level 3) Oscilloscope is in the preview mode 4) The same error reflects low record length leading to less number of samples.	If the signal is too noisy, enable Average mode, instead of sample mode, and acquire the signal. This reduces the jitter on the signal and smooths the signal. Increase the hysteresis band level from the application to compensate for noise in the signal.
1748	Number of sample points available for analysis during Ton or Toff is zero.	Due to low record length, the number of samples present during Ton or Toff is zero, which leads to infinity when calculating the switching frequency that is calculated for every switching.	Increase the record length value and run the measurement again. Increase the record length value to have enough samples during each switching.
1749	Number of sample points available for analysis during Ton or Toff should be more than two.	If the number of samples between 10 percent and 90 percent of switching ON or OFF portion of the voltage waveform is less than two, then the application displays a warning message.	Increase the record length value to have enough samples during each switching.
1750	All three outputs are OFF. Ensure that at least one output is ON.	Before you run the measurement, set the state of the used output to the ON state.	Make sure that at least one output is set to ON.
1751	The trigger voltage cannot be set to more than the maximum line voltage.	The trigger voltage should be less than the maximum line voltage.	Set the trigger voltage level lower than the maximum line voltage level.

Error Codes	Error Message	Description	Possible Solutions
1752	Calculated power loss value is zero. One complete switching ON to ON cycle may not be available or the conduction portion of the power signal may be negative. Reacquire with at least two complete cycles.	Power loss minimum or maximum and average value can become zero under the following conditions: 1) When coupling used is AC, then signal can vary from negative to positive and power loss calculated can become zero. 2) AC-coupled current and voltage signals are multiplied to get power-signal. To calculate the power loss, integration of the power signal is done, which varies from negative to positive where the probability of calculating a zero value is possible. 3) When the probe has DC offset.	Make sure that the coupling used is DC. DC offset on the probes used should be compensated before you run the measurement again.
1753	RDS ON or Vce(Sat) is not Configured. The calculated energy and loss may not be accurate.	This warning message appears if the vertical scale of the switch voltage is more than 10 V per division and device parameter RDS On or Vce(SAT) is not selected.	Select device type MOSFET or IGBT/BJT and enter the respective parameter.
1754	Total loss and total energy not calculated.	Total loss and total energy not calculated.	Error.
1755	Multiple edges found in a switching cycle, or DC offset present in the waveform.	This error appears in two scenarios: 1) When multiple edges are found within a switching cycle. This is because of improper ref and hysteresis levels. 2) If voltage and current probes are not properly compensated for DC offset, then the configured Ton and Toff levels are not met.	Set the ref hysteresis level for the voltage edge source. Remove the DC offset in the probes and run the measurement again.

Error Codes	Error Message	Description	Possible Solutions
1756	The calculated edge at (Ref Level $\pm$ Hysteresis/2) is less than the Ton and Toff voltage level.	The error appears when the configured Ton and Toff levels are less than the edge (Ref Level + Hysteresis /2).	Set the ref and hysteresis level/2 more than the Ton and Toff level on the voltage waveform and run the measurement again.
1757	The calculated edge at (Ref Level $\pm$ Hysteresis/2) is less than Ton and Toff current level.	The error appears when the configured Ton and Toff levels are less than the edge (Ref Level + Hysteresis /2).	Set the ref and hysteresis level/2 more than the Ton and Toff level for the current waveform and run the measurement again.
1758	The calculated edge at (Ref Level $\pm$ Hysteresis/2) is more than 80 percent of the gate voltage.	The error appears when the configured edge (Ref Level + Hysteresis/2) is more than 80 percent of the gate voltage.	Set the ref and hysteresis level/2 less than 80 percent of the gate voltage and run the measurement again.
1759	(Ref Level $\pm$ Hysteresis/2) is more than 100 percent.	The error appears when the edge Ref Level + Hysteresis/2) is more than 100 percent.	Set the ref and hysteresis level/2 less than 100 percent and run the measurement again.
1760	Failed to process the waveform.	When the oscilloscope is unable to return the maximum and minimum levels, this error appears.	Run the measurement again.
1761	Switching loss and energies in the result can be zero.	The probable reason is that there can be a sharp spike in the switch current during turn ON. The amplitude of the spike is more than the remaining portion of the switch current cycle. This affects the configured I-level (percent) and is converted to absolute as product of the maximum spike current and percentage level.	Check the I and V levels and run the measurement again.

Error Codes	Error Message	Description	Possible Solutions
1762	The calculated switching loss and energy is zero.	There may be a sharp spike in the switch current during turn ON or the amplitude of the spike may be more than the remaining portion of the switch current cycle.	Check the I and V levels and run the measurement again. The spike can be because of the parasitic effect of the associated components and extended current loop. Use a small loop to measure current and a small lead to measure the voltage.
1763	The number of samples between the cursors is less than two.	This is caused by improper placing of cursors such that there are no sample points between the cursors.	Reposition the cursors and run the measurement again.
1764	The calculated total loss and energy is less than the sum of Ton loss and energy and Toff loss and energy.	The calculated total loss and energy is less than the sum of Ton loss and energy and Toff loss and energy.	Error.
1765	The number of samples between the consecutive edges is less than ten. Increase the sample rate and use the HiRes acquisition mode.	This warning appears when multiple edges are found within a switching cycle. The probable reason for multiple edges is ringing that is present in the switch voltage.	Configure the edge level to avoid ringing portions and increase the hysteresis band. Set Hi Res as an acquisition mode.
1766	Invalid data for HiPower Finder results.	The waveform does not have enough edges or the waveform is not proper for the selected measurement to run successfully.	Decrease the horizontal scale of the waveform, or increase the record length value.
1767	Switching Loss results are Negative. This may be due to DC offset in the voltage and current probes used. To avoid this, compensate the probes for DC offset and also run Signal Path Compensation (SPC) on the oscilloscope before starting the application.	This may be due to DC offset in the voltage and current probes used.	To avoid this, compensate the probes for DC offset and also run Signal Path Compensation (SPC) on the oscilloscope before starting the application.

Error Codes	Error Message	Description	Possible Solutions
1768	Inadequate acquisition duration, increase the record length and run again.	This error appears when the frequency resolution is more than the selected frequency range.	Try running the measurement with more record length.
1769	Select the appropriate edge source (either voltage or current channel).	In Magnetic Property, edge source is neither set to the voltage nor the current channel.	Go to the Source configuration panel, set the edge source to either the voltage or the current channel.
1770	V(ce) cannot be negative. Check the coefficient values and run the measurement again.	The coefficients entered to calculate Vce ended up in a negative value of Vce which is not possible.	Check the coefficient values and enter valid values for a positive Vce.
1771	Not enough samples between edges.	Not enough samples between edges.	Not enough samples between edges.
1772	From and To Channels are the same.	From and To channels selected in deskew are the same.	Select different from and to channels for real time deskew.
1773	Too many edges in the waveform. Only 1 edge is required.	According to the configuration, only 1 edge is required to perform deskew. However, too many edges exist in the acquired waveform.	Set the Record length properly to have just 1 edge and run deskew again.
1774	The skew calculated is more than the oscilloscope permissible value, so it will be set to the maximum.	The calculated skew is more than what is supported by the oscilloscope.	Connect valid signals to the channels.
1775	The skew calculated is lower than the oscilloscope permissible value, so it will be set to the minimum.	The calculated skew is less than what is supported by the oscilloscope.	Connect valid signals to the channels.
1776	Not enough samples for current harmonics.	Not enough samples for the given number of harmonics and signal frequency.	Increase the number of samples and run the measurement again.
1777	Given current threshold is not applicable for the current waveform.	The threshold value is not applicable for the acquired current waveform.	Set the proper threshold value and run the measurement again.



Error Codes	Error Message	Description	Possible Solutions
1778	No peaks are found in the selected region, please change the cursor position.	The region selected by cursors does not have any peaks.	Adjust the cursor positions and run the measurement again.
1779	No peaks are found in the waveform, please acquire again.	The waveform is not proper and does not have any peaks.	Reacquire the waveforms and rerun the measurement.
1780	Low sampling rate, please increase the sampling rate and run the measurement again.	The sampling rate set is not enough for spectral analysis.	Set the sampling rate at a higher value and run the measurement again.
1781	Waveform sampling rate and/or record length does not match.	The sampling rate and record length of voltage and current channels do not match.	Make sure both channels have the same record length and sampling rate, and run the measurement again.
1782	Insufficient number of cycles.	No full cycle is available for power quality measurement.	Increase the horizontal scale to have at least one cycle and rerun the measurement.
1783	Low record length, please increase the sampling rate and run the measurement again.	The record length of the waveform is insufficient for the measurement.	Set the record length higher, and run the measurement again.
1784	Start frequency and stop frequency can't be the same.	In the Spectral analysis Configuration panel, Start and Stop frequency have been set to the same value. This is not allowed.	Set different values to Start and Stop frequencies.
1785	AutoSet failed: Oscilloscope is not responding, please recall default setup and run again.	Oscilloscope is not responding, thus autoseg failed.	Recall default setup and run autoseg again.
1786	Ref level and hysteresis are not applicable for the signal.	Ref level and hysteresis are not applicable for the signal.	Change the levels, and rerun the measurement.
1787	Autoseg save failed. Check system drive accessibility.	Unable to save autoseg data.	Check that the drive is accessible with appropriate permissions.
1788	Autoseg save failed.	Unable to save autoseg data.	Autoseg again.

Error Codes	Error Message	Description	Possible Solutions
1789	Recall Plot failed. The plot does not match the measurement.	The plot that is being recalled is not applicable to that particular measurement.	Recall appropriate plots related to that measurement.
1790	Autoset failed: Incompatible signal.	Autoset failed due to improper signal. This may be because there is too much noise in the input.	Connect a valid signal to the channel and run autoset again.
1791	Deskew performed successfully.	Deskew operation completed.	Deskew operation completed.
1792	Autoset Error.	Autoset failed to set the coupling/bandwidth on selected channels because the probe connected to respective channels does not support selected bandwidth or coupling.	Select appropriate coupling and/or bandwidth from the global configurations panel.
1793	Autoset Completed	Done with the autoset.	Done with the autoset.
1794	Selected resolution bandwidth is not applicable for input waveform, display results for available resolution?	The RBW selected from the configuration panel is not matching with the calculated RBW on the waveform.	Run at least horizontal autoset once before running spectral measurement.
1795	No edges found in the waveform. Adjust the waveform and rerun the measurement.	No edges found in the waveform acquired.	Change the oscilloscope horizontal settings to have at least one edge and rerun the measurement.
1796	Negative capacitance detected still showing the result please change ref levels and run the measurement again.	The average capacitance value calculated is negative.	Change reference levels from the configuration panel and rerun the measurement.
1797	Do you want to autoset?	This pop up comes before performing adeskew operation.	It is a yes or no pop up. If clicked yes it will autoset and continue the deskew, else it will just perform deskew.

Error Codes	Error Message	Description	Possible Solutions
1798	Unable to set the calculated skew value of ... value in scope vertical De-skew, since the Skew value is < Sample Interval. Increase the sample Rate and adjust the Record Length, such that Sample Interval is < " + GetFormattedValue(skewValue) + "\n The skew value has been set to " + GetFormattedValue(setValue) + " by scope".	Slew value calculated is less than the sampling interval.	Increase the sampling rate such that the sampling interval is less than the skew value.
1800	Turn on the device now.	The sequencer is waiting to acquire the signal for turn on time measurement.	Turn on the device and click ok.
1801	Unable to find edges for the region selected. Adjust the ref levels or change the cursor positions and re-rerun the measurement.	No edges found in the selected region of the waveform, may be the cursors are too close to each other or the waveform does not contain edges.	If cursors are too close to each other widen the gap between them or change the horizontal scale to acquire enough edges for the measurement.
1802	Current probe is not connected to any of the selected sources.	Current probe is not detected on any of the channels.	Connect a current probe and perform degauss again.
1803	No magnetic cycles found on the waveform. Adjust the cursors and rerun the measurement.	Cursor gating is turned on but no complete cycles are available between cursors or no complete cycles are available in entire cycle.	Widen the gap between cursors if the cursor gating is ON or change the horizontal parameters and acquire the signal again.
1804	No magnetic cycles found on the waveform. Acquire again with a longer Record length and rerun the measurement.	One full cycle is not available in the entire waveform.	Change horizontal scale and rerun the measurement.
1805	The configured frequency range is not supported by the spectral analysis measurement.	The difference between start to stop frequency is too long for supported record length and sampling rate.	Change start/stop frequency such that the difference is reduced.

Error Codes	Error Message	Description	Possible Solutions
1806	No samples available in the selected region of the waveform. Reposition the cursors and run the measurement.	The selected region does not contain any samples, may be both the cursors are in the same position.	Move one of the cursors and rerun the measurement.
1807	AutoSet is only applicable for live channels.	User tried to run autosest on reference sources.	Select live channels and run autosest.
1808	Clipping detected during autosest, Rerun horizontal after completing vertical autosest.	Clipping detected during horizontal autosest and the autosest is not able to identify signal.	Run vertical autosest first and then run horizontal.
1809	No complete switching cycle found in the waveform. Reposition the cursors, check the waveform and re-run the measurement.	Not a full switching cycle is available in the selected region of the waveform.	Widen the gap between cursors or change horizontal scale and run the measurement again.
1810	Update and select appropriate RBW from measurement configuration panel and rerun autosest.	In Spectral Measurement, "Auto set" sets the horizontal resolution based on RBW(Hz). This need to update or set before performing measurement.	Click <b>Configure &gt; Spectral Config &gt; Update / select Res BW(Hz)</b>
1811	Consecutive mask point can't be same, change values and click Add/Update button.	SOA measurement has a feature to create a mask using "Mask Designer". Condition is only that lines connected to between points should not intersect.	Avoid creating points, which lines are intersect.
1812	Mask is not valid (Specify more number of points(Minimum 3 points) and make sure points do not lie on a straight line).		

Error Codes	Error Message	Description	Possible Solutions
1813	Mask points are not valid. It could be because.		Mask has less number of points. All the points in the mask are on a straight line. Redesign the mask and use preview to check the validity of mask or disable the mask from configuration panel and run the measurement again.
1814	60 cycles of Line Frequency is required OR Make sure Configure ->Line Frequency is correct.	"AM14" standard of Current Harmonic measurement need a 60 cycle to create a 15 parts of each 4 cycles to do analysis.	<ol style="list-style-type: none"> <li>1. Click <b>Configure &gt; Standard &gt; Line Frequency &gt; Auto</b></li> <li>2. <b>Configure &gt; Standard &gt; Harmonic Order</b></li> <li>3. Open <b>Source Configure &gt; Vert/ Horiz</b></li> </ol>
1815	Unable to find edges for the configured trigger level.		Adjust the trigger level and re-run the measurement.
1816	Unable to find edges for the configured output max voltage level.		Adjust the voltage level and re-run the measurement.
1817	Not a valid mask, make sure lines are not intersecting.	The coordinates used to draw the mask has only one or two points.	Generate mask with atleast three points and not all of them in a straight line.
1818	Make sure input signals are not DC in nature.		Check the setup for further analysis.
1819	For most (>80%) of the acquisition duration, the input waveform is DC in nature, since difference of samples yields zero values. A plot with the same name is already added.	RDS(on) measurement expect input to be AC in nature. In some case, if the user gives pure DC input or input which has 80% of the time DC in nature, Measurement do not work and through an error message.	Make sure to have proper transitions in the waveforms to analyze for entire waveform.

Error Codes	Error Message	Description	Possible Solutions
1820	Plot already added with selected row color. Select some other row or clear the selected row and try Recall option.	SOA overlay measurement has a feature to plot various result on a single plot.	Select a new row to reference with new overlay plot data.
1821	Recent plots does not exist. Run measurement to get the recent saved plots.	Recent, opens the plot data saved or Recalled and Cleared plot.	Either Plot data should be saved or Recalled and Cleared, to open Recent plot.
1822	Selected scale and scale in the selected mask file does not match. Do you want to change the scale?	NA (We are automatically changing the scale by Yes/No popup)	NA
1823	Selected mask file may be corrupted. Recall a valid mask file.	If user saves the invalid mask, It cannot recall.	Create a valid mask, which can be shows on Graph. "Graph" button is present in <b>Configuration &gt; Mask Editor</b> .
1824	No coordinates found. Recall a valid mask file.	If user saves the invalid mask, It cannot recall.	Create a valid mask, which can be shows on Graph. "Graph" button is present in <b>Configuration &gt; Mask Editor</b> .
1825	Coordinate values are not within the specified range.		
1826	File not found.	When user try to recall a file, which is not a valid or not presented, error message comes up.	Make sure, the recalling file is present at the specified path.
1827	Changing the scale will clear the unsaved mask. Press Yes to clear the mask. Press No to return.	NA (We are not asking to user, if user changes the scale)	NA
1828	Could not log the data, check if the file is in use.	If the file is already Open, logging of data is not possible.	Close the opened file and rerun.

Error Codes	Error Message	Description	Possible Solutions
1829	Record Length is chopped to 12.5M with respected start point.	For the case of Spectral measurement, if the RL is greater than 12.5 M, Signal is chopped from 0 position or 1 cursor position to 12.5M.	It just an informative message to user.
1830	Zoom is not applied as very few complete cycles are available.	In case of Low frequency inputs, if Auto set is performance, it sets only few cycles to acquire for time limit operation. In such a case Zoom after auto set is not applicable.	It just an informative message to user.
1831	Make sure Sampling minimum frequency is ' Line Frequency x Harmonics No.x 2.2' times.	In Total Power Quality, Current harmonic and Voltage Harmonic, If the user is running with condition of aliasing, this error message is displayed.	<ol style="list-style-type: none"> <li>1. Click on <b>Configure &gt; Standard &gt; Line Frequency &gt; Auto</b></li> <li>2. <b>Configure &gt; Standard &gt; Harmonic Order</b></li> <li>3. Open <b>Source Configure &gt; Vert/ Horiz</b></li> </ol>
1832	File not found.	File is not available at the specified location.	Rerun the measurement.
1833	No sufficient data available for Time trend Plot. Increase the record length or number of cycles being captured.	Not Used NA	Not Used NA
1834	Acquired waveform is negative in nature. Inverse the probing points and re-acquire.		Inverse the probing points and re-acquire.
1835	Please wait while plotting.	Data rendering is in progress.	Please wait for the rendering to happen.
1836	Edges found are not proper, may be due to ringing in the wfm.	Configure Gate voltage as an edge source to compute edges.	Make sure at least 100 sample points are present in each switching cycle. We recommend to use source autose.

Error Codes	Error Message	Description	Possible Solutions
1837	For a REF source the REF voltage cannot be set more than the maximum line voltage.		
1838	For most (>80%) of the acquisition duration, the input waveform is DC in nature and consecutive difference of samples yield zero values.	RDS(on) measurement expect input to be AC in nature. In some case, if the user gives pure DC input or input which has 80% of the time DC in nature, Measurement do not work and through an error message.	Make sure to have proper transitions in the waveforms to analyze for entire waveform.
1839	SOA-X-Y(DPX) cannot run with other measurements of Switching Analysis.	Select only SOA-X-Y (DPX) to run it.	Press Yes to clear the list and add the new measurement. Press No to return back without any modification.
1840	Use Gate Voltage (Vg), If Signal is noisy	In Switching Loss Analysis, it has an option of PFC signal. Generally, PFC need a Gate Voltage to detect the edges.	It is just a reminder to user if PFC is selected.
1841	AutoZero performed successfully	All the measurement, Source Configuration has a option of "AutoZero", which set the DC offset.	It's a message of completion of operation "AutoZero".
1842	AutoZero: Computed DC Offset value	Turn On Time cannot run with other measurements of Output Analysis.	Remove the grouping of such measurements and run them separately.
1843	Turn On Time cannot run with other measurements of Output Analysis.	Select only Turn On Time to Run it.	Press Yes to clear the list and add the new measurement. Press No to return back without any modification.
1844	In Rush Current cannot run with other measurements of Input Analysis.	Select only Inrush Current to Run it.	Press Yes to clear the list and add the new measurement. Press No to return back without any modification.



Error Codes	Error Message	Description	Possible Solutions
1845	Input Capacitance cannot run with other measurements of Input Analysis.	Select only Input Capacitance to Run it.	Press Yes to clear the list and add the new measurement. Press No to return back without any modifications.
1846	No edges were found in the waveform, possible due to ringing in the switching transitions.	The minimum number of samples between consecutive edges must be atleast six or more.	In case of PFC configuration, adjust the edge REF level and the hysteresis value higher than default levels to overcome no or any false edges. For other topologies you may need to re-acquire the waveforms.
1847	Max X Scale should be greater than Min X Scale.	In SOA mask designer, if maximum X scale value is entered lesser than minimum X scale value, This error comes.	Set maximum X scale value greater than minimum X scale value
1848	Min X Scale should be lesser than Max X Scale.	In SOA mask designer, if minimum X scale value is entered greater than maximum X scale value, This error comes.	Set minimum X scale value lesser than maximum X scale value
1849	Max Y Scale should be greater than Min Y Scale.	In SOA mask designer, if maximum Y scale value is entered lesser than minimum Y scale value, This error comes.	Set maximum Y scale value greater than minimum Y scale value
1850	Min Y Scale should be lesser than Max Y Scale.	In SOA mask designer, if minimum Y scale value is entered greater than maximum Y scale value, This error comes.	Set minimum Y scale value lesser than maximum Y scale value
1851	Probe is already Degaussed.	Probe is already Degaussed.	Not required to degauss probe.
1852	Default vertical gain of 10e-3 V/div is set for probe type am503s.	This message is displayed for AM503 probe series.	When user performs vertical or both autoset on AM503 series, it displays the information about vertical settings.

Error Codes	Error Message	Description	Possible Solutions
1854	Voltage & Current signals are noisy	Voltage & Current signals are noisy	Recommended to setup Gate Voltage(Vg) and deselect Auto Level.
1855	Make sure the RecordLength is at least 10K having 10 switching cycles	The RecordLength should be at least 10K having 10 switching cycles.	Make sure the RecordLength is at least 10K having 10 switching cycles.
1856	The 'Start' and 'Stop' frequency values should be less than sample rate of the reference waveform.	The 'Start' and 'Stop' frequency values should be less than sample rate of the reference waveform.	Re-acquire with higher sample rate and set 'Start' and 'Stop' frequencies lower than acquired sample rate. The measurement continues by computing for full bandwidth of the REF waveform.

## Correlation of measurement to configurations

The following table list the configurations for each measurement.

**Table 11: Switching Analysis**

UI Name	Global	Options	Edges	Type	PWMType	OnOffLevel	Mask Editor	Method
Switching Loss	✓	✓		✓		✓		
Hi-Power Finder	✓		✓		✓			
SOA	✓						✓	
RDS(on)	✓							✓
dv/dt	✓	✓						
di/dt	✓	✓						
SOA X-Y (DPX)								

**Table 12: Timing Analysis**

UI Name	Global	Options	Edges	Edge
Pulse width	✓	✓	✓	
Duty Cycle	✓	✓	✓	
Period	✓	✓	✓	
Frequency	✓	✓	✓	
Skew	✓	✓		✓

**Table 13: Magnetics**

UI Name	Global	Options	Edges	Source	Physical Chars1	Physical Chars2
Inductance	✓	✓	✓			
Magnetic Property	✓	✓		✓	✓	✓
Magnetic Loss	✓					
$I$ vs $\int V$	✓					

**Table 14: Input Analysis**

UI Name	Global	Options	Harmonics Table	Line Frequency	Standard	I-Probe Impedance
Power Quality	✓					
Current Harmonics	✓		✓		✓	✓
Total Power Quality	✓		✓		✓	✓
In-Rush Current	✓	✓				
Input Capacitance	✓	✓				
Voltage Harmonics	✓			✓		

**Table 15: Output Analysis**

UI Name	Global	Line Ripple Freq	Ripple Freq	Spectral Config	Input	Output
Line Ripple	✓	✓				
Switching Ripple	✓		✓			
Spectral Analysis	✓			✓		
Turn On Time	✓				✓	✓

**Table 16: Amplitude**

UI Name	Global	Options	Edge	Signal Type
High	✓	✓	✓	
Low	✓	✓		
High Low	✓	✓	✓	
Cycle Min	✓	✓	✓	✓
Cycle Max	✓	✓		✓
Cycle PkPk	✓	✓		✓

## Correlation of measurement to plots

The following table list the plots displayed for each measurement.

**Table 17: Switching Analysis**

UI Name	Time Trend	Histogram	Switching On OFF	SOA Graph	Rise Edge(s)-Time Trend	Fall Edge(s)-Time Trend
Switching Loss			✓	✓		
Hi-Power Finder						
SOA				✓		
RDS(on)	✓					
dv/dt		✓		✓	✓	✓
di/dt		✓		✓	✓	✓
SOA X-Y (DPX)						

**Table 18: Timing Analysis**

UI Name	Time Trend	Histogram
Pulse width	✓	
Duty Cycle	✓	
Period	✓	
Frequency	✓	
Skew	✓	✓

**Table 19: Magnetics**

UI Name	Inductance Curve	BH Curve	$I \text{ vs } \int V$
Inductance	✓		
Magnetic Property		✓	
Magnetic Loss			
$I \text{ vs } \int V$			✓

**Table 20: Input Analysis**

UI Name	$V \cdot I$ Power Waveform	$\int (V \cdot I)$ Energy Waveform	Harmonics Bar Graph
Power Quality	✓	✓	
Current Harmonics			✓
Total Power Quality			✓
In-Rush Current			
Input Capacitance			
Voltage Harmonics			✓

**Table 21: Output Analysis**

UI Name	Spectrum
Line Ripple	
Switching Ripple	
Spectral Analysis	✓
Turn On Time	

**Table 22: Amplitude**

UI Name	Time Trend	Histogram
High	✓	✓
Low	✓	✓

UI Name	Time Trend	Histogram
High Low	✓	✓
Cycle Min	✓	✓
Cycle Max	✓	✓
Cycle PkPk	✓	✓

## Parameters

### About application parameters

This section describes the Advanced Power Analysis application parameters, and includes the default menu settings. You should refer to the user manual for your oscilloscope for operating details of other controls, such as front-panel buttons.

The parameters for the menus and options list the selections available for each and include the default values.

### Sequencer parameters

Parameters	Selections
Clear	None
Recalc	None
Single	None
Run	None

### Measurement menu parameters

Parameters	Selection	Default Setting
Switching Analysis	Switching Loss, Hi-Power Finder, SOA, SOA X-Y (DPX), di/dt, dv/dt, RDS(on)	None
Timing Analysis	Pulse Width, Period, Duty Cycle, Frequency	None
Magnetics	Inductance, Magnetic Loss, Magnetic Property, I vs V	None
Input Analysis	Power Quality, Current Harmonics, Voltage Harmonics, Total Power Quality, In Rush Current, Capacitance	None
Output Analysis	Line Ripple, Switching Ripple, Turn on Time, Spectral Analysis	None
Amplitude	Cycle min, Cycle max, Cycle peak-to-peak, High, Low, High-Low	None

### Configure measurements menu parameters

You can configure the parameters for the selected measurements.

[Source Configuration Parameters](#)

[SOA Parameters](#)

[di/dt Parameters](#)

[dv/dt Parameters](#)

[Magnetics Parameters](#)

[Total Power Quality Parameters](#)

[Current Harmonics Parameters](#)

[Pulse Width Modulation Parameters](#)

[Period Modulation Parameters](#)

[Duty Cycle Modulation Parameters](#)

[Frequency Modulation Parameters](#)

### Source configuration parameters

Parameter	Selection	Default Setting
Voltage	Ch1, Ch2, Ch3, Ch4, Math1, Math2, Math3, Math4, Ref1, Ref2, Ref3, Ref4	Ch1
Current	Ch1, Ch2, Ch3, Ch4, Math1, Math2, Math3, Math4, Ref1, Ref2, Ref3, Ref4	Ch2

### Configure Hi-Power finder and switching loss parameters

Parameter	Selection	Default Setting
<b>Hi-Power Finder</b>		
Type tab	Fixed, Variable	Fixed
On-Off Level tab	Vsw, Vg	Vsw
Vg Source	Ch1-Ch4, Math1-Math4	Ch3
Units	Absolute, Percentage	Percentage
Hysteresis %	-	10%
Ref Level	-	50%
Reference Absolute		0 V
Hysteresis Absolute		0 V
Device	N-Channel, P-Channel	N-Channel
V-level percentage	-	5%
I-level percentage	-	5%
V-level absolute	-	5 V
I-level absolute	-	1 A
Options tab		

Parameter	Selection	Default Setting
Vg Level	-	1.5 V
Filter Current	-	Checked
Switch On	-	Disabled
Details		
<b>Switching Loss</b>		
Type tab		
PWM Type	Fixed, Variable	Fixed
Cursor gating	On, Off	Off
Device	Auto, User	Auto
Type	MOSFET, BJT/IGBT	BJT/IGBT
RDS On	-	20 mohm
On-Off Level tab	Vsw, Vg	Vg if PFC is selected else Vsw
Vg Source	Ch1-Ch4, Math1-Math4	Ch3
Units	Absolute, Percentage	Percentage
Hysteresis %	-	10%
Autocalc loss without Vg	-	Unchecked
Ref Level	-	50%
Reference Absolute		50 V
Hysteresis Absolute		5 V
Device	N-Channel, P-Channel	N-Channel
V-level percentage	-	5%
I-level percentage		5%
V-level absolute	-	5 V
I-level absolute		1 A
Option tab		
Vg Level	-	1.5 V
Signal Condition	-	Checked
Filter Current	-	Checked
Switch On	-	Disabled
Details		



### Configure magnetics parameters

Parameter	Selection	Default Setting
Magnetic Loss tab		
Cursor Gating Details	On, Off	Off
Inductance-Edge Source	Ch1-Ch4, Math1-Math4	Ch1
Ref Level	Absolute, Percentage	Percentage
Ref Level Absolute	-	0 V
Hysteresis Absolute	-	0 V
Ref Level Percentage	-	50%
Hysteresis Percentage	-	10%
Single, Multiple	Single, Multiple	Single
Magnetic Property tab-Type and Edge Source		
Freq/Duty	Fixed, Variable	Fixed
Cursor Gating	On, Off	Off
# of Windings ( Primary Windings )	-	One
Edge Source	Ch1-Ch4, Math1-Math4	Ch1
Units	Absolute, Percentage	Percentage
Ref Level Percentage	10-90%	50%
Hysteresis Percentage	5-40%	10%
Magnetic Property tab-Physical Chars		
Units	SI, CGS	SI
Number of Turns	1-1 M	1
Cross Section Area-SI		1 m <sup>2</sup>
Cross Section Area-CGS		1 cm <sup>2</sup>
Magnetic Length-SI		1 m
Magnetic Length-CGS		1 CM
# of Windings	Two, More	Two
Windings 1 Source	Ch1-Ch4	Ch3
Magnetizing Current	Ref1-Ref4	Ref1
Windings 2 Source	Ch1-Ch4, Unused	Unused

**Configure SOA parameters**

Parameter	Selection	Default Setting
Cursor Gating	On, Off	Off
Mask	Editor	Enable
Utility	Overlay	

**SOA mask**

Parameter	Selection	Default Setting
Mask Grid		
Scale	Log, Linear	Linear
Linear	Mask Values	X-Min, X-Max -40 KV to 40 KV Y-Min, Y-Max -40 KA to 5 KA
Log	Mask Values	X-Min, X-Max -40 KV to 40 KV Y-Min, Y-Max -40 KA to 5 KA

**Configure di-dt parameters**

Parameter	Selection	Default Setting
Units	Percentage, Absolute	Percentage
Ref Level Percentage		50%
Hysteresis Percentage		10%
Ref Level Absolute		0A
Hysteresis Absolute		0A

**Configure dv-dt parameters**

Parameter	Selection	Default Setting
Units	Percentage, Absolute	Percentage
Ref Level Percentage		50%
Hysteresis Percentage		10%
Ref Level Absolute		0 V
Hysteresis Absolute		0 mV

### Configure current harmonics parameters

Parameter	Selection	Default Setting
Standards	61000-3-2, AM 14, MIL 1399	61000-3-2
61000-3-2		
Line Frequency	50 Hz, 60 Hz	50 Hz
Harmonic Table	Table 1-10	Table 1
Class	Class A-Class D	Class A
AM 14		
Line Frequency	50 Hz, 60 Hz	50 Hz
Harmonic Table	Table 1-10	1
Class	Class A-Class D	Class A
	Filter	Checked
	Controls> Input Power	100W
	Controls> Power Factor	1
	Controls> Fundamental Current	15A
MIL 1399		
Harmonics	50,100	50
Line Frequency	60 Hz, 400 Hz	60 Hz
i-Probe Impedance		
Transfer Impedance Table	Table 1-10	Table 1
Use Impedance Table Check box	Unchecked, Checked	Unchecked

### Configure voltage harmonics parameters

Parameter	Selection	Default Setting
<b>Line Frequency</b>		
Line Frequency	50 Hz, 60 Hz, Custom (1 Hz to 4 KHz)	50 Hz
Harmonics order	40 - 100	40
<b>Global</b>		
Coupling	AC, DC	DC
Bandwidth Limit	20 MHz, 250 MHz, Full <sup>1</sup>	20 MHz
Switching Freq	50 Hz to 1 MHz	100 Hz
Acquisition Mode	Hi Res, Sample, Pk Detect	Hi Res

<sup>1</sup> \*These options may not be available on all supported oscilloscopes. Please refer to your oscilloscope bandwidth options.

**Configure total power quality parameters**

Parameter	Selection	Default Setting
Standards	61000-3-2, AM 14, MIL 1399	61000-3-2
61000-3-2		
Line Frequency	50 Hz, 60 Hz	50 Hz
Harmonic Table	Table 1-10	Table 1
Class	Class A-Class D	Class A
AM 14		
Line Frequency		50 Hz
Harmonic Table		1
Class		Class A
	Filter	Checked
	Controls> Input Power	100W
	Controls> Power Factor	1
	Controls> Fundamental Current	15A
MIL 1399		
Harmonics	50,100	50
Line Frequency	60 Hz, 400 Hz	60 Hz
i-Probe Impedance		
Transfer Impedance Table	Table 1-10	Table 1
Use Impedance Table Check box	Unchecked, Checked	Unchecked

**Configure line ripple parameters**

Parameter	Selection	Default Setting
Coupling	AC, DC	DC
Bandwidth Limit	20 MHz, 250 MHz, Full <sup>2</sup>	20 MHz
Acquisition Mode	Hi Res, Pk Detect, Sample	Hi Res
Ripple Freq	50 Hz, 60 Hz, 400 Hz	50 Hz

<sup>2</sup> \*These options may not be available on all supported oscilloscopes. Please refer to your oscilloscope bandwidth options.

### Configure switching ripple parameters

Parameter	Selection	Default Setting
<b>Ripple Freq</b>		
Switching Ripple Frequency	50 Hz to 1 MHz	100 KHz
<b>Global</b>		
Coupling	AC, DC	DC
Bandwidth Limit	20 MHz, 250 MHz, Full <sup>3</sup>	20 MHz
Switching Freq	50 Hz to 1 MHz	100 Hz
Acquisition Mode	Hi Res, Sample, Pk Detect	Hi Res

### Configure Turn-On time parameters

Parameter	Selection	Default Setting
Input		
Source	Ch1, Ch2, Ch3, Ch4	Ch1
Converter	AC-DC, DC-DC	AC-DC
Max Voltage	1 V-500 V	230 V
Trigger Level	1 V-500 V	230 V
Max Turn-On Time	1 us to 5 s	200 ms
Output		
Source 1	On, Off	On
Source 2	On, Off	Off
Source 3	On, Off	Off
Source 1	Ch1-Ch4	Ch2
Max Voltage	-5.9 KV to 5.9 KV	5.0 V

### Configure pulse width timing analysis parameters

Parameter	Selection	Default Setting
Source	Ch1, Ch2, Ch3, Ch4,	Ch1
Ref Destination	Ref1, Ref2, Ref3, Ref4	Ref1
Units	Level, Percentage	Percentage
Percentage	Ref Level Hysteresis	Ref Level: 50% Hysteresis: 5%
Absolute	Ref Level Hysteresis	Ref Level:0 V Hysteresis:6 V
Edge	Positive, Negative	Positive
Cursor Gating		Off
Polarity	Positive, Negative	Positive

<sup>3</sup> \*These options may not be available on all supported oscilloscopes. Please refer to your oscilloscope bandwidth options.

**Configure period timing analysis parameters**

Parameter	Selection	Default Setting
Source	Ch1, Ch2, Ch3, Ch4,	Ch1
Ref Dest	Ref1, Ref2, Ref3, Ref4	Ref1
Ref Level Mode	Level, Percentage	Percentage
Percentage	Ref Level Hysteresis	Ref Level: 50% Hysteresis: 5%
Absolute	Ref Level Hysteresis	Ref Level:0 V Hysteresis:6 V
Edge Type	Rise, Fall	Rise
Cursor Gating	On, Off	Off

**Configure duty cycle timing analysis parameters**

Parameter	Selection	Default Setting
Source	Ch1, Ch2, Ch3, Ch4,	Ch1
Ref Dest	Ref1, Ref2, Ref3, Ref4	Ref1
Edge Level: Units	Level, Percentage	Percentage
Percentage	Ref Level Hysteresis	Ref Level: 50% Hysteresis: 5%
Absolute	Ref Level Hysteresis	Ref Level:0 V Hysteresis:6 V
Edge	Rise, Fall	Rise
Cursor Gating	On, Off	Off
Polarity	Positive, Negative	Positive

**Configure frequency parameters**

Parameter	Selection	Default Setting
Source	Ch1, Ch2, Ch3, Ch4,	Ch1
Edge Type	Rise, Fall	Rise
Edge Level: Units	Percentage, Absolute	Percentage
Ref Level: Percentage	1% to 99%	50%
Ref Level: Absolute	0 V to 6 V	0 V
Hysteresis	0 V to 3 KV	6 V

**Utilities menu**    The parameter available under Utilities Menu is:

- Deskew
- SOA Overlay
- Degauss
- Autoreset

**See also.**

*[Deskew](#)*

*[SOA Overlay](#)*

*[DeGauss](#)*

*[Autoreset](#)*

## Static deskew

Parameters	Selections	Default Setting
From	Source Ch1, Ch2, Ch3, Ch4	Ch1
Probe	TAM503B w/ A6302, AM503B w/ A6303, AM503B w/ A6312, AM503B w/ A6302XL, AM503B w/ A6303XL, AM503B w/ A6304XL, P5050, P5050B, P5100, P5100A, P5200, P5200A, P5202A, P5205, P5205A, P5210, P5210A, P6015A (10 ft), P6015A (25 ft), P6021A, P6131 (1.3 m), P6131 (2 m), P6138A, P6139A, P6139B, P6158, P6243, P6245, P6246, P6247, P6248, P6250, P6251, TAP1500, TAP2500, TCP0020, TCP0030, TCP0030A, TCP0150, TCP202, TCP202A, TCP2020, TCP202A;TPA-BNC, TCPA300 w/ TCP303, TCPA300 w/ TCP303 + TPA-BNC, TCPA300 w/ TCP305, TCPA300 w/ TCP305 + TPA-BNC, TCPA300 w/ TCP305A, TCPA300 w/ TCP305A + TPA-BNC, TCPA300 w/ TCP312, TCPA300 w/ TCP312 + TPA-BNC, TCPA300 w/ TCP312A, TCPA300 w/ TCP312A + TPA-BNC, TCPA400 w/ TCP404XL, TCPA400 w/ TCP404XL + TPA-BNC, TDP0500, TDP1000, TDP1500, TDP3500, TekVPI TCP0030, TekVPI TAP1500, TekVPI TAP2500, TekVPI TPA-BNC, THDP0100, THDP0200, TMDP0200, TPP0500, TPP0500B, TPP0502, TPP0850, TPP1000, Custom.	Custom
To Source	Ch1, Ch2, Ch3, Ch4	Ch2



Parameters	Selections	Default Setting
Probe	AM503B w/ A6302, AM503B w/ A6303, AM503B w/ A6312, AM503B w/ A6302XL, AM503B w/ A6303XL, AM503B w/ A6304XL, P5050, P5050B, P5100, P5100A, P5200, P5200A, P5202A, P5205, P5205A, P5210, P5210A, P6015A (10 ft), P6015A (25 ft), P6021A, P6131 (1.3 m), P6131 (2 m), P6138A, P6139A, P6139B, P6158, P6243, P6245, P6246, P6247, P6248, P6250, P6251, TAP1500, TAP2500, TCP0020, TCP0030, TCP0030A, TCP0150, TCP202, TCP202A, TCP2020, TCP202A;TPA-BNC, TCPA300 w/ TCP303, TCPA300 w/ TCP303 + TPA-BNC, TCPA300 w/ TCP305, TCPA300 w/ TCP305 + TPA-BNC, TCPA300 w/ TCP305A, TCPA300 w/ TCP305A + TPA-BNC, TCPA300 w/ TCP312, TCPA300 w/ TCP312 + TPA-BNC, TCPA300 w/ TCP312A, TCPA300 w/ TCP312A + TPA-BNC, TCPA400 w/ TCP404XL, TCPA400 w/ TCP404XL + TPA-BNC, TDP0500, TDP1000, TDP1500, TDP3500, TekVPI TCP0030, TekVPI TAP1500, TekVPI TAP2500, TekVPI TPA-BNC, THDP0100, THDP0200, TMDP0200, TPP0500, TPP0500B, TPP0502, TPP0850, TPP1000, Custom.	Custom

## Real Time Deskew.

Parameters	Selections	Default Setting
From Source	Ch1, Ch2, Ch3, Ch4	Ch1
To Source	Ch1,Ch2 Ch3, Ch4,	Ch2
Slope	Rise, Fall	Rise
Edges <sup>1</sup>		
Ref Level	Min:0,Max:100%	50%
Hysteresis	Min:0,Max:25%	5%
Source	Internal, External	External
Edges	-	1

## Prevailing switch mode power supply (SMPS)

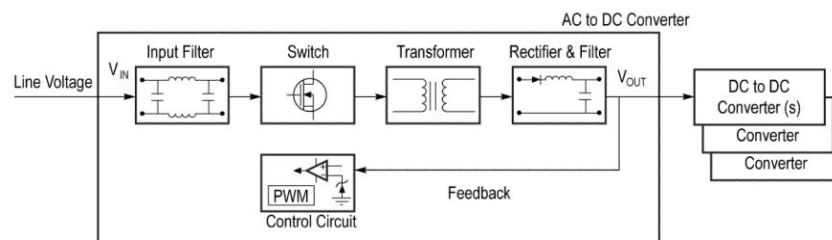
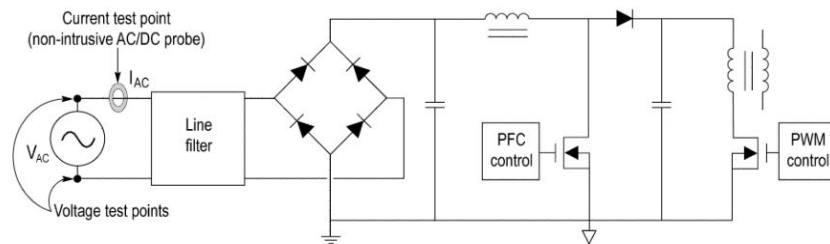

Figure 21: SMPS block diagram

<sup>1</sup> One is recommended. You can use up to 5 edges.

The most common architecture to ensure high efficiency power conversion is the switch-mode power supply. This architecture minimizes the use of lossy components. Instead, it uses switch-mode semiconductor devices, magnetic and passive components which are all, ideally, lossless. SMPS devices typically include a control section containing elements such as pulse-width modulated regulators, pulse-rated modulated regulators, and feedback loops. Sometimes, control sections may have their own power supplies. Switch mode power supply technology rests on power semiconductor switching devices such as Metal Oxide Semiconductor Field Effect Transistors (MOSFETs) and Insulated Gate Bipolar Transistors (IGBTs). These devices offer fast switching times and are able to withstand erratic voltage spikes. Equally important, they dissipate very little power in either the On or Off states, achieving high efficiency with low heat dissipation. For the most part, the switching device determines the overall performance of an switch mode power supply. Common measurements for each major section of the switch-mode power supply are shown here. For the switching device, key measurements include switching loss, average power loss and safe operating area. For the transformer section, power supply performance will depend on the magnetic properties and magnetic power loss in this section. It's also necessary to analyze how the supply interacts with its service environment. For this, measurements like power quality, harmonics and total harmonic distortion are important.



**Figure 22: SMPS circuit diagram**

## Switching loss (PFC)

### Switch current spikes during turn ON

During switch ON, the switch current increases and can have sudden spike or close ringing. These ringing cause wrong identification of start of TON. While identifying the start index on the current waveform, the current waveform is passed through the 4 point software moving average filter (MAV) to reduce ringing. The filtered current waveform is used for identifying the start index. The index of the filtered current waveform is mapped to the actual current for the calculation of Ton Loss.

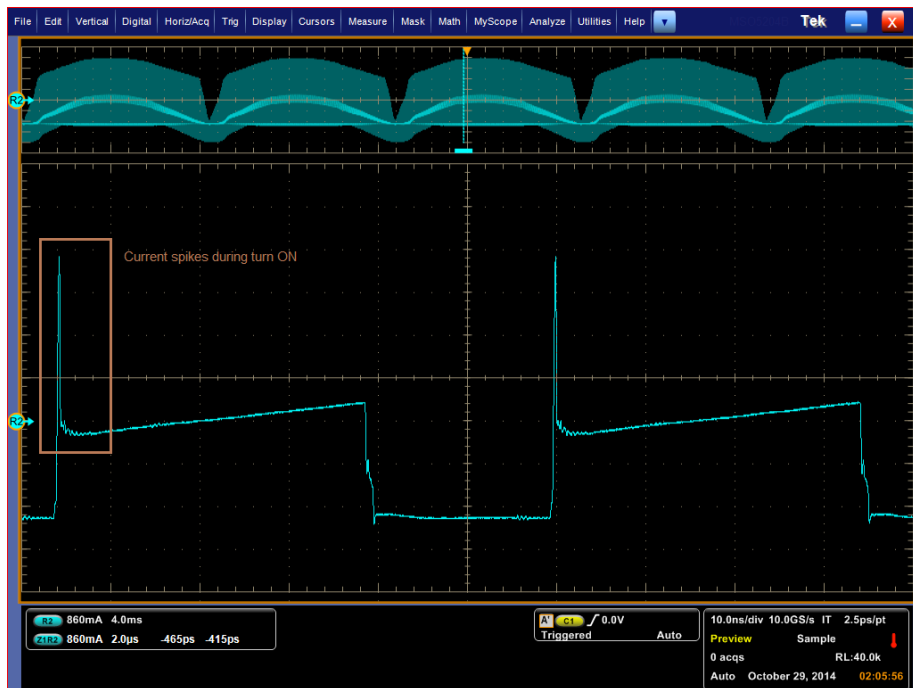

Figure 23: Current spikes during turn ON

### Cursor placement

Select two switching loss measurements, one with two sources VDS and ID and second instance with three sources VDS, ID and VG. Place the cursor-1 and 2 such that the region includes 120Hz hump, as shown in following figure.

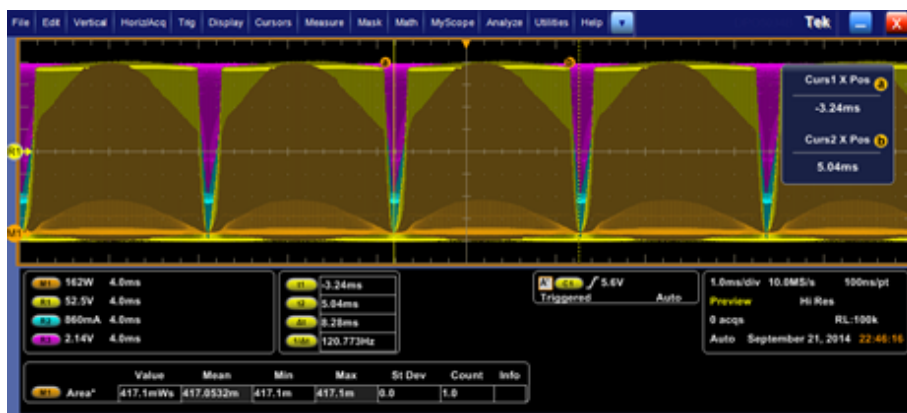

Figure 24: Cursor placement

Observe that VG has ringing and VDS is very clean, from following diagram.

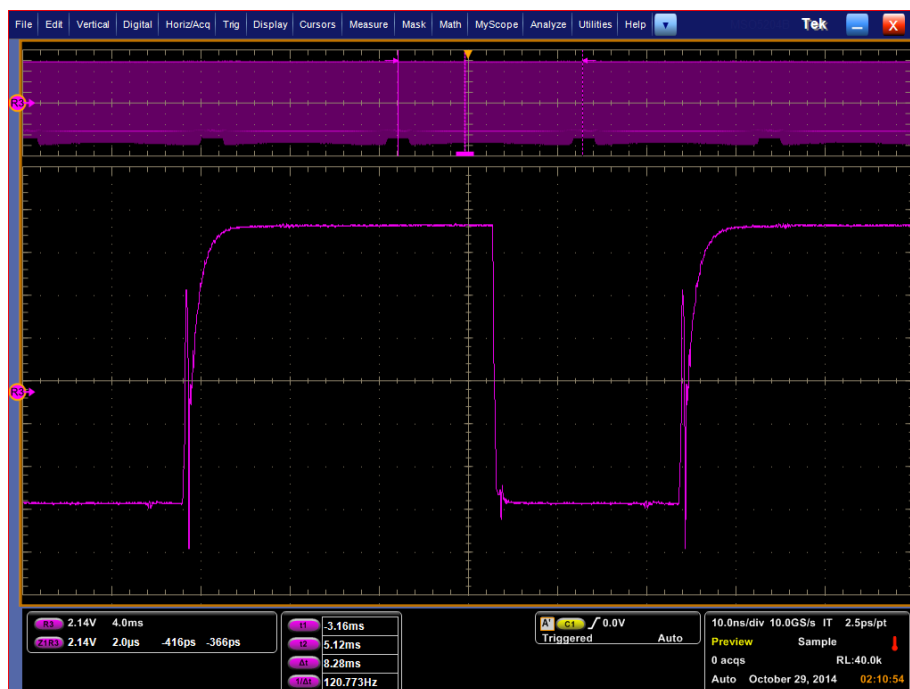

Figure 25: Ringing VG during TOFF

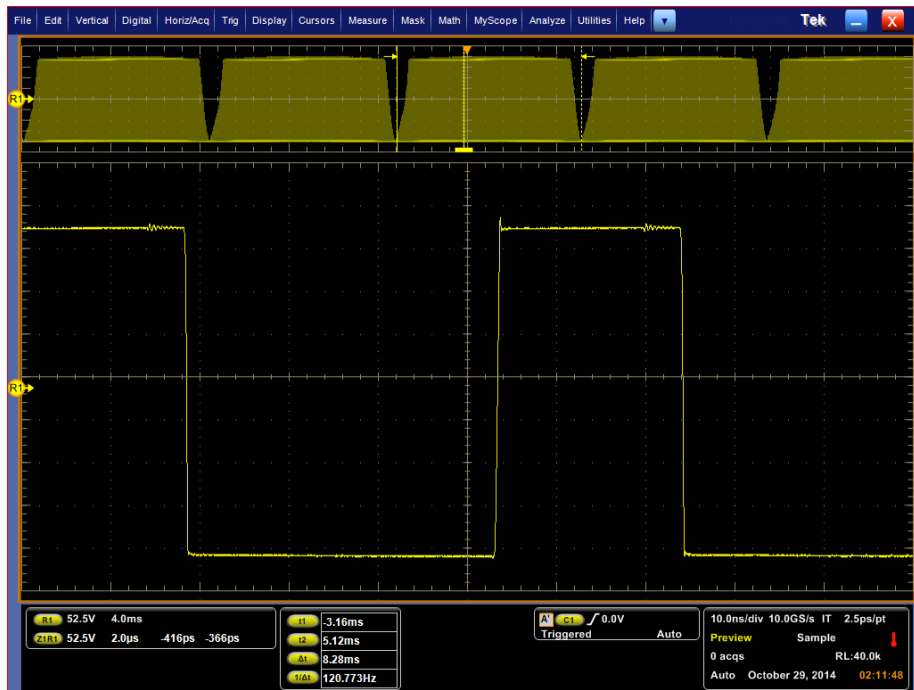
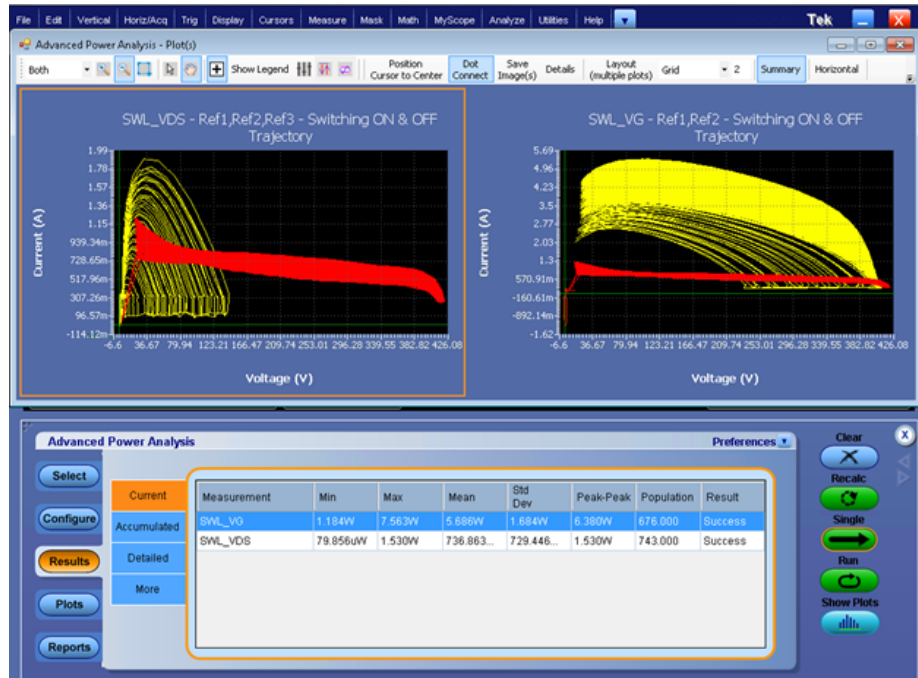

Figure 26: Clean VDS

Continue the measurement to get results and plots:



Observe that plot with VDS is correct since both current and voltage range on X-axis too 400V.

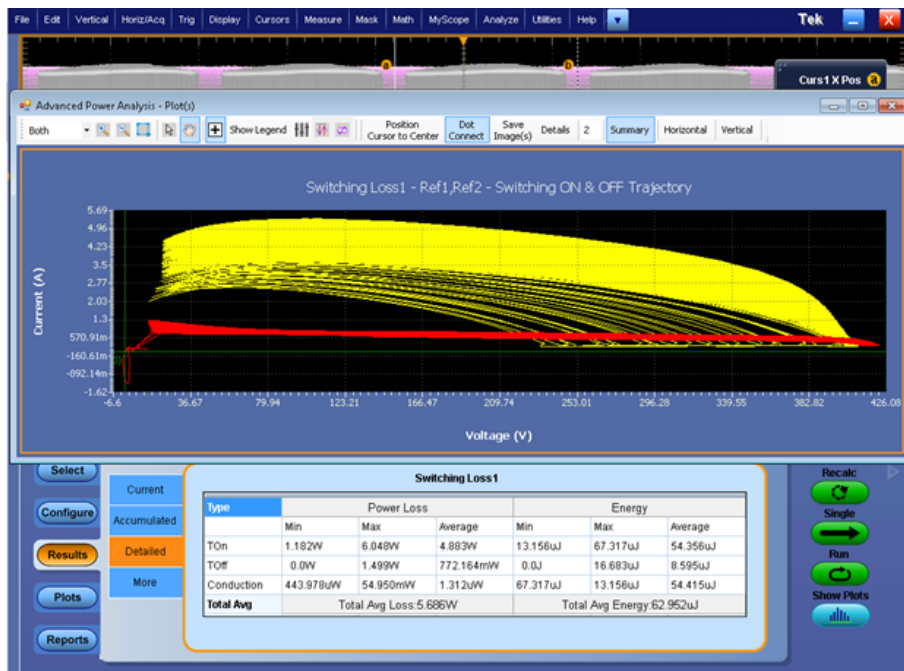

Figure 27: Measurement results and switching loss plot

### REF level computation for noisy VG source

For PFC gate voltage is recommended to use as edge source. Zoom the gate voltage and observe that there are ripples during turn ON of each switching cycle. This ringing will cause false edges and leads to error in the measurement. The default values will not work in this case.

Measure the clean region of the gate voltage where edges can be computed, as shown in figure-1. Set 12.25V value in the application configuration for edges.



How to compare between plot and result

Select a particular switching cycle and click Details. Select any Turn ON region, from the plot Prev and Next button, as shown in following figure.

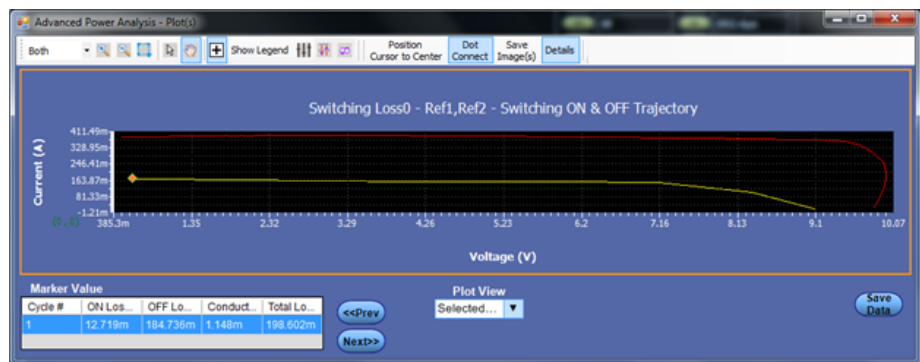

Observe that scope built-in area measurement with cursor gating turned on is ~ 75.32nWs. This matches with energy of TON statistics.





To calculate loss in watts multiply scope built-in value by switching frequency that is 164 KHz, which gives 12.35mW, which lies in within TON loss statistics.



In summary, you cannot directly compare values from plot to scalar results. To compare between plot cycle and results value, you need to add all values for TON and TOFF separately. Enable dot connect, as shown below, add all yellow points which corresponds to ON region, then multiply by sample interval to get particular energy.



# Algorithms

## About Algorithms

An algorithm is a method expressed as a finite list of well-defined instructions for calculating a function. This section explains the DPOPWR measurement algorithms.

### Equipment setup guidelines

Advanced Power Analysis sets the oscilloscope parameters appropriately for each measurement before running the measurements. The voltage or current waveforms are expected in any Ch1-Ch4 or Ref1-Ref4. In the case of two channel oscilloscopes, they are expected in CH1-CH2 or Ref1-Ref2.

1. For best results, the vertical scale for the waveform must be set such that the waveform does not exceed the vertical range of the oscilloscope. You should set the vertical scale so that the waveform occupies the full screen.
2. The sample rate must be set to capture enough waveform detail and avoid "aliasing" here.

## Options configuration

This configuration tab allows you to select waveform edge(s) the application should use to take each measurement.

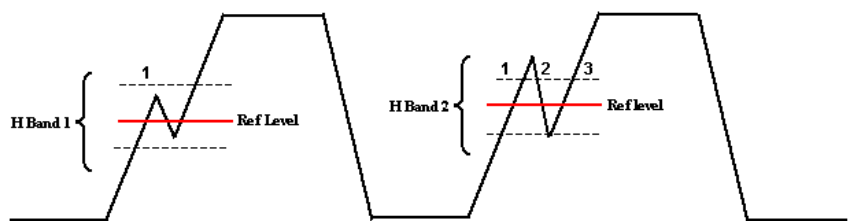

**Figure 28: Hysteresis**

The hysteresis input helps you to identify the cross over time on the waveform at specified reference levels as shown in the preceding figure. If there is any noise at the Reference level, the hysteresis band (H Band 1) helps to identify the single cross over.

If the hysteresis band (H Band 2) is less than the signal noise at the Reference level, this shows as three edges or transitions instead of one transition. Hysteresis band helps you to identify the correct transition.

### Ref Level

The REF Level is used to compute the edges for configured source at specified level.

## Switching analysis

**Switching loss** Switch-Mode Power Supply (SMPS) design has three types of losses, they are Turn-On (TON), Turn-Off (TOFF) and Conduction loss. To achieve the maximum efficiency, losses should be reduced. This section details about the basics of Switching Loss Analysis. A simplified SMPS schematic is shown in SMPS circuit diagram.

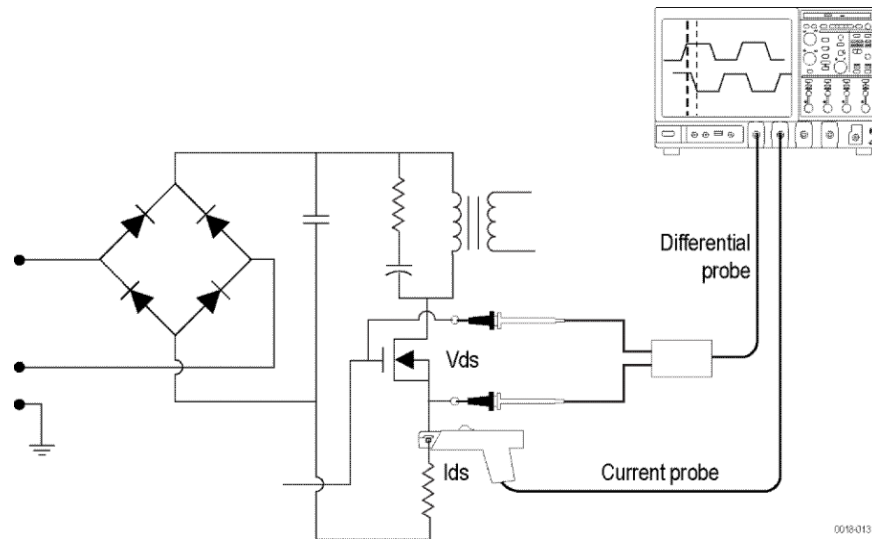
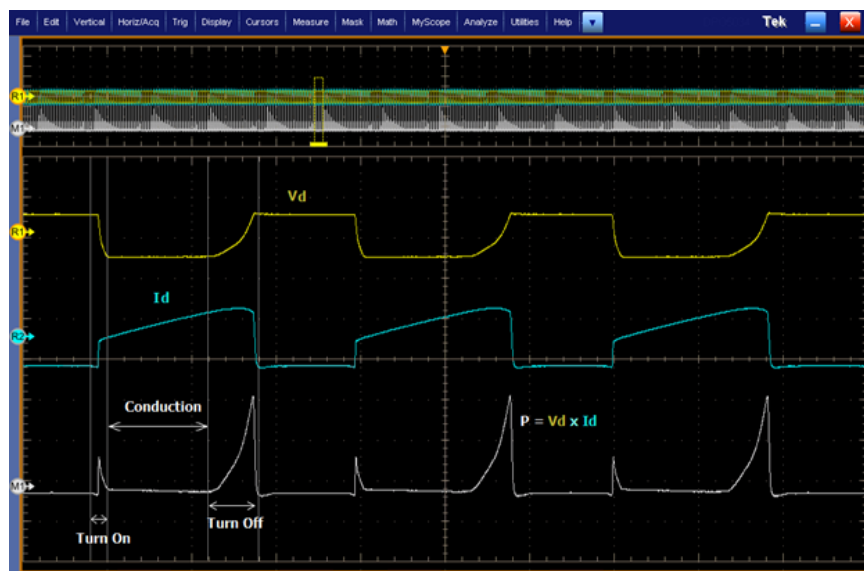

Figure 29: SMPS circuit diagram

SMPS circuit diagram shows the points where switching loss can be measured. After full wave rectification, the current signal should pass through the harmonic standard and enters for DC conversation. MOSFET plays an important role to meet the design of SMPS.

Regions of TON, TOFF and Conduction loss with voltage source (Vds) and current source (Ids) are shown in Switching Loss TON, TOFF and Conduction loss regions.



**Figure 30: Switching Loss TOn, TOff and Conduction loss regions**

All the switching losses are measured on Power signal based on Vds and Ids transition

**TOn Loss region:** When Vds starts rolling towards zero, the Ids starts to roll upward.

**TOff Loss region:** When Vds starts rolling upwards, the Ids start to roll towards zero.

**Conduction Loss region:** The region when the Ids is high and Vds is low.

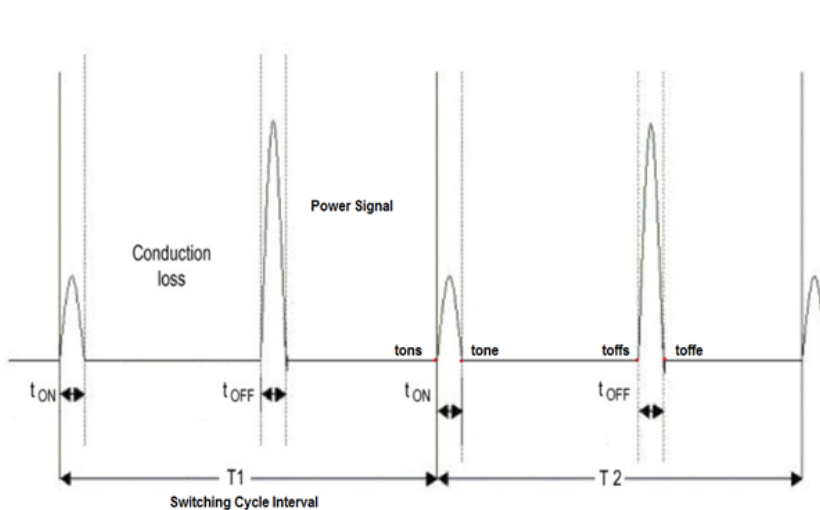

**Figure 31: Switching Loss Power signal and Losses regions**

$T_1$ : First switching cycle

$T_2$ : Second switching cycle

- **TOn and TOff losses**

T<sub>ON</sub> and T<sub>OFF</sub> losses per switching cycle are computed as in the following equations:

$$T_{ONi} = f_{swi} \times \int_{tonsi}^{tonei} \{V_{ds} \times I_{ds}\} dt \text{ Watt}$$

$$T_{OFFi} = f_{swi} \times \int_{toffsi}^{toffe_i} \{V_{ds} \times I_{ds}\} dt \text{ Watt}$$

Where,

T<sub>ONi</sub> - Turn ON loss of the i<sup>th</sup> switching cycle, in watt

T<sub>OFFi</sub> - Turn OFF loss of the i<sup>th</sup> switching cycle, in watt

f<sub>swi</sub> - Switching frequency of the i<sup>th</sup> switching cycle, in Hz

tonsi - Start point of T<sub>ONi</sub> region of the i<sup>th</sup> switching cycle, in time unit

tonei - End point of a power T<sub>ON</sub> region of the i<sup>th</sup> switching cycle, in time unit

toffe<sub>i</sub> - End point of T<sub>OFFi</sub> region, in time unit

toffs<sub>i</sub> - Start point of T<sub>OFFi</sub> region, in time unit

V<sub>ds</sub> - Voltage drain current, in Volts

I<sub>ds</sub> - Drain current, in Amps

■ **Energy Loss Computation**

Energy loss computation for TON and TOFF are as below:

$$T_{EONi} = \int_{tonsi}^{tonei} \{V_{ds} \times I_{ds}\} dt \text{ Joule}$$

$$T_{EOFFi} = \int_{toffsi}^{toffe_i} \{V_{ds} \times I_{ds}\} dt \text{ Joule}$$

T<sub>EONi</sub>: i<sup>th</sup> switching cycle turn on energy loss in joule.

T<sub>EOFFi</sub> - i<sup>th</sup> switching cycle turn off energy loss in joule.

■ **Computation of Conduction**

Conduction is computed as RDS(on) value for the **MOSFET** is used to calculate total loss in the application. To measure conduction loss in a MOSFET, use the following equation:

$$ConductionLoss_i = f_{SWi} \times \int_{tcsi}^{tcei} \{RDS_{on} \times I_{ds}^2\} dt \text{ watt}$$

$$ConductionEnergy_i = \int_{tcsi}^{tcei} \{RDS_{on} \times I_{ds}^2\} dt \text{ Joule}$$

Conduction loss and energy are computed using above equations.

Here,

tcei: <sup>th</sup> Cycle's stop/end point of conduction region.

tcsi: <sup>th</sup> Cycle's start point of conduction region.

RDS<sub>on</sub>: Dynamic resistance, in  $\Omega$

ConductionLoss<sub>i</sub>: <sup>th</sup> switching cycle conduction loss in watt.

ConductionEnergy<sub>i</sub>: <sup>th</sup> switching cycle conduction energy in joule.

To measure conduction loss in a **BJT/IGBT**, use the following equation:

$$ConductionLoss_i = f_{SWi} \times \int_{tcsi}^{tcei} \{V_{ce(SAT)} \times I_{ds}\} dt \text{ watt}$$

$$ConductionEnergy_i = \int_{tcsi}^{tcei} \{V_{ce(SAT)} \times I_{ds}\} dt \text{ Joule}$$

Here,

V<sub>ce(SAT)</sub> - is the voltage in volt, which should be configure in application

#### ■ Computation of Average Loss and Total Loss

Average and Total loss are computed as:

$$T_{onAvg} = \frac{1}{N_c} \sum_{i=1}^{N_c} T_{on_i}$$

$$T_{offAvg} = \frac{1}{N_c} \sum_{i=1}^{N_c} T_{off_i}$$

$$ConductionLoss_{Avg} = \frac{1}{N_c} \sum_{i=1}^{N_c} ConductionLoss_i$$

$$Total\ Avg\ Loss = T_{onAvg} + T_{offAvg} + ConductionLoss_{Avg}$$

$$T_{ETONAvg} = \frac{1}{N_c} \sum_{i=1}^{N_c} T_{EON_i}$$

$$T_{EOFFAvg} = \frac{1}{N_c} \sum_{i=1}^{N_c} T_{EOFF_i}$$

Where,

$f_{sw_i}$ :  $i^{th}$  switching cycle frequency, in Hz

$i$ : Cycle number

$N_c$ : Number of conduction cycles

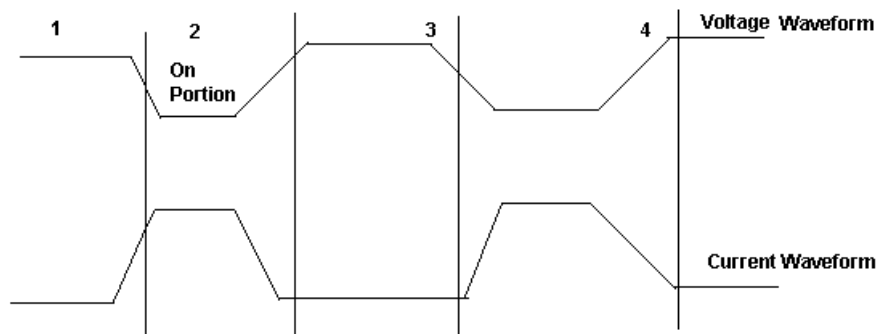



Total Switching Loss=Ton Loss+Toff Loss+Conduction Loss.

Basic Algorithm: For the calculation of the TOn, TOff, and average Total loss.

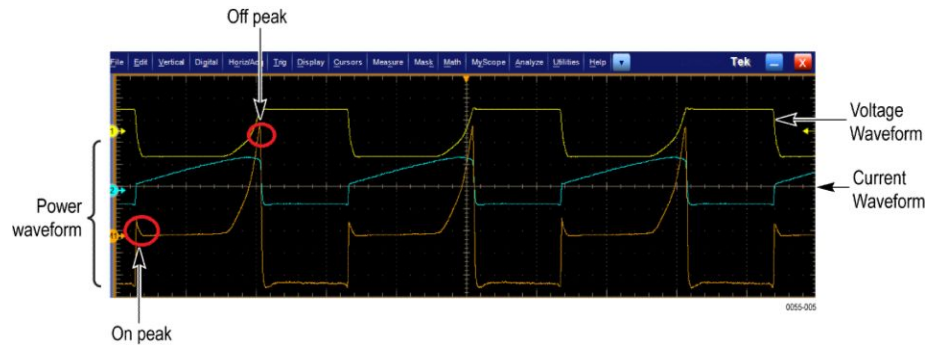

Concept to identify TOn and TOff using gate voltage for edge analysis:

Use gate voltage for edge analysis with default 50% edge level and hysteresis 10%.

- To find the start of TOn: The start of the TOn is 5% or 1.5 V whichever is lower on the rise slope of the gate voltage.
- To find the stop of TOn: The start index on the switch voltage is 5% or 1.5 V of the rise slope gate voltage. Move forward on the switch voltage from the start index until 5% or the configured level is met.
- To find the start of TOff: The start index is 80% of the gate voltage. From the Stop index, search for 5% of the switch voltage (on rise slope).
- To find the stop of TOff: The 80% of the gate voltage is start index. From this start index on switch current (fall slope) move forward until 5% of the max (switch current) is met.

If you select the Filter check box in the application, use the following equation to calculate moving average filter.

$$y(n) = \frac{1}{M} \sum_{k=0}^{M-1} x(n-k)$$

y(n)= is the output

x(n)= is the input

M is four sample points that are averaged

### Benefits of Vg Source and SWL configuration

The switching circuit of interest has three types of signal:

1.  $V_{ds}(t)$  switching voltage
2.  $I_{ds}(t)$  switching current waveform
3.  $V_{gs}(t)$  is the gate to source voltage waveforms

The gate voltage signal from IC/Oscillator switching circuit is a clean signal. But switching voltage and current signals can be noisy and has ringing based on various SMPS topologies.

Gate voltage is recommended for below scenarios:

#### Case1:

The switching voltage can vary in duty cycle and operating frequency as shown in the Discontinuous switching mode diagram. In this switch voltage can operate in both continuous conduction mode and discontinuous conduction mode. The switching cycles cannot be identified using switch voltage in this scenario. So, gate signal is used to identify the correct switching cycles, which follow the switching current  $I_{ds}$ .

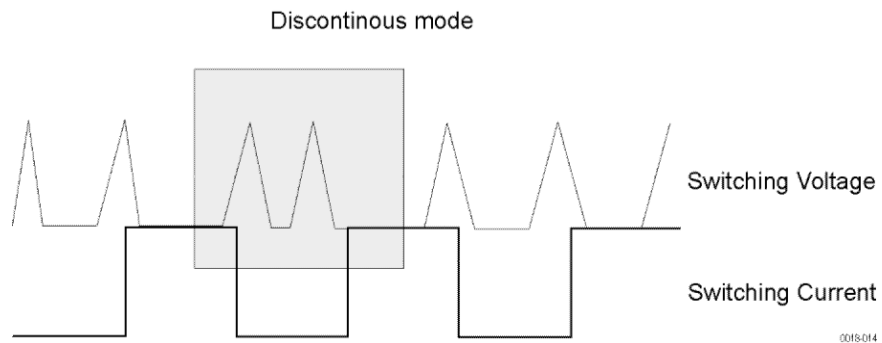

**Figure 32: Discontinuous switching mode**

#### Case 2:

For example, in Flyback topology lot of ringing can be observed during TOff and spikes on switching current as shown in Impulsive voltage source diagram. In such cases, voltage source cannot locate accurate TOn and TOff transition, and needs Vg source which is in phase with current signal.

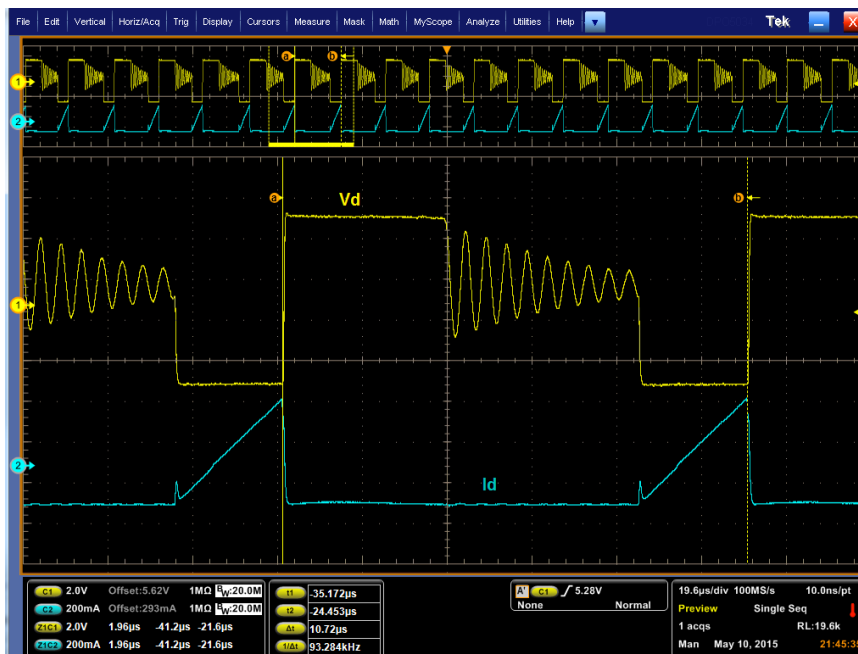

Figure 33: Impulsive voltage source

### Case 3:

By default, TON and TOFF regions are 5% of V - Level & I - Level of 'OnOffLevel' configuration. Example of sudden spike/ringing is shown in Impulsive current signal diagram. This ringing causes wrong identification of start of TON region. In such case use 'Absolute' unit of 'OnOffLevel' configuration and manual setting of the 'I-Level' and 'V-Level' in case of  $V_g$  source.

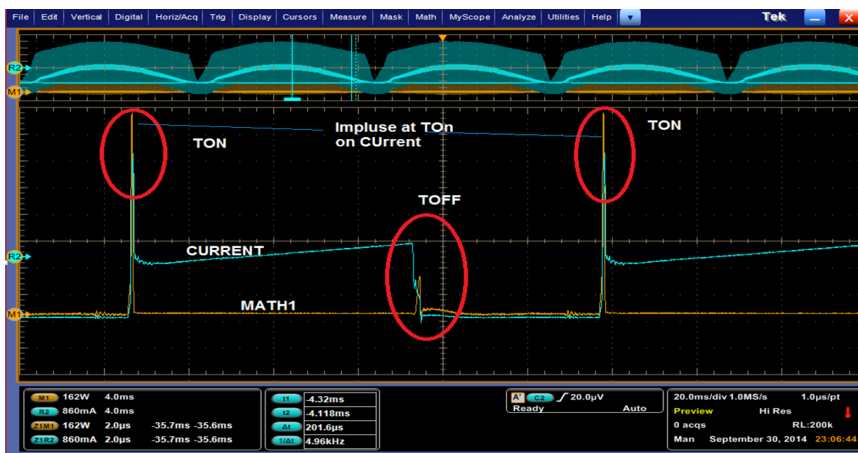

Figure 34: Impulsive current signal

So  $V_g$  is recommended in above cases, so that the start and stop of TON and TOFF regions are properly computed.

### Switching Loss Configurations

To compute losses, resonance on sources needs to be avoided, and it is described in the configuration on setup in the next section.

1. In Case 1 and 2, use the Gate Voltage ( $V_g$ ) source for noisy  $V_{ds}$  and  $I_{ds}$  signals, which can be selected as shown in the Switching Loss source configuration diagram.

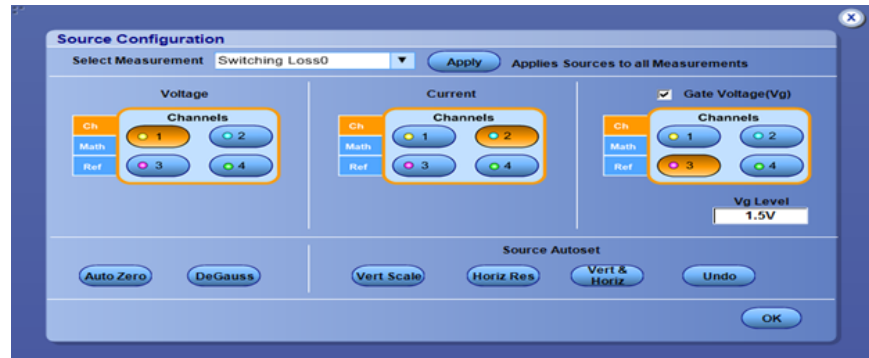

Figure 35: Switching Loss source configuration

2. In Case 3, select Switching Loss and select **Configure** > **OnOffLevel**

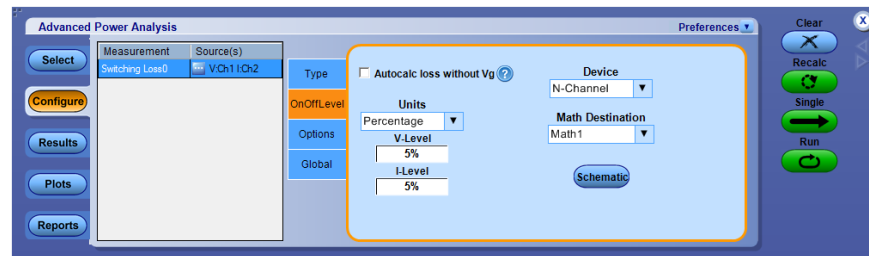

Figure 36: Switching Loss On and OnOff Level configuration

Set Units as Absolute in

- V-Level: Set the minimum V-Level above noise level on  $V_{ds}$  as shown in the Switching Loss On and OnOff Level configuration diagram
- I-Level: Set the minimum I-Level above noise level on  $I_{ds}$  as shown in the Switching Loss On and OnOff Level configuration diagram

- In case if  $V_g$  source has spikes, then the manual setting can be found as shown in Spike on  $V_g$  source.

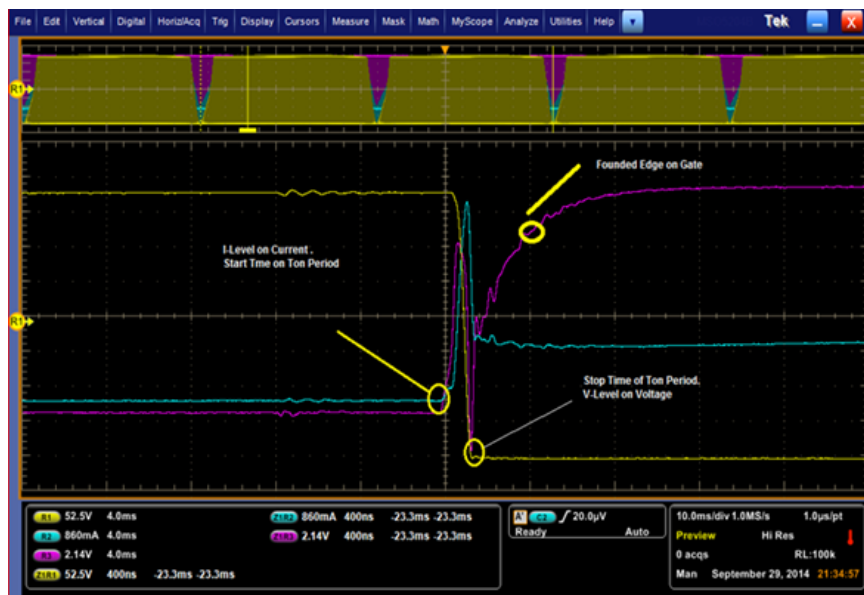

Figure 37: Spike on  $V_g$  source

Gate voltage  $V_g$  should be expected without any ringing and spike. The spikes gives incorrect edges. To avoid spikes as edges, use the **Options** configuration.

Select Units as **Absolute** and set Ref Level above the spike peak value. By default it is Percentage.

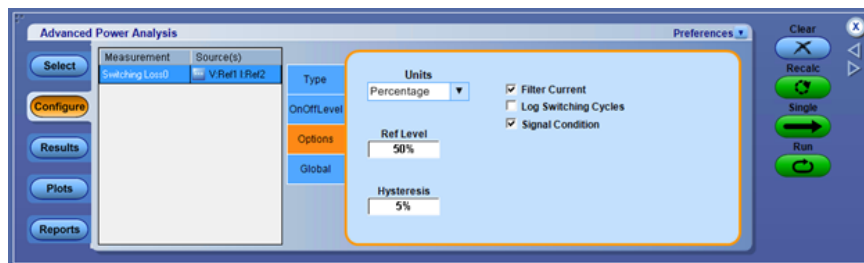

Figure 38: Switching Loss Edge configuration

- Run the measurement.

**Switching loss - PFC**

Power factor correction (PFC) is a special circuit used by SMPS to make the input current follow the sinusoidal shape of the AC input voltage, this helps to correct the power factor. There are two types of PFC, passive and active in nature.

The following waveforms show typical switching voltage, current and gate voltage scenario captured from electronic ballast.

You can observe that Switching Loss current at the start of operating frequency is almost zero and ramps up in envelope shape to higher current levels and starts reducing to zero level. So it is not possible to find edges with current waveform and we had to use gate voltage.

Gate voltage as a third source is recommended to find proper ON and OFF edge transitions because the switch voltage can vary in duty cycle and operating frequency as shown in the figure. Switch voltage can operate in both continuous conduction mode and discontinuous conduction mode.

The following figure shows 50 Hz captured switching voltage waveform bursts. The zoomed portion shows the transitions. Place cursors 1 and 2 such that one region is covered that is 100 Hz range.

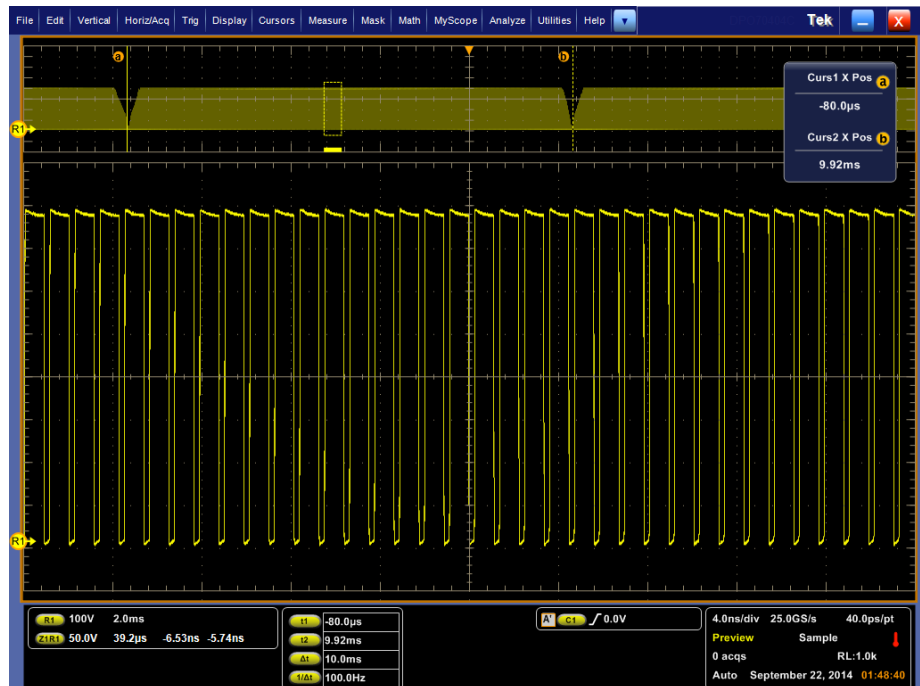

**Figure 39: Zoom-in of the VDS (Drain-Source) Voltage Switching cycles**

During turn on time, a spike appears as shown below in the current waveform. To have a more accurate analysis, a Gate voltage is recommended.

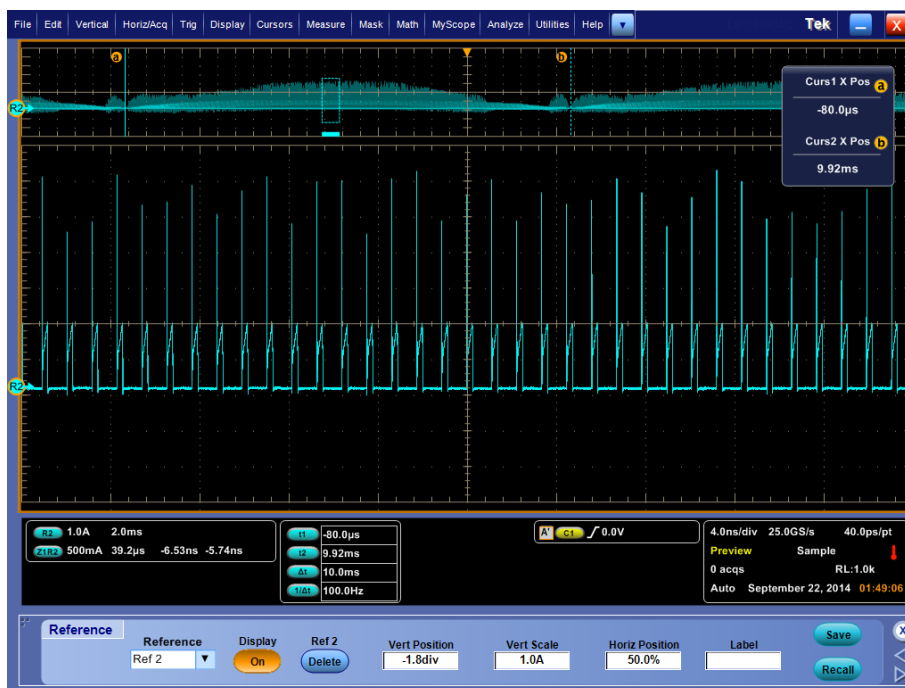

Figure 40: Zoom-in of the IDS (Drain-Source) Current Switching cycles

The current waveform is in-phase with the Gate voltage and the Gate voltage is ideally a pulse wave without ringing. If the gate voltage is noisy, it is recommended to set the edge REF levels in the **measurement > Configuration > Options** tab appropriately. The levels can be observed manually by using horizontal cursors.



Figure 41: Zoom-in of the (VG)Gate Voltage



Figure 42: VDS, IDS and VG overlapped



Figure 43: PFC Results



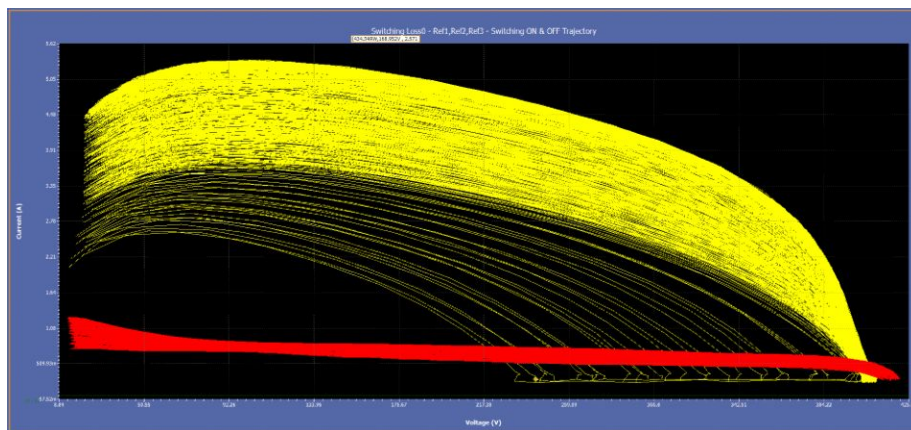
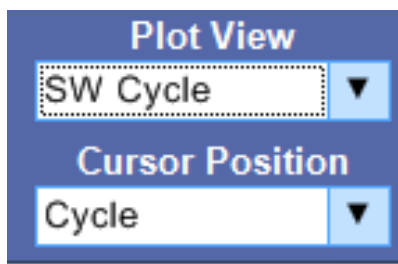

Figure 44: Typical PFC plot over many cycles

For PFC Switching Loss plot, select Details button on the Plots menu to display detailed Plot view options as below:

The Plot View drop-down has two options to select: All SW Cycle, SW Cycle.



When you select the SW Cycle drop-down, it will show four options: Cycle, OnLoss, OffLoss, ConductionLoss.

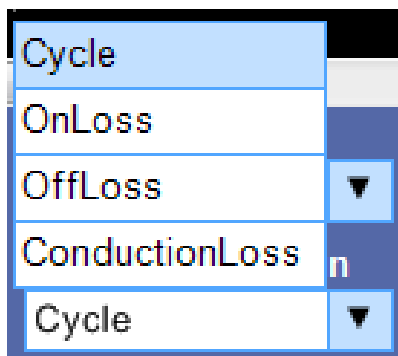

---

**NOTE.**

- *It is recommend to use "Cursor Position" in SW Cycle in case of noisy VG source and plot may not place the cursors properly.*
  - *It is recommend for Switching Loss measurement for PFC and other topologies to have at least 10 complete switching cycles to measure properly.*
- 

**Hi-Power finder**      The computation of TON, TOFF and Total loss for Hi-Power finder is same as Switching Loss measurements.

**Safe operating area**      This measurement has three options:

- SOA: Plots the graph of the voltage and current waveform.
- SOA X-Y (DPX): Invokes the oscilloscope's built in XY mode. This is applicable only for live channels.

**Results:** The voltage vs current graph (also known as SOA Plot) displays the value of voltage, current and power for a selected portion on the graph.

The occurrence field displays:

- The number of occurrences of the selected voltage and current position in the acquired waveforms
- Average power
- Standard deviation for the selected data point

The application calculates the Power Value using the following equation:

$$P_n = V_n I_n$$

Where:

$P_n$  is the instantaneous power value

$V_n$  is the voltage value

$I_n$  is the current value

$n$  is the sample at the particular point

The application calculates the Average Power using the following equation:

$$P_{Avg} = \frac{1}{N} \sum_{n=0}^{n=N} V_n I_n$$

Where:

$N$  is the number of samples which has the same value in the plot.

The application calculates the Standard Deviation using the following equation:

$$S_d = \frac{1}{N-1} \sqrt{\sum (x_i - \bar{x})^2}$$

Where:

$X_i$  is the Power Value

$X$  is the Mean Power

**RDS(on)** Dynamic resistance (RDS(on)) is the resistance offered by a switching device when it is in the ON condition. DPOPWR helps to monitor the dynamic resistance through V/I curve using oscilloscope built-in Math capability.

Place the cursor in the area of interest on resistance curve to get the resistance value.

**di-dt** di/dt measurement represents the rate at which the current changes during switching. The application uses the oscilloscope's built in math feature to provide a differentiation waveform of the current input.

When you run the measurement, the application calculates di/dt for the first edge by taking the default levels as 10% and 90% and displays the results.

Select a specific section of the waveform on the live signal by providing inputs for high and low levels in terms of percentage and absolute value of voltage and current. Select the edge of interest by viewing it visually on the oscilloscope. You can also enter the edge number on the results panel. The application displays the results for the selected edge and levels on the results panel.

The application calculates di/dt using the following equation:

$$\frac{di}{dt} = \frac{\sum(x_i - \bar{x}_i) \times (y_j - \bar{y}_j)}{\sum(x_i - \bar{x}_i)^2}$$

Where:

X=timing values

Y=Vertical values of the waveform data

**dv-dt** dv/dt represents the rate at which the voltage changes during switching. The application uses the math feature to provide a differentiation waveform of the voltage input.

When you run the measurement, the application calculates dv/dt for the first edge by taking the default levels as 10% and 90% and displays the results.

Select a specific section of the waveform on the live signal by providing inputs for high and low levels in terms of percentage and absolute value of voltage and current. Select the edge of interest by viewing it visually on the oscilloscope. You can also enter the edge number on the results panel. The application displays the results for the selected edge and levels on the results panel.

The application calculates dv/dt using the following equation:

$$\frac{dv}{dt} = \frac{\sum (x_i - \bar{x}_i) \times (y_j - \bar{y}_j)}{\sum (x_i - \bar{x}_i)^2}$$

where:

X = timing values

Y = Vertical (Voltage) values of the waveform data between the cursors.

## Timing analysis

This section explains the algorithm details of the following measurements which are part of Modulation Analysis:

- Pulse Width
- Period
- Duty Cycle
- Frequency

The application measures the signals on the complete cycles in the voltage waveform. All these measurements are related with the time locations of the edges in an acquisition. The result is displayed in graphical format in one of the reference memory selected as part of the setup of the measurement.

### Period and frequency

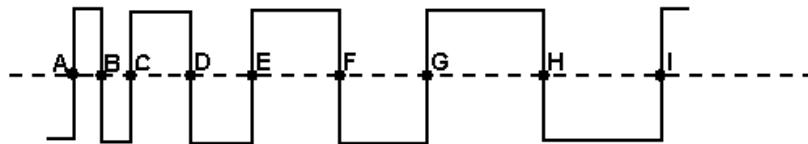

The above diagram is a sample period-modulated signal that explains period and frequency modulation. The annotations A to I in the above diagram represent the V ref mid crossing in an acquired waveform.

The application calculates the period and frequency using the following equation:

$$Frequency = \frac{1}{Period}$$

$$Period = (C - A) \text{ or } (E - C) \text{ or } (I - G)$$

Where:

A, B, C, D, E, F, G, H, I are the data points

### Pulse width and duty cycle

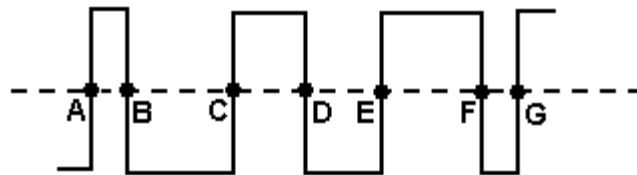

The above diagram is a sample pulse width-modulated signal that calculates the pulse width and duty cycle modulation. The annotations A to G in the above diagram represent the V ref Mid crossing in an acquired waveform.

You can also configure the positive or negative pulse width or duty cycle.

The application calculates the pulse width and duty cycle using the following equation:

$$PositivePulseWidth = (B - A) \text{ or } (D - C) \text{ or } (F - E)$$

$$NegativePulseWidth = (C - B) \text{ or } (E - D) \text{ or } (G - F)$$

$$PositiveDutyCycle = \frac{B - A}{C - A}$$

$$\text{NegativeDutyCycle} = \frac{C - B}{C - A}$$

Where:

A, B, C, D, E, F, G are the data points.

## Skew

This section explains the algorithm details of the following measurements which are part of Timing Analysis:

The Skew measurement calculates the difference in time between the designated edge on a principle waveform to the designated edge on another waveform.

The range limits where closest data edge to the clock edge falls is calculated by following equation:

$$T_n^{\text{Skew}} = T_n^{\text{Main}} = T_n^{\text{2nd}}$$

Where:

$T_n^{\text{Skew}}$  is the timing skew.

$T_n^{\text{Main}}$  is the main input VRefMidMain crossing time in the specified direction.

$T_n^{\text{2nd}}$  is the 2nd input VRefMid2nd crossing time in the specified direction.

n = 1 to number of edges.

## Magnetics

The Magnetics measurement displays  $I$  vs  $\int V$  and measures Inductance, Magnetic Property and Magnetic Loss. When using the integral of voltage, take care to check that the voltage 'V' does not have any DC components. Use the oscilloscope AC coupling to avoid any DC shifts on the integral of the voltage waveform. The application creates a single cycle by averaging multiple cycles of current and integrated voltage.

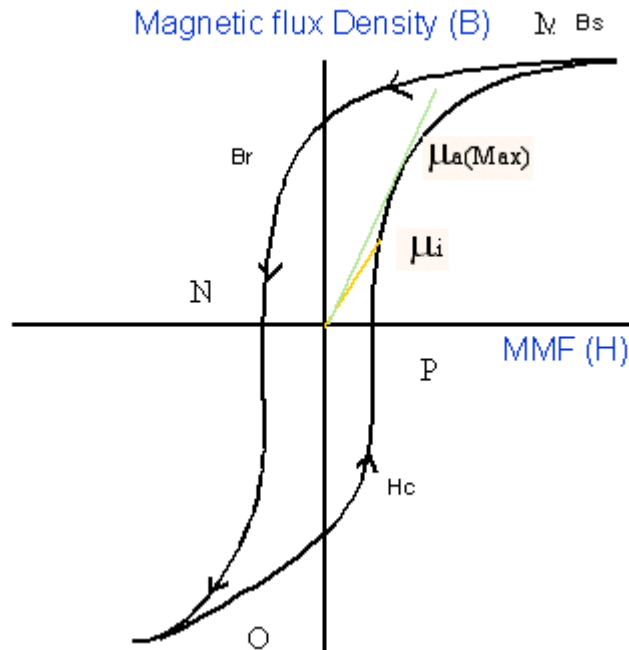

In the previous figure:

$B_s$  is the Saturation Flux Density

$B_r$  is the Remanence Flux Density

$H_c$  is the Coercive Force( $H_c$ )

$\mu_i$  is the Initial Permeability

$\mu_a$  is the Max Amplitude permeability

---

**NOTE.** The data waveform starts from the Max value of  $H$  and Decreases and increases again (  $M-N-O-P$  ).

---

**Magnetic Field Strength (H):** The previous figure shows the hysteresis in a typical magnetic material. The magnetic field induces a magnetic flux in the DUT. The units of measurement are Ampere/mtr in SI unit and Oersted in CGS unit.



**Saturation Flux Density (Bs):** The maximum magnetic flux density induced in the material regardless of the magnitude of the externally applied field H.

This is calculated on the maximum flux density cycle on the acquired waveform and let this be the Kth cycle on the acquired waveform.

$$B_s = \text{Max} ( B_k )$$

The Magnetic Field Intensity H is also calculated on the Maximum flux density cycle  $B_k$ .

$$B_s = \text{Max} ( B )$$

Index I where H is maximum

$$I = \text{Index of} ( \text{Max}(H) )$$

$$B_s = B(I) (2)$$

**Remanence (Br):** Is the Induced magnetic flux density that remains in the material after the externally applied magnetic field (H) is returned to zero during the generation of the Hysteresis loop.

Remanence also calculated on the kth cycle ( $B_k$ ) where the maximum flux density occurs in the entire acquired waveform.

Find the index at Zero value of H on the H waveform and calculate the maximum value of B from these indexes.

Let 'q' be the index at Zero value of H on H waveform. Let the q1 and q2 be the index of the waveform. Calculate the value of B at the Index q1 and q2 on the Kth cycle. The maximum magnitude value of B is the remanence Flux density.

**Coercive Force(Hc):** The value of H found at the intersection of the H-axis with the Hysteresis loop is the coercive force. This represents the external field required to cause the induced flux density (B) to reach zero during the measurement cycle of a Hysteresis loop. HC is symmetrical with positive and negative axis.

Coercivity Hc is also calculated on the kth cycle where the maximum flux density occurs in the entire acquired waveform.

Finding the index at Zero B value on the B waveform: Let 'q' be the index at Zero value of B on B waveform. Let q1 and q2 be the index on the B waveform where B is Zero.

The maximum magnitude of the H data at the index of q1 and q2 is the coercivity.

**Permeability:** It is the ratio of B and H calculated on the  $B_k$  cycle.

Select the points on the BH plot using the cursor and calculate the slope of the BH curve using the data selected between the cursor. You can chose the portion of the plot using the cursor to obtain the results.

Slope Calculation

There are N data points between the cursors

$$\text{Find } H_{av} = (H_1 + H_2 + \dots + H_n) / N$$

$$B_{av} = (B_1 + B_2 + \dots + B_n) / N$$

$$H_{normi} = H_i - H_{av}, i=1..N$$

$$B_{normi} = B_i - B_{av}, i=1..N$$

$$B/H = \frac{\text{SUM}(H_{norm1} * B_{norm1} + H_{norm2} * B_{norm2} + \dots + H_{normN} * B_{normN})}{\text{SUM}(H_{norm1} * H_{norm1} + H_{norm2} * H_{norm2} + \dots + H_{normN} * H_{normN})}$$

## Input analysis

**Power quality** The Power Quality measurement calculates the root mean square value for voltage, root mean square value for current, true power, apparent power, power factor, crest factor for voltage and crest factor for current.

The application calculates the RMS Voltage using the following equation:

$$RMS(v) = \sqrt{\frac{1}{N} \sum_{n=0}^{N-1} v^2(n)}$$

Where:

RMS(v) is voltage

N is the number of samples

n is the data point

v(n) is the absolute value of the voltage at the particular data point

---

**NOTE.** The voltage RMS is for all time domain cycles in the acquisition.

---

The application calculates the RMS Current using the following equation:

$$RMS(i) = \sqrt{\frac{1}{N} \sum_{n=0}^{N-1} i^2(n)}$$

Where:

i is current

N is the number of samples

n is the data point

i(n) is the absolute value of the current at the particular data point

The application calculates the True Power using the following equation:

$$\text{True/RealPower} = P_{\text{Real}} = \sum_{n=0}^{N-1} i(n)v(n)$$

Where:

N is the number of samples

n is the data point

The application calculates the Apparent Power using the following equation:

$$\text{ApparentPower} = P_{\text{Appar}} = \text{RMS}(v) * \text{RMS}(i)$$

Where:

RMS(v) is the root mean square of the voltage

RMS(i) is the root mean square of the current

The application calculates the Power Factor using the following equation:

$$\text{PowerFactor} = \frac{P_{\text{Real}}}{P_{\text{Appar}}}$$

Where:

P real is the real power

P appar is the apparent power

Crest factor is the ratio of the PK value of the signal to the RMS value of the signal. Use the following equation to calculate the crest factor for the voltage and current.

$$Cv = \frac{V_{pk}}{V_{RMS}}$$

Where:

Vpk is the peak value of the voltage

Vrms is the rms value of the voltage

$$Ci = \frac{I_{pk}}{I_{RMS}}$$

Where:

Ipk is the peak value of the current

Irms is the RMS value of the current

### Phase angle measurement

Phase Angle is the angle (-90 to +90) whose cosine is the true power factor. Unit of Phase Angle is degrees. The angle is positive if the Ch1 waveform (typically voltage) leads the Ch2 waveform (typically current). The angle is negative if the Ch1 waveform lags behind the Ch2 waveform.

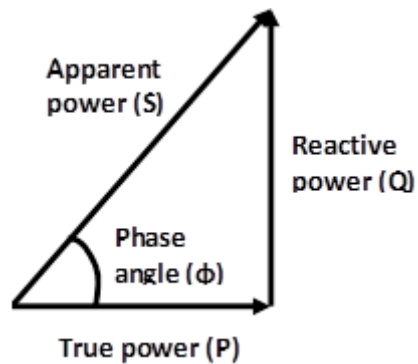

Power Quality, which provides a single table of measurements and measurement statistics for the AC input section of a power conversion circuit which includes:

- RMS voltage and current.
- True power (P) or the actual power delivered to the resistive part of the load, measured in Watts. It is also  $V_{RMS} * I_{RMS} * \cos(\phi)$ .
- Apparent power (S), the product of the RMS voltage and current (mathematically, the absolute value of the vector sum of the true and reactive power), measured in Volt-Amperes or VA.
- Reactive power (Q) or the imaginary power delivered to and temporarily stored in the reactive (inductive or capacitive) elements of the load, measured in units of Volt-Amperes-Reactive or VAR. It is also  $V_{RMS} * I_{RMS} * \sin(\phi)$ .
- Voltage and current crest factors, which are the peak-to-RMS ratios for the signals Frequency.
- Power factor, the ratio of true power to apparent power. (If the signals are pure sine waves, the power factor is the cosine of the phase angle between the current and voltage waveforms).

---

**NOTE.** *The phase angle can be easily derived from the other measurement results.*

- *Phase angle ( $\phi$ ), which is the angle between the real and apparent power vectors, equal to the impedance phase angle.*
  - *Mathematically,  $\cos(\phi) = P/S$  and  $\sin(\phi) = Q/S$ .*
- 

### Current/Voltage harmonics

Harmonics are sinusoidal voltages or currents having frequencies that are integer multiples of the frequency at which the supply system is designed to operate (termed the fundamental frequency). Distorted waveforms can be decomposed into a sum of the fundamental frequency and the harmonics.

Current/Voltage measurements follow the below steps to calculate harmonics:

1. It uses the Discrete Fourier Transform (DFT) to calculate real component(Re(k)) and imaginary component Im(k)

$$\text{Re}_{k_i} = \sum_{n=0}^{N-1} x(n) \times \cos\left(\frac{j2\pi nk}{N}\right)$$

$$\text{Im}_{k_i} = \sum_{n=0}^{N-1} x(n) \times \sin\left(\frac{j2\pi nk}{N}\right)$$

Where

$k_i$  = The index for the harmonics as per acquired recorded length (N)

$i = 1, 2, \dots$  Harmonic order (OH).

$k_i$  = Index of input line harmonic  $\times i$

$x(n)$  = The discrete set of acquire time samples

$\text{Re}_k$  = Real component of  $k^{\text{th}}$  harmonic

$\text{Im}_k$  = Imaginary component of  $k^{\text{th}}$  harmonic

2. Magnitude of frequency domain component

$$f_k = \sqrt{2 \times \left\{ \left( \frac{\text{Re}(k)}{N} \right)^2 + \left( \frac{\text{Im}(k)}{N} \right)^2 \right\}}$$

$f_k$  -  $k^{\text{th}}$  harmonic

Unit of  $f_k$  for voltage signal is volt and for current signal is ampere.

3. Harmonic is converted into dB using below equation

$$f_k^{dB} = 20 \times \log_{10} \left( f_{\text{Amp/Volt}}(k) \right) + 120$$

---

**NOTE.** In case of 'AM 14' standard, acquired signal is divided into 15 chunks and all harmonic are calculated for each chunk. For each individual harmonic maximum is taken out of 15 values.

---

RMS of harmonic is calculated from harmonic in unit of volt or ampere below formula:

$$\text{RMS} = \sqrt{f_1^2 + f_2^2 + \dots + f_{OH}^2}$$

$f_1$  = Fundamental harmonic or line harmonic

Total harmonic distortion ( $THD_F$ ) is measured as a ratio to the RMS value of the fundamental component of the source waveform. Reported as a percentage and calculated by below formula:

$$THD_F = \frac{\sqrt{RMS^2 - f_1^2}}{f_1} \times 100 \%$$

Total harmonic distortion ( $THD_R$ ) is measured as a ratio to the RMS value of the source waveform. Reported as a percentage and calculated by below formula:

$$THD_R = \frac{\sqrt{RMS^2 - f_1^2}}{RMS} \times 100 \%$$

### Phase calculation

Alternatively, the frequency domain can be expressed in polar form. In this notation, real ( $ReX[i]$ ) & imaginary ( $ImX[i]$ ) component in frequency domain are replaced with two other arrays, called the Magnitude of  $X[i]$ ,  $Mag X[i]$ , and the Phase of  $X[i]$ , written as:  $Phase X[i]$ . The magnitude and phase are a pair-for-pair replacement for the real and imaginary parts. For example,  $Mag X[0]$  and  $Phase X[0]$  are calculated using only  $ReX[0]$  and  $Im X[0]$ . Likewise,  $Mag X[14]$  and  $Phase X[14]$  are calculated using only  $ReX[14]$  and  $Im X[14]$ , and so forth. To understand the conversion, consider what happens when you add a cosine wave and a sine wave of the same frequency. The result is a cosine wave of  $A \cos(x) + B \sin(x) = M \cos(x + \Phi)$ .

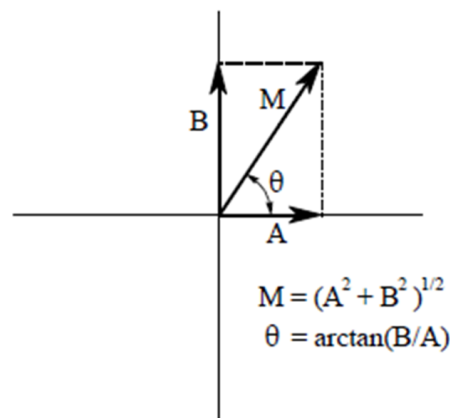

$$Mag[i] = \sqrt{ReX[i]^2 + ImX[i]^2}$$

Where:

$i$  = Index of harmonics

$RelX[i]$  = Real component of the harmonic (Cos frequency)

$ImgX[i]$  = Imaginary component of the harmonic (Sin frequency)

$$Phase[i] = \tan \frac{ImgX[i]}{RelX[i]}$$

If,  $RelX[i] < 0$  &  $ImgX[i] < 0$   $Phase[i] = Phase[i] - \pi$

If,  $RelX[i] < 0$  &  $ImgX[i] > 0$   $Phase[i] = Phase[i] + \pi$

---

**NOTE.** For "AM 14" standard phase values are shown in result of maximum amplitude value of harmonic.

---

### **Partial Odd Harmonic Current (POHC)**

For the 21<sup>st</sup> standard higher odd order harmonics, the average values obtained for each individual odd harmonic over the full observation period, calculated from acquired waveform. The measured partial odd harmonic current does not exceed the partial odd harmonic current which can be calculated from the applicable limits.

$$POHC = \sqrt{\sum_{k=21,23}^{OH} f_k^2}$$



**Total power quality** The algorithm for this measurement is a combination of the *Current harmonics* and *Power quality* algorithms.

**In-Rush current** Typical scenario to measure Peak Inrush current is when the switching power supply is first turned ON. Power converters have inrush currents much higher than their steady state currents, due to the charging current of the input capacitance. So we have devised a general measurement which can cater to all situations.

#### Algorithm:

The In-Rush current is measured for the region of interest and not on the entire waveform. The start region is defined as, when the waveform crosses the 'In-Rush threshold' to stop region where the current waveform again crosses this level. The measurement is automatic and identifies the In-Rush region algorithmically. However user can specify the inrush region by placing the scope cursors. The start and stop of In-Rush region depends on the threshold (Ref Level configuration) value which is used to identify region. Typically the start region is when the waveform crosses the threshold and stop region is identified where the current waveform again crosses the threshold.

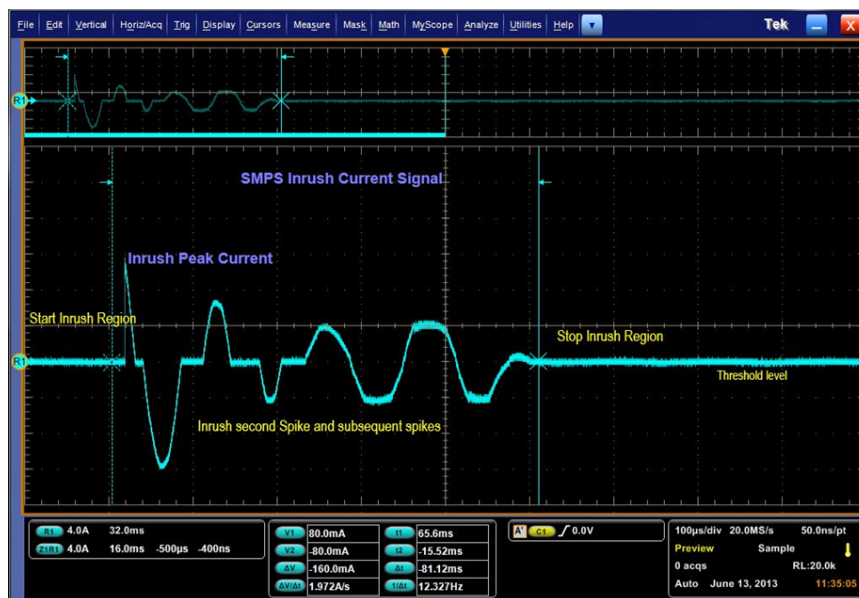

**Input capacitance**

The current waveform is used to compute the capacitance value. The application provides configuration to enter peak voltage values, so waveform is not require to acquire. The accumulated charge is computed using the trapezoidal integration of current samples taken from start to stop regions.

**Algorithm:**

$$Q = \int I_k$$

The charge,

Where:

K stands for current samples between start and stop index.

$$Q = CV$$

The capacitance is computed using the equation

$$C = Q/V$$

Hence capacitance in Farad is

**Output analysis**

**Ripple line and ripple switching**

The Ripple measurements display the ripple content in the signal. In Ripple Line, the time base is set to have three cycles of 50 Hz or 60 Hz in the input waveform. In Ripple switching, depending the switching frequency input sets the time base to display four cycles.

Depending upon the coupling type you select, the application sets the required offset and adjusts the vertical scale to the appropriate sensitivity. The application measures the peak-to-peak value and displays the result.

**Spectral analysis**

Spectral Analysis measures the magnitude of the signal over the specified frequency range by computing the Fast Fourier Transform.

The application calculates the two sided amplitude spectrum using the following equation:

$$\text{Amplitude spectrum in quantity peak} = \text{Magnitude [ FFT (A)]/N}$$

Where:

N = number of sampling points and

A is the signal

The application calculates the two sided amplitude spectrum using the following equation:

$$\text{Single sided Amplitude spectrum in volts rms} = 1.141 * \text{Magnitude [ FFT (A)]/N}$$

for i = 1 to N/2 -1

= Magnitude [FFT (A)]/N for  $i = 0(\text{DC})$

Where:

$i$  is the frequency line number of the FFT of A

Each frequency other than the DC is multiplied by 2 and the second half of the array is discarded.

Amplitude spectrum is closely related to the power spectrum. Single sided power spectrum is computed by squaring the single-sided rms amplitude spectrum.

The application calculates the single sided amplitude spectrum using the following equation:

$$Db = 20 \times \log_{10} [Mag(i) * \sqrt{2}] - 3dB$$

Where:

P is the measured power

Pr is the reference power

$$Db = 20 \log_{10} P/Pr$$

Where:

A is the measured amplitude measured in Decibel

Ar is the reference amplitude measured in Decibel

The application calculates the FFT using the following equation:

$$X(k) = \sum_{n=0}^{N-1} x(n) e^{-j 2\pi nk/N}$$

Where:

X (K) is the discrete Fourier transform of x computed using a Fast Fourier Transform algorithm.

x(n) is the discrete set of time samples

k is the index for the computed set of discrete frequency components

N is the number of samples considered

**Selecting RBW value.** Algorithm uses scope record length and selected ‘Stop’ frequency (*Selecting and configuring measurements-Spectral analysis*)

$$RBW(Hz) = \frac{F_{Stop}}{RL - 1}$$

Where,

FStop = Selected ‘Stop’ frequency in Spectral Configuration

RL – Scope Record length {2k, 5k, 10k, 20k, 50k, 100k, 200k, 500k, 1M, 2M };

**PoE Specific filter details.** Following table describes the settings of PoE Specific filters:

**Table 23: PoE filter settings**

Filter name	Filter type	Start frequency (Hz)	Stop frequency (Hz)	Window type
PoE 500 Hz	Low pass	0 Hz	500 Hz	Kaiser
PoE 500 Hz-150 KHz	Band pass	500 Hz	150KHz	Kaiser
PoE 150 KHz-500 KHz	Band pass	150 KHz	500KHz	Kaiser
PoE 500 KHz-1 MHz	Band pass	500 KHz	1MHz	Kaiser

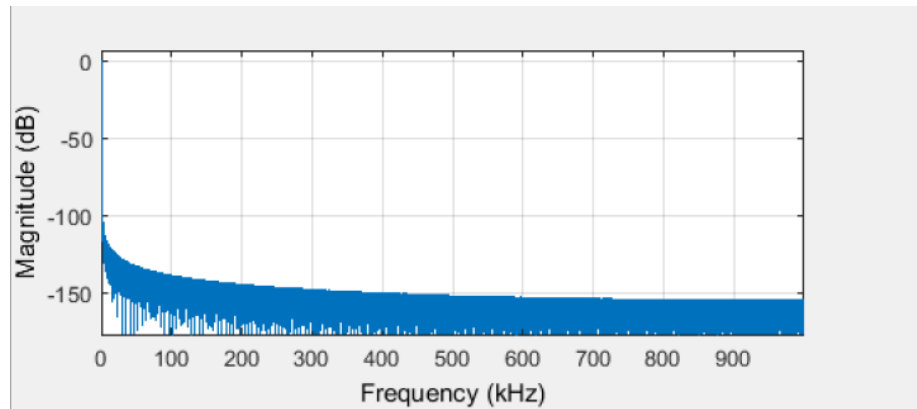

**Figure 45: POE150KTO500K**

**Turn-On time** Turn-On Time is the time taken to get the output voltage of the power supply after the input voltage is applied. DPOPWR provides an option of measuring three output signals concurrently in case of four channel oscilloscopes.

The application measures Turn-On Time with the following inputs.

You have to have the following inputs to measure Turn-On Time:

- Levels of all the channels voltages
- Maximum Turn-On Time

The application sets the vertical settings for the waveform to occupy at least two divisions. The horizontal settings are set according to the configuration inputs mentioned above.

## Amplitude

**High** The High Amplitude measurement calculates the mean or mode of a selected portion of each unit interval.

The application calculates this measurement using the following equation:

$$V_{\text{HIGH}(n)} = \text{Func}(V_{\text{percent}(n)})$$

Where:

$V_{\text{HIGH}(n)}$  is the high amplitude measurement result.

Func [ ] is the selected operation (either Mean or Mode).

$V_{\text{percent}(n)}$  is the region around the upper portion center of each cycle ranging from 1% to 100%.

n is the index of a high bit.

**Low** The Low Amplitude measurement calculates the mean or mode of a selected portion of each unit interval.

The application calculates this measurement using the following equation:

$$V_{\text{Low}(n)} = \text{Func}(V_{\text{percent}(n)})$$

Where:

$V_{\text{Low}(n)}$  is the low amplitude measurement result.

Func [ ] is the selected operation (either Mean or Mode). Mean method is the arithmetic average from the histogram for each cycle in entire acquisition. Mode method is the most commonly occurred value from the histogram for each cycle in entire acquisition.

$V_{\text{percent}(n)}$  is the region around the lower portion center of each cycle ranging from 1% to 100%.

n is the index of a high bit.

- High-Low** The High–Low measurement calculates the change in voltage level across a transition in the waveform.
- The application calculates this measurement using the following equation:
- $$V_{\text{High-Low}(n)} = \text{Func}(V_{\text{level}(i)} - V_{\text{level}(i+1)})$$
- Where:
- $V_{\text{High-Low}(n)}$  is the high-low amplitude measurement result.
- $i$  is the index of the first edge location of the acquired waveform.
- 
- Cycle min** Cycle min measures lower region of the waveform for all cycles. It is the minimum voltage for each cycle from the mid level of Fall to the Rise slope.
- $$V_{\text{CycleMin}} = \text{Min}(f(\text{FallIndex}(i) \text{ to } \text{RiseIndex}(i+1)))$$
- Where:
- $i = 1$  to the valid edge of the last cycle.
- $f$  is the function, which finds the minimum sample point in the defined region.
- 
- Cycle max** Cycle max measures upper region for all cycles. It is the maximum voltage for each cycle from the mid level of rise to the fall slope.
- The application calculates this measurement using the following equation:
- $$V_{\text{CycleMax}} = \text{Max}(f(\text{RiseIndex}(i) \text{ to } \text{FallIndex}(i+1)))$$
- Where:
- $i = 1$  to the valid edge of the last cycle.
- $f$  is the function, which finds the maximum sample point in the defined region.
- 
- Cycle peak-to-peak (Pk-Pk)** Cycle peak-to-peak measures the absolute difference between the maximum and minimum amplitude for every cycle of the waveform. The peak value is measured from fall slope to the next rise if the valid slope is a fall and the next peak would be from rise to next fall slope. The peak-to-peak value is calculated on all the pairs of minimum and maximum values available.
- The application calculates the Cycle Pk-Pk using the following equation:
- $$V_{\text{pk-pk}(n)} = \text{ABS}(V_{\text{CycleMax}} - V_{\text{CycleMin}})$$
- Where:
- $V_{\text{CycleMax}}(n)$  is the maximum peak amplitude.
- $V_{\text{CycleMin}}(n)$  is the minimum peak amplitude.
- $n$  is the number of cycles from 1 to the last valid edge.

---

# Appendix

## Appendix A

Use differential voltage and current probes to probe voltage and current signals in a switching power supply. Since these probes have active circuits, correct the DC offset errors. The DC voltage error adds to the test signal to display wrong results. The different propagation in differential voltage probes and current probes causes errors in time-correlated measurements and displays wrong power waveform measurements.

Follow the procedure below to eliminate these errors:

### For P5205 probe

1. Connect P5205 to Channel 1 of the oscilloscope.
2. Set the probe at 50X position.
3. Connect the + and - probe inputs to the same test point.
4. Set the coupling to DC.
5. Set the vertical sensitivity to maximum.
6. Check for no DC voltage offset on screen.
7. If there is a DC offset on the oscilloscope screen, use a small screwdriver and set "adjust offset" potentiometer at the BNC end of P5205, so that the DC voltage is zero.

### For TCP202 probe

1. Connect TCP202 to Channel 2 of the oscilloscope.
2. Close the TCP202 clamp.
3. Press degauss and release degauss button at the BNC connector of TCP202.
4. If DC offset is present on screen, use "Balance" at the BNC connector of TCP202 to adjust the DC current level to zero.

---

**NOTE.** P5205 and TCP202 are matched probes. You do not have to deskew these probes because they have the same propagation delay.

---

5. The test setup is ready to take power measurements.

## Appendix B

1. The application expects the data waveform in a nonequivalent time mode (ET) for its analysis. If the equivalent time mode is turned AUTO, the application switches off the equivalent time mode and measures the signal. The application does not display a warning message and the record length may vary according to the horizontal settings.
2. The application uses the reference memory and/or the math based on the measurement selected. The application does not display a warning message.
3. The application runs with a record length of 2M or less when measurement is selected with plots.
4. While measuring Power Dissipation, SOA and Magnetics, do not disturb the oscilloscope settings during the post analysis of the results. This leads to wrong interpretation of results.
5. Connect the current probe in the correct direction. If not, the application displays negative results for the inductance value.
6. Compensate the DC offset in the current probe and voltage probe. If not, the core loss result becomes negative or Peak Finder measurement displays improper cursor association.
7. Select the appropriate voltage and current channels according to the voltage and current probes connected to the channels. If not, the B-H curve is reversed and other measurements may provide wrong results.



---

# Glossary

## AC signal

A time-varying signal whose polarity varies with a period of time  $T$ , and whose average value is zero.

**Crest factor: cf** The ratio of the peak value to the rms value of an AC waveform measured under steady-state conditions. It is unit-less, and the ratio for a pure sine wave is equal to  $\sqrt{2}$ .

where  $V_{in}$  is the voltage at the user input terminals.

**dB** The abbreviation for decibels.

**Current probe(s)** A current probe is used to measure DC, AC, or composite currents. DC current probes should measure DC and composite currents to within  $\pm 1\%$  with a probe calibrator and  $\pm 3\%$  without the calibrator. AC current probes should measure AC currents to within  $\pm 5\%$ . This accuracy should be maintained up to the worst case expected peak current. Proper bandwidth should also be ensured.

**DC signal** A signal whose polarity and amplitude do not vary with time.

## Electrical power dissipation

The difference between the electrical input power to the UUT and its electrical output power, expressed in watts.

$$P_{diss} = P_{in} - \sum_i P_{o,i}$$

Alternatively, power dissipation is expressed as:

$$P_{diss} = P_{in} - \sum_i P_{o,i} = (1 - \eta)P_{in}$$

## Harmonics

Sinusoidal voltage or current components (distortion) of a periodic waveform which occur at a frequency that is an integer multiple of the fundamental frequency.

Most nonlinear loads generate odd-numbered harmonics, for example, as a result of full wave rectification of the input power. The frequencies at which these "characteristic harmonics" are produced by a user with an input rectifier can be determined by the equation:

$$f_H = (k \cdot q \pm 1) \cdot f_1$$

where

$f_H$  = the characteristic harmonic (for example, the "third harmonic" when  $H = 3$ );

$H$  = the number of the harmonic;

$k$  = an integer, beginning with 1;

$q$  = an integer, representing the number of rectifier commutations per cycle;

$f_1$  = the fundamental frequency.

Half wave rectification produces even-numbered harmonics that cause very undesirable results (for example, DC content) in the ac power system. Full wave rectification at the input of single-phase power loads results in ‘triplen’ harmonics at odd multiples of three times the fundamental frequency. These are also very undesirable, considering the potential quantity of single-phase loads and the fact that these harmonics interact with the distribution system’s normally high zero sequence impedance. User distortion current requirements are intentionally restrictive therefore for even and triplen harmonics.

**Power factor  
(displacement)**

For user equipment, the displacement power factor is equal to the cosine of the angle,  $\phi$ , between the input current and the input voltage at the fundamental frequency.

$$PF_{\phi} = \cos \phi$$

This definition of power factor does not include the effect of distortion in the input current (and/or voltage) waveform.

**Power, total or apparent**

The total or apparent power (S) is the product of rms voltage and current (VA).

**Power factor  
(displacement)**

For user equipment, the displacement power factor is equal to the cosine of the angle,  $\phi$ , between the input current and the input voltage at the fundamental frequency.

$$PF_{\phi} = \cos \phi$$

This definition of power factor does not include the effect of distortion in the input current (and/or voltage) waveform.

**Power factor (distortion)** The distortion power factor is defined as:

$$PF_{dt} = \frac{1}{\sqrt{1 + THD^2}}$$

where THD (Total Harmonic Distortion) is defined in 1.22.

This definition of power factor does not include effect of displacement.

**Power factor (true)** For user equipment, the true power factor is the ratio of the active, or real, power (P) consumed in watts to the apparent power (S) drawn in volt-amperes, with:

$$PF = P / S \quad \text{and}$$
$$S = \sqrt{P^2 + Q^2}$$

where

PF = power factor;

P = active power in watts;

Q = reactive power in vars;

S = total power in volt-amperes.

This definition of power factor includes the effect of both displacement and distortion in the input current (and/or voltage) waveform.

Alternatively, if there are no inter-harmonics, equation 7 can be simplified to

$$PF = PF_{dp} \cdot PF_{dt}$$

## In rush

A hot plug measurement of the maximum value or peak of the inrush current. Results of the measurement include peak power, energy during inrush, and duration of the inrush current.

## Input capacitance

Measures the capacitance using the voltage and current, by using the equation  $c=q/v$ .

where

c - capacitance in farad;

q - accumulated charge, which is integration of current waveform;

v - peak-peak voltage.

## RMS value (voltage)(voltage)

The square root of the average of the square of the value of the function taken throughout the period. For instance, the rms voltage value for a sinewave may be computed as:

$$V_{rms} = \sqrt{\frac{1}{T} \int_0^T v^2(t) dt}$$

where

T = waveform time period;

v(t) = instantaneous voltage at time t;

$V_{rms}$  = rms voltage value.

**Total harmonic distortion** The ratio, expressed as a percent, of the rms value of the ac signal after the fundamental component is removed and inter-harmonic components are ignored, to the rms value of the fundamental. The formula defining total harmonic distortion (THD) is provided in equation (7). The variables 'X<sub>1</sub>' and x<sub>n</sub> may represent either voltage or current, and may be expressed either as rms or peak values, so long as all are expressed in the same fashion.

$$THD_x = \frac{\sqrt{\sum_{n=2}^{\infty} x_n^2}}{X_1} \cdot 100\%$$

Where:

X<sub>1</sub> = Fundamental value of current or voltage;

x<sub>n</sub> = n th harmonic value of current or voltage.

## Transfer impedance

The output voltage divided by the input current while the output is delivering rated current.

**Hysteresis** The difference between the threshold voltage for the UVLO and the threshold voltage for turn-on.

**V max input** The maximum allowable input voltage rating at which UUT can operate to specifications.

**V min input** The minimum allowable input voltage rating at which UUT can operate to specifications.

**V nom input** The stated or objective value of the input voltage, which may not be the actual value measured. The value should be between the minimum and maximum input value.

**Voltage probe** A connecting device, usually consisting of a two-conductor shielded cable and frequency-compensating network, with a hand-held tip, for use with an oscilloscope to measure the amplitude and waveshape of a DC, AC or a composite signal. It should include a ground reference. The measurement bandwidth should be at least 10 times greater than the frequency of interest. The impedance should be at least 50 times greater than the node impedance under measurement. A low impedance probe should be used for measurement purposes.

# Additional topics

## Current harmonics bar graph results

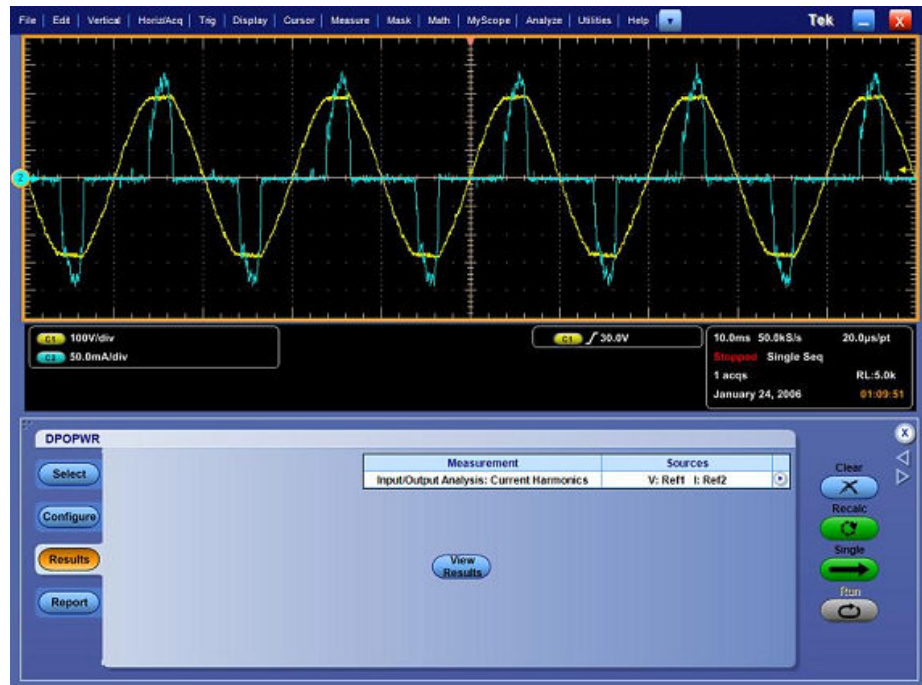

Select the Save button to save the bar graph to the default location C:\Program Data\Tektronix\TekApplications\Advanced Power Analysis\Images or any other location of your choice.

## File menus

There are no parameters for the File menu items.

## Configuration parameter specifications

Measurement/ Sub Type	Menu	Minimum	Maximum	Default	Resolution	Units
Common Configuration	I-Probe Settings> Transfer Impedance	0.001	10	0.5	0.001	$\Omega$
Common Configuration	I-Probe Settings> Custom Scale Factor	100p	10G	1	1	NA
Common Configuration	I-Probe Settings> Custom Propagation Delay	0	150n	0	1n	s
Power Dissipation	RDS On	0	100	20m	0.0001	$\Omega$
	VCE Sat	100m	50	2	0.1	V
	Edge Levels					
	Hysteresis percentage	5	40	10	1	%
	Ref Level percentage	10	90	50	1	%
	Hysteresis absolute	0	3000	5	0.001	V
	Ref Level absolute	-5999	5999	50	0.001	V
	V Level percentage	1	90	5	1	%
	I level percentage	1	90	5	0	%
	V level absolute	-5999	5999	5	0.001	V
	I Level absolute	-100	100	1	0.001	A
	Vg Level	-100	100	1.5	0.1	V
	Magnetics	Hysteresis percentage	5	40	10	1



Measurement/ Sub Type	Menu	Minimum	Maximum	Default	Resolution	Units
	Ref Level percentage	10	90	50	1	%
	Hysteresis absolute	0	3000	150m	0.001	V
	Ref Level absolute	-5999	5999	5	0.001	V
	Num of Turns	1	1M	1	1	NA
	Cross section area-SI	1u	1M	1	1u	m <sup>2</sup>
	Length-SI	1u	1M	1	1n	m
	Cross section area-CGS	1un	1M	1	1n	cm <sup>2</sup>
	Length-CGS	1un	1M	1	1n	cm
Current Harmonics	Ampere Value (in Harmonic Table Editor)	0	10	0	0.00001	A
	Ratio (In Impedance table Editor)	0.001	2	0	0.001	NA
	A14 Input Power (for Class C and Class D only )	0	600	100	10m	W
	A14 Power Factor (for Class C Only)	0	1	1	10m	NA
	A14 Fundamental Current (for class C only)	0	16	16	10m	A
Switching Ripple	Switching Frequency	50	1M	10K	1	Hz
Turn on Time	Maximum Line Voltage	1	500	230	1	V
	Voltage 1 Maximum Value	- 5999	5999	5	0.01	V

Measurement/ Sub Type	Menu	Minimum	Maximum	Default	Resolution	Units
	Voltage 2 Maximum Value	- 5999	5999	5	0.01	V
	Voltage 3 Maximum Value	- 5999	5999	5	0.01	V
	Maximum Turn-on	1u	5	200m	1u	s
	Custom Frequency for AC-DC	50	1M	50	1	Hz
	Trigger Voltage	1	500	230	1	V
Utilities> Deskew	From Ref Level	0	100	50	1	%
	From Hysteresis	0	25	5	1	%
	To Ref Level	0	100	50	1	%
	To Hysteresis	0	25	5	1	%
	Edges	1	100	1	1	NA

Measurement/ Sub Type	Menu	Minimum	Maximum	Default	Resolution	Units
Pulse Width, Duty Cycle, Period, Frequency						
Absolute Ref Level	Ref Level	-5999	5999	0	0.001	V
Absolute Hysteresis	Ref Level	0	3000	6	0.001	V
Percentage Ref Level	NA	1	99	50	1	%
Percentage Hysteresis	NA	0	50	3	1	%
SOA						
SOA Mask Editor	Y Max	(-40K)	5K	10		A
	Y Min	(-40K)	5K	0		A
	X Max	(-40K)	40K	500	1m	V
	X Min	(-40K)	40K	0	1m	V
SOA Overlay	Y Max	-40	5	10		A
	Y Min	-40	5	0		A

Measurement/ Sub Type	Menu	Minimum	Maximum	Default	Resolution	Units
	X Max	-40	5	500		V
	X Min	-40	40Kv	0		V
Spectral Analysis						
Start Frequency	NA	0	499 M 299 M for TDS5032, TDS5034	50	5	Hz
Stop Frequency	NA	50	500 M 499 M for TDS5032, TDS5034	1000	5	Hz
PoE Filter						

Measurement/ Sub Type	Menu	Minimum, Maximum
SOA Plot	Cursor Position	Dynamic depending on results
Power Energy Power Finder results	Peak Count	Dynamic depending on results
	Occurrence	Dynamic depending on results
Core Saturation Plot	Cursor Position	Dynamic depending on results

Measurement/ Sub Type	Minimum	Maximum	Default	Resolution	Units
<b>di/dt configuration</b>					
Ref Level in Amps	-999	999	5	0.001	A
Hysteresis in Amps	0	3000	150m	0.001	A
Ref Level in percentage	1	99	50	1	%
Hysteresis in percentage	5	50	10	1	%
<b>dv/dt configuration</b>					
Ref Level in Volts	-5999	5999	5	0.001	V
Hysteresis in Volts	0	3000	150m	0.001	V
Ref Level in Percentage	-5999	5999	50	1	%
Hysteresis in Percentage	5	50	10	1	%

Measurement/Sub Type	Menu	Minimum	Maximum	Default	Resolution	Units
<b>di/dt results</b>						
Ref Level in Amps	High	-999	999	10	0.001	A
	Low	-999	999	1	0.001	A
Ref Level in percentage	High	1	99	90	1	%
	Low	1	99	10	1	%
<b>dv/dt results</b>						
Ref Level in Volts	High	-5999	5999	10	0.001	V
Ref Level in Volts	Low	-5999	5999	1	0.001	V
Ref Level in Percentage	High	1	99	90	1	%
Ref Level in Percentage	Low	1	99	10	1	%
Edge Number	Dynamic depending on results					NA

## SOA plot functionality

The zero reference line in green represents the X and Y values where X is the current and Y, the voltage. This appears if zero values occur in SOA measurement. The horizontal zero reference line appears if the horizontal value is zero and a vertical reference line appears if the vertical value is zero. If the X and Y axis have zero value, it is represented by (0,0). The input is the X and Y waveform and the output is the plot.

**Dot Connect Feature:** You can connect successive data points in a plot. You can identify when a single data is spread sparingly on the plot area. This feature is not available in Zoom In or Zoom Out mode.

**Link:** Select the Link button to link the data points. When you link the data points, the application automatically resizes the plot to the half screen.

**Reset:** Use the Reset button to reset the zoomed plot to its original state.

**Saving the Plot:** Use the Save button to save the XY plot. This will save the plot area in .jpeg format in the default directory C:\User\Public\TekApplications\DPOPWR\Images.

**Zoom In, Zoom Out:** Select the Zoom control buttons to enable the Zoom buttons. You can zoom in/out the data Points on the XY plot with a single mouse click on the plot area. Draw a rectangle on the plot to select the portion you want to zoom. This zooms the selected area.

## Setting up the application and taking measurements

To set up the oscilloscope follow these steps:

1. You must warm up the oscilloscope for twenty minutes before you can start to take measurements.
2. You must run the compensation signal path on the oscilloscope.
3. You must make sure that the default factory setups are recalled before you start using the application in the oscilloscope. To do so, push the recall default setup button on the front-panel of the oscilloscope to recall the default factory settings.
4. You should always use calibrated probes and degauss the current probes.

## I-Probe settings-AM503S settings configuration

If you are using an AM503S series probe, select the AM503S Settings button and use the drop-down arrow in the Probe Type field to select the probe type. Select the Range value from the drop-down list to display the range of the selected probe in the Probe Type field. Select OK to return to commit the change.

## View recall waveform from the oscilloscope

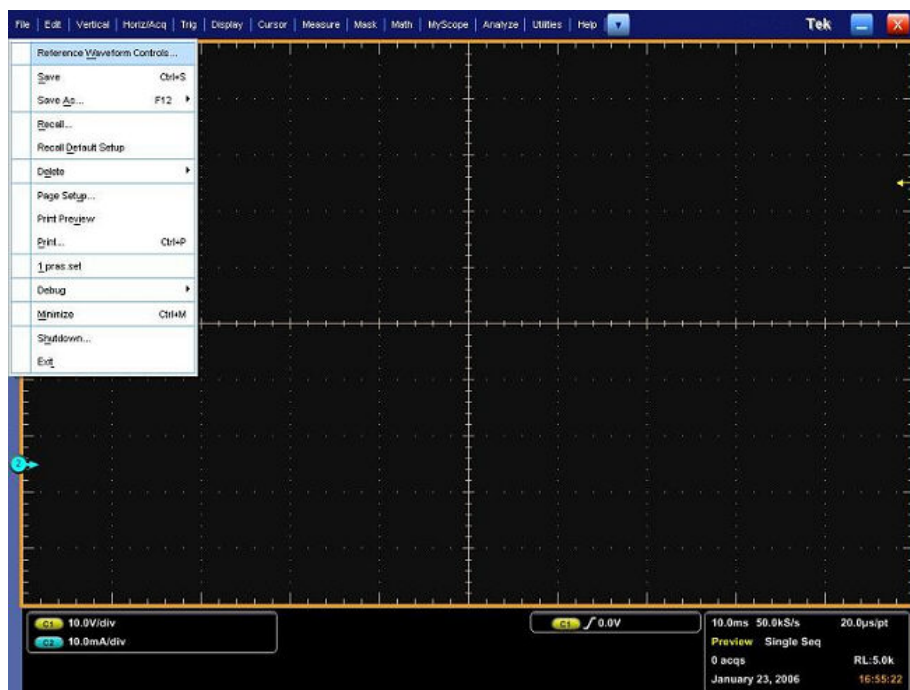



# Index

## A

- About application examples, 203
- About Application Parameters, 264
- About Basic Operations, 13
- About taking new measurements, 43
- AC Signal, 323
- Amplitude
  - cycle max, 320
  - cycle min, 320
  - cycle peak-to-peak, 320
  - high, 319
  - high-low, 320
  - low, 319
- Analyze Switching Loss, 205
- Appendix, 321
- Application Directories and File Names, 14
- Application Interface, 13
- Auto Zero, 17
- Autocalc loss without Vg, 71
- Autoset, 60

## C

- Configuring edges, 65
- Configuring global settings, 64
- Configuring options, 65
- Control panel, 66
- Conventions, 4
- Current Harmonics, 311
- Current probes, 9
- Current Transient Response, 302

## D

- Degauss, 17
- Deskew Real Time, 25
- Deskewing in DPO7000 series Oscilloscope, 25
- Deskewing Probes and Channels, 19
- Deskewing using a fixture, 27
- di/dt, 302
- dv/dt, 302

## E

- Edges
  - configuring, 65

- Electrical Power Dissipation, 324
- Equipment setup guidelines, 285

## F

- Feedback
  - techsupport, 4
- File Menus, 330
- Functionalities of the XY Plot, 334

## G

- General Safety Summary, 1
- Global settings, 64
- Glossary, 323
- GPIB command
  - accumulated results
    - DPOPWR:MEAS<x>:ACCMAX?, 216
    - DPOPWR:MEAS<x>:ACCMEAN?, 217
    - DPOPWR:MEAS<x>:ACCMIN?, 217
    - DPOPWR:MEAS<x>:ACCPKTOPk?, 218
    - DPOPWR:MEAS<x>:ACCPOPULATION?, 218
    - DPOPWR:MEAS<x>:ACCRRESULT?, 219
    - DPOPWR:MEAS<x>:ACCSTDDEV?, 219
  - add measurements
    - DPOPWR:ADDMEAS, 211
  - current results
    - DPOPWR:MEAS<x>:CURRENTMAX?, 224
    - DPOPWR:MEAS<x>:CURRENTMEAN?, 224
    - DPOPWR:MEAS<x>:CURRENTMIN?, 225
    - DPOPWR:MEAS<x>:CURRENTPKTOPk?, 225
    - DPOPWR:MEAS<x>:CURRENTPOPULATION?, 226
    - DPOPWR:MEAS<x>:CURRENTRESULT?, 226
    - DPOPWR:MEAS<x>:CURRENTSTDDEV?, 227
  - error
    - DPOPWR:LASTERROR, 216

## general

- DPOPWR:CLEARALLMeas, 214
- DPOPWR:FREerun, 214
- DPOPWR:MEAS<x>:CUSTomname?, 227
- DPOPWR:MEAS<x>:NAME?, 229
- DPOPWR:MEAS(x):SELECTMEAS, 230
- DPOPWR:MEAS(x):SOURCEAPPLYAll, 230
- DPOPWR:RECalc, 233
- DPOPWR:SELECTEDMEAS?, 233
- DPOPWR:SINGle, 234

## global configure

- DPOPWR:MEAS<x>:ACQmode, 220
- DPOPWR:MEAS<x>:BWLlimit, 222
- DPOPWR:MEAS<x>:COUPling, 223
- DPOPWR:MEAS<x>:CURGATing, 223

## plots

- DPOPWR:CLEARALLPlots, 214
- DPOPWR:MEAS<x>:ADDPLOT, 220

## report

- DPOPWR:GENREPAS, 215
- DPOPWR:GENREPort, 215

## source autoset

- DPOPWR:MEAS<x>:SOURCEAutoset, 231

## source selection

- DPOPWR:MEAS<x>:GATESOURce, 228
- DPOPWR:MEAS<x>:ISOURce, 229
- DPOPWR:MEAS<x>:VSOURce, 232

**H**

Harmonics, 324

Hi-Power finder Ton and Toff levels, 87

Hi-Power finder type, 86

**I**

I-Probe Settings-AM503S Settings Configuration, 335

In Rush, 327

Input Capacitance, 327

Installing the application, 12

Introduction and Product Description

Installing the Application, 7, 12

Requirements and Restrictions, 9

Introduction to the Tutorial, 195

iProbe, 19

**M**

Magnetic loss, 131

Magnetics, 306

Measure Magnetic Loss, 207

Measure Switching Loss, 203

Measuring Magnetics, 199

Measuring Power Dissipation, 197

**O**

Online Help and Related documentation

- Conventions, 3

- Customer Feedback, 3

Options

- Configuring, 65

**P**

Power factor correction (PFC), 296

Power Quality, 308

Preferences dialog, 19

Printing from the Online Help, 3

**R**

RDS(on), 302

Real time deskew, 25

Recalling a Saved Setup, 16

Recalling the Default Setup, 16

Related documentation, 4

Reports, 54

Requirements and Restrictions, 9

Returning to the Application, 15

Ripple Line and Ripple Switching, 316

RMS Voltage, 327

**S**

Safe Operating Area, 300

Saving a Setup, 15



Select and configure measurement - Amplitude high-low, 193

Select and configure measurement - cycle peak-to-peak, 185

Selecting a measurement, 57

Selecting and configuring measurements

- Spectral analysis, 169
- Turn-on time, 177

Selecting and Configuring Measurements

- di/dt, 94

Selecting and configuring measurements - amplitude high, 188

Selecting and configuring measurements - amplitude low, 190

Selecting and configuring measurements - cycle max, 182

Selecting and configuring measurements - cycle min, 179

Selecting and configuring measurements-Line ripple, 167

Selecting and configuring measurements-Power quality, 135

Selecting and configuring measurements-Switching ripple, 175

Setting up the application, 29

Setting Up the Application and Taking Measurements, 335

Setting Up the Oscilloscope, 196

Setting up the software, 29

Source selection panel, 58

Spectral Analysis, 317

Starting the Application, 196

Switch mode power supply, 277

Switching loss options, 72

Switching loss TOn and TOff levels, 70

## T

Timing analysis

- modulation measurements, 303
- time measurements, 305

Total Power Quality, 315

Transfer Impedance, 328

Troubleshooting Spectral Analysis, 174

Turn-On Time, 319

## U

Updates through the web site

- Readme, 12

Utilities Menu, 273

## V

View measurement result - amplitude high, 189

View measurement result - amplitude high-low, 194

View measurement result - amplitude low, 192

View measurement result - cycle max, 184

View measurement result - cycle min, 181

View measurement result - cycle peak-to-peak, 187

Viewing plots, 51

Viewing results

- accumulated, 43
- detailed, 43
- Input capacitance, 166
- more, 43
- Spectral analysis, 173
- Turn-On Time, 178

Viewing Results, 43

Viewing results-Current harmonics, 145

Viewing results-di/dt, 95

Viewing results-Duty cycle, 113

Viewing results-dv/dt, 98

Viewing results-Frequency, 117

Viewing results-I vs  $\int V$ , 133

Viewing results-In rush current, 164

Viewing results-Inductance, 123

Viewing results-Line ripple, 168

Viewing results-Magnetic loss, 132

Viewing results-Magnetic property, 129

Viewing results-Period, 115

Viewing results-Power quality, 137

Viewing results-Pulse width, 111

Viewing results-RDS(on), 92

Viewing results-Safe operating area, 102, 108

Viewing results-Skew, 120

Viewing results-Switching ripple, 176

Viewing results-Total power quality, 159

Viewing results-voltage harmonics, 152

Voltage Harmonics, 311

Voltage probes, 10

**W**

Welcome

Installation Procedures, ix  
Product Description, ix  
Using Online Help, ix