



DPOJET
Jitter, Noise and Eye Diagram Analysis Solution
Printable Application Help





DPOJET
Jitter, Noise and Eye Diagram Analysis Solution
Printable Application Help

Supports DPOJET Software V1.0 and above

www.tek.com
077-0048-26

Copyright © Tektronix. All rights reserved. Licensed software products are owned by Tektronix or its subsidiaries or suppliers, and are protected by national copyright laws and international treaty provisions. Tektronix products are covered by U.S. and foreign patents, issued and pending. Information in this publication supersedes that in all previously published material. Specifications and price change privileges reserved.

TEKTRONIX and TEK are registered trademarks of Tektronix, Inc.

Contacting Tektronix

Tektronix, Inc.
14150 SW Karl Braun Drive
P.O. Box 500
Beaverton, OR 97077
USA

For product information, sales, service, and technical support:

- In North America, call 1-800-833-9200.
- Worldwide, visit www.tek.com to find contacts in your area.

Table of Contents

Welcome	xix
---------------	-----

Introduction to the application

Free trials	1
Related documentation	2
Conventions	2
Technical support	3
Customer feedback	3

Getting started

Product description	5
DPOJET option levels	6
Compatibility	8
Requirements and restrictions	8
Supported probes	8
Installing the application	9
About DPOJET	9

Operating basics

About basic operations	11
Starting the application	11
Application interface menu controls	11
Virtual keypad	12
Tips on DPOJET user interface	12
Basic oscilloscope functions	13
Application directories	13
File name extensions	14
Application menu shortcuts	14
Returning to the application	15
Warning log notifiers	15
Saving and recalling setups	16
Saving a setup	16
Recalling a saved setup	16
Recalling the default setup	17

Jitter, Noise and Eye Diagram Analysis

About Jitter, Noise and Eye-diagram analysis	19
Setting up DPOJET to take measurements	21
Setting up the application for analysis	21
Deskew for accurate measurement	22
Selecting a measurement	24
Table of measurements-Period/Freq	26
Table of measurements-Jitter	26
Table of measurements-Noise	29
Table of measurements-Time	30
Table of measurements-Eye	31
Table of measurements-Amplitude	33
Table of measurements-Standard	34
Test point selection in the standard tab	37
Configuring measurements	38
About configuring a measurement	38
General	39
Global	40
Filters	46
Clock recovery	52
Bit config	70
BER	81
RJ-DJ	82
RN-DN	85
Bus state	88
Edges	90
SSC	105
Margin	105
DFE	106
General configuration (DPOJET)	108
One touch jitter	108
Serial Data/Jitter guide	111
Source configuration	120
Preferences setup	140
Export data and measurement	148
Data logging	152
Sequencing	162
Limits	163

Measurement summary	167
Results as statistics	170
Viewing statistical results	170
Export results to ref waveform	174
Bit rate and pattern length detection	176
Result as plots	177
About plots	177
Plot usage	179
Selecting plots	182
Configuring plots	183
Viewing plots	201
Reports	205
About reports	205

Tutorial

Introduction to the tutorial	211
Setting up the oscilloscope	211
Starting the application	212
Waveform files	212
Recalling a waveform file	212
Taking a period measurement	213
Taking a TIE measurement	215
Taking an eye height and width measurement	216
Summary tutorial	217
Stopping the tutorial	219
Returning to the tutorial	219

Parameters

About parameters	221
Measurement select parameters	221
Autoset parameters	223
Ref level menu parameters	223
Preferences parameters	224
Deskew parameters	225
Data logging parameters	226
Control panel parameters	227
Configure measurement parameters	227
Bit config parameters	227

BER parameters	228
Edges parameters	228
Clock recovery parameters	230
SSC parameters	233
RJ-DJ analysis parameters	233
RN-DN analysis parameters	233
Filters parameters	234
Bus state	234
General parameters	235
Global parameters	235
Margin parameters	236
DFE parameters	236
Plots	236
Histogram plot parameters	236
Eye diagram plot parameters	237
Spectrum plot parameters	237
Time trend plot parameters	237
Phase noise plot parameters	238
Bathtub plot parameters	238
Transfer function plot parameters	238
Composite jitter histogram plot parameters	238
Noise bathtub plot parameters	239
BER Eye contour plot paramters	239
Composite noise histogram plot parameters	239
BER Eye plot parameters	240
Correlated Eye plot parameters	240
PDF Eye plot parameters	240
Reports	240

Reference

Progress bar status messages	243
Breakdown of jitter (Jitter map)	246
Breakdown of noise (Noise map)	248
Error codes	250
Measurement range limit values	255
Measurement units	260
Custom mask file requirements	261
Correlation of measurement to configuration	262

Algorithms

About algorithms	271
Period/Freq measurements	271
Period	271
Positive and negative width	272
Frequency	273
N-Period	273
Positive and negative duty cycle	274
CC-Period	275
Positive and negative CC duty	275
Data rate	275
Jitter measurements	276
TIE	276
RJ	276
RJ(h)	277
RJ(v)	277
Dual dirac random jitter	277
Jitter summary	277
TJ@BER	278
DJ	278
Dual Dirac deterministic jitter	278
Phase noise	278
PJ	278
PJ(h)	278
PJ(v)	279
NPJ	279
DDJ	279
DCD	279
J2	279
J9	280
SRJ	280
F/N	280
PJrms	281
SJ@Freq	282
Clock Pk-Pk	282
Noise measurements	282
TN@BER	282
RN	283

RN(v)	283
RN(h)	283
DN	283
PN	283
PN(v)	284
PN(h)	284
DDN(0)	284
DDN(1)	284
DDN	285
NPN	285
Unit Amplitude	285
Noise summary	286
Timing measurements	286
Rise time	286
Fall time	286
Skew	287
High time	287
Low time	287
Setup	288
Rising Slew Rate measurement algorithm	288
Fall slew rate	289
Hold	290
SSC profile	290
SSC MOD rate	291
SSC FREQ DEV MIN	291
SSC FREQ DEV MAX	291
SSC FREQ DEV	291
tCMD-CMD	292
Time Outside Level measurement algorithm	292
Eye diagram measurements	293
Eye width	293
Width@BER	293
Eye height	293
Height@BER	294
Eye high	295
Eye low	295
Q-factor	296
Mask hits	297
Autofit mask hits	297

V-Widest Open Eye	297
DFE eye height	298
DFE eye width	298
DFE eye diagram	298
Amplitude measurements	299
High	299
Low	299
DC common mode	300
AC common mode	300
T/nT ratio	301
High-Low	302
V-Diff-Xovr	303
Overshoot	304
Undershoot	304
Cycle max	305
Cycle min	305
Cycle Pk-Pk	305
Standard-Specific measurements	306
PCIe T-Tx-Diff-PP	306
PCIe T-TX	307
PCIe T-Tx-Fall	307
PCIe Tmin-Pulse	308
PCIe DeEmph	308
PCIe T-Tx-Rise	308
PCIe UI	309
PCIe Med-Mx-Jitter	309
PCIe T-RF-Mismch	309
PCIe MAX-MIN ratio	310
PCIe SSC PROFILE	311
PCIe SSC FREQ DEV	311
PCIe AC common mode	311
USB VTx-Diff-PP	311
USB TCdr-Slew-Max	312
USB Tmin-Pulse-Tj	313
USB Tmin-Pulse-Dj	313
USB SSC MOD RATE	313
USB SSC FREQ-DEV-MAX	314
USB SSC FREQ-DEV-MIN	314
USB SSC PROFILE	314

USB UI	314
USB AC common mode	315
Average optical power	315
Extinction ratio	315
Optical modulation amplitude	315
Optical high	315
Optical low	316
Eye Crossing Level	317
Eye Crossing Time	318
Eye Crossing Percent	318
Mask Hit Ratio	318
Mask Margin	318
Jitter separation	319
Jitter analysis through RJ-DJ separation	319
RJ-DJ separation via spectrum analysis	320
RJ-DJ separation for arbitrary patterns	320
Separation of Non-Periodic jitter (NPJ)	321
Estimation of TJ@BER and eye Width@BER	321
Jitter estimation using Dual-Dirac models	322
Joint Jitter/Noise analysis	323
Differences between Jitter-Only and Jitter+Noise analysis	323
Use of Jitter+Noise analysis when DJAN is not enabled	324
Basic steps in joint Jitter+Noise analysis	325
Noise model component interrelationships	326
Results	326

GPIB commands

About the GPIB program	329
GPIB reference materials	329
Argument types	330
DPOJET:ADDMeas	330
DPOJET:APPLYAll	331
DPOJET:BITRatestate	331
DPOJET:CLEARALLMeas	332
DPOJET:DATAratelimits	332
DPOJET:DESKEW	333
DPOJET:DESKEW:DESKEWchannel	333
DPOJET:DESKEW:DESKEWHysteresis	334
DPOJET:DESKEW:DESKEWMidlevel	334

DPOJET:DESKEW:EDGE	335
DPOJET:DESKEW:MAXimum	335
DPOJET:DESKEW:MINimum	336
DPOJET:DESKEW:REFChannel	336
DPOJET:DESKEW:REFHysteresis	337
DPOJET:DESKEW:REFMidlevel	337
DPOJET:DIRacmodel	338
DPOJET:EXPORT	338
DPOJET:EXPORTRaw	339
DPOJET:GATING	339
DPOJET:HALTFreerunonlimfail	340
DPOJET:HIGHPerfrendering	340
DPOJET:INTERp	341
DPOJET:JITtermode?	341
DPOJET:JITtermodel	342
DPOJET:ANALYSISMETHOD	342
DPOJET:LASTError?	342
DPOJET:LIMITRise	343
DPOJET:MINBUJUI	343
DPOJET:LIMits:FILEName	344
DPOJET:LIMits:STATE	344
DPOJET:LOGging:MEASurements:FOLDer	345
DPOJET:LOGging:MEASurements:STATE	345
DPOJET:LOGging:SNAPshot	346
DPOJET:LOGging:STATistics:FILEName	346
DPOJET:LOGging:STATistics:STATE	347
DPOJET:LOGging:WORSTcase:FOLDer	347
DPOJET:LOGging:WORSTcase:STATE	348
DPOJET:MEAS<x>	348
DPOJET:MEAS<x>:BER:TARGETBER	349
DPOJET:MEAS<x>:BITCfghmethod	349
DPOJET:MEAS<x>:BITPcnt	350
DPOJET:MEAS<x>:BITConfig:STARTPercent	350
DPOJET:MEAS<x>:BITConfig:ENDPercent	351
DPOJET:MEAS<x>:BITConfig:NUMBins	351
DPOJET:MEAS<x>:BITConfig:ABSRELstate	352
DPOJET:MEAS<x>:BITType	352
DPOJET:MEAS<x>:BUSState:CLOCKPolarity	353
DPOJET:MEAS<x>:BUSState:FROMPattern	353

DPOJET:MEAS<x>:BUSState:FROMSymbol	354
DPOJET:MEAS<x>:BUSState:MEASUREType	354
DPOJET:MEAS<x>:BUSState:MEASUREFrom	355
DPOJET:MEAS<x>:BUSState:MEASURETO	355
DPOJET:MEAS<x>:BUSState:TOPattern	356
DPOJET:MEAS<x>:BUSState:TOSymbol	356
DPOJET:MEAS<x>:CLOCKRecovery:CLOCKBitrate	357
DPOJET:MEAS<x>:CLOCKRecovery:CLOCKFrequency	357
DPOJET:MEAS<x>:CLOCKRecovery:CLOCKMultiplier	358
DPOJET:MEAS<x>:CLOCKRecovery:CLOCKPath	358
DPOJET:MEAS<x>:CLOCKRecovery:DAMPing	359
DPOJET:MEAS<x>:CLOCKRecovery:DATARate	359
DPOJET:MEAS<x>:CLOCKRecovery:BWType	360
DPOJET:MEAS<x>:CLOCKRecovery:LOOPBandwidth	360
DPOJET:MEAS<x>:CLOCKRecovery:MEANAUTOCalculate	361
DPOJET:MEAS<x>:CLOCKRecovery:METHod	361
DPOJET:MEAS<x>:CLOCKRecovery:MODel	362
DPOJET:MEAS<x>:CLOCKRecovery:NOMINALOFFset	362
DPOJET:MEAS<x>:CLOCKRecovery:NOMINALOFFset:AUTO?	363
DPOJET:MEAS<x>:CLOCKRecovery:NOMINALOFFset:MANual	363
DPOJET:MEAS<x>:CLOCKRecovery:NOMINALOFFset:Recalctype	364
DPOJET:MEAS<x>:CLOCKRecovery:NOMINALOFFset:SELECTIONtype	364
DPOJET:MEAS<x>:CLOCKRecovery:PATTern	365
DPOJET:MEAS<x>:CLOCKRecovery:STAndard	365
DPOJET:MEAS<x>:COMMONMode:FILTers:STATE	366
DPOJET:MEAS<x>:CUSTomname	366
DPOJET:MEAS<x>:DATA?	367
DPOJET:MEAS<x>:DFE:RESOLution	367
DPOJET:MEAS<x>:DFE:TAPState	368
DPOJET:MEAS<x>:DFE:ABSOLUTEState	368
DPOJET:MEAS<x>:DFE:ABSOLUTEValue	369
DPOJET:MEAS<x>:DFE:MEASatpercent	369
DPOJET:MEAS<x>:DISPLAYNAME?	370
DPOJET:MEAS<x>:DFE:TAPValue	370
DPOJET:MEAS<x>:EDGE1	371
DPOJET:MEAS<x>:EDGE2	371
DPOJET:MEAS<x>:EDGEIncre	372
DPOJET:MEAS<x>:EDGES:FROMLevel	372
DPOJET:MEAS<x>:EDGES:LEVel	373

DPOJET:MEAS<x>:EDGES:SLEWRATETechnique	373
DPOJET:MEAS<x>:EDGES:SUBRATEDivisor	374
DPOJET:MEAS<x>:EDGES:EYEHeightstate	374
DPOJET:MEAS<x>:EDGES:VOLTAGEState	375
DPOJET:MEAS<x>:EDGES:USERDefinedvoltage	375
DPOJET:MEAS<x>:EDGES:TOLevel	376
DPOJET:MEAS<x>:FILTerS:BLANKingtime	376
DPOJET:MEAS<x>:FILTerS:HIGHPass:FREQ	377
DPOJET:MEAS<x>:FILTerS:HIGHPass:SPEC	377
DPOJET:MEAS<x>:FILTerS:LOWPass:FREQ	378
DPOJET:MEAS<x>:FILTerS:LOWPass:SPEC	378
DPOJET:MEAS<x>:FILTerS:SJBAndwidth	379
DPOJET:MEAS<x>:FILTerS:SJFRequency	379
DPOJET:MEAS<x>:REFVoltage	380
DPOJET:MEAS<x>:FILTerS:RAMPTime	380
DPOJET:MEAS<x>:FROMedge	381
DPOJET:MEAS<x>:HIGHREFVoltage	381
DPOJET:MEAS<x>:LOWREFVoltage	382
DPOJET:MEAS<x>:LOGging:MEASurements:FILEname?	382
DPOJET:MEAS<x>:LOGging:MEASurements:SElect	383
DPOJET:MEAS<x>:LOGging:STATistics:SElect	383
DPOJET:MEAS<x>:LOGging:WORSTcase:SElect	384
DPOJET:MEAS<x>:MARGIN:HITCOUNTValue	384
DPOJET:MEAS<x>:MARGIN:HITRATIOState	385
DPOJET:MEAS<x>:MARGIN:HITRATIOValue	385
DPOJET:MEAS<x>:MARGIN:RESOLution	386
DPOJET:MEAS<x>:MASKfile	386
DPOJET:MEAS<x>:MASKOffset:HORizontal:SELECTIONtype	387
DPOJET:MEAS<x>:MASKOffset:HORizontal:AUTOfit?	387
DPOJET:MEAS<x>:MASKOffset:HORizontal:MANual	388
DPOJET:MEAS<x>:MEASRange:MAX	388
DPOJET:MEAS<x>:MEASRange:MIN	389
DPOJET:MEAS<x>:MEASRange:STATE	389
DPOJET:MEAS<x>:MEASStart	390
DPOJET:MEAS<x>:N	390
DPOJET:MEAS<x>:NAME?	391
DPOJET:MEAS<x>:PHASNoise:HIGHLimit	391
DPOJET:MEAS<x>:PHASNoise:LOWLimit	392
DPOJET:MEAS<x>:REFVoltage	392

DPOJET:MEAS<x>:RESULts?	393
DPOJET:MEAS<x>:RESULts:ALLAcqs?	393
DPOJET:MEAS<x>:RESULts:ALLAcqs:HITPopulation?	393
DPOJET:MEAS<x>:RESULts:ALLAcqs:HITS?	394
DPOJET:MEAS<x>:RESULts:ALLAcqs:LIMits:STATUs?	394
DPOJET:MEAS<x>:RESULts:ALLAcqs:LIMits:HIgh:STATUs?	394
DPOJET:MEAS<x>:RESULts:ALLAcqs:LIMits:LOW:STATUs?	395
DPOJET:MEAS<x>:RESULts:ALLAcqs:MAX?	395
DPOJET:MEAS<x>:RESULts:ALLAcqs:MAXCC?	395
DPOJET:MEAS<x>:RESULts:ALLAcqs:MAXCC:STATUs?	396
DPOJET:MEAS<x>:RESULts:ALLAcqs:MAXHits?	396
DPOJET:MEAS<x>:RESULts:ALLAcqs:MAX:STATUs?	396
DPOJET:MEAS<x>:RESULts:ALLAcqs:MAX:HIGHLimit?	397
DPOJET:MEAS<x>:RESULts:ALLAcqs:MAX:HIGHMArgin?	397
DPOJET:MEAS<x>:RESULts:ALLAcqs:MIN:LOWLimit?	398
DPOJET:MEAS<x>:RESULts:ALLAcqs:MIN:LOWMArgin?	398
DPOJET:MEAS<x>:RESULts:ALLAcqs:MEAN?	398
DPOJET:MEAS<x>:RESULts:ALLAcqs:MEAN:HIGHLimit?	399
DPOJET:MEAS<x>:RESULts:ALLAcqs:MEAN:STATUs?	399
DPOJET:MEAS<x>:RESULts:ALLAcqs:MIN?	399
DPOJET:MEAS<x>:RESULts:ALLAcqs:MINCC?	400
DPOJET:MEAS<x>:RESULts:ALLAcqs:MINCC:STATUs?	400
DPOJET:MEAS<x>:RESULts:ALLAcqs:MINHits?	400
DPOJET:MEAS<x>:RESULts:ALLAcqs:MIN:STATUs?	401
DPOJET:MEAS<x>:RESULts:ALLAcqs:PK2PK?	401
DPOJET:MEAS<x>:RESULts:ALLAcqs:PK2PK:STATUs?	401
DPOJET:MEAS<x>:RESULts:ALLAcqs:POPulation?	402
DPOJET:MEAS<x>:RESULts:ALLAcqs:POPulation:STATUs?	402
DPOJET:MEAS<x>:RESULts:ALLAcqs:SEG(x):Hits?	403
DPOJET:MEAS<x>:RESULts:ALLAcqs:SEG(x):MAXHits?	403
DPOJET:MEAS<x>:RESULts:ALLAcqs:SEG(x):MINHits?	403
DPOJET:MEAS<x>:RESULts:ALLAcqs:STDDev?	404
DPOJET:MEAS<x>:RESULts:ALLAcqs:STDDEV:STATUs?	404
DPOJET:MEAS<x>:RESULts:CURRentacq:MAX?	404
DPOJET:MEAS<x>:RESULts:CURRentacq:MAXCC?	405
DPOJET:MEAS<x>:RESULts:CURRentacq:MAXCC:STATUs?	405
DPOJET:MEAS<x>:RESULts:CURRentacq:MAX:STATUs?	406
DPOJET:MEAS<x>:RESULts:CURRentacq:MEAN?	406
DPOJET:MEAS<x>:RESULts:CURRentacq:MEAN:STATUs?	406

DPOJET:MEAS<x>:RESULts:CURRentacq:MIN?	407
DPOJET:MEAS<x>:RESULts:CURRentacq:MINCC?	407
DPOJET:MEAS<x>:RESULts:CURRentacq:MINCC:STATUs?	407
DPOJET:MEAS<x>:RESULts:CURRentacq:MIN:STATUs?	408
DPOJET:MEAS<x>:RESULts:CURRentacq:PK2PK?	408
DPOJET:MEAS<x>:RESULts:CURRentacq:PK2PK:STATUs?	409
DPOJET:MEAS<x>:RESULts:CURRentacq:POPulation?	409
DPOJET:MEAS<x>:RESULts:CURRentacq:POPulation:STATUs?	409
DPOJET:MEAS<x>:RESULts:CURRentacq:STDDev?	410
DPOJET:MEAS<x>:RESULts:CURRentacq:STDDev:STATUs?	410
DPOJET:MEAS<x>:RESULts:STATUs?	411
DPOJET:MEAS<x>:RESULts:View?	411
DPOJET:MEAS<x>:RJDJ:BER	411
DPOJET:MEAS<x>:RJDJ:DETECTPLEN	412
DPOJET:MEAS<x>:RJDJ:PATLen	412
DPOJET:MEAS<x>:RJDJ:TYPe	413
DPOJET:MEAS<x>:RJDJ:WINDOwlength	413
DPOJET:MEAS<x>:RNDN:BER	414
DPOJET:MEAS<x>:RNDN:AUTODETECTpattern	414
DPOJET:MEAS<x>:RNDN:PATLen	415
DPOJET:MEAS<x>:RNDN:TYPe	415
DPOJET:MEAS<x>:RNDN:WINDOwlength	416
DPOJET:MEAS<x>:SIGNALType	416
DPOJET:MEAS<x>:SOUrce1	417
DPOJET:MEAS<x>:SOUrce2	417
DPOJET:MEAS<x>:SSC:NOMinalfreq:AUTO?	418
DPOJET:MEAS<x>:SSC:NOMinalfreq:MANual	418
DPOJET:MEAS<x>:SSC:NOMinalfreq:SELECTIONtype	419
DPOJET:MEAS<x>:TIMEDATa?	419
DPOJET:MEAS<x>:TOEdge	420
DPOJET:MEAS<x>:ZOOMEVENT	420
DPOJET:NOISEENABLED	421
DPOJET:NUMMeas?	421
DPOJET:ADDPlot	422
DPOJET:CLEARALLPlots	422
DPOJET:PLOT<x>:COMPOSITEJitterhist:VERTical:SCALE	423
DPOJET:PLOT<x>:COMPOSITEJitterhist:NUMBins	423
DPOJET:PLOT<x>:COMPOSITEJitterhist:TJ	424
DPOJET:PLOT<x>:COMPOSITEJitterhist:RJNPJ	424

DPOJET:PLOT<x>:COMPOSITEJitterhist:PJ	425
DPOJET:PLOT<x>:COMPOSITEJitterhist:DDJDCD	425
DPOJET:PLOT<x>:DATA:XDATAa?	426
DPOJET:PLOT<x>:DATA:XDATA:TJ?	427
DPOJET:PLOT<x>:DATA:XDATA:RJBUI?	427
DPOJET:PLOT<x>:DATA:XDATA:PJ?	428
DPOJET:PLOT<x>:DATA:XDATA:DDJDCD?	429
DPOJET:PLOT<x>:DATA:XDATA:TN	429
DPOJET:PLOT<x>:DATA:XDATA:RNNPN	430
DPOJET:PLOT<x>:DATA:XDATA:PN	430
DPOJET:PLOT<x>:DATA:XDATA:DDNZERO	431
DPOJET:PLOT<x>:DATA:XDATA:DDNONE	431
DPOJET:PLOT<x>:DATA:YDATAa?	432
DPOJET:PLOT<x>:DATA:YDATA:TJ?	433
DPOJET:PLOT<x>:DATA:YDATA:RJBUI?	433
DPOJET:PLOT<x>:DATA:YDATA:PJ?	434
DPOJET:PLOT<x>:DATA:YDATA:DDJDCD?	435
DPOJET:PLOT<x>:DATA:YDATA:TN	435
DPOJET:PLOT<x>:DATA:YDATA:RNNPN	436
DPOJET:PLOT<x>:DATA:YDATA:PN	437
DPOJET:PLOT<x>:DATA:YDATA:DDNONE	437
DPOJET:PLOT<x>:DATA:YDATA:DDNZERO	438
DPOJET:PLOT<x>:XUnits?	439
DPOJET:PLOT<x>:YUnits?	439
DPOJET:PLOT<x>:SOUrce?	440
DPOJET:PLOT<x>:TREND:TYPe	440
DPOJET:PLOT<x>:TYPe?	441
DPOJET:PLOT<x>:BATHtub:BER	441
DPOJET:PLOT<x>:BATHtub:VERTical:SCALE	442
DPOJET:PLOT<x>:EYE:ALIGNment	442
DPOJET:PLOT<x>:EYE:ALLUI	443
DPOJET:PLOT<x>:EYE:HORizontal:AUTOscale	443
DPOJET:PLOT<x>:EYE:HORizontal:RESolution	444
DPOJET:PLOT<x>:EYE:INTERPolationtype	444
DPOJET:PLOT<x>:EYE:MASKfile	445
DPOJET:PLOT<x>:EYE:STATE	445
DPOJET:PLOT<x>:EYE:SUPERImpose	446
DPOJET:PLOT<x>:EYE:VERTICALAlignment	446
DPOJET:PLOT<x>:EYE:VERTScale	447

DPOJET:PLOT<x>:EYE:HORIZScale	447
DPOJET:PLOT<x>:EYE:VERTical:YAXISMAx	448
DPOJET:PLOT<x>:EYE:VERTical:YAXISMin	448
DPOJET:PLOT<x>:EYE:HORizontal:XAXISMAx	449
DPOJET:PLOT<x>:EYE:HORizontal:XAXISMin	449
DPOJET:PLOT<x>:TOTALUISAnalyzed?	450
DPOJET:PLOT<x>:TOTALUISAcquired?	450
DPOJET:PLOT<x>:HISTOgram:HORizontal:SPAN	450
DPOJET:PLOT<x>:HISTOgram:AUTOset	451
DPOJET:PLOT<x>:HISTOgram:HORizontal:AUTOscale	451
DPOJET:PLOT<x>:HISTOgram:HORizontal:CENter	452
DPOJET:PLOT<x>:HISTOgram:HORizontal:SPAN	452
DPOJET:PLOT<x>:HISTOgram:NUMBins	453
DPOJET:PLOT<x>:HISTOgram:VERTical:SCALE	453
DPOJET:PLOT<x>:PHASEnoise:BASEline	454
DPOJET:PLOT<x>:SPECTrum:BASE	454
DPOJET:PLOT<x>:SPECTrum:HORizontal:SCALE	455
DPOJET:PLOT<x>:SPECTrum:MODE	455
DPOJET:PLOT<x>:SPECTrum:VERTical:SCALE	456
DPOJET:PLOT<x>:TRANSfer:DENominator	456
DPOJET:PLOT<x>:TRANSfer:HORizontal:SCALE	457
DPOJET:PLOT<x>:TRANSfer:MODE	457
DPOJET:PLOT<x>:TRANSfer:NUMerator	458
DPOJET:PLOT<x>:TRANSfer:VERTical:SCALE	458
DPOJET:PLOT<x>:BERContour:ALIGNment	459
DPOJET:PLOT<x>:BERContour:HORizontal:AUTOscale	459
DPOJET:PLOT<x>:BERContour:HORizontal:RESolution	460
DPOJET:PLOT<x>:BERContour:MASK	460
DPOJET:PLOT<x>:BERContour:MASKFile	460
DPOJET:PLOT<x>:BERContour:SUPERImpose	461
DPOJET:PLOT<x>:BERContour:BER1E6V	461
DPOJET:PLOT<x>:BERContour:BER1E9V	462
DPOJET:PLOT<x>:BERContour:BER1E12V	462
DPOJET:PLOT<x>:BERContour:BER1E15V	463
DPOJET:PLOT<x>:BERContour:BER1E18V	463
DPOJET:PLOT<x>:BERContour:TARGETBER	464
DPOJET:PLOT<x>:VERTBATHtub:BER	464
DPOJET:PLOT<x>:VERTBATHtub:HORizontal:SCALE	465
DPOJET:PLOT<x>:CORRELATEDEye:BER1E6V	465

DPOJET:PLOT<x>:EXPORTRaw?	466
DPOJET:PLOT<x>:CORRELATEDEye:BER1E9V	466
DPOJET:PLOT<x>:CORRELATEDEye:BER1E12V	467
DPOJET:PLOT<x>:CORRELATEDEye:BER1E15V	467
DPOJET:PLOT<x>:CORRELATEDEye:BER1E18V	468
DPOJET:PLOT<x>:CORRELATEDEye:TARGETBER	468
DPOJET:PLOT<x>:PDFEye:BER1E6V	469
DPOJET:PLOT<x>:PDFEye:BER1E9V	469
DPOJET:PLOT<x>:PDFEye:BER1E12V	470
DPOJET:PLOT<x>:PDFEye:BER1E15V	470
DPOJET:PLOT<x>:PDFEye:BER1E18V	471
DPOJET:PLOT<x>:PDFEye:TARGETBER	471
DPOJET:PLOT<x>:BEREye:BER1E6V	472
DPOJET:PLOT<x>:BEREye:BER1E9V	472
DPOJET:PLOT<x>:BEREye:BER1E12V	473
DPOJET:PLOT<x>:BEREye:BER1E15V	473
DPOJET:PLOT<x>:BEREye:BER1E18V	474
DPOJET:PLOT<x>:BEREye:TARGETBER	474
DPOJET:PLOT<x>:COMPOSITENoisehist:HORIZontal:SCALE	475
DPOJET:PLOT<x>:COMPOSITENoisehist:NUMBins	475
DPOJET:PLOT<x>:COMPOSITENoisehist:TN	476
DPOJET:PLOT<x>:COMPOSITENoisehist:RNNPN	476
DPOJET:PLOT<x>:COMPOSITENoisehist:PN	477
DPOJET:PLOT<x>:COMPOSITENoisehist:DDNZERO	477
DPOJET:PLOT<x>:COMPOSITENoisehist:DDNONE	478
DPOJET:POPULATION:CONDition	478
DPOJET:POPULATION:LIMIT	479
DPOJET:POPULATION:LIMITBY	479
DPOJET:POPULATION:STATE	480
DPOJET:QUALify:ACTIVE	480
DPOJET:QUALify:SOUrce	481
DPOJET:QUALify:STATE	481
DPOJET:REFLevel:CH<x>:MIDZero	482
DPOJET:REFLevels:AUTOSet	482
DPOJET:REFLevels:AUTOset:STATE?	483
DPOJET:REFLevels:CH<x>:AUTOSet	483
DPOJET:REFLevels:CH<x>:ABSolute	484
DPOJET:REFLevels:CH<x>:ABSolute:RISEHigh	484
DPOJET:REFLevels:CH<x>:ABSolute:RISELow	484

DPOJET:REFLevels:CH<x>:ABSolute:RISEMid	485
DPOJET:REFLevels:CH<x>:ABSolute:FALLHigh	485
DPOJET:REFLevels:CH<x>:ABSolute:FALLLow	486
DPOJET:REFLevels:CH<x>:ABSolute:FALLMid	486
DPOJET:REFLevels:CH<x>:ABSolute:HYSteresis	487
DPOJET:REFLevels:CH<x>:BASETop	487
DPOJET:REFLevels:CH<x>:PERcent	488
DPOJET:REFLevels:CH<x>:PERcent:FALLHigh	488
DPOJET:REFLevels:CH<x>:PERcent:FALLLow	488
DPOJET:REFLevels:CH<x>:PERcent:FALLMid	489
DPOJET:REFLevels:CH<x>:PERcent:PERCENTReflevel	489
DPOJET:REFLevels:CH<x>:PERcent:HYSteresis	490
DPOJET:REFLevels:CH<x>:PERcent:RISEHigh	490
DPOJET:REFLevels:CH<x>:PERcent:RISELow	491
DPOJET:REFLevels:CH<x>:PERcent:RISEMid	491
DPOJET:REPORT	492
DPOJET:REPORT:APPLIcationconfig	492
DPOJET:REPORT:AUTOincrement	493
DPOJET:REPORT:COMments	493
DPOJET:REPORT:DETailedresults	494
DPOJET:REPORT:DISPunits	494
DPOJET:REPORT:ENABLecomments	495
DPOJET:REPORT:GETIMAGE	495
DPOJET:REPORT:GETIMAGENAME	496
DPOJET:REPORT:GETXMLReport	496
DPOJET:REPORT:PASSFailresults	496
DPOJET:REPORT:PLOTimages	497
DPOJET:REPORT:REPORTName	497
DPOJET:REPORT:SETupconfig	498
DPOJET:REPORT:SAVEWaveforms	498
DPOJET:REPORT:SETIMAGEPath	499
DPOJET:REPORT:STATE?	499
DPOJET:REPORT:VIEWreport	499
DPOJET:RESULts:STATUs?	500
DPOJET:RESULts:View	500
DPOJET:RESULts:GETALLResults?	501
DPOJET:SAVE	501
DPOJET:SETIMAGETPath	501
DPOJET:SETLOGGINGPath	502

DPOJET:SETREPORTPath	502
DPOJET:SOURCEAutoset	503
DPOJET:SOURCEAutoset:HORizontal:UICount	503
DPOJET:SOURCEAutoset:HORizontal:UIValue	504
DPOJET:SOURCEAutoset:STATE?	504
DPOJET:STATE	505
DPOJET:TDCOMPensation	505
DPOJET:UNITType	506
DPOJET:LOCKRJ	506
DPOJET:LOCKRJValue	507
DPOJET:PLOT(x):BATHtub:XAXISUnits	507
DPOJET:PLOT(x):NOISEBATHtub:YAXISUnits	508
DPOJET:VERTUNITType	508
DPOJET:VERsion?	508

Welcome

DPOJET is a jitter, noise, timing, and eye analysis tool for Tektronix Performance Digital Oscilloscopes (DPO5000/B, MSO5000/B, DPO7000C, DPO7000C/D/DX, DSA7000C/D, MSO7000C/DX, DPO72304SX, DPO73304SX, DPO75002SX, DPO75902SX, and DPO77002SX series). DPOJET enables you to achieve new levels of productivity, efficiency, and measurement reliability on complex clock, digital, and serial data signals. DPOJET revolutionized jitter analysis by adding noise analysis.

Some of the features of DPOJET are:

- Advanced Jitter, Noise and Timing Analysis for clocks and data signals, with up to 99 simultaneous measurements on 12 analog and 16 digital sources.
- Jitter Guide/Serial Data wizard for easy configuration of popular measurement sets.
- One Touch Jitter wizard for quick jitter summaries.
- Accurate jitter decomposition and TJ (BER) estimation using industry-accepted methods.
- Isolate jitter and noise due to crosstalk, and make random and deterministic estimations in the presence of crosstalk.
- Comprehensive measurement statistics.
- Random Jitter (RJ) Lock value for analysis.
- BER analysis of serial data rates.
- BUJ analysis of both clock and data signals.
- Flexible measurement/statistic logging and export capabilities.
- Sophisticated plots for graphical analysis such as Histograms, Time Trends, Eye Diagrams, Spectrums, Bathtub Plots, BER Eye Contour, Composite Jitter Histogram, Composite Noise Histogram, Noise Bathtub, BER eye, Correlated Eye, PDF Eye and Real-Time Eye[®] diagrams with transition and non-transition bit separation.
- Tektronix patented Programmable PLL software clock recovery.
- Standards-specific support for clock recovery and jitter separation methods.
- Capture and storage of worst-case waveforms for subsequent analysis.
- Thorough remote programmability using oscilloscope-like syntax.
- Optical measurements are added under optical standard tab: Average Optical Power, Extinction Ratio, Optical Modulation Amplitude, Optical High, Optical Low, Eye Crossing Level, Eye Crossing Time, Eye Crossing Percent, Mask Hit Ratio, and Mask Margin.

Introduction to the application

Free trials

Refer to the *Optional Applications Software on a Windows-Based Oscilloscope Installation Manual* for details on free trials which are available for all applications. The manual is available on the Optional Applications Software on Windows-Based Oscilloscopes DVD, in the documents directory.

NOTE. *Before evaluating an application, first check that your DSA/DPO/MSO series oscilloscope firmware version is consistent with the version requirements mentioned in the application's readme file. You can check the firmware version number from the oscilloscope Help drop-down list (About TekScope). To check the application's firmware compatibility, refer to the System Requirements section of the readme.txt file.*

If an application is introduced after you receive your oscilloscope, you can download the application as described in the installation manual (Tektronix part number 071-1888-XX) to obtain the free trial. Download the manuals from www.tektronix.com/manuals and www.tektronix.com/software.

NOTE. *Free trial is supported Via floating trial license.*

Related documentation

Tektronix manuals are available at: www.tektronix.com/manuals and www.tektronix.com/software. Use the following table to determine the document that you need:

Table 1: List of reference documents

For information on:	Refer to:
<ul style="list-style-type: none"> ■ Operating the Oscilloscope 	Oscilloscope user manual. Oscilloscope user online help.
<ul style="list-style-type: none"> ■ Software warranty ■ List of available applications ■ Compatible oscilloscopes ■ Relevant software and firmware version numbers ■ Applying a new option key label ■ Installing an application ■ Enabling an application ■ Downloading updates from the Tektronix Web site 	<i>Optional Applications Software on Windows-Based Oscilloscopes Installation Manual</i> , which is provided on the <i>Optional Applications Software on Windows-Based Oscilloscopes CD-ROM</i> , in the Documents directory.



Conventions

Online Help uses the following conventions:

- When steps require sequence of selections using the application interface, the “>” delimiter marks each transition between a menu and an option. For example, **Analyze> Wizard > One Touch Jitter**.
- The terms “DPOJET application” and “application” refer to DPOJET.
- The term “oscilloscope” refers to any product on which this application runs.
- The term “DUT” is an abbreviation for Device Under Test.
- The term “select” is a generic term that applies to the methods of choosing an option: with a mouse or with the touch screen.
- User interface screen graphics are taken from a DPO7000 series oscilloscope.

You can find a PDF (portable document format) file for this document in the Documents directory on the *Optional Applications Software on Windows-Based Oscilloscopes DVD*. The DVD booklet only contains information on installing the application from the DVD and on how to apply a new label. You can also find the PDF and the Online Help at **Start>All Programs>TekApplications > DPOJET**.

Table 2: Icon descriptions

Icon	Meaning
	This icon identifies important information.
	This icon identifies conditions or practices that could result in loss of data.
	This icon identifies additional information that will help you use the application more efficiently.

Technical support

Tektronix welcomes your comments about products and services. Contact Tektronix through mail, telephone, or the Web site. Click [Contacting Tektronix](#) for more information.

Tektronix also welcomes your feedback. Click [Customer feedback](#) for suggestions for providing feedback to Tektronix.

Customer feedback

Tektronix values your feedback on our products. To help us serve you better, please send us your suggestions, ideas, or other comments you may have regarding the application or oscilloscope.

Direct your feedback via email to

techsupport@tektronix.com

Or FAX at (503) 627-5695, and include the following information:

- General Information**
- Oscilloscope model number (for example, DPO/MSO5000, DPO7000, DSA/DPO/MSO70000 series) and hardware options, if any.
 - Software version number.
 - Probes used.

- Application-specific Information**
- Description of the problem such that technical support can duplicate the problem.
 - If possible, save the oscilloscope and application setup files as .set and associated .xml files.
 - If possible, save the waveform on which you are performing the measurement as a .wfm file.

Once you have gathered this information, contact technical support by phone or through e-mail. In the subject field, please indicate “DPOJET Problem” and attach the .set, .xml and .wfm files to your e-mail. If there is any query related to the actual measurement results, then you can generate a .mht report and send it.

The following items are important, but optional:

- Your name
- Your company
- Your mailing address
- Your phone number
- Your FAX number

Enter your suggestion. Please be as specific as possible.

Please indicate if you would like to be contacted by Tektronix regarding your suggestion or comments.

To include screen shots of the oscilloscope waveform and DPOJET user interface, from your oscilloscope menu bar, click **File > Save As > Screen Capture**. To include screenshots of the DPOJET plots, select the floppy-disk icon from the plots toolbar. In either case, enter a file name in the Save As dialog box, select an image file format (For example: .bmp or .png or .jpeg), choose a save location and select Save. You can then attach the file(s) to your e-mail (depending on the capabilities of your e-mail editor).

Getting started

Product description

DPOJET is a jitter, noise, timing, and eye diagram analysis tool for Tektronix Performance Digital Oscilloscopes (DPO5000/B, MSO5000/B, DPO7000C, DPO7000C/D/DX, DSA7000C/D, MSO7000/C/DX, DPO72304SX, DPO73304SX, DPO75002SX, DPO75902SX, and DPO77002SX series).

DPOJET enables you to achieve new levels of productivity, efficiency, and measurement reliability on complex clock, digital, and serial data signals. DPOJET answers the challenge with a jitter and noise breakdown extended to properly classify the bounded uncorrelated disturbers in their own category, increasing the accuracy of the jitter/noise result.

The application provides the following features:

- One Touch Jitter Summary.
- Measurement Setup Wizard.
- Isolate jitter and noise due to crosstalk, and make random and deterministic estimations in the presence of crosstalk.
- Qualify the waveform measurement within a selected result range by General.
- Limit the waveform (data) analysis by Gating, applying a Qualifier or configuring population limits.
- High pass and low pass measurement filters.
- Random Jitter (RJ) Lock value for analysis.
- Auto-detection of signal type (clock or data), bit rate, and pattern length.
- Different architectures for clock recovery to establish a reference clock, the edges of which can be used as a basis for timing comparisons.
- RJ-DJ and RN-DN decomposition on repeating and arbitrary data patterns.
- BER analysis of serial data rates.
- BUJ analysis of both clock and data signals.
- Eye diagrams with transition and non-transition bits separation.
- Show results as numeric and graphical displays.
- Different types of two-dimensional display plots for easier analysis of results.
- Automatic reference level autoreset for eye diagrams, jitter, noise and timing measurements.
- Preferences shortcut to set up options available at the Select panel.

Jitter Analysis

Jitter Analysis is the measurement of Time Interval Error (TIE), advanced RJ-DJ decomposition, and other clock to data edge relationships.

Noise Analysis

Noise Analysis is the set of measurements (RN, NN, DDN, ..) that are analogous to Jitter component measurements (RJ, PJ, DDJ, ..).

Timing Analysis

Timing analysis is the measurement of period, setup, hold, skew, and other edge-to-edge data timing relationships.

Eye Diagram Analysis

Eye diagram analysis is the plotting and measurement of eye diagrams and masks.

DPOJET option levels

The DPOJET application offers three different levels of features, depending on how it is configured. The configurations are determined by the following order codes:

- **DJE** – Jitter and Eye Diagram Analysis Tools - Essentials
- **DJA** – Jitter and Eye Diagram Analysis Tools - Advanced
- **DJAN** – Noise Analysis Tools - Requires DJA

NOTE. *The application name “Jitter and Eye Diagram Analysis Tools” is the same for DJE, DJA. The application name for DJAN is “Noise Analysis Tools” and it requires DJA enabled. However, Help > About DPOJET indicates the configured option level. Save/Recall is compatible between the option levels. If a setup file saved in DJA is recalled in DJE, only the capabilities available in DJE will be recalled. If a setup file saved in DJAN is recalled in DJA or DJE, only the capabilities available in DJA or DJE will be recalled.*

Jitter and Eye Diagram Analysis Tools - Essentials

Use **Essentials** for basic timing and jitter analysis. Essentials offers:

- Period, Frequency and Time Interval Error analysis.
- Timing parametrics such as rise/fall times, pulse width and duty cycle.
- Many graphical tools such as histograms, time trends, and spectrums.
- Configurable HTML report generation.
- Logging features for recording individual measurements, statistics, or worst-case waveforms.
- Comprehensive remote control using oscilloscope-like GPIB syntax.
- A wizard interface to ease common setup tasks.

NOTE. *Summary View and Overall Test Result are not available for DJE.*

Jitter and Eye Diagram Analysis Tools-Advanced

The **Advanced** configuration offers all the features of Essentials, and adds the following:

- Jitter separation (RJ-DJ analysis).
- Eye measurements.
- Amplitude measurements.
- Measurement filters.
- Eye diagrams, bathtub plots or Mask Hits waveform plots.
- Pass/Fail limits capability.
- RJ Lock value

NOTE. *Option DJA is required for PCI Express Gen1/Gen2/Gen3 measurements and for DDRA measurements.*

Noise Analysis Tools - Requires DJA

The **Noise Analysis Tools** configuration offers all the features of Advanced and adds the following:

- Jitter separation RJ(h), RJ(v), PJ(h), PJ(v).
- Noise measurements RN, RN(v), RN(h), DN, DDN, DDN(1), DDN(0), PN, PN(v), PN(h), NPN, TN@BER, Unit Amplitude.
- Plots related to composite Jitter+Noise analysis, such as BER Eye, Correlated Eye and PDF Eye.
- Noise measurement plots such as BER Eye contour, Noise Bathtub, Composite Noise Histogram.

Compatibility

For information on oscilloscope compatibility, refer to the *Optional Application Software on Microsoft Windows Based Oscilloscopes Installation Manual*, Tektronix part number 077-0067-XX. The manual is available as a PDF file.

Requirements and restrictions

DPOJET requires Matlab MCR (Matlab Compiler Runtime) 8.0 for 64-bit oscilloscopes. DPOJET requires .Net framework v4 or higher for 64-bit oscilloscopes.

Supported probes

The application supports the following probes:

- TAP1500
- TAP2500
- TAP3500
- P5100
- P6015
- P6101A
- P6139A
- P6241
- P6243
- P6245
- P6249
- P6150
- P6158
- P7240
- P7260
- P7330
- P7340A
- P7350
- P7350SMA
- P7360A
- P7380A
- P7380SMA

- P7313A
- P7313SMA
- All P75XX and P76XX probes

Installing the application

Refer to the *Optional Applications Software on Windows-Based Oscilloscopes Installation Manual* for the following information:

- Software warranty.
- List of available applications, compatible oscilloscopes, and relevant software and firmware version numbers.
- Applying a new option installation key label.
- Installing an application.
- Enabling an application.
- Downloading updates from the Tektronix Web site.

You can find a PDF (portable document format) file for this document in the Documents directory on the *Optional Applications Software on Windows-Based Oscilloscopes DVD*. The DVD booklet contains information on how to install the application from the DVD and on how to apply a new option installation key label.

About DPOJET

Click **Help > About DPOJET** to view application details such as the release software version number, application name, and copyright.

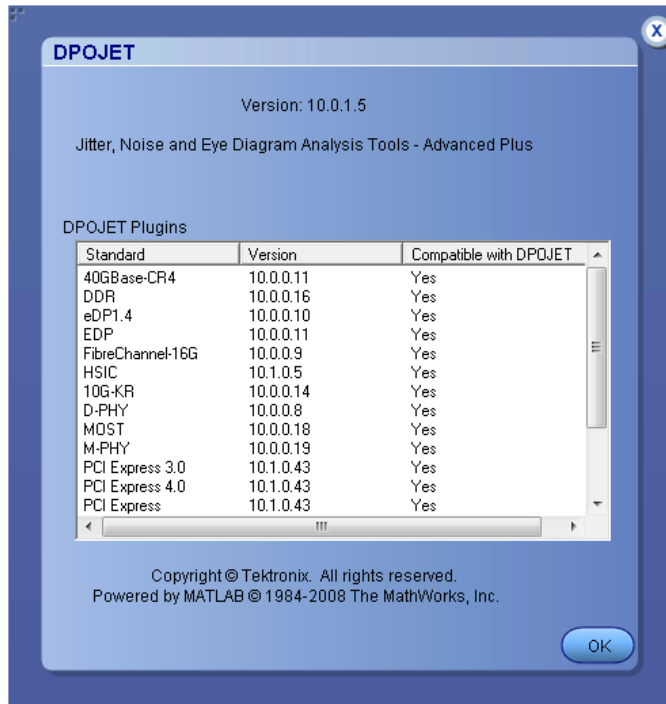

NOTE. *The version displayed above is indicative only, the version number displayed will vary depending upon the exact version of the application installed.*





Operating basics

About basic operations

Starting the application On the oscilloscope menu bar, click **Analyze>Jitter and Eye Analysis (DPOJET) > Select** to open the application.

Application interface menu controls

Table 3: Application menu controls descriptions

Item	Description
Tab	Shortcut to a menu in the menu bar or a category of menu options; most tabs are short cuts.
Area	Visual frame with a set of related options.
Option button	Button that defines a particular command or task.
Field	A box to type in text, or to enter a value with the Keypad or a Multipurpose knob.
Check Boxes	Use to select or clear preferences.
Scroll bar	Vertical or horizontal bar at the side or bottom of a display area that can be used for moving around in that area.
Browse	Displays a window where to look through a list of directories and files.
Command button	Button that initiates an immediate action such as Run command button  in the control panel.
Virtual Keypad icon 	Click to use on-screen keypad to enter alphanumeric values.
MP knob references (a or b)  	Identifiers that show which Multi Purpose Knob (MPK) may be used as an alternate means to control a parameter; turn the knob on the oscilloscope front panel to adjust the corresponding parameter Also, the value can be entered directly on the MPK display component.



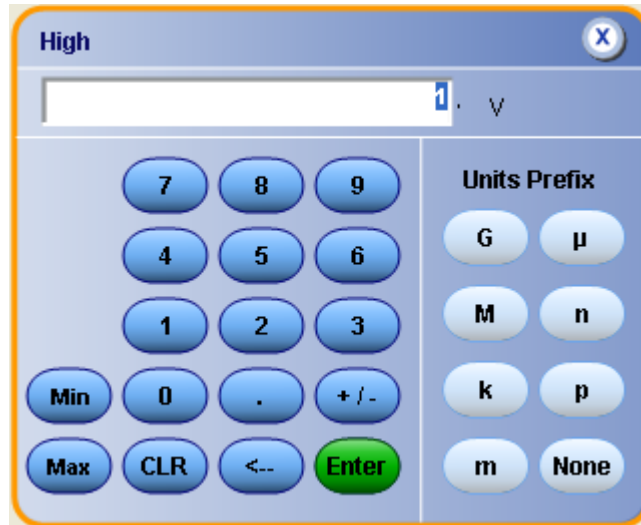

Virtual keypad

Select the  icon and use the virtual keypad to enter alphanumeric values, such as reference voltage levels.



Tips on DPOJET user interface

The following tips help you with the application user interface:

- Use the Serial Data/Jitter Guide to rapidly set up and initiate sets of commonly used measurements. After running the Serial Data/Jitter Guide, you can modify the configuration parameters to meet specific needs.
- Select a measurement to create a measurement and add it to the current measurement table. New measurements initially use the same source as the earlier measurement, or the most recently used source. Click  to change the measurement source or adjust other source parameters such as the reference levels.
- Select any measurement multiple times to create multiple copies. This may be useful if you wish to run the same measurement with different configuration options.
- Use the Single button  to obtain a single set of measurements from a single new waveform acquisition. Pushing the button again before processing has completed will interrupt the processing cycle.
- Use the Run button  to continuously acquire and accumulate measurements. Push the button again to interrupt the current acquisition.
- Use the Recalc button  to perform measurements on the waveform currently displayed on the oscilloscope, that is without performing a new acquisition. This is useful if you wish to modify a configuration parameter and re-run the measurements on the current waveform.

Basic oscilloscope functions

Application directories The installation directory for DPOJET is C:\Program Files\TekApplications\DPOJET. During installation, the application sets up directories for various functions such as to save setup files. The file name extension is used to identify the file type.

Table 4: Application directories

Default directory	Used for
C:\%USERPROFILE%\Tektronix\TekApplications\DPOJET\Images ¹	Exported plot files.
C:\Users\Public\Tektronix\TekApplications\DPOJET\Limits	Pass/fail limits files.
C:\Users\Public\Tektronix\TekApplications\DPOJET\Patterns	Bit patterns.
C:\%USERPROFILE%\Tektronix\TekApplications\DPOJET\Logs ¹	Log files. Consists of three subfolders: <ul style="list-style-type: none"> ■ Statistics for statistics log files (.csv) ■ Measurements for measurement log files (.csv) and ■ Waveforms for worst case waveforms (.wfm)
C:\Users\Public\Tektronix\TekApplications\DPOJET\Masks	Mask files for various serial data standards. For Example - PCIE, FBDIMM, SATA.
C:\%USERPROFILE%\Tektronix\TekApplications\DPOJET\Reports ¹	Report files (.mht).
C:\%USERPROFILE%\Tektronix\TekApplications\DPOJET\Data ¹	Error log file, DPOJETErrors.log.
C:\Users\Public\Tektronix\TekApplications\DPOJET\Examples	Various tutorial and support files.

¹ %USERPROFILE% represents your user location.

File name extensions

Table 5: File name extensions

File Extension	Description
.csv	Ascii file containing Comma Separated Values. This file format may be read by any ascii text editor (such as Notepad) or may be imported into spreadsheets such as Excel.
.xml	Ascii file containing measurement setup information, limits or other data in Extensible Markup Language.
.set	Binary file containing oscilloscope setup information in a proprietary format.
.mht	An HTML archive file, compatible with common Windows applications; and contain the full report, including text and graphics.
.msk	A user mask file.
.wfm	Binary file containing an oscilloscope waveform record in a recallable, proprietary format.

Application menu shortcuts

The DPOJET application provides shortcuts for navigating the user interface. Use **Alt+ A** for the Analyze menu and **Alt+A+J** for Jitter and Eye Analysis (DPOJET). Use **Alt+A+E** for PCI Express and **Alt+A+U** for USB 3.0 Essentials.

NOTE. *is common for all submenus except the Help menu.*

Table 6: Application shortcuts

Menu Items	SubMenu	Shortcut
Wizard	One Touch Jitter	Alt +A+J+J
	Serial Data/Jitter Wizard	Alt +A+J+W
Select		Alt +A+J+S
Configure		Alt +A+J+C
Results		Alt +A+J+R
Plots		Alt +A+J+P
Reports		Alt +A+J+O
Export	Data Snapshot	Alt +A+J+E+D
	Measurement Summary	Alt +A+J+E+S
Data Logging		Alt +A+J+L
Preferences		Alt +A+J+F
Limits		Alt +A+J+I
Global Configuration		Alt +A+J+G
Measurement Summary		Alt +A+J+M
Deskew		Alt +A+J+K
Help		
About DPOJET		Alt +H+J



Menu Items	SubMenu	Shortcut
Help on Jitter and Eye Analysis		Alt +H+T
Help on PCI Express MOI		Alt+H+M
Help on USB 3.0 MOI		Alt+H+U

Returning to the application

When you access oscilloscope functions, the DPOJET control windows may be replaced by the oscilloscope control windows or by the oscilloscope graticule. Access oscilloscope functions in the following ways:

- From the menu bar on the oscilloscope, choose **Analyze > Jitter and Eye Analysis (DPOJET) > Select**.
- Alternatively, switch between recently used control panels using the forward or backward arrows  on the right corner of the control panel.

Warning log notifiers

Warning Log Notifiers display error messages or warnings. Warnings () or Error () messages are also shown in the results tab. You can click **View Log** to view the error log information in a text editor. Click **OK** to discard the displayed error message.

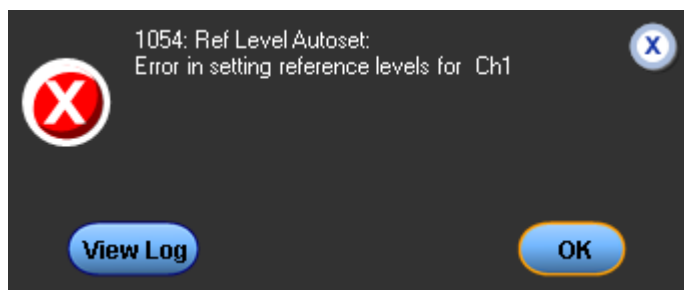

You can set the duration for which the warning notification should appear on the screen in the *Preferences* dialog box or click **OK** to discard the warning information.

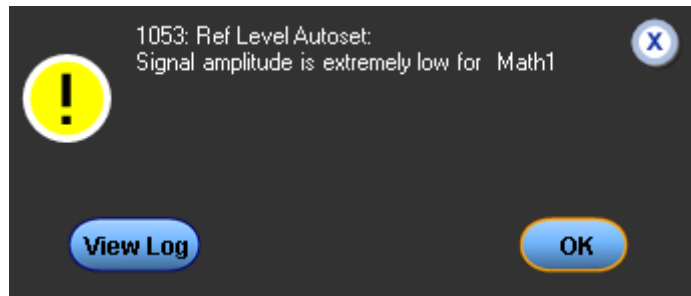

NOTE. The error or warning log is saved as *DPOJETErrors.log* in subfolder, where *%USERPROFILE%* represents your user location.

Saving and recalling setups

Saving a setup

The DPOJET application state is automatically saved with the oscilloscope state. To save the oscilloscope settings and application state, follow these steps:

1. Click **File>Save As >Setup**.
2. In the file browser, select the directory to save the setup file.
3. Select or enter a file name. The application appends *_DPOJET.xml to store DPOJET setup, and *.set to store oscilloscope settings.
4. Click **Save**.

NOTE. After the oscilloscope application is started, DPOJET needs to be launched at least once before any saved DPOJET configuration can be recalled.

Recalling a saved setup

To recall the default application setup and oscilloscope settings, do the following steps:

1. Click **File > Recall**.
2. Select the directory in the file browser to recall the setup file.
3. Select a .set file and click **Recall**.

NOTE. Only .set files can be selected for recall; any corresponding *_DPOJET.xml* file in the same directory will be recalled as well, if DPOJET has been launched at least once since the oscilloscope application was started. If DPOJET has not been launched at least once, the oscilloscope settings will be recalled but the DPOJET configuration will be ignored.

Recalling the default setup

To recall the default application and oscilloscope settings, click **File>Recall Default Setup**.

Jitter, Noise and Eye Diagram Analysis

About Jitter, Noise and Eye-diagram analysis

This section describes the DPOJET measurement and their analysis for real-time oscilloscopes. Using Navigation panel and Control panel DPOJET measurements are selected and analysed.

Control panel The Control panel appears on the right of the application window. Using this panel, you can start or stop the sequence of processes for the application and the oscilloscope to acquire information from the waveform. The controls are Clear, Recalc, Single and Run. The following table describes each of these controls:



Table 7: Control panel selections

Item	Description
Clear	Clears the current result display and resets any statistical results and autoselected reference levels.
Recalc	Runs the selected measurements on the current acquisition.
Single	Initiates a new acquisition and runs the selected measurements.
Run	Initiates a new acquisition and runs the selected measurements repeatedly until Stop is clicked. Used only for live sources.

Item	Description
Show Plots	Displays the plot summary window when clicked. This button appears in the control panel only when a plot is selected.
DDR Analysis	Shortcut to access the DDRA application from DPOJET. Appears in the control panel only when DDRA is opened using Analyze > DDR Analysis.

The control panel with **Show Plots** is as shown:



Navigation panel

The Navigation panel appears on the left of the application window. It consists of the following tabs: Select, Configure, Results, Plots and Reports.

Table 8: Navigation panel functions

Tab	Description
Select	Displays the various measurements available for selection. By default, this tab is highlighted. You can click any measurement categorized with Period/Freq, Jitter, Time, Eye and Amplitude tabs.
Configure	Displays the configuration for the selected measurement.
Results	Displays the result for the selected measurement.
Plots	Displays the result as a two-dimensional plot for additional measurement analysis. You can select and configure plots for selected measurements.
Reports	Displays the configuration for generating reports in .mht format. Allows you to select results, plots and details.

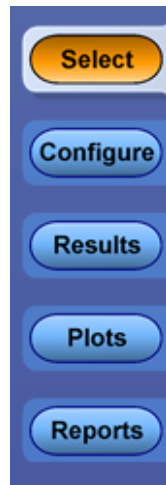

Setting up DPOJET to take measurements

Setting up the application for analysis

In general, setting up the application for analysis consists of these steps:

1. Selecting one or more measurements
2. Configuring parameters for the selected measurements
3. Configuring any global parameters
4. Adding plots to visual measurement results

Steps 2-4 are optional, and step 4 can be done either before or after measurement results have been calculated. In addition to this manual process, several wizard interfaces (One Touch Jitter, Serial Data/Jitter Guide) are available that can streamline the process.

Selecting measurements is accomplished by first selecting a measurement category (Period and Frequency, Jitter and Noise, Time, Eye, Amplitude, or Standard-Specific Measurements) and then choosing specific measurements. A measurement may be selected multiple times, for example to run on different waveform sources or to run on the same waveform source with different parameters.

Refer to the following sections for more details on various measurements:

[*Period and frequency measurements*](#)

[*Jitter measurements*](#)

[*Noise measurements*](#)

[*Time measurements*](#)

[*Eye measurements*](#)

[*Amplitude measurements*](#)

Standard-specific Measurements

Related topics.

Selecting a measurement

Deskew for accurate measurement

Deskew for accurate measurement

To ensure accurate results for two-channel measurements and differential signals acquired on two channels, it is important to first deskew the probes and oscilloscope channels before you take measurements of your *DUT*.

The application includes an automated deskew utility that you can use to deskew any pair of oscilloscope channels.

NOTE. *To produce the best deskew results, you should connect the probes to the fastest slew rate signals from your DUT.*

Connecting to a device under test (DUT). You can use any compatible probes or cable interface to connect between your DUT and oscilloscope.



WARNING. *To avoid electric shock, remove power from the DUT before connecting the probes. Do not touch exposed conductors except with the properly rated probe tips. Refer to the probe manual for proper use. Failure to do so may cause injury or death.*

Refer to the General Safety Summary in your oscilloscope manual.

Deskewing on Oscilloscopes with bandwidth extension. Some Tektronix oscilloscopes feature software-based bandwidth extension. The bandwidth extension may be enabled on a per-channel basis.

Enabling or disabling bandwidth extension on any channel affects the skew on that channel. Thus, you should deskew probes and channels after you make such configuration changes. Bandwidth Extension provides improved timing accuracy, phase matching, and amplitude accuracy. It also will provide noise reduction. Bandwidth extension should be used at all times.

Steps to deskew probes and channels. To deskew probes and oscilloscope channels, follow these steps:

1. Refer to Connecting to a Device Under Test before starting the procedure.
2. Connect both probes to the fastest signal in your DUT.

Set up the oscilloscope as follows:

1. Use the Horizontal Scale knob to set the oscilloscope to an acquisition rate so that there is at least two, preferably five, samples per edge or more samples on the deskew edge.
2. Use the Vertical Scale and Position knobs to adjust the signals to fill the display without missing any part of the signals.
3. Set the Record Length so that there are more than 100 edges in the acquisition.
4. Launch the DPOJET application.
5. Click **Analyze > Jitter and Eye Analysis (DPOJET) > Deskew**.

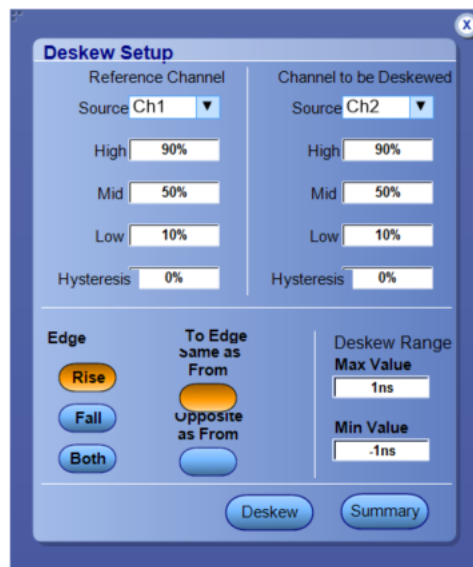

6. Set the Reference channel source to Ch1. The source waveform is the reference point used to deskew the remaining channels.
7. Set the Channel to be Deskewed source as Ch2.
8. To start the process, click **Perform Deskew**.
9. Repeat steps 7 and 8 for other Ch waveforms.
10. Select Summary to view the deskew values.

Deskew summary channel source and deskew values

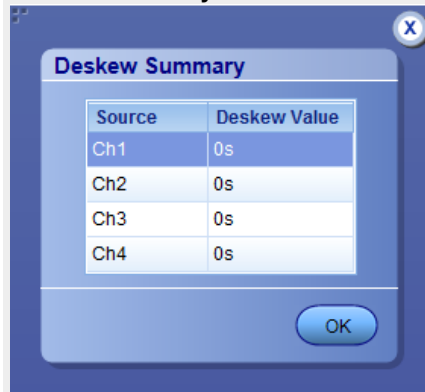

Selecting a measurement

To take a measurement, click **Analyze > Jitter and Eye Analysis (DPOJET) > Select**.

You can select measurements listed under the following categories:

- Period/Freq: [Click here](#) to view the measurements grouped under Period/Freq.
- Jitter: [Click here](#) to view the measurements grouped under Jitter.
- Noise: [Click here](#) to view the measurements grouped under Noise.
- Time: [Click here](#) to view the measurements grouped under Time.
- Eye: [Click here](#) to view the measurements grouped under Eye.
- Amplitude: [Click here](#) to view the measurements grouped under Amplitude.
- Standard: [Click here](#) to view the measurements grouped under Standard.

NOTE. *Noise measurements are accessible only when DJAN - Noise Analysis Tools is enabled.*

- When the Analysis Method is Jitter Only, Jitter tab is displayed and only jitter measurements are accessible under Select panel. Click Analyze > Jitter and Eye Analysis (DPOJET) > Preferences > Jitter Decomp to select the analysis method as Jitter Only.

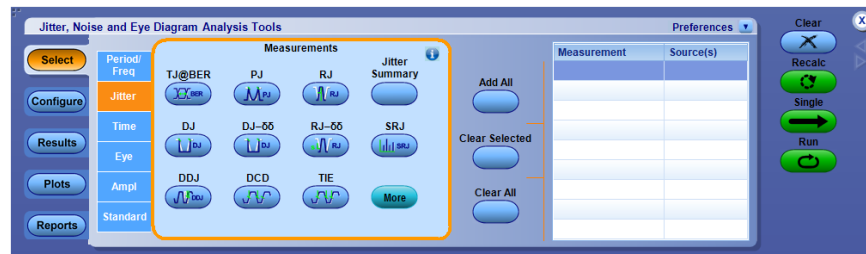

Figure 1: Jitter Only measurements are enabled

- When the Analysis Method is Jitter + Noise, Jitter tab will be displayed as Jitter/Noise with measurements under Select panel. You can also see two radio button for selecting Jitter or Noise measurements. By default Jitter measurements are selected. Click Analyze > Jitter and Eye Analysis (DPOJET) > Preferences > Jitter Decomp to select the analysis method as Jitter + Noise.

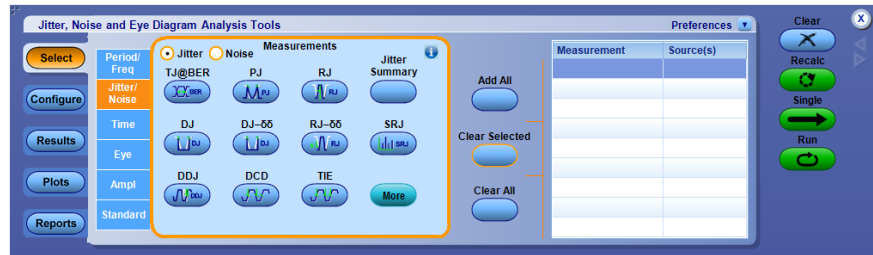

Figure 2: Jitter/Noise measurements are enabled

NOTE. *Preference setup - Jitter Decomp* allows you to enable or disable Noise measurements.

The application provides you different methods to set up the application:

- Wizard

Wizard

The Serial Data/Jitter Guide allows you to set up, configure, and run the selected set of measurements without requiring any knowledge of the control menus. However, it does not provide access to many of the advanced features.

- Measurement Setup sequence

Measurement setup sequence

The Measurement Setup Sequence buttons in the left navigation panel shows the logical order you would follow to set up the application if you do not use the Wizard.

Alternatively, click Analyze > [application name] to personalize DPOJET for a specific standard. For example, to take a PCI Express measurement, click **Analyze > PCI Express** and for USB 3.0 Essentials measurement, click **Analyze > USB 3.0 Essentials**.

Related topics.

[DPOJET option levels](#)

**Table of measurements-
Period/Freq**

Definitions of the period and frequency-related measurements are given in the following table:

Table 9: Period/Frequency measurements definitions

Measurement	Description
Period	For clock signals, the elapsed time between consecutive crossings of the mid reference voltage level in the direction specified; one measurement is recorded per crossing pair. For data signals, the elapsed time between consecutive crossings of the mid reference voltage in opposite directions divided by the estimated number of unit intervals for that pair of crossings; one measurement is recorded per unit interval so N consecutive bits of the same polarity result in N identical period measurements.
Frequency	The inverse of the period for each cycle or unit interval.
CC–Period	The cycle-to-cycle period; the difference in period measurements from one cycle to the next, that is the first difference of the Period measurement.
N–Period	The duration of N periods.
Pos Width	Amount of time the waveform remains above the mid reference voltage level.
Neg Width	Amount of time the waveform remains below the mid reference voltage level.
+Duty Cycle	The ratio of positive width to period, expressed in %.
–Duty Cycle	The ratio of negative width to period, expressed in %.
+CC–Duty	The difference between two consecutive positive widths.
–CC–Duty	The difference between two consecutive negative widths.
Data Rate	This measurement calculates the inverse of the mean duration of all cycles defined by the consecutive starting and stopping edges if the signal is clock and mean duration of the unit intervals, if the signal is data.

**Table of measurements-
Jitter**

By default, the application enables analysis of all jitter components except non-periodic jitter (NPJ). This is because NPJ (a form of bounded uncorrelated jitter (BUJ) that isn't periodic) is less frequently encountered and its analysis typically requires longer waveforms, multiple waveforms, or both. The default processing mode is called Spectral Only. To enable analysis of NPJ, you must set the processing mode to Spectral + BUJ. This is done either from the Preferences-Jitter Decomposition panel or from the Jitter map.

Definitions of the jitter-related measurements are given in the following table.

NOTE. All jitter measurements except TIE are statistical measurements that require sufficient record length so that all deterministic effects can be observed and the random jitter can be modeled.

Table 10: Jitter measurements definitions

Measurement	Description
TIE	Time interval error is the difference in time between an edge in the source waveform and the corresponding edge in a reference clock or explicitly by another source signal. The reference clock is determined by a clock recovery process.
RJ	Random jitter is the statistics for all timing errors not exhibiting deterministic behavior, based on the assumption that they follow a Gaussian distribution. If the Jitter separation model is set to Spectral + BUJ, the Gaussian assumption is further validated and jitter appearing to be non-Gaussian is excluded. Random jitter is characterized by its standard deviation.
RJ- $\delta\delta$	Dual-dirac random jitter is random jitter as defined above, but calculated based on a simplified assumption that the histogram of all deterministic jitter can be modeled as a pair of equal-magnitude dirac functions (impulses known as delta-functions).
DJ	Deterministic jitter is the statistics for all timing errors that follow deterministic behavior. Deterministic jitter is characterized by its peak-to-peak value.
DJ- $\delta\delta$	Dual-dirac random jitter is random jitter as defined above, but calculated on the same simplified model as described under RJ- $\delta\delta$.
PJ	Periodic jitter is the statistics for that portion of the deterministic jitter which is periodic, but for which the period is not correlated with any data in the waveform.
DDJ	Data-dependent jitter is the statistics for that portion of the deterministic jitter directly correlated with the data pattern in the waveform.
DCD	Duty cycle distortion is the statistics for that portion of the deterministic jitter directly correlated with signal polarity, that is the difference in the mean timing error on positive edges versus that on negative edges.
TJ@BER	Total jitter at a specified bit error rate (BER). This combines the random and deterministic effects, and predicts a peak-to-peak jitter that will only be exceeded with a probability equal to the BER.
Jitter Summary	This is not an individual measurement but a convenience function. Pressing this button automatically adds a set of eleven jitter-related measurements with a single action. The measurements are: TIE, RJ, RJ- $\delta\delta$, DJ, DJ- $\delta\delta$, PJ, SRJ, DDJ, DCD, TJ@BER, and Width@BER.
Phase Noise	The RMS magnitude for all integrated timing jitter falling between two specified frequency limits. This measurement is only applicable for clock signals.
NPJ ¹	Non-Period Jitter is the statistics for that portion of the non-deterministic jitter that has a bounded distribution. It is characterized by its dual-dirac amplitude (that is, the amount by which its presence causes an additional separation of the two Gaussian distributions in the dual-dirac model).

¹ The NPJ measurement is only available when the Jitter Separation Model is set to Spectral + BUJ under DPOJET Preferences Setup.

Measurement	Description
J2	Total jitter at a bit error rate (BER) value of 2.5E-3. This statistical value predicts a peak-to-peak jitter that will only be exceeded with a probability equal to the BER.
J9	Total jitter at a bit error rate (BER) value of 2.5E-10. This statistical value predicts a peak-to-peak jitter that will only be exceeded with a probability equal to the BER.
F/N	The peak-to-peak amplitude of periodic jitter occurring at a rate that divides the data rate by an integer. (When a deterministic jitter component could be interpreted either as F/N or DDJ, it is treated as DDJ by convention.)
SRJ	Sub-rate jitter is jitter at rates that integrally divide the data rate. SRJ typically results when a data stream has been created by multiplexing multiple lower-rate streams. SRJ is a subcomponent of PJ, and can be further isolated into F/N components.
RJ(h)	RJ(h) is that component of measured RJ which is due to direct phase modulation.
RJ(v)	RJ(v) is that component of measured RJ which is due to vertical waveform fluctuations, appearing as phase fluctuations due to AM-to-PM conversion on the waveform rising or falling edges.
PJ(h)	PJ(h) is that component of measured PJ which is due to direct phase modulation.
PJ(v)	PJ(v) is that component of measured PJ which is due to vertical waveform fluctuations, appearing as phase fluctuations due to AM-to-PM conversion on the waveform rising or falling edges.
PJrms	Periodic Jitter RMS (PJrms) is the root mean square amplitude for that portion of the deterministic jitter which is periodic but for which the period is not correlated with any data pattern in the waveform. A single PJrms value is determined for each acquisition, by means of RJ-DJ separation analysis.
SJ@Freq	SJ@Freq is a Sinusoidal Jitter measurement which reports the peak to peak amplitude of energy within the narrow spectral band specified by the user. A single SJ@Freq value is determined for each acquisition, by means of TIE spectral analysis.
PkPkCikRJ	PkPkCikRJ is the random component value of the histogram data.
PkPkCikDJ	PkPkCikDJ is the deterministic component value of the histogram data.
PkPkCikTJ	PkPkCikTJ is equal to $RJ * 2 * Q @ BER + DJ$.

Related topics.

[Breakdown of jitter \(Jitter map\)](#)

[Preferences jitter decomp](#)

**Table of measurements-
Noise**

When DPOJET application is first launched, the noise analysis is disabled and no noise measurements appear for selection. To enable noise measurements, click **Preferences > Jitter Decomp** and select the Analysis Method as Jitter + Noise. This option will not appear unless your scope has the optional Jitter + Noise package (DJAN).

The application doesn't attempt to detect non-periodic Bounded Uncorrelated Noise (NPN). This is because NPN is less frequently encountered and its analysis typically requires longer waveforms, multiple waveforms, or both. The default processing mode is called Spectral Only. To enable analysis of NPN, you must set the processing mode to Spectral + BUJ. This is done either from the [Preferences jitter decomp](#) panel or from the Noise map. The following table describes the measurements under Noise.

Table 11: Noise measurements definitions

Measurement	Description
RN	Random noise (RN) is the RMS magnitude of all non-deterministic Gaussian-distributed vertical deviations from the nominal bit amplitude at the specified UI offset of each bit interval.
RN(v)	RN(v) is that component of measured RN which is due to direct amplitude modulation.
RN(h)	RN(h) is that component of measured RN which is due to phase modulation, appearing as noise fluctuations due to PM-to-AM conversion near the center of the unit interval.
DN	Deterministic noise (DN) is the peak-to-peak amplitude for all amplitude variations from nominal bit amplitudes that exhibit deterministic (non-random) behavior.
DDN	Data dependent noise (DDN) is the total vertical eye closure due to bit pattern-correlated vertical variations, at the center of the eye. It is the sum of the positive peak DDN(0) relative to the nominal low level, and the negative peak DDN(1) relative to the nominal high level.
DDN(0)	Data dependent noise 0 (DDN0) is the peak-to-peak amplitude for all bit pattern-correlated vertical variations of low bits from the nominal low level, at the specified UI offset.
DDN(1)	Data dependent noise 1 (DDN1) is the peak-to-peak amplitude for all bit pattern-correlated vertical variations of high bits from the nominal high level, at the specified UI offset.
PN	Periodic noise (PN) is the peak-to-peak amplitude for that portion of the deterministic noise which is periodic, but for which the period is not correlated with any data pattern in the waveform.
PN(v)	PN(v) is that component of measured PN which is due to direct amplitude modulation.
PN(h)	PN(h) is that component of measured PN which is due to phase modulation, appearing as noise fluctuations due to PM-to-AM conversion near the center of the unit interval.

Measurement	Description
NPN ²	Non-Periodic noise (NPN) is the dual-dirac magnitude of that portion of the bounded uncorrelated noise that is not periodic. Bounded uncorrelated noise (BUN) is the collection of amplitude variations that is not correlated to data pattern but which is bounded in vertical amplitude (i.e. does not grow larger as the observation interval is increased). BUN is composed of PN plus NPN.
TN@BER	Total noise at a specified bit error rate (BER). This extrapolated value statistically predicts a peak-to-peak vertical eye closure (at the specified horizontal bit offset) that will only be exceeded with a probability equal to the BER. It is typically not equal to the actual vertical eye closure for a given observation interval.
Unit Amplitude	Unit Amplitude is the difference between nominal high and low values, and it is used to normalize all the other noise measurements if the units are switched from absolute to normalized. The nominal high level is the mean value of the distribution that represents DDN(1), and the nominal low level is the mean value of the distribution that represents DDN(0).
Noise Summary	This is not an individual measurement but a convenience function. Pressing this button automatically adds a set of nine noise-related measurements with a single action. The measurements are: RN, DN, PN, DDN, DDN0, DDN1, TN@BER and NPN ² .

Related topics.

[Breakdown of noise \(Noise map\)](#)

[Preferences jitter decomp](#)

**Table of measurements-
Time**

Definitions of the time-related measurements are given in the following table:

Table 12: Time measurements definitions

Measurement	Description
Rise Time	Elapsed time between the Low reference level crossing and the High reference level crossing on the rising edge of the waveform
Fall Time	Elapsed time between the High reference level crossing and the Low reference level crossing on the falling edge of the waveform
High Time	Amount of time the waveform remains above the high reference voltage level
Low Time	Amount of time the waveform remains below the low reference voltage level
Setup ³	Elapsed time between the designated edge of a data waveform and that of a clock waveform, based on the respective mid reference level crossings

² The NPN measurement is only available when the Jitter Separation Model is set to Spectral + BUJ under DPOJET Preferences Setup.

³ Two Source Measurements.

Measurement	Description
Hold ³	Elapsed time between the designated edge of a clock waveform and that of a data waveform, based on the respective mid reference level crossings
Rise Slew Rate	Rate of change of voltage between the two chosen reference level crossings on the rising edges of the waveform
Fall Slew Rate	Rate of change of voltage between the two chosen reference level crossings on the falling edges of the waveform
Skew ³	Time difference between two similar edges on two waveforms assuming that every edge in one waveform has a corresponding edge (either the same or opposite polarity) in the other waveform; edge locations are determined by the mid reference voltage level.
SSC Profile	SSC Profile is not intended to serve as a measurement. It is a vehicle for showing the SSC modulation profile versus time, using a time trend plot.
SSC Mod Rate	SSC Mod Rate computes the SSC modulating frequency.
SSC Freq Dev	SSC frequency deviation in ppm (parts per million), measured at each inflection point in the modulation profile
SSC Freq Dev Min	The minimum frequency shift as a function of time
SSC Freq Dev Max	The maximum frequency shift as a function of time
Time Outside Level.	Time Outside Level Ring Back is defined as the time interval of overshoot or undershoot.
tCMD-CMD ⁴	tCMD-CMD is a timing measurement and it measures the elapsed time between two logic states on a specified digital bus.

**Table of measurements-
Eye**

Definitions of the eye-related measurements are given in the following table:

Table 13: Eye measurements definitions

Measurement	Description
Autofit Mask Hits	The number of unit intervals for which mask violations occurred. A mask violation occurs when, during a unit interval, the waveform passes through a segment of the defined mask. Autofit mask hits are separately tailed for Segment 1 (upper), Segment 2 (Center) and Segment 3 (lower) and the total for all three segments is also reported. Autofit Mask Hits reports mask hits in terms of Pixel (not UI) and only the Segment 2 (Middle) is considered as criteria for mask hits calculation and it will move the mask a location where the minimum or zero hits are happening.
Height	The measured clear vertical eye opening at the center of the unit interval. Height = High(min) – Low(max)
Height@BER	The eye height at a specified Bit Error Rate
Width	Measured clear horizontal eye opening at the middle reference level. Width = UI(mean) – TIE(max) – TIE(min)

⁴ This measurement is available only on 64-bit MSO instruments.

Measurement	Description
Width@BER	<p>The horizontal eye opening projected to correspond to a specified Bit Error Rate. This number is obtained by measuring the jitter on the waveform, performing RJ-DJ separation analysis, creating a bathtub curve, and reporting the bathtub width at the appropriate error rate. This eye width may not match the observed eye width because it is a statistical measure. The measurement requires a sufficient record length so that all deterministic effects can be observed and the random jitter can be modeled.</p> $\text{Width(BER)} = \text{UI}(\text{mean}) - \text{TJ}(\text{BER})$
Mask Hits	<p>The number of unit intervals for which mask violations occurred. A mask violation occurs when, during a unit interval, the waveform passes through a segment of the defined mask. Mask hits are separately tallied for Segment 1 (upper), Segment 2 (center-of-eye mask) and Segment 3 (lower), and the total for all three segments is also reported. Thus, as many as three hits can be added to the total count for each unit interval. The population for this measurement gives the total number of unit intervals observed.</p>
Eye High	<p>The voltage at a selected horizontal position across the unit interval, for all High bits in the waveform.</p>
Eye Low	<p>The voltage at the selected horizontal position across the unit interval, for all Low bits in the waveform.</p>
Q-Factor	<p>Quality Factor is the ratio of vertical eye opening to rms vertical noise.</p>
DFE EW	<p>This measurement is used to calculate the Eye Width of input waveform in a non-parametric manner from the rendered eye diagram. The rendered plot is processed to come up with the optimal eye width value. The measurement also comes with dedicated configuration panel tab "DFE".</p> <p>The DFE tab allows you to adjust the configuration parameters such as DFE tap value, measurement point as a % of peak to peak of the signal, and the resolution of the measurement.</p>
DFE EH	<p>This measurement is used to calculate the Eye Height of input waveform in a non-parametric manner from the rendered eye diagram. The rendered plot is processed to come up with the optimal eye height value. The measurement also comes with dedicated configuration panel tab "DFE"</p> <p>This DFE tab allows you to adjust the configuration parameters such as DFE tap value, measurement point as a % of UI of the signal, and the resolution of the measurement.</p>
DFE Eye Diagram	<p>This measurement is used to render the Eye Diagram representation of input waveform with or without a mask file specified. By default, this measurement is executed without any mask, but the configuration panel also gives you the option to specify a particular mask file.</p>
V-Widest Open Eye	<p>This measurement measures the voltage at the widest eye opening in the search range from 40% to 60% of the eye amplitude.</p>

**Table of measurements-
Amplitude**

Definitions of the amplitude-related measurements are given in the following table:

Table 14: Amplitude measurements definitions

Measurement	Description
High	The High Amplitude measurement calculates the nominal amplitude of a "1" bit, in one of two ways depending on the selected Method. Note that the Mean method results in one measurement value for each "1" bit of the selected type, whereas the Mode method results in a single measurement value for the entire waveform record.
Low	The Low Amplitude measurement calculates the nominal amplitude of a "0" bit, in one of two ways depending on the selected Method. Note that the Mean method results in one measurement value for each "0" bit of the selected type, whereas the Mode method results in a single measurement value for the entire waveform record.
High-Low	Difference between High and Low amplitude measurements that bound each selected transition. This value is always expressed as a positive number, regardless of whether the transition is rising or falling.
DC Common Mode ⁵	Common-mode voltage for the two sources. $\text{Mean} \left(\frac{\text{Source1} + \text{Source2}}{2} \right)$
AC Common Mode ⁵	The common mode voltage between two single-ended signals. AC is defined as all the frequency components above the cutoff frequency (30 kHz).
T/nT-Ratio	Ratio of the transition eye-voltage to the nearest subsequent non-transition eye voltage, expressed in decibels.
V-Diff -Xovr ⁵	Voltage level at the crossover voltage of a differential signal pair.
Overshoot	Difference between the positive-going peak amplitude and the reference voltage level, for each waveform event that exceeds the reference level.
Undershoot	Difference between the negative-going peak amplitude and the reference voltage level (expressed as a positive number), for each waveform event that exceeds the reference level.
Cycle Pk-Pk	Difference between the maximum and minimum voltage for each cycle, where a cycle is defined as a positive half-cycle followed by a negative half-cycle or a negative half-cycle followed by a positive half-cycle. Half-cycles are determined by the mid reference level crossings.
Cycle Min	Defined as the peak negative voltage for each negative half-cycle, where half-cycles are determined by the mid reference level crossings.
Cycle Max	Defined as the peak positive voltage for each positive half-cycle, where half-cycles are determined by the mid reference level crossings.

⁵ Two Source Measurements.

**Table of measurements-
Standard**

Standard-specific measurements in the this category may include timing, jitter, amplitude or eye measurements. Generally, they are measurements that have been modified to support a specific standard or otherwise deviate from the generic measurements. Use the Standard drop-down list to view the DDR, PCI Express, USB and Optical measurements. Use the [Test point selection](#) when available, to select the setup file specific to the standard. Their measurement definitions are given in the following table:

Table 15: Standard-specific measurements definitions

Measurement	Description
PCI Express	
PCIe T-Tx-Diff-PP	Defined as the change in voltage level across a transition in the waveform. It is the peak-to-peak differential voltage swing.
PCIe T-TX	Defined as the measured clear horizontal eye opening at the middle reference level.
PCIe T-Tx-Fall	Defined as the time difference between the VRefLo(20%) reference level crossing and the VRefHi(80%) reference level crossing on the falling edge of the waveform.
PCIe Tmin-Pulse	Defined as the single pulse width measured from one transition center to the next.
PCIe DeEmph	Defined as the ratio of the transition eye-voltage to the nearest subsequent non-transition eye voltage, expressed in decibels.
PCIe T-Tx-Rise	Defined as the time difference between the VRefHi(80%) reference level crossing and the VRefLo(20%) reference level crossing on the rising edge of the waveform.
PCIe UI	For clock signals, the elapsed time between consecutive crossings of the mid reference voltage level in the direction specified; one measurement is recorded per crossing pair. For data signals, the elapsed time between consecutive crossings of the mid reference voltage in opposite directions divided by the estimated number of unit intervals for that pair of crossings; one measurement is recorded per unit interval so N consecutive bits of the same polarity result in N identical period measurements.
PCIe Med-Mx-Jitter	Defined as the maximum time between the jitter median and the maximum deviation from the median.
PCIe T-RF-Mismch	Defined as the mismatch between Rise time (TRise) and Fall time (TFall).
PCIe MAX-MIN Ratio ⁶	Defined as the voltage range ratio over which a particular receiver must operate for consecutive UI.
PCIe SSC FREQ DEV	Defined as the SSC frequency deviation in ppm (parts per million).
PCIe SSC PROFILE	Shows the modulation profile of the SSC.
PCIe AC Common Mode ⁷	The common mode voltage between two single-ended signals. AC is defined as all the frequency components above the cutoff frequency (30 kHz).

⁶ Custom name for PCIe MAX-MIN Ratio is PCIe VRX-MAX-MIN Ratio.

⁷ Two Source Measurements.

Measurement	Description
T-TX-DDJ	Defined as the time delta between the PDF's mean for each zero crossing point and the corresponding recovered clock edge.
T-TX-UTJ	Referenced to a recovered data clock generated by means of a CDR tracking function. Uncorrelated total jitter may be derived after removing the DDJ component from each PDF and combining the PDFs for all edges in the pattern.
T-TX-UDJDD	Defined as uncorrelated jitter at the zero crossing point and the corresponding recovered clock edge.
T-TX-UPW-TJ	Defined as an edge-to-edge phenomenon on consecutive edges.
T-TX-UPW-DJDD	Defined as uncorrelated PWJ at the zero crossing.
V-TX-NO-EQ	Defined by setting c_{-1} and c_{+1} to zero and measuring the p-p voltage on the 64-ones/64-zeroes segment of the compliance pattern.
V-TX- EIEOS	Defined by setting c_{+1} coefficient value of -0.33 and a c_{-1} coefficient of 0.0 and measuring the p-p voltage on the 8-ones/8-zeroes segment of the compliance pattern, where the pattern is repeated for a total of 128 UI.
ps21TX	Measured by comparing the 64-zeroes/64- ones p-p voltage (V111) against a 1010 pattern (V101).
V-TX-BOOST	When c_{-1} and c_{+1} are non-zero, measure the PP voltage on the 64-ones/64-zeroes segment of the compliance pattern and with immediate single transition bit voltage.
USB 3.0 Essentials	
USB VTx-Diff-PP	Defined as the change in voltage level across a transition in the waveform. It is the peak-to-peak differential voltage swing.
USB TCdr-Slew-Max ⁸	This measurement finds the peak-to-peak period jitter. Period jitter can be obtained by taking the first difference of the filtered phase jitter.
USB Tmin-Pulse-Tj	Defined as the single pulse width measured from one transition center to the next including all jitter sources.
USB Tmin-Pulse-Dj	Defined as the minimum pulse width with only deterministic jitter components.
USB SSC MOD RATE	Defined as the SSC modulation rate in terms of Hz.
USB SSC FREQ DEV MAX	Defined as the maximum frequency shift as a function of time.
USB SSC FREQ DEV MIN	Defined as the minimum frequency shift as a function of time.
USB SSC PROFILE	Shows the modulation profile of the SSC.

⁸ To run a slew rate measurement, you need a waveform with minimum record length of 5 MB.

Measurement	Description
USB UI	For clock signals, defined as the elapsed time between consecutive crossings of the mid reference voltage level in the direction specified; one measurement is recorded per crossing pair. For data signals, defined as the elapsed time between consecutive crossings of the mid reference voltage in opposite directions divided by the estimated number of unit intervals for that pair of crossings; one measurement is recorded per unit interval so that N consecutive bits of the same polarity result in N identical period measurements.
USB AC Common Mode ⁹	The common mode voltage between two single-ended signals. AC is defined as all the frequency components above the cutoff frequency (30 kHz).
Optical	
AOP (Average optical power)	The true average component of an optical signal, in Watts.
ER (Extinction ratio)	The ratio of average power levels of the logic 1 level (High) to the logic 0 level (Low) of an optical signal. All level determinations are made within the Eye Aperture. The Eye Aperture is adjustable and defaults to 20% of the signal bit time.
OMA (Optical modulation amplitude)	The difference between the average power levels of the logic 1 level (High) to the logic 0 level (Low) of an optical signal. All level determinations are made within the Eye Aperture. The Eye Aperture is adjustable and defaults to 20% of the signal bit time.
Optical High	The Optical High measurement calculates the nominal amplitude of a "1" bit, in one of two ways depending on the selected Method. Note that the Mean method results in one measurement value for each "1" bit of the selected type, whereas the Mode method results in a single measurement value for the entire waveform record.
Optical Low	The Optical Low measurement calculates the nominal amplitude of a "0" bit, in one of two ways depending on the selected Method. Note that the Mean method results in one measurement value for each "0" bit of the selected type, whereas the Mode method results in a single measurement value for the entire waveform record.
Eye Crossing Level	The Eye Crossing Level measurement lists the voltage/watts level where the rising and falling edges of the eye waveform intersect (PCross ₁ and PCross ₂). The measurement algorithm searches for the eye waveform with narrowest crossing width.
Eye Crossing Time	The Eye Crossing Time measurement is the time of a single eye crossing waveform in seconds (TCross ₁).
Eye Crossing Percent	Eye Crossing Percent measurement is an eye crossing point expressed as a percentage of the eye waveform height.

⁹ Two Source Measurements

Measurement	Description
Mask Hit Ratio	A Mask Hit Ratio is the ratio of number of UI that have a mask hit and total number of UI observed. Mask Hit Ratio = (# of UI that have a mask hit) / (total # of UI observed)
Mask Margin	The concept of margin allows for more information to be shared than merely Pass/Fail decision. We assume the position of level values and unit interval boundary as 100% and original mask location as 0%. Hence a 20% mask margin implies that the mask violations does not occur even after scaling the original mask by this amount.

Test point selection in the standard tab

Test Point Selection is available only for PCI Express, USB, and MIPI standards. You can either use the Test Point “Setup” button or File > Recall option to select the setup file for the selected standard.

The Test Point shows “None Selected” if no test point is specified. Click Setup to navigate to the directory, which contains the setup files specific to the standard.

The setup file with oscilloscope settings and test measurements replaces any selected measurements and oscilloscope settings before specifying the test point. A warning message is displayed as shown:

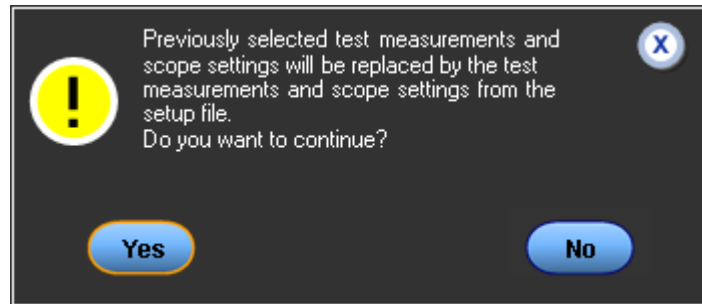

Once the test point is selected, the measurements associated with the test point are displayed in the measurement table and the configuration specific to the standard is recalled. However, you can still add the measurements specific to the standard. At any time, you can save the setup file to recall. The Test Point field displays only the Test point name. A tool tip displays the entire file name as shown:

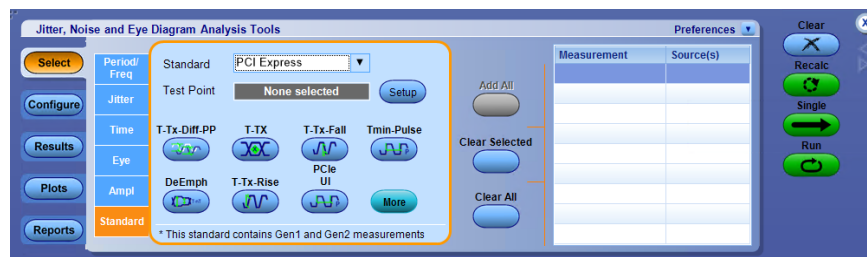

When you select PCI Express from the Standards list, a hint saying “This standard contains Gen1 and Gen2 measurements” as shown:

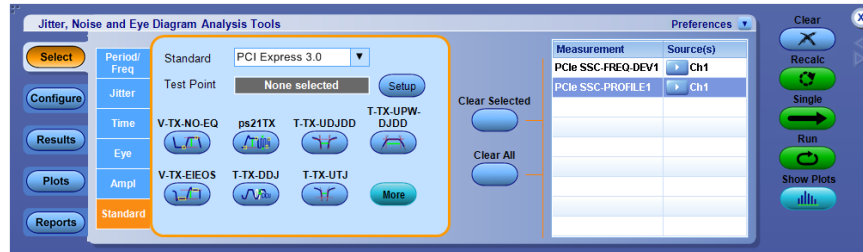

Configuring measurements

About configuring a measurement

You can configure the measurements listed under the following categories:

- Period/Freq
- Jitter/Noise
- Time
- Eye
- Amplitude
- Standard

NOTE. Configuration for respective measurements are displayed only when measurement is selected.

NOTE. When noise measurements are enabled, Jitter tab is displayed as Jitter/Noise.

Related topics.

[Correlation of measurement to configuration](#)

[Global](#)

[General](#)

[Filters](#)

[Clock recovery](#)

[Bit config](#)

[BER](#)

[RJ-DJ](#)

[RN-DN](#)

[Configuring bus states](#)

[Edges](#)

[Spread spectrum clocking \(SSC\)](#)

[Margin](#)

General

Configuration tab allows you to customize the measurement name and qualify the measurement within a selected result range. The General tab appears same for all the measurements but is not common. The values are different for different measurements. You can set the custom name per measurement here. Use the virtual keyboard to enter the measurement name of your choice. Measurements selected in DDRA are the custom names for the measurements defined in DPOJET. A tool tip displays the custom name and the DPOJET-based measurement name (in brackets) on moving the mouse over the row in the measurement table, results, data snapshot, and measurement configuration summary.

NOTE. Custom measurement names revert to their DPOJET-based measurement names on being cleared in the General configuration screen.

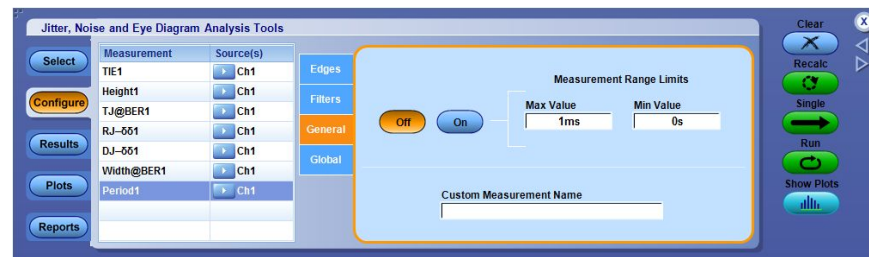

Table 16: General options

Item	Description
Off	Disables the application from using the specified measurement limits.
On	Enables the application to use the specified measurement limits.
Max or Min value	Specify the maximum and minimum range of valid measurement values measurements. The default values for the Measurement Range Limits options vary by measurement.
Custom Measurement Name	Option to modify the measurement name. Allows adding a user-specified name to any measurement. This is useful for aligning DPOJET measurements with a user measurement list or standard.

NOTE. *If a max value smaller than the min value is entered, it is accepted and the min value is also silently reduced to the same value. Likewise, if a min value larger than the max is entered, both are set to that value.*

Global **About global.** This configuration tab is common for all measurements. You can limit the waveform data analysis by Gating, by applying a Qualifier, or by setting the measurement population limits. Access the Global configuration directly from the oscilloscope menu under **Analyze > Jitter and Eye Analysis (DPOJET) > Global Configuration.**

- [Gating](#)
- [Qualify](#)
- [Population](#)



Gating. Gating allows you to focus the analysis on a specific area of the waveform bounded by a gated region, which is a way to filter unnecessary information.

You can set up a gated region in one of the following ways:

- Zoom
- Cursors



Table 17: Global-Gating options

Item	Description
Off	No gating occurs; application takes measurements over the entire waveform.
Zoom	Zooms the specified region of the source waveform to take measurements within the selected area. The region of waveform within the zoom is analyzed.
Cursors	Gates the waveform with Vertical cursors. The region of waveform within the cursors is analyzed.

Qualify. Qualifiers allows you to limit the application to more narrowly defined conditions before taking measurements. All sources for the measurements and Qualify input must have the same Horizontal Sample Rate, Record Length, and Position to ensure that measurements function properly. For measurements which require clock recovery such as TIE or eye measurements, only the first qualified region will be measured even if multiple qualified regions are present. For all other measurements, the entire waveform is processed.

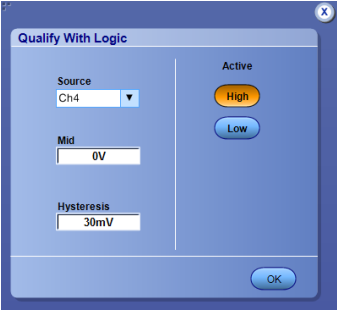



Table 18: Global-Qualify options

Item	Description
Off	Disables the application from using the defined conditions while taking measurements.
On	Enables the application to use the defined conditions while taking measurements.
Configure	Displays the <i>Qualify with logic</i> dialog box.

Configuring qualify with logic.

Table 19: Qualify-Configure options

Source		Ch1-Ch4, Ref1-Ref4, Math1-Math4	Search0-Search8	
Configuration Panel				
Configure options	Item	Description		
	Source ¹	Selects a waveform to qualify the signal or clock source used for the measurement. The input source waveforms or files are Ch1-Ch4, Ref1-Ref4, and Math1-Math4.	Selects a waveform to qualify the signal or clock source used for the measurement. The input source waveforms or files are Search0-Search8 . Displays the burst control type selected in DDRA when you turn on the qualifier. Also indicates that ASM is turned on.	
	Mid	Shows the vertical reference level of the qualifier waveform. ²		
	Hysteresis	Shows the amount of hysteresis applied to the vertical reference level of the qualifier waveform. Hysteresis prevents small amounts of noise in a waveform from producing multiple threshold crossings.		
	Active			
	High ¹²	Enables measurements in regions ³ where the qualifier waveform exceeds the mid reference level.		
	Low ¹²	Enables measurements in regions ¹² where the qualifier waveform falls below the mid reference level.		
OK	Accepts the changes and closes the window.			

¹ Measurement and Qualify sources must have the same Horizontal Sample Rate, Record Length, and Position to ensure that measurements function properly.

² The default behavior for all reference levels is to automatically adjust based on the signal amplitude after a Clear operation, unless you disable the autoset check box in the source configuration panel. Whether you use the Qualify with Logic dialog box to adjust the levels or not, be aware that the levels may change if automatic adjustment is still enabled. For more information, refer to [Automatic versus manual reference voltage levels](#).

³ For measurements that require clock recovery, only the first qualified region will be measured even if multiple qualified regions are present.

Search behavior in DPOJET. When search is configured, the application analyzes the identified marks on the source waveform. Read and Write bursts are selected in ASM when search is selected as the qualify source. Each Mark indicates the start and stop of a burst. These marks are used by the DPOJET measurement when the qualify source is configured to **Search**. You can configure up to eight searches (Search1 – Search8) in ASM (Advanced Search and Mark) and Search0 for visual search. The same search number gets reflected in DPOJET. Search is used for Multiple burst analysis. For more details, refer to your oscilloscope online help.

Population. The Population control allows you to limit the amount of waveform data that is analyzed. This is often done in industry standards to make sure that there is consistency between measurement techniques.



Table 20: Global-Population options

Item	Description
Off	Disables the application from using a Population limit while taking measurements.
On	Enables the application to use a Population limit while taking measurements. ⁴
Configure	Displays the <i>Population limit</i> dialog box. This allows you to set a limit on a maximum population to obtain, for selected measurements.

⁴ If population limit is turned ON for the Mask Hits measurement, then unselect Enable high-performance eye rendering in *Preferences Tab* for accurate results.

Configuring population limit.

Table 21: Population-Configure options

Item	Description
Population	The limit determines the population of measurement observations that will be accumulated. Some measurements may accumulate observations more quickly than others.
Acquisitions	The limit determines the number of acquisition cycles that will be performed.
Each Measurement	Each measurement stops accumulating as soon as it reaches the specified limit. Sequencing does not stop until all measurements have reached the limit, at which time every measurement will have exactly the limit.
Last Measurement	Sequencing continues and all measurements continue accumulating until the last (slowest accumulating) measurement reaches the limit, at which time they all stop. When sequencing stops, all measurements except one may have higher population than the limit.
Limit	Specifies the number of acquisitions or measurements the application takes before sequencing stops. Population limit is not applicable for Mask Hits.
OK	Accepts the changes and closes the window.

Filters **About filters.** This configuration tab allows you to modify the measurement data by applying a High Pass filter to block low frequency band components or a Low Pass filter to block high frequency band components. For Example, Selecting a 1 MHz high pass filter can reduce the effect of SSC on results.

For some measurements (Period, Frequency, TIE, +Duty Cycle, -Duty Cycle, +CC Duty, - CC Duty, CC-Period, Positive Width, Negative Width, N-Period, Rise Time, Fall Time, Low Time, High Time, DC Common Mode, High-Low, High, Low, T/nT Ratio, PCIe T-Tx-Rise, PCIe T-Tx-Fall, PCIe T-RF-Mismch, PCIe UI, USB UI, PCIe SSC FREQ DEV, USB TCdr-Slew-Max, USB SSC FREQ DEV, USB SSC MOD RATE and USB SSC PROFILE), the measurements versus time waveform (time trend) that is derived from the original oscilloscope waveform can be filtered before it is passed to the statistics and plotting subsystems.

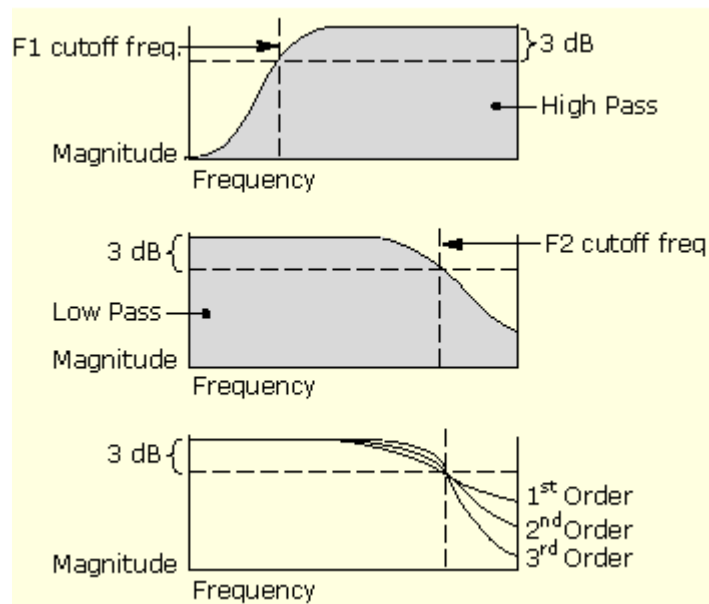

Band Pass Filtering. You can create a band pass filter by enabling both the High Pass and the Low Pass filters on a measurement. The cut-off frequency for the Low Pass filter must be greater than or equal to the cut-off frequency for the High Pass filter.

You should be aware that setting the cut-off frequencies close to each other may effectively filter out all of the measurement data, or all but a small amount of timing noise. This diagram shows the spectrum of the measurement data passed to the statistics and plotting subsystems when you use both the High Pass and the Low Pass filters.

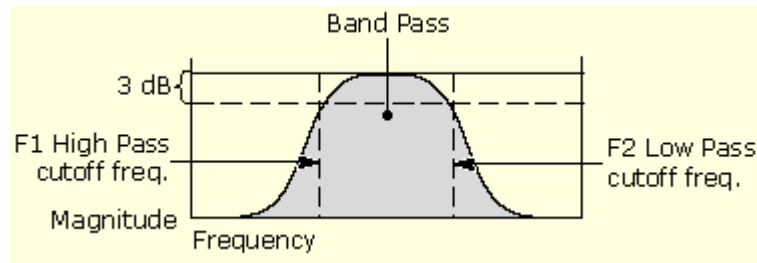

High Pass filters attenuate low frequencies, and filter out DC values entirely. When a high pass filter is added to a period or frequency measurement, the mean value of the filtered measurement goes to zero. This can be seen by creating a Time Trend plot of a high-pass-filtered period or frequency measurement. Although this is the correct theoretical behavior for the filtered measurement, it is not very useful if the Results panel reports that the mean period or frequency is zero. For this reason, the mean values that appear in the results panels for Period and Frequency measurements are the values before the filter.

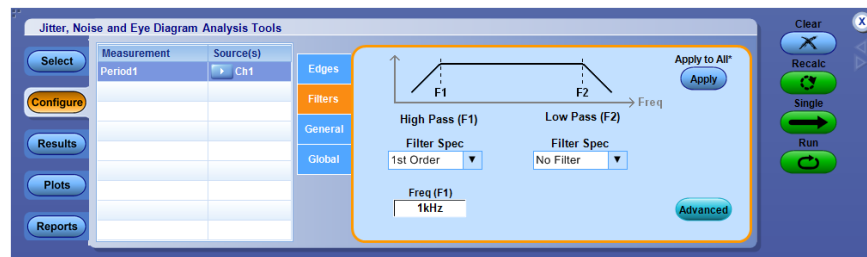

Table 22: Filter options

Item	Description
Filter Spec	When enabled, blocks the low frequency band and passes only the high frequency band of the waveform; defined as 1 st order, 2 nd order, 3 rd order Butterworth and No filter, being the default.
Freq (F1) ¹	High Pass filter cut-off frequency at which the filter magnitude falls by 3 dB.
Filter Spec	When enabled, blocks the high frequency band and passes only the low frequency band of the waveform; defined as 1 st order, 2 nd order, 3 rd order Butterworth, and No filter, being the default.
Freq (F2) ¹⁴	Low Pass filter cut-off frequency at which the filter magnitude falls by 3 dB.
Advanced	Displays the <i>Advanced filter configuration</i> dialog box.
Apply to All	Settings of the measurement are applied to all measurements with those settings.

¹ Includes a 3 dB cut-off frequency.

Measurements such as AC Common Mode, PCIe AC Common Mode, and USB AC Common Mode use a high-pass sliding window filter. This filter is applied to remove low frequency common mode noise. It has a 30 kHz cutoff frequency.

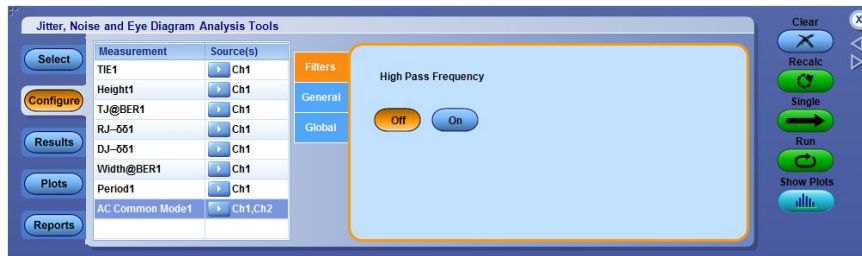
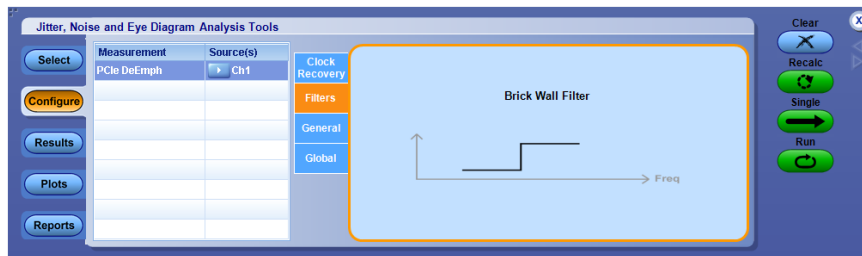

Table 23: Filter options

Item	Description
High Pass Frequency	
Off	High pass frequency is set to Off. Default configuration of High pass frequency for measurements is Off.
On	High pass frequency is set to On.

Brick wall filter configuration. Measurements such as PCIe DeEmph and PCIe Med-Mx Jitter use the Brick Wall filter. A brick wall filter is applied to the PCIe signal to remove the low frequency jitter components. The PCI Express application applies the filter as per the PCIe specification. A Brick Wall filter has a very sharp cut-off frequency.



Advanced filter configuration. The measurement filters are implemented using infinite impulse response (IIR) designs. As with any causal filter, a transient may occur at the filter’s output in response to the arrival of the input signal. It is usually desirable to exclude this transient from the measurement results.

In the DPOJET application, the filter transient is managed in two ways. First, the input to the filter is gently “ramped up” from zero to its full value over some ramp time t_r . Second, the output of the ramp is “blanked” over some duration t_b , so that the remaining effects of any transient are omitted from measurement results, statistics and plots. The sequence of operations is depicted here:

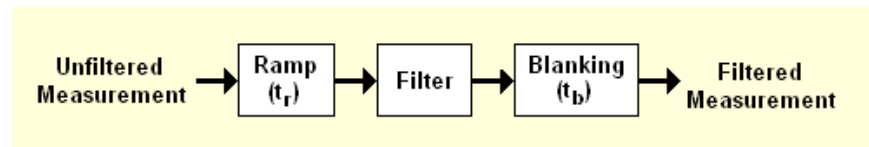

The ramp function has a raised-cosine profile and is defined in the time domain as:

$$\frac{1}{2} \left[1 - \cos\left(\pi * \frac{t}{t_r}\right) \right] \quad 0 < t \leq t_r$$

$$1 \quad t > t_r$$

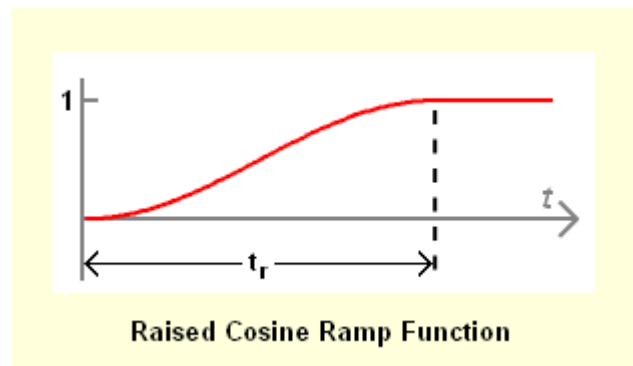

You may adjust the ramp time t_r by means of the Advanced control panel. If you wish to turn off the ramp function, set the ramp time to 0.

Similarly, you can adjust the blanking duration t_b by means of the Advanced control panel. Setting the blanking duration to 0 will allow you to see the entire filtered measurement, including any transients.

Both, the ramp time t_r and the blanking duration t_b , are set relative to the reciprocal of the lowest filter frequency F_c . By default, both of these parameters are set to $1/F_c$. Since they are normalized to the filter frequency, they will automatically adjust if you change the filter cut-off frequency.

The complete set of signal processing options, together with representative waveforms that suggest how the options affect the measurement vector, are shown here:

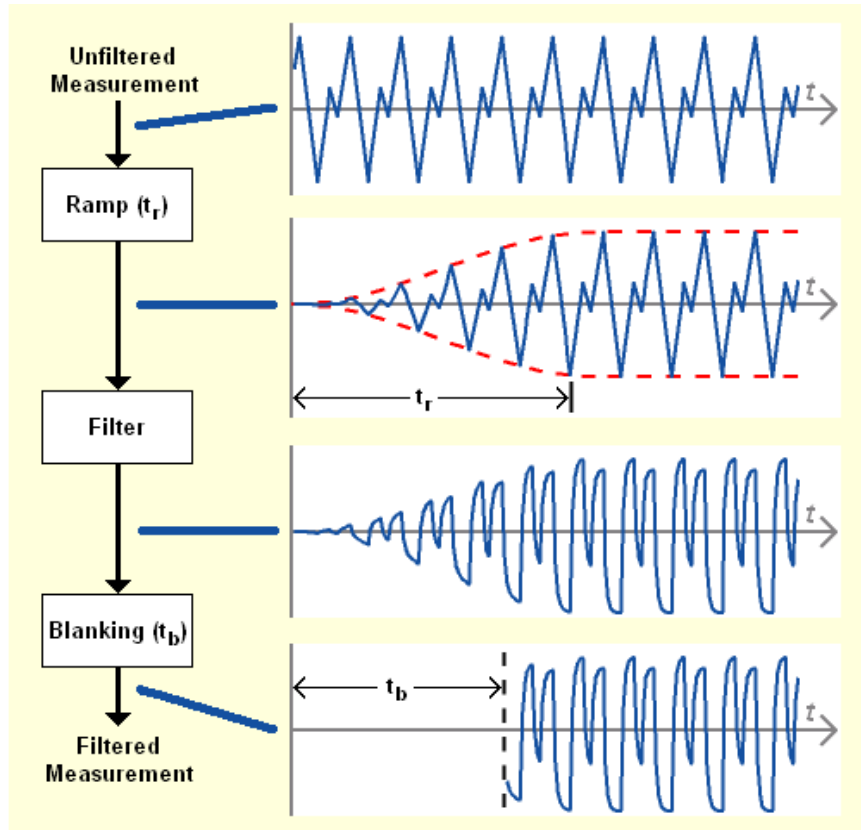

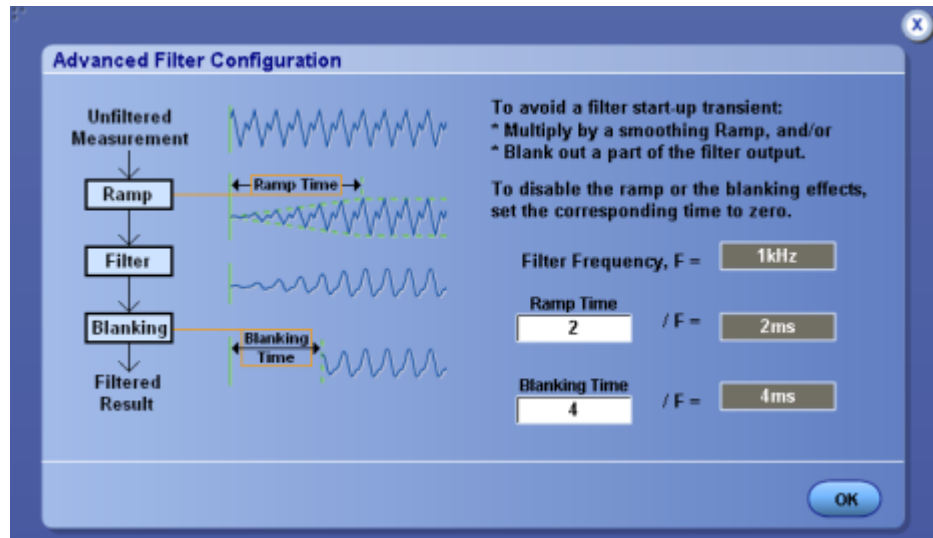

Table 24: Advanced filter configuration options

Item	Description
Ramp Time	Duration of the raised-cosine smoothing function applied to the measurement vector before the vector is filtered.
Blanking Time	Duration of the filter's output that is suppressed. The blanked portion of the output is not included in the measurement statistics, or in any plots.
OK	Accepts changes and closes.

Configuring Filters for SJ@Freq. This configuration tab allows you to select the SJ Frequency and SJ Bandwidth.

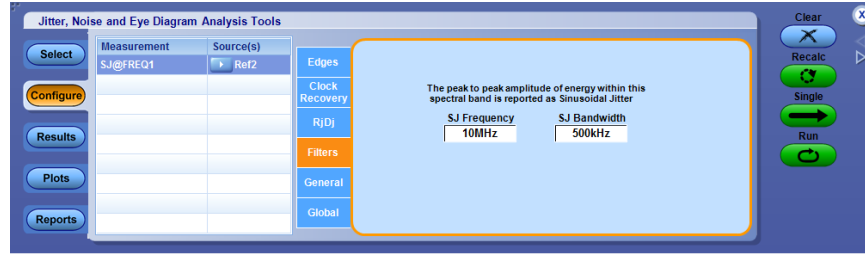

Table 25: Configuring Filters for SJ@FREQ

Item	Description
SJ Frequency	The frequency at which Sinusoidal Jitter measurement is calculated.
SJ Bandwidth	Narrow band around which Sinusoidal Jitter measurement is calculated. A high limit of 1 MHz will be optimal.

NOTE. *The peak to peak amplitude of energy within this spectral band is reported as a Sinusoidal Jitter.*

Clock recovery

About clock recovery. Clock recovery refers to the process of establishing a reference clock, the edges of which can be used as a basis for timing comparisons. The Clock Recovery configuration tab allows you to select one of the following clock recovery methods:

- Constant Clock - Mean*
- Constant Clock - Median*
- Constant Clock - Fixed*
- Phase locked loop standard bandWidth*
- Phase locked loop custom bandWidth*
- Explicit Clock - Edge*
- Explicit Clock - PLL*

The first five methods derive the reference clock from the same channel upon which the measurement is defined. This is the conventional method of clock recovery for serial data communications, where no separate clock is available. The last two methods (Explicit Clock) derive the reference clock from a channel other than the one upon which the measurement is defined.

About constant clock recovery. In Constant Clock Recovery, the clock is assumed to be of the form $A \cdot \sin(2\pi ft + \Phi)$, where the frequency (f) and phase (Φ) are treated as unknown constants. Once a source waveform has been acquired and the edges extracted, one or both of these constants are determined using linear regression, so that the recovered clock minimizes the mean squared sum of the Time Interval Error (TIE) for that waveform.

If Constant Clock - Mean is selected as the clock recovery method, both the frequency and the phase are chosen to minimize the mean squared error.

If Constant Clock - Fixed is selected as the clock recovery method, the precise frequency specified is used but the phase is chosen so that the median error between the recovered and measured edges is zero.

If Constant Clock - Median is selected as the clock recovery method, the phase is chosen so that the median error between the recovered and measured edges is zero.

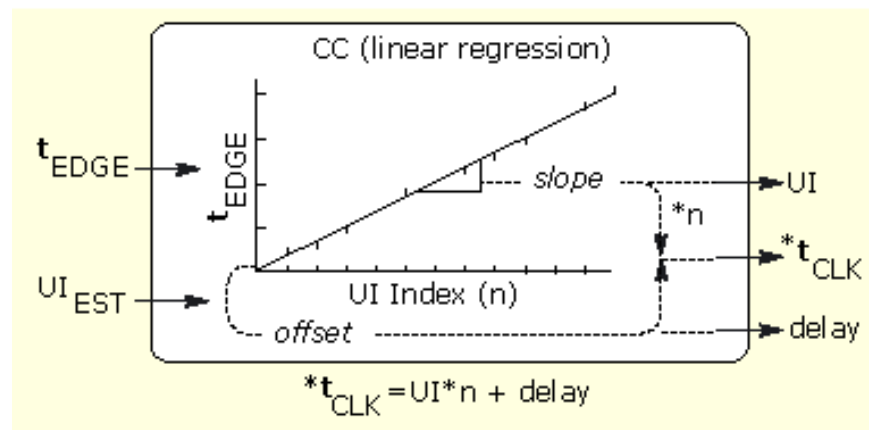

Constant clock - mean. This method provides the following options that control how the clock recovery is performed:

- Auto Calc First Acq
- Auto Calc Every Acq

Selecting Autocalc First Acq will allow the clock-recovery algorithm to choose a new best-fit clock frequency and phase only on the first acquisition. Subsequent acquisitions will choose a best fit on clock phase but retain the clock frequency found on the first acquisition.

Selecting Autocalc Every Acq will allow the clock-recovery algorithm to choose a new best-fit clock frequency and phase for each new oscilloscope acquisition.

Clearing the measurement results by choosing Clear on the sequencing panel will reset the clock recovery so that both frequency and phase are optimized on the subsequent acquisition.

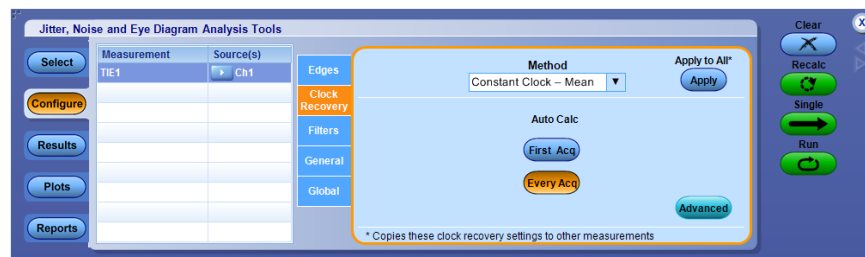

Table 26: Constant clock - mean options

Item	Description
Auto Calc First Acq	Calculates the best fit of the initial acquisition or the first acquisition after clearing results, and then uses the value until you clear the results.
Auto Calc Every Acq	Calculates the best fit for each acquisition (default).
Apply to All	
Apply	Applies the current clock recovery configuration to all selected measurement(s), PLL-Standard clock recovery options that have Clock Recovery as configuration tab.
Advanced	Displays the <i>Clock recovery advanced setup</i> dialog box.

Constant clock - median. This method provides the following options that control how the clock recovery is performed:

- Auto Calc First Acq
- Auto Calc Every Acq

Selecting Autocalc First Acq will allow the clock-recovery algorithm to choose a new best-fit clock frequency and phase only on the first acquisition. Subsequent acquisitions will choose a best fit on clock phase but retain the clock frequency found on the first acquisition.

Selecting Autocalc Every Acq will allow the clock-recovery algorithm to choose a new best-fit clock frequency and phase for each new oscilloscope acquisition.

Clearing the measurement results by choosing Clear on the sequencing panel will reset the clock recovery so that both frequency and phase are optimized on the subsequent acquisition.

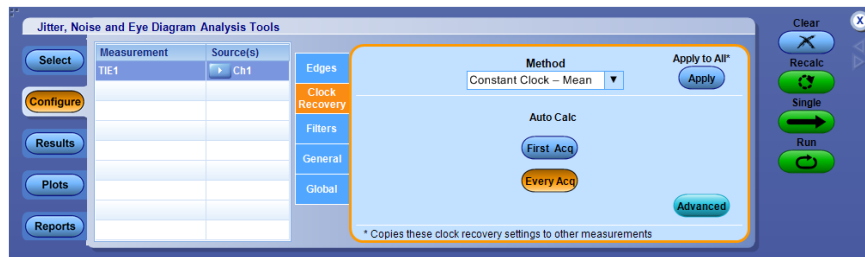
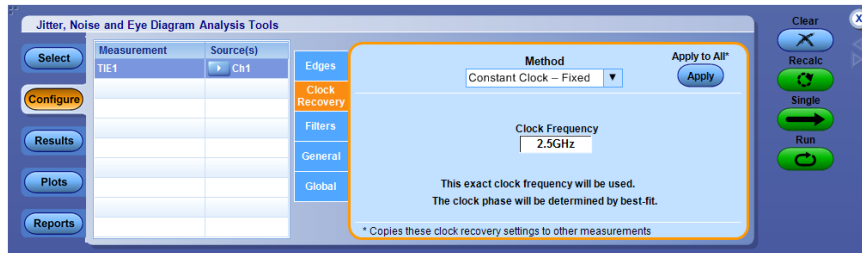

Table 27: Constant clock - median options

Item	Description
Auto Calc First Acq	Calculates the best fit of the initial acquisition or the first acquisition after clearing results, and then uses the value until you clear the results.
Auto Calc Every Acq	Calculates the best fit for each acquisition (default).
Apply to All	
Apply	Applies the current clock recovery configuration to all selected measurement(s) that have Clock Recovery as the configuration tab.
Advanced	Displays the <i>Clock recovery advanced setup</i> dialog box.

Constant clock - fixed. This method provides a single option that controls how the clock recovery is performed. With Fixed Constant Clock recovery, no attempt is made to derive information about the actual data rate from the signal under test. Instead, the precise frequency that you specify will be used. (However, the clock phase will be chosen so that the median difference between the recovered and measured edges is zero.)



NOTE. Click to apply the clock recovery configuration to all selected measurement(s) that have Clock Recovery as configuration tab.

Clock recovery advanced setup. The Advanced Clock Recovery methods can be used when unusually high noise or ambiguous data patterns defeats normal clock recovery methods. Under most normal operating conditions, these methods are not required nor recommended.

Nominal Data Rate and Known Data Pattern are the two advanced clock recovery methods.

In Nominal Data Rate, you can provide the nominal data rate to the clock recovery algorithm. Normally, the application analyzes your data and determines the data rate automatically. Setting this parameter to Manual allows you to provide a starting point or hint to the clock recovery algorithm. This is useful when the data pattern makes data rate detection ambiguous. As an example, a “1 1 0 0 1 1 0 0” pattern at 8 Gb/s would otherwise be detected as a “1 0 1 0” pattern at 4 Gb/s. Setting the bit rate to 8 Gb/s will cause the proper unit interval and pattern length to be identified.

In Known Data Pattern, the pattern is specified by using an ASCII text file containing the characters 1 and 0. The file may contain other characters, spaces and tabs for formatting purposes, but they will be ignored. Several files for commonly used patterns are included with the application, and you may use these as examples if you wish to create your own pattern files. Click **Browse** to modify the default location for pattern files.

NOTE. The last line of the pattern file must end with a CR/LF. Without the CR/LF, you will receive a too many bits error message.

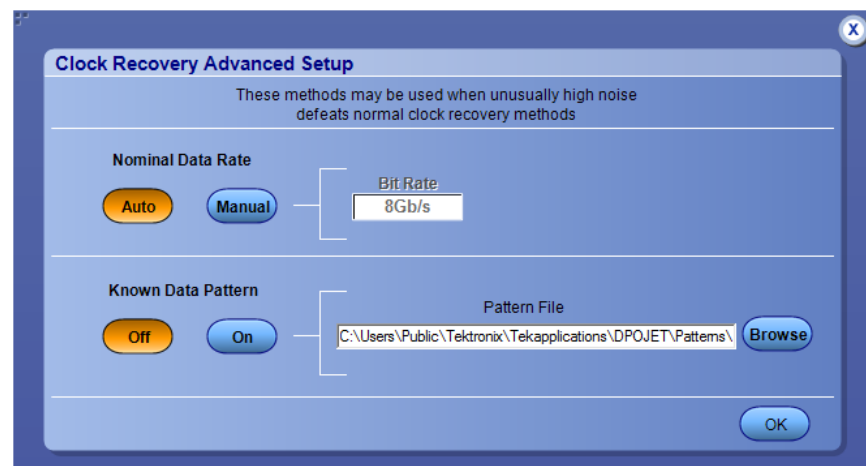

Table 28: Advanced clock recovery options

Item	Description
Auto	Enables automatic detection of the data rate on the first acquisition following a Clear or configuration change.

Item	Description
Manual	Allows you to manually specify the nominal data rate. This is useful when the data pattern makes data rate detection ambiguous. As an example, a "1 1 0 0 1 1 0 0" pattern at 8 Gb/s would otherwise be detected as a "1 0 1 0" pattern at 4 Gb/s.
Bit Rate	In Manual configuration, allows you to specify the approximate data rate in bits per second (b/s). In Auto configuration, displays the detected data rate.
Off, On	Enables (On) or disables (Off) advanced clock recovery through a known data pattern.
Pattern File Name	
Browse	Selects a file to use for the data pattern.
OK	Accepts changes and closes.

About PLL clock recovery setup. When PLL-based clock recovery is selected, the application simulates the behavior of the hardware Phase Locked Loop clock recovery circuit. This is a feedback loop in which the Voltage-Controlled Oscillator (VCO) is used to track or follow slow variations in the bit rate of the input waveform. Such loops are frequently used to recover the clock in communication links that do not transmit the clock as a separate signal. The PLL parameters in the application may be adjusted to simulate with the behavior of a receiver in such a link, within certain guidelines.

NOTE. The effective transfer function of a PLL loop is not equal to the PLL Loop BW setting. The Transfer function depends on the factors such as damping, transition density and type.

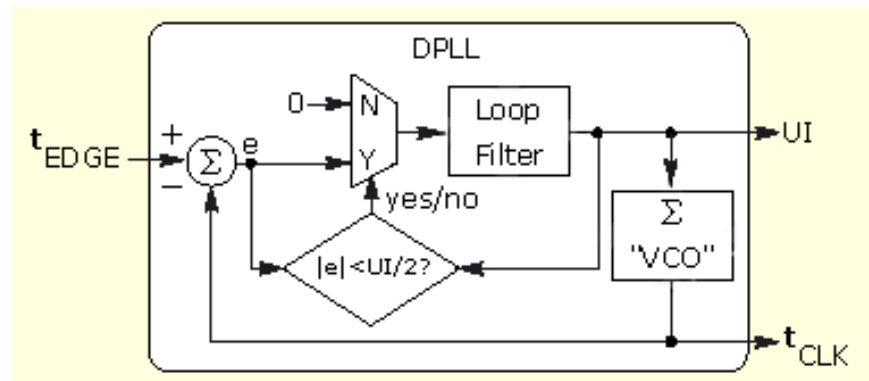

NOTE. PLL response is not instantaneous. This causes some signals to have a ramped trend at the beginning of a waveform as the PLL locks to the applied signal. To avoid a PLL start-up transient, part of the output is blanked out. This is applicable only when you select PLL Custom BW, PLL Standard BW or Explicit Clock-PLL as the clock recovery method. PLL blanking is used by measurements such as TIE, RJ, RJ- $\delta\delta$, DJ, DJ- $\delta\delta$, PJ, TJ@BER, High Voltage, Low Voltage, High-Low, T n/t Ratio, Eye Width, Eye Height, Width@BER, Height@BER, Rise Time and Fall Time.

About PLL loop BW versus JTF BW. Phase locked loops are characterized according to their bandwidth (BW), and several different bandwidths are commonly used. The terminology used for these bandwidths is described here, since it varies somewhat across different industries.

- Loop BW (or Closed Loop BW) is the frequency at which the closed-loop gain has fallen to -3 dB (half power) relative to unity-gain. The closed-loop gain function has the character of a low-pass filter.
- JTF BW (Jitter Transfer Function BW or Error Function BW) is the frequency below which input jitter to a tracking loop is removed. The JTF BW has a high-pass filter characteristic.

For Type I loops, the Loop BW and the JTF BW are always equal. For Type II loops, these two bandwidths are different, and their ratio depends on the PLL damping factor. You can choose to specify either bandwidth, and the other is displayed for reference.

PLL standard BW. The PLL control area provides control over the phase-locked loop used for clock recovery. You can choose the loop bandwidth and the loop order, and if a Type II loop is chosen, you can specify the damping factor.

To set the loop bandwidth automatically, based on a serial standard, select PLL: Standard BW as the clock recovery method. From the Standard: b/s list box, select the standard that matches your data link. For example, choose “PCI-E: 2.5” to test a 2.5 Gbit/second PCI Express link. In this case, the PLL bandwidth will be set to 1.5 MHz, which is 1/1667 of the baud rate as specified in PCI Express standard.

You can use the PLL Model list box to choose between Type I and Type II loop. A Type I loop has a transfer function that approaches zero frequency with a slope of 1/s and a Type II loop approaches zero frequency with a 1/s² slope (In much of the PLL literature, these terms are used interchangeably with First-Order and Second-Order loops. For a thorough discussion of loop type versus order, see Frequency Synthesis by Phase Lock, by William Egan).

NOTE. Although it is possible to configure a Type II PLL with a bandwidth up to 1/10 of the baud rate, such a loop will have poor dynamic performance. This is because Type II loops have less phase margin than Type I loops. A preferred alternative to using a Type II PLL with a bandwidth close to its baud rate is to use a second order high-pass measurement filter to emulate the effects of the PLL.

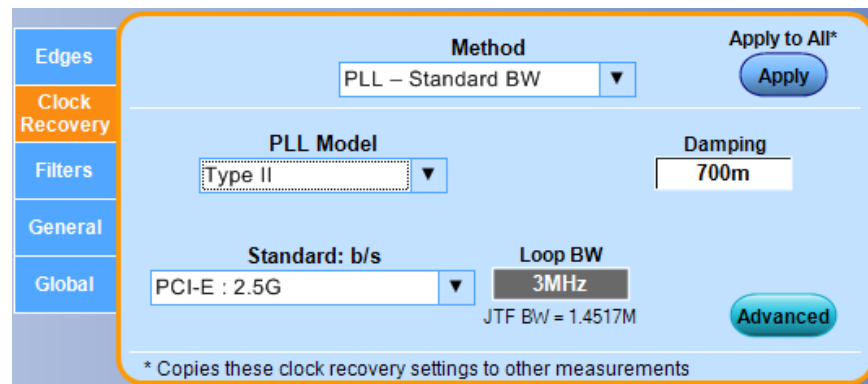

Table 29: PLL-standard clock recovery options

Item	Description
PLL Model	Selects between a Type I or Type II phase-locked loop.
Damping	Use the keypad to specify the damping ratio of the PLL. It is enabled only for Type II phase-locked loop.
Loop BW	Displays the Closed Loop bandwidth that has been configured based on the current standard.

Item	Description
JTF BW	Displays the Jitter Transfer Function bandwidth that has been configured based on the current standard.
Standard: b/s	Implicitly sets the loop bandwidth of the clock recovery PLL, based on selection of the industry standard and data rate in bits/second.
Apply to All	Applies the current clock recovery configuration to all selected measurements that have user-configurable clock recovery.
Apply	Applies the current clock recovery configuration to all selected measurement(s) that have Clock Recovery as the configuration tab.
Advanced	Displays the Clock Recovery Advanced Setup. For more details, refer to the Clock recovery advanced setup .

Related topics.

[About PLL loop BW versus JTF BW](#)

PLL custom BW. The PLL control area provides control over the phase-locked loop used for clock recovery. You can choose the loop bandwidth and the loop order, and if a Type II loop is chosen, you can specify the damping factor.

To manually control the loop bandwidth, select PLL: Custom BW as the clock recovery method and use the BW control to choose the -3 dB bandwidth, in Hz.

You can use the PLL Model list box to choose between a Type I and Type II loop. A Type I loop has a transfer function that approaches zero frequency with a slope of $1/s$ and a Type II loop approaches zero frequency with a $1/s^2$ slope. (In much of the PLL literature, these terms are used interchangeably with First-Order and Second-Order loops. For a thorough discussion of loop type versus order, see *Frequency Synthesis by Phase Lock*, by William Egan).

If you choose a Type II loop, you can use the radio buttons to select whether you will directly control the Loop BW (low-pass function) or the JTF BW (high-pass function). You must also select the Damping Factor for a Type II loop.

NOTE. *Although it is possible to configure a Type II PLL with a bandwidth up to 1/10 of the baud rate, such a loop will have poor dynamic performance. This is because Type II loops have less phase margin than Type I loops. A preferred alternative to using a Type II PLL with a high bandwidth is to use a 2 order high-pass measurement filter to emulate the effects of the PLL.*

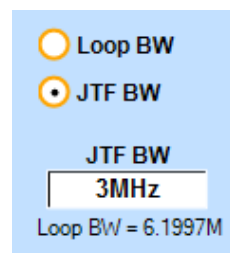
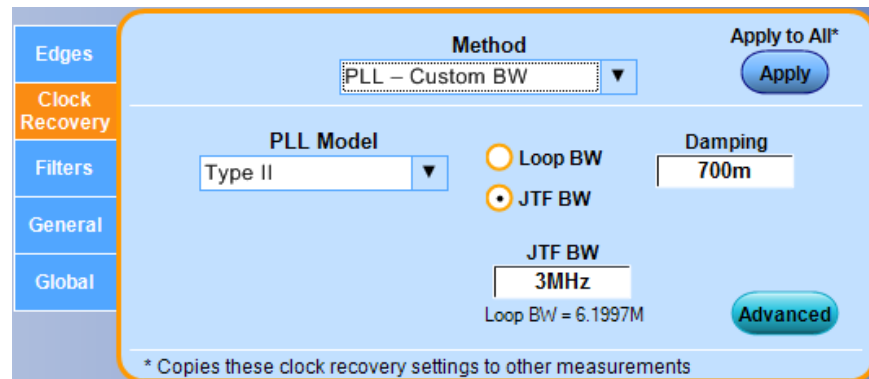

Table 30: PLL-Custom clock recovery options

Item	Description
PLL Model	Selects between Type I or Type II phase-locked loop.
Damping	Use the keypad to specify the damping ratio of the PLL. It is enabled only for Type II phase-locked loop.
JTF BW	Explicitly sets the JTF bandwidth of the clock recovery PLL when the PLL Model is Type II and the JTF BW radio button is selected.
Loop BW	Explicitly sets the Loop bandwidth of the clock recovery PLL when the PLL Model is Type II and the Loop BW radio button is selected.
Apply to All	Applies the current clock recovery configuration to all selected measurements that have user-configurable clock recovery.
Apply	Applies the current clock recovery configuration to all selected measurement(s) that have Clock Recovery as the configuration tab.
Advanced	Displays the Clock Recovery Advanced Setup. For more details, refer to the Clock recovery advanced setup .

Related Topics.

[About PLL loop BW versus JTF BW](#)

About explicit clock recovery. In Explicit Clock Recovery, the reference clock is not derived from the measurement's target source at all, but is instead taken from a separately-identified source. Since the source used for the measurement now differs from the source used to derive the reference clock, selecting this type of clock recovery converts the measurement from a single-source measurement to a dual-source measurement. The reference clock source is always shown on the right when the two sources appear in a measurement table. Changing the clock-recovery method back to a non-explicit clock method will change the measurement back to a single-source measurement.

Explicit Clock-Edge. Select Explicit Clock-Edge method if you want to use the edges found in the selected clock source (possibly multiplied up by an integral number). If the Clock Multiplier is set to 1 (the default), only these edges will be used. If the Clock Multiplier is set to a number N other than 1, linear interpolation will be used between each pair of actual edges to create N-1 additional reference edges. The interpolated edge times, combined with the actual edges, give a total of N reference edge times per actual edge.

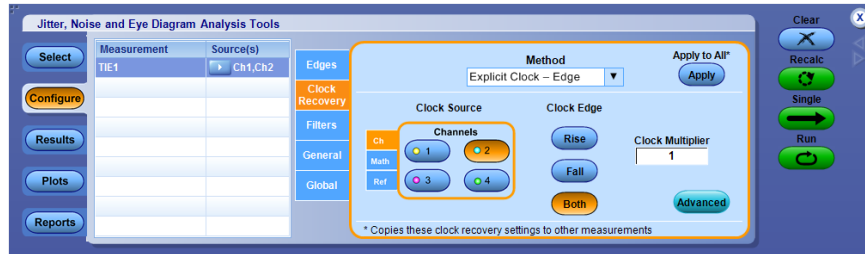

Table 31: Explicit-Clock edge options

Item	Description
Clock Source	Select Ch1 to Ch4, Ref1 to Ref4, or Math1 to Math4 as reference source for clock recovery.
Clock Edge	Specify whether the rising, falling or both edges of selected source should be considered.
Clock Multiplier	Specify the number of edges to be used.
Apply to All	
Apply	Applies the current clock recovery configuration to all selected measurement(s) that have Clock Recovery as the configuration tab.
Advanced	Displays the <i>Advanced explicit clock-edge</i> dialog wherein you can adjust the timing relation between reference clock source and data source.

Advanced explicit Clock-Edge. To compare the reference clock times to the edge times from the data source, some assumptions must be made about how they align. The default assumption is that each data source edge is associated with the reference clock edge to which it is nearest in time. This assumption may not be optimum, for example if the probes for the reference clock and data signal have different cable lengths.

To change the way the reference clock edges and data edges are associated, you can control the Nominal clock Offset Relative to Data.

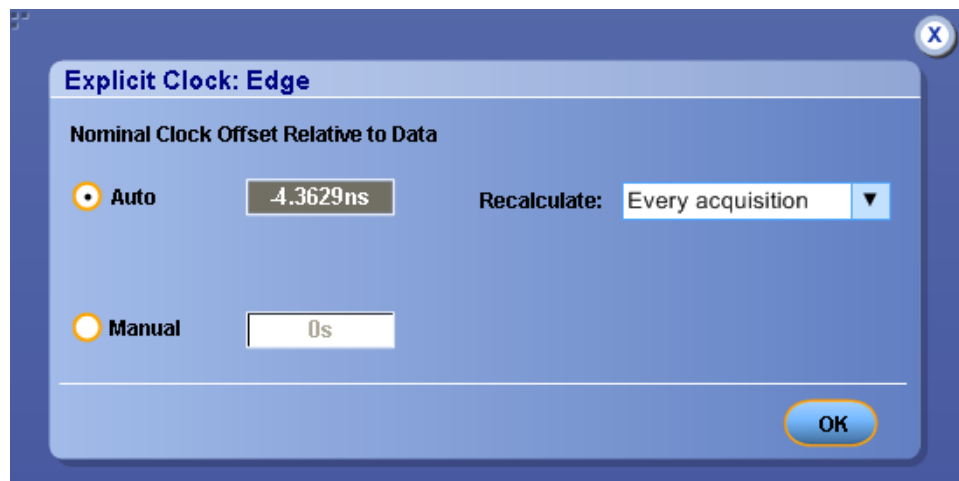

Table 32: Advanced explicit-Clock edge options

Item	Description
Auto	Automatically calculates the clock data skew and shifts the reference clock edges before the application associates each data edge with the closest clock edge.
Manual	Specify a time delay (positive or negative) to shift the reference clock edge before the application associates each data edge with the closet data edge.
Recalculate	
When required	Recalculates the nominal clock offset value whenever a new measurement is added or results are cleared or there are any measurement configuration changes.
Every acquisition	Recalculates the nominal clock offset value for every acquisition.

Related topics.

[Effect of nominal clock offset on eye diagrams](#)

Explicit Clock-PLL. Select Explicit Clock-PLL as the clock recovery method if you want to feed the edges from the selected clock source through a PLL rather than using them directly. The actual edges from the clock source will be used to drive a software PLL model, and the edge times coming out of the PLL will be used as the reference edges for the target measurement. If the Clock Multiplier is set to a number N other than 1, the output of the PLL will have N edges per actual edge.

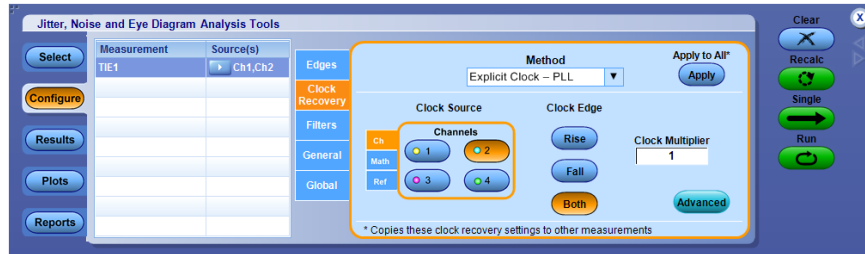

Table 33: Explicit Clock-PLL options

Item	Description
Clock Source	Select Ch1 to Ch4, Ref1 to Ref4 or Math1 to Math4 as reference source for clock recovery.
Clock Edge	Specify whether the rising, falling or both edges of selected source should be considered.
Clock Multiplier	Specify the number of edges to be used.
Apply to All	
Apply	Applies the current clock recovery configuration to all selected measurement(s) that have Clock Recovery as configuration tab.
Advanced	Displays the <i>Advanced explicit clock-PLL</i> dialog wherein you can adjust the timing relation between reference clock source and data source.

Advanced explicit Clock-PLL. In the Advanced Explicit Clock- PLL, you can specify the PLL type, bandwidth, damping factor and nominal clock offset relative to data. Damping numeric input is enabled only for Type II phase-locked loop.

Nominal Clock Offset Relative to Data. To compare the reference clock times to the edge times from the data source, some assumptions must be made about how they align. The default assumption is that each data source edge is associated with the reference clock edge to which it is nearest in time. This assumption may not be optimum, for example if the probes for the reference clock and data signal have different cable lengths.

To change the way the reference clock edges and data edges are associated, you can control the Nominal clock Offset Relative to Data.

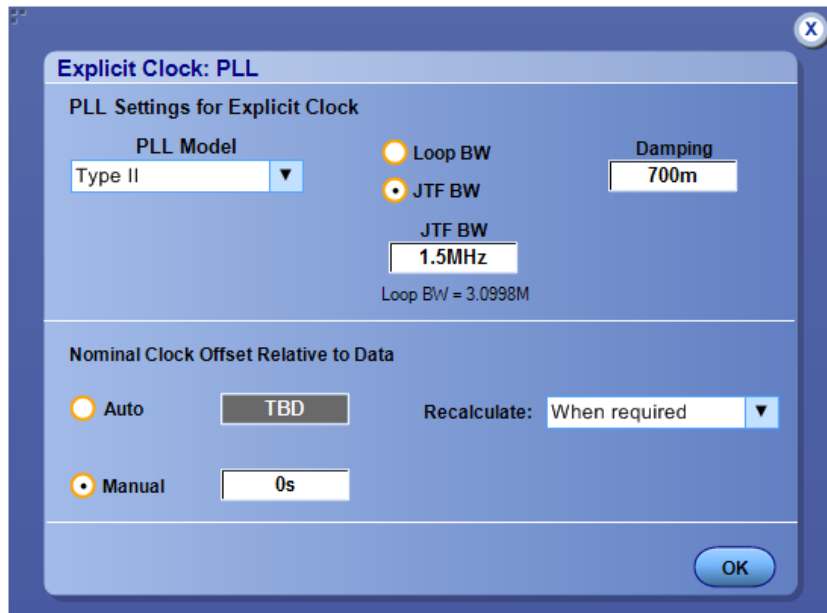

Table 34: Advanced Explicit-Clock PLL options

Item	Description
PLL Settings for Explicit Clock	
JTF BW	Explicitly sets the JTF bandwidth of the clock recovery PLL when the PLL Model is Type II and the JTF BW radio button is selected.
Loop BW	Explicitly sets the Loop bandwidth of the clock recovery PLL when the PLL Model is Type II and the Loop BW radio button is selected.
PLL Model	Selects between Type I or Type II phase-locked loop.
Damping	Use the keypad to specify the damping ratio of the PLL. It is enabled only for Type II phase-locked loop.

Item	Description
Auto	Automatically calculates the clock data skew and shifts the reference clock edges before the application associates each data edge with the closest clock edge.
Manual	Specify a time delay (positive or negative) to shift the reference clock edge before the application associates each data edge with the closet data edge.
Recalculate	
When required	Recalculates the nominal clock offset value whenever a new measurement is added or results are cleared or there are any measurement configuration changes.
Every acquisition	Calculates the nominal clock offset value for every acquisition.

Related topics.

Effect of nominal clock offset on eye diagrams

Effect of nominal clock offset on eye diagrams. Nominal Clock Offset does not affect the eye diagrams directly. Data and clock timing relationship is maintained ignoring the clock offset value. The clock offset still affects the eye diagram shape indirectly through edge labeling and TIE measurement but not with alignment.

When Explicit Clock Recovery is used, the Nominal Clock Offset does not affect eye diagram alignment. The relative alignment between data and clock is maintained as acquired. An absolute alignment is controlled by Ref Clock Alignment setting in Eye Diagram plot configuration panel. To ensure proper alignment between data and clock it is important to properly deskew oscilloscope channels.

Bit config **Bit config for eye height measurements.** This configuration tab allows you to select which waveform bit types (Transition bits, Non-Transition or All Bits) are included when taking eye height.

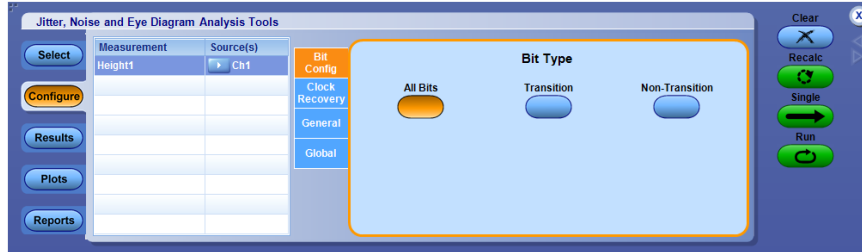

Table 35: Bit config for eye height

Item	Description
Bit Type	
All Bits	Eye analysis includes both transition and non-transition bits.
Transition	Eye analysis only on transition bits.
Non-Transition	Eye analysis only on non-transition bits.

Bit config for eye high eye low and Q-Factor measurements. This configuration tab allows you to select which waveform bit types (Transition bits, Non-Transition or All Bits) are included when taking eye height. This configuration tab also allows you to set the percent of unit interval where the measurement is taken.

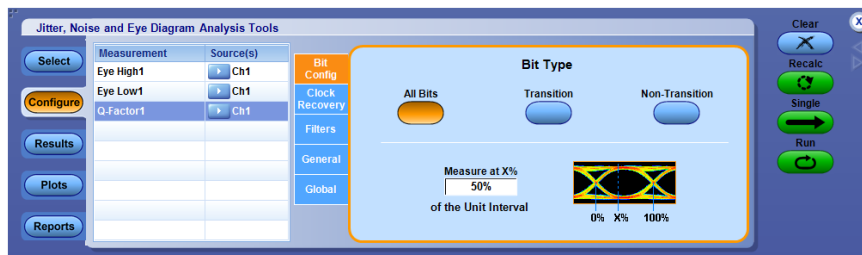

Table 36: Bit config for eye high, low, and Q-Factor

Item	Description
Bit Type	
All Bits	Eye analysis includes both transition and non-transition bits.
Transition	Eye analysis only on transition bits.
Non-Transition	Eye analysis only on non-transition bits.
Measure at X% of the Unit Interval	Sets the horizontal position where the measurement is taken, as a percentage of the Unit Interval.

Bit config for Height@BER measurements - Jitter Only. This configuration tab is displayed for the Height@BER measurement when the analysis method selected is Jitter Only (**Preferences > Jitter Decomp > Analysis Method**).

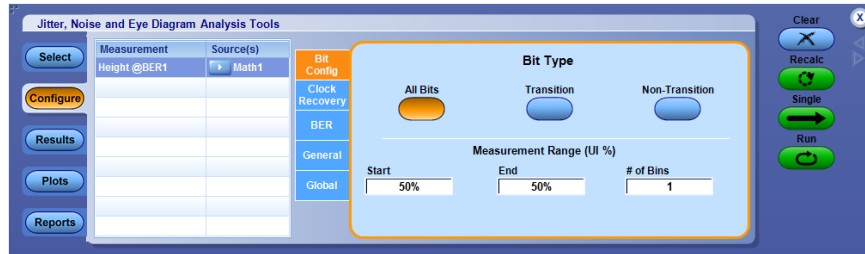

Table 37: Bit config for Height@BER

Item	Description
Bit Type	
All Bits	Eye analysis includes both transition and non-transition bits.
Transition	Eye analysis only on transition bits.
Non-Transition	Eye analysis only on non-transition bits.
Measurement Range (UI %)	
Start	Start % value of UI
End	End % value of UI
# of Bins	The resolution by the number of bins into which Span is divided.

Bit config for Height@BER measurements - Jitter + Noise. This configuration tab is displayed for the Height@BER measurement when the analysis method selected is Jitter + Noise (**Preferences > Jitter Decomp > Analysis Method**).

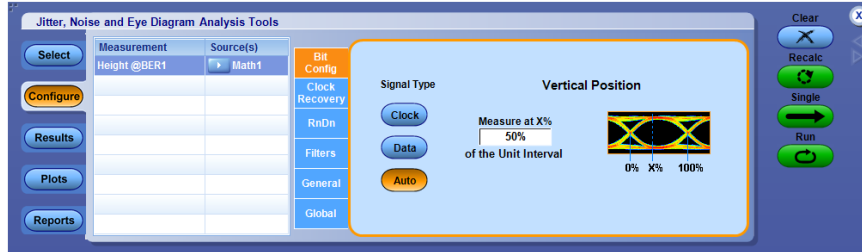

Table 38: Bit config for Height@BER

Item	Description
Signal Type	
Clock	Clock Forces the signal to be interpreted as a Clock. Measurements will take place on the edges specified by the Clock Edge control.
Data	Data Forces the signal to be interpreted as a Data. Both rising and falling edges are used.
Auto	Allows the application to automatically detect whether the signal is clock or data. If the signal is a clock, the Clock Edge control will determine which edges are used; otherwise the Clock Edge control will have no effect.
Vertical Position	
Measure at X% of the Unit Interval	Sets the horizontal position where the measurement is taken, as a percentage of the Unit Interval.

Bit config for TN@BER measurement. This configuration tab is displayed for the TN@BER measurement.

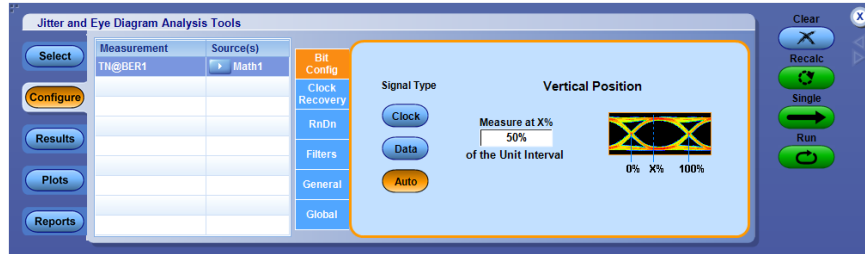

Table 39: Bit config for TN@BER

Item	Description
Signal Type	
Clock	Clock Forces the signal to be interpreted as a Clock. Measurements will take place on the edges specified by the Clock Edge control.
Data	Data Forces the signal to be interpreted as a Data. Both rising and falling edges are used.
Auto	Allows the application to automatically detect whether the signal is clock or data. If the signal is a clock, the Clock Edge control will determine which edges are used; otherwise the Clock Edge control will have no effect.
Vertical Position	
Measure at X% of the Unit Interval	Sets the horizontal position where the measurement is taken, as a percentage of the Unit Interval.

Bit config for mask hits measurements. This configuration tab allows you to select the waveform bit type (All Bits, Transition, or Non-Transition) and the mask to be used for Mask hits measurements.



Table 40: Bit config for mask hits

Item	Description
Bit Type	
All Bits	Eye analysis includes both transition and non-transition bits.
Transition	Eye analysis only on transition bits.
Non-Transition	Eye analysis only on non-transition bits.
Mask	
Browse	Allows selection of the mask file. (If none of the supplied mask files meets your need, you may create a custom mask file with a text editor by using one of the existing mask specification files as a template.)

Item	Description
Mask	<p>There are two types of mask coordinates:</p> <ul style="list-style-type: none"> ■ Absolute: Select to define the mask in terms of absolute values. The units defining the polygon X and Y values are in the waveforms horizontal and vertical coordinates. ■ Relative: Select to define the mask in terms of normalized values. The horizontal axis is normalized to the Unit Interval and the vertical axis is normalized to Nominal1 and Nominal0. Normalized levels of 0 and 1 represent logic zero and one respectively. These are defined by the means of the lower and upper halves of the central 0.2 UI of the eye. <p>Relative Mask Math:</p> <pre>Nominal1 = <vertical value of 1> Nominal0 = <vertical value of 0> UI = <Time Interval of Symbols> UICenter = <Time at Center of UI> hRelativeStart = 0.5 vValue(y) = (y*(Nominal1 - Nominal0)) + Nominal0 hValue(x) = (x - hRelativeStart-0.5)*UI + UICenter</pre>

Bit config for autofit mask hits measurement. This configuration tab allows you to select the waveform bit type (All Bits, Transition, or Non-Transition) and the mask to be used for Autofit Mask hits measurements and Advance options.

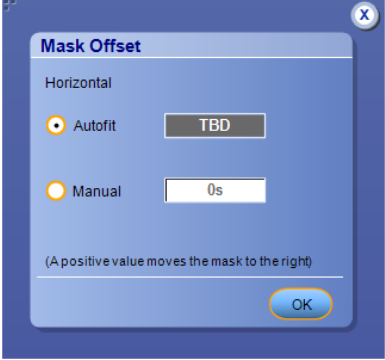

Bit config for mask hits	Description
Bit Type	
All Bits	Eye analysis includes both transition and non-transition bits.
Transition	Eye analysis only on transition bits.
Non-Transition	Eye analysis only on non-transition bits.
Mask	
Browse	Allows selection of the mask file. (If none of the supplied mask files meets your need, you may create a custom mask file with a text editor by using one of the existing mask specification files as a template.)
Mask	<ul style="list-style-type: none"> ■ Absolute: Select to define the mask in terms of absolute values. The units defining the polygon X and Y values are in waveforms horizontal and vertical coordinates. ■ Relative: Select to define the mask in terms of normalized values. The horizontal axis is normalized to the Unit Interval and the vertical axis is normalized to Nominal1 and Nominal0. Normalized levels of 0 and 1 represent logic zero and one respectively.

Bit config for mask hits	Description
Advance	<p data-bbox="792 312 1146 342">Displays the Mask Offset dialog box.</p>  <p data-bbox="792 810 1500 932">Autofit configuration: When Autofit is clicked, If “Autofit” configuration is selected, the backend algorithm automatically identifies the best location where the pixel hits are either minimum or zero in an eye diagram. The “Horizontal Mask Offset” value will get updated in Autofit text box.</p> <p data-bbox="792 936 1500 1125">Manual configuration: If Manual configuration is selected, the positive offset value will move the mask to the right side and negative offset value will move the mask to left side of eye diagram. We should add a short line of text at the bottom of the Horizontal section: “A positive value moves the mask to the right”. There will be no mask movement for this particular configuration (Manual = 0 seconds).</p>

Bit config for mask hits ratio measurement. This configuration tab allows you to select the waveform bit type (All Bits, Transition, or Non-Transition) and the mask to be used for Mask hits measurements.



Table 41: Bit config for mask hits

Item	Description
Bit Type	
All Bits	Eye analysis includes both transition and non-transition bits.
Transition	Eye analysis only on transition bits.
Non-Transition	Eye analysis only on non-transition bits.
Mask	
Browse	Allows selection of the mask file. (If none of the supplied mask files meets your need, you may create a custom mask file with a text editor by using one of the existing mask specification files as a template.)

Bit config for mask margin measurement. This configuration tab allows you to select the waveform bit type (All Bits, Transition, or Non-Transition) and the mask to be used for Mask hits measurements.



Table 42: Bit config for mask margin measurement

Item	Description
Bit Type	
All Bits	Eye analysis includes both transition and non-transition bits.
Transition	Eye analysis only on transition bits.
Non-Transition	Eye analysis only on non-transition bits.
Mask	
Browse	Allows selection of the mask file. (If none of the supplied mask files meets your need, you may create a custom mask file with a text editor by using one of the existing mask specification files as a template.)

Bit config for amplitude measurements. This configuration tab is present only for High, Low and High–Low measurements. You can select the waveform bit type (All Bits, Transition, Non-Transition) and method.

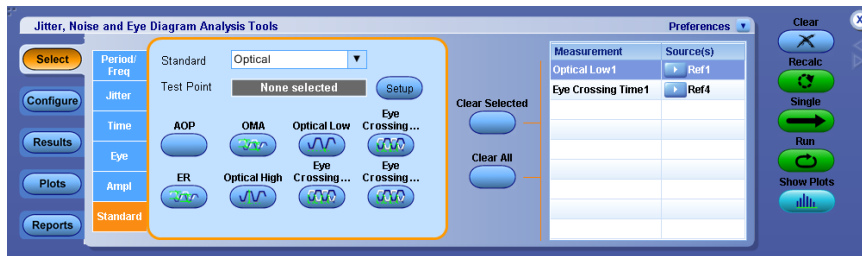
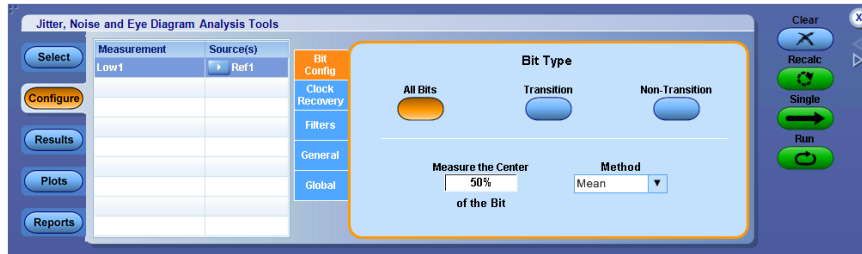

Table 43: Bit config for amplitude measurements

Item	Description
Bit Type	
All Bits	Eye analysis includes both transition and non-transition bits.
Transition	Eye analysis only on transition bits.
Non-Transition	Eye analysis only on non-transition bits.
Measure the Center X % of the Bit	Determines what percentage (1 to 100) of a unit interval, centered in the middle of the bit, shall be included in each measurement. The waveform points selected by the percentage form a distribution (vertical histogram) from which a single value is extracted, based on the Method control.
Method	Determines whether the Mean value or the Median of the selected distribution is used for the measurement value for each unit interval.

Bit config for PCI express measurements. This configuration tab allows you to select which waveform bit types (Transition, Non-Transition or All Bits) are included when taking PCI Express measurements, PCIe T-Tx-Rise and PCIe T-Tx-Fall.

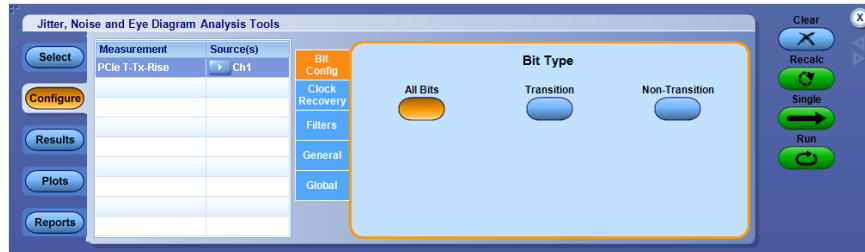
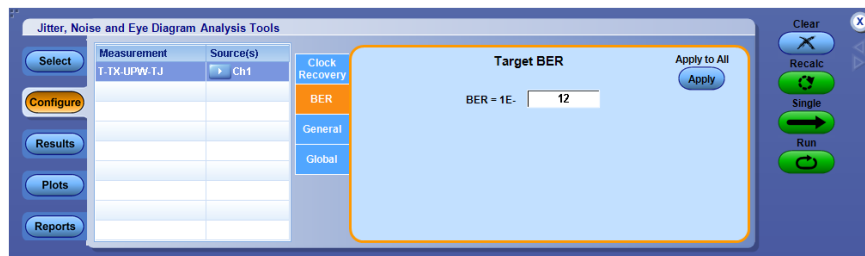

Table 44: Bit config for PCI express measurements

Item	Description
Bit Type	
All Bits	Analysis includes both transition and non-transition bits.
Transition	Analysis only on transition bits.
Non-Transition	Analysis only on non-transition bits.

BER The BER configure panel is available for T-TX-UTJ, T-TX-UDJDD, T-TX-UPW-TJ, T-TX-UPW-DJDD, PkPkClkTJ measurements.



Item	Description
Target BER	
BER= 1E-?	Sets the Bit Error Rate exponent, thereby setting the statistical level at which Total Jitter and Eye Opening are reported.
Apply To All	
Apply	Applies the Target BER value to both Jitter Target BER and Target BER for all the measurements that have the BER as the configuration tab.

RJ-DJ **About RJ-DJ.** This configuration tab allows you to select an appropriate decomposition method for jitter analysis. RJ-DJ decomposition analysis divides the timing jitter into various categories and uses the results to predict the total jitter at a selected bit error rate (BER).

The DPOJET application offers two methods of RJ-DJ analysis:

- A method based on spectral analysis that is appropriate for cyclically repeating data patterns.
- A method that works for arbitrary data sequences.

This configuration tab allows you to guide the decomposition method based on the data pattern. By default, the decomposition method is selected automatically based on the detected bit pattern. This is the recommended configuration.

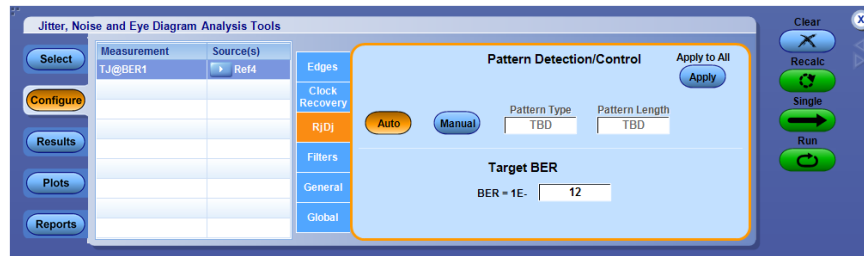

Table 45: RJ-DJ analysis of repeating options

Item	Description
Pattern Detection/Control	
Auto [Preferred]	Causes the data pattern to be detected automatically on the first acquisition following a “Clear” or configuration change. Based on this detection, the Pattern Type and associated controls are then configured optimally for the given record length.
Manual	Allows (and requires) that the Pattern Type and associated controls be set manually.
Pattern Type	
Pattern Type - Repeating	If the data signal is repeating pattern of N bits, then Repeating pattern type should be selected. ¹
Pattern Type - Arbitrary	If the data signal is non-repeating pattern, or is unknown then Arbitrary pattern type should be selected.
Pattern Length	(Present only when the Pattern Type is <i>Repeating</i> .) When Pattern Detection is <i>Auto</i> , this field shows the detected pattern length. When Pattern Detection is <i>Manual</i> , this control must be set to match the actual pattern length. If the manually-set pattern length is inconsistent with the detected pattern length, processing will continue but a warning will be logged.

¹ A minimum of 50 repeats of the pattern must be present.

Item	Description
Window Length	(Only present when the Pattern Type is Arbitrary.) Determines the number of unit intervals over which pattern correlation effects are analyzed. The window should be set to a large enough value that the impulse response of the serial data transmitter and channel have settled.
Target BER	
BER= 1E-?	<p>Sets the Bit Error Rate exponent, thereby setting the statistical level at which Total Jitter, Total Noise and Eye Opening are reported.</p> <p>NOTE. Target BER configuration is available only for TJ@BER, Width@BER, Height@BER, BER mask test and PDF mask test measurements.</p>
Apply To All	
Apply	Applies all settings on this configuration tab to all other measurements that have an RJ-DJ tab.

Related topics.

[RJ-DJ analysis of arbitrary pattern](#)

[RJ-DJ analysis of repeating patterns](#)

RJ-DJ analysis of repeating patterns. This method of RJ-DJ analysis uses a Fourier transform of the time-interval error signal to identify and separate jitter components. It is described in the Fibre Channel - Methodologies for Jitter and Signal Quality Specification (MJSQ) and has wide industry acceptance.

This method requires that the data signal be composed of a pattern of N bits that are repeated over and over. A minimum of 50 repeats of the pattern must be present. If you select Manual configuration, you must enter the pattern length (N), although it is not necessary to know the specific bits that make up the pattern. If you use the default “Auto” configuration, this method will be selected if possible and configured based on the detected bit pattern.

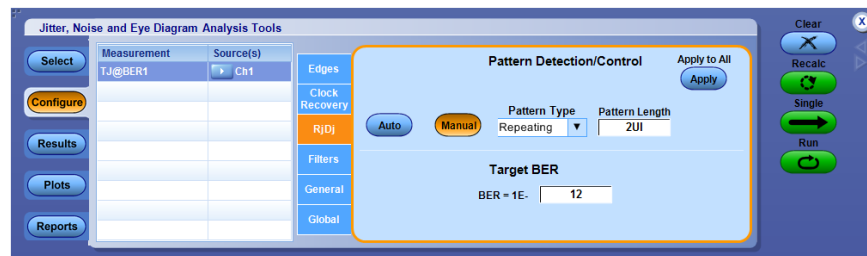

RJ-DJ analysis of arbitrary pattern. When the data pattern is not repeating, or is unknown, a second method of RJ-DJ analysis may be used. (It may also be used if the pattern is repeating, and correlates well with the Spectral method in this case.) This method assumes that the Inter Symbol Interference (ISI) from a given edge only affects a relatively small number of subsequent bits. For example, in a band-limited link where a string of ones follows a string of zeros, the signal may require three or four bit periods to fully settle to the “high” state.

In this method, an analysis window with a width of K+1 bits is slid along the waveform. For each position of the window, the time interval error of the rightmost bit in the window is stored, along with the K-bit pattern that preceded it. After the window has been slid across all positions, it is possible to calculate the component of the jitter that is correlated with each observed K-bit pattern, by averaging together all the observed errors associated with that specific pattern.

In the configuration menu for the arbitrary-pattern method, the Window Length field allows you to select how many bits are included in the sliding window. The window should include enough bits to allow the impulse response of the system under test to settle, usually 5 to 10 bits. The disadvantage of increasing the window length is that it uses more memory and requires additional processing time and greater measurement population to form an answer. If the measurement population is not sufficient at the end of a processing cycle to calculate an answer, the results table displays <Min# of UI.

Prior versions of DPOJET allowed direct control of the minimum number of observations required for each data pattern, before a result would be produced. This minimum is now set internally to 10. DPOJET always uses all available observations; this control only set the minimum allowable.

The arbitrary pattern approach for measuring jitter may not be appropriate if there are very-long-duration memory effects in your data link. An example would be if there are impedance mismatch reflections that arrive long enough after the initial edge to fall outside the analysis window.

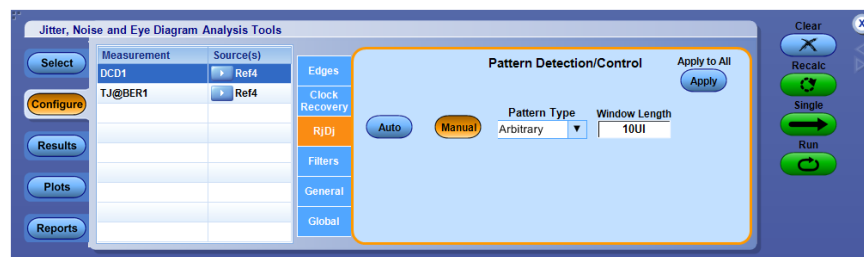

RN-DN **About RN-DN.** This configuration tab allows you to select an appropriate decomposition method for noise analysis. RN-DN decomposition analysis divides the noise into various categories and uses the results to predict the total jitter at a selected bit error rate (BER).

The DPOJET application offers two methods of RN-DN analysis:

- A method based on spectral analysis that is appropriate for cyclically repeating data patterns.
- A method that works for arbitrary data sequences.

This configuration tab allows you to guide the decomposition method based on the data pattern. By default, the decomposition method is selected automatically based on the detected bit pattern. This is the recommended configuration.

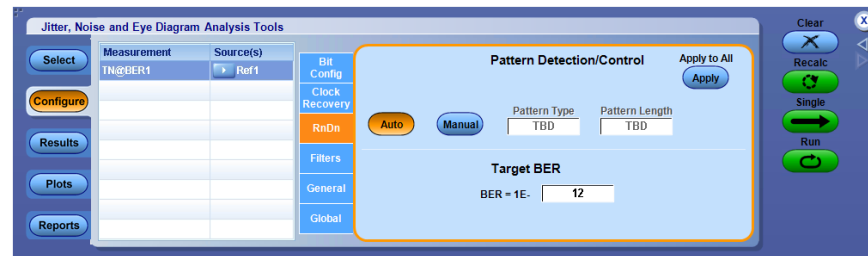

Table 46: RN-DN analysis of repeating options

Item	Description
Pattern Detection/Control	
Auto [Preferred]	Causes the data pattern to be detected automatically on the first acquisition following a “Clear” or configuration change. Based on this detection, the Pattern Type and associated controls are then configured optimally for the given record length.
Manual	Allows (and requires) that the Pattern Type and associated controls be set manually.
Pattern Type	
Pattern Type - Repeating	If the data signal is repeating pattern of N bits, then Repeating pattern type should be selected.
Pattern Type - Arbitrary	If the data signal is non-repeating pattern, or is unknown then Arbitrary pattern type should be selected.
Pattern Length	(Present only when the Pattern Type is <i>Repeating</i>) When Pattern Detection is <i>Auto</i> , this field shows the detected pattern length. When Pattern Detection is <i>Manual</i> , this control must be set to match the actual pattern length. If the manually-set pattern length is inconsistent with the detected pattern length, processing will continue but a warning will be logged.

Item	Description
Window Length	(Only present when the Pattern Type is Arbitrary) Determines the number of unit intervals over which pattern correlation effects are analyzed. The window should be set to a large enough value that the impulse response of the serial data transmitter and channel have settled.
Target BER	
BER= 1E-?	Sets the Bit Error Rate exponent, thereby setting the statistical level at which Total Jitter, Total Noise and Eye Opening are reported. <i>NOTE. Target BER configuration is available only for TN@BER measurement.</i>
Apply To All	
Apply	Applies all settings on this configuration tab to all other measurements that have an RN-DN tab.

Related topics.

[RN-DN analysis of arbitrary pattern](#)

[RN-DN analysis of repeating patterns](#)

RN-DN analysis for repeating pattern. This method of RN-DN analysis uses a Fourier transform of the noise signal to identify and separate noise components.

This method requires that the data signal be composed of a pattern of N bits that are repeated over and over. A minimum of 50 repeats of the pattern must be present. If you select Manual configuration, you must enter the pattern length (N), although it is not necessary to know the specific bits that make up the pattern. If you use the default “Auto” configuration, this method will be selected if possible and configured based on the detected bit pattern.

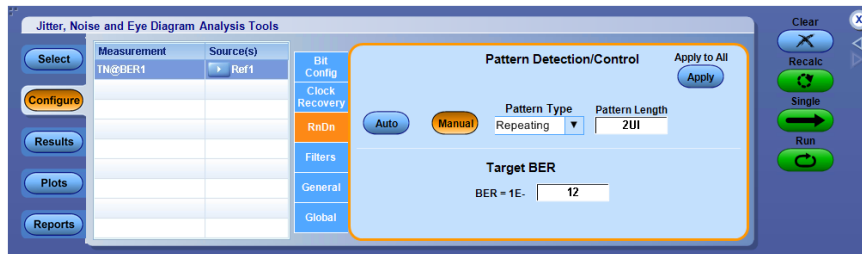

RN-DN analysis for arbitrary pattern. When the data pattern is not repeating, or is unknown, a second method of RN-DN analysis may be used. (It may also be used if the pattern is repeating, and correlates well with the Spectral method in this case.) This method assumes that the Inter Symbol Interference (ISI) from a given edge only affects a relatively small number of subsequent bits. For example, in a band-limited link where a string of ones follows a string of zeros, the signal may require three or four bit periods to fully settle to the “high” state.

In this method, an analysis window with a width of K+1 bits is slid along the waveform. For each position of the window, the time interval error of the rightmost bit in the window is stored, along with the K-bit pattern that preceded it. After the window has been slid across all positions, it is possible to calculate the component of the jitter that is correlated with each observed K-bit pattern, by averaging together all the observed errors associated with that specific pattern.

In the configuration menu for the arbitrary-pattern method, the Window Length field allows you to select how many bits are included in the sliding window. The window should include enough bits to allow the impulse response of the system under test to settle, usually 5 to 10 bits. The disadvantage of increasing the window length is that it uses more memory and requires additional processing time and greater measurement population to form an answer. If the measurement population is not sufficient at the end of a processing cycle to calculate an answer, the results table displays <Min# of UI.

Prior versions of DPOJET allowed direct control of the minimum number of observations required for each data pattern, before a result would be produced. This minimum is now set internally to 10. DPOJET always uses all available observations; this control only set the minimum allowable.

The arbitrary pattern approach for measuring jitter may not be appropriate if there are very-long-duration memory effects in your data link. An example would be if there are impedance mismatch reflections that arrive long enough after the initial edge to fall outside the analysis window.

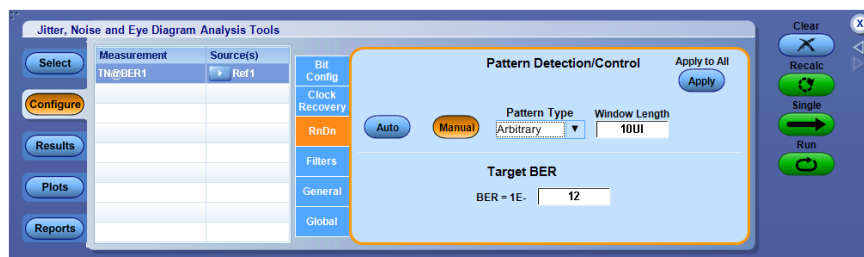

Bus state **Configuring bus states.** The following topic applies only to MSO series oscilloscopes, since it depends on the ability to define a digital bus using the oscilloscope logic channels.

Use this configuration tab to select the bus states, clock source, edge and polarity used in measurements that require a bus source. The configuration changes based on the selected measurement. Measurement tCMD-CMD requires two different bus states to calculate the time between them. Select the bus states using a bus symbol file or a bus pattern setup. Select between the options using the radio buttons.

If a symbol file is not loaded, Enter pattern is selected. If a symbol file is loaded, Use symbol file is selected. The symbol file loads commands into the drop down lists. The Bus State user interface stays in sync with the Bus Setup window of the oscilloscope. Any change in Bus state configuration tab will reflect in Bus setup window and vice versa.

When a symbol file is loaded, the From Symbol and To Symbol drop downs are displayed, with the commands loaded from the symbol file. You can select the required Measure at bus states. Changing Measure at to Clock Edge lets you set the clock source and polarity. Clock Edge considers the time at which commands are registered, that is, at the Rising or Falling edge of the clock, depending on the Clock Polarity configuration.

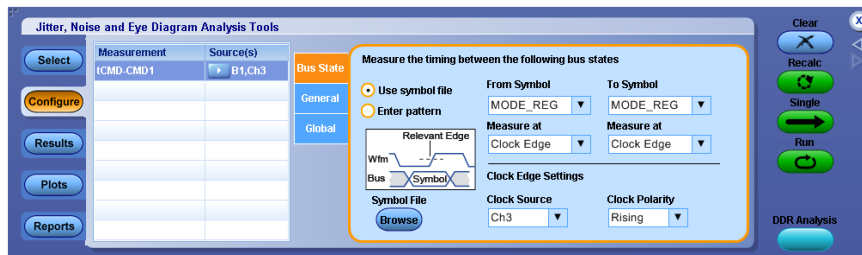

Measurements like tCKSRE require one waveform source and one bus state. Select the waveform source from the Clock Source drop down or the Source Configuration window. Your selected source is the first choice in the Clock Source drop down. Select the bus state using the Symbol drop down.

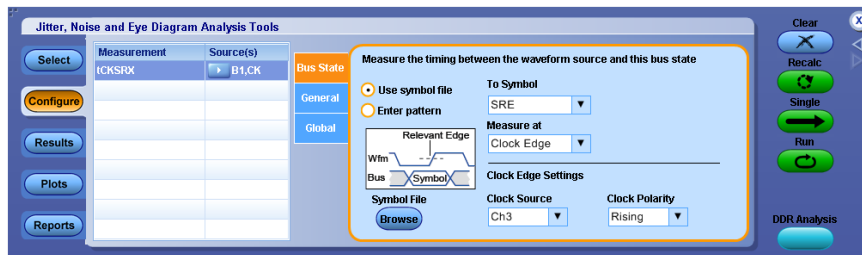

The tBurst-CMD measurement is a single-source measurement by default. The Measure at selection does not have a Clock Edge selection, only Start and Stop.

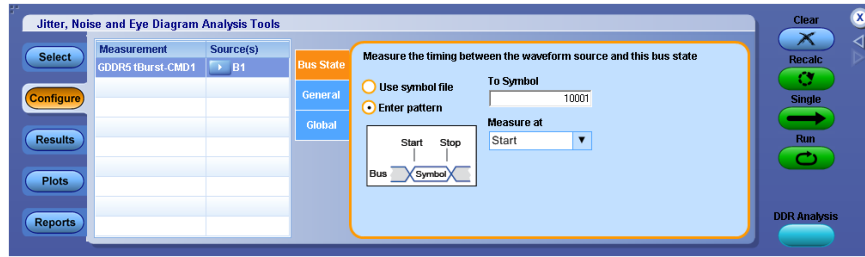

Select Enter pattern to directly enter the required symbol bit patterns.

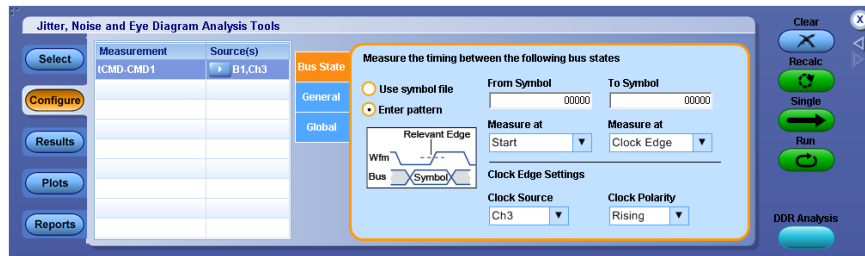

Table 47: Bus state options

Item	Description
Use symbol file	Use the bus state in the symbol file.
Enter pattern	Specify a bus state pattern.
Symbol File	Browse for the symbol file to use.
Symbol	The bus state symbol to use in measurements.
Measure at	Specify where to take the measurement.
Clock Edge Settings	
Clock Source	Specify the clock source for the measurement.
Clock Polarity	Specify the clock polarity for the measurement.
Between bus states	
From Symbol	Specify where the measurement is take from.
To Symbol	The symbol file specifies where to measurement to.
Measure at	The symbol file specifies where to take the measurement. Start - Considers Start time of the command. Stop - Considers Stop time of the command. Clock Edge - Considers the time at which Commands are registered, that is, at the Rising edge of the clock.

Edges **Configuring edges.** This configuration tab allows you to select waveform edge(s) the application should use to take measurement. Depending on the particular measurement, the tab will offer access to other options and constraints that help guide the analysis. The application is able to automatically detect whether a signal is clock or data, and will do so by default. This can be overridden by configuring the signal type as Clock or Data.

The configuration options for Edges change based on whether the analysis method selected is Jitter Only or Jitter + Noise (**Preferences > Jitter Decomp > Analysis Method**).

Configuring edges - Jitter only. The following configuration options apply to most measurements when the analysis method selected is Jitter Only. See the subsequent sections for Edge tabs corresponding to particular measurements.

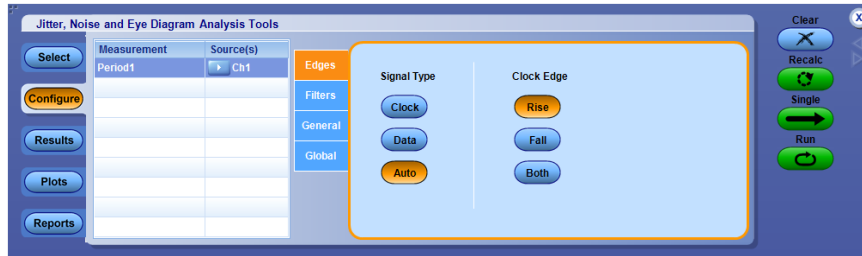

Item	Description
Signal Type	
Clock	Forces the signal type to be interpreted as a Clock. Measurements will take place on the edges specified by the Clock Edge control.
Data	Forces the signal to be interpreted as a Data. Both rising and falling edges are used.
Auto	Allows the application to automatically detect whether the signal is clock or data. If the signal is a clock, the Clock Edge control will determine which edges are used; otherwise the Clock Edge control will have no effect.
Clock Edge	
Rise	Uses only the rising edges of the signal.
Fall	Uses only the falling edges of the signal.
Both	Uses both the rising and falling edges of the signal.

Configuring edges - Jitter + Noise. The following configuration options apply to most Jitter measurements when the analysis method selected is Jitter + Noise. The rise edge and fall edge configuration is disabled for Width@BER and all Jitter measurements except TIE. For TIE measurement, the Clock Edge configuration are enabled. See the subsequent sections for Edge tabs corresponding to particular measurements.

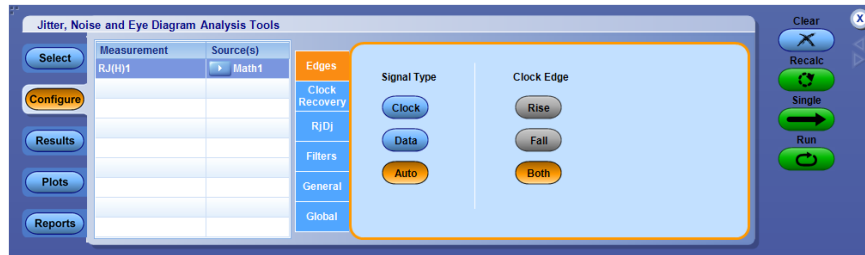

Item	Description
Signal Type	
Clock	Forces the signal type to be interpreted as a Clock. Measurements will take place on the edges specified by the Clock Edge control.
Data	Forces the signal to be interpreted as a Data. Both rising and falling edges are used.
Auto	Allows the application to automatically detect whether the signal is clock or data. If the signal is a clock, the Clock Edge control will determine which edges are used; otherwise the Clock Edge control will have no effect.
Clock Edge	
Rise	Disabled (greyed out)
Fall	Disabled (greyed out)
Both	Uses both the rising and falling edges of the signal (default).

The following configuration options apply to most Noise measurements when the analysis method selected is Jitter + Noise. See the subsequent sections for Edge tabs corresponding to particular measurements.

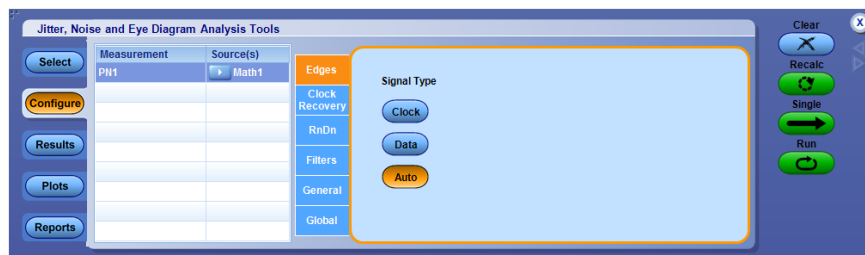

Item	Description
Signal Type	

Item	Description
Clock	Forces the signal type to be interpreted as a Clock. Measurements will take place on the edges specified by the Clock Edge control.
Data	Forces the signal to be interpreted as a Data. Both rising and falling edges are used.
Auto	Allows the application to automatically detect whether the signal is clock or data. If the signal is a clock, the Clock Edge control will determine which edges are used; otherwise the Clock Edge control will have no effect.

Configuring edges for skew measurements. This configuration tab is displayed for Skew measurements.

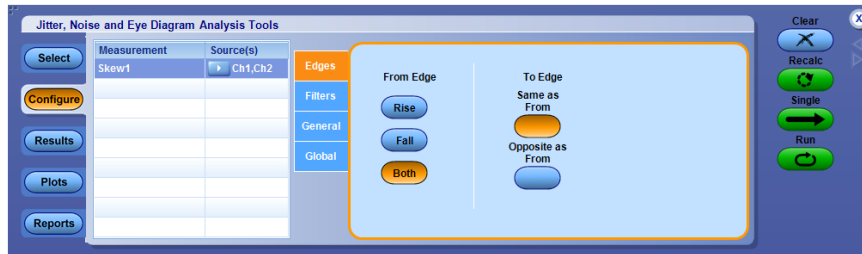

Item	Description
From Edge	
Rise	Uses only the rising edges of the signal.
Fall	Uses only the falling edges of the signal.
Both	Uses both the rising and falling edges of the signal.
To Edge	
Same as From	Each measurement is defined by a pair of like edges (Rise to Rise or Fall to Fall).
Opposite as From	Each measurement is defined by a pair of opposing edges (Rise to Fall or Fall to Rise).

Configuring edges for differential CrossOver voltage measurements. This configuration tab is displayed for Differential CrossOver Voltage measurements.

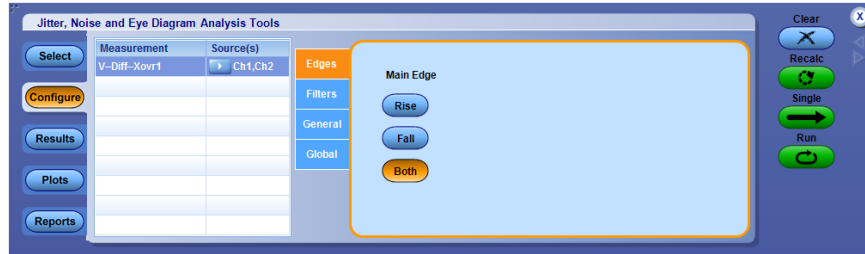

Item	Description
Rise	Uses only the rising edges of the signal.
Fall	Uses only the falling edges of the signal.
Both	Uses Both the rising and falling edges of the signal.

Configuring edges for phase noise measurements. This configuration tab is displayed for Phase Noise measurements. Phase noise measurements are undefined for data signals, so the signal is assumed to be a clock.

The Noise Integration Limits determine the portion of the phase noise spectrum that is integrated to produce a single measurement per waveform acquisition.

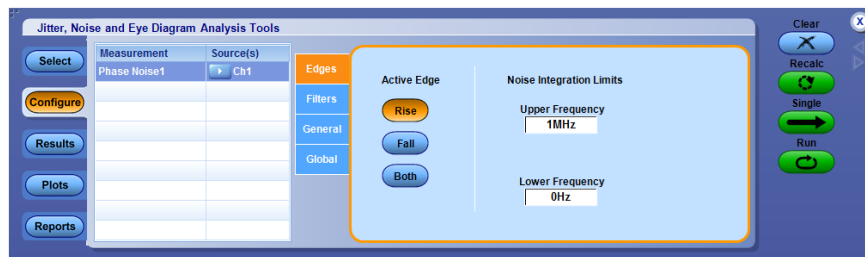

Item	Description
Active Edge	
Rise	Uses only the rising edges of the signal.
Fall	Uses only the falling edges of the signal.
Both	Uses both the rising and falling edges of the signal.
Noise Integration Limits	
Upper Frequency	Sets the upper end of the noise integration frequency range.
Lower Frequency	Sets the lower end of the noise integration frequency range.

Configuring edges for N-Period measurements. This configuration tab is displayed for N-Period measurements.

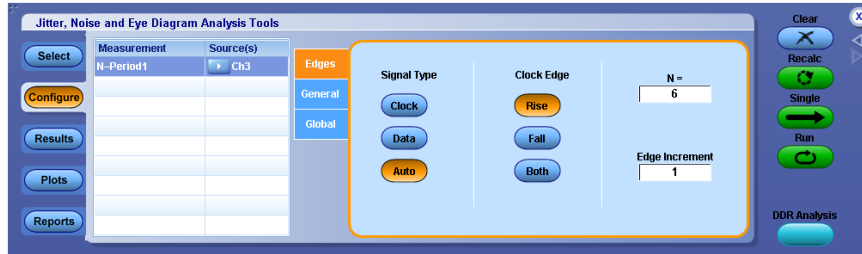

Item	Description
Signal Type	
Clock	Forces the signal to be interpreted as a Clock. Measurements will take place on the edges specified by the Clock Edge control.
Data	Forces the signal to be interpreted as a Data. Both rising and falling edges are used.
Auto	Allows the application to automatically detect whether the signal is clock or data. If the signal is a clock, the Clock Edge control will determine which edges are used; otherwise the Clock Edge control will have no effect.
Clock Edge	
Rise	Uses only the rising edges of the signal.
Fall	Uses only the falling edges of the signal.
Both	Uses both the rising and falling edges of the signal.
N=	Specifies number of cycles or unit interval in each N-period group.
Edge Increment	Specifies the temporal displacement in edges between consecutive measurements.

Configuring edges for setup/hold. This configuration tab is displayed for two source measurements: Setup and Hold.

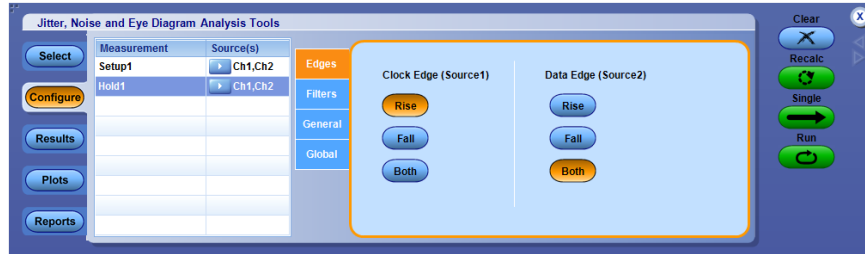

Item	Description
Clock Edge (Source1)	
Rise	Uses only the rising edges of the signal.
Fall	Uses only the falling edges of the signal.
Both	Uses both the rising and falling edges of the signal.
Clock Edge (Source2)	
Rise	Uses only the rising edges of the signal.
Fall	Uses only the falling edges of the signal.
Both	Uses both the rising and falling edges of the signal.

Configuring edges for CC-Period/Duty cycle measurements. This configuration tab is displayed for the CC-Period, +Duty Cycle and -Duty Cycle measurements. These measurements are only defined for clock signals, and each measurement value is evaluated over one full clock cycle.

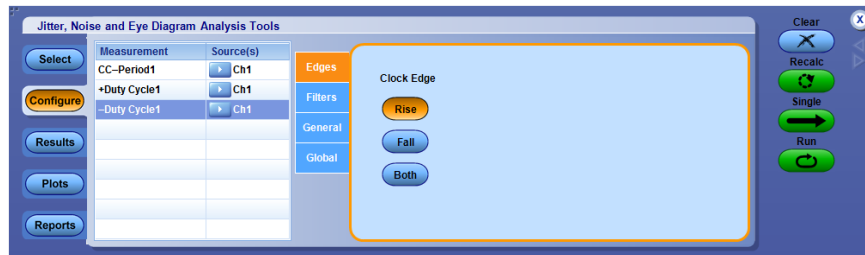

Item	Description
Clock Edge	
Rise	Measurements are only initiated on the Rising edges of the clock signal.
Fall	Measurements are only initiated on the Falling edges of the clock signal.
Both	Measurements are initiated on both the Rising and falling edges of the clock signal.

Configuring edges for DCD measurement. This configuration tab is displayed for DCD measurement.

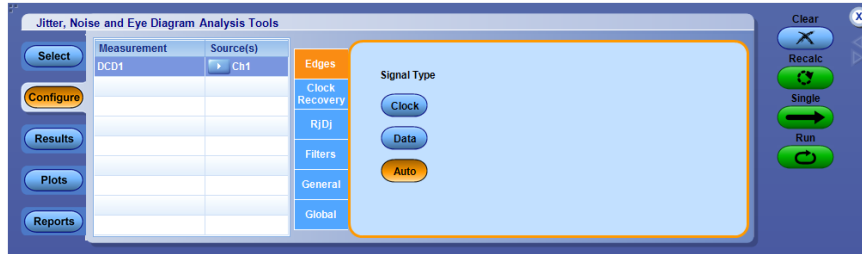

Item	Description
Signal Type	
Clock	Forces the signal type to Clock. Edges are selectable.
Data	Forces the signal type to Data. Both rising and falling edges are used.
Auto	Automatically detects whether the signal is clock or data.

Configuring edges for Overshoot/Undershoot measurements. This configuration is displayed for both Overshoot and Undershoot measurements. The algorithm calculates the maximum peak amplitude above/below the specified edge configuration *Reference level voltage* for Overshoot/Undershoot measurements.

An Overshoot event is defined by a rising crossing followed by a falling crossing of the reference level. Undershoot is defined by a falling crossing followed by a rising crossing of the reference level.

The difference between the peak amplitude and the reference level voltage is shown in the measurement results, expressed as a positive value in all cases. The results are stored zero for the cycles which do not have Overshoot/Undershoot.

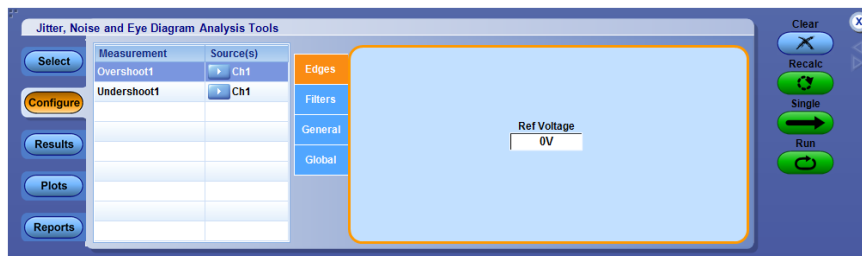

Configuring edges for rise/fall slew rate.

This configuration is displayed for rise slew rate measurement:

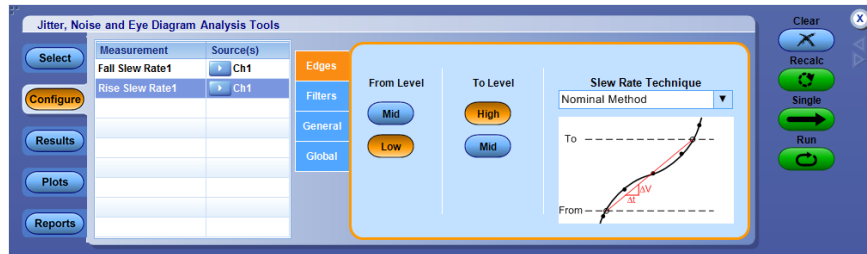

Table 48: Configuration options for rise slew rate

Item	Description
From Level	
Mid	Uses the source configuration mid reference voltage level for the Rise slew rate.
Low	Uses the source configuration low reference voltage level for the Rise slew rate. Default is low.
To Level	
High	Uses the source configuration high reference voltage level for the Rise slew rate. Default is high.
Mid	Uses the source configuration mid reference voltage level for the Rise slew rate.
Slew Rate Technique	
Nominal Method	Determines the slew rate between From -> Low level to To -> High level.
DDR Method	Determines the slew rate between low to high reference level. If the actual signal is earlier than the nominal slew rate line, then the slew rate is calculated using the tangent method From->Low level to To->High to the sample, which occurred earlier.

This configuration is displayed for fall slew rate measurement:

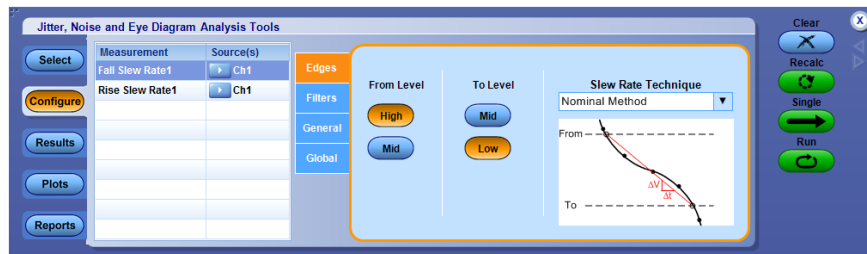

Table 49: Configuration options for fall slew rate

Item	Description
From Level	
High	Uses the source configuration high reference voltage level for the Fall slew rate. Default is high
Mid	Uses the source configuration mid reference voltage level for the Fall slew rate.
To Level	
Mid	Uses the source configuration mid reference voltage level for the Fall slew rate.
Low	Uses the source configuration low reference voltage level for the Fall slew rate. Default is low.
Slew Rate Technique	
Nominal Method	Defines the slew rate between From -> Low level to To -> High level.
DDR Method	Determines the slew rate between high to low reference level. If the actual signal is earlier than the nominal slew rate line, then the slew rate is calculated using the tangent method From->High level to To->Low to the sample, which occurred earlier.

Related topics

[High mid and low reference voltage levels](#)

Configuring edges for time outside level. This configuration is displayed for the Time Outside Level measurement:

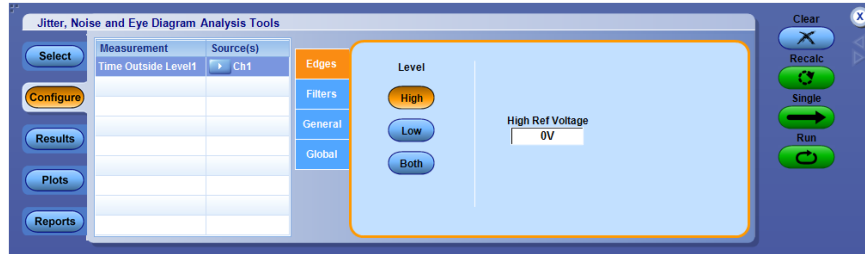

Item	Description
Level	
High	Time Outside Level measurement is computed only in overshoot using High Ref Level.
High Ref Voltage	Displays or allows you to define the high reference voltage level.
Low	Time Outside Level measurement is computed only in undershoot using Low Ref Level.
Low Ref Voltage	Displays or allows you to define the low reference voltage level.
Both	Time Outside Level measurement is computed in both overshoot and undershoot using High and Low Ref Levels.

Related topics.

[High mid and low reference voltage levels](#)

Configuring edges for F/N measurements - Jitter Only. This configuration tab is displayed for F/N measurements.

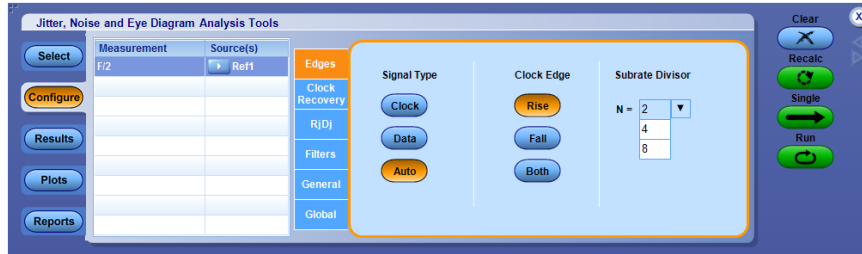

Item	Description
Signal Type	
Clock	Forces the signal to be interpreted as a Clock. Measurements will take place on the edges specified by the Clock Edge control.
Data	Forces the signal to be interpreted as a Data. Both rising and falling edges are used.
Auto	Allows the application to automatically detect whether the signal is clock or data. If the signal is a clock, the Clock Edge control will determine which edges are used; otherwise the Clock Edge control will have no effect.
Clock Edge	
Rise	Uses only the rising edges of the signal.
Fall	Uses only the falling edges of the signal.
Both	Uses both the rising and falling edges of the signal.
Subrate Divisor	
N	Specifies the subrate divisor value 2 , 4, 8 which is used to compute F/2, F/4, F/8 jitter measurement.

Configuring edges for F/N measurements - Jitter + Noise. This configuration tab is displayed for F/N measurements when the analysis method selected is Jitter + Noise.

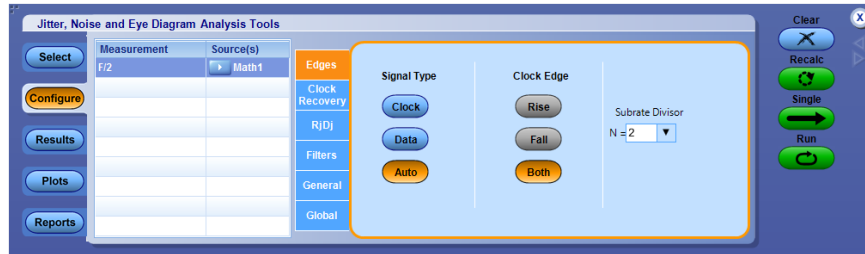

Item	Description
Signal Type	
Clock	Forces the signal to be interpreted as a Clock. Measurements will take place on the edges specified by the Clock Edge control.
Data	Forces the signal to be interpreted as a Data. Both rising and falling edges are used.
Auto	Allows the application to automatically detect whether the signal is clock or data. If the signal is a clock, the Clock Edge control will determine which edges are used; otherwise the Clock Edge control will have no effect.
Clock Edge	
Rise	Disabled (greyed out)
Fall	Disabled (greyed out)
Both	Uses both the rising and falling edges of the signal.
Subrate Divisor	
N	Specifies the subrate divisor value 2 , 4, 8 which is used to compute F/2, F/4, F/8 jitter measurement.

Configuring edges for DDR tCH(avg) and DDR tCL(avg). This configuration tab is displayed for both DDR tCH(avg) and DDR tCL(avg). Set the window size for clock measurements. The measurement analysis is done on a sliding window of size 200 cycles with a step increment of 1 cycle. You can set window size up to 1M, with at least 200.

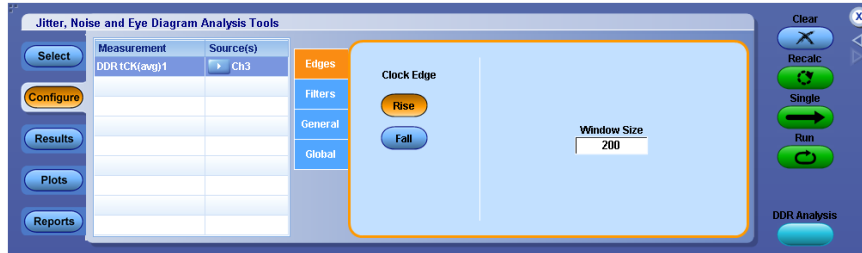

Configuring edges for DDR tERR(m-n). This configuration tab is displayed for DDR tERR(m-n) measurement.

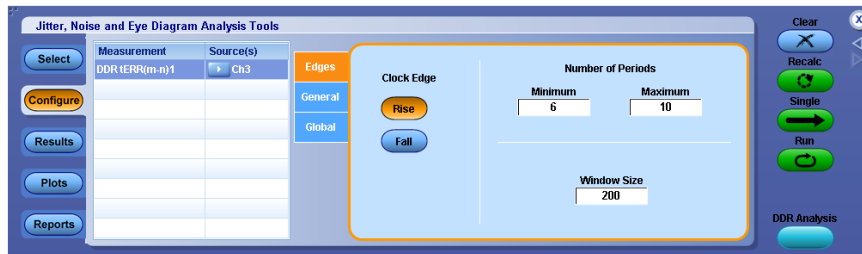

Item	Description
Clock Edge	
Rise	Measurements are only initiated on the Rising edges of the clock signal.
Fall	Measurements are only initiated on the Falling edges of the clock signal.
Minimum	Specify the minimum number of periods required to calculate error across multiple consecutive cycles from tCK(avg).
Maximum	Specify the maximum number of periods required to calculate error across multiple consecutive cycles from tCK(avg).
Window Size	Measurement analysis is done on a window of size 200 cycles with a step increment of 1 cycle. As per the standard, the default window size is 200. You can set window size up to 1M.

Configuring edges for DDR tERR(n). This configuration tab is displayed for DDR tERR(n) measurement.

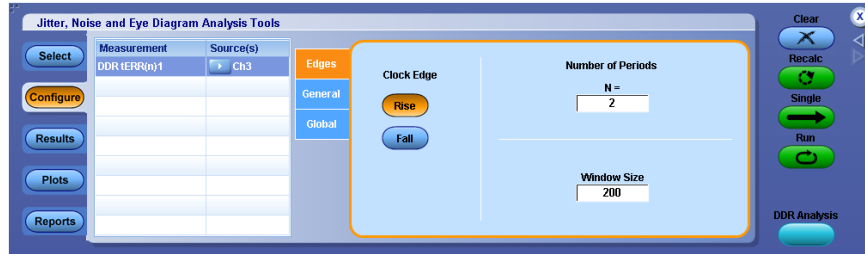

Item	Description
Clock Edge	
Rise	Measurements are initiated only on the Rising edges of the clock signal.
Fall	Measurements are initiated only on the Falling edges of the clock signal.
Number of Periods	Timing error (tERR) requires number of periods (n(per)) to calculate error across multiple consecutive cycles from tCK(avg). You can configure n(per) up to 50, with a resolution of 1.
Window Size	Measurement analysis is done on a window of size 200 cycles with a step increment of 1 cycle. As per the standard, the default window size is 200. You can set window size up to 1M.

Configuring edges for DDR tHZDQ and DDR tLZDQ. This configuration tab is displayed for both DDR tHZDQ and DDR tLZDQ.

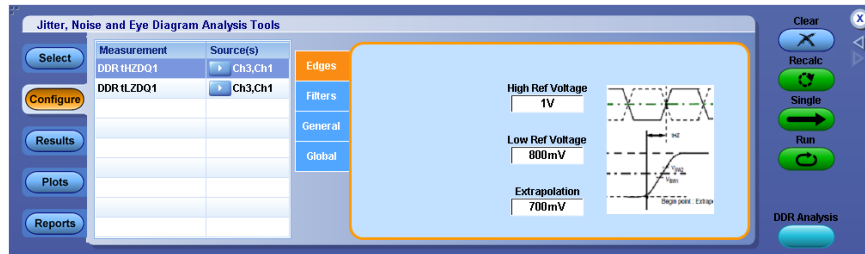

Configuring edges for DDRtJIT(per) DDRtCK(avg) and DDRtJIT(duty). This configuration tab is displayed for DDRtJit(per), DDRtCK(avg) and DDRtJIT(duty).



Item	Description
Clock Edge	
Rise	Measurements are only initiated on the Rising edges of the clock signal.
Fall	Measurements are only initiated on the Falling edges of the clock signal.
Window Size	Measurement analysis is done on a window of size 200 cycles with a step increment of 1 cycle. As per the standard, the default window size is 200. You can set window size up to 1M.

Configuring edges for DDR VIH.DQ(AC), VIH.DQ(DC), VIL.DQ(AC), and VIL.DQ(DC). This configuration tab is displayed for DDR VIH.DQ(AC), VIH.DQ(DC), VIL.DQ(AC), and VIL.DQ(DC).

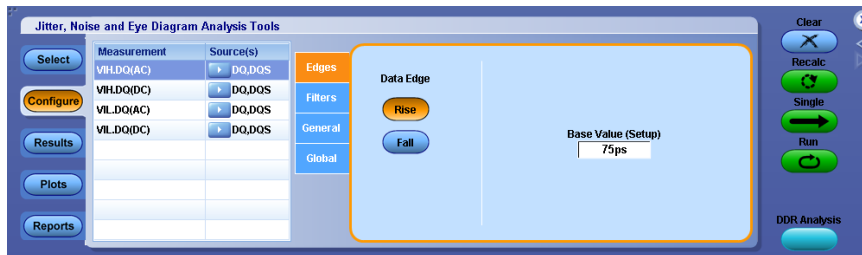

Item	Description
Data Edge	
Rise	Measurements are only initiated on the Rising edges of the clock signal.
Fall	Measurements are only initiated on the Falling edges of the clock signal.
Base Value (Setup)	

SSC **Spread spectrum clocking (SSC).** This configuration tab allows you to set the nominal frequency of the Spread spectrum clocking (SSC).

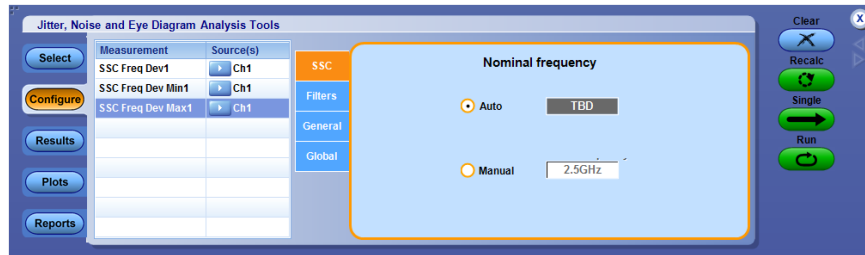

Table 50: Spread spectrum clock

Item	Description
Nominal frequency	
Auto	Allows the application to determine the frequency.
Manual	You enter the nominal frequency of the spread spectrum clock.

Margin This configuration tab is displayed for the Mask Margin configuration.

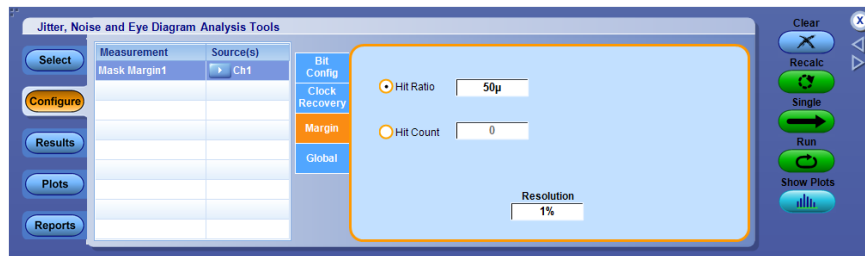

Table 51: Margin config for mask margin

Item	Description
Hit Ratio	Allows the user to set a threshold mask hit ratio value and the mask margin computation proceeds till it reaches the defined hit ratio or 100%
Hit Count	Allows the user to set a threshold mask hit count value and the mask margin computation proceeds till it reaches the defined hit count or 100%.
Resolution	Allows the user to set a resolution to be used in the mask margin computation. Higher resolution gives coarser results and smaller resolution gives finer results.

DFE This configuration tab is displayed for DFE EH, DFE EW, and DFE Eye Diagram measurements.

Configuring for DFE EH. This configuration tab is displayed for DFE eye height measurement.

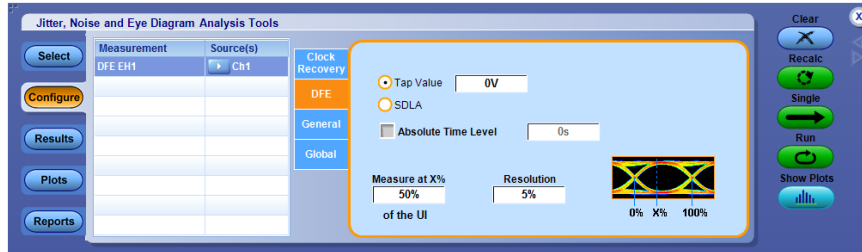

Table 52: DFE configuration for DFE EH

Item	Description
Tap Value	Enter the explicit DFE tap value. Default value is 0V
SDLA	Displays the DFE tap value for SDLA output file. Default path is C:\Users\Public\Tektronix\TekApplications\SDLA\FinalEQResults.txt
Absolute Time Level	Sets the window around the V% to search for the maximum width. Default value is 0 s.
Measure at X% of the UI	Sets the horizontal position where the measurement is taken, as a percentage of the Unit Interval. Default value is 50%.
Resolution	Sets the window around the X% to search for the maximum width/height. Default value is 5%.

Configuring for DFE EW. This configuration tab is displayed for DFE eye width measurement.

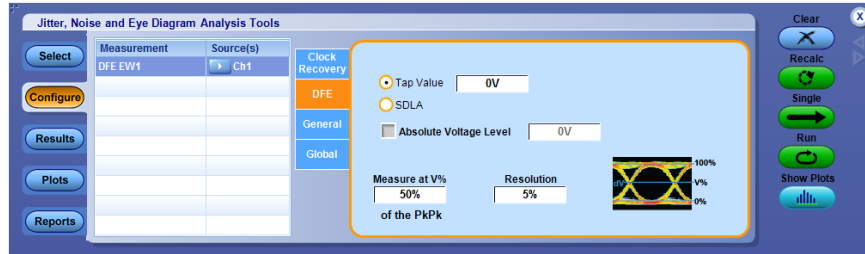

Table 53: DFE configuration for DFE EW

Item	Description
Tap Value	Enter the explicit DFE tap value. Default value is 0V
SDLA	Displays the DFE tap value for SDLA output file. Default path is C:\Users\Public\Tektronix\TekApplications\SDLA\FinalEQResults.txt
Absolute Voltage Level	Sets the window around the V% to search for the maximum width. Default value is 0V.
Measure at V% of the PkPk	Sets the reference voltage in the vertical scale to measure the eye width. Default value is 50%.
Resolution	Sets the window around the X% to search for the maximum width/height. Default value is 5%.

Configuring DFE Eye Diagram. This configuration tab is displayed for DFE Eye Diagram measurement.

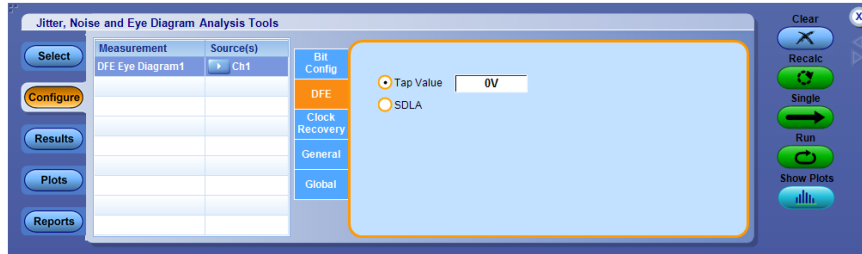

Table 54: DFE configuration for DFE Eye Diagram

Item	Description
Tap Value	Enter the explicit DFE tap value. Default value is 0V
SDLA	Displays the DFE tap value for SDLA output file. Default path is C:\Users\Public\Tektronix\TekApplications\SDLA\FinalEQResults.txt

General configuration (DPOJET)

One touch jitter

One Touch Jitter is a process for automatically performing complex jitter analysis with a single menu selection. The process selects a waveform source, sets the horizontal and vertical scales, chooses measurements, generates statistical results and creates plot summary (Histogram, Spectrum, Bathtub and Eye Diagram). To run this process, select **Analyze > Jitter and Eye Analysis (DPOJET) > One Touch Jitter**.

By default, the DPOJET application chooses an appropriate source for the jitter measurements from the available active source(s) (amplitude >50 mV) before generating the jitter summary.

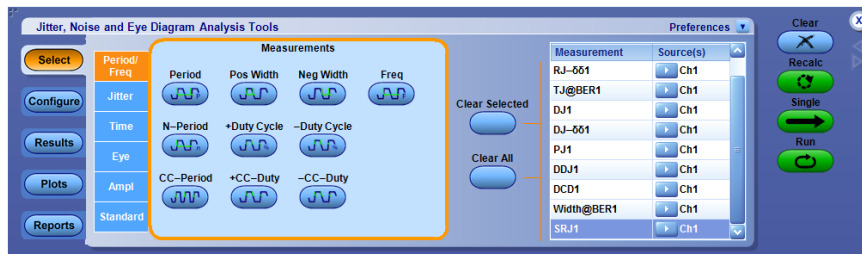

NOTE. *If the source amplitude is not greater than 50 mV, the application displays a message “Signal amplitude is extremely low for the selected source”.*

The following logic is used if none or many sources are active:

- *None of the sources are active*
- *Only one source is active*
- *Two sources are active*
- *Three sources are active*
- *Four or more sources are active*

Case 1: None of the sources are active. If none of the sources are active, you are prompted to select any one of the Ch, Ref or Math sources. The selected source is validated to have amplitude >50 mV. When the amplitude of the selected source is >50 mV, then autoset is performed to increase vertical and horizontal resolution of the signal. The selected source is assigned for all single source jitter measurements. The results and plots are generated for a single sequence.

Case 2: Only one source is active. The application checks if the active source has amplitude >50 mV. The selected source is assigned for all single jitter measurements. The results and plots are generated for a single sequence.

Case 3: Two sources are active. The application checks whether the active sources are a differential pair. If so, it creates a Math waveform by taking the difference of the two (Example: Math1=Ref1-Ref2). The lowest numbered Math waveform is considered as the source for all single jitter measurements. The results and plots are generated for a single sequence.

If the active sources are not a differential pair, the application checks if one of the source is a clock with a period that divides the other sources. An explicit clock recovery method derives the clock from the clock source. The application creates explicit-clock measurements TIE, Height, TJ@BER, RJ- $\delta\delta$, DJ- $\delta\delta$ and Width@BER for the source. The results and plots are generated for a single sequence.

If one of the active sources is not a clock, the application selects a single source from the active sources using the following priority:

- 1st- Lowest numbered Math
- 2nd- Lowest numbered Channel
- 3rd- Lowest numbered Ref

The results and plots are generated for a single sequence.

Case 4: Three sources are active. The application checks whether one of the active sources is a Math, which is defined as difference of two sources (Example: $\text{Math1} = \text{Ref1} - \text{Ref2}$). The application selects the Math waveform as the source for all single source jitter measurements. The results and plots are generated for a single sequence.

If one of the active sources is not a Math, the application selects a single source from the active sources using the following priority:

- 1st-Lowest numbered Math
- 2nd-Lowest numbered Channel
- 3rd-Lowest numbered Ref

The application creates single source jitter measurements. The results and plots are generated for a single sequence.

Case 5: Four or more sources are active. If four or more sources are active, the application selects a single source from the active sources using the following priority:

- 1st-Lowest numbered Math
- 2nd-Lowest numbered Channel
- 3rd-Lowest numbered Ref

The application creates single source jitter measurements for the selected source. The results and plots are generated for a single sequence. The following figure shows the summary plot after One Touch Jitter is performed.

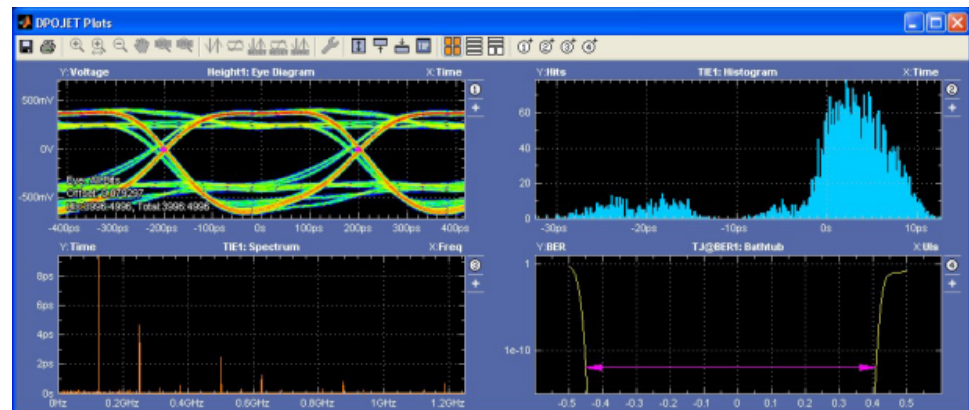

Serial Data/Jitter guide

About serial Data/Jitter guide. The Serial Data/Jitter Guide allows you to set up, configure and run a measurement without intimate knowledge about the control menus.

Select **Analyze > Jitter and Eye Analysis (DPOJET) > Serial Data/Jitter Wizard** to launch the Serial Data/ Jitter Wizard.

The Serial Data/ Jitter Wizard includes the following steps:

Select measurement

Configure measurement

Select source(s)

Configure autoset options

Select plots

NOTE. *You can exit the Serial Data/Jitter Wizard without affecting any settings in the DPOJET application by clicking anytime before clicking the button.*

Select measurement. In this step, you can select any of the listed measurements:



- Period and Frequency
- Skew
- Time Interval Error (TIE)
- Jitter Summary includes Total Jitter (TJ@BER), RJ, DJ, PJ, DDJ, TIE, and DCD measurements and plots
- *Eye summary* includes Height, Height@BER, Width, Width@BER, and Unit Interval measurements and plots

By default, the Period and Frequency measurement is selected. Click **Next** to accept the measurement and proceed to Configure Measurement. The transition

to next step is represented by  on the left along with selections or default values.

About configuring measurement. By default, the configuration parameters are displayed for Period and Frequency, TIE and Eye measurements. The Configure Measurement option is available only for Skew and Jitter Summary. The selection in the previous step is displayed on the left.

Configure skew measurement

Configure jitter summary measurement

Configure measurement-Skew. If you select Skew in the previous step, you can configure edges by selecting the **From** and **To** edges and set the measurement limits.

Click **Next** to select the measurement sources.



Related topics.

[Configure edges for skew measurement](#)

Configure measurement-Jitter summary. If you select Jitter Summary measurement in the previous step, the bit rate and pattern length will automatically be determined by DPOJET, thus the Configure Measurement section is not required.

NOTE. *The measurements that you select also determine the plot types.*

Click **Next** to select the measurement sources.



Related topics.

[RJ-DJ analysis parameters](#)

[RJ-DJ](#)

Select sources. In this step, you can select the measurement source(s). The source selection depends on the measurement type. By default, Source1 is displayed automatically for all the measurements depending on the waveform last used. If Ch1/Ref1/Math1 is displayed for Source1, Source2 is Ch2/Ref2/Math2 else Ch1/Math1/Ref1 will be selected as Source2.



The Source2 option is displayed only for two source measurements such as Skew.

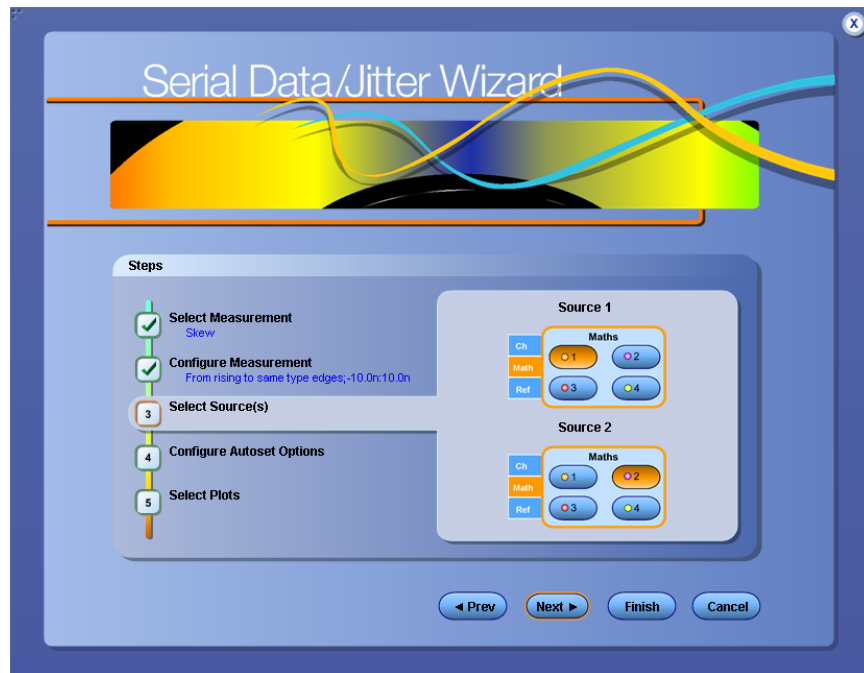

Click **Next** to configure autoset.

Configure autoset options. In this step, you can choose to automatically adjust the oscilloscope settings or the reference levels before the measurement. The default of Yes is recommended. By selecting No, you will retain the current oscilloscope settings and/or ref levels.

Click **Next** to select plots.



Select plots. In this step, you can select the plots that you want to display. The measurements that you selected earlier also determine which plot types will be available in this step. The following table lists the available plots for measurements:

Table 55: Measurements and available plots

Measurement	Plots
Period and Frequency	Period Trend, Period Spectrum, Period Histogram.
Skew	Skew Trend, Skew Spectrum.
TIE	TIE Trend, TIE Spectrum, TIE Histogram.
Jitter Summary	TIE Trend, TIE Spectrum, TIE Histogram, and Bathtub Curve.
<i>Eye summary</i>	Eye Diagram (Transition Bit), Eye Diagram (Non Transition Bit) Unit Interval Histogram, and Eye Width@BER.

In this example, the selections shown are for a Period and Frequency measurement.

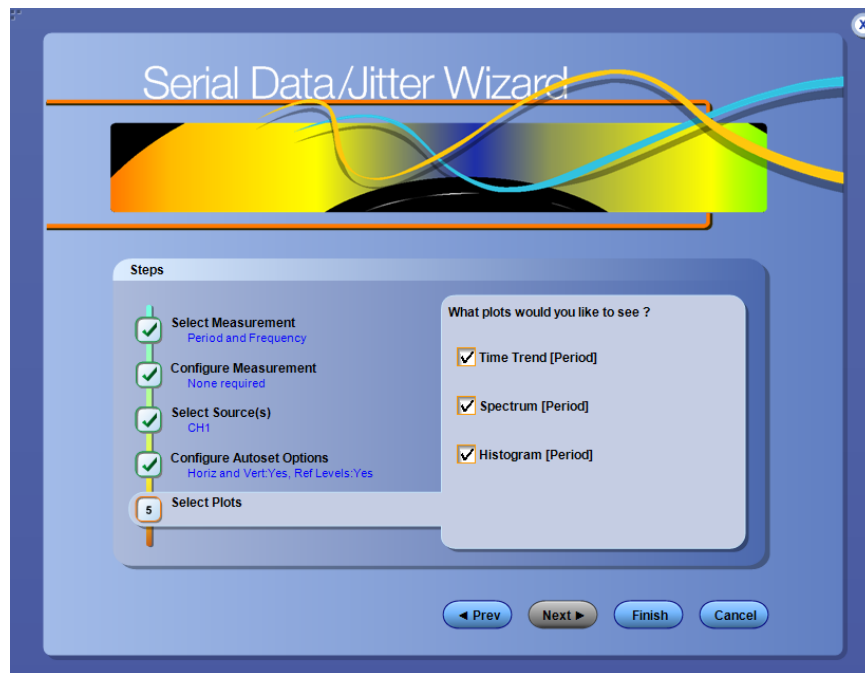

Click **Finish** to start the acquisition sequence using the selected settings. The Serial Data/Jitter Guide window closes and the results screen is displayed.

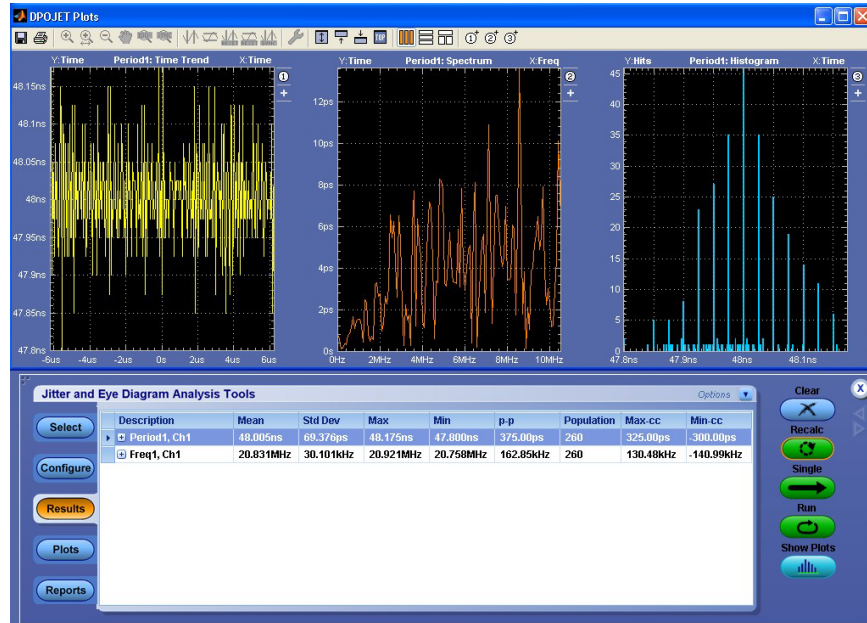

NOTE. None of the user specified settings are retained if you click before clicking .

Configuring for SSC (Spread Spectrum Clocking). Spread spectrum clocking involves modulating the clock frequency of a device and high-speed serial signals in a controlled manner. The purpose of using SSC modulation is to spread the spectral energy to mitigate interference due to unintentional RF radiation. The typical modulating frequency is 33.3 kHz.

The Serial Data wizard will configure DPOJET appropriately to see an open eye diagram for a signal with SSC, by using PLL clock recovery to track the modulation. If your goal is to analyze the SSC modulation profile versus time, a different configuration is required. You can use the SSC-related measurements (SSC Profile, SSC Mod Rate, SSC Freq Dev, etc) to configure DPOJET appropriately for those purposes.

Source configuration

Custom source name. Any oscilloscope source (Channel, Math, or Reference) can have a custom label which is created or changed using the main oscilloscope interface:

- Channels: Vertical > Label
- Maths: Math > Setup
- References: File > Reference Waveform Controls

If a source has been assigned a custom label, both the native name and custom name are shown on the Source Config panel. When sources with custom labels appear in the measurement lists (for example, on the Select or Config panels of DPOJET), only the custom label is shown. To see the native name, move the mouse over the row in the measurement table; a tool tip displays the native name. In these cases, the custom label is shown, followed by the native name in parenthesis, for example DQS (Ch1).

The custom source names (DQ and DQS) appear in the following screens:

- Measurement table

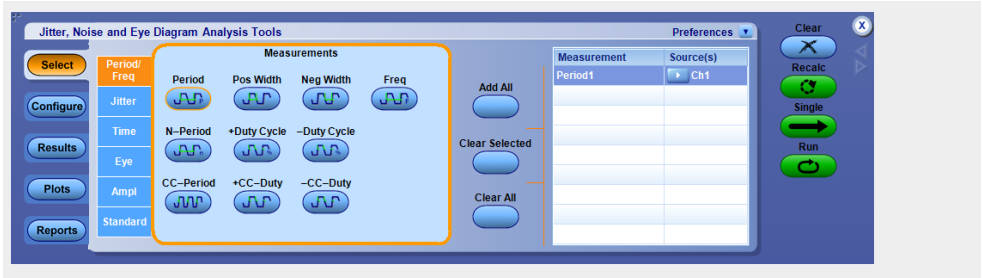

- Source configuration

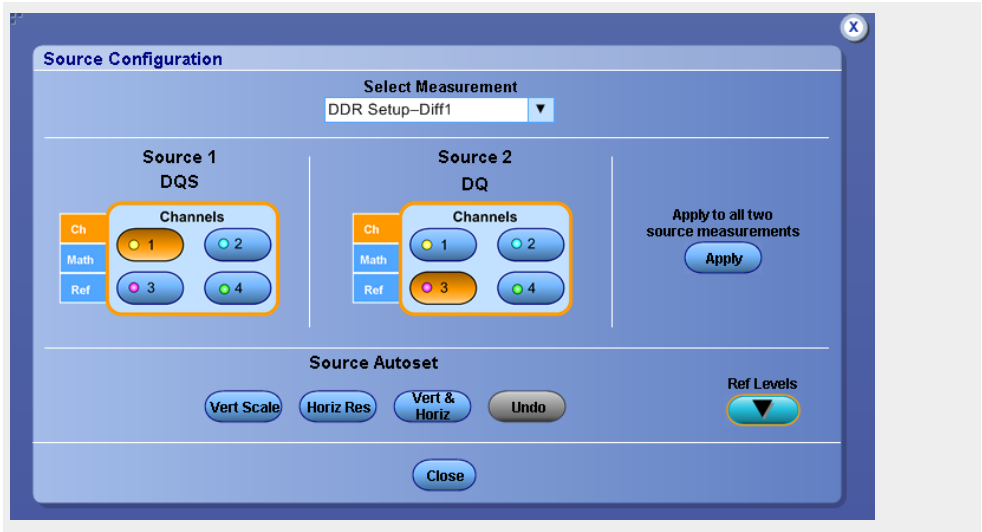

- Results

Jitter and Eye Diagram Analysis Tools

Description	Mean	Std Dev	Max	Min	p-p	Population	Max-cc	Min-cc
IDH-Diff(base), DQS...	778.50ps	5.3622ps	782.29ps	774.71ps	7.5833ps	2	0.0000s	0.0000s
IDOSH, DQS	96.072ps	50.293ps	204.17ps	22.500ps	181.67ps	79	176.17ps	-164.00ps
IDOSL, DQS	3.0997ns	1.5644ns	7.4255ns	26.667ps	7.3988ns	79	4.8987ns	-4.8717ns
IDS-Diff(base), DQS...	143.94ps	72.524ps	259.29ps	6.0000ps	253.29ps	30	239.28ps	-161.67ps
IDS-SE(base), DQS...	83.597ps	68.559ps	276.37ps	555.54fs	275.82ps	16	22.222ps	-24.222ps

■ Plots

Jitter, Noise and Eye Diagram Analysis Tools

Plots

Time Trend Data Array Histogram
Spectrum Transfer

Plot Type Measurement
Spectrum Setup1,DQS...
Transfer Setup1,DQS...
Data Array Setup1,DQS...
Histogram Setup1,DQS...

■ Data snapshot

Data Snapshot

Select Target Measurements

Measurement	Source(s)
<input checked="" type="checkbox"/> Skew1	DQS,DQ
<input checked="" type="checkbox"/> Setup1	DQS,DQ
<input checked="" type="checkbox"/> Hold1	DQS,DQ
<input checked="" type="checkbox"/> DC Common Mod...	DQS,DQ
<input checked="" type="checkbox"/> High1	DQS

File Name
C:\Users\johnh\Tektronix\TekApplications\DPOJET\Logs\Stat

■ Data logging

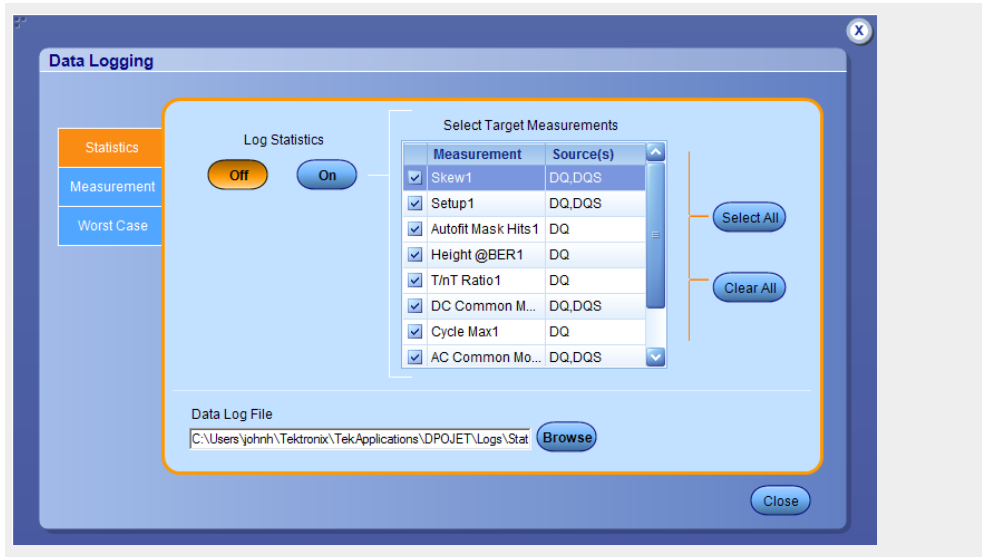

■ Measurement summary

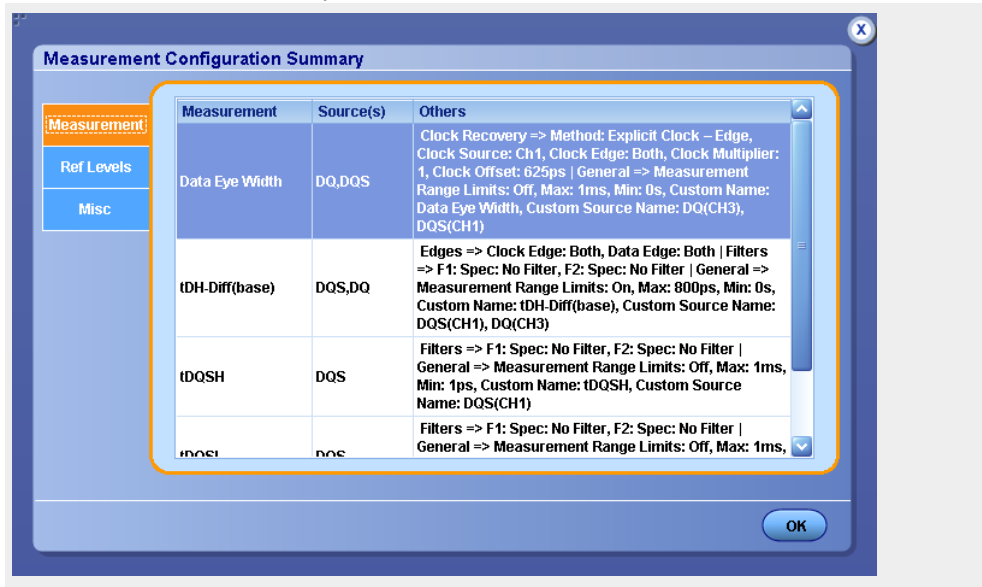

■ Export results to Ref

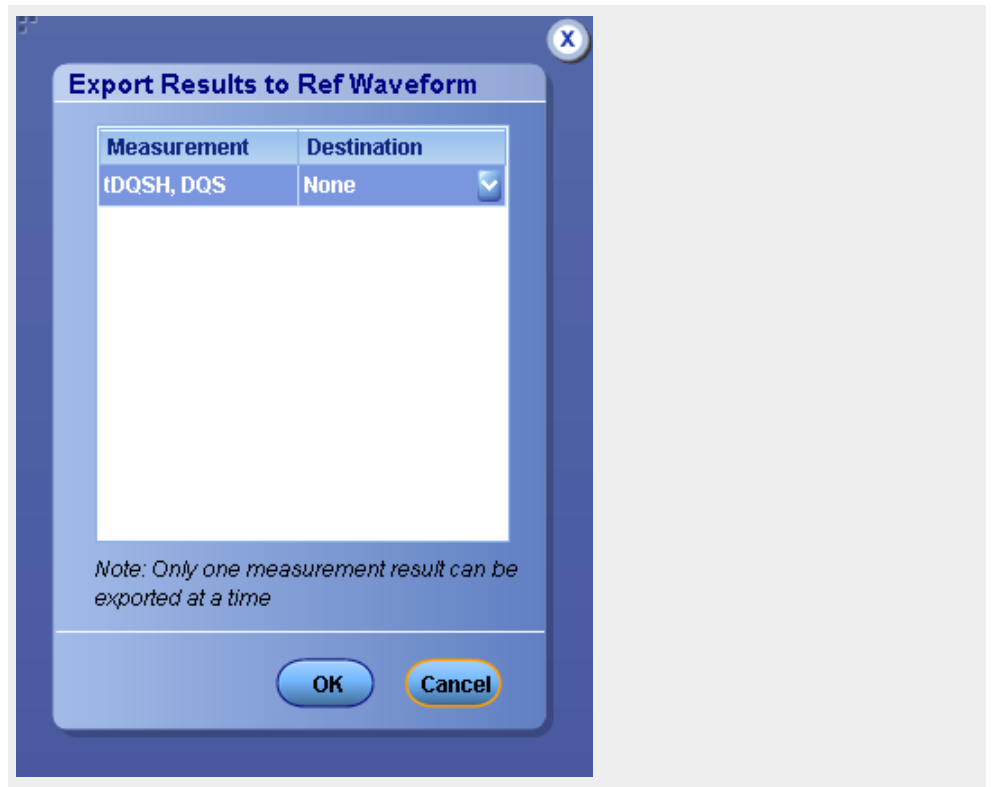

Sources setup. The application takes measurements from waveforms specified as input sources. You can select an oscilloscope channel input (live), a reference or a math waveform as the source and also view *Labels* of the selected waveforms. Some measurements require a *Bus as a source*.

You can configure sources using any of the following options:

- Click  icon in the table which lists the selected measurements.
- Double-click anywhere on a row in the table that lists the selected measurements.

The source selections depend on the selected measurement.

NOTE. *Setup, Hold, V-Diff-Xovr, DC Common Mode and Skew* are two source measurements. The *Source2* option is displayed only for two source measurements.

When more than one single source measurement is selected, **Apply to all single source measurements** option is enabled in the source configuration screen.

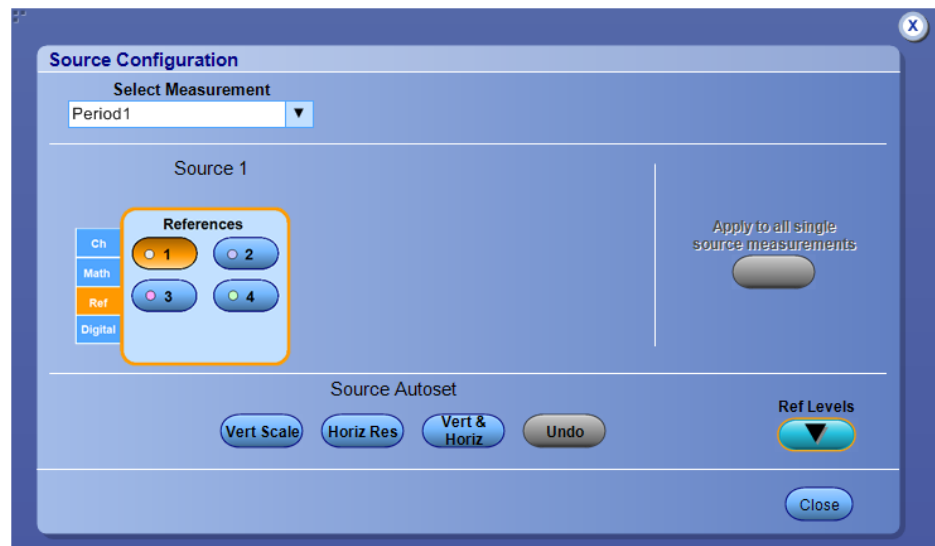

When more than one two source measurement is selected, **Apply to all two source measurements** option is enabled in the source configuration screen.

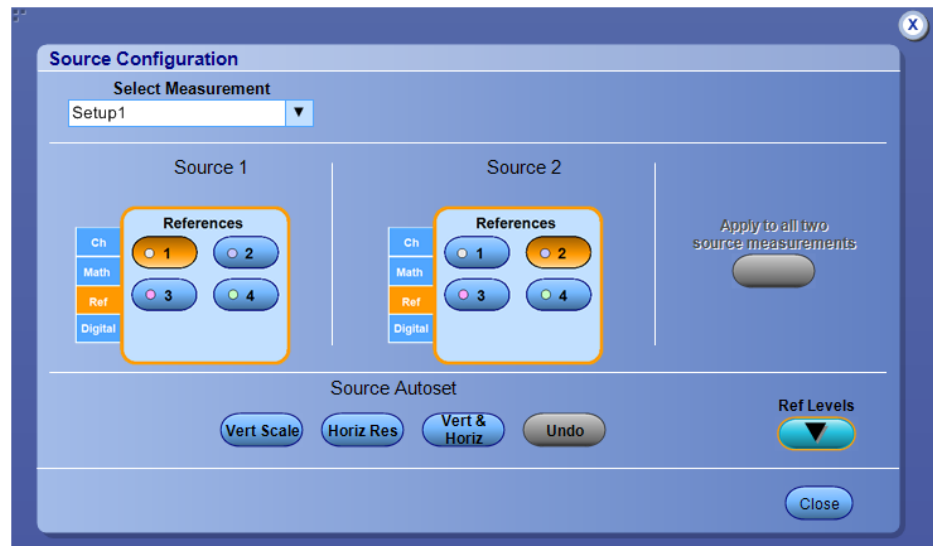

NOTE. Although any DPOJET measurement can be assigned a custom name (Example: *tDQSH*), the custom name is not displayed in the DPOJET source configuration screen. Instead, the default name for the corresponding measurement is displayed.

Related topics.

[Source autoset](#)

[Ref levels](#)

[Bus as a source](#)

Source autoset. The Source Autoset allows you to automatically adjust the oscilloscope's vertical and/or horizontal settings for live sources (Ch1-Ch4) to improve measurement accuracy.

The Vertical Scale option automatically checks the peak-to-peak level of live sources. The vertical scale and offset of all signals with a peak-to-peak value less than six divisions are adjusted so the peak-to-peak will be eight divisions. If the maximum or minimum value of a signal is “clipped”, the vertical scale and offset are adjusted so that the peak-to-peak value will be eight divisions.

The Horizontal Resolution option checks the Rise Time/Resolution and Fall Time/Resolution of all live channels. The instrument horizontal resolution is set to the largest value that does not cause the samples-per-edge of the fastest edge to fall below five samples per edge. The option sets the acquisition sampling mode to Real Time for signals with very high edge speeds. Horizontal Autoset, by default, tries to set the record length corresponding to 10000 UI for any given waveform at highest possible sample rate.

To automatically define both the vertical and horizontal settings for all channel sources, select the Vert and Horiz button. The Vert and Horiz option also applies an oscilloscope autoset on each channel before performing the vertical scale and horizontal resolution autoset.

Follow these steps to automatically define the vertical or horizontal settings for active sources:

1. Ensure that any channel waveform that you want to autoset is visible on the oscilloscope.
2. Select one of the following options:
 - Vert & Horiz to autoset both vertical and horizontal setting.
 - Vert Scale button to autoset oscilloscope vertical settings only.
 - Horiz Res to autoset oscilloscope horizontal settings only.
3. Select Undo to return the oscilloscope to its state before autoset.

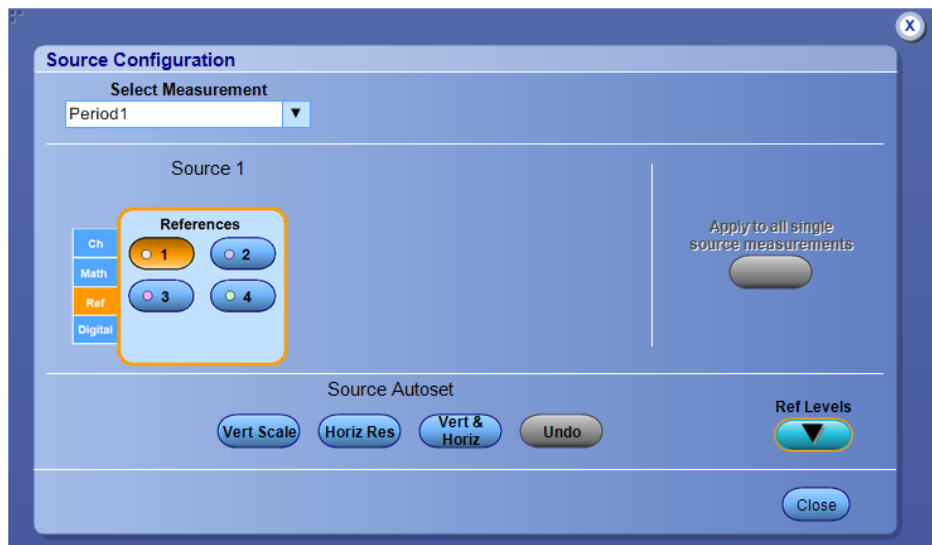

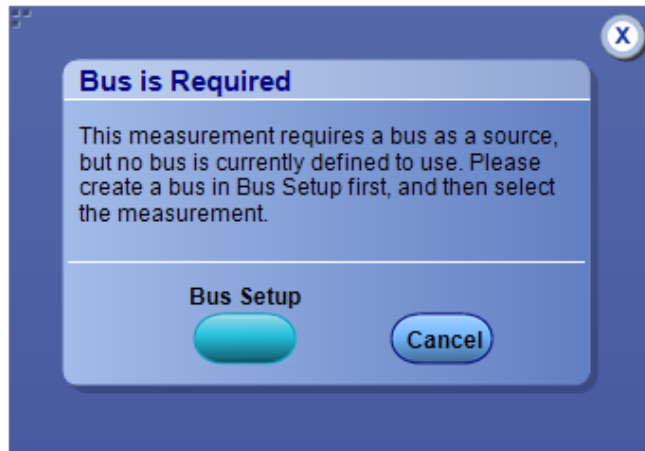

Table 56: Autoset configuration options

Item	Description
Vertical Scale	If a channel waveform is clipped or does not exceed six vertical divisions, adjust the scale so that the waveform occupies about eight divisions.
Horiz Res	Sets the horizontal resolution so that the number of samples on the fastest transition (edge) exceeds a specified target.
Vert & Horiz	Performs a sequence: Oscilloscope Autoset, Vertical scale and Horizontal resolution.
Undo	Returns to the settings present before an Autoset was performed; disabled after measurements are taken until you perform another source autoset.
Ref Levels Setup 	Click Ref Levels Setup in the Source Configuration screen to hide/unhide the Ref Levels Setup.

Bus as a source. On MSO model oscilloscopes only, some measurements (tCMD-CMD, GDDR5 tCKSRE, GDDR5 tCKSRX, and GDDR5 tBurst-CMD) require a bus as a source. Set up the bus using the Bus Setup window of TekScope, and set up the source using the Source Configurations window of DPOJET. If you try to select a measurement that requires a bus, but no bus is configured, a pop up asks you to set up a bus.



Clicking Bus Setup displays the Bus Setup window where you can configure a bus.

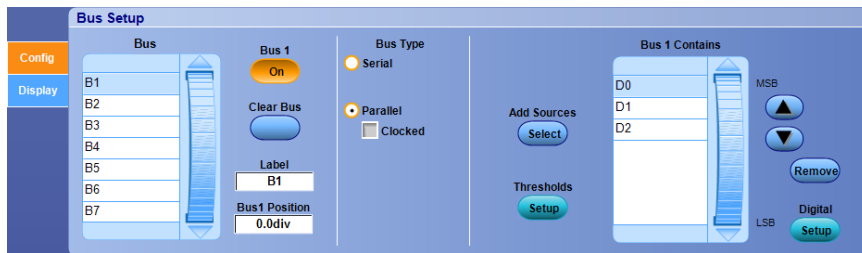

You can select sources using the Source configuration window. The selected bus is displayed and you can apply both the bus and analog source settings to all similar measurements. If the measurement requires one bus source and one clock source, the following Source Configuration window is displayed.

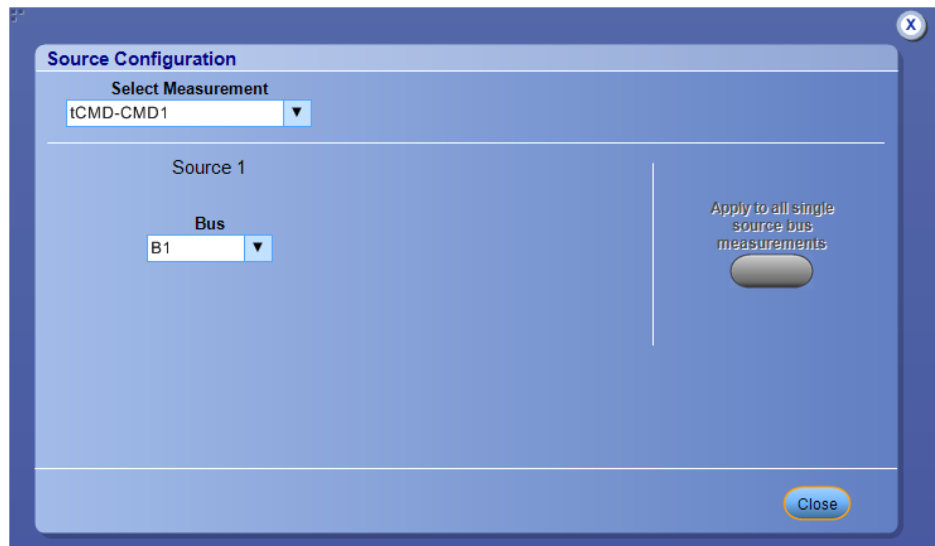

If the measurement has only one bus source, and Source Autoselect and Ref Level Autoselect are not required, then the following Source Configuration window is displayed.

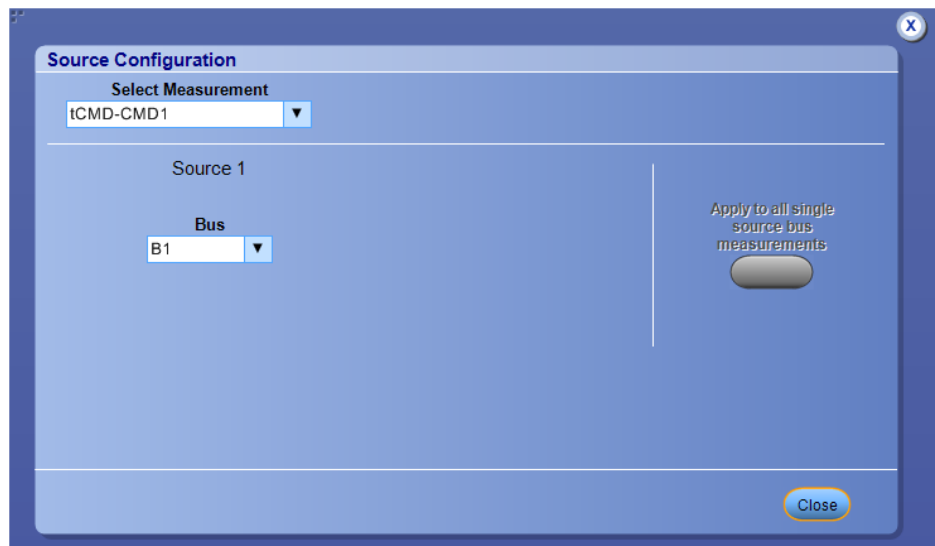

Related topic.

[Sources setup](#)

Digital as a source. DPOJET supports the following measurement on Digital channels. Digital source measurements are available only on MSO5000/70000 series of instruments running with 64-bit Windows 7 OS.

Period/Frequency measurements	Time measurements
Period	Skew
Positive Width	Setup
Negative Width	Hold
Frequency	
+Duty Cycle	
-Duty Cycle	
CC-Period	
+CC-Duty	
-CC-Duty	

Digital source selection. You can select any of the Digital channels (D0 – D15) from the digital tab as shown below.

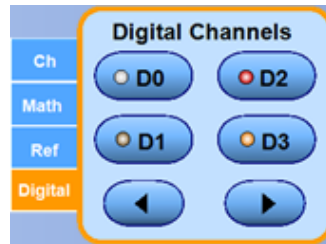

Left and Right arrows will display the previous and next set of digital channels as shown below:

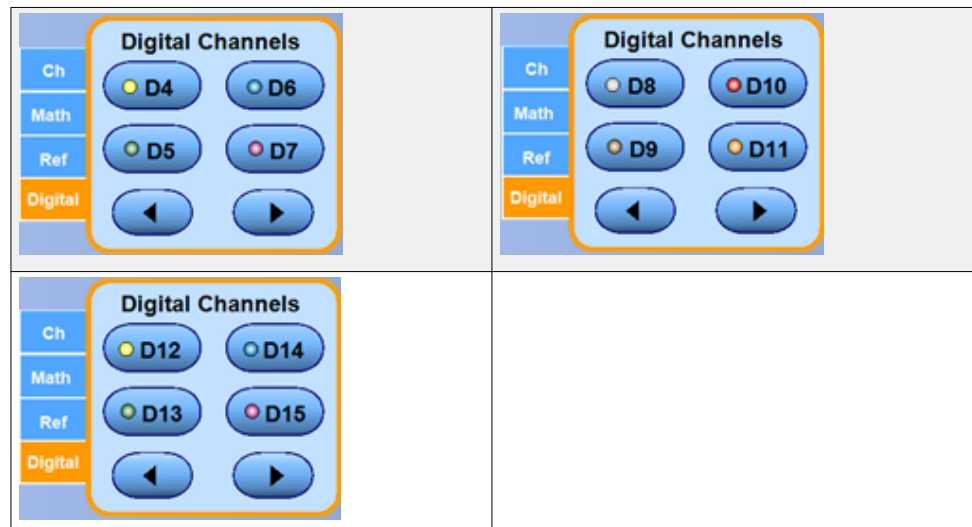

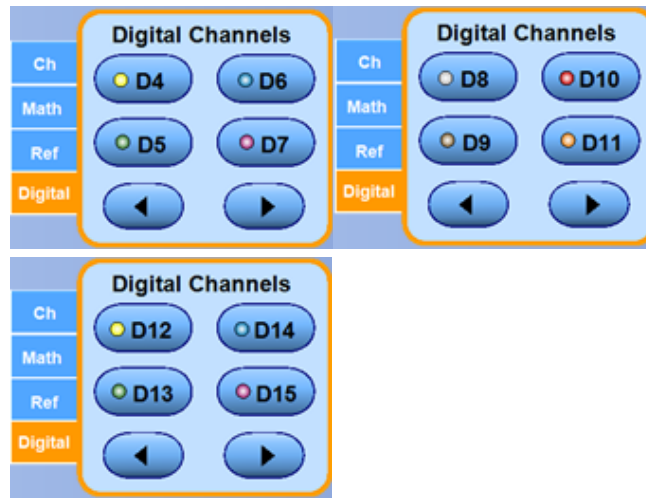

Digital sources do not have Source Autoset available. Also, digital sources are not used for performing Ref Level Autoset.

Configurations and features. All the configurations and the features that are supported for analog sources are supported for digital sources as well.

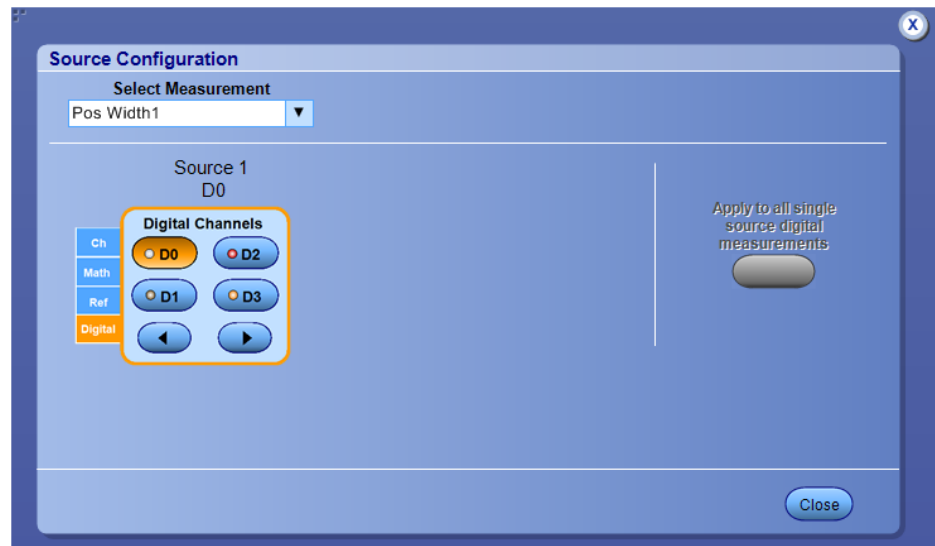

Related topic.

[Sources setup](#)

Ref levels. Timing measurements are based on state transition times. By definition, edges occur when a waveform crosses specified reference voltage levels. Reference voltage levels must be set so that the application can identify state transitions on a waveform. By default, the application automatically chooses reference voltage levels when necessary.

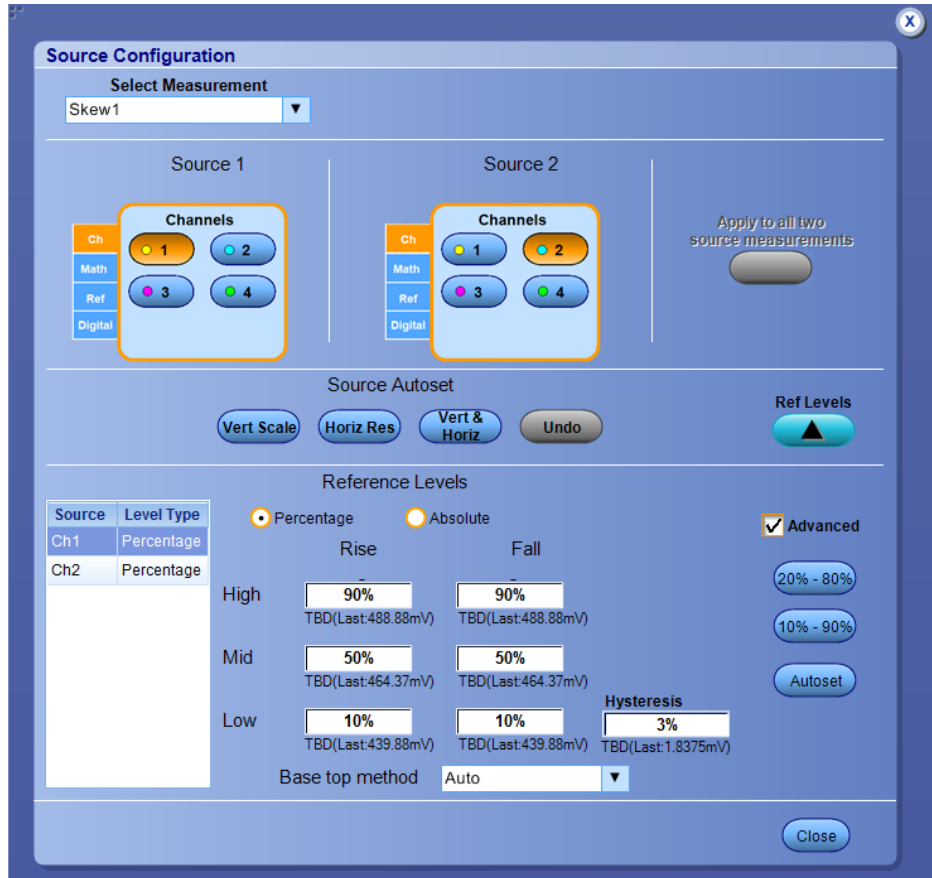

The DPOJET application uses three basic reference levels: High, Mid and Low. In addition, a hysteresis value defines a voltage band that prevents a noisy waveform from producing spurious edges. The reference levels and hysteresis are independently set for each source waveform, and are specified separately for rising versus falling transitions. There are two ways to set the reference voltage levels: *Automatic* and *Manual*.

High, mid and low reference voltage levels. The application uses three reference voltage levels: High, Mid, and Low:

- For most measurements, the application only uses the Mid reference voltage level. The Mid reference level defines when the waveform state transition occurs at a given threshold.
- For Rise Time and Fall Time measurements, the High and Low reference voltage levels define when the waveform is fully high or fully low.

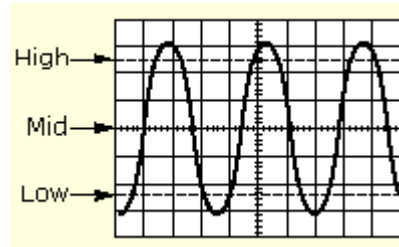

Rising Versus Falling Thresholds. You can specify thresholds for each of the reference voltage levels: High, Mid, and Low. The application uses the thresholds to determine the following events:

- A Low/Mid/High rising event, which occurs when the waveform passes through the corresponding Rise threshold in the positive direction.
- A Low/Mid/High falling event, which occurs when the waveform passes through the corresponding Fall threshold in the negative direction.

For a given logical reference level (such as Low, Mid, or High), rising and falling events alternate as time progresses.

NOTE. *In many cases, the rising and falling thresholds for a given reference voltage level are set to the same value. In those cases, a hysteresis value helps prevent spurious edges produced by small amounts of noise in a waveform.*

Using the hysteresis option. The hysteresis option can prevent small amounts of noise in a waveform from producing multiple threshold crossings. You can use a hysteresis when the rising and falling thresholds for a given reference voltage level are set to the same value.

The reference voltage level \pm the hysteresis value defines a voltage range that must be fully crossed by the waveform for an edge event to occur. If the decision threshold is crossed more than once before the waveform exits the hysteresis band, the mean value of the first and last crossing are used as the edge event time.

For example, if the waveform rises through the Threshold – Hysteresis, then rises through the Threshold, then falls through the Threshold, then rises through both the Threshold and the Threshold + Hysteresis, a single edge event occurs at the mean value of the two rising crossings.

Example of hysteresis on a noisy waveform.

Automatic versus manual reference voltage levels. Each measurement source can be configured to automatically choose voltage reference levels (default), or to use specific absolute reference voltages. In the automatic configuration, levels are chosen according to percentages of the overall signal amplitude.

In the Ref Levels Setup panel, a table at the left edge contains all of the current active measurement sources. If a source is configured for Percentages, appropriate reference levels will be chosen, when necessary (typically when you press the Single or Run button). Select Autoset at the right edge of the Source Configuration menu to force autoset to occur and to learn which absolute voltage will be used. For each level, the absolute voltage will be shown directly under the corresponding control. If Autoset has not been selected recently, the values will be shown as TBD; the last-used voltages will be displayed for reference.

Normally, the reference levels used for rising and falling edges are identical for a given threshold (High, Mid or Low). Some special cases demand different thresholds for rising edges than for falling edges. In those cases, select the Advanced check box to allow separate configuration based on polarity. The Advanced view also allows you to adjust the Hysteresis value or choose the Base-Top method.

For more details, refer to [Understanding when ref level autosest will occur](#) and [Understanding how ref level autosest chooses voltages](#).

Table 57: Configure sources ref levels autosest configuration

Item	Description
Autosest ¹	Calculates and displays the reference voltage levels for all sources where the autosest option is set according to the Autosest Ref Level Setup.
Base top method	Specifies the Base-Top method to be used for all reference voltage levels when autosest occurs.

Understanding when ref level autosest will occur. When Autosest is enabled for a given source, the individual reference levels are displayed but you may not manually adjust them. Instead, the reference levels are automatically recalculated whenever one of the following events occur:

- A measurement sequence is initiated for the first time after a source has become active.
- A measurement sequence is initiated for the first time after all results have been cleared.
- The Autosest button at the right edge of the panel is pressed.

The Autosest button is provided as a convenience, but it is never required. Autosest will always be run (if enabled) before an uninitialized source is used for a measurement.

Understanding how ref level autosest chooses voltages. Once triggered, the Reference Level Autosest function uses the following logic to determine actual voltage levels.

For each applicable source, the Top (high logic level) and Base (low logic level) are first determined. Then, the High, Mid and Low levels are calculated as percentages of the Top-Base difference. For example, if the Top and Base are 2.8 volts and 0.4 volts respectively and the High percentage level is 90%, this threshold would be calculated as:

$$HighThres = Base + High\ Percent (Top - Base) = 0.4 + 0.9 (2.8 - 0.4) = 2.56$$

Manually adjusting the reference voltage levels. Whether or not you use the application to automatically calculate the initial reference voltage levels, you may

¹ If you do not perform Autosest using the Autosest button, the application updates the reference levels (if required) when you select Single or Run to take measurements.

need to manually change the values. To set the reference levels manually, follow these steps:

1. Click  icon in the table which lists the selected measurements to view the source configuration screen.
2. Select the desired source from the Source list.

NOTE. You cannot select inactive sources.

1. Select the **Absolute** button.
2. Select the reference levels or hysteresis options and manually adjust the values. The values will not change when you select Autoset or take measurements.

NOTE. A source will become inactive if all measurements on that source are removed. If a new measurement is then added on that source, the source once again becomes active, and defaults to the Percentage method. If you clear all measurement on a source that was set to Absolute, you must reselect the Absolute method and levels (if desired) when the source is again added.

Click Percentage to set the reference levels in percentages.

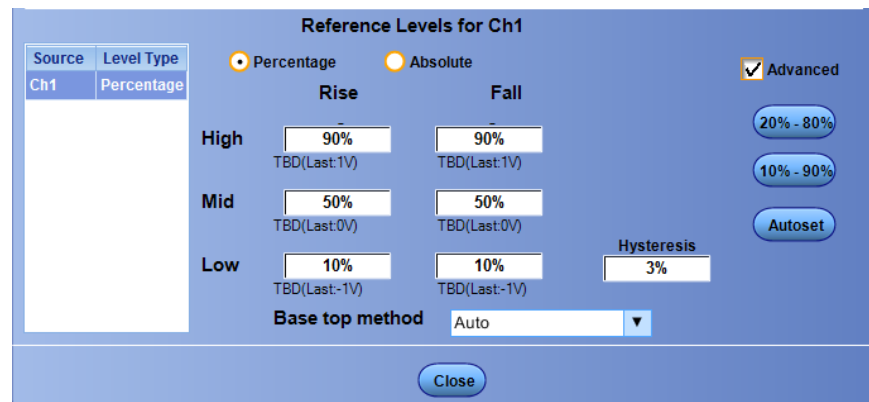

Click Absolute to set the reference levels manually to specific voltages.

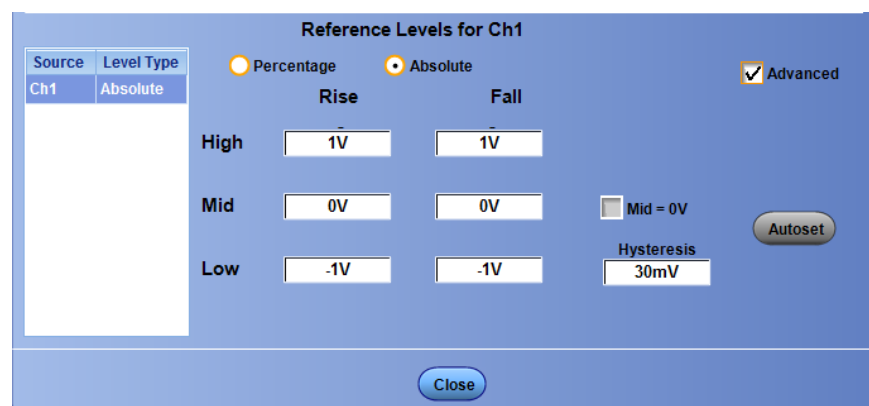

Click Percentage to set the reference levels in percentages with advanced not checked.

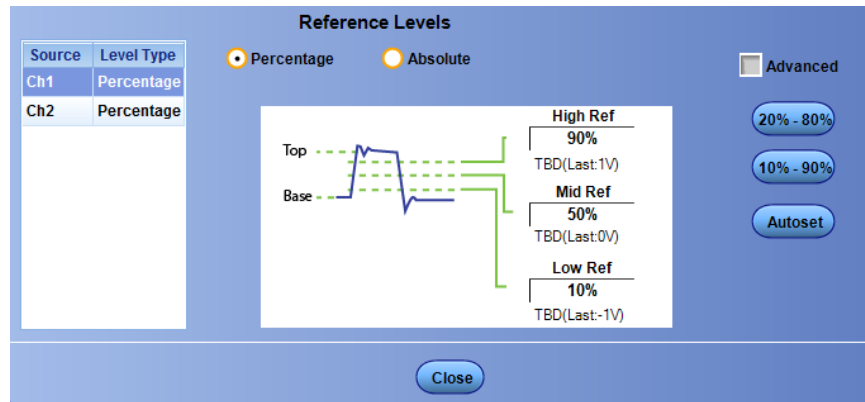

Click Absolute to set the reference levels manually to specific voltages with advanced not checked.

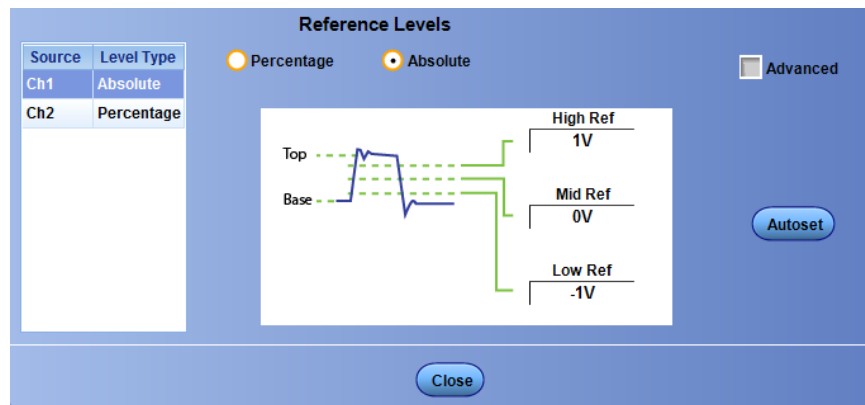

Table 58: Configure sources ref levels configuration

Item	Description
Autoset ²	Calculates and displays the reference voltage levels for all sources where the autoset option is set according to the Autoset Ref Level Setup.
Base top method	Specifies the Base-Top method to be used for all reference voltage levels when autoset occurs.
Advanced	Allows you to set the Rise and Fall reference levels independently.
Absolute	Allows manually setting the reference levels.

² If you do not update ref levels by clicking Autoset, the application updates the reference levels (if required) when you select the Single or Run to take measurements.

Item	Description
Percentage	Allows setting the reference levels as a percentage.
20% – 80%	Sets the low threshold level to 20%, the mid threshold level to 50%, and the high threshold level to 80%.
10% – 90%	Sets the low threshold level to 10%, the mid threshold level to 50%, and the high threshold level to 90%.
Ref Levels Setup (one level per source) ³	
Rise High	Sets the high threshold level for the rising edge of the source.
Rise Mid	Sets the middle threshold level for the rising edge of the source.
Rise Low	Sets the low threshold level for the rising edge of the source.
Fall High	Sets the high threshold level for the falling edge of the source.
Fall Mid	Sets the middle threshold level for the falling edge of the source.
Fall Low	Sets the low threshold level for the falling edge of the source.
Hysteresis	Sets the threshold margin to the reference level which the voltage must cross to be recognized as changing; the margin is the relative reference level plus or minus hysteresis; use to filter out spurious events.
Close	Accepts the changes and closes the window.

³ Default settings are 90% (High), 50% (Mid), 10% (Low), and 3% (Hysteresis).

Base top method. Click **Base top method** in the Ref Level Setup screen to select a method used for calculating Top and Base of the waveform.

When the reference levels are set to Autoset, which is the default, the following steps are used during an autoset:

- Base and Top of the waveform are calculated
- High, Mid and Low reference voltages are determined as percentages of the (Top - Base) difference

There are four methods to calculate the Base and Top of the waveform:

- Min - Max
- Low - High Histogram (Full Waveform)
- Low - High Histogram (Center of Eye)
- Auto

Table 59: Autoset ref level configuration

Item	Description
Min-Max	Uses the minimum and maximum values in the waveform to determine the base and top amplitude. Useful on a waveform with low noise and free from excessive overshoot.
Low-High Histogram (Full Waveform) ¹	Uses a histogram approach to determine the base top amplitude. Creates a histogram of the amplitudes of the entire waveform; the histogram should have a peak at the nominal high level, and another peak at the nominal low level.
Low-High Histogram (Center of Eye)	Uses a histogram approach to determine the base top amplitude. Creates a histogram of the amplitudes in the center of each bit (unit interval) while ignoring the waveform during bit transitions. The histogram should have a peak at the nominal high level and another peak at the nominal low level.
Auto	Automatically determines the best Base Top method to use.
OK	Accepts the changes and closes the window.

Min - Max. The figure shows a typical data waveform with a vertical histogram turned on. If base-top method Min-Max is selected, the voltages indicated by the red lines is used for the base and top since these are the absolute min and max points in the entire waveform. If there isn't too much overshoot in a waveform this is a good base top method.

¹ The base and top are based on the base oscilloscope's High and Low measurements.

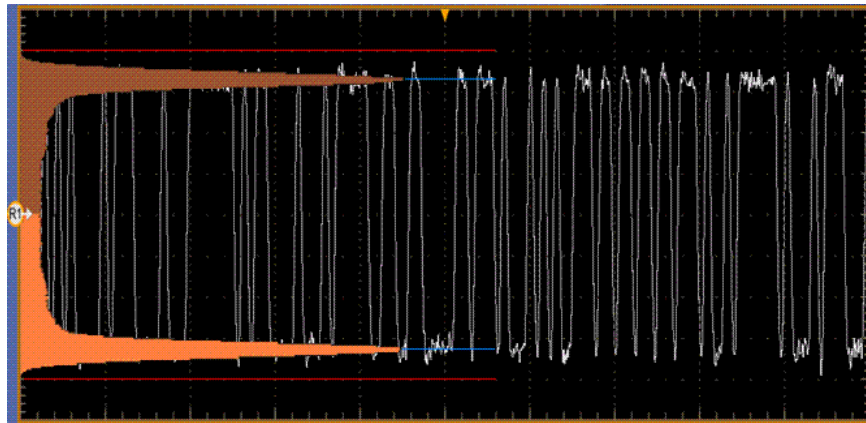

Low - High Histogram (Full Waveform). If base-top method Low - High Histogram (Full Waveform) is selected, the oscilloscope performs two histogram measurements: one on the top half of the waveform and another on the lower half of the waveform. The upper and lower blue lines in the figure show the modes of the upper and lower histogram, respectively. The mode of a histogram is the value that appears most frequently; visually, it is the peak of the histogram. It does a good job of picking out the high and low logic levels to which the waveform settles.

Low - High Histogram (Center of Eye). If base-top method Low - High Histogram (Center of Eye) is selected, the waveform is assumed to be a serial data signal and DPOJET performs clock recovery on the waveform. Then, the point at the center of each unit interval is taken. These samples are sorted into low bits and high bits. One histogram is formed on the low samples, and another on the high samples. The Base and Top are the modes of these histograms. This is similar to the Histogram Mode method Low - High Histogram (Full Waveform), except it is less influenced by the shape of the waveform during transitions between bits.

Auto. Base-top method Auto is the default. In Auto, method Low - High Histogram (Full Waveform) is tried first. But sometimes that method gives ambiguous results because there's no clear point to choose on the histogram. If that occurs, DPOJET switches to method Min-Max.

Preferences setup

About preferences setup. The application provides Preferences Setup, where you can set options that apply globally within DPOJET. These options remain unchanged until you reset them. Click **Analyze > Jitter and Eye Analysis (DPOJET) > Preferences** to view the Preferences screen. Optionally, click the preferences shortcut that is available in the select panel of DPOJET and its modules such as DDR, PCIE, and USB. To use the application more efficiently, you can set the options in the following tabs:

Preferences-General

Preferences-Jitter decomp

Preferences-Measurement

Preferences-Path defaults

Preferences-General. Click **Analyze > Jitter and Eye Analysis (DPOJET) > Preferences > General** to view the following:

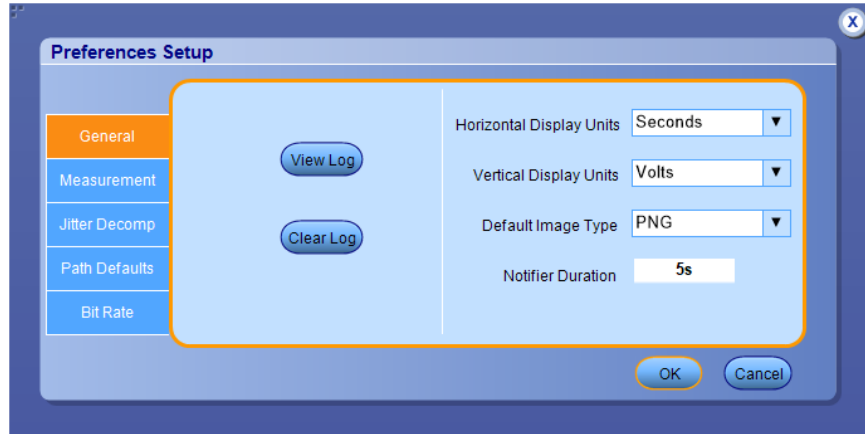

Table 60: Preferences-General options

Item	Description
View Log	Displays the error/warning log file in a Notepad window when the button is pushed.
Clear Log	Clears the error/warning log file when the button is pushed.
Horizontal Display Units	Select the horizontal display units for Time measurement results as Seconds (default) or Unit Intervals. Unit Intervals are calculated for time measurements which has Clock recovery only.
Vertical Display Units	Select the vertical display units for Noise measurement results as Volts (default) or Unit Amplitude.
Default Image Type	Selects the default image format (JPEG, PNG or BMP) that will be used by the functions that save images.
Notifier Duration	Determines how long the warning notifier will remain on the screen before disappearing. (The notifier may also be dismissed manually).
Cancel	Discards all changes and closes the Preferences window.
OK	Accepts all changes and closes Preferences window.

Related topics.

[Preferences-Measurement](#)

[Preferences-Path defaults](#)

[Preferences-Jitter Decomp](#)

Preferences-Measurement. Click **Analyze > Jitter and Eye Analysis (DPOJET) > Preferences > Measurement** to view the following:

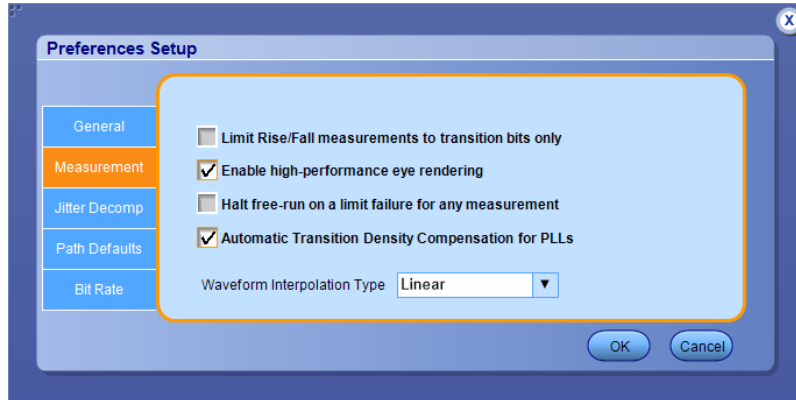

The Measurement tab allows you to limit Rise and Fall measurements to transition bits only, or allow these measurements for all bits. Here, the transition bits refer to edge transitions for which the preceding transition was only one unit interval away. This may be important for signals with pre-emphasis, since the transition following a string of two or more like bits has an intentionally low swing that you may not want to measure.

Use this tab to enable or disable high-performance eye rendering. This provides a trade-off between greater fidelity or greater rendering speed. You can also select the waveform interpolation type.

Table 61: Preferences-Measurement options

Item	Description
Limit Rise/Fall measurements to transition bits only	When selected, determines whether Rise Time and Fall Time measurements are performed on all bits or only on transition bits.

Item	Description
<p>Enable high-performance eye rendering</p>	<p>Determines whether eye diagrams are optimized for speed or fidelity. When disabled, all unit intervals (UI) in the waveform(s) are included in the rendered eye. This gives the highest fidelity eye rendering, but can take a considerable amount of time for long records. When this option is enabled, a statistically representative subset of the UI is rendered, so that eye diagrams for long waveforms can be displayed in a shorter time. The rules for high-performance rendering are as follows:</p> <ul style="list-style-type: none"> ■ If the waveform contains 15,000 or fewer UI, all the UIs in the waveform are rendered. ■ If the waveform includes more than 15,000 UI, it is subdivided into segments of 2000 UI each. The entire waveform is scanned to find the specific UI, that are the worst-case violators for six different points around the eye. For each of these worst case violators, the entire segment of 2000 UI in which it lies is rendered. Depending on whether multiple worst-case violators lie in the same segment or not, as few as 2000 UI but typically from 8000 to 12,000 UI will be rendered in the final eye. <p>UIs: Current number of UIs used to render eye diagram: Total number of UIs in the current acquisition Total: Total number of UIs used to render the eye diagram (when doing multiple acquisitions): Total number of UIs in the total population (when doing multiple acquisitions). If high performance rendering is off: $UIs\ X = UIs\ Y$ Population $X = Population\ Y$ If high performance rendering is on: $UIs\ X < UIs\ Y$ Population $X < Population\ Y$</p>
<p>Halt free-run on a limit failure for any measurement</p>	<p>If any of the selected measurement fails a limit test in free run, sequencing is stopped.</p>
<p>Automatic Transition Density Compensation for PLLs</p>	<ul style="list-style-type: none"> ■ When selected, the loop feedback time constants are adjusted to make the actual transfer function more closely match a mathematical filter polynomial. ■ When deselected, the clock recovery algorithm is configured for an assumed 50% transition density. By default, it is deselected.
<p>Waveform Interpolation Type</p>	<p>Select the type of interpolation that is used between sample points, to determine the exact time when a waveform crosses a reference voltage level. Linear interpolation is faster but introduces distortion that raises the jitter noise floor slightly. $Sin(x)/x$ Interpolation, also known as Sinc Interpolation, approaches theoretically perfect waveform reconstruction but is computationally expensive.</p> <hr/> <p>NOTE. For Eye-High, Eye-Low, and Eye-Height measurements, $Sin(x)/x$ interpolation is always used for eye measurements independent of the chosen interpolation type.</p>
<p>Cancel</p>	<p>Discards the changes and closes the window.</p>
<p>OK</p>	<p>Accepts the changes and closes the window.</p>

PLL-based clock recovery is implemented using a software model of a hardware PLL circuit, sequentially processing waveform transitions and adjusting the clock period in a feedback loop. This approach means that the transition density of the input signal has subtle effects on the effective bandwidth and damping factor of the feedback loop, just as it does with actual hardware PLLs. The influence of transition density is only relevant for data signals, since clock signals (or data signals with a two bit pattern) have 100% transition density.

Related topics.

[*Preferences-General*](#)

[*Preferences-Jitter Decomp*](#)

[*Preferences-Path defaults*](#)

Preferences-Jitter decomp. Click **Analyze > Jitter and Eye Analysis (DPOJET) > Preferences > Jitter Decomp** to view the following:

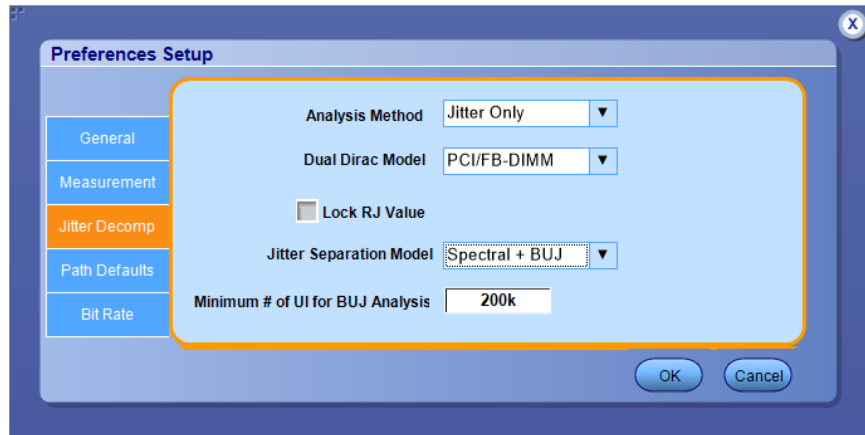

Figure 3: Analysis Method - Jitter Only

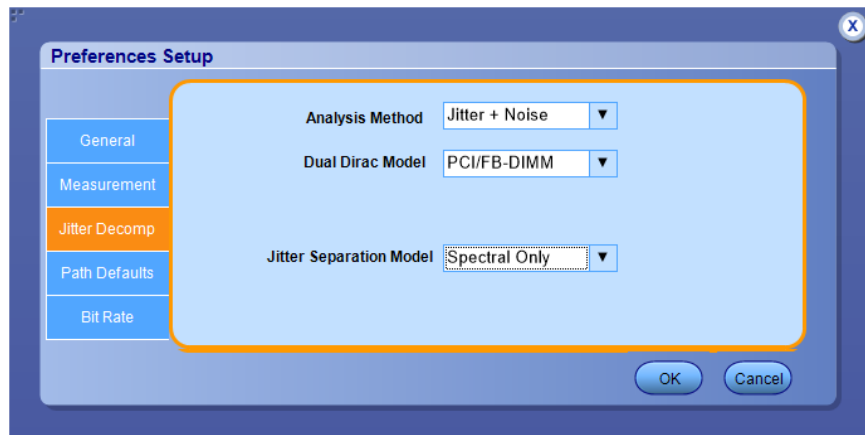

Figure 4: Analysis Method - Jitter + Noise

The Jitter Decomp tab allows you to select the Dual Dirac model and the Jitter Separation model, and to select the minimum number of unit intervals required for BUJ analysis.

Table 62: Preferences-Jitter Decomp options

Item	Description
Analysis Method	Select the analysis method as: <ul style="list-style-type: none"> ■ Jitter Only ■ Jitter + Noise

Item	Description
Dual Dirac Model	Determines which parameter-extraction method is used when RJ-DJ separation is done under the Dual-Dirac model. This affects results for the RJ- $\delta\delta$ and DJ- $\delta\delta$ measurements only. When Fibre Channel is selected, RJ and DJ parameters are extracted according to guidelines given in ANSI/INCITS Technical Report TR-35-2004 "Methodologies for Jitter and Signal Quality Specification". RJ and DJ values are selected that cause an exact match between the bathtub curves from the dual-dirac and the full analytical models at two prescribed BER levels. When PCI/FB-DIMM is selected, RJ and DJ parameters are determined using the methodology defined in the PCI Express Gen 2 and Fully-Buffered DIMM specifications. In this technique, the bathtub curves are plotted on a Q-scale that linearizes the tails of the bathtub, and the RJ and DJ values are derived from where the asymptotes to the curves intersect the BER=0 line.
Lock RJ Value	Selecting the Lock RJ Value calculates the measurements at the specified random jitter value. The checkbox is unchecked by default. Selecting the checkbox displays a text box where you can enter the RJ value. The default value is 1ps. Lock RJ Value cannot be configured when Jitter Separation Model is Spectral + BUJ. NOTE. This configuration is available only for Analysis Method - Jitter Only.
Jitter Separation Model	Selects the type of jitter separation, Spectral Only or Spectral + BUJ. Spectral Only identifies almost all categories of jitter, including Bounded Uncorrelated Jitter (BUJ) that is periodic (PJ). However, it cannot separate bounded random jitter from Gaussian random jitter. Spectral+BUJ includes additional processing to identify bounded random jitter (also called Non-Periodic Jitter or NPJ). NPJ is typically caused by crosstalk from a signal on a different clock domain, and generally requires a higher population of measurements for proper detection.
Minimum # of UI for BUJ Analysis	Determines the number of unit intervals (UI) that must be processed before jitter separation is performed. This item is only used for Spectral + BUJ processing, and is not shown if the Jitter Separation Model is Spectral Only. A higher number of UI will allow the separation algorithm to detect lower levels of NPJ, but will typically require longer record length, more acquisitions, or both. A lower number of UI will allow processing to occur on smaller populations of UI, but may only identify stronger forms of NPJ. Also, note that the number of UI processed for BUJ analysis is only 17% to 33% of the total UI acquired in each waveform.
Cancel	Discards the changes and closes the window.
OK	Accepts the changes and closes the window.

Related topics.

[Preferences-General](#)

[Preferences-Measurement](#)

[Preferences-Path defaults](#)

Preferences-Path defaults. Click **Analyze > Jitter and Eye Analysis (DPOJET) > Preferences > Path Defaults** to view the following:

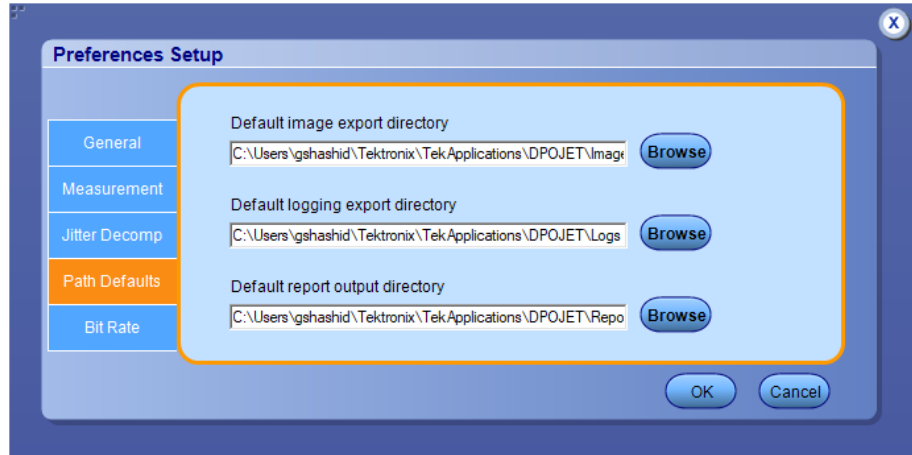

The Path Defaults allows you to set the path for images, reports and log files. Click **Browse** to modify the default directory path.

Table 63: Preferences-Path defaults options

Item	Description
Default image export directory	Selects the directory to which images will be saved, unless overridden at the time of the export.
Default logging export directory	Selects the directory to which logs will be saved, unless overridden at the time of the export.
Default report export directory	Selects the directory to which reports will be saved, unless overridden at the time of the export.
Cancel	Discards the changes and closes the window.
OK	Accepts the changes and closes the window.

Related topics.

[Preferences-General](#)

[Preferences-Measurement](#)

[Preferences-Jitter Decomp](#)

Export data and measurement

Export data snapshot-Statistics. You can save a snapshot of the current statistics in .csv format. The default location is C:\%USERPROFILE%\Tektronix\TekApplications\DPOJET\Logs\Statistics, where %USERPROFILE% represents your user location.

Click **Analyze > Jitter and Eye Analysis (DPOJET) > Export > Data Snapshot > Statistics** to view the following:

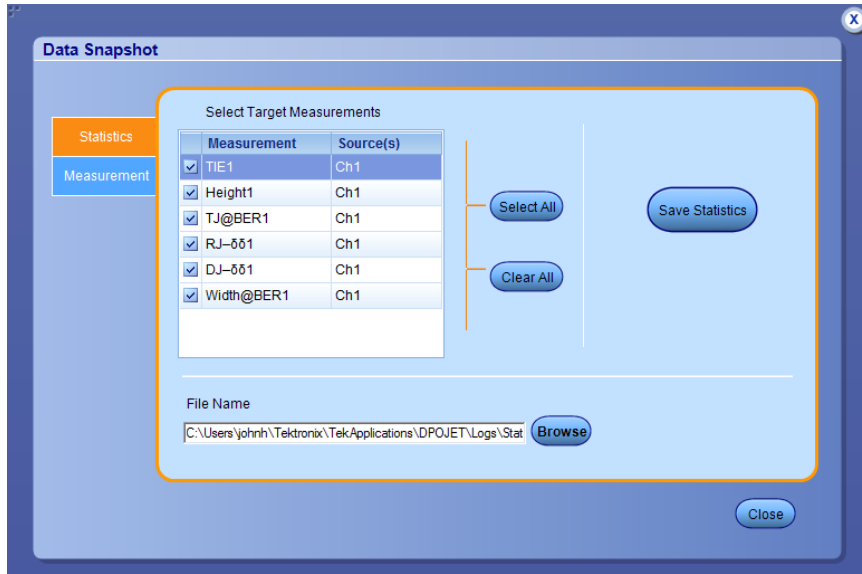

Table 64: Data snapshot- Statistics options

Item	Description
Select Target Measurements	Displays the measurement list. Click a row to select the measurement. By default, all measurements are selected.
Select All	Selects all the measurements in the list for saving statistics.
Clear All	Deselects all the measurements from the list.
Save Statistics	
Save	Saves the current statistics of selected target measurements to a log file.
File Name	
Browse	Allows you to choose the name and location where the .csv file will be saved. The default name is YYYYMMDD_HHMMSS_Stats.csv. The default directory is C:\%USERPROFILE%\Tektronix\TekApplications\DPOJET\Logs, where %USERPROFILE% represents your user location.
Close	Accepts the changes and closes the window.

NOTE. The default location for saving log files can be changed in the Preferences dialog box.

Related topics. [Export data snapshot-Measurement](#)

Export data snapshot-Measurement. You can save a snapshot of the data points in .csv format. The default location is C:\%USERPROFILE%\Tektronix\TekApplications\DPOJET\Logs\Measurements, where %USERPROFILE% represents your user location.

Click **Analyze > Jitter and Eye Analysis (DPOJET) > Export > Data Snapshot > Measurement** to view the following:

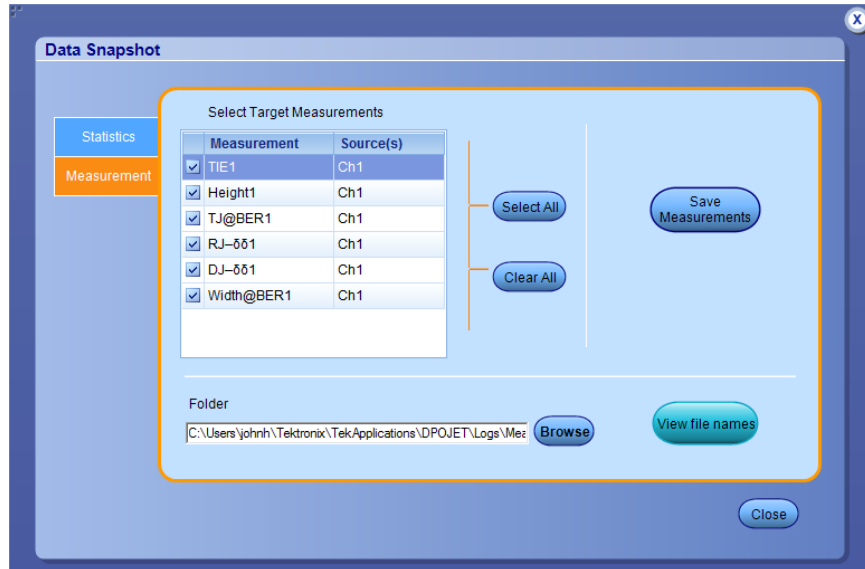
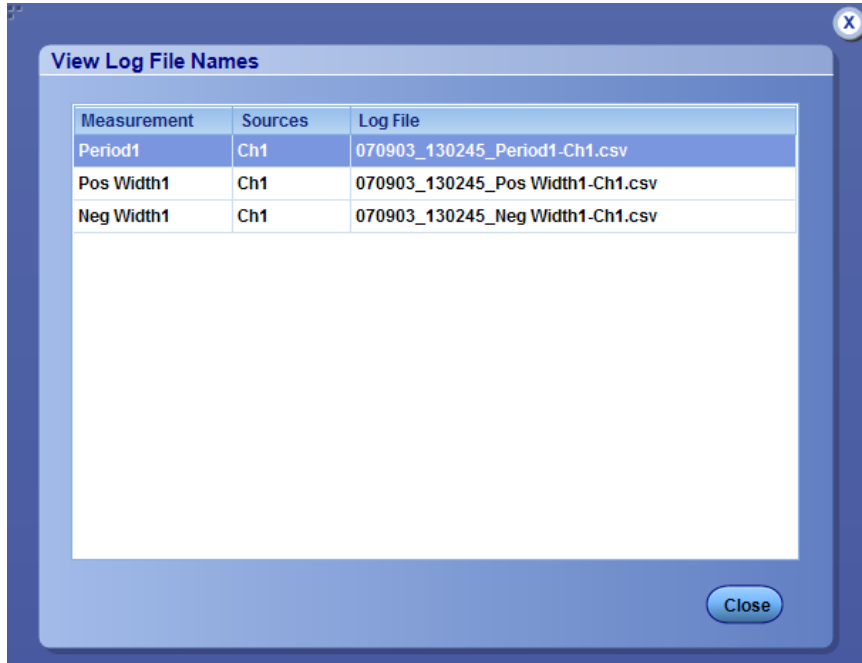

Table 65: Data snapshot- Measurement options

Item	Description
Select Target Measurements	Displays the measurement list. Click a row to select the measurement. By default, all measurements are selected.
Select All	Selects all the measurements in the list for saving statistics.
Clear All	Deselects all the measurements from the list.
Save Measurements	
Save	Saves the data points for current acquisition of selected target measurements in a log file.
Folder	
Browse	Allows you to choose the location where the .csv files will be saved. The default directory is C:\%USERPROFILE%\Tektronix\TekApplications\DPOJET\Logs\Measurements, where %USERPROFILE% represents your user location.
File Names	
View	Displays <i>View log file names</i> dialog box which lists the measurements and their source(s) with corresponding log file name in YYYYMMDD_HHMMSS_<Measurement Name>-<SourceName>.csv format.

Item	Description
Close	Accepts the changes and closes the window.

The View Log File Names dialog box lists the measurements and their source(s) with corresponding log file name in YYYYMMDD_HHMMSS_<Measurement Name>-<SourceName>.csv format. Click **Close** to close the dialog box. **View log file names**



Related topics.

[Export data snapshot](#)

Export measurement summary. Click **Analyze > Jitter and Eye Analysis (DPOJET) > Export > Measurement Summary** to save the generated report in C:\%USERPROFILE%\Tektronix\TekApplications\DPOJET\Reports, where %USERPROFILE% represents your user location. The exported measurement summary contains information only about application setup and configuration.

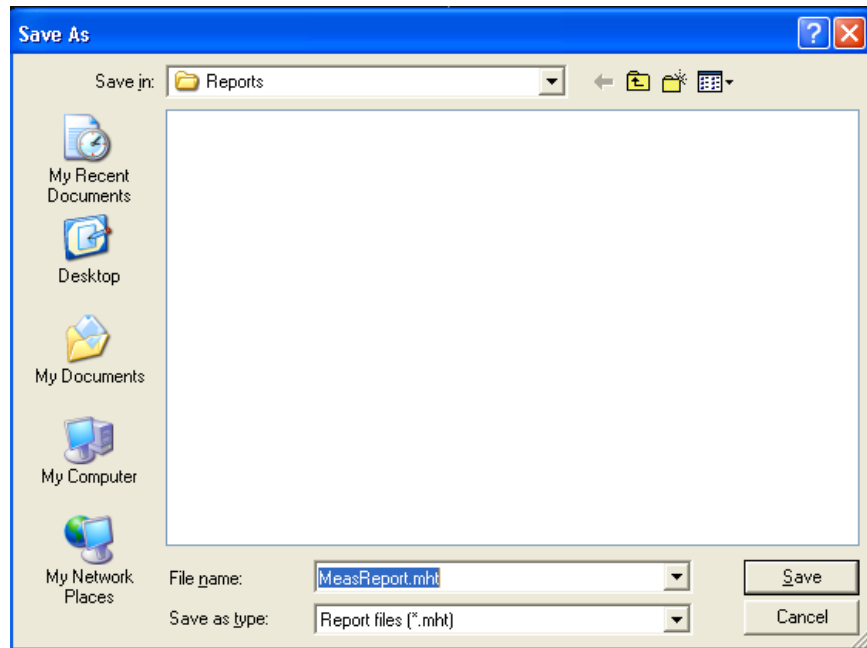

Data logging **Data logging-Statistics.** The application can continuously log (save to file) the calculated statistics. You can save the statistics to a “comma separated value” (.csv) file to import into a text editor, a spreadsheet, or an analysis tool.

By default, all measurements are selected. You can select individual measurements by selecting the row in the table on the left.

The steps for logging statistics are:

1. Click **Analyze > Jitter and Eye Analysis (DPOJET) > Data Logging > Statistics** to view the Logging Statistics screen.

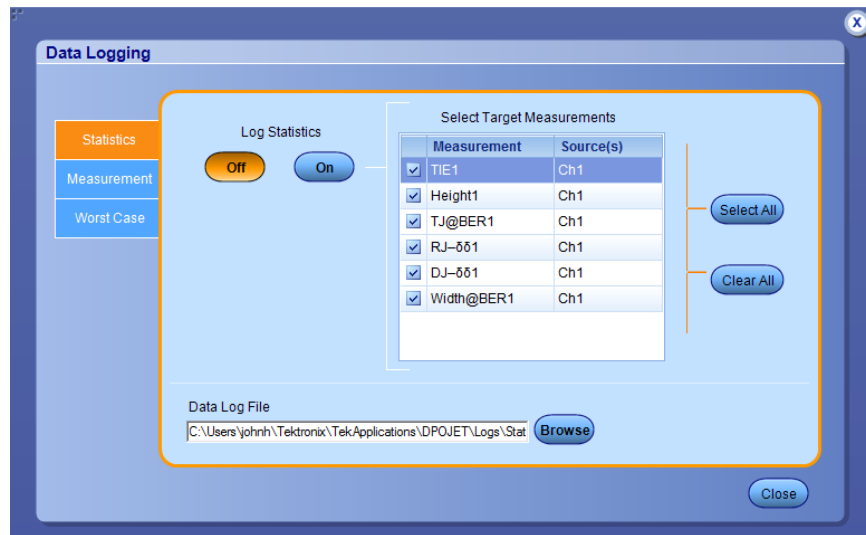

2. Select the measurements that you want to log in the **Select Target Measurements** table on the left. Click **Select All** to select all the measurements for logging or click **Clear All** to deselect the current measurements list.
3. Click **On/Off** to enable/disable automatic logging statistics for all selected measurements.
4. Click **Browse** to select a directory.

The default directory is C:\%USERPROFILE%\Tektronix\TekApplications\DPOJET\Logs\Statistics, where %USERPROFILE% represents your user location.

Table 66: Log-Statistics options

Item	Description
Select Target Measurements	Displays the measurement list. Select the check box to select the measurement. By default, all measurements are selected.
Select All	Selects all the measurements in the list.
Clear All	Deselects all the measurements in the list.

Item	Description
Off	Disables automatic logging for all selected measurements.
On	Enables automatic logging for all selected measurements.
Data Log File	
Browse	Allows you to choose the name and location where the .csv file will be saved. The default name is YYMMDD_HHMMSS_Stats.csv. The default directory is C:\%USERPROFILE%\Tektronix\TekApplications\DPOJET\Logs\Statistics, where %USERPROFILE% represents your user location.

NOTE. Microsoft Excel has a limitation where you cannot increase the number of rows (65,536) or columns (256) beyond the maximum row and column limits. Opening log files in or another analysis package is recommended. An error message “File not loaded completely” is displayed, if you try to open a log file with data exceeding the aforesaid row and column limits.

Related topics.

[Data logging-Measurement](#)

[Data logging-Worst case](#)

Data Logging-Measurement. You can log the actual individual measurement data values as measurement files.

1. Click **Analyze > Jitter and Eye Analysis (DPOJET) > Data Logging > Measurement** to view the Logging screen.

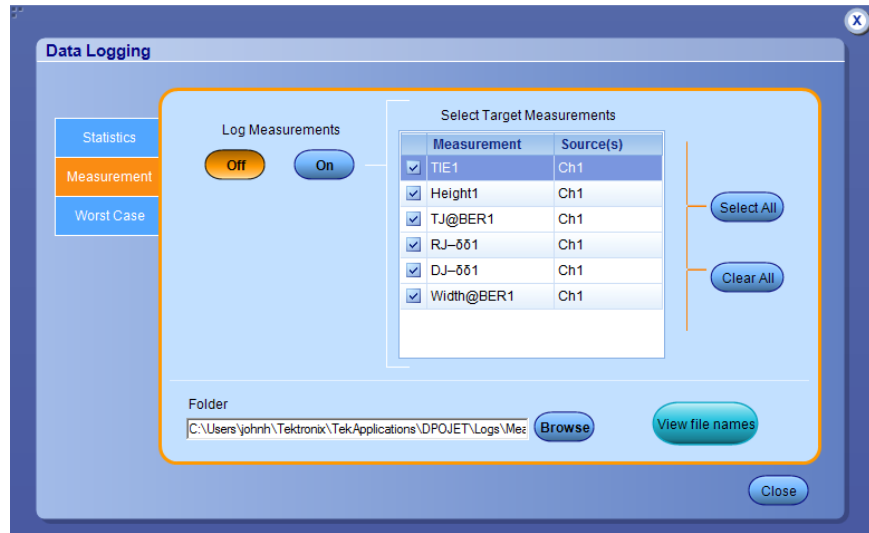

2. Select the measurements that you want to log in the **Select Target Measurements** table on the left. Click **Select All** to select all the measurements for logging or click **Clear All** to deselect the current measurements list.
3. Click **On/Off** to enable/disable logging for all selected measurements.
4. Click **Browse** to select a directory.

The default directory is C:\%USERPROFILE%\Tektronix\TekApplications\DPOJET\Logs\Measurements, where %USERPROFILE% represents your user location.

Table 67: Log-Measurements options

Item	Description
Select Target Measurements	Displays the measurement list. Select the check box to select the measurement. By default, all measurements are selected.
Select All	Selects all the measurements in the list.
Clear All	Deselects all the measurements from the list.
Log Measurements	
Off	Disables automatic logging for all selected measurements.
On	Enables automatic logging for all selected measurements.
Folder	

Item	Description
Browse	Allows you to choose the name and location where the .csv file will be saved. The default directory is C:\%USERPROFILE%\Tektronix\TekApplications\DPOJET\Logs\Measurements, where %USERPROFILE% represents your user location.
File Names	
View	Displays <i>View log file names</i> dialog box which lists the selected measurements with source(s) and their corresponding log file names in <MeasurementName>_<SourceName>_YYMMDD_HHMMSS.csv format.

View log file names. The View Log File Names dialog box lists the selected measurements with source(s) and their corresponding log file names in <MeasurementName>_<SourceName>_YYMMDD_HHMMSS.csv format. A tool tip is displayed as shown on hovering the mouse over the text. Click **Close** to close the dialog box.



The application displays a hint at the bottom of the screen under the following conditions:

- Qualifier turned on for measurements in **Global > Qualify** with searches specified.



- Any sources other than search types are specified. Example Math instead of Search1.

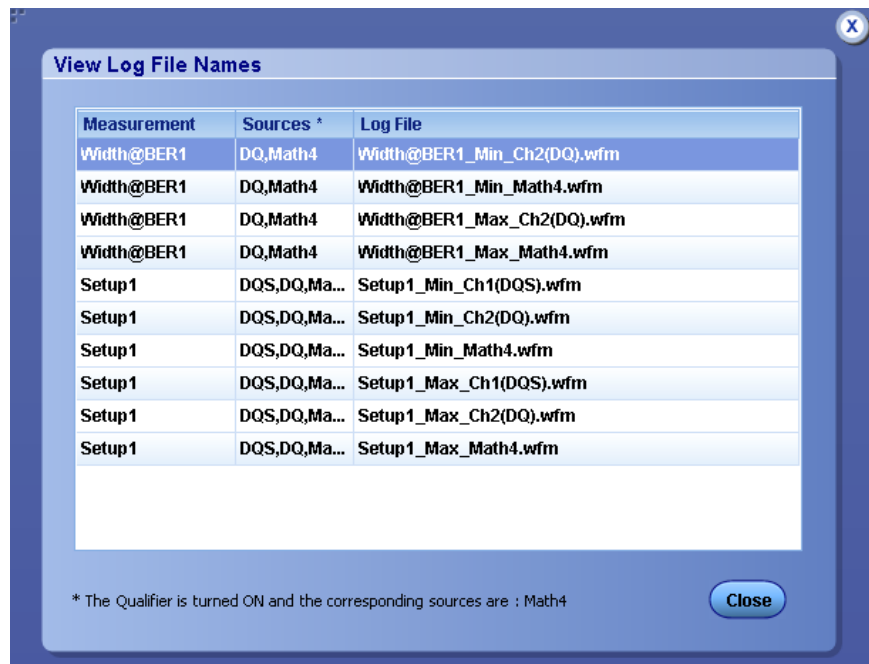

Related topics.

[Data logging-Statistics](#)

[Data logging-Worst case](#)

Data logging-Worst case.

1. Click **Analyze > Jitter and Eye Analysis (DPOJET) > Data Logging > Worst Case** to view the Worst Case Logging screen.

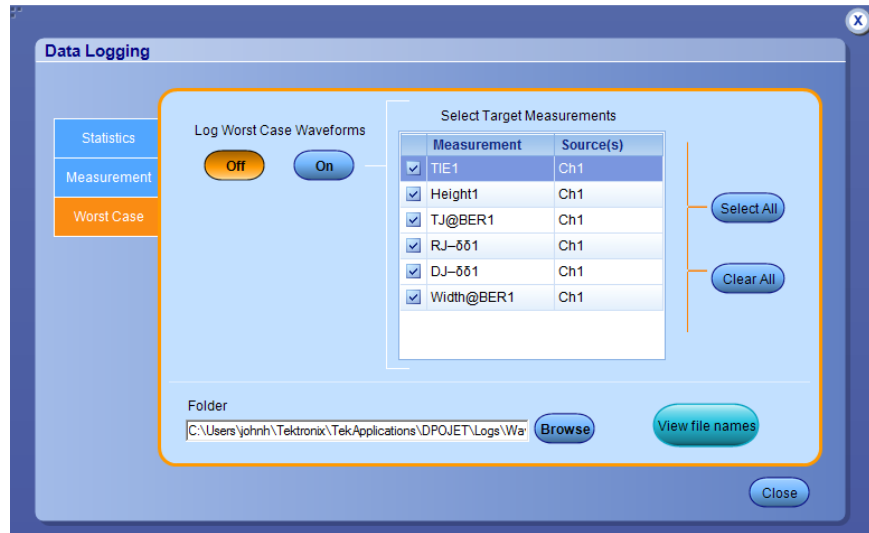

2. Select the measurements which you want to log in the **Select Target Measurements** table on the left. Click **Select All** to select all the measurements for logging or click **Clear All** to deselect the current measurements list.
3. Click **On/Off** to enable/disable worst case logging for all selected measurements.
4. Click **Browse** to select a directory.

The default directory is C:\%USERPROFILE%\Tektronix\TekApplications\DPOJET\Logs\Waveforms, where %USERPROFILE% represents your user location.

Table 68: Log-Worst case options

Item	Description
Select Target Measurements	Displays the measurement list. Select the check box to select the measurement. By default, all measurements are selected.
Select All	Selects all the measurements in the list.
Clear All	Deselects all the measurements in the list.
Off	Disables the application to save worst case waveforms for all selected measurements.
On	Enables the application to save worst case waveforms for all selected measurements.

Item	Description
Folder	
Browse	Allows you to choose the name and location where the .csv file will be saved. The default directory is C:\%USERPROFILE%\Tektronix\TekApplications\DPOJET\Logs\Waveforms, where %USERPROFILE% represents your user location.
File Names	
View	Displays View log file names dialog box which lists the selected measurements with source (labels) and their corresponding log file names in <MeasurementName>_Min_<Source(label)>.wfm and <MeasurementName>_Max_<Source(label)>.wfm ¹ format.

View log file names. The View Log File Names dialog box lists the selected measurements with source(s) and their corresponding log file names in <MeasurementName>_Min_<Source(label)>.wfm and <MeasurementName>_Max_<Source(label)>.wfm format. Click **Close** to close the dialog box.

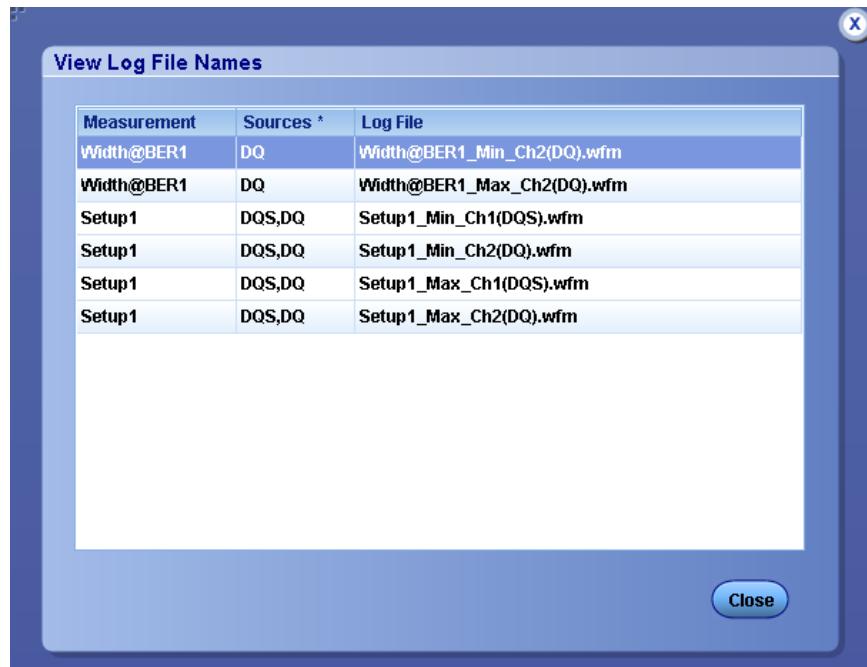

The application displays a hint at the bottom of the screen under the following conditions:

¹ For example, if the selected measurement is Skew1 with Ch1 and Ch2 as sources, then the file names will be Skew1_Min_Ch1(DQS).wfm, Skew1_Min_Ch2(DQ).wfm, Skew1_Max_Ch1(DQS).wfm, and Skew1_Max_Ch2(DQ).wfm.

- Qualifier turned on for measurements in **Global > Qualify** with searches specified.

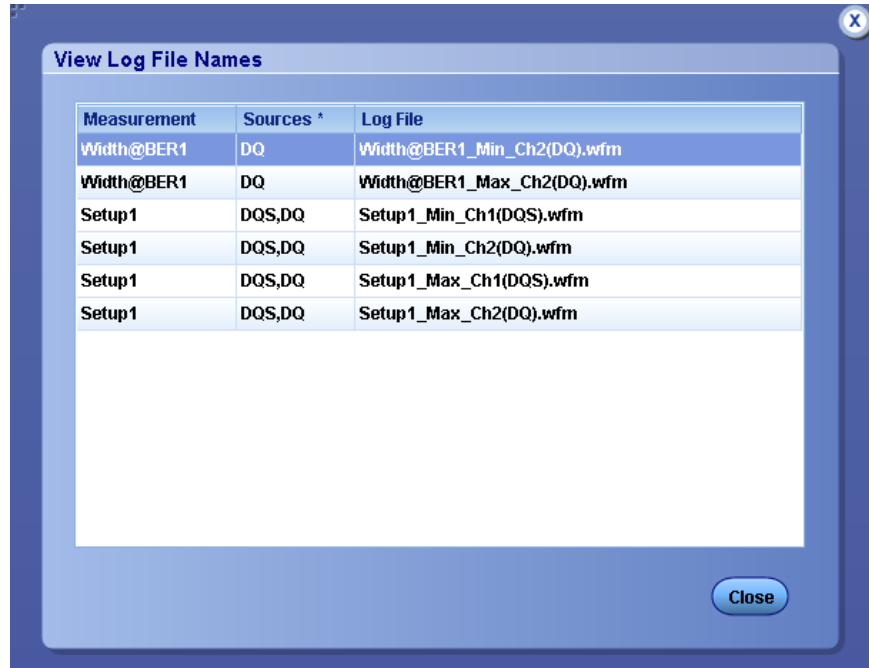

- Any sources other than search types are specified. Example Math instead of Search1.

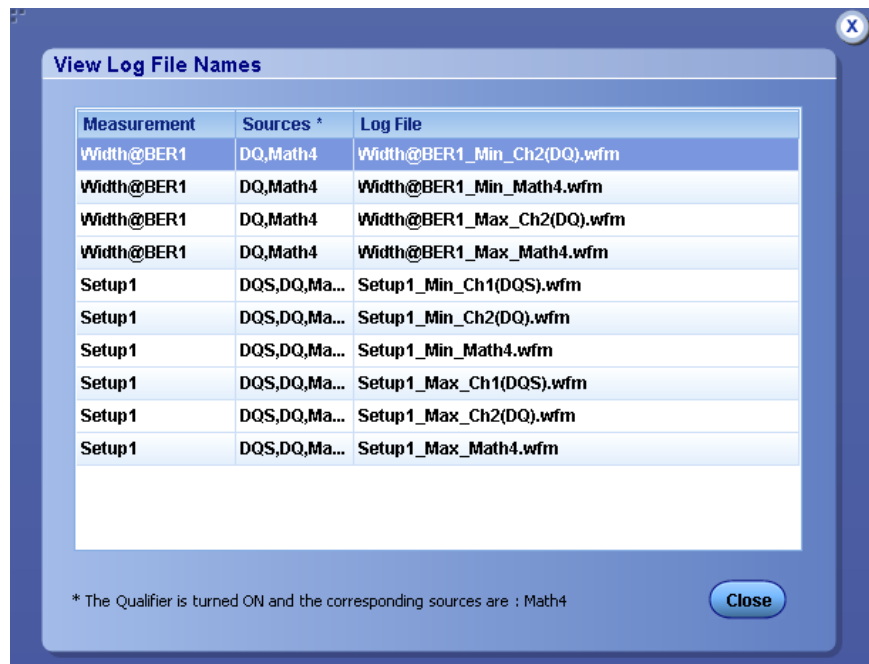

Logging worst case for mask hits measurement. The DPOJET application supports worst case logging for the Mask Hits measurement. Whenever Mask Hits is selected, there are two waveforms corresponding to maximum and minimum values for each of the segment as shown in the following figure:

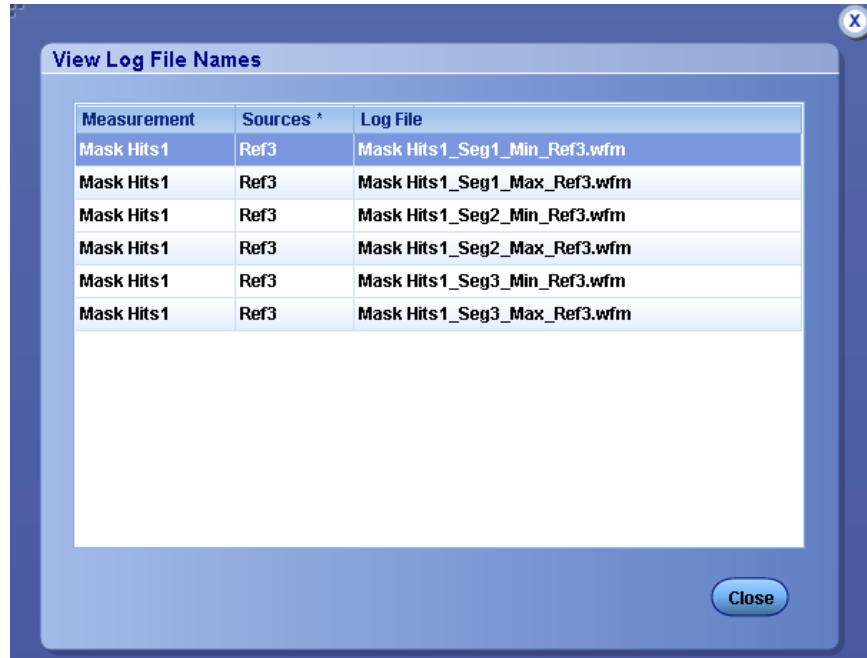

When an additional clock source (Clock Recovery > Explicit Clock Edge) is included for the Mask Hits measurement, there are two waveforms corresponding to maximum and minimum values for each of the source as shown:

Measurement	Sources ²	Log File
Mask Hits1	Ref2,Ref3	Mask Hits1_Seg1_Min_Ref2.wfm
Mask Hits1	Ref2,Ref3	Mask Hits1_Seg1_Min_Ref3.wfm
Mask Hits1	Ref2,Ref3	Mask Hits1_Seg1_Max_Ref2.wfm
Mask Hits1	Ref2,Ref3	Mask Hits1_Seg1_Max_Ref3.wfm
Mask Hits1	Ref2,Ref3	Mask Hits1_Seg2_Min_Ref2.wfm
Mask Hits1	Ref2,Ref3	Mask Hits1_Seg2_Min_Ref3.wfm
Mask Hits1	Ref2,Ref3	Mask Hits1_Seg2_Max_Ref2.wfm
Mask Hits1	Ref2,Ref3	Mask Hits1_Seg2_Max_Ref3.wfm
Mask Hits1	Ref2,Ref3	Mask Hits1_Seg3_Min_Ref2.wfm
Mask Hits1	Ref2,Ref3	Mask Hits1_Seg3_Min_Ref3.wfm
Mask Hits1	Ref2,Ref3	Mask Hits1_Seg3_Max_Ref2.wfm
Mask Hits1	Ref2,Ref3	Mask Hits1_Seg3_Max_Ref3.wfm

NOTE. All waveforms are displayed in the reports when worst case logging is enabled. Worst case waveform logging is now supported for all search types. For more details on the search types, refer to your oscilloscope online help.

Related topics.

[Data logging-Statistics](#)

[Data logging-Measurement](#)

Sequencing

Use the [Control panel](#) to start or stop the sequence of processes the application and oscilloscope use to acquire information from a waveform. The application then determines if the algorithm for the selected measurement can be applied to the waveform information. Sequencing is the steps to acquire waveform information, determine if the information is usable for the measurement, take the measurement, and display the results (and plots if selected).

When you click Recalc, Single or Run, the corresponding button is changed to Stop and the Progress indicator is displayed. For more details, refer to the [Control panel](#).

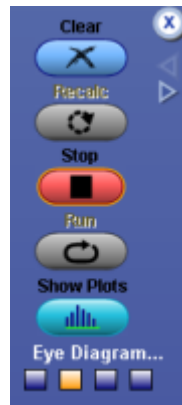

The Progress Indicator displays the sequencer state. Select Stop, if you want to interrupt the sequence before its completion.

For more details on progress bar status messages, refer to [Progress bar status messages](#).

Limits

A Limits file allows you to specify the Pass/Fail threshold for measurements. Each DPOJET-based serial data application typically provides limits files that include combinations of relevant measurements and statistical characteristics, and an appropriate range of values for each combination.

The DPOJET application provides an example limits file, called Example_Limits.xml, that is annotated to explain some of the methods of assigning limits. You can create additional limits files by copying the example and modifying it appropriately. You can specify limits for any of the result parameters such as Mean, Std Dev, Max, Min, peak-to-peak, population, MaxPosDelta or MinPosDelta. For each of these result parameters, you can specify Upper Limit (UL), Lower Limit (LL), or Both. The measurement names in the limits file must be entered as mentioned in

[Setting up the application for analysis](#).

To include Pass/Fail status in the result statistics, you can create a limits file using an XML editor or any other editor in the following format. If the file is created in any other editor such as notepad, it should be saved in Unicode format.

```
<?xml version="1.0" encoding="utf-16" ?>
<Main>
<Measurement>
<NAME>Period</NAME>
<STATS>
<STATS_NAME>Mean</STATS_NAME>
<LIMIT>UL</LIMIT>
```

```
<UL>1</UL>
<LL>0</LL>
<STATS>
<STATS_NAME>StdDev</STATS_NAME>
<LIMIT>LL</LIMIT>
<UL>1121</UL>
<LL>0121</LL>
</STATS>
<STATS>
<STATS_NAME>Max</STATS_NAME>
<LIMIT>BOTH</LIMIT>
<UL>1</UL>
<LL>0</LL>
</STATS>
<STATS>
<STATS_NAME>Min</STATS_NAME>
<LIMIT>UL</LIMIT>
<UL>0</UL>
<LL>1</LL>
</STATS>
<STATS>
<STATS_NAME>PeakToPeak</STATS_NAME>
<LIMIT>UL</LIMIT>
<UL>1</UL>
<LL>1</LL>
</STATS>
<STATS>
<STATS_NAME>MaxPosDelta</STATS_NAME>
<LIMIT>UL</LIMIT>
<UL>1121</UL>
<LL>1121</LL>
</STATS>
<STATS>
```



```

<STATS_NAME>MinNegDelta</STATS_NAME>
<LIMIT>UL</LIMIT>
<UL>0</UL>
<LL>0</LL>
</STATS>
<STATS>
<STATS_NAME>Population</STATS_NAME>
<LIMIT>UL</LIMIT>
<UL>0</UL>
<LL>0</LL>
</STATS>
</Measurement>
</Main>

```

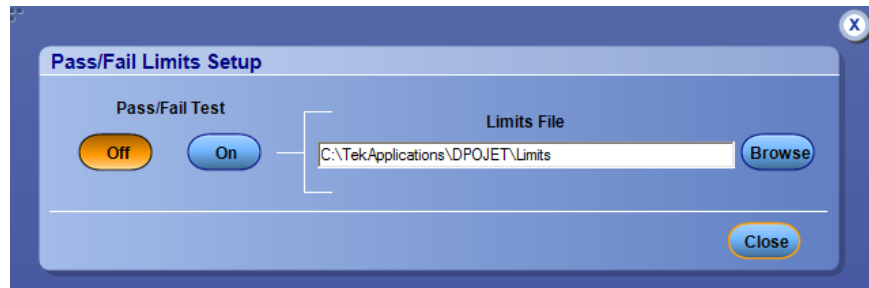
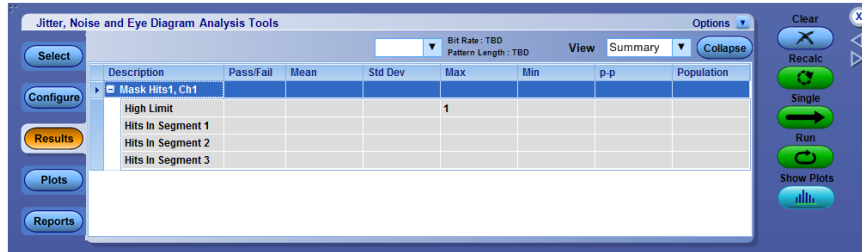

Table 69: Limits options

Item	Description
Pass/Fail Test	
Off/On	Enables (On) or Disables (Off) the display of limit information in results. Select On to choose a limits file for the selected measurement.
Limits File	
Browse	To select an existing limits file or locate the directory.
Close	Accepts the changes and closes the window.

Limits for mask hits. Limits are available for Mask Hits. The applications displays the following in the results panel when limits are turned on (Analyze > Jitter and Eye Analysis (DPOJET) > Limits):



If there is a hit in any of the segments, the result is FAIL as shown:

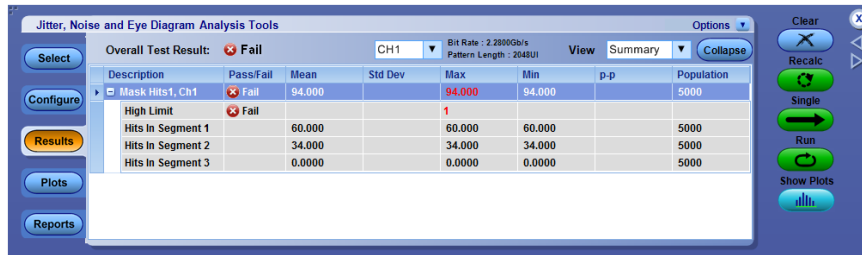

Measurement summary

Measurement configuration summary-Measurement. Click **Analyze > Jitter and Eye Analysis (DPOJET) > Measurement Configuration Summary > Measurement** to view measurement, source and the configuration parameters of each measurement.

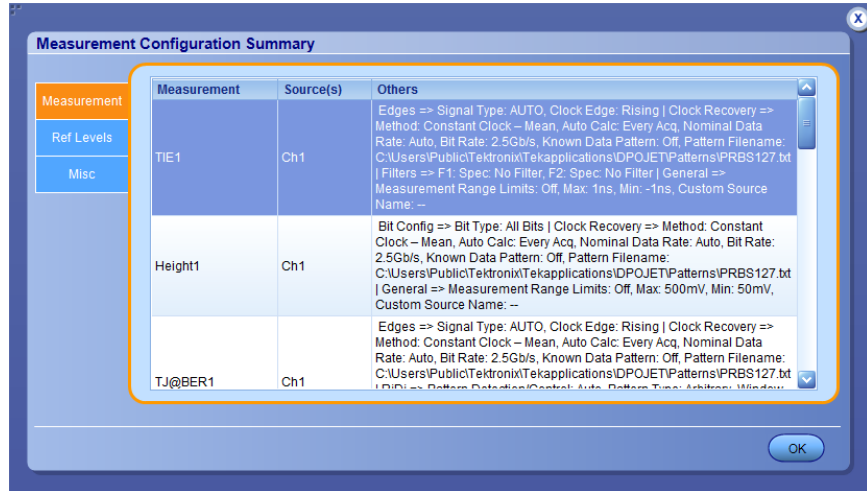

Table 70: Measurement configuration information

Item	Description
Measurement	Displays the measurement name.
Source	Displays the selected source.
Others	Displays the other configuration information related to the selected measurement.
OK	Closes the window.

Related topics.

[Measurement summary-Ref levels](#)

[Measurement summary-Misc](#)

Measurement summary-Ref levels. Click **Analyze > Jitter and Eye Analysis (DPOJET) > Measurement Configuration Summary > Ref Levels** to view the ref level tab. This tab provides information about ref level configuration per source. Displays the reference voltage levels for the high, mid, and low thresholds for the rising edge and for the falling edge of each active source, and the hysteresis.

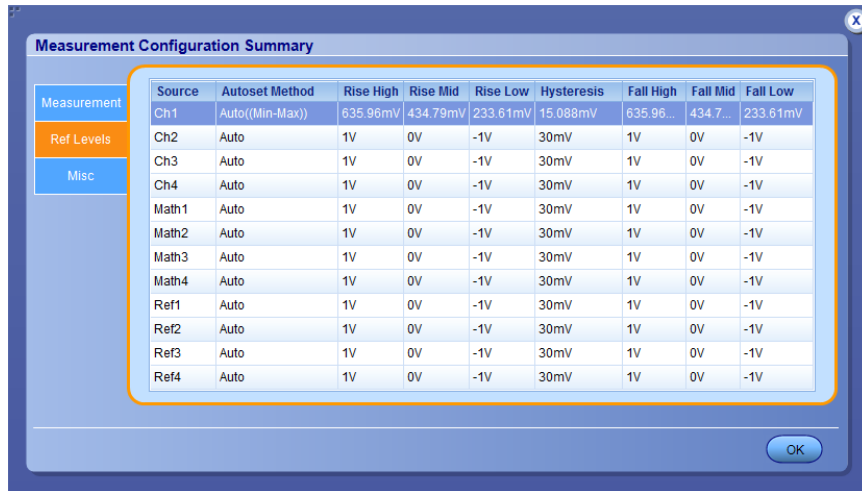

Table 71: Ref level configuration information

Item	Description
Source	Displays the selected source.
Rise High	Displays the high threshold level for the rising edge of the source.
Rise Mid	Displays the middle threshold level for the rising edge of the source.
Rise Low	Displays the low threshold level for the rising edge of the source.
Hysteresis	Displays the threshold margin to the reference level which the voltage must cross to be recognized as changing; the margin is the relative reference level plus or minus the hysteresis; use to filter out spurious events.
Fall High	Displays the high threshold level for the falling edge of the source.
Fall Mid	Displays the middle threshold level for the falling edge of the source.
Fall Low	Displays the low threshold level for the falling edge of the source.
OK	Closes the window.

Related topics.

[Measurement configuration summary-Measurement](#)

[Measurement summary-Misc](#)

Measurement Summary-Misc. Click **Analyze > Jitter and Eye Analysis (DPOJET) > Measurement Configuration Summary > Misc** tab to view various configuration parameters. The Miscellaneous tab shows whether the Gating, Qualify, and Stat Pop Limit functions are enabled; if enabled, it also shows the source for qualification, the size for population, and various other configuration choices.

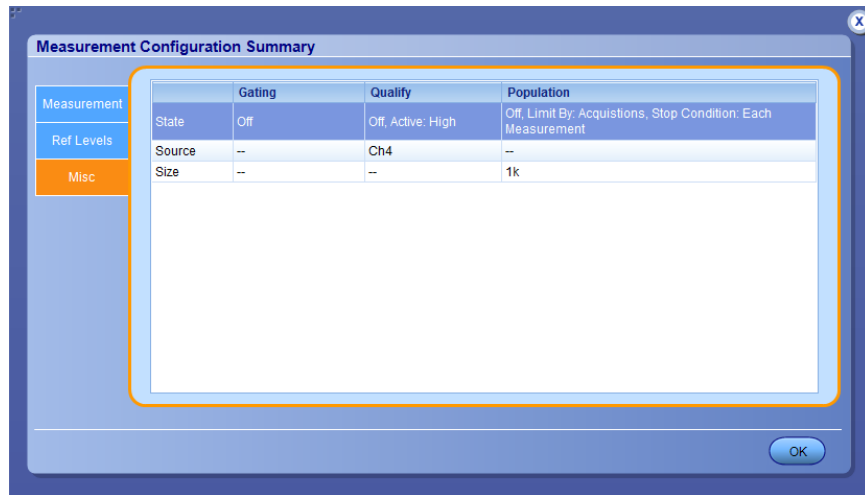

Table 72: Miscellaneous configuration information

Item	Description
State	Displays On when Gating, Qualify and Population are enabled and Off when they are disabled.
Source	Displays the selected source for qualify.
Size	Specifies the maximum population that can be obtained for each active measurement.
OK	Closes the window.

Related topics.

[Measurement configuration summary-Measurement](#)

[Measurement summary-Ref levels](#)

Results as statistics



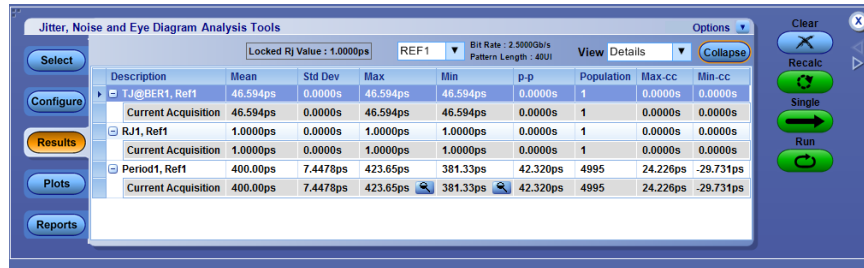

Viewing statistical results

The application displays results for the measurements for all acquisitions or for the current acquisition. By default in the detail view, the limits will not be shown unless the limits are turned on.





Result statistics for most of the measurements show Population in terms of UI or transitions. According to the JEDEC specification, the analysis for most of the clock measurements is done for a 200-cycle moving window. However, for clock measurements such as DDRtCL(avg) and DDRtCH(avg), the population is shown as tCK(avg) units. For Data Eye Width, the population number is shown as per acquisition.

Table 73: Results menu options

Item	Description
	Displays an error message. You can click  to view the error log information in a text editor.
	Displays a warning. You can click  to view the error log information in a text editor.
Description	Lists the measurement name and the source.
Mean	Lists a statistical mean value for the measurement data.
Std Dev	Lists a statistical standard deviation value for the measurement data.
Max	Lists a statistical maximum value for the measurement data. Shows Pass if the statistics is within the specified Upper Limit Equality (ULE).
Min	Lists a statistical minimum value for the measurement data. Shows Fail if the statistics has crossed the specified Lower Limit Equality (LLE).
p-p	Lists a statistical peak-to-peak value for the measurement data.
Population ¹	Lists the total number of measurement data points used for displaying the statistics.
Max-cc	Lists the maximum cycle-to-cycle differences per acquisition.

¹ Jitter measurements such as RJ, DJ show population in terms of acquisitions.

Item	Description
Min-cc	Lists the minimum cycle-to-cycle differences per acquisition.
 Options	Click to view Save Current Stats, Export to Ref Waveform, and Display Units-Absolute options.
Save Current Stats...	Saves the current statistics as log information.
Export to Ref Waveform	Exports time trend data of the selected measurement to the reference memory.
Display Units- Absolute	Default display unit is Absolute.
	Click to view the result details.

NOTE. For Mask Hits measurement, only Mean, Max, Min and Population values are displayed in the results table. On clicking, Hits in Segment 1, Segment 2 and Segment 3 are displayed. For Mask Hits measurements, mean indicates the total number of hits for all acquisitions.

The results tab with limits turned on is as shown. You can click the zoom icon, available for Max and Min values irrespective of the limits being turned on/off in the current acquisition. A tool tip displays the message “Click to view the event on the waveform” and appends the result statistics in full resolution (without any truncation) on hovering the mouse.

NOTE. The zoom feature is available only for vector measurements.

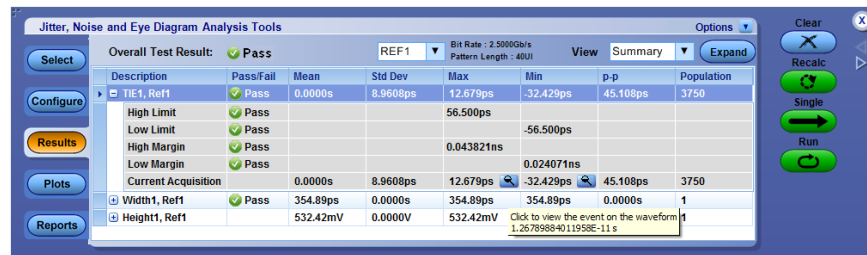

Results with Error/Warning Notification. The results tab with error  icon is as shown. Click **View Log** to view the error log information in a text editor.

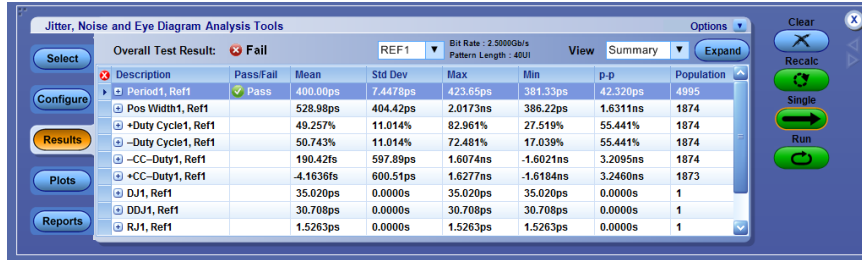

The screenshot shows the 'Results' tab of the 'Jitter, Noise and Eye Diagram Analysis Tools' application. The overall test result is 'Fail', indicated by a red 'X' icon. The table below shows the test results for various parameters.

Description	Pass/Fail	Mean	Std Dev	Max	Min	p-p	Population
Period1, Ref1	Pass	400.00ps	7.4478ps	423.65ps	381.33ps	42.320ps	4995
Pos Width1, Ref1		528.98ps	404.42ps	2.0173ns	386.22ps	1.6311ns	1874
+Duty Cycle1, Ref1		49.257%	11.014%	82.961%	27.519%	55.441%	1874
-Duty Cycle1, Ref1		50.743%	11.014%	72.481%	17.039%	55.441%	1874
-CC-Duty1, Ref1		190.42fs	597.89ps	1.6074ns	-1.6021ns	3.2095ns	1874
+CC-Duty1, Ref1		-4.1636fs	600.51ps	1.6277ns	-1.6184ns	3.2460ns	1873
DJ1, Ref1		35.020ps	0.0000s	35.020ps	35.020ps	0.0000s	1
DDJ1, Ref1		30.708ps	0.0000s	30.708ps	30.708ps	0.0000s	1
RJ1, Ref1		1.5263ps	0.0000s	1.5263ps	1.5263ps	0.0000s	1

The results tab with warning  icon is as shown. You can click **View Log** to view the error log information in a text editor.

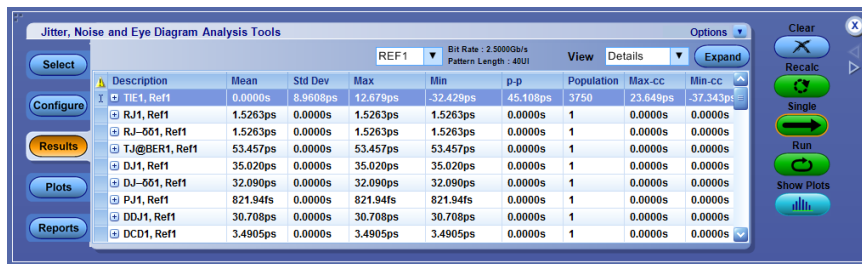

The screenshot shows the 'Results' tab of the 'Jitter, Noise and Eye Diagram Analysis Tools' application. The overall test result is 'Warning', indicated by a yellow triangle icon. The table below shows the test results for various parameters.

Description	Mean	Std Dev	Max	Min	p-p	Population	Max-cc	Min-cc
TIE1, Ref1	0.0000s	8.9608ps	12.679ps	-32.429ps	45.108ps	3750	23.649ps	-37.343ps
RJ1, Ref1	1.5263ps	0.0000s	1.5263ps	1.5263ps	0.0000s	1	0.0000s	0.0000s
RJ-561, Ref1	1.5263ps	0.0000s	1.5263ps	1.5263ps	0.0000s	1	0.0000s	0.0000s
TJ@BER1, Ref1	53.457ps	0.0000s	53.457ps	53.457ps	0.0000s	1	0.0000s	0.0000s
DJ1, Ref1	35.020ps	0.0000s	35.020ps	35.020ps	0.0000s	1	0.0000s	0.0000s
DJ-561, Ref1	32.090ps	0.0000s	32.090ps	32.090ps	0.0000s	1	0.0000s	0.0000s
PJ1, Ref1	821.94fs	0.0000s	821.94fs	821.94fs	0.0000s	1	0.0000s	0.0000s
DDJ1, Ref1	30.708ps	0.0000s	30.708ps	30.708ps	0.0000s	1	0.0000s	0.0000s
DCD1, Ref1	3.4905ps	0.0000s	3.4905ps	3.4905ps	0.0000s	1	0.0000s	0.0000s

Overall Test Result. There are two ways to view the statistical results of measurements:

- Summary
- Details

NOTE. Alternatively, you can toggle between Summary and Details using the Expand/Collapse button.

On clicking Single/Run, the Overall Test Result shows Pass/Fail icons depending on the result of the measurement(s).

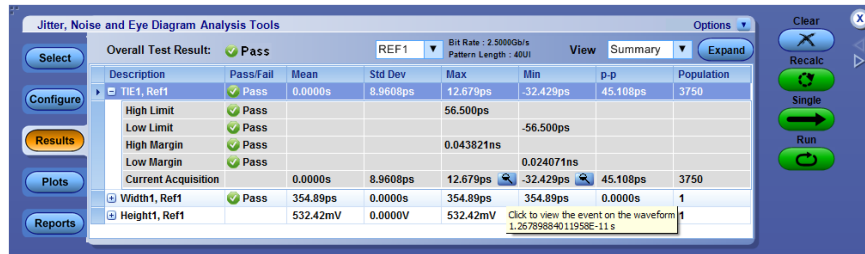

For example, the Overall test result is fail if any measurement has limit failure. The result statistic which has failed is highlighted in red as shown:

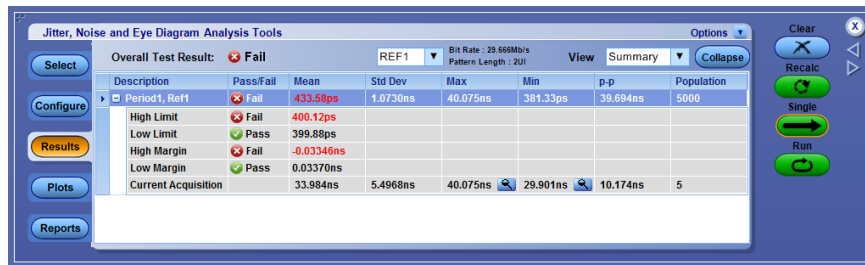

NOTE. When limits are turned off, Summary and Overall Test Result options are not available.

Summary

Displays the summary of the results for all acquisitions. Pass/Fail information is included whereas Max-cc and Min-cc information is excluded. Click the Expand button for the summary view as shown:

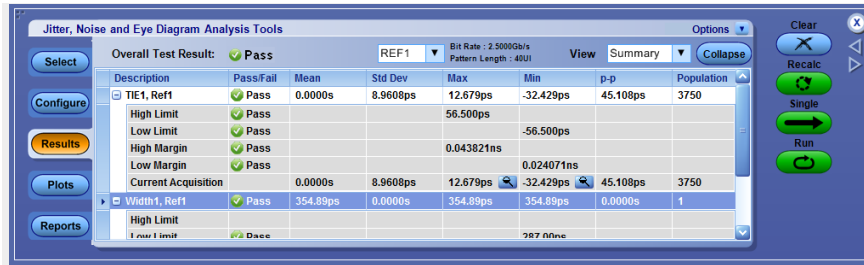

Details

Displays the detailed results specifying values for High Limit, Low Limit, High Margin, Low Margin, Pass/Fail, and current acquisition. Click the Expand button for the details view as shown:

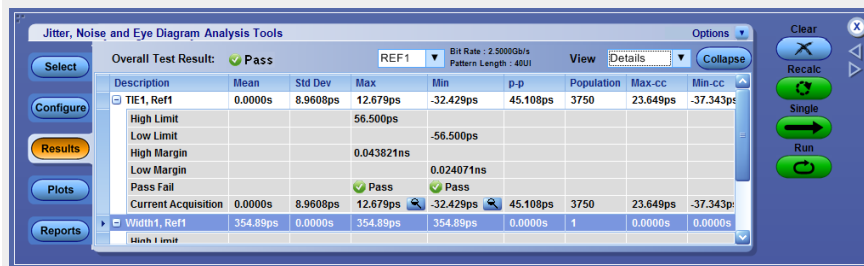

Export results to ref waveform

Using this option, you can export the time trend plot of a measurement to any of the available reference memory, Ref1-Ref4. Click  on the right corner of the results panel to select the “Export Results to Ref” option.

The Export Results to Ref waveform dialog box appears. It lists all the possible measurements that have time trend result data (that is measurements for which time trend plot is enabled in the plot panel).

From the list of measurements, results of any **one** measurement can be exported to any **one** of the reference memory (Ref1-Ref4) which is not used as the source of any measurement.



Before exporting results to a reference memory, the application checks for the following:

- If any of the ref waveforms are already used as source for one of the measurement(s), then you cannot export the results on those ref destinations. The application prevents exporting by displaying an error message [2003](#).
- If all the reference waveforms (Ref1-Ref4) are already used as sources for various measurements, the “Export Results to Ref Waveform” is not displayed. Instead, an error message [2002](#) is displayed.
- If a ref destination is assigned to a measurement from the list which is not empty (that is, if the ref is already defined and holds any other recalled waveform), a warning prompts you from overwriting the existing definition of the selected destination ref.
- In case of any error ([2002](#) or [2004](#)) or warning (Overwriting the existing definition) and you select the response as “No”, the destination ref reverts to its previous value. For example, if the selected measurement is Period-Ref1, and the destination ref assigned to the measurement is Ref3, and if you try to change the destination from Ref3 to Ref1, an error message [2003](#) is displayed. Ref3 is retained as the destination ref.
- Time trend result export to the reference waveform for a measurement is independent of time trend plot. Time trend result can be exported to ref without selecting/defining plots in the plots panel.
- If “Export Results to Ref” is selected without any measurement selection, an error message [2005](#) is displayed.
- If none of the selected measurements have time trend data, an error message [2007](#) is displayed and “Export Results to Ref” dialog is not displayed.

- If the selected measurements have no results (results are cleared or measurements are not run to produce results), an error message 2006 is displayed and “Export Results to Ref” dialog box is not displayed.
- If the destination is none for all measurements, the results are not exported to ref on clicking **OK**. An information/warning 2008 is displayed.

Bit rate and pattern length detection

Beginning with version 6.1.0, DPOJET performs automatic detection of bit rate and pattern length whenever a new processing cycle occurs (for example, after a configuration change or a “Clear” operation). The detected values are displayed at the top of the results panel, to allow quick verification of overall test setup and device configuration.

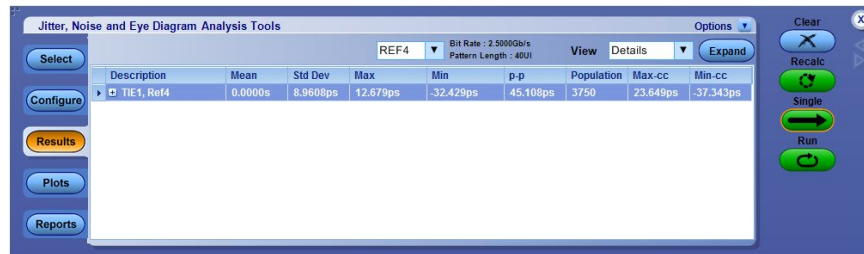

- If there are simultaneous measurements on several different sources, the results for the source associated with the first measurement will be shown initially. The drop-down selector can be used to see the bit rate and pattern length for other sources.
- The reported bit rate can be influenced by the clock recovery settings, and in particular by the Nominal Data Rate (if present) in the Advanced panel of the clock recovery configuration tab.
- If no repeating pattern is detected, or if jitter measurements are explicitly configured to use arbitrary-pattern analysis, the second line will say Pattern: Arbitrary.
- By default, the detected pattern length also automatically configures any jitter measurements that require pattern length as a configuration parameter. These parameters appear on the RJ-DJ tab of the jitter measurements. If a jitter measurement is configured to use a specific pattern length (instead of using the detected length), the user-specified length will be shown at the top of the results panel and will be used by the measurement even if it does not appear to match the actual signal. To manually configure the pattern length, select the configure tab and then the measurement. Select the RJ-DJ tab and select the Manual button.

Related topics.

[About RJ-DJ](#)

[Clock recovery advanced setup](#)

Result as plots

About plots

The application can display the results as two-dimensional plots for easier analysis. Before or after you take measurements, you can set up the Select Plots and Plots Configure menus to define up to four plots. The last plot selected is displayed when the application completes [Sequencing](#).

NOTE. Plots are not available for DDR tJIT(duty), DDR tJIT(per), DDR tERR(n), DDR tERR(m-n), PCIe Tmin-Pulse, PCIe Med-Mx Jitter, PCIe Tmin-Pulse-Tj, PCIe Tmin-Pulse-Dj, USB UI,DDR VID(ac), USB SSC FREQ DEV MAX and USB SSC FREQ DEV MIN, ps21TXand T-TX-DDJ measurements.

If you set up plots after sequencing, the application displays the plot based on the current measurement and result.

NOTE. When taking measurements in the Run mode, you must stop the sequencing before you can use some plot features.

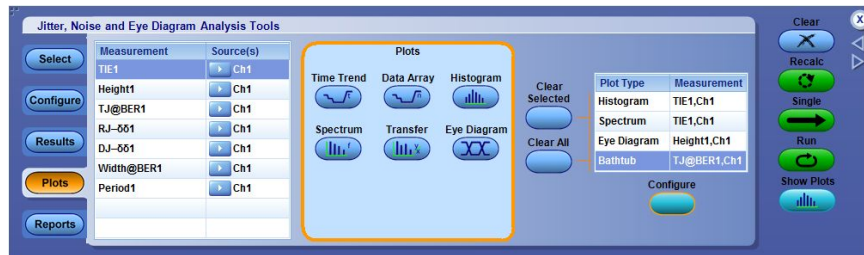

Table 74: Plot type definitions

Item	Description
Time Trend	Represents the measurement values versus the time location.
Data Array	Represents the measurement values versus the index number of the measurement array.
Histogram ¹	Represents measurements sorted by value as a distribution of measurement values versus the number of times the value occurred.
Spectrum	Represents the frequency content computed using the FFT of the Time Trend of the measurement data.
Transfer	Represents the magnitude ratio of spectrum of time trend data of two measurements from the following set: Clock Period, Clock Frequency, Clock TIE, Clock PLL TIE, Data Period, Data Frequency, Data TIE, Data PLL TIE.

¹ Available for all measurements except Mask Hits, DDR tJIT(duty), DDR tJIT(per), DDR tERR(n), DDR tERR(m-n), PCIe Tmin-Pulse, PCIe UI, and PCIe Med-Mx Jitter.

Item	Description
Phase Noise ²	Represents the phase noise of a clock signal and is plotted in the frequency domain for only Clock TIE measurements.
Eye Diagram ³	Represents data for the eye diagram based on the recovered clock as the timing reference; used for mask testing.
Waveform ⁴	Represents the acquired waveform. It is available for use with eye diagram mask tests to locate bit errors in the real-time waveform.
Bathtub ⁵	Represents the Bit Error Rate versus the unit interval for measurements that include RJ-DJ analysis.
Q-Bathtub ⁶	Represents Q-Scale value versus the Unit interval for the PCIe 3 Uncorrelated Jitter Measurements.
Q-PulseWidth ⁷	Represents Q-Scale value versus Time for the PCIe 3 Uncorrelated Pulse Width Jitter Measurements.
Composite Jitter Hist	Plots four Histograms (TJ, RJ+BUJ, PJ, DDJDCD) together.
Noise Bathtub ⁸	This plot shows the extrapolated curves due to noise like the way Bathtub plot shows the extrapolated curve due to jitter.
BER Eye Contour ^{9 10}	This plot shows the Bit Error Rate contours at standard BER Levels like 1e-6, 1e-9, 1e-12, 1e-15, 1e-18 and Target BER on top of an accumulated eye diagram.
Correlated Eye	This plot shows the data dependent eye with all uncorrelated effects removed.
PDF Eye	This plot shows the underlying statistical model used to generate the BER contours.
BER Eye	This plot shows the probability of a hit vs the location in the eye.

You can select the measurements from the displayed measurement list table on the left. The Plots for the selected measurements are displayed in Select Plots. The plots which are not applicable for the selected measurement are not available under Select Plots. You can select up to 4 plots.

² Available only for Phase Noise measurement.

³ Available only for all Eye, TIE and PCIe-T-TXA measurements.

⁴ Available only for Mask Hits measurement.

⁵ Available only for TJ@BER and Width@BER measurements.

⁶ Available only for PCIe TTX-UDJDD and PCIe TTX-UTJ measurements.

⁷ Available only for PCIe TTX-UPWTJ and PCIe TTX-UPWDJDD measurements.

⁸ Available only for TN@BER measurement.

⁹ Available only for Phase Noise measurement.

¹⁰ Available only for TN@BER measurement.

Plot usage This section provides a description of various plots of DPOJET.

Histogram plot usage

A Histogram plot displays the results such that the horizontal axis represents the measurement values and the vertical axis represents the number of times that each value occurred. Unlike most other plots, a histogram plot can accumulate measurements over multiple acquisitions, up to a total population size of 2.1 billion.

Histograms are particularly useful in analyzing jitter. A histogram of the Time Interval Error (TIE) represents the basis of jitter analysis using a histogram approach. In a histogram, Deterministic Jitter (DJ) is bounded so that the horizontal span of the plot will remain relatively constant. Random Jitter (RJ) is unbounded and amplitude (horizontal span) will continue to grow as more population is acquired. The TIE histogram provides a good way to quickly and informally assess jitter.

Spectrum plot usage

A Spectrum plot is obtained from the Fourier Transform of measurement data from a Time Trend. This plot is useful in identifying periodic frequency components that contribute to timing errors, such as phase modulation.

When the signal has a repetitive data pattern, an analysis of the TIE Spectrum of the signal can be used to separate Random Jitter (RJ) from Deterministic Jitter (DJ) as well as to separate subcomponents such as Periodic Jitter (PJ), ISI and DCD. Spectral components (spikes) that do not correlate with the frequencies contained in the data pattern can be a clue that external deterministic noise sources are coupling into a system.

Data array plot usage

A Data Array plot shows measurement values versus measurement index, where the indexes are always equally spaced along the horizontal axis. In contrast, the measurement values on a Time Trend plot are not equally spaced along the horizontal time axis.

Time trend plot usage

A Time Trend plot is a waveform trace of a measurement versus time. Each measurement value is placed precisely at the time at which the measurement took place. Measurements that involve two timing points are placed at the midpoint between those two time. For example, a Risetime measurement is placed halfway between the low threshold crossing and the high threshold crossing.

A Time Trend plot is useful, for example, in determining if the embedded clock in a serial bit stream is modulated outside the capabilities of your receiver to recover the clock. If the TIE time trend plot starts to take an unexpected periodic shape, then this could indicate that you have uncorrelated periodic jitter from crosstalk or from power supply coupling.

Bathtub plot usage

A Bathtub curve is the industry standard way of viewing the statistical Jitter Eye Opening. A Bathtub curve represents eye opening as a function of the BER (Bit Error Ratio). Most serial standards call for Total Jitter to be measured at a BER of 10^{-12} . The eye opening represented by the Bathtub Curve is what is left of the unit interval after the total jitter measurement is subtracted.

The Jitter Eye opening and the Total Jitter have the following relationship:

Total Jitter + Jitter Eye Opening = 1 Unit Interval

The Bathtub Curve plot shows the eye opening and total jitter values as functions of the BER level. The plot is obtained from jitter analysis that performs RJ-DJ separation.

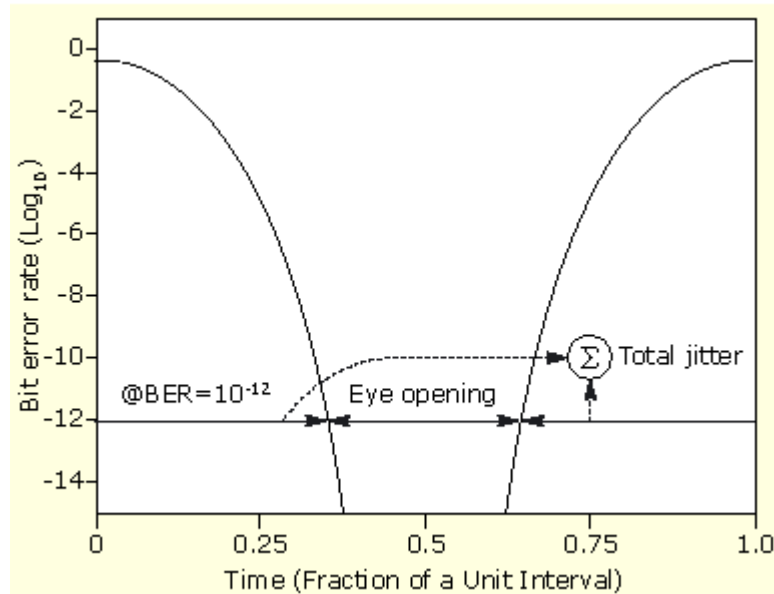

Q-Bathtub plot usage

TTX-UTJ and TTX-UDJDD are two jitter measurements in the PCI Express 3.0 Compliance Specification. The Q-Bathtub plot provides a graphic visualization of the Q-Scale extrapolation used to arrive at the measurement value. The plot represents the Q-Factor value on the y-axis over one unit interval on the x-axis and the extrapolation points are clearly indicated.

Q-PulseWidth plot usage

TTX-UPWTJ and TTX-UPWDJDD are two critical jitter measurements in the PCI Express 3.0 Compliance Specification. The Q-PulseWidth plot provides a graphic visualization of the Q-Scale extrapolation used to arrive at the measurement value. The Q-Factor values lie on the y-axis, and the x-axis represents a part of one unit interval significant for the measurement.

Phase noise plot usage

A Phase Noise plot shows a frequency domain view of the jitter noise on a waveform normalized in an industry-standard way. The vertical axis is logarithmic and uses the units of dBc/Hz, which means “decibels (relative to the carrier) per Hertz”. The horizontal axis is logarithmic with units.

Transfer function plot usage

A Transfer Function plot shows the magnitude ratio of the frequency spectrums of two measurements on logarithmic axes. This can be a useful way to depict the response of a system to stimuli at various frequencies, or to identify poles and zeros in a system characteristic equation. Suppose that $x(t)$ is a jitter measurement at the input of a device, and $y(t)$ is a corresponding jitter measurement at the output of the device. The Transfer Function plot can be used to show the following function, where $X(f)$ is the Fourier Transform of $x(t)$:

$$H(f) = \frac{|Y(f)|}{|X(f)|}$$

The horizontal axis of the Transfer Function plot goes up to the Nyquist frequency of X or Y, whichever is lower. These plots work best if averaged across multiple acquisitions to reduce the effects of measurement noise.

Waveform plot usage

The waveform plot is only applicable to the Mask Hits measurement. It depicts a copy of the source waveform, with all mask violations denoted in a highlight color. These are the same violations that appear on the Mask Hits eye diagram, but the waveform plot allows them to be seen in the context of a continuous-time waveform.

Eye diagram plot usage

An eye diagram is a plot of the voltage versus time for a serial bit stream, with the time axis “wrapped” so that all unit intervals are superimposed on top of each other in a time-aligned fashion. Because the resulting plot has many waveforms overlaid, color grading is used to separate areas with many coincident waveforms from areas that are only rarely crossed.

If there is an area free of waveforms in the center of the diagram, the eye is said to be “open”, and a comparator circuit repetitively sampling the waveform at this point in the unit interval could unambiguously separate the two logic states. For experienced signal integrity engineers, the eye diagram allows many common problems to be recognized instantly.

Composite jitter histogram plot usage

Composite Jitter Histogram plots 4 histograms (TJ, PJ, RJ+BUJ, DDJDCD) together. This will be helpful in analyzing 4 components of jitter together. Configurations for this plot are the same as that of Histogram Plot. This plot is only applicable for Jitter measurements.

BER Eye contour plot usage

This plot shows the Bit Error Rate contours at standard BER Levels like 1e-6, 1e-9, 1e-12, 1e-15, 1e-18 and Target BER on top of an accumulated eye diagram.

Noise Bathtub plot usage

This plot shows the extrapolated curves due to noise like the way Bathtub plot shows the extrapolated curve due to jitter.

Composite noise histogram plot usage

Composite noise histogram plots 5 histograms (TN, PN, RN+NPN, DDN0, DDN1) together. This will be helpful in analysing 5 components of noise together. Configurations for this plot are the same as that of Histogram Plot. This plot is only applicable for Noise measurements.

Correlated Eye plot usage

This plot shows the data dependent eye with all uncorrelated effects removed.

PDF Eye plot usage

This plot shows the underlying statistical model used to generate the BER contours.

BER Eye plot usage

This plot shows the probability of a hit vs the location in the eye.

Selecting plots

Before or after you take measurements, you can set up plots for the selected measurements by following these steps:

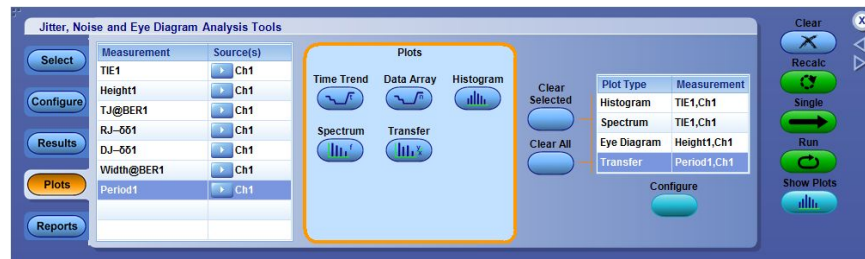

1. Click **Plots** in the *Navigation panel* to view the Select Plot window. The currently active measurements and source(s) are displayed in the table on the left (measurement table).
2. Click any of the plot icons that are available for the selected measurement. The corresponding plot type and measurement are then added to a table on the right (plot table).
3. Add another plot for the current measurement, or select a different measurement and choose from its plot types. A maximum of four plots can be selected at any given time.

Table 75: Plot selections

Item	Description
Plots	Lists only the plots which are available for the selected measurement. Click a plot icon to add the plot type to the table on the right.
Clear Selected	Clears the selected plot from the plot table.
Clear All	Clears all plots from the plot table.
Configure	Allows you to adjust display options for the selected plot.

Configuring plots

About configuring plots. Most plot types (except Data Array and Waveform) have display options that can be adjusted for each instance of the selected plot.

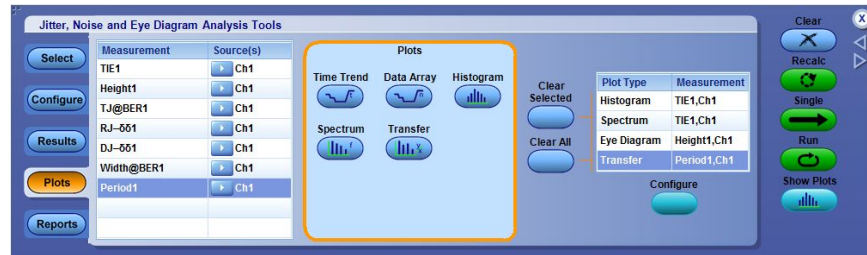

The steps to configure a plot are:

1. Select a plot instance by clicking on a row from plot table on the right.
2. Click **Configure** to display a pop-up window with the available configuration options.
3. Adjust the configuration options and click **OK** to accept the changes and close the window.
4. Click **Show Plots** in the control panel to view the configured plot.

NOTE. The Show Plots icon appears in the only when one or more plots are defined.

Related topics.

[Configuring a time trend](#)

[Configuring a histogram plot](#)

[Configuring a spectrum plot](#)

[Configuring a transfer plot](#)

[Configuring a phase noise plot](#)

[Configuring an eye diagram for mask hits](#)

[Configuring an eye diagram plot for eye height](#)

[Configuring a bathtub plot](#)

[Configuring a composite jitter histogram plot](#)

[Configuring a composite noise histogram plot](#)

[Configuring a BER Eye contour plot](#)

[Configuring a BER Eye plot](#)

[Configuring a Correlated Eye plot](#)

[Configuring a PDF Eye plot](#)

Configuring a bathtub plot. Select a Bathtub plot in the table on the right and click **Configure** to configure the plot.

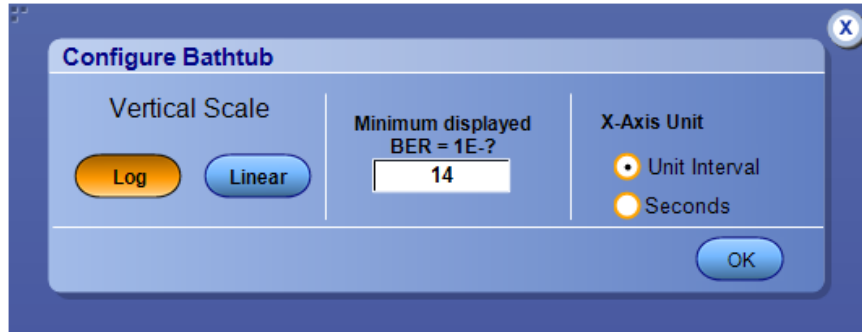

Item	Description
Vertical Scale	Select the Vertical Scale as <ol style="list-style-type: none"> 1. Log for logarithmic scaling of Vertical axis.(default) 2. Linear for linear scaling of Vertical axis.
Minimum displayed BER = 1E-?	Sets the lower axis for logarithmic plots to this value (expressed as the negative of a base-10 exponent).
X-Axis Unit	Select the X-Axis Unit as Unit Interval or Seconds.
OK	Accepts the changes and closes the window.

Configuring a spectrum plot. Select a Spectrum plot in the table on the right to and click **Configure** to configure the plot.

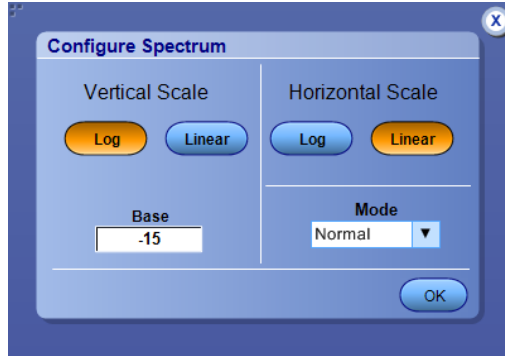

Item	Description
Log	Selects logarithmic scaling for the vertical axis.
Linear	Selects linear scaling for the vertical axis.
Base	Sets the lower axis limit for logarithmic plots to this value (expressed as a base-10 exponent). Available only when the vertical scale is log.
Log	Selects logarithmic scaling for the horizontal axis.
Linear	Selects linear scaling for the horizontal axis.
Mode	Selects whether the plot shows only the most recent spectrum, the uniform average of all spectrums since the last time the results were cleared, or the peak of the envelope of all spectrums since the last time the results were cleared. Normal - Shows magnitude values from the most recent acquisition. Average - Averages the magnitude values at each frequency. Peak Hold - Keeps the maximum value at each frequency.
OK	Accepts the changes and closes the window.

Configuring a time trend. Select a Time Trend plot in the table on the right and click **Configure** to configure the plot.



Item	Description
Vector	Connects measurement points with straight lines to form a continuous waveform.
Bar	Places a vertical bar at the horizontal position of each measurement with a height (positive or negative) that represents the value of that measurement; a horizontal baseline represents the mean value of the Time Trend.
OK	Accepts the changes and closes the window.

Configuring a histogram plot. Select a Histogram plot in the table on the right and click **Configure** to configure the plot.

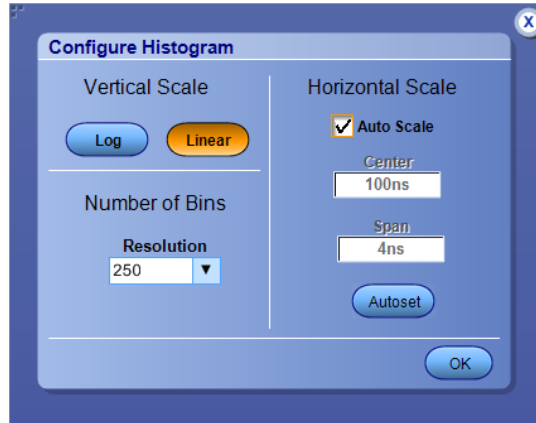

Item	Description
Vertical Scale	
Linear	Selects linear scaling for the vertical axis.
Log	Selects logarithmic scaling for the vertical axis.
Resolution	Defines resolution by the number of bins into which Span is divided: 25, 50, 100, 250, 500, 2000, and Maximum.
Horizontal Scale	
Auto Scale	Causes the horizontal scale of the histogram to be adjusted automatically based on the accumulated data points. If subsequently acquired data falls outside the current horizontal scale, histogram bins are consolidated so that the number of bins is preserved and the horizontal scale allows all data to be plotted. When checked, disables the "Center" and "Span" numerical inputs.
Center	Manually sets the value for the horizontal center of the Histogram, for subsequent plot updates. You can set values up to 1 as (atto second) using your keyboard.
Span	Manually sets the value for the total horizontal range of the Histogram, for subsequent plot updates. You can set values up to 1 as (atto second) using your keyboard.
Autoset	Uses the results of the latest acquisition to determine the logical values for the Center and Span options (if the population of the measurement is three or more).
OK	Accepts the changes and closes the window.

Configuring a transfer plot. Select a Transfer Function plot in the table on the right and click **Configure** to configure the plot.

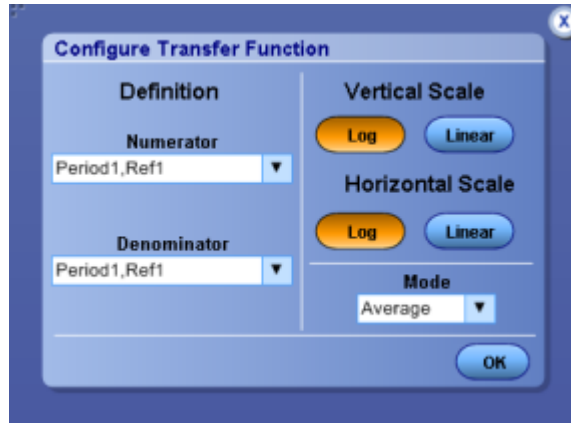

Item	Description
Definition	
Numerator	Measurement for which the magnitude spectrum is used as a reference.
Denominator	Measurement for which the magnitude spectrum is used to normalize the numerator.
Vertical Scale	
Linear	Selects linear scaling for the vertical axis.
Log	Selects logarithmic scaling for the vertical axis (default).
Horizontal Scale	
Linear	Selects linear scaling for the vertical axis.
Log	Selects logarithmic scaling for the horizontal axis (default).
Mode	Selects whether the plot shows only the most recent spectrum, or the uniform average of all spectrums since the last time the results were cleared (default). Normal - updates the plot with current values. Average - averages the magnitude values at each frequency.
OK	Accepts the changes and closes the window.

Configuring a phase noise plot. Select a Phase Noise plot in the table on the right and click **Configure** to configure the plot.

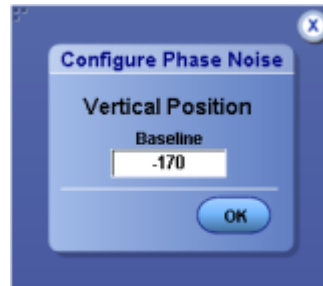

Item	Description
Vertical Position	
Baseline	Sets the lower axis limit for logarithmic plots to this value.
OK	Accepts the changes and closes the window.

Configuring an eye diagram plot for eye height. Select an Eye Diagram plot (for all eye measurements other than Mask Hits) in the table on the right and click **Configure** to configure the plot.

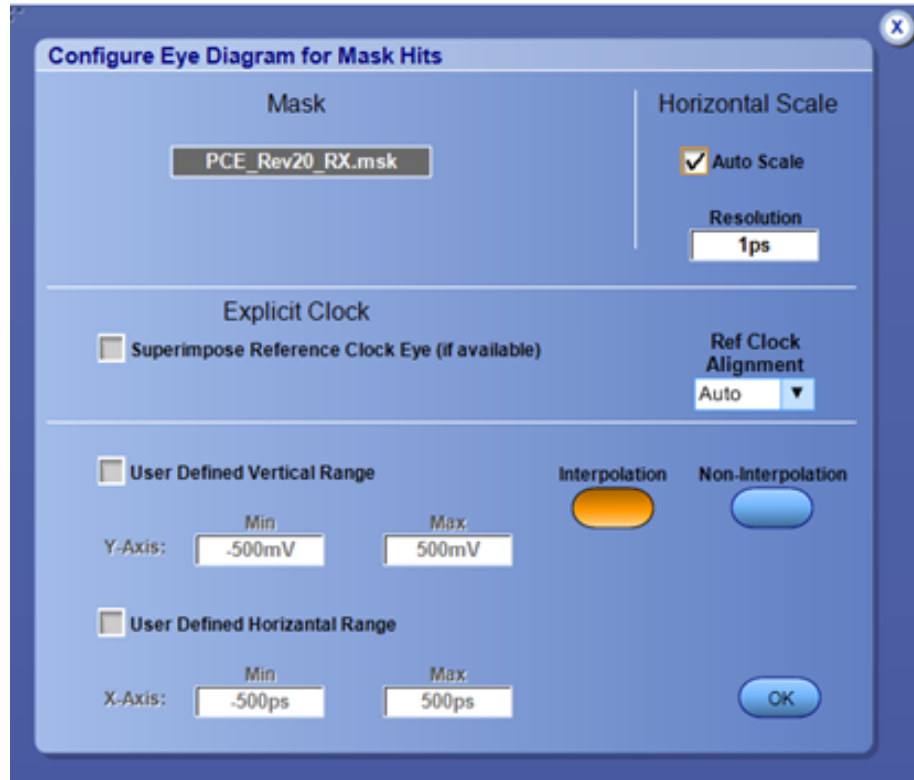

Item	Description
Mask	
On	Enables display and mask testing.
Off	Disables display and mask testing.
Browse	Select a mask file to import from the C:\Users\Public\Tektronix\TekApplications\DPOJET\Masks directory.
Horizontal Scale	
Auto Scale	When checked, causes the horizontal scale to be adjusted automatically.
Resolution	Manually sets the horizontal resolution, when Auto Scale is unchecked.
Superimpose Reference Clock Eye (if available)	When checked, superimposes DQS eye onto the data eye diagram.
Ref Clock Amplitude	
Scale to Ref Clock	Scales the waveform to the one which is larger among the superimposed eye when the Superimpose Reference Clock Eye option is checked.
Scale to Data	Autoscales to the vertical height of the data signal (DQ as in DDRA) without regard to the reference clock (DQS) signal amplitude.

Item	Description
Ref Clock Alignment	Determines how an eye diagram is positioned on the plot. The position is determined by the eye reference point, which is the location of overlapping recovered or explicit clock edge locations. Typically, the eye is located so that waveform edges are approximately at 25% and 75% of the width of the diagram. This ensures that the eye opening is centered on the plot facilitating cursor measurements and mask testing.
Auto	Determines the alignment property automatically. Eye diagram is aligned automatically. Auto is typically equivalent to Left.
Center	Eye reference point is centered on the plot. Center alignment is appropriate for DDR Write bursts or other signals with explicit reference clock where the clock and data signals are out of phase.
Left	Eye reference point is positioned on the left of the plot so that eye opening is centered. Left alignment is appropriate for DDR Read bursts and signals with recovered clock or explicit clock where the clock and data signals are in phase.
User Defined Vertical Range	When checked, min and max values entered by you will be taken for y axis of eye diagram
User Defined Horizontal Range	When checked, min and max value entered by you will be taken for x axis of eye diagram. If the entered range is not valid, a warning message gets displayed with the available x range.
Vertical Alignment	When checked, aligns the mean of clock waveform to the mean of the data waveform. This is useful when the mean of data waveform is not matching to the mean of clock waveform.
Interpolation	When selected, performs eye rendering for a reduced set of Unit intervals. It also performs interpolation between samples and gives a finer rendering appearance.
Non-Interpolation	When selected, performs eye rendering for the complete set of Unit intervals. This option does not perform any interpolation and gives a coarser rendering appearance.
Save Eye Diagram Raw Data	By clicking Browse button, it saves the raw Eye Diagram 2d histogram data to the specified file path. The Format is determined through the filename extension.
OK	Accepts the changes and closes the window.

Related topics.

[Effect of nominal clock offset on eye diagrams](#)

NOTE. If there is unwanted skew between the data and explicit clock signals, the channels must be properly deskewed. Refer to your oscilloscope online help on how to deskew the channels.

Configuring an eye diagram for mask hits. An eye diagram plot is activated whenever a mask hits measurement is selected. Click **Configure** in the plots panel to configure the plot.

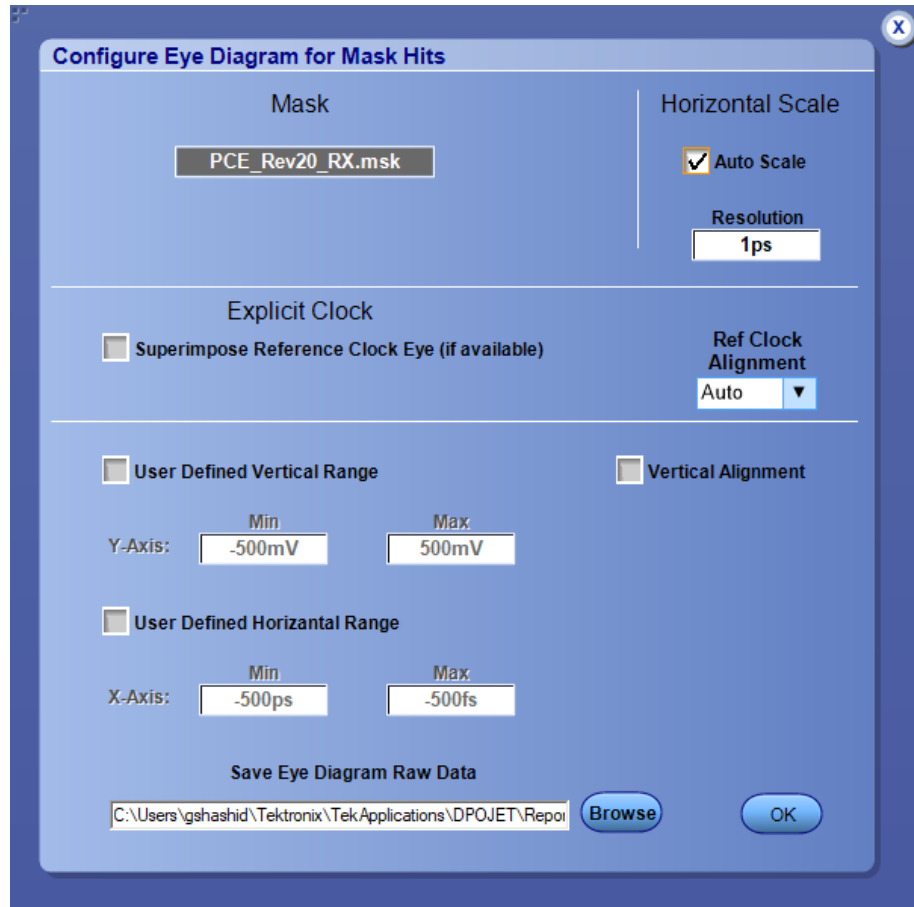

Item	Description
Mask	Shows which mask has been selected (for the Mask Hits measurement, the mask selection is performed as part of measurement configuration rather than plot configuration).
Horizontal Scale	
Auto Scale	When checked, causes the horizontal scale to be adjusted automatically.
Resolution	Manually sets the horizontal resolution, when Auto Scale is unchecked.
Superimpose Reference Clock Eye (if available)	When checked, superimposes DQS eye onto the data eye diagram.

Item	Description
Ref Clock Alignment	Determines how an eye diagram is positioned on the plot. The position is determined by the eye reference point, which is the location of overlapping recovered or explicit clock edge locations. Typically, the eye is located so that waveform edges are approximately at 25% and 75% of the width of the diagram. This ensures that the eye opening is centered on the plot facilitating cursor measurements and mask testing.
Auto	Determines the alignment property automatically. Eye diagram is aligned automatically. Auto is typically equivalent to Left.
Center	Eye reference point is centered on the plot. Center alignment is appropriate for DDR Write bursts or other signals with explicit reference clock where the clock and data signals are out of phase.
Left	Eye reference point is positioned on the left of the plot so that eye opening is centered. Left alignment is appropriate for DDR Read bursts and signals with recovered clock or explicit clock where the clock and data signals are in phase.
User Defined Vertical Range	When checked, min and max values entered by you will be taken for y axis of eye diagram
User Defined Horizontal Range	When checked, min and max value entered by you will be taken for x axis of eye diagram. If the entered range is not valid, a warning message gets displayed with the available x range.
Vertical Alignment	When checked, aligns the mean of clock waveform to the mean of the data waveform. This is useful when the mean of data waveform is not matching to the mean of clock waveform.
Save Eye Diagram Raw Data	By clicking Browse button, it saves the raw Eye Diagram 2d histogram data to the specified file path. The Format is determined through the filename extension.
OK	Accepts the changes and closes the window.

Related topics.

[Effect of nominal clock offset on eye diagrams](#)

NOTE. *If there is unwanted skew between the data and explicit clock signals, the channels must be properly deskewed. Refer to your oscilloscope online help on how to deskew the channels.*

Configuring an eye diagram for DFE measurements. An eye diagram plot is activated whenever a DFE EH, DFE EW, or DFE Eye Diagram measurement is selected. Click **Configure** in the plots panel to configure the plot.

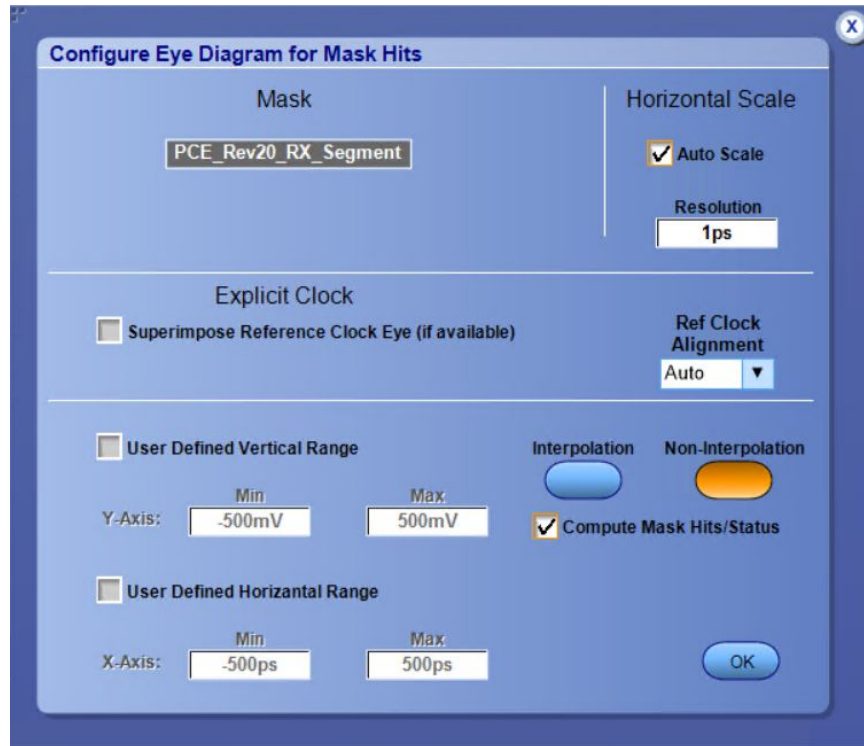

Item	Description
Mask	
On	Enables display and mask testing.
Off	Disables display and mask testing.
Browse	Select a mask file to import from the C:\Users\Public\Tektronix\TekApplications\DPOJETMasks directory.
Horizontal Scale	
Auto Scale	When checked, causes the horizontal scale to be adjusted automatically.
Resolution	Manually sets the horizontal resolution, when Auto Scale is unchecked.
Superimpose Reference Clock Eye (if available)	When checked, superimposes DQS eye onto the data eye diagram.
Ref Clock Amplitude	
Scale to Ref Clock	Scales the waveform to the one which is larger among the superimposed eye when the Superimpose Reference Clock Eye option is checked.
Scale to Data	Autoscales to the vertical height of the data signal (DQ as in DDRA) without regard to the reference clock (DQS) signal amplitude.

Item	Description
Ref Clock Alignment	Determines how an eye diagram is positioned on the plot. The position is determined by the eye reference point, which is the location of overlapping recovered or explicit clock edge locations. Typically, the eye is located so that waveform edges are approximately at 25% and 75% of the width of the diagram. This ensures that the eye opening is centered on the plot facilitating cursor measurements and mask testing.
Auto	Determines the alignment property automatically. Eye diagram is aligned automatically. Auto is typically equivalent to Left.
Center	Eye reference point is centered on the plot. Center alignment is appropriate for DDR Write bursts or other signals with explicit reference clock where the clock and data signals are out of phase.
Left	Eye reference point is positioned on the left of the plot so that eye opening is centered. Left alignment is appropriate for DDR Read bursts and signals with recovered clock or explicit clock where the clock and data signals are in phase.
User Defined Vertical Range	When checked, min and max values entered by you will be taken for y axis of eye diagram
User Defined Horizontal Range	When checked, min and max value entered by you will be taken for x axis of eye diagram. If the entered range is not valid, a warning message gets displayed with the available x range.
Vertical Alignment	When checked, aligns the mean of clock waveform to the mean of the data waveform. This is useful when the mean of data waveform is not matching to the mean of clock waveform.
Interpolation	When selected, performs eye rendering for a reduced set of Unit intervals. It also performs interpolation between samples and gives a finer rendering appearance.
Non-Interpolation	When selected, performs eye rendering for the complete set of Unit intervals. This option does not perform any interpolation and gives a coarser rendering appearance.
Compute Mask Hits/Status	When checked, the total number of mask hits is displayed.
Save Eye Diagram Raw Data	By clicking Browse button, it saves the raw Eye Diagram 2d histogram data to the specified file path. The Format is determined through the filename extension.
OK	Accepts the changes and closes the window.

Related topics.

[*Effect of nominal clock offset on eye diagrams*](#)

NOTE. *If there is unwanted skew between the data and explicit clock signals, the channels must be properly deskewed. Refer to your oscilloscope online help on how to deskew the channels.*

Configuring a composite jitter histogram plot. Select the Composite Jitter Histogram (CJH) plot from the list on the right and click Configure to configure the plot.

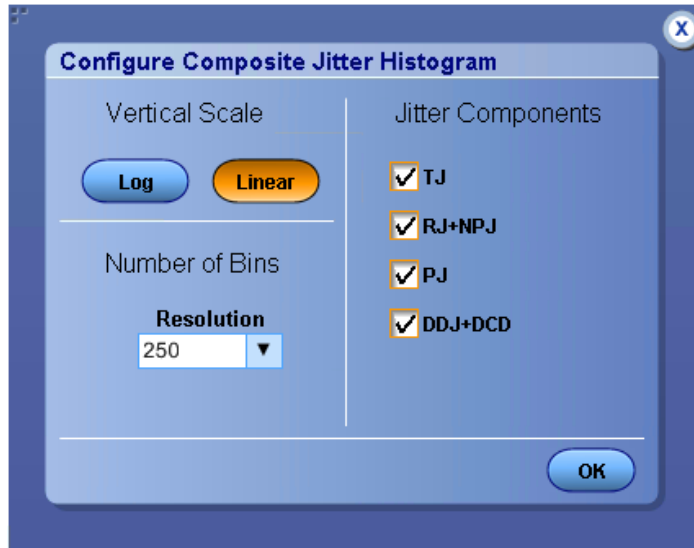

Table 76: Composite jitter histogram plot

Item	Description
Vertical Scale	Select the Vertical Scale as <ol style="list-style-type: none"> 1. Log for logarithmic scaling of Vertical axis. 2. Linear for linear scaling of Vertical axis (default).
Number of Bins	
Resolution	Defines resolution by the number of bins into which Span is divided: 25, 50, 100, 250, 500, 2000, or Maximum.
Jitter Components	Selected checkbox values will be plotted <ul style="list-style-type: none"> ■ TJ ■ RJ+NPJ ■ PJ ■ DDJ+DCD By default , all Jitter components will be checked.
OK	Accepts the changes and closes the window

NOTE. In CJH plot, the RJ+NPJ histogram values and RJ Trend are analytical values when RJ is locked.

Configuring a composite noise histogram plot. Select the Composite Noise Histogram plot from the list on the right and click Configure to configure the plot.

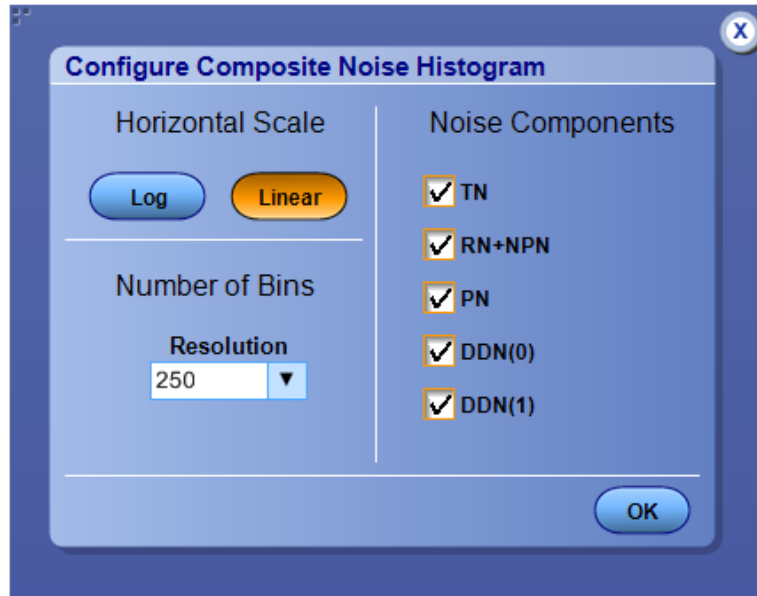
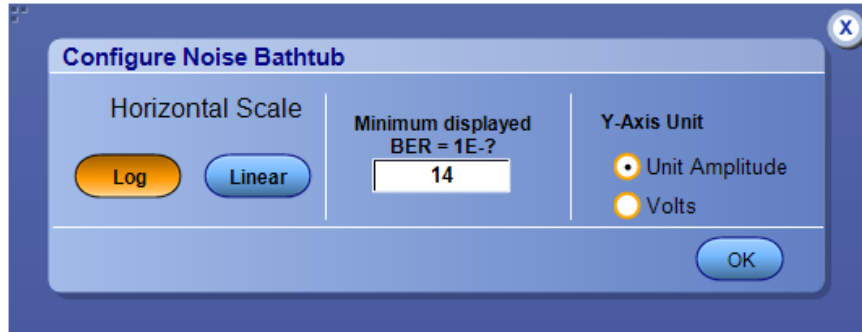

Table 77: Composite noise histogram plot

Item	Description
Horizontal Scale	Select the Horizontal Scale as <ol style="list-style-type: none"> 1. Log for logarithmic scaling of horizontal axis. 2. Linear for linear scaling of horizontal axis (default).
Number of Bins	
Resolution	Defines resolution by the number of bins into which Span is divided: 25, 50, 100, 250, 500, 2000, or Maximum.
Noise Components	Selected checkbox values will be plotted <ul style="list-style-type: none"> ■ TN ■ RN+NPN ■ PN ■ DDN(0) ■ DDN(1) By default , all Noise components will be checked.
OK	Accepts the changes and closes the window

Configuring a noise bathtub plot. Select a Noise bathtub plot in the table on the right and click Configure to configure the plot.



Item	Description
Horizontal Scale	Select the Horizontal Scale as <ol style="list-style-type: none"> 1. Log for logarithmic scaling of horizontal axis (default). 2. Linear for linear scaling of horizontal axis.
Minimum displayed BER = 1E-?	Sets the lower axis for logarithmic plots to this value (expressed as the negative of a base-10 exponent).
Y-Axis Unit	Select the Y-Axis Unit as Unit Amplitude or Volts. Default - Unit Amplitude
OK	Accepts the changes and closes the window.

Configure a BER Eye contour plot. Select a BER Eye contour plot from the list on the right and click Configure to configure the plot.

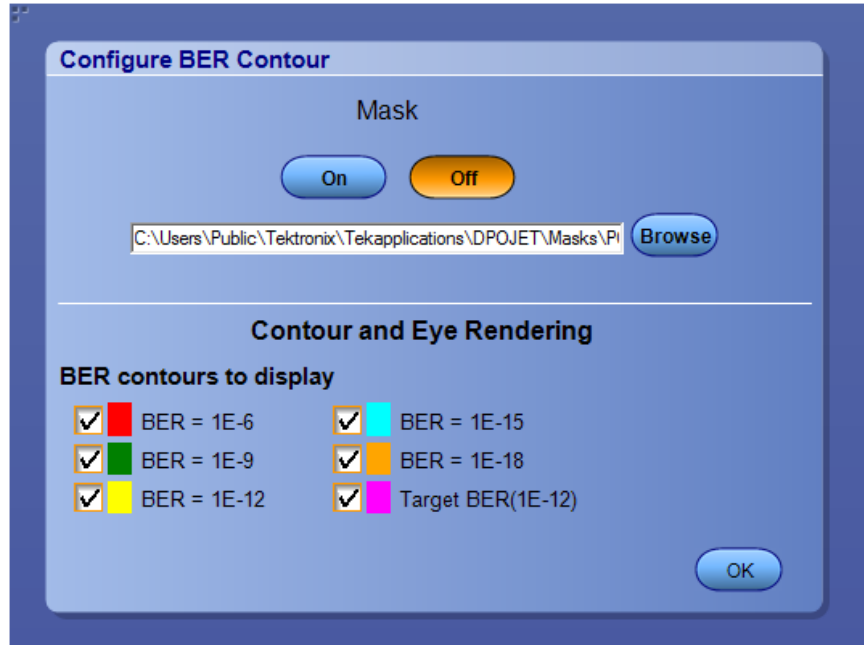

Item	Description
Mask	
On	Enables display and mask testing.
Off	Disables display and mask testing.
Browse	Select a mask file to import from the C:\Users\Public\Tektronix\TekApplications\DPOJET\Masks directory.
Contour and Eye rendering	
BER contours to display	Enables the user to select or de-select BER contours of interest. By default, all the standard BER contours are selected. <i>NOTE. Target BER determines the Target BER value which is configured in RJDJ or RNDN for the measurements. The default Target BER value is (1E-12).</i>
OK	Accepts the changes and closes the window.

Configure a BER Eye plot. Select a BER Eye plot from the list on the right and click Configure to configure the plot.

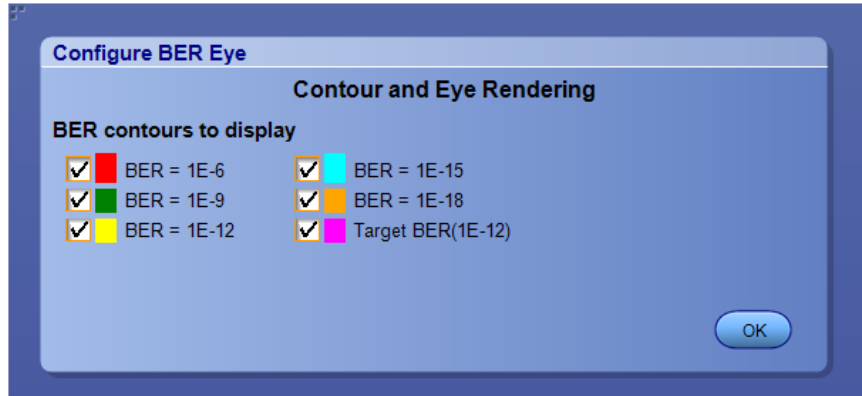

Item	Description
Contour and Eye rendering	
BER contours to display	Enables the user to select or de-select BER contours of interest. By default, all the standard BER contours are selected.
OK	Accepts the changes and closes the window.

Configure a Correlated Eye plot. Select a Correlated Eye plot from the list on the right and click Configure to configure the plot.

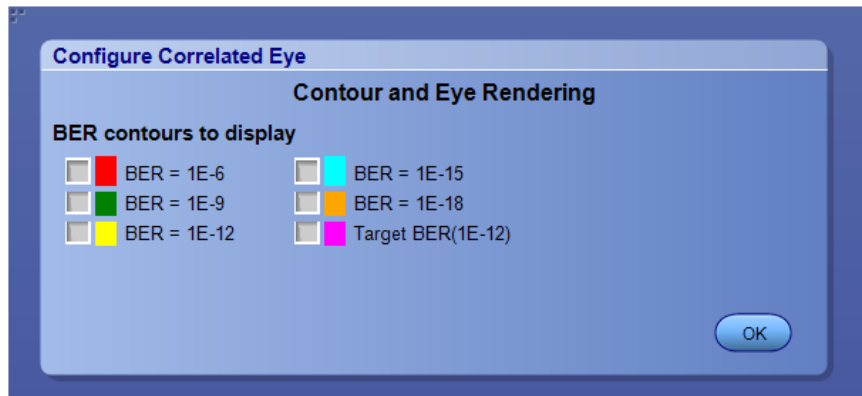

Item	Description
Contour and Eye rendering	
BER contours to display	Enables the user to select or de-select BER contours of interest. By default, all the standard BER contours are un-selected.
OK	Accepts the changes and closes the window.

Configure a PDF Eye plot. Select a PDF Eye plot from the list on the right and click Configure to configure the plot.

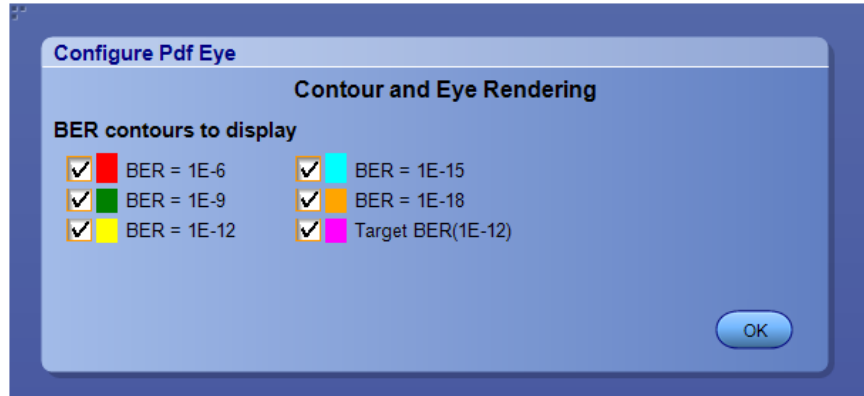

Item	Description
Contour and Eye rendering	
BER contours to display	Enables the user to select or de-select BER contours of interest. By default, all the standard BER contours are selected.
OK	Accepts the changes and closes the window.

Viewing plots

About viewing plots. You can create and configure up to four plots. If you already have measurement results, creating a plot will cause it to be displayed immediately. If there are no current results, the plot will be created when you sequence the application and results have been calculated. The Show Plots icon appears in the control panel whenever at least one plot is defined. The Show Plots  icon appears in the control panel whenever at least one plot is defined. By default, all defined plots windows are grouped in a single window on the upper half of the display, but the window can be moved, resized, or dragged to a second monitor. The application includes tools to help you select which plots to view, to size and position the plot windows, to save plot information, to use the zoom function, and to use the cursors functions.

If your Windows desktop is extended to a second monitor, you can drag the plots window to the second monitor.

NOTE. When sequencing is complete, the plot window displays with the last plot selected. The plot window also updates whenever you reconfigure a plot.

Using a second monitor to view plots. If your oscilloscope setup includes a second monitor that extends the Windows desktop, you can select and drag the title bar of the plot window to position it in the second monitor. This allows you to simultaneously display a waveform on the oscilloscope, measurement results, and the plot for easy viewing.

Toolbar functions in plot windows. The Plot Toolbar window includes the following functions:



Table 78: Plot toolbar functions

Icon	Functions
	Export Figure.
	Print Figure.
	Zoom and Pan.
	Vertical and Horizontal Cursor controls.
	Moving and Resizing Plots.
	Plot properties.
	Plot Summary Views.
	Full view of plots 1 to 4.

Moving and resizing plots. You can move and resize plot windows the same way you would move and resize any window.

You can change the plot size to the whole display of the oscilloscope, or to half the display. When viewing a plot in half the display, you can position the plot to the top or bottom. The tools also return the plot to the original size. To position a plot quickly on the oscilloscope, select one of the following tools in the plot window:

- enlarges the plot to fill the entire display.
- positions the plot to the top.
- positions the plot to the bottom.
- always keep the plot on top layer.

Using zoom in a plot. Once you have created a plot, you can use the Zoom tools to examine the data at various scales.



TIP. *If you prefer to use the zoom functions in a plot window with your finger, you can activate the Touch Screen on the oscilloscope.*

Table 79: Zoom functions in a plot

Item	Description
	Zoom in (Horizontal and Vertical) – Expands part of the plot; the data appears in more detail.
	Zoom out – Contracts part of the plot; the data appears in less detail.
	Zoom in (Horizontal only) – Expands the horizontal axis only and retains the vertical axis.
	Resets the zoom to 100%.

Changing the scale of data in a plot (Zoom). To change the scale of the data in a Plot Details window, select one of the following plot zoom tools:

- zooms in to expand the scale.
- zooms out to contract the scale.
- zooms in to expand the horizontal axis only.
- moves the plot anywhere within the scale.
- zooms in to restore the entire waveform data.

When you select the tool, you can use a select-drag-release action to expand part of the waveform (zoom in) by an arbitrary amount on both axes. After you select (touch with a finger or click with the mouse) and begin dragging, a bounding box shows what part of the waveform will be expanded upon release.

Select any part of the plot to expand the data by a factor of two (2X) equally on both axes. Double selecting expands the data to the maximum factor.

To contract an expanded part of the data (zoom out), select anywhere on the data. The view contracts to the values that existed before the most recent expansion of the data. Selecting multiple times will restore successively earlier views. To expand the scale of the horizontal axis only by a factor of two (2X), click a part of the waveform. The plot retains the scale of the vertical axis.







TIP. *Select to see the entire available waveform.*

Using cursors in a plot. Cursors allow you to view numerical values associated with a plot based on cursor locations. There are two types of cursors:



- Horizontal cursors

- Vertical cursors

Table 80: Cursor functions in a plot

Item	Description
	Displays the vertical coordinate where each cursor touches the plot and the difference (Δ) between the cursors.
	Displays the horizontal coordinate where each cursor touches the plot and the difference (Δ) between the cursors.
	Brings the cursors into the visible part of the plot.
	Displays the plot properties.

Cursors in a plot. You can use cursors to read the coordinate where each cursor (line) touches the plot and also view the difference (Δ) between the two cursors. The steps to use cursors in a plot details window are:

1. Select any of the following cursors:
 -  to use horizontal cursors.
 -  to use vertical cursors.
 -  to bring cursors into the visible plot.
2. Select and drag either cursor to move the cursor to the desired part of the plot. The cursor readout changes to reflect the cursor position.

NOTE. You can drag cursors only when the Zoom functions are disabled.





TIP. If you prefer to move the cursors in the plot window with your finger, you can activate the touch screen on the oscilloscope.

Exporting plot files. You can export plot image in Plot Toolbar window. Click  to save the contents of the plot window in any of the format as a MATLAB figure format (.fig), .bmp, .jpg, .png, .emf, .tif, .mat and .csv.

The steps to export a plot file are:

1. Set up the plot window.
2. Select  to save the plot as a figure.
3. Select the directory and enter a file name.
4. Click **Save**. The application saves the file in C:\%USERPROFILE%\Tektronix\TekApplications\DPOJET\images, where %USERPROFILE% represents your user location.

Printing plots. The steps to print a plot are:

1. Verify that the printer is configured.
2. Set up the plot window with zoom, cursors, or grid functions.
3. Click  icon in the plot details/summary window. The Print Preview dialog is displayed.
4. Click  to set up the printing options and print a plot file.

NOTE. You can customize the print layout using the MATLAB page setup options. The DPOJET online help does not provide information on MATLAB page setup. For more information, refer to the MATLAB documentation.

Reports

About reports

You can use the Reports to configure and generate a compliance report to view later or to share with others. You can also access reports using **Analyze > Jitter and Eye Analysis (DPOJET) > Reports**. You can select the option which you want to display in the report as shown in the following table:

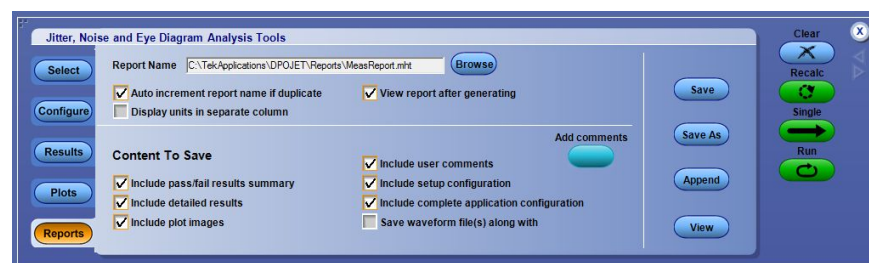

NOTE. When only the Mask Hits measurement is selected, the report shows only the Pass/Fail information. If any other measurement having limits is selected along with the Mask Hits measurement, limit information section is also included in the generated report.

Table 81: Report generation options

Item	Description
Auto increment report name if duplicate	Select/Clear the option to auto increment the report name if its already existed. The auto generated report is of YYYYMMDD_HHMMSS_savedfile.mht format.
Display units in separate column	Select this option to display units in separate column
View report after generating	Select this option to view the report after generation.
Report Name	Lists the directory path where the last generated report is stored.
Save	Saves the changes in the default report directory. Manipulates the report name based on "Auto increment report name if duplicate" option.
Save As	Displays the browser where you specify the directory to save the generated report. You can also edit the report name in the Save As browser. By default, the generated report is saved in C:\%USERPROFILE%\Tektronix\TekApplications\DPOJET\Reports, where %USERPROFILE% represents your user location.
Append	Adds the current settings to an existing report.
View	Opens the generated report in the default browser.
Include pass/fail results summary	Select/Clear the option to include/exclude the pass/fail status in the generated report.
Included detailed results	Select/Clear the option to include/exclude the measurement result details in the generated report.
Include plot images	Select/Clear the option to include/exclude the plot images like measurement plots and oscilloscope waveform in the generated report. Saving a report from Internet Explorer does not save plot images.
Include setup configuration	Select/Clear the option to include/exclude the setup information like DPOJET version, oscilloscope version, and status in the generated report.
Include complete application configuration	Select/Clear the option to include/exclude the complete configuration details in the generated report.
Save waveform file(s) along with report	Select/Clear the option to include/exclude the oscilloscope waveform details in the generated report.
Include user comments	Select the option to include any comments in the generated report. To do so, click the Add/Edit comments button.

Reports Format. The generated reports are in .mht format and includes the following configured set of information:

- Comments displays any user comments.
- Setup Configuration such as DPOJET version and oscilloscope version.
- Measurement Configuration such as measurement name, source and other configuration parameters. Click on the measurement name to view the oscilloscope waveform details.
- Source Reference Levels displays the reference voltage levels for the high, mid, and low thresholds for the rising edge and for the falling edge of all sources, and the hysteresis.
- Miscellaneous Settings such as Gating, Qualify and Population status.
- Pass/Fail Summary indicating the Pass/Fail status for the selected measurements. Also displays the limits information for measurements selected along with Mask Hits.
- Measurement Results with statistics.
- Plot Images includes both selected plots and oscilloscope waveforms.
- Reference waveforms stored at includes the location of the waveforms used.

Append Reports. Click the **Append** button to add the generated report to an existing report of the same format. The application prompts you with a message “Do you wish to append the current results to xxx.mht”? before the append action.

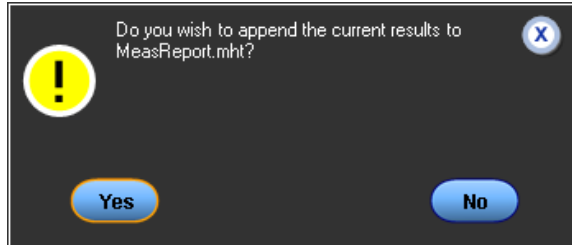

NOTE. *Time stamp differentiates various appended reports.*

Reports compatibility. The application displays a warning when you try to append the report with other reports, generated using previous versions of DPOJET. Click **Yes** to overwrite an old report with a newer format.

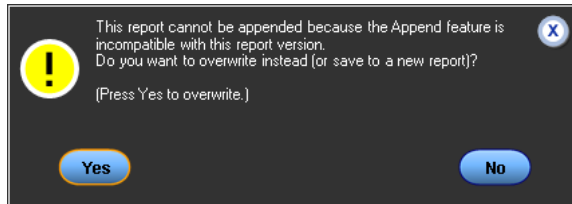

NOTE. *If there is not enough disk space to save the report, the application displays “Cannot save file: There may not be enough free disk space. Delete one or more files to free disk space, and then try again”.*

Printing reports. You need to set the following while printing reports to get the alternate gray and white rows in the table:

- Select Internet Explorer, go to **Tools > Internet Options**.

- In the Advanced tab, select the option **Print Background Color and Images** under Printing as shown.

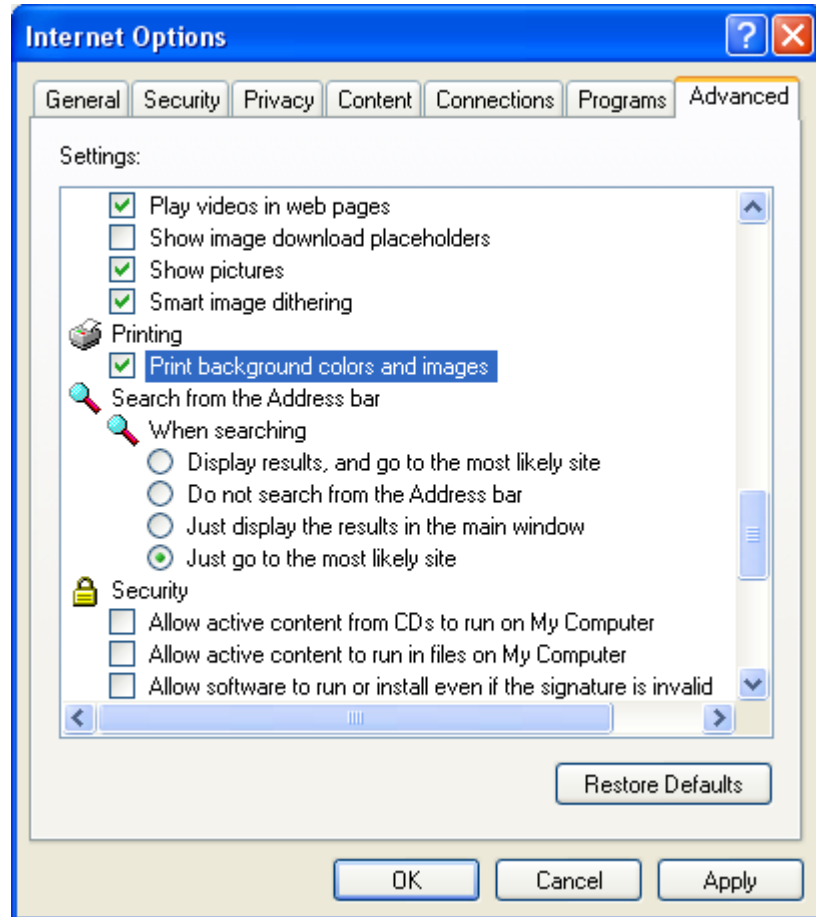

Saving waveform files. You can save waveform(s) used for the measurement by checking the option “Save Waveform file(s) along with report” in the reports screen. The waveforms are stored under C:\%USERPROFILE%\Tektronix\TekApplications\DPOJET\Reports, where %USERPROFILE% represents your user location.

If one or more waveforms are to be saved, the report name is incremented for every append action by including a number in the parenthesis as shown:

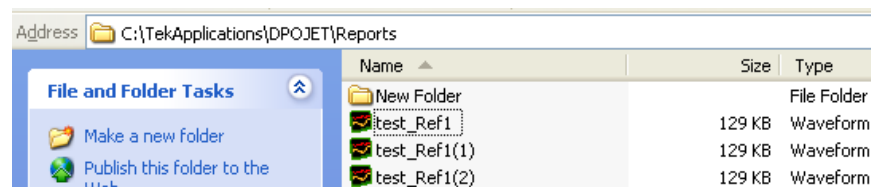

NOTE. *If the waveform path name is greater than 128 characters, the applications displays a warning even though the waveform is created with a truncated name (without a .wfm extension).*

Add Comments. Check “Include user comments” option to include the comments in the generated report. Click **Add comments** in the report panel to include comments in the report. **Add Comments** changes to **Edit Comments** in the report panel until all the contents are cleared in the Comment dialog box.



Item	Description
Clear	Clears the edited contents.
Copy	Copies the edited contents.
Paste	Pastes the copied contents in the new comments dialog box even after closing the window without clicking “Ok”.
Cancel	Closes the dialog box without saving any added contents.
OK	Saves the edited text.

Tutorial

Introduction to the tutorial

This tutorial teaches how to set up the application, take measurements, and view results as plots or statistics.

Before you begin the tutorial, perform the following tasks:

- Set up the oscilloscope.
- Start the application.
- Recall the tutorial waveform.

NOTE. *The screen captures shown in this section are from a DPO7254 oscilloscope.*

Setting up the oscilloscope

The steps to set up the oscilloscope are:

1. Click **File > Recall Default Setup** in the oscilloscope menu bar to recall the default settings.
2. Press the individual CH1, CH2, CH3, and CH4 buttons as needed to add or remove active waveforms from the display.

Starting the application

Click **Analyze > Jitter and Eye Analysis (DPOJET) > Select** to open the application.

Waveform files

The application provides the following tutorial waveforms:

- Rt-EyeTutorial.wfm
- ckminus_50gs_18g_20m_pat1.wfm
- ckplus_50gs_18g_20m_pat1.wfm
- dplus_50gs_18g_20m_pat1.wfm
- dminus_50gs_18g_20m_pat1.wfm

The waveform files are found at C:\Users\Public\Tektronix\TekApplications\DPOJET\Examples.

Recalling a waveform file

To recall a waveform file, follow these steps:

1. Click **File > Recall** in the oscilloscope menu bar to display the Recall dialog box.

NOTE. *If the application is in button mode, select the Recall button to recall the tutorial waveform.*

2. Click **Waveform** icon in the left of the Recall dialog box.
3. Select Ref1, Ref2, Ref3, or Ref4 as the Destination option.
4. Browse to select the waveform. Use the keypad to edit the waveform file name.
5. Click **Recall**. The oscilloscope recalls and activates the Reference Waveform control window.
6. Click **On** to display the waveform.
7. Click  to return to the application. Alternatively, DPOJET can also be accessed from **Analyze > Jitter and Eye Analysis (DPOJET) > Select**.



In the Summary tutorial, the tutorial waveforms are recalled as Math waveforms using the following setup:

- dplus_50gs_18g_20m_pat1.wfm is recalled as **Ref1** and dminus_50gs_18g_20m_pat1.wfm as **Ref2**.

NOTE. Using *Math Setup* (Select *Math* > *Math Setup* in the menu bar to view the *Math Setup* dialog. For more details, refer to the “*Math Equation Editor: Controls in your oscilloscope online help*), set .

- ckplus_50gs_18g_20m_pat1.wfm is recalled as **Ref3** and ckminus_50gs_18g_20m_pat1.wfm as Ref4.

NOTE. Using *Math Setup*, set

Taking a period measurement

In this lesson, you will learn how to take a period measurement and view the results. You can also learn the following tasks:

- Select a measurement and a source
- Configure measurement
- Take measurements
- View results as plots or statistics
- View reports
- Return to the application

Setting up a Period Measurement

Follow these steps to take a period measurement:

1. To set the application to default values, click **File** > **Recall Default Setup**. This is not necessary if you have just started the application.
2. To view the DPOJET application, select **Analyze** > **Jitter and Eye Analysis (DPOJET)** > **Select**.

- Go to **Select** in the left navigation panel. Click **Period** in the Measurements area. The application shows the measurement and source selection on the right of the display. The current measurement selection is displayed as Period1. The subsequent selections will be Period2, Period3 and so on. In this example, Rt-EyeTutorial.wfm is recalled as Ref1 and is selected as source for Period1. New measurements initially use the same source as the earlier measurement, or the most recently used source.

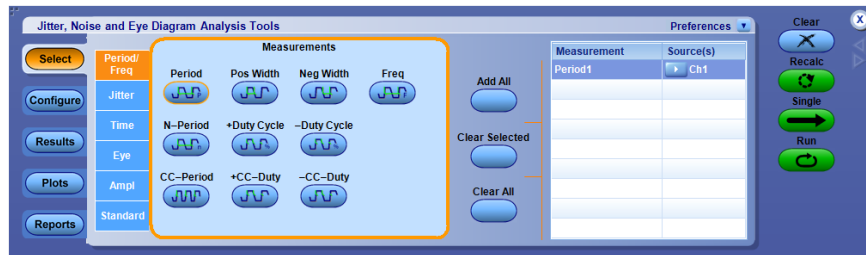

- Click  or the row which lists the selected measurement to configure the source. Select Ref1 for Period1. For more details, refer to [Source setup](#).
- Click **Ref Levels Setup**. The Configure Reflevel menu appears. For more details, refer to [Ref levels](#).
- Click **Configure** in the left navigation panel of the main application window to view the configure tabs. For more details, refer to [Configuring measurements](#).
- Click **Plots** to view the available plots for the selected measurement. Select Time Trend for Period. For more details, refer to [Configuring time trend](#).
- Click **Single** to run the application. When complete, the result statistics is shown in the results tab. The plots are displayed as shown:

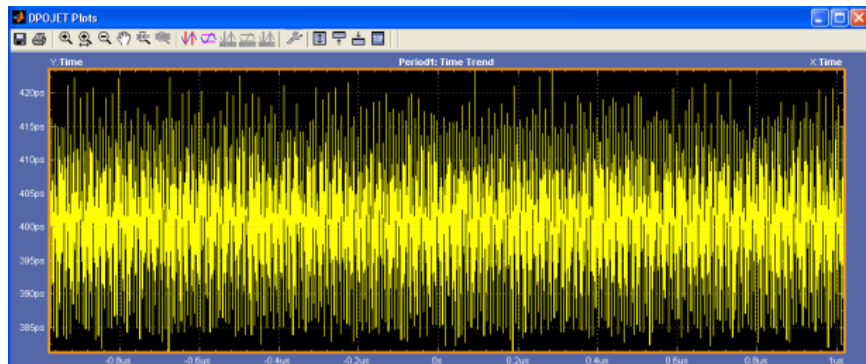



NOTE. You can log result , to a .csv file and to a .wfm file.

Taking a TIE measurement

For jitter application, use the PLL TIE measurement. The steps to take a TIE measurement are:

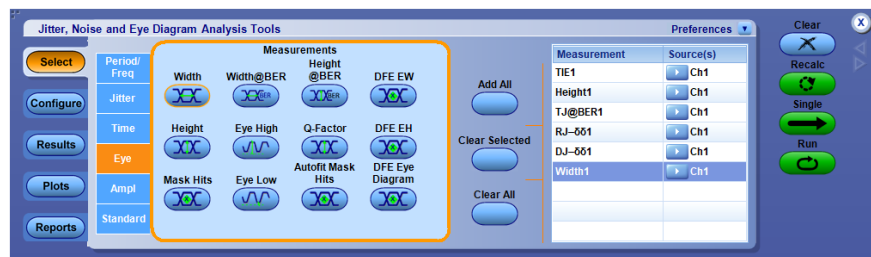
1. To set the application to default values, click **File > Recall Default Setup**. This is not necessary if you have just started the application.
2. Go to **Select** in the left navigational panel. Click **Jitter** tab to select TIE in the Measurements area. The application shows the measurement and source selection on the right of the display. In this example, Rt-EyeTutorial.wfm is recalled as Ref1 and is selected as source for TIE1.



3. Click  or the row which lists the selected measurement to configure the source. Select Ref1 for TIE1. For more details, refer to [Source setup](#).
 4. Click **Ref Levels Setup** in the source configuration dialog. The Configure Reflevel menu appears. For more details, refer to [Ref levels](#).
 5. Click **Configure** in the left navigation panel to view the configure tabs. For more details, refer to [Configuring measurements](#).
1. Click **Plots** to view the available plots for the selected measurement. Select Time Trend and Spectrum plots for TIE measurement. For more details, refer to [Configure plots](#).
 2. Click **Single** to run the application. When complete, the result statistics is shown in the results tab. The plots are displayed as follows:

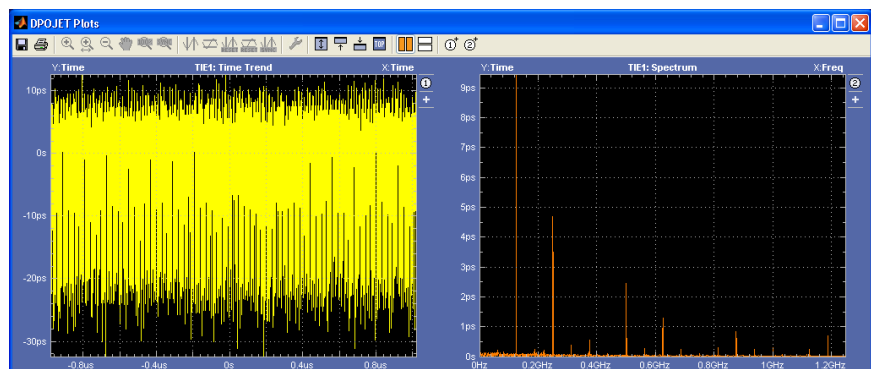

NOTE. You can log result *Statistics, Measurement data points* to a .csv file and *Worst case waveforms* to a .wfm file.

Taking an eye height and width measurement

For signal integrity application, use the Eye Height and Width measurements.

1. Select **Analyze > Jitter and Eye Analysis (DPOJET) > Select** to run the DPOJET application.
2. Go to Select in the left navigation panel. Click **Eye** tab to select Height and Width measurement. In this example, Rt-EyeTutorial.wfm is recalled as Ref1 and is selected as source for Height1 and Width1.

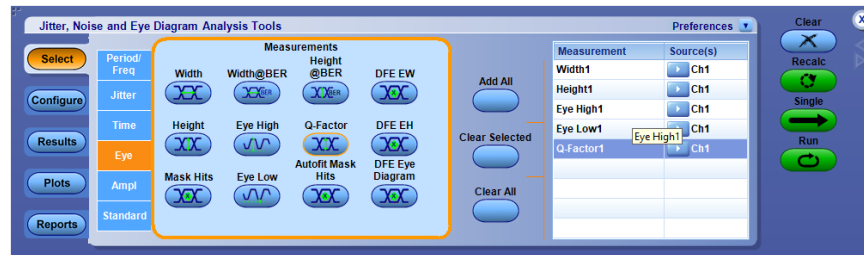

3. Select Ref1 as source for Height and Width measurements. For more details, refer to [Source setup](#).
4. Click Plots to view the available plots for the selected measurement. Select Eye Diagram for Height measurement.
5. Select Eye diagram Plot type and click **Configure** to turn on the Mask in the Configure Eye Diagram for Eye Height dialog. For more details, refer to the [Configuring eye diagram plot for eye height](#).
6. Select Histogram plot for Width measurement.
7. Click **Single** to run the application. When complete, the result statistics is shown in the results tab.

8. The Plot summary window is displayed as shown in the following figure:

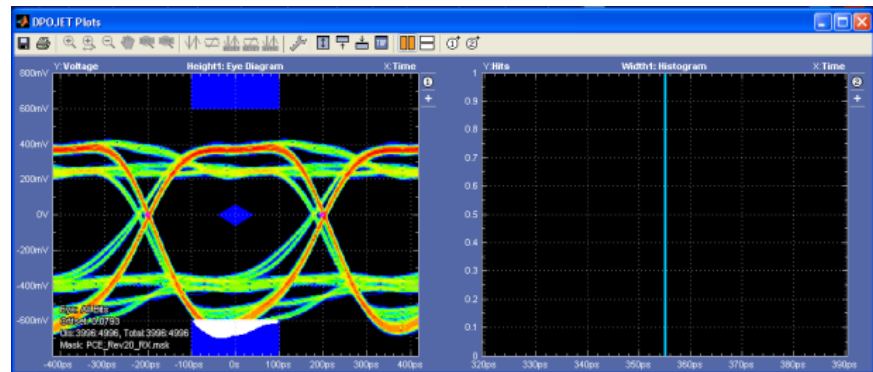

NOTE. You can log result *Statistics*, *Measurement data points* to a *.csv* file and *Worst case waveforms* to a *.wfm* file.

Summary tutorial

For a summary tutorial, the following example is considered:

Case 1: Period measurement with Low pass filters to show SSC profile:

1. Select **Analyze > Jitter and Eye Analysis (DPOJET) > Select** to run the DPOJET application. For more details on waveforms recalled on Math1, Refer *Recalling a waveform file*.
2. Select Period measurement on Math1.
3. Click **Configure**. In the Filters configuration tab, select 2nd order low pass filter and specify the cut-off frequency as 33 kHz. ($F_2 = F_{\text{baud}}/1667$).
4. Go to Plots. Select Time Trend for Period measurement.

- Click **Single** to run the application. When complete, the result statistics is shown in the results tab. The Time Trend plot is as shown.

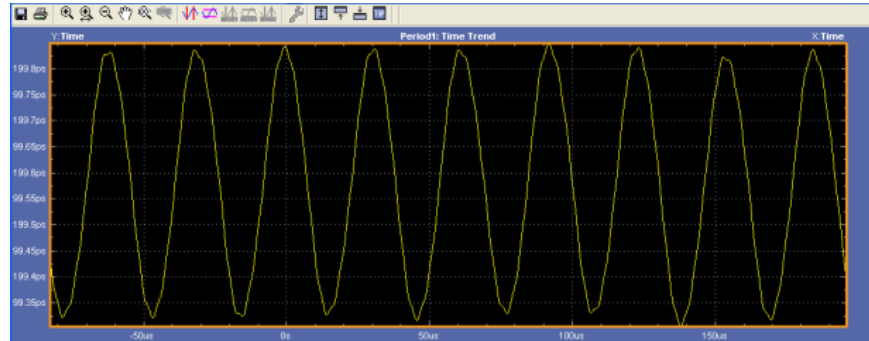

Case 2: A pair of TIE for showing jitter integration caused by SSC and the effect of a high pass filter on SSC spectrum plots:

- Click **Jitter** to select TIE measurement.
- Select *Math1* as the source for both TIE1 and TIE2.

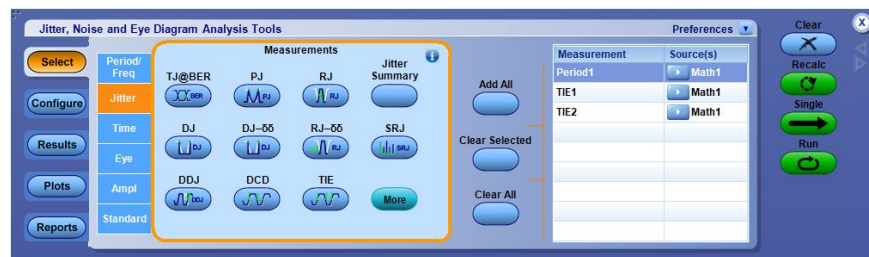

- Click **Configure**. Do the following settings for TIE1 and TIE2 in the Filters configuration tab:
 - Select “No Filter” for TIE1.
 - Select 2nd order High Pass filter for TIE2. In this example, the F1 cut-off frequency is set to 1 GHz.
- Go to Plots. Select Time Trend for both TIE1 and TIE2.
- Select Spectrum plot for both TIE1 and TIE2.
- Click **Single** to run the application. When complete, the result statistics is shown in the results tab.

7. A Plot Summary window shows Time Trend plots for TIE1, TIE2 and Spectrum plots for TIE1, TIE2.

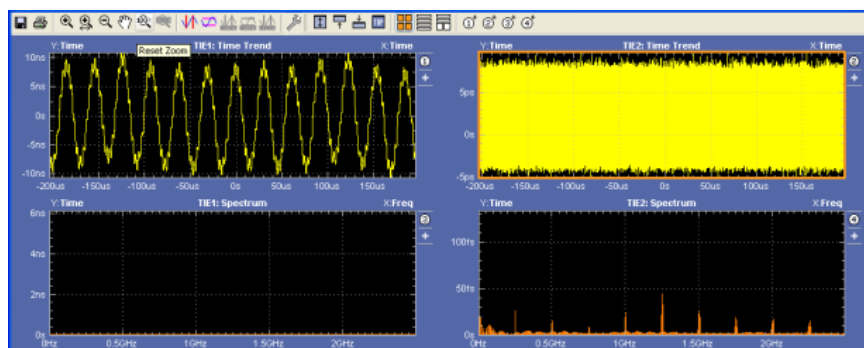

NOTE. You can log result *Statistics*, *Measurement data points* to a *.csv* file and *Worst case waveforms* to a *.wfm* file.

Stopping the tutorial

If you need more than one session to complete the tutorial lessons, you can stop the tutorial and return to it later.

To save the application setup, refer to [Saving a setup file](#). To exit the DPOJET

application, click  present at the right corner of the application.

Returning to the tutorial

To return to the tutorial setup, you can start the application and then recall the saved setup. To recall the application setup, refer to [Recalling a saved setup file](#).

Parameters

About parameters

This section describes the DPOJET application parameters and includes the menu default settings. Refer to the user manual for your oscilloscope for operating details of other controls, such as front-panel buttons.

The parameter tables list the selections or range of values available for each option, the incremental unit of numeric values, and the default selection or value.

Refer to the [GPIB](#) section for a complete list of the GPIB Command Syntax. The topics include a complete list of the GPIB commands along with the arguments, variables, and variable values that correspond to the DPOJET parameters.

Measurement select parameters

The Measurement Select includes the following measurement categories:

- **Period/Freq:** Frequency, Period, CC–Period, N–Period, Pos Width, Neg Width, +Duty Cycle, –Duty Cycle, +CC–Duty, –CC–Duty, and Data Rate.
- **Jitter:** TIE, RJ, DJ, PJ, DDJ, DCD, RJ– $\delta\delta$, DJ– $\delta\delta$, TJ@BER, J2, J9, SRJ, F/N, RJ(h), RJ(v), PJ(h), PJ(v), Jitter Summary, Phase Noise, SJFreq, PJrms, PkPkClkRJ, PkPkClkJDJ, and PkPkClkJTJ.
- **Noise:** RN, RN(v), RN(h), DN, DDN, DDN(1), DDN(0), PN, PN(v), PN(h), NPN, TN@BER, Unit Amplitude, and Noise Summary.
- **Time:** Rise Time, Fall Time, High Time, Low Time, Setup, Hold, Rise Slew Rate, Fall Slew Rate, Skew, SSC Profile, SSC Mod Rate, SSC Freq Dev, SSC Freq Dev Min, SSC Freq Max, and tCMD-CMD.
- **Eye:** Height, Width, Mask Hits, Autofit Mask Hits, Width@BER, Height@BER, Q-Factor, Eye High, Eye Low, AutoFit Mask Hits, and V-Widest Open Eye.

- **Ampl:** High, Low, DC Common Mode, AC Common Mode, High–Low, T/nT Ratio, Overshoot, Undershoot, V–Diff –Xovr, Cycle Min, Cycle Max, Cycle Pk-Pk.
- **Standard:** Standard-specific measurements are as follows:
 - **PCI Express:** PCIe T-Tx-Diff-PP, PCIe T-TX, PCIe T-Tx-Fall, PCIe Tmin-Pulse, PCIe DeEmph, PCIe T-Tx-Rise, PCIe UI, PCIe Med-Mx-Jitter, PCIe T-RF-Mismch, PCIe MAX-MIN Ratio (Custom name is PCIe VRX-MAX-MIN Ratio), PCIe SSC FREQ DEV, PCIe SSC PROFILE, PCIe AC Common Mode.
 - **USB 3.0 Essentials:** USB VTx-Diff-PP, USB TCdr-Slew-Max, USB Tmin-Pulse-Tj, USB Tmin-Pulse-Dj, USB SSC MOD RATE, USB SSC FREQ DEV MAX, USB SSC FREQ DEV MIN, USB SSC PROFILE, USB UI, USB AC Common Mode.
 - **Optical:** AOP, ER, OMA, Optical High, Optical Low, Eye Crossing Level, Eye Crossing Time, Eye Crossing Percent, Mask Hit Ratio, and Mask Margin.

You can set the Source option as any of the following waveforms: Ch1, Ch2, Ch3, Ch4, Ref1, Ref2, Ref3, Ref4, Math1, Math2, Math3, Math4, B1, B2, B3, B4, B5, B6, B7, B8, B9, B10, B11, B12, B13, B14, B15, or B16 (bus source types are applicable for bus measurements only).

Table 82: Source parameters

Option	Parameters	Default
Source1	Ch1-Ch4, Math1-Math4, Ref1-Ref4	Ch1
Source1	B1–B16	User should configure
Source2	Ch1-Ch4, Math1-Math4, Ref1-Ref4	Ch2

Autoset parameters

The Configure Source Autoset includes the following command buttons:

- Vert Scale
- Horiz Res
- Vert & Horiz
- Undo

Ref level menu parameters

The Configure Ref Level menu parameters includes the following command buttons:

- Autoset
- Setup

Option	Parameters	Default setting
Source	Ch1-Ch4, Ref1-Ref4, Math1-Math4	
Autoset	Set, Clear	Set
Rise High	-20 V to 20 V	1 V
Rise Mid	-20 V to 20 V	0 V
Rise Low	-20 V to 20 V	-1 V
Fall High	-20 V to 20 V	1 V
Fall Mid	-20 V to 20 V	0 V
Fall Low	-20 V to 20 V	-1 V
Hysteresis	0 to 10 V	30 mV

Autoset Ref Levels Parameters

Option	Parameters	Default setting
Base Top Method	<ul style="list-style-type: none"> ■ Min-Max ■ Low-High Histogram (Full Waveform) ■ Low- High Histogram (Center of Eye) ■ Auto 	Auto
Rise High	1 to 99%	90%
Rise Mid	1 to 99%	50%
Rise Low	1 to 99%	10%
Fall High	1 to 99%	90%

Option	Parameters	Default setting
Fall Mid	1 to 99%	50%
Fall Low	1 to 99%	10%
Hysteresis	0 to 50%	3%

Preferences parameters

The **Analyze > Jitter and Eye Analysis (DPOJET) > Preferences** includes the following tabs:

- General
- Measurement
- Jitter Decomp
- Path Defaults

Option	Parameters	Default setting
General		
Horizontal Display Units	Seconds, Unit Intervals	Seconds
Vertical Display Units	Volts, Unit Amplitude	Volts
Default Image Type	PNG, JPG, BMP	PNG
Notifier Duration	2 to 20 s	5 s
Measurement		
Limit Rise/Fall measurements to transition bits only	Set, Clear	Clear
Enable high-performance eye rendering	Set, Clear	Set
Halt free-run on a limit failure for any measurement	Set, Clear	Clear
Automatic Transition Density Compensation for PLLs	Set, Clear	Clear
Waveform Interpolation Type	Linear, Sin(x)/x	Linear
Jitter Decomp		
Analysis Method	Jitter Only, Jitter + Noise	Jitter Only
Dual Dirac Model	Fibre Channel, PCI/FB-DIMM	PCI/FB-DIMM
Loc RJ Value	1fs to 1s	1ps
Jitter Separation Model	Spectral Only, Spectral + BUJ	Spectral Only
Minimum # of UI for BUJ Analysis	10K to 9M	200k
Path Defaults		

Option	Parameters	Default setting
Default image export directory	Browser	C:\%USERPROFILE%\Tektronix\TekApplications\DPOJET\Images ¹
Default logging export directory	Browser	C:\%USERPROFILE%\Tektronix\TekApplications\DPOJET\Logs ¹
Default report output directory	Browser	C:\%USERPROFILE%\Tektronix\TekApplications\DPOJET\Reports ¹

Deskew parameters

The **Analyze > Jitter and Eye Analysis (DPOJET) > Deskew** includes the following command buttons:

- Perform Deskew
- Summary

Option	Parameters	Default setting
Reference Channel		
Source	Ch1, Ch2, Ch3, Ch4	Ch1
Mid	-20 V to 20 V	0 V
Hysteresis	0 to 10 V	30 mV
Channel to be Deskewed		
Source	Ch1, Ch2, Ch3, Ch4	Ch2
Mid	-20 V to 20 V	0 V
Hysteresis	0 to 10 V	30 mV
Edges	Rise, Fall, Both	Rise
Deskew Range		
Max Value	-24.9 ns to 25 ns	1 ns
Min Value	-25.0 ns to 24.9 ns	-1 ns

¹ %USERPROFILE% represents your user location.

Data logging parameters

The application includes the following Log menus:

- Statistics
- Measurement
- Worst Case

Option	Parameters	Default
Statistics		
Select Target Measurements	Set, Clear	Set
Log Statistics	Off, On	Off
Data Log File	Browser	C:\%USERPROFILE%\Tektronix\TekApplications\DPOJET\Logs\Statistics ²
Measurement		
Select Target Measurements	Set, Clear	Set
Log Measurements	Off, On	Off
Folder	Browser	C:\%USERPROFILE%\Tektronix\TekApplications\DPOJET\Logs\Measurements ²
Worst Case		
Select Target Measurements	Set, Clear	Set
Log Worst Case Waveforms	Off, On	Off
Folder	Browser	C:\%USERPROFILE%\Tektronix\TekApplications\DPOJET\Logs\Waveforms ²

² %USERPROFILE% represents your user location.

Control panel parameters

The Control Panel menu includes the following command buttons:

- Clear
- Recalc
- Single
- Run
- Show Plots

NOTE. *Show Plots* appears in the control panel only when one or more plots are selected.

Configure measurement parameters

Bit config parameters

The Eye configure menu has the following parameters:

Option	Parameters	Default setting
Bit Type	All Bits, Transition, Non-Transition	All Bits
Mask ³	Browser	C:\Users\Public\Tektronix\TekApplications\DPOJET\Masks
Measure the Center of the Bit ⁴	1 to 100%	For High, Low, High-Low - 1% For all Optical measurements - 20% For all other measurements - 50%
Method ⁴	Mean, Mode	Mean
Measurement range (% UI) ⁶	Start, End, # of Bins	50%, 50%, 1

Mask Hits, Autofit Mask Hits

³ The Mask selector is available only for Mask Hits measurement.

⁴ Available only for High, Low, and High-Low measurements.

⁵ Available for OMA, ER, Optical High, Optical Low, Optical Eye Crossing Level, Optical Eye Crossing Time and Optical Eye Crossing Percent.

⁶ Available only for Height@BER measurement

Option	Parameters	Default setting
Bit Type	All Bits, Transition, Non-Transition	All Bits
Mask ⁷	Browser	C:\Users\Public\Tektronix\TekApplications\DPOJET\Masks
Mask	Absolute, Relative	Absolute
Measure the Center of the Bit ⁸	1 to 100%	For High, Low, High-Low - 1% For all Optical measurements - 20% For all other measurements - 50%
Method ⁴	Mean, Mode	Mean
Measurement range (% UI) ¹⁰	Start, End, # of Bins	50%, 50%, 1

BER parameters The BER configure menu has the following parameters.

Option	Parameters	Default setting
Target BER	BER = 1E-?	12

Edges parameters The Edges configure menu depends on the measurement selected.

Period, Freq, TIE, RJ, RD-dd, TJ@BER, DJ, DJ-dd, PJ, J2, J9, SRJ, Width@BER, RJ(h), RJ(v), PJ(h), PJ(h), Data Rate

Option	Parameters	Default setting
Signal Type	Clock, Data, Auto	Auto
Clock Edge	Rise, Fall, Both	Rise

N-Period

Option	Parameters	Default setting
Signal Type	Clock, Data, Auto	Auto
Clock Edge	Rise, Fall, Both	Rise
N=	1 to 1M	6
Edge Increment	1, 10 K	1

Positive and Negative duty cycle, CC Period

⁷ The Mask selector is available only for Mask Hits measurement.

⁸ Available only for High, Low, and High-Low measurements.

⁹ Available for OMA, ER, Optical High, Optical Low, Optical Eye Crossing Level, Optical Eye Crossing Time and Optical Eye Crossing Percent.

¹⁰ Available only for Height@BER measurement

Option	Parameters	Default setting
Clock Edge	Rise, Fall, Both	Rise

Phase noise

Option	Parameters	Default setting
Active Edge	Rise, Fall, Both	Rise
Noise Integration Limits		
Upper Frequency	0 to 1 T	1 MHz
Lower Frequency	0 to 1 T	0 Hz

DCD

Option	Parameters	Default setting
Signal Type	Clock, Data, Auto	Auto

F/N

Option	Parameters	Default setting
Signal Type	Clock, Data, Auto	Auto
Clock Edge	Rise, Fall, Both	Rise
N=	2, 4, 8	2

Skew

Option	Parameters	Default setting
From Edge	Rise, Fall, Both	Both
To Edge	Same as From, Opposite as From	Same as From

Setup and Hold

Option	Parameters	Default setting
Clock Edge (Source 1)	Rise, Fall, Both	Rise
Data Edge (Source 2)	Rise, Fall, Both	Both

Rise slew rate

Option	Parameters	Default setting
From Level	Mid, Low	Low
To Level	High, Mid	High
Slew Rate Technique	Nominal Method, DDR Method	Nominal Method

Fall slew rate

Option	Parameters	Default setting
From Level	High, Mid	High
To Level	Mid, Low	Low
Slew Rate Technique	Nominal Method, DDR Method	Nominal Method

Time outside level

Option	Parameters	Default setting
Level	High, Low, Both	High
High Ref Voltage	User selectable	0 V

Overshoot/Undershoot

Option	Parameters	Default setting
Ref Voltage	-100 V to 100 V	0 V

V-Diff-Xovr

Option	Parameters	Default setting
Main Edge	Rise, Fall, Both	Both

CrossOver

Option	Parameters	Default setting
Main Edge	Rise, Fall, Both	Both

Clock recovery parameters

The Clock recovery configure menu depends on the clock recovery method being selected.

PLL Clock recovery method parameters.

Option	Parameters	Default setting
PLL Standard BW		
PLL Model	Type I, Type II	Type I
Standard: b/s	IBA2500: 2.5G, PCI-E: 2.5G, PCI_E_GEN2: 5.0G FC133: 132.8M, FC266: 265.6M, FC531: 531.2M, FC1063: 1.063G, FC2125:2.125G, SerATAG1:1.5G, SerATAG2:3.0, SerATAG3:6.0G USB 3.0: 5.0G 1394b S400b: 491.5M, 1394b S800b: 983.0M, 1394b S1600b: 1.966G GB Ethernet: 1.25G 100BaseT:125M OC1:51.8M, OC3:155M, OC12:622M, OC48:2.488G, FC4250:4.25G, FC8500:8.5G IBA_GEN2: 5.0G FBD1:3.2G, FBD2: 4.0G, FBD3: 4.8G XAUI: 3.125G, XAUI_GEN2: 6.25G SAS15:1.5G (no SSC), SAS3: 3.0G (no SSC), SAS6: 6.0G (no SSC), SAS12: 12.0G (no SSC) SAS15:1.5G (SSC), SAS3: 3.0G (SSC), SAS6: 6.0G (SSC), SAS12: 12.0G (SSC) RIO125: 1.25G, RIO250: 2.5G, RIO3125: 3.125G	PCI-E: 2.5G
Damping ¹¹	0.5 to 2	700 m
Loop BW	1 to 2.5 GHz	1.5 MHz
PLL Custom BW		
PLL Model	Type I, Type II	Type I
Loop BW	1 to 2.5 GHz	1.5 MHz

¹¹ Enabled only for Type II PLL models.

Constant clock recovery method parameters.

Option	Parameters	Default setting
Constant Clock-Mean		
Auto Calc	First Acq, Every Acq	Every Acq
Constant Clock-Median		
Auto Calc	First Acq, Every Acq	Every Acq
Constant Clock-Fixed		
Clock Frequency	1 Hz to 25 GHz	2.5 GHz

Explicit clock recovery method parameters.

Option	Parameters	Default setting
Explicit Clock-Edge/Explicit Clock-PLL		
Clock Source	Ch1-Ch4, Ref1-Ref4, Math1-Math4	Ch2
Clock Edge	Rise, Fall, Both	Both
Clock Multiplier	1 to 1 K	1

Advanced clock recovery configuration parameters.

Option	Parameters	Default setting
PLL Custom BW/PLL Standard BW/ Constant Clock-Mean/Constant Clock-Median		
Nominal Data Rate	Auto, Manual	Auto
Bit Rate	0 b/s to 100 Gb/s	Auto TBD Manual 2.5 Gb/s
Known Data Pattern	On, Off	Off
Pattern Filename	Browse	C:\Users\Public\Tektronix\TekApplications\DPOJET\Patterns
Explicit Clock: Edge		
Nominal Clock Offset Relative to Data	Auto, Manual	Manual
Recalculate	Every acquisition, When required	When required
Explicit Clock:PLL		
PLL Method	Type I, Type II	Type I
Damping	0.5 to 2	700 m
Loop B/W	1 Hz to 2.5 GHz	1.5 MHz
Nominal Clock Offset Relative to Data	Auto, Manual (-1s to 1s)	Manual
Recalculate	When required, Every acquisition	When required

SSC parameters The Spread Spectrum Clock menu has the following parameters:

Option	Parameters	Default setting
Nominal frequency		
Auto	Determined by instrument	TBD
Manual	User selectable	2.5 GHz

RJ-DJ analysis parameters The RJ-DJ configure menu has the following parameters:

Option	Parameters	Default setting
Pattern Detection/Control		
Pattern Detection	Auto, Manual	Auto
Pattern Type	Repeating, Arbitrary	Auto TBD Manual Repeating
Pattern Length ¹²	2 UI to 1M UI	2 UI
Window Length ¹³	2 to 24 UI for Jitter Only 2 to 17 UI for Jitter + Noise	10 UI
Target BER		
BER = 1E-? ¹⁴	2 to 18	12

RN-DN analysis parameters The RN-DN configure menu has the following parameters:

Option	Parameters	Default setting
Pattern Detection/Control		
Pattern Detection	Auto, Manual	Auto
Pattern Type	Repeating, Arbitrary	Auto TBD Manual Repeating
Pattern Length ¹²	2 UI to 1M UI	2 UI
Window Length ¹³	2 to 17 UI	10 UI
Target BER		
BER = 1E-? ¹⁵	2 to 18	12

¹² Only for Repeating Patterns.

¹³ Only for Arbitrary Patterns.

¹⁴ Only for TIE, TJ@BER, and Width@BER measurements.

¹⁵ Only for TN@BER.

Filters parameters The Filter configure menu has the following parameters:

Option	Parameters	Default setting
High Pass (F1)		
Filter Spec	No Filter, 1 st order, 2 nd order, 3 rd order	No Filter
Freq (F1)	10 Hz to 1 THz	1 kHz
Low Pass (F2)		
Filter Spec	No Filter, 1 st order, 2 nd order, 3 rd order	No Filter
Freq (F2)	10 Hz to 1 THz	1 kHz

Table 83: Filter configuration for SJ@Freq

Option	Parameters	Default setting
SJ Frequency	10 Hz to 1 THz	100 MHz
SJ Bandwidth	10 Hz to 1 THz	500 kHz

Advanced filter configure parameters. The Advanced Filter Configuration includes the following parameters:

Option	Parameters	Default setting
Ramp Time	0/F to 10/F	2/F
Blanking Time	0/F to 10/F	4/F

Bus state The Bus State configure menu has the following parameters:

Table 84: Bus state options

Option	Parameters	Default setting
Use symbol file	On, Off	On
Enter pattern	On, Off	Off
Symbol	MODE_REG, REFRESH, PRECHARGE, ACTIVATE, WRITE, READ, SRX, DESELECT, SRE, PDE	PDE
Measure at	Clock Edge, Start, Stop	Clock Edge
Clock Source	Ch1, Ch2, Ch3, Ch4, Math1, Math2, Math3, Math4, Ref1, Ref2, Ref3, Ref4	Ch2
Clock Polarity	Rising, Falling	Rising
From Symbol	MODE_REG, REFRESH, PRECHARGE, ACTIVATE, WRITE, READ, SRX, DESELECT, SRE, PDE	MODE_REG

Option	Parameters	Default setting
To Symbol	MODE_REG, REFRESH, PRECHARGE, ACTIVATE, WRITE, READ, SRX, DESELECT, SRE, PDE	MODE_REG
Clock Edge Settings		
To Symbol	MODE_REG, REFRESH, PRECHARGE, ACTIVATE, WRITE, READ, SRX, DESELECT, SRE, PDE	MODE_REG
Measure at	Clock Edge, Start, Stop	Clock Edge

General parameters

The General configure menu has the following parameters:

Option	Parameters	Default setting
Measurement Range Limits	Off, On	Off

Maximum and minimum values vary for different measurements. For more details, refer to [Measurement range limit values](#).

Global parameters

The Global configure menu has the following parameters:

Option	Parameter	Default setting
Gating		
Gating	Off, Zoom, Cursors	Off
Qualify		
Qualify	Off, On	Off
Qualify With Logic		
Source	Ch1-Ch4, Ref1-Ref4, Math1-Math4, Search0-Search8, Burst Search	Ch1
Mid	-20 V to 20 V	0 V
Hysteresis	0 to 10 V	30 mV
Active	High, Low	High
Population		
Population	Off, On	Off
Population Limit		
Limits By	Population, Acquisitions	Acquisitions
Limit	1 to 2 ³¹	1 K
Stop Condition	Each Measurement, Last Measurement	Each Measurement

Margin parameters The margin has the following parameters:

Option	Parameters	Default setting
Hit Ratio	50 μ to 1.5m	50 μ
Hit Count	0 to 10	0
Resolution	1 to 10%	1%

DFE parameters The DFE eye width, eye height, and eye diagram measurements has the following parameters:

Option	Parameters	Default setting
Tap Value	-10v to 10v	0v
Absolute Voltage Level	-1v to 1v	0v
Absolute Time Level	-100ps to 100ps	0s
Measure at V% of the PkPk	1% to 100%	50%
Measure at X% of the UI	1% to 100%	50%
Resolution	0% to 100%	5%

Plots

Histogram plot parameters The Histogram plot has Autoset as the command button.

Option	Parameters	Default setting
Vertical Scale	Log, Linear	Linear
Number of Bins		
Resolution	25, 50, 100, 250, 500	250
Horizontal Scale		
Auto Scale	Set, Clear	Set
Center	-1 ms to 1 Ts	100 ns
Span	1 s to 1 Ts	4 ns

Eye diagram plot parameters

The Eye Diagram plot has the following parameters:

Option	Parameters	Default setting
Mask	On, Off	Off
	Browser	C:\Users\Public\Tektronix\TekApplications\DPOJET\Masks
Horizontal Scale		
Auto Scale	Set, Clear	Set
Resolution	2.00E-13 to 2.00E-08	1.00E-12
Explicit Clock		
Superimpose Reference Clock Eye (if available)	Set, Clear	Clear
Ref Clock Alignment	Auto, Centre and Left	Auto
Interpolation	Interpolation, Non-Interpolation	Interpolation
Compute Mask Hits/Status	Set, Clear	Set

Spectrum plot parameters

The Spectrum plot has the following parameters:

Option	Parameters	Default setting
Vertical Scale	Log, Linear	Log
Base	-20 to 15	-15
Horizontal Scale	Log, Linear	Linear
Mode	Normal, Average, Peak Hold	Normal

Time trend plot parameters

The Time Trend plot has the following parameters:

Option	Parameters	Default setting
Mode	Vector, Bar	Vector

Phase noise plot parameters

The Phase Noise plot has the following parameters:

Option	Parameters	Default setting
Vertical Position		
Baseline	-200 to 0	-170

Bathtub plot parameters

The Bathtub plot has the following parameters:

Option	Parameters	Default setting
Vertical Scale	Log, Linear	Log
Minimum displayed BER= 1E-?	2 to 18 ¹	14
X-Axis Unit	Unit Interval, Seconds	Unit Interval

Transfer function plot parameters

The Transfer Function plot has the following parameters:

Option	Parameters	Default setting
Vertical Scale	Log, Linear	Log
Horizontal Scale	Log, Linear	Log
Mode	Normal, Average	Average

Composite jitter histogram plot parameters

The Composite Jitter Histogram plot has the following parameters:

Option	Parameters	Default setting
Vertical Scale	Log, Linear	Linear
Number of Bins		
Resolution	25, 50, 100, 250, 500	250

¹ Applicable for Log and Linear scale only.

Noise bathtub plot parameters

The noise bathtub plot has the following parameters:

Option	Parameters	Default setting
Horizontal Scale	Log, Linear	Log
Minimum displayed BER = 1E-?	2 to 18 ²	14
Y-Axis Unit	Unit Amplitude, Volts	Unit Amplitude

BER Eye contour plot parameters

The BER eye contour plot has the following parameters:

Option	Parameters	Default setting
Mask	On, Off	Off
	Browser	C:\Users\Public\Tektronix\TekApplications\DPOJET\Masks
BER contours to display	1E-6, 1E-9, 1E-12, 1E-15, 1E-18, Target BER (1E-12)	All BER contours to display will be selected.

Composite noise histogram plot parameters

The composite noise histogram plot has the following parameters:

Option	Parameters	Default setting
Horizontal Scale	Log, Linear	Linear
Noise Components	TN, RN+NPN, PN, DDN(0), DDN(1)	All noise components will be selected
Number of Bins		
Resolution	25, 50, 100, 250, 500, 2000, Maximum	250

² Applicable for Log and Linear scale only.

BER Eye plot parameters

The BER eye plot has the following parameters:

Option	Parameters	Default setting
BER contours to display	1E-6, 1E-9, 1E-12, 1E-15, 1E-18, Target BER (1E-12)	All BER contours to display will be selected.

Correlated Eye plot parameters

The Correlated eye plot has the following parameters:

Option	Parameters	Default setting
BER contours to display	1E-6, 1E-9, 1E-12, 1E-15, 1E-18, Target BER (1E-12)	All BER contours to display will be un-selected.

PDF Eye plot parameters

The PDF eye plot has the following parameters:

Option	Parameters	Default setting
BER contours to display	1E-6, 1E-9, 1E-12, 1E-15, 1E-18, Target BER (1E-12)	All BER contours to display will be selected.

Reports

The Reports menu has the following command buttons:

- Save
- Save As
- Append
- View
- Add/Edit comments

Option	Parameters	Default setting
Auto increment report name if duplicate	Set, Clear	Set
Display units in separate column	Set, Clear	Clear
View report after generating	Set, Clear	Set
Display units in separate column	Set, Clear	Clear
Content To Save		
Include pass/fail results summary	Set, Clear	Set
Include detailed results	Set, Clear	Set
Include plot images	Set, Clear	Set

Option	Parameters	Default setting
Include setup configuration	Set, Clear	Set
Include user comments	Set, Clear	Set
Include complete application configuration	Set, Clear	Set
Save Waveform file(s) along with report	Set, Clear	Clear
Report Name	Browser	C:\%USERPROFILE%\Tektronix\TekApplications\DPOJET\Reports, where %USERPROFILE% represents your user location.

Reference

Progress bar status messages

Function/Measurement module	Status/Message	Description
Autoset-Source Autoset	VertAuto-Chx	Vertical autoset for Chx is going on.
Autoset-Source Autoset	HorizAuto-Chx	Horizontal autoset for Chx is going on.
Autoset-Source Autoset	Zooming Horiz	Zooming the horizontal scale after horizontal autoset.
Autoset-Ref Level Autoset	RefAuto-Chx	Reference level autoset for Chx is going on.
Autoset-Ref Level Autoset	RefAuto-Refx	Reference level autoset for Refx is going on.
Autoset-Ref Level Autoset	RefAuto-Mathx	Reference level autoset for Mathx is going on.
Sequencing	Sequencing	Refers to the measurement setup-edge extraction.
	Measurement Name	Running the measurement specified by name.
Plots	Plotting	Plotting is started.
	Bathtub	Creating Bathtub plot.
	Spectrum	Creating spectrum plot.
	Time Trend	Creating time trend plot.
	Histogram	Creating Histogram plot.
	Transfer Func	Creating Transfer Function plot.
	Eye Mask Hits	Creating Eye Diagram plot.
	Eye Height	Creating Eye Diagram plot.
	Data Array	Creating Data Array plot.
Phase Noise	Creating Phase noise plot.	
Edge Extraction	Finding Edges	Extracting Edges from signal waveform.
Clock Data Recovery	Recovery Clk	Clock and Data recovery.
Worst case logging	Saving WC Wfm	Logging the worst case waveform.
Trigger	Slow Trigger	Waiting for trigger/trigger not available.
Measurements Name	Progress Bar Display	

Function/Measurement module	Status/Message	Description
Amplitude High Low	Ampl High–Low	
Amplitude HighV	Amp High	
Amplitude LowV	Ampl Low	
CMV	Common Mode	
DCD	DCD	
DDJ	DDJ	
DiffXovrV	V-Diff-Xovr	
DJ	DJ	
DJδδ	DJ–δδ	
EdgeExtractor	Edge Extractor	
EyeHeight	Eye Height	
EyeHeightBER	Eye Height@BER	
EyeMaskHits	Eye Mask Hits	
EyeWidth	Eye Width	
EyeWidthBER	Eye Width@BER	
FallTime	Fall Time	
Frequency	Freq	
HighTime	High Time	
Hold	Hold	
LowTime	Low Time	
NegativeDutyCycle	–Duty Cycle	
NegativeDutyCycleCycle	–CC–Duty	
NegativeWidth	Neg Width	
NPeriod	N–Period	
PerCycleCycle	CC–Period	
Period	Period	
PhaseNoise	Phase Noise	
PJ	PJ	
PositiveDutyCycle	+Duty Cycle	
PositiveDutyCycleCycle	+CC–Duty	
PositiveWidth	Pos Width	
RiseTime	Rise Time	
RJ	RJ	
RJδδ	RJ–δδ	
Setup	Setup	
Skew	Skew	
TIE	TIE	
TJ	TJ@BER	

Function/Measurement module	Status/Message	Description
TNTRatio	T/nT Ratio	
TJ@BER	TJ	
NPJ	NPJ	
RJ(H)	RJH	
RJ(V)	RJV	
PJ(H)	PJH	
PJ(V)	PJV	
PJrms	PJrms	
SJ@Freq	SJ@Freq	
SRJ	SRJ	
J2_	J2	
J9_	J9	
F/N	F_N	
RN	RN	
RN (v)	RNV	
RN (h)	RNH	
DN	DN	
DDN	DDN	
DDN0	DDN0	
DDN1	DDN1	
PN	PN	
PN (v)	PNV	
PN (h)	PNH	
NPN	NPN	
TN@BER	TN	
Unit Amplitude	UA	

Breakdown of jitter (Jitter map)

The breakdown of jitter into components such as RJ, PJ and DDJ is model-based. This means that a suitable mathematical model is proposed for the overall jitter, consisting of various jitter components. The components are separable from each other based on observable characteristics, and the rules by which these components combine to form an overall jitter distribution are based on well-understood mathematical principles.

The model used by DPOJET is hierarchical, and is represented by a jitter map. To view the jitter breakdown map, follow the steps:

- Click **Select > Jitter**
- Click the information icon () in the upper right corner of the panel.

NOTE. *If noise measurements are enabled, the Jitter tab is displayed as Jitter/Noise and buttons at the top of the tab allow selection of Jitter or Noise measurements. Select the jitter button () to display the jitter measurements.*

DPOJET displays one of the two different jitter maps depending on the global configuration:

- **Spectral only (default):** A simpler map that does not include NPJ and BUJ categories is used when the decomposition method is set to 'Spectral only'. This offers simpler and faster processing and gives accurate results when crosstalk is not present (and often even when it is present).
- **Spectral + BUJ:** This decomposition method offers an additional model component (Non-Periodic Jitter or NPJ). This jitter model is more accurate when certain types of crosstalk are present. The disadvantage of using this map is that more statistics (that is, a higher population of unit intervals) must be acquired before results can be produced. This may require longer record length, multiple acquisitions, or both.

By clicking the radio buttons in the upper left corner of the map window, you can switch between the two jitter models and their corresponding maps. Once a model has been selected, you can add jitter measurements by clicking directly on the buttons embedded in the map, or dismiss the map and click on the conventional buttons in the main control window.



Figure 5: Jitter map - Spectral Only

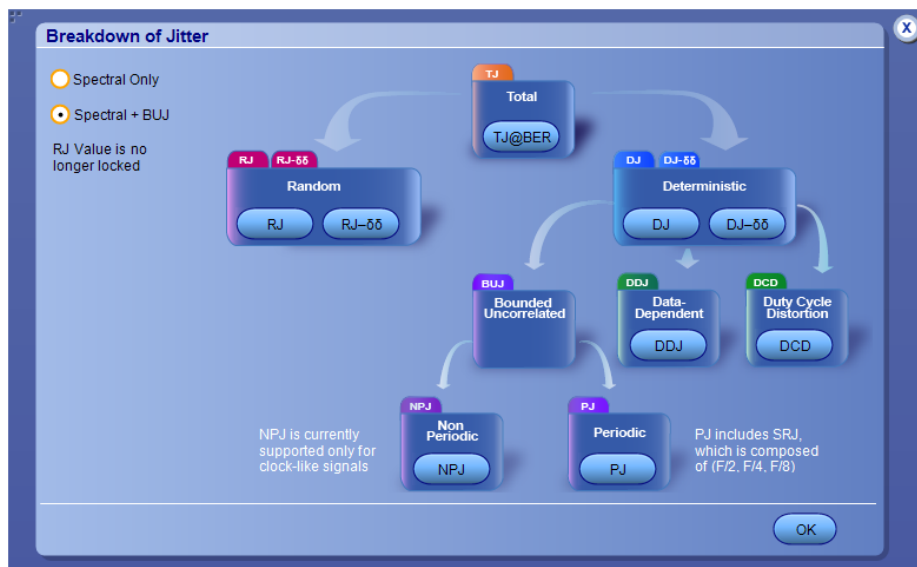

Figure 6: Jitter map - Spectral + BUJ

Related topics

[DPOJET options levels](#)

[Separation of Non-Periodic Jitter \(NPJ\)](#)

Breakdown of noise (Noise map)

The breakdown of noise into components such as RN and DN is model-based. This means that a suitable mathematical model is proposed for the overall noise measurements, consisting of various components. The components are separable from each other based on observable characteristics, and the rules by which these components combine to form an overall noise distribution are based on well-understood mathematical principles.

The model used by DPOJET is hierarchical, and is represented by a noise map. To view the noise breakdown map, follow the steps:

- Click Select > Jitter/Noise and select the noise measurement by radio button. The [Preference setup - Jitter Decomp](#) allows you to enable or disable noise measurements by changing the Analysis Method, if the noise measurement option is available.
- Click the information icon () in the upper right corner of the panel.

NOTE. *If the tab is labeled 'Jitter' and the Jitter and Noise radio buttons are absent, Noise measurements are currently disabled.*

DPOJET displays one of the two different jitter maps depending on the global configuration:

- Spectral only (default): A simpler map that does not include NPN and BUN categories is used when the decomposition method is set to 'Spectral only'. This offers simpler and faster processing and gives accurate results when crosstalk is not present (and often even when it is present).
- Spectral + BUJ: This decomposition method offers an additional model component (Non-Periodic Noise or NPN). This noise model is more accurate when certain types of crosstalk are present. The disadvantage of using this method is that more statistics (that is, a higher population of unit intervals) must be acquired before results can be produced. This may require longer record length, multiple acquisitions, or both.

By clicking the radio buttons in the upper left corner of the map window, you can switch between the two decomposition models and their corresponding maps. Once a model has been selected, you can add noise measurements by clicking directly on the buttons embedded in the map, or dismiss the map and click on the conventional buttons in the main control window.

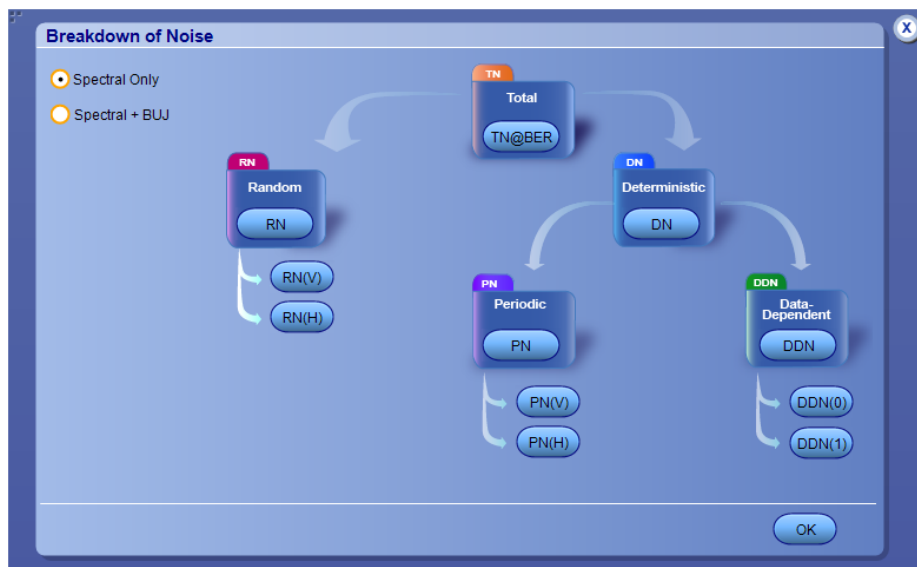

Figure 7: Noise map - Spectral Only

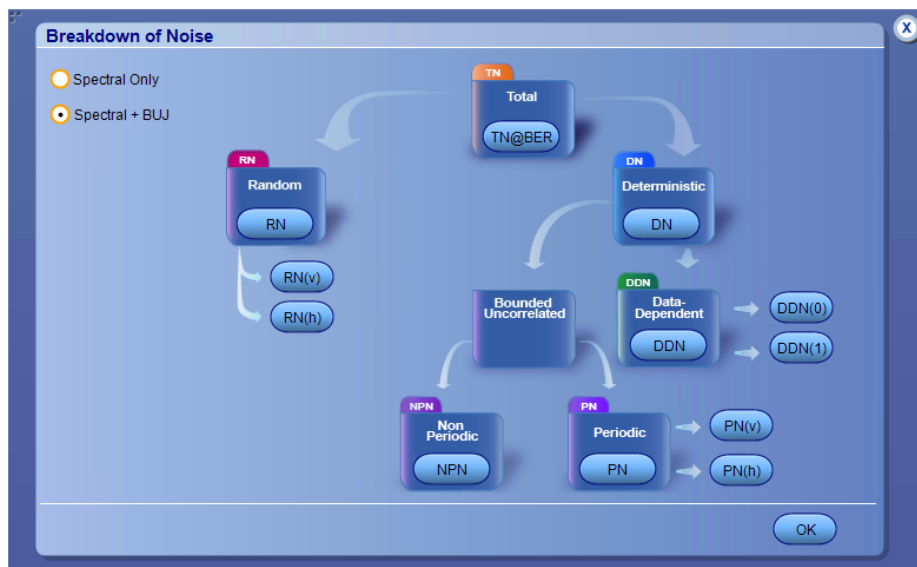

Figure 8: Noise map - Spectral + BUJ

Related topics

[DPOJET options levels](#)

[Separation of Non-Periodic Jitter \(NPJ\)](#)

Error codes

Code	Description
E102	File does not exist
E103	DPOJET is not able to open the help file. In order to use the help file, please reinstall DPOJET.
E104	Mask Hits measurement requires an Eye diagram plot but no more plots can be assigned. Please remove a plot before adding a Mask Hits measurement.
E105	The maximum number of plots you can select is 4.
E106	No Spectrum plot data is available.
E107	This plot type is not configurable.
E108	The SSC-PROFILE measurement requires an Time Trend plot but no more plots can be assigned. Please remove a plot before adding a SSC-PROFILE measurement.
E109	The SSC PROFILE measurement requires an Time Trend plot but no more plots can be assigned. Please remove a plot before adding a SSC PROFILE measurement.
E202	The upper range must be greater than the lower range.
E400	A measurement failed to complete successfully.
W410	Number of edges are not sufficient for a measurement.
E411	In at least one zone, there are too few edges to complete a measurement.
E424	No edges or UI of the required type were found in the waveform. If this is not a clock signal, check the Vref threshold and record length.
E425	No transitions of the selected Bit Type were found in the waveform.
E426	Result has 0 population since all measurement points fall within the PLL's settling time. Either acquire a longer waveform, or increase the PLL's bandwidth.
E427	All waveform samples fall within the PLL's settling time. Either acquire a longer waveform, or increase the PLL's bandwidth.
E500	The record lengths of the source waveforms differ. Please configure for sources with equivalent record lengths.
E1001	Vertical Autoset Failed: Signal on Source x has extreme offset.
E1002	Vertical Autoset Failed: Amplitude of Source x is too small.
E1003	Vertical Autoset Failed: Amplitude or DC offset of Source x is too high.
E1004	Vertical Autoset Failed: No signal on Source x.
E1005	Vertical Autoset Failed: Signal on Source x exceeds top of scale.
E1006	Vertical Autoset Failed: Signal on Source x exceeds bottom of scale.
E1007	Vertical Autoset Failed: Signal on Source x is clipped on top.

Code	Description
E1008	Vertical Autoset Failed: Signal on Source x is clipped on bottom.
E1009	Vertical Autoset Failed: Measurement error (ISDB error code = 6) on Source x.
E1010	Vertical Autoset Failed: Measurement error (ISDB error code = 7) on Source x.
W1011	A change to Source x vertical settings caused overload disconnect. Original settings are restored and Source x is reconnected. Ignore oscilloscope message.
E1012	Vertical Autoset Failed: None of the selected measurements use live sources (Ch1-Ch4). Vertical autoset works for live sources only.
E1013	Vertical Autoset Failed: Invalid signal on Source x.
E1020	Horizontal Autoset Failed: None of the selected measurements use live sources (Ch1-Ch4). Horizontal autoset works for live sources only.
E1021	Horizontal Autoset Failed: On Source x, cannot determine resolution of rising/falling edges.
E1022	Horizontal Autoset Failed: Horizontal resolution is at the maximum.
E1026	Horizontal Autoset Failed: Source amplitude is too low.
E1027	Horizontal Autoset Failed: Signal is clipped at the top - positive clipping.
E1028	Autoset Failed: Signal is clipped at the bottom - negative clipping.
E1029	Horizontal Autoset Failed: Signal frequency is extremely low.
E1035	Oscilloscope has gone into invalid state. Please restart the system.
E1040	Autoset Failed: None of the live sources (Ch1-Ch4) selected.
E1041	Autoset Failed: Unable to trigger
W1051	Ref Level Autoset: Waveform for the source x is clipped.
W1053	Ref Level Autoset: Source amplitude is extremely low.
E1054	Ref Level Autoset: Error in setting reference levels.
E1055	Ref Level Autoset Failed: No waveform to measure.
E1056	Ref Level Autoset: Unstable Histogram for waveform on source x.
E1057	Ref Level Autoset: No selected source.
E1058	Ref Level Autoset Failed: Invalid signal on source x.
E1059	Ref Level Autoset Failed: High/Low Method measures High = Low on.
E1060	Ref Level Autoset Failed: Max/Min Method measures Max = Min on.
E1061	Since Digital Filters (DSP) Enabled, Maximum sampling rate has been retained. To enable adaptive use of lower sampling rate, please choose Analog Only under Vertical->Bandwidth Enhanced.
E1062	The maximum Record Length (RL) in autoset is restricted to 25M, set the RL manually for > 25M.
E1063	The minimum Record Length (RL) in autoset is restricted to 500K, set the RL manually for < 500K.
W1064	Ref Level Autoset: Unable to trigger.
E1065	Ref Level Autoset Failed: Top(Eye High) was calculated as equal or less than Base(Eye Low) for Base Top method Low-High(eye ctr) on

Code	Description
E1066	Ref Level Autoset Failed: Top(High) was calculated as equal or less than Base(Low) for Base Top method
E2001	The maximum number of measurements has been reached.
E2002	All the refs are used as sources by the measurements. Export to Ref is not possible.
E2003	Ref 'x' is already used as a measurement source.
E2004	Ref 'x' is already used as a destination for other measurement.
E2005	No measurement(s) are selected. Export to Ref is not possible.
E2006	No results available to export to ref.
E2007	There are no time trend results for the selected measurement(s).
E2008	No ref destination is selected. Results will not be exported to ref.
E3001	Could not open or create a log file. Please ensure that you have read/write permission to access log folders and files.
E3002	The specified path is invalid (for example, the specified path is not mapped to a drive).
E3003	The specified path, file name or both exceed the system defined length. For example, on Windows-based platforms, the path name must be less than 248 characters and file names less than 260 characters.
E3004	The specified path directory is read-only or is not empty.
E3005	Please ensure that the file is currently not in use by other process and/or has not exceeded the file size limit.
E3006	Invalid filename: Check whether the file name contains a colon (:) in the middle of the string.
E3007	Select at least one measurement from the table before you save.
E3008	There are currently no results to save. Please run a measurement.
E3009	Current statistics is successfully saved at C:\%USERPROFILE%\Tektronix\TekApplications\DPOJET\Logs\Statistics, where %USERPROFILE% represents your user location.
E3010	Access to file/directory denied. Please ensure that the file/directory has read/write permissions.
E3011	Mask Hits Measurements will not be selected as this feature is not available for Mask Hits measurement.
E3012	Folder does not exist.
E4000	Not enough data points. Unable to render plot(s).
E4001	Internal measurement error. Please remove a measurement and try again.
E4002	Not enough data points for spectrum computation.
E4003	Due to high memory usage, only a portion of the waveform could be processed. Please reduce your record length or the number of measurements.
E4004	An error occurred in the edge extraction process.
E4005	Qualifier: The record length and sample interval must match across the waveforms.

Code	Description
E4006	A maximum of 4096 qualifier zones is supported. The entire waveform will not be processed and hence partial measurement results are available.
E4007	Logic Qualifier enabled and no qualifier zones found.
W4008	The configured Ref voltage for Overshoot must be greater than or equal to the mid autosef ref levels.
W4009	The configured Ref voltage for Undershoot must be lesser than or equal to the mid autosef ref levels.
E4010	The preamble has got clipped
E4011	The postamble has got clipped
E4012	The local ref levels could not be calculated due to insufficient edges in burst
E4013	The configured Ref voltage must be greater than or equal to the mid autosef ref levels.
E4014	The configured Ref voltage must be lesser than or equal to the mid autosef ref levels.
E4015 ¹	One or more qualifier zones had too few edges for measurement calculation.
E4016	Not enough edges in the waveform for measurement calculation.
E4017	Qualifier not enabled and hence no qualifier zones found. Please enable the qualifier.
E4018	The preamble is incomplete in all the qualifier zones.
E4019 ¹	The preamble is incomplete in one or more qualifier zones.
E4020	The postamble is incomplete in all the qualifier zones.
E4021 ¹	The postamble is incomplete in one or more qualifier zones.
E4022 ¹	Not enough samples present in the qualifier zones. Please increase the sampling rate and reacquire the waveform.
E4023	The configured ref levels are not correct. The high ref level should be \geq Mid and Mid should be \geq Low for both Rise and Fall slopes. Reconfigure the ref levels and run the measurement.
E4024	Could not compute proper High and Low values.
W4025	The signal does not cross the configured Ref Voltage and hence the result shows zero population. Please adjust the Ref voltage value.
W4026	Command Patterns were not found in the required order.
E4027	From Symbol not found in the acquisition.
E4028	To Symbol not found in the acquisition.
E4029	The configured High Ref voltage must be \geq to the mid autosef ref levels.
E4030	The configured Low Ref voltage must be \leq to the mid autosef ref levels.
E4031	The configured High Ref voltage must be \geq to the mid autosef ref levels and the configured Low Ref voltage must be \leq to the mid autosef ref levels.
E4032	Set up the DDR Search and turn on the Qualifier to run this measurement.
E4033	Required command was not found after the burst.

¹ Displays the zone number for which the preamble/postamble fails.

Code	Description
E4034	Self Refresh Entry command is not registered in the current acquisition.
E4035	Self Refresh Exit command is not registered in the current acquisition.
E4036	Vsw1 voltage point on DQ is not found in one or more zones.
E4037	Vsw2 voltage point on DQ is not found in one or more zones.
E4038	Insufficient Edges in CK source in one or more zones.
E4039	Insufficient Edges in DQ source in one or more zones.
E4040	Invalid configuration, extrapolation voltage should be \geq Vsw2 and $V_{sw2} > V_{sw1}$
E4041	CK rising edge corresponding to the DQ edge is not found in one or more zones
E4042	DQ edge at Vsw1 was not found in one or more zones
E5000	This report cannot be appended because the Append feature is incompatible with this report version. Do you want to overwrite or save as a new report? Press Yes to overwrite. Press No to save as a new report.
E5001	The report contains data. Do you wish to overwrite?
E5002	Cannot save file: There may not be enough free disk space. Delete one or more files to free disk space, and then try again.
E5003	Cannot save some of the waveform file(s) as the application encountered internal error.
E5004	Do you wish to append the current results to
E5005 ²	Occurs while running setup. Please make sure you have finished any previous setup and closed other applications.
W5005	The path or file name exceeds the system limit of 260 characters.
E6001	The measurement cannot show the failed event as failures are not found in the current acquisition.
E6002	The measurement cannot show the failed event as there is a mis-match in waveform and measurement data.
E7001	Error in reading measurement data.
E7002	Error in reading plot data.
E8000	The sequence has been aborted. Please note Zoom min/max may not work as expected
W9005	Derating value calculated using single Slew Rate measurement value.
W9006	Derating value cannot be computed since the calculated Slew Rate is not present in the derating table ³ .
E9007	Derating Error ⁴ .

² This error occurs during DPOJET installation on a DPO/MSO oscilloscope. Delete the Installshield folder under C:\Program files\Common Files and delete all files and folders under C:\Windows\Temp folder. Restart the installation again.

³ Signal Slew Rate value is outside the derating table (Example: If DDR2-800 MT/s tDS derating with a differential probe has a DQS differential slew rate of 0.65 V/ns, this warning message is displayed as the derating table definition starts from 0.8 V/ns).

Derating value is not supported (TBD) in the specification (Example: If the DQS differential slew rate is 2.0 V/ns and the DQ slew rate is 0.7 V/ns, then the value is -(TBD).

Derating will not be applied for the above cases and the base limit will be displayed in the results table.

Measurement range limit values

The following table lists the maximum and minimum values of all measurement range limits:

NOTE. Measurement Range Limits are provided for each measurement under the *General* configure tab of the DPOJET application. The range limits are turned off by default. For two-source measurements such as Skew, Setup, Hold and a few others, these range limits are always ON (OFF is disabled). In these cases, the range limits are used by the algorithms to associate the valid edge of first source to the valid edge of the second source.

Name	Measurement range limits (Max)			Measurement range limits (Min)		
	Default	Max	Min	Default	Max	Min
Period/Freq measurements						
Period	1 ms	1 ks	0 s	0 s	1 ks	0 s
CC-Period	1 ns	1 s	1 fs	-1 ns	-1 fs	-1 s
Freq	10 GHz	50 GHz	1 MHz	1 MHz	50 GHz	1 MHz
N-Period	1 ms	1 ks	0 s	0 s	1 ks	0 s
Pos Width/ Neg Width	10 ns	1 Ms	1 ps	1 ns	1 Ms	1 ps
+Duty Cycle/-Duty Cycle	90 %	100 %	0 %	10 %	100 %	0 %
+CC-Duty/ - CC-Duty	90 %	100 %	100 %	10 %	100 %	0 %
Data Rate	10 Gb/s	50 Gb/s	1 Mb/s	1 Mb/s	50 Gb/s	1 Mb/s
Jitter Measurements						
TIE	1 ns	1 μ s	-1 μ s	-1 ns	1 μ s	-1 μ s
RJ	1 ns	1 μ s	0 s	1 ns	1 μ s	0 s
RJ- $\delta\delta$	1 ns	1 μ s	0 s	0 s	1 μ s	0 s
TJ@BER	1 ns	1 μ s	0 s	0 s	1 μ s	0 s
DJ	1 ns	1 μ s	0 s	0 s	1 μ s	0 s
DJ- $\delta\delta$	1 ns	1 μ s	0 s	0 s	1 μ s	0 s
Phase Noise	1 ms	1 ms	0 s	0 s	1 ms	0 s
DCD	1 ns	1 μ s	0 s	0 s	1 μ s	0 s
DDJ	1 ns	1 μ s	0 ns	0 s	1 μ s	0 s
PJ	1 ns	1 μ s	0 s	0 s	1 μ s	0 s
J2	1 ns	1 μ s	0 s	0 s	1 μ s	0 s

⁴ Slew Rate measurements used to calculate the derated value failed to Run as there are no sufficient edges on the Rise and Fall slopes of the waveform. Base measurement limits are not defined as per the specification.

Name	Measurement range limits (Max)			Measurement range limits (Min)		
	Default	Max	Min	Default	Max	Min
J9	1 ns	1 μ s	0 s	0 s	1 μ s	0 s
F/N	1 ns	1 μ s	0 s	0 s	1 μ s	0 s
SRJ	1 ns	1 μ s	0 s	0 s	1 μ s	0 s
RJ (h)	1 ns	1 μ s	0 s	0 s	1 μ s	0 s
RJ (v)	1 ns	1 μ s	0 s	0 s	1 μ s	0 s
PJ (h)	1 ns	1 μ s	0 s	0 s	1 μ s	0 s
PJ (v)	1 ns	1 μ s	0 s	0 s	1 μ s	0 s
PJrms	1 ns	1 μ s	0 s	0 s	1 μ s	0 s
SJ@Freq	1 ns	1 μ s	0 s	0 s	1 μ s	0 s
PkPkClkTJ	1 ms	1 ks	0 s	0 ms	1 ks	0 s
PkPkClkRJ	1 ms	1 ks	0 s	0 ms	1 ks	0 s
PkPkClkJ	1 ms	1 ks	0 s	0 ms	1 ks	0 s
Noise Measurements						
RN	500 mV	10 V	-10 V	-500 mV	10 V	-10 V
RN (v)	500 mV	10 V	-10 V	-500 mV	10 V	-10 V
RN (h)	500 mV	10 V	-10 V	-500 mV	10 V	-10 V
DN	500 mV	10 V	-10 V	-500 mV	10 V	-10 V
DDN	500 mV	10 V	-10 V	-500 mV	10 V	-10 V
DDN0	500 mV	10 V	-10 V	-500 mV	10 V	-10 V
DDN1	500 mV	10 V	-10 V	-500 mV	10 V	-10 V
PN	500 mV	10 V	-10 V	-500 mV	10 V	-10 V
PN (v)	500 mV	10 V	-10 V	-500 mV	10 V	-10 V
PN (h)	500 mV	10 V	-10 V	-500 mV	10 V	-10 V
NPN	500 mV	10 V	-10 V	-500 mV	10 V	-10 V
TN@BER	500 mV	10 V	-10 V	-500 mV	10 V	-10 V
Unit Amplitude	500 mV	10 V	-10 V	-500 mV	10 V	-10 V
Time Measurements						
Rise Time	200 ns	1 ks	0 s	0 s	1 ks	0 s
Setup	10 ns	1 s	-1 s	0 s	1 s	-1 s
High Time	10 ns	1 Ms	1 ps	0 s	1 Ms	1 ps
Fall Time	200 ns	1 ks	0 s	0 s	1 ks	0 s
Rise Slew Rate	1 V/ns	100 V/ns	1 μ V/ns	0 V/ns	100 V/ns	0 V/ns
Fall Slew Rate	0 V/ns	0 V/ns	-100 V/ns	-1 V/ns	-1 μ V/ns	-100 V/ns
Hold	10 ns	1 s	-1 s	0 s	1 s	-1 s
Low Time	10 ns	1 Ms	1 ps	1 ps	1 Ms	1 ps

Name	Measurement range limits (Max)			Measurement range limits (Min)		
	Default	Max	Min	Default	Max	Min
Skew	10 ns	1 s	-1 s	-10 ns	1 s	-1 s
SSC Profile	1 ms	1 ks	0 s	0 s	1 ks	0 s
SSC Mod Rate	10 kHz	50 GHz	100 Hz	1 kHz	50 GHz	100 Hz
SSC Freq Dev	1 kppm	1 Gppm	-1 Gppm	-1 kppm	1 Gppm	-1 Gppm
SSC Freq Dev Min	1 kppm	1 Gppm	-1 Gppm	-1 kppm	1 Gppm	-1 Gppm
SSC Freq Dev Max	1 kppm	1 Gppm	-1 Gppm	-1 kppm	1 Gppm	-1 Gppm
Time Outside Level	1 ms	1 ks	0 s	0 s	1 ks	0 s
tCMD-CMD	1 ms	1 ks	0 s	0 s	1 ks	0 s
Eye Measurements						
Height	500 mV	1 kV	0 V	50 mV	1 kV	0 V
Height@BER	500 mV	1 kV	0 V	50 mV	1 kV	0 V
Width	1 ns	1 s	0 s	50 ps	1 s	0 s
Mask Hits	500 Hits	1 MHits	0 Hits	0 Hits	1 MHits	0 Hits
Autofit Mask Hits	500 Hits	1 MHits	0 Hits	0 Hits	1 MHits	0 Hits
Width@BER	0.9 UI	1.0 UI	0 UI	0.1 UI	1.0 UI	0 UI
Eye High	500 mV	10 V	-10 V	-500 mV	10 V	-10 V
Eye Low	500 mV	10 V	-10 V	-500 mV	10 V	-10 V
Q-Factor	1 k	1 G	0	0	1 G	0
V-Widest Open Eye	3V	-10V	10V	-3V	-10V	10V
Amplitude Measurements						
DC Common Mode	500 mV	10 V	-10 V	-500 mV	10 V	-10 V
AC Common Mode	500 mV	10 V	-10 V	-500 mV	10 V	-10 V
High	500 mV	10 V	-10 V	-500 mV	10 V	-10 V
T/nt-Ratio	8 dB	12 dB	-12 dB	0 dB	12 dB	-12 dB
High-Low	500 mV	10 V	-10 V	-500 mV	10 V	-10 V
Low	500 mV	10 V	-10 V	-500 mV	10 V	-10 V
V-Diff-Xovr	500 mV	10 V	-10 V	-500 mV	10 V	-10 V
Overshoot	500 mV	10 V	0 V	0 mV	10 V	0 V
Undershoot	500 mV	10 V	0 V	0 V	10 V	0 V

Name	Measurement range limits (Max)			Measurement range limits (Min)		
	Default	Max	Min	Default	Max	Min
Cycle Pk-Pk	500 mV	10 V	-10 V	-500 mV	10 V	-10 V
Cycle Min	500 mV	10 V	-10 V	-500 mV	10 V	-10 V
Cycle Max	500 mV	10 V	-10 V	-500 mV	10 V	-10 V
Standard-Specific Measurements						
PCIe Med-Mx-Jitter	1 ms	1 ks	0 s	0 s	1 ks	0 s
PCIe AC Common Mode	500 mV	10 V	-10 V	-500 mV	10 V	-10 V
PCIe T-RF-Mismch	1 ns	1 ks	0 s	0 s	1 ks	0 s
PCIe MAX-MIN Ratio ⁵	1 V	10 V	-10 V	-1 V	10 V	-10 V
PCIe SSC FREQ DEV	200 ns	1 ks	0 s	0 s	1 ks	0 s
PCIe SSC PROFILE	1 ms	1 ks	0 s	0 s	1 ks	0 s
PCIe-T-Tx-Diff-PP	1 V	10 V	-10 V	-1 V	10 V	-10 V
PCIe T-TX	1 ns	1 s	0 s	50 ps	1 s	0 s
PCIe T-Tx-Fall	200 ns	1 ks	0 s	0 s	1 ks	0 s
PCIe Tmin-Pulse	1 ms	1 ks	0 s	0 s	1 ks	0 s
PCIe DeEmph	8 dB	12 dB	-12 dB	0 dB	12 dB	-12 dB
PCIe T-Tx-Rise	200 ns	1 ks	0 s	0 s	1 ks	0 s
PCIe UI	1 ms	1 ks	0 s	0 s	1 ks	0 s
T-TX-DDJ	1 ns	1 μs	0 s	0 s	1 μs	0 s
T-TX-UTJ	1 ns	1 μs	0 s	0 s	1 μs	0 s
T-TX-UDJDD	1 ns	1 μs	0 s	0 s	1 μs	0 s
T-TX-UPW-TJ	1 ns	1 μs	0 s	0 s	1 μs	0 s
T-TX-UPW-DJDD	1 ns	1 μs	0 s	0 s	1 μs	0 s
V-TX NO-EQ	1.2 V	2 V	0 V	0 V	2 V	0 V
V-TX EIEOS	1.2 V	2 V	0 V	0 V	2 V	0 V

⁵ Custom name for PCIe MAX-MIN Ratio is PCIe VRX-MAX-MIN Ratio.

Name	Measurement range limits (Max)			Measurement range limits (Min)		
	Default	Max	Min	Default	Max	Min
ps21TX	8 dB	12 dB	-12 dB	0 dB	12 dB	-12 dB
V-TX-BOOST	8 dB	12 dB	-12 dB	0 dB	12 dB	-12 dB
USB AC Common Mode	500 mV	10 V	-10 V	-500 mV	10 V	-10 V
USB VTx-Diff-PP	1 V	10 V	-10 V	-1 V	10 V	-10 V
USB TCdr-Slew-Max	200 ns	1 ks	0 s	0 s	1 ks	0 s
USB Tmin-Pulse-Tj	1 ms	1 ks	0 s	0 s	1 ks	0 s
USB Tmin-Pulse-Dj	200 ns	1 ks	0 s	0 s	1 ks	0 s
USB SSC MOD RATE	200 ns	1 ks	0 s	0 s	1 ks	0 s
USB SSC FREQ DEV MAX	200 ns	1 ks	0 s	0 s	1 ks	0 s
USB SSC FREQ DEV MIN	200 ns	1 ks	0 s	0 s	1 ks	0 s
USB SSC PROFILE	1 ms	1 ks	0 s	0 s	1 ks	0 s
USB UI	1 ms	1 ks	0 s	0 s	1 ks	0 s
AOP	500 mW	10 W	-10 W	-500 mW	10 W	-10 W
ER	500 mW	10 W	-10 W	-500 mW	10 W	-10 W
OMA	500 mW	10 W	-10 W	-500 mW	10 W	-10 W
Optical High	500 mW	10 W	-10 W	-500 mW	10 W	-10 W
Optical Low	500 mW	10 W	-10 W	-500 mW	10 W	-10 W
Eye Crossing Level	500 mW	10 W	-10 W	-500 mW	10 W	-10 W
Eye Crossing Time	-1fs	-500as	-1fs	-1ns	1ns	-1ns
Eye Crossing Percent	100%	100%	0%	0%	100%	0%

Measurement units

The following table lists the engineering multipliers that the DPOJET application uses.

Table 85: Measurement units

Abbreviation	Unit	Multiplier
y	yocto or septillionths	1E-24)
z	zepto or sextillionths	1E-21)
a	atto or quintillionths	1E-18)
f	femto or quadrillionths	1E-15)
p	pico or trillionths	1E-12)
n	nano or billionths	1E-09)
u	micro or millionths	1E-06)
m	milli or thousandths	1E-03)
	one	1E+00)
k	kilo or thousands	1E+03)
M	mega or millions	1E+06)
G	giga or billions	1E+09)
T	tera or trillions	1E+12)
P	peta or quadrillions	1E+15)
E	exa or quintillions	1E+18)
Z	zetta or sextillions	1E+21)
Y	yotta or septillions	1E+24)

Custom mask file requirements

DPOJET uses mask definition files that are compatible with TekScope firmware user masks, and consist of ASCII text but are identified with a .msk file extension. Any firmware mask can be saved as a user mask and imported into DPOJET. Alternatively, DPOJET mask files can be manually created using an ASCII text editor such as Notepad, or copied from an existing mask and then edited. DPOJET doesn't require most of the fields found in a TekScope mask file, so the minimum DPOJET mask file is substantially simpler.

The following fields are required:

```
:MASK:USER:SEG1:POINTS x1,y1,x2,y2,x3,y3,x4,y4;
```

```
:MASK:USER:SEG2:POINTS x1,y1,x2,y2,x3,y3,x4,y4;
```

```
:MASK:USER:SEG3:POINTS x1,y1,x2,y2,x3,y3,x4,y4;
```

Seg1 represents the top mask segment, typically used to detect overshoot. Similarly, Seg3 is the base mask segment that detects undershoot. Seg2 is the center-of-eye mask, which typically has four or six vertices. The mask vertices are represented by xy pairs where x is in seconds and y is in volts. All mask segments must be convex. The center of the eye is the time reference point $t = 0$.

For reasons beyond the scope of this document, it is not valid to have ALL time values for ALL segments greater than zero.

The top and base segments can affect the eye diagram scale. The eye diagram will always be scaled such that these segments are fully displayed.

If it is desired to disable a mask segment, use four identical vertices (conceptually describing a rectangle with zero width and zero height). Such a segment will cause no mask hits, although it can still affect eye diagram scaling. For example, `:MASK:USER:SEG1:POINTS 0,4,0,4,0,4,0,4;` would disable the upper segment, but it would force the top edge of the eye diagram to at least +4 V.

All other fields are optional, at the time of this writing, and are ignored by DPOJET. It is possible that future versions of DPOJET software will use additional fields as new features are added to TekScope firmware or DPOJET.

An example mask file is as follows. Only the last three lines are mandatory:

```
:MASK:USER:WID 400.0000E-12;
:MASK:USER:LAB "User Mask";
:MASK:USER:VSCA 200.0000E-3;
:MASK:USER:BITR 2.5000E+9;
:MASK:USER:SEG1:POINTS
-200.0000E-12,600.0000E-3,200.0000E-12,600.0000E-3,200.0000E-
12,800.0000E-3,-200.0000E-12,800.0000E-3;
:MASK:USER:SEG2:POINTS
-140.0000E-12,0.0000,25.8494E-27,-400.0000E-3,140.0000E-
12,0.0000,25.8494E-27,400.0000E-3;
```

:MASK:USER:SEG3:POINTS
 -200.0000E-12,-800.0000E-3,200.0000E-12,-800.0000E-3,200.0000E-12,-
 600.0000E-3,-200.0000E-12,-600.0000E-3;

Correlation of measurement to configuration

The following tables list the configure tabs displayed for each measurement.

Table 86: Period/Freq measurements

UI Name	Measurements	Edges	Bit Config	Clock Recovery	RJDJ	Filters	General	Global
Period	Clock Period	✓				✓	✓	✓
	Data Period					✓	✓	✓
Freq	Clock Frequency	✓				✓	✓	✓
	Data Frequency					✓	✓	✓
Pos Width	Pos Width					✓	✓	✓
Neg Width	Neg Width					✓	✓	✓
N-Period	N-Period	✓					✓	✓
+Duty Cycle	+Duty Cycle	✓				✓	✓	✓
-Duty Cycle	-Duty Cycle	✓				✓	✓	✓
CC-Period	CC-Period	✓				✓	✓	✓
+CC-Duty	+CC-Duty					✓	✓	✓
-CC-Duty	-CC-Duty					✓	✓	✓
Datarate		✓					✓	✓

Table 87: Jitter measurements

UI Name	Measurements	Bit Config	Edges	Clock Recovery	BER	RjDj	Filters	General	Global
TIE	Clock TIE		✓	✓			✓	✓	✓
	Data TIE			✓			✓	✓	✓
TJ@BER	Clock TJ		✓	✓		✓	✓	✓	✓
	Data TJ			✓		✓	✓	✓	✓
DCD	Clock DCD		✓	✓		✓	✓	✓	✓
	Data DCD			✓		✓	✓	✓	✓
RJ	Clock RJ		✓	✓		✓	✓	✓	✓
	Data RJ			✓		✓	✓	✓	✓
RJ (h)			✓	✓		✓	✓	✓	✓
RJ (v)			✓	✓		✓	✓	✓	✓
PJ (h)			✓	✓		✓	✓	✓	✓
PJ (v)			✓	✓		✓	✓	✓	✓
PJrms			✓	✓		✓	✓	✓	✓
SJ@Freq			✓	✓		✓	✓	✓	✓
DJ	Clock DJ		✓	✓		✓	✓	✓	✓
	Data DJ			✓		✓	✓	✓	✓
DDJ	DDJ			✓		✓	✓	✓	✓
RJ-δδ	Clock RJ-δδ		✓	✓		✓	✓	✓	✓
	Data RJ-δδ			✓		✓	✓	✓	✓
DJ-δδ	Clock DJ-δδ		✓	✓		✓	✓	✓	✓
	Data DJ-δδ			✓		✓	✓	✓	✓
PJ	Clock PJ		✓	✓		✓	✓	✓	✓
	Data PJ			✓		✓	✓	✓	✓
SRj	SRj		✓	✓		✓	✓	✓	✓
F/N	F/N		✓	✓		✓	✓	✓	✓
Jitter Summary ¹									

¹ Jitter Summary is not an individual measurement but a convenience function. Pressing this button automatically adds a set of eleven jitter-related measurements with a single action. The measurements are: TIE, RJ, RJ-δδ, DJ, DJ-δδ, PJ, DDJ, DCD, TJ@BER, and Width@BER.

UI Name	Measurements	Bit Config	Edges	Clock Recovery	BER	RjDj	Filters	General	Global
Phase Noise			✓				✓	✓	✓
J2	Clock TJ		✓	✓		✓	✓	✓	✓
	Data TJ			✓		✓	✓	✓	✓
J9	Clock TJ		✓	✓		✓	✓	✓	✓
	Data TJ			✓		✓	✓	✓	✓
PkPkCk RJ				✓			✓	✓	✓
PkPkCk DJ				✓			✓	✓	✓
PkPkCk TJ				✓	✓		✓	✓	✓

Table 88: Noise measurements

UI Name	Measurements	Bit config	RnDn	Clock recovery	Filters	General	Global
RN			✓	✓	✓	✓	✓
RN (v)			✓	✓	✓	✓	✓
RN (n)			✓	✓	✓	✓	✓
DN			✓	✓	✓	✓	✓
DDN			✓	✓	✓	✓	✓
DDN1			✓	✓	✓	✓	✓
DDN0			✓	✓	✓	✓	✓
PN			✓	✓	✓	✓	✓
PN(v)			✓	✓	✓	✓	✓
PN(h)			✓	✓	✓	✓	✓
NPN			✓	✓	✓	✓	✓
TN@BER		✓	✓	✓	✓	✓	✓
Unit Amplitude			✓	✓	✓	✓	✓
Noise summary ²							

² Noise Summary is not an individual measurement but a convenience function. Pressing this button automatically adds a set of eleven noise-related measurements with a single action. The measurements are: RN, DN, PN, DDN, DDN1, DDN0, TN@BER.

Table 89: Timing measurements

Measurements	SSC	Bus State	Edges	Clock Recovery	RJDJ	Filters	General	Global
Rise Time				✓		✓	✓	✓
Fall Time				✓		✓	✓	✓
Skew			✓			✓	✓	✓
High Time						✓	✓	✓
Low Time						✓	✓	✓
Setup			✓			✓	✓	✓
Rise Slew Rate			✓			✓	✓	✓
Fall Slew Rate			✓			✓	✓	✓
Hold			✓			✓	✓	✓
SSC Profile						✓	✓	✓
SSC Mod Rate						✓	✓	✓
SSC Freq Dev	✓			✓		✓	✓	✓
SSC Freq Dev Min	✓			✓		✓	✓	✓
SSC Freq Dev Max	✓			✓		✓	✓	✓
Time Outside Level			✓			✓	✓	✓
tCMD-CMD		✓					✓	✓

Table 90: Eye measurements

Measurements	Bit Config	Edges	Clock Recovery	RNDN	RJDJ	Filters	General	Global
Width			✓				✓	✓
Width@BER		✓	✓		✓	✓	✓	✓
Height	✓		✓				✓	✓
Height@BER	✓		✓	✓		✓	✓	✓
Mask Hits	✓		✓				✓	✓

Measurements	Bit Config	Edges	Clock Recovery	RNDN	RJDJ	Filters	General	Global
Eye High	✓		✓			✓	✓	✓
Eye Low	✓		✓			✓	✓	✓
Q-Factor	✓		✓			✓	✓	✓
AutoFit Mask Hits	✓		✓				✓	✓

Table 91: Amplitude measurements

Measurements	Bit Config	Edges	Clock Recovery	RJDJ	Filters	General	Global
High	✓		✓		✓	✓	✓
DC Common Mode					✓	✓	✓
AC Common Mode					✓	✓	✓
Low	✓		✓		✓	✓	✓
T/nT Ratio			✓		✓	✓	✓
High-Low	✓		✓		✓	✓	✓
V-Diff-Xovr		✓			✓	✓	✓
Overshoot		✓			✓	✓	✓
Undershoot		✓			✓	✓	✓
Cycle Pk-Pk					✓	✓	✓
Cycle Min					✓	✓	✓
Cycle Max					✓	✓	✓

Table 92: Standard-specific measurements

Measurements	Bus State	Bit Config	Edges	Clock Recovery	BER	Filters	General	Global
PCI Express								
PCIe Med-Mx-Jitter			✓	✓		✓	✓	✓
PCIe T-RF-Mismch				✓		✓	✓	✓

Measurements	Bus State	Bit Config	Edges	Clock Recovery	BER	Filters	General	Global
PCIe MAX-MIN Ratio ³				✓			✓	✓
PCIe SSC FREQ DEV				✓		✓	✓	✓
PCIe SSC PROFILE			✓			✓	✓	✓
PCIe T-Tx-Diff-PP				✓			✓	✓
PCIe T-TX				✓			✓	✓
PCIe T-Tx-Fall		✓		✓		✓	✓	✓
PCIe Tmin-Pulse				✓			✓	✓
PCIe DeEmph				✓		✓	✓	✓
PCIe T-Tx-Rise		✓		✓		✓	✓	✓
PCIe UI			✓			✓	✓	
PCIe AC Common Mode						✓	✓	✓
T-TX-DJ				✓			✓	✓
T-TX-UTJ				✓	✓		✓	✓
T-TX-UDJDD				✓	✓		✓	✓
T-TX-UPW-TJ				✓	✓		✓	✓
T-TX-UPWDJDD				✓	✓		✓	✓
V-TX-NO-EQ				✓			✓	✓
V-TX-EIEOS				✓			✓	✓

³ Custom name for PCIe MAX-MIN Ratio is PCIe VRX-MAX-MIN Ratio.

Measurements	Bus State	Bit Config	Edges	Clock Recovery	BER	Filters	General	Global
ps21TX				✓			✓	✓
USB 3.0 Essentials								
USB VTx-Diff-PP				✓			✓	✓
USB TCdr-Slew-Max				✓		✓	✓	✓
USB Tmin-Pulse-Tj				✓			✓	✓
USB Tmin-Pulse-Dj				✓		✓	✓	✓
USB SSC MOD RATE				✓		✓	✓	✓
USB SSC FREQ-DEV MAX				✓		✓	✓	✓
USB SSC FREQ DEV-MIN				✓		✓	✓	✓
USB SSC PROFILE			✓			✓	✓	✓
USB UI			✓			✓	✓	✓
USB AC Common Mode						✓	✓	✓
Optical								
AOP							✓	✓
ER		✓		✓		✓	✓	✓
OMA		✓		✓		✓	✓	✓
Optical High		✓		✓		✓	✓	✓
Optical Low		✓		✓		✓	✓	✓
Eye Crossing Level		✓		✓			✓	✓
Eye Crossing Time		✓		✓			✓	✓

Measurements	Bus State	Bit Config	Edges	Clock Recovery	BER	Filters	General	Global
Eye Crossing Percent		✓		✓			✓	✓
Mask Hit Ratio		✓		✓			✓	✓
Mask Margin		✓		✓			✓	✓

Algorithms

About algorithms

The DPOJET application can take measurements from one or two waveforms. The number of waveforms used by the application depends on the type of measurement being taken.

Oscilloscope setup guidelines

For all measurements, use the following guidelines to set up the oscilloscope:

1. The signal is any channel, reference, or math waveform.
2. The vertical scale for the waveform must be set so that the waveform does not exceed the vertical range of the oscilloscope.
3. The sample rate must be set to capture sufficient waveform detail and avoid aliasing.
4. Longer record lengths increase measurement accuracy but the oscilloscope takes longer to measure each waveform.

Period/Freq measurements

Period **If the Signal Type is Clock.** The Period measurement calculates the duration of a cycle as defined by a start and a stop edge. Edges are defined by polarity, threshold, and hysteresis. The application calculates clock period measurement using the following equation:

$$P_n^{Clock} = T_{n+1} - T_n$$

Where:

PClock is the clock period.

T is the VRefMid crossing time for the selected polarity.

If the Signal Type is Data. The Period measurement calculates the duration of a Unit Interval. The application calculates this measurement using the following equation:

$$P_n^{Data} = (T_n^{Data} - T_{n-1}^{Data}) / K_n$$

Where:

$PData$ is the data period.

$TData$ is the VRefMid crossing time in either direction.

$Kn = Cn - Cn - 1$ is the estimated number of unit intervals between two successive edges. C_n is the calculated data bit index of T_n^{Data} .

Each measurement result P_n^{Data} is repeated K_n times in the measurement result vector, so that the measurement population is equal to the number of unit intervals in the qualified waveform, rather than the number of edge pairs.

Positive and negative width

Amount of time the waveform remains above/below the mid reference voltage level.

The application calculates these measurements using the following equations:

$$W_n^+ = T_n^- - T_n^+$$

$$W_n^- = T_n^+ - T_n^-$$

Where:

$W+$ is the positive pulse width.

$W-$ is the negative pulse width.

$T-$ is the VRefMid crossing on the falling edge.

$T+$ is the VRefMid crossing on the rising edge.

Frequency Frequency measurement calculates the inverse of the data period for each cycle.

If the Signal Type is Clock. The application calculates clock frequency measurement using the following equation:

$$F_n^{Clock} = 1 / P_n^{Clock}$$

Where:

FClock is the clock frequency.

PClock is the clock period measurement.

If the Signal Type is Data. The application calculates data frequency measurement using the following equation:

$$F_n^{Data} = 1 / P_n^{Data}$$

Where:

FData is the data frequency.

PData is the data period measurement.

N-Period **If the Signal Type is Clock.** The N-Period measurement calculates the elapsed time for N consecutive crossings of the mid reference voltage level in the direction specified.

The application calculates this measurement using the following equation:

$$NP_n^{Clock} = T_{n+N}^{Clock} - T_n^{Clock}$$

Where:

*NP**Clock* is the accumulated period for N clock cycles.

TClock is the VRefMid crossing time for the selected edge polarity.

If the Signal Type is Data. The N-Period measurement calculates the elapsed time for N consecutive unit intervals.

The application calculates this measurement using the following equation:

$$NP_n^{Data} = T_{n+N}^{Data} - T_n^{Data}$$

Where:

$NPData$ is the duration for N unit intervals.

$TData$ is the VRefMid crossing time in either direction.

If $T_{n+NData}$ does not exist for a given n, no measurement is recorded for that position.

Positive and negative duty cycle

The +Duty Cycle and -Duty Cycle measurements calculate the ratio of the positive (or negative) portion of the cycle relative to the period.

The application calculates these measurements using the following equations:

$$D_n^+ = W_n^+ / P_n^{Clock}$$

$$D_n^- = W_n^- / P_n^{Clock}$$

Where:

$D+$ is the positive duty cycle.

$D-$ is the negative duty cycle.

$W+$ is the positive pulse width.

$W-$ is the negative pulse width.

$PClock$ is the period.

Related topics.

[Period](#)

[Positive and negative width](#)

CC-Period The CC-Period measurement calculates the difference in period measurements from one cycle to the next.

The application calculates CC-Period measurement using the following equation:

$$\Delta P_n = P_{n+1}^{Clock} - P_n^{Clock}$$

Where:

ΔP is the difference between adjacent periods.

$PClock$ is the clock period measurement.

Positive and negative CC duty The + CC-Duty and – CC-Duty measurements calculate the difference in positive (or negative) pulse widths from one cycle to the next.

The application calculates these measurements using the following equations:

$$\Delta W_n^+ = \Delta W_n^+ - \Delta W_{n-1}^+$$

$$\Delta W_n^- = \Delta W_n^- - \Delta W_{n-1}^-$$

Where:

ΔW^+ is the difference between positive pulse widths of adjacent clock cycles.

ΔW^- is the difference between negative pulse widths of adjacent clock cycles.

W^+ is the positive pulse width measurement.

W^- is the negative pulse width measurement.

Data rate **If the Signal Type is Clock.** The Data Rate measurement calculates the inverse of the mean duration of all cycles defined by the consecutive starting and stopping edges. Edges are defined by polarity, threshold and hysteresis. The application calculates the Data Rate using the following equation:

$$Data\ Rate^{Clock} = 1/\Sigma (T_{n+1} - T_n)$$

If the Signal Type is Data. The Data Rate measurement calculates the inverse of the mean duration of the Unit Intervals in the signal. The application calculates the Data Rate using the following equation:

$$Data\ Rate^{Clock} = 1/\Sigma (T_n - T_{n-1}/K_n)$$

Where:

T_n is the VRefMid crossing time in both direction

K_n is the estimated number of unit intervals in successive edges

Jitter measurements

TIE TIE (Time Interval Error) is the difference in time between an edge in the source waveform and the corresponding edge in a reference clock. The reference clock is usually determined by a clock recovery process performed on the source waveform. For Explicit-Clock clock recovery, the process is performed on an explicitly identified source.

If the Signal Type is Clock. The application calculates Clock TIE measurement using the following equation:

$$TIE_n^{Clock} = T_n^{Clock} - T'_n^{Clock}$$

Where:

TIE_{Clock} is the clock time interval error.

T'^{Clock} is the corresponding edge time for the specified reference clock.

If the Signal Type is Data. The application calculates Data TIE measurement using the following equation:

$$TIE_k^{Data} = T_k^{Data} - T'_k^{Data}$$

Where:

TIE_{Data} is the data time interval error.

T'^{Data} is the corresponding edge time for the specified reference clock.

The subscript k is used to indicate that there is one measurement per actual edge.

RJ Random Jitter (RJ) is the rms magnitude of all timing errors not exhibiting deterministic behavior. A single RJ value is determined for each acquisition, by means of RJ-DJ separation analysis.

RJ(h) RJ(h) is the portion of RJ attributable to random horizontal displacement of the localized waveform. Compare this to RJ(v). Since RJ(h) and RJ(v) are uncorrelated, $RJ = \sqrt{RJ(h)^2 + RJ(v)^2}$.

Related topics. [Joint Jitter/Noise Analysis](#)

[Noise model component interrelationships](#)

RJ(v) RJ(v) is the portion of RJ attributable to random vertical noise. If the waveform slew rate is infinite at each transition, noise would have no effect on the edge timing. Since the waveform slew rate is finite on each transition, some amount of noise is manifested as jitter. Since RJ(h) and RJ(v) are uncorrelated, $RJ = \sqrt{RJ(h)^2 + RJ(v)^2}$.

Related topics. [Joint Jitter/Noise Analysis](#)

[Noise model component interrelationships](#)

Dual dirac random jitter Dual Dirac Random Jitter (RJ- $\delta\delta$) is the rms magnitude of all timing errors not exhibiting deterministic behavior, calculated based on a simplifying assumption that the histogram of all deterministic jitter can be modeled as a pair of equal-magnitude dirac functions (impulses). A single RJ- $\delta\delta$ value is determined for each acquisition, by means of RJ-DJ separation analysis.

Related topics.

[Jitter analysis through RJ-DJ separation](#)

[Jitter estimation using Dual-Dirac models](#)

Jitter summary The Jitter Summary is not a single measurement. The Jitter Summary button on the graphical user interface simply creates one each of all the other jitter measurements, as a convenience. This convenience function is not supported via the programmable interface.

TJ@BER Total Jitter at a specified Bit Error Rate (BER). This extrapolated value predicts a peak-to-peak jitter that will only be exceeded with a probability equal to the BER. It is generally not equal to the total jitter actually observed in any given acquisition. A single TJ@BER value is determined for each acquisition, by means of RJ-DJ separation analysis.

DJ Deterministic Jitter (DJ) is the peak-to-peak amplitude for all timing errors that follow deterministic behavior. A single DJ value is determined for each acquisition, by means of RJ-DJ separation analysis.

Dual Dirac deterministic jitter Dual Dirac Deterministic Jitter (DJ- $\delta\delta$) the peak-to-peak magnitude for all timing errors exhibiting deterministic behavior, calculated based on a simplifying assumption that the histogram of all deterministic jitter can be modeled as a pair of equal magnitude dirac functions (impulses). A single DJ- $\delta\delta$ value is determined for each acquisition, by means of RJ-DJ separation analysis.

Phase noise The Phase Noise measurement performs a jitter measurement, converts the result into the frequency domain, and reports the rms jitter integrated between two specific frequencies selected by the user.

The phase noise measurement is defined only for clock signals. If the source waveform appears to be a data signal, a warning message will be produced but the measurement will proceed.

PJ Periodic Jitter (PJ) is the peak-to-peak amplitude for that portion of the deterministic jitter which is periodic, but for which the period is not correlated with any data pattern in the waveform. A single PJ value is determined for each acquisition, by means of RJ-DJ separation analysis.

PJ(h) PJ(h) is the portion of PJ attributable to periodic horizontal displacement of the waveform. Compare this to PJ(v). For any given frequency, PJ(h) and PJ(v) are correlated and added algebraically. If PJ(h) and PJ(v) are at the same frequency but of opposite phase, one or both can be larger than PJ.

Related topics. [Joint Jitter/Noise Analysis](#)
[Noise model component interrelationships](#)

PJ(v) PJ(v) is the portion of PJ attributable to periodic vertical noise. If the waveform slew rate is infinite at each transition, noise would have no effect on the edge timing. Since the waveform slew rate is finite on each transition, some amount of noise is manifested as jitter. For any given frequency, PJ(h) and PJ(v) are correlated and added algebraically. If PJ(h) and PJ(v) are at the same frequency but of opposite phase, one or both can be larger than PJ.

Related topics. [Joint Jitter/Noise Analysis](#)

[Noise model component interrelationships](#)

NPJ Non-Periodic Jitter (NPJ) is the dual-dirac magnitude of that portion of Bounded Uncorrelated Jitter (BUJ) that is not periodic. Since it is not periodic and is not correlated with the data pattern, NPJ is frequently difficult to distinguish from (Gaussian) RJ.

This component of jitter is not analyzed by default, but you can enable it by switching the jitter analysis mode to Spectral + BUJ. Since it typically requires high populations to distinguish, you may need to acquire multiple waveforms before jitter results are available when Spectral + BUJ mode is enabled.

DDJ Data-Dependent Jitter (DDJ) is the peak-to-peak amplitude for that portion of the deterministic jitter directly correlated with the data pattern in the waveform. A single DDJ value is determined for each acquisition, by means of RJ-DJ separation analysis.

DCD Duty Cycle Distortion (DCD) is the peak-to-peak amplitude for that portion of the deterministic jitter directly correlated with signal polarity, that is the difference between the mean positive edge displacement versus that on negative edges. A single DCD value is determined for each acquisition, by means of RJ-DJ separation analysis.

J2 J2 is Total Jitter at a Bit Error Rate (BER) value of 2.5E-3. This statistical value predicts a peak-to-peak jitter that will only be exceeded with a probability equal to the BER.

J9 J9 is Total Jitter at a Bit Error Rate (BER) value of 2.5E-10. This statistical value predicts a peak-to-peak jitter that will only be exceeded with a probability equal to the BER.

SRJ Sub-Rate Jitter is periodic jitter at a rate that integrally divides the data rate. For example, if the data rate is F bits/second, sub-rate jitter components could occur at F/2 or F/4. It typically occurs when a serial data stream is formed by multiplexing (interleaving) an integral number of lower-rate bit streams together, although there can be other causes. Sub-rate jitter is a sub-component of PJ.

The SRJ measurement is the peak-to-peak amplitude for the sum of all F/N jitter components that are tracked by DPOJET. Since different F/N components are correlated with each other, the peak-to-peak SRJ depends on relative phases and is not simply the sum of the individual F/N components.

The SRJ measurement always tracks and accounts for N = 2, 4 and 8 regardless of whether the corresponding F/N measurements have been selected.

F/N Conceptually, F/N jitter is the peak-to-peak amplitude of periodic jitter occurring at a rate that divides the data rate (F) by the integer N. However, it excludes jitter occurring at harmonics of F/N. For example, F/4 jitter occurs at one fourth the data rate (but the measurement excludes jitter attributable to F/2 before determining the peak-to-peak amplitude).

For a repeating data pattern, some deterministic jitter can be interpreted either as DDJ or as F/N jitter. This condition occurs when the pattern length, P, is an integer multiple of N. By convention, such jitter is reported as DDJ, and the corresponding F/N is reported as zero. For example, a signal with a pattern length of 10 would report F/2 = 0 since jitter at half the bit rate can be interpreted as DDJ. But F/4 and F/8 may be non-zero since they cannot be DDJ for this pattern length.

The measurement uses a divisor (N) of 2 by default but a divisor of 2, 4 or 8 can be selected.

For a given N, the value of F/N is computed as follows:

For a data stream of I bits, the mean jitter for each of the phases $n \in \{1, 2, \dots, N\}$ is calculated as:

$$\bar{J}_n = \frac{1}{K} \sum_{i=0}^{K-1} TIE(n + i * N) \quad \text{where } K = \lfloor I/N \rfloor$$

The jitter-per-phase is collected into a jitter trend or array:

$$T_N = [\bar{J}_1, \bar{J}_2, \dots, \bar{J}_N]$$

From this trend, the trends attributable to higher harmonics are removed (for example, the T2 and T4 trends are subtracted from the T8 trend):

$$U_N = T_N \sum (T_{\text{Harmonic of } N})$$

The peak-to-peak jitter is then:

$$F/N = \max_n (U_N) - \min_n (U_N)$$

From this trend, the trends attributable to higher harmonics are removed (for example, the T2 and T4 trends are subtracted from the T8 trend):

For a repeating data pattern with repeat length N, some deterministic jitter falls in an ambiguous category where it could be interpreted either as DDJ or as F/N jitter. By convention, such jitter is reported as DDJ, and the corresponding F/N is reported as zero.

Related topics.

[*SRJ*](#)

[*Jitter analysis through RJ-DJ separation*](#)

PJrms Periodic Jitter RMS (PJrms) is the root mean square amplitude for that portion of the deterministic jitter which is periodic but for which the period is not correlated with any data pattern in the waveform. A single PJrms value is determined for each acquisition, by means of RJ-DJ separation analysis.

SJ@Freq SJ@Freq is a Sinusoidal Jitter measurement which reports the peak to peak amplitude of energy within the narrow spectral band specified by the user. A single SJ@Freq value is determined for each acquisition, by means of TIE spectral analysis.

Clock Pk-Pk This measurement calculates the peak-to-peak jitter for larger sample sizes of clock signal, similar to jitter tail-fitting procedure. This measurement is specific to only Clock signal as input and is related to the Period measurement only. It also does not support any plots. The measurement computation steps are defined below:

1. Capture the Period of the clock signal and accumulate. Find the Pk-Pk value and Standard deviation value.
2. Capture the Histogram result of the periods.
3. From the histogram data, separate out Random (PkPkClkRJ) and Deterministic (PkPkClkJ) components by tail-fitting procedure.
4. The Pk-Pk jitter (PkPkClkJ) of the BER ¹ is equal to RJ*2*Q@BER+DJ.

Noise measurements

TN@BER Total Noise at a specified Bit Error Rate (BER). This extrapolated value predicts a peak-to-peak vertical eye closure (relative to the estimated bit amplitude) that will only be exceeded with a probability equal to the BER. It is generally not equal to the total vertical closure actually observed in any given acquisition. A single TN@BER value is determined for each acquisition, by means of RN-DN separation analysis.

Related topics. [Joint Jitter/Noise analysis](#)
[Noise model component interrelationships](#)

¹ You can configure the BER values. Example, 10⁻¹⁸, 10⁻¹².

RN Random Noise (RN) is the rms magnitude of all vertical deviations from nominal bit amplitude not exhibiting deterministic behavior. A single RN value is determined for each acquisition, by means of RN-DN separation analysis.

Related topics. *Joint Jitter/Noise analysis*

Noise model component interrelationships

RN(v) RN(v) is the portion of RN attributable to random vertical displacement of the waveform. Compare this to RN(h). Since RN(v) and RN(h) are uncorrelated, $RN = \sqrt{RN(v)^2 + RN(h)^2}$.

Related topics. *Joint Jitter/Noise Analysis*

Noise model component interrelationships

RN(h) RN(h) is the portion of RN attributable to random jitter. If the waveform slew rate is zero across the center of each bit, jitter will have no effect on vertical measurements at this point. But if the waveform slew rate is not zero at the center of each bit, some amount of jitter is manifested as vertical displacement. Since RN(v) and RN(h) are uncorrelated, $RN = \sqrt{RN(v)^2 + RN(h)^2}$.

Related topics. *Joint Jitter/Noise Analysis*

Noise model component interrelationships

DN Deterministic Noise (DN) is the peak-to-peak amplitude for all vertical deviations from nominal bit amplitude that follow deterministic behavior. A single DN value is determined for each acquisition, by means of RN-DN separation analysis.

Related topics. *Joint Jitter/Noise analysis*

Noise model component interrelationships

PN Periodic Noise (PN) is the peak-to-peak amplitude for that portion of the deterministic noise which is periodic, but for which the period is not correlated with any data pattern in the waveform. A single PN value is determined for each acquisition, by means of RN-DN separation analysis.

Related topics. *Joint Jitter/Noise analysis*

Noise model component interrelationships

PN(v) PN(v) is the portion of PN attributable to periodic vertical displacement of the waveform. Compare this to PN(h). For any given frequency, PN(v) and PN(h) are correlated and added algebraically. If PN(v) and PN(h) are at the same frequency but of opposite phase, one or both can be larger than PN.

Related topics. *Joint Jitter/Noise Analysis*

Noise model component interrelationships

PN(h) PN(h) is the portion of PN attributable to periodic jitter. If the waveform slew rate is zero across the center of each bit, jitter will have no effect on vertical measurements at this point. But if the waveform slew rate is not zero at the center of each bit, some amount of jitter is manifested as vertical displacement. For any given frequency, PN(v) and PN(h) are correlated and added algebraically. If PN(v) and PN(h) are at the same frequency but of opposite phase, one or both can be larger than PN.

Related topics. *Joint Jitter/Noise Analysis*

Noise model component interrelationships

DDN(0) Data-Dependent Noise for 0 bits (DDN(0)) is the peak-to-peak amplitude for all bit pattern-correlated vertical variations of low bits from the nominal low level, at the center of the eye. A single DDN(0) value is determined for each acquisition.

Related topics. *Joint Jitter/Noise analysis*

Noise model component interrelationships

DDN(1) Data-Dependent Noise for 1 bits (DDN(1)) is the peak-to-peak amplitude for all bit pattern-correlated vertical variations of high bits from the nominal high level, at the center of the eye. A single DDN(1) value is determined for each acquisition.

Related topics. *Joint Jitter/Noise analysis*

Noise model component interrelationships

DDN Data-Dependent Noise (DDN) is the total vertical eye closure due to bit pattern-correlated vertical variations, at the center of the eye. It is the sum of the positive peak DDN(0) relative to the nominal low level, and the negative peak DDN(1) relative to the nominal high level. A single DDN value is determined for each acquisition.

Related topics. [Joint Jitter/Noise analysis](#)

[Noise model component interrelationships](#)

NPN Non-Periodic Noise (NPN) is the dual-dirac magnitude of that portion of Bounded Uncorrelated Noise (BUN) that is not periodic. Since it is not periodic and is not correlated with the data pattern, NPN is frequently difficult to distinguish from (Gaussian) RN. This component of noise is not analyzed by default, but you can enable it by switching the analysis mode to Spectral + BUJ. Since it typically requires high populations to distinguish, you may need to acquire multiple waveforms before noise results are available when Spectral + BUJ mode is enabled.

Related topics. [Separation of Non-Periodic jitter \(NPJ\)](#)

[Preferences-Jitter decomp](#)

Unit Amplitude The Unit Amplitude is the automatically determined nominal eye amplitude at the horizontal center of the eye. The nominal High level is the mean value of the distribution that represents DDN(1), and the nominal Low level is the mean value of the distribution that represents DDN(0). Unit Amplitude is the difference between these nominal High and Low values, and it is used to normalize all the other noise measurements if the units are switched from absolute to normalized. The actual High and Low levels are not individually reported, but they are depicted on plots such as the BER Eye Contour, PDF Eye, Correlated Eye, using pink dots positioned along a vertical line at the eye center.

Related topics. [Joint Jitter/Noise analysis](#)

[Noise model component interrelationships](#)

Noise summary The Noise Summary is not a measurement. The Noise Summary button on the graphical user interface simply creates one each of all the primary noise measurements, as a convenience. The function is also accessible via the programmable interface.

Timing measurements

Rise time The Rise Time measurement is the time difference between when the VRefHi reference level is crossed and the VRefLo reference level is crossed on the rising edge of the waveform. The Rise Time algorithm uses the VRef values as the reference voltage level. Each edge is defined by the slope, voltage reference level (threshold), and hysteresis.

The application calculates this measurement using the following equation:

$$T_n^{Rise} = T_n^{Hi+} - T_n^{Lo+}$$

Where:

T_{Rise} is the Rise Time.

T_{Hi+} is the VRefHi crossing on the rising edge.

T_{Lo+} is the VRefLo crossing on the rising edge.

Fall time The Fall Time measurement is the time difference between when the VRefLo reference level is crossed and the VRefHi reference level is crossed on the falling edge of the waveform. The Fall Time algorithm uses the VRef values as the reference voltage level. Each edge is defined by the slope, voltage reference level (threshold), and hysteresis.

The application calculates this measurement using the following equation:

$$T_n^{Fall} = T_n^{Lo-} - T_n^{Hi-}$$

Where:

T_{Fall} is the Fall Time.

T_{Lo-} is the VRefLo crossing on the falling edge.

T_{Hi-} is the VRefHi crossing on the falling edge.

Skew Skew is the time between the mid reference level crossing on Source1 to the mid reference level crossing on Source2. The direction of the edge crossing is configurable.

The application calculates this measurement using the following equation:

$$T_n^{Skew} = T_n^{Main} - T_n^{2nd}$$

Where:

T_{Skew} is the timing skew.

T_{Main} is the Main input Mid reference crossing time in the configured direction.

T_{2nd} is the 2nd input Mid2 reference crossing time in the configured direction.

High time The High Time Measurement is the amount of time that a waveform cycle is above the High reference voltage level.

The application calculates the measurement using the following equation:

$$T_n^{High} = T_n^{Hi-} - T_n^{Hi+}$$

Where:

T_{High} is the high time.

T_{Hi-} is the High reference crossing on the falling edge.

T_{Hi+} is the High reference crossing on the rising edge.

Low time The Low Time measurement is the amount of time that a waveform cycle is below the Low reference voltage level.

The application calculates this measurement using the following equation:

$$T_n^{Low} = T_n^{Lo+} - T_n^{Lo-}$$

Where:

T_{Low} is the low time.

T_{Lo+} is the Low reference crossing on the rising edge.

T_{Lo-} is the Low reference crossing on the falling edge.

Setup Setup Time is the time between the mid reference level crossing of the clock source (Source1) and the closest previous mid reference level crossing of the data source (Source2). The crossings (edges) may be configured to be rising, falling or either.

The application calculates this measurement using the following equation:

$$T_n^{Setup} = T_i^{Main} - T_n^{2nd}$$

Where:

T_{Setup} is the setup time.

T_{Main} is the Main input (clock) Mid reference crossing time in the specified direction.

T_{2nd} is the 2nd input (data) Mid2 reference crossing time in the specified direction.

Rising Slew Rate measurement algorithm

The Rise Slew Rate is defined as the rate of change of the voltage between the crossings of the specified V_{REFHI} and V_{REFLO} reference voltage levels. The voltage difference is measured between the V_{REFHI} reference level crossing and the V_{REFLO} reference level crossing on the rising edge of the waveform. The time difference is measured as the difference between the low time, and the low time at which V_{REFLO} and V_{REFHI} are crossed. The Rise Slew Rate algorithm uses the high and low rise reference voltage levels to configure the values. Each edge is defined by the slope, voltage reference level (threshold), and the hysteresis.

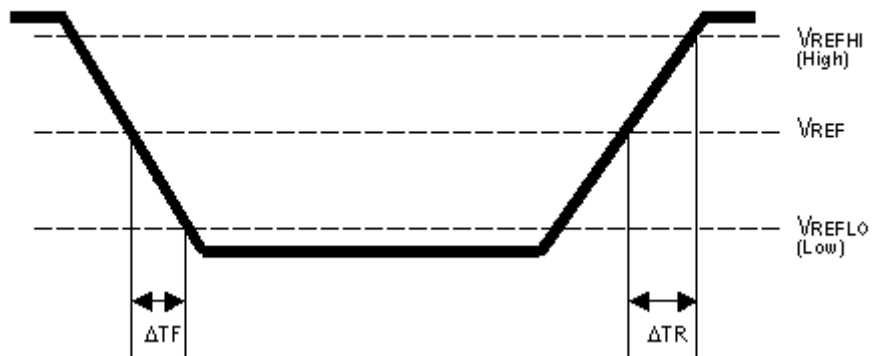

The application calculates this measurement using the following equation:

$$\text{Rise Slew Rate} = \frac{V_{\text{REFHI}} - V_{\text{REFLO}}}{\Delta T_R}$$

Fall slew rate The Fall Slew Rate is defined as the rate of change of the voltage at the specified V_{REFLO} and V_{REFHI} reference voltage levels. The voltage difference is measured between the V_{REFLO} reference level crossing and the V_{REFHI} reference level crossing on the falling edge of the waveform. The time difference is measured as the difference between the high time and low time at which V_{REFHI} and V_{REFLO} are crossed. The Fall Slew Rate algorithm uses the low time and high fall reference voltage levels to configure the values. Each edge is defined by the slope, voltage reference level (threshold), and the hysteresis.

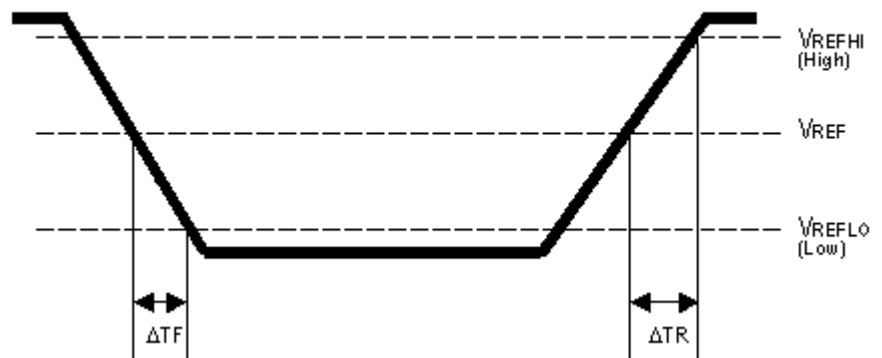

The application calculates this measurement using the following equation:

$$\text{Fall Slew Rate} = \frac{V_{\text{REFLO}} - V_{\text{REFHI}}}{\Delta T_F}$$

Hold The Hold Time measurement is the elapsed time between when the clock waveform crosses its own voltage reference level and the designated edge of a data waveform. The closest data edge to the clock edge that falls within the range limits is used.

The application calculates this measurement using the following equation:

$$T_n^{Hold} = T_n^{2nd} - T_i^{Main}$$

Where:

T_{Hold} is the hold time.

T_{Main} is the Main input (clock) Mid reference crossing time in the specified direction.

T_{2nd} is the 2nd input (data) Mid2 reference crossing time in the specified direction.

NOTE. *The order of the input sources for Setup and Hold measurements (Source1 = Clock, Source2 = Data) differs from the order of input sources on the Setup/ Hold Trigger menu in the oscilloscope.*

SSC profile SSC Profile shows the modulation profile of the Spread Spectrum Clocking (SSC). It is the time trend plot of the SSC profile. All SSC measurements use the Period measurement with a second order low pass filter. Using the profile you can analyze the SSC modulation rate by using the horizontal cursors. You can also analyze the peak-to-peak frequency deviation by using the vertical cursors.

The following are the default configurations that are required:

- Constant Clock Recovery (CCR) Mean set as the Clock Recovery method.
- Low pass filter with 1.98 MHz cut off frequency set by default. This is the standard FiberChannel cut off frequency.
- Available plots are Time Trend, Data Array, Histogram and Spectrum plots.

- SSC MOD rate** SSC Modulating Rate is the modulating frequency of a spread spectrum clock. It is the rate that the clock frequency changes.
- Clock recovery is used on the measurement. The method is constant clock mean.
- SSC FREQ DEV MIN** The SSC FREQ DEV MIN is defined as the minimum frequency shift as a function of time. It represents the frequency deviation in terms of ppm (parts per million).
- Find the 50% edges on the SSC profile.
 - Calculate the LOW value between the n and n+1 edge.
 - Find the Minimum frequency deviation as LOW.
- The application calculates the measurement using the equation:
- $$Freq\ Dev\ Min(ppm) = ((Minimum\ Freq - Nominal\ Data\ Rate) / Nominal\ Data\ Rate) * 1e6$$
- Available plots are Time Trend, Data Array, Histogram and Spectrum plots.
- SSC FREQ DEV MAX** SSC FREQ DEV MAX is defined as the maximum frequency shift as a function of time. It represents the frequency deviation in terms of ppm (parts-per-million).
- Find the 50% edges on the SSC profile
 - Calculate the HIGH value between the n and n+1 edge
 - Find the Maximum frequency deviation as HIGH
- The application calculates the measurement using the equation:
- $$Freq\ Dev\ Max(ppm) = ((Maximum\ Freq - Nominal\ Data\ Rate) / Nominal\ Data\ Rate) * 1e6$$
- The difference between the SSC FREQ DEV MAX and SSC FREQ DEV MIN measurements are that they compute the maximum frequency deviation and minimum frequency deviation separately. By doing this the limits can be applied separately.
- Available plots are Time Trend, Data Array, Histogram and Spectrum plots.
- SSC FREQ DEV** SSC Freq Dev is the spread spectrum clock frequency deviation from the nominal frequency in ppm (parts per million).
- Clock recovery is used on the measurement. The method is constant clock mean.

tCMD-CMD

tCMD-CMD measures the elapsed time between two bus states, for example CMD_1 and CMD_2. For each state, the relevant timing point can be specified as the start of the state, the end of the state, or a rising or falling edge on a separately-specified clock source. The timing resolution of this measurement is dependent on the sample clock used. For example, if the bus is composed of digital channels sampled as 12.5 Gsps, the resolution is 80 ps.

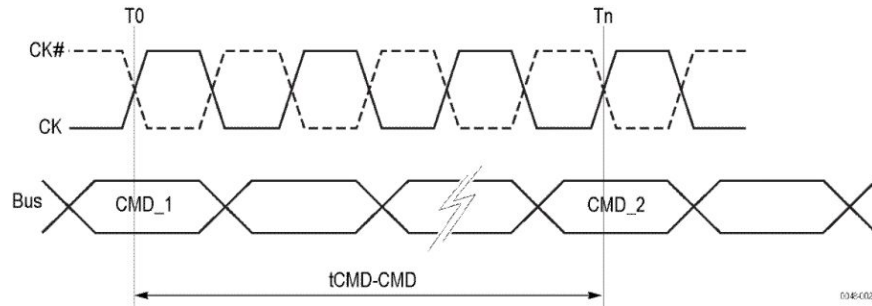

Time Outside Level measurement algorithm

Time Outside Level is the time the signal remains above the high reference level and/or below the low reference level.

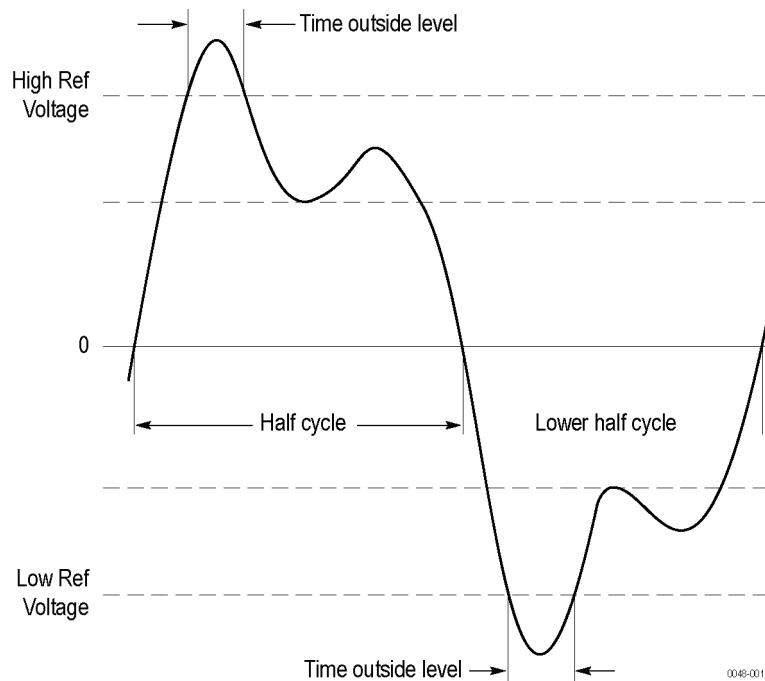

Eye diagram measurements

Eye width The Eye Width measurement is the measured minimum horizontal eye opening at the zero reference level.

The application calculates this measurement using the following equation:

$$T_{EYE-WIDTH} = UI_{AVG} - TIE_{pk-pk}$$

Where:

UI_{AVG} is the average UI.

TIE_{pk-pk} is the Peak-Peak TIE.

Width@BER Width@BER is the Eye Width at a specified Bit Error Rate (BER). This extrapolated value predicts a horizontal eye opening that will be violated with a probability equal to the BER. It is generally not equal to the eye width actually observed in any given acquisition. A single Width@BER value is determined for each acquisition, by means of RJ-DJ separation analysis.

Eye height The Eye Height measurement is the measured minimum vertical eye opening at the UI center as shown in the plot of the eye diagram. There are three types of Eye Height values.

The application calculates this measurement using the following equation:

$$V_{EYE-HEIGHT} = V_{EYE-HI-MIN} - V_{EYE-LO-MAX}$$

Where:

$VEYE-HI-MIN$ is the minimum of the High voltage at mid UI.

$TIEEYE-LO-MAX$ is the maximum of the Low voltage at mid UI.

Eye Height-Transition. The application calculates this measurement using the following equation:

$$V_{EYE-HEIGHT-TRAN} = V_{EYE-HI-TRAN-MIN} - V_{EYE-LO-TRAN-MAX}$$

Where:

VEYE-HI-TRAN-MIN is the minimum of the High transition bit eye voltage at mid UI.

TIEEYE-LO-TRAN-MAX is the maximum of the Low transition bit eye voltage at mid UI.

Eye Height-Non-Transition. The application calculates this measurement using the following equation:

$$V_{EYE-HEIGHT-NTRAN} = V_{EYE-HI-NTRAN-MIN} - V_{EYE-LO-NTRAN-MAX}$$

Where:

VEYE-HI-NTRAN-MIN is the minimum of the High non- transition bit eye voltage at mid UI.

TIEEYE-LO-NTRAN-MAX is the maximum of the Low non-transition bit eye voltage at mid UI.

Height@BER

Height@BER is the Eye Height at a specified Bit Error Rate (BER). This extrapolated value predicts a vertical eye opening that will be violated with a probability equal to the BER. It is generally not equal to the eye height actually observed in any given acquisition. A single Height@BER value, in the given interval, is determined for each acquisition by means of Q-scale extrapolation.

Eye high Eye High calculates the voltage at a selected horizontal position across the unit interval, for all High bits in the waveform. You specify the offset at which the measurement takes place from 0% to 100% of the unit interval. Configure the measurement to include all bits, only transition bits, or only non-transition bits. (Note that some of the waveform can be omitted from the measurement due to initialization of clock recovery or filtering.) A histogram of the Eye High measurement corresponds to a vertical slice through the upper half of a three-dimensional eye diagram.

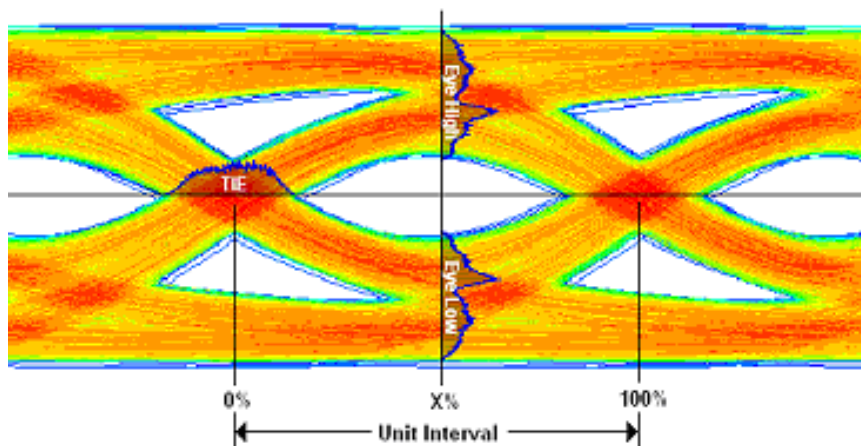

NOTE. This illustration shows how the measurement is made, and does not represent how the oscilloscope actually displays an eye diagram or histograms on an eye diagram plot.

Eye low Eye Low calculates the voltage at the selected horizontal position across the unit interval, for all Low bits in the waveform. A histogram of the Eye Low measurement corresponds to a vertical slice through the lower half of a three-dimensional eye diagram.

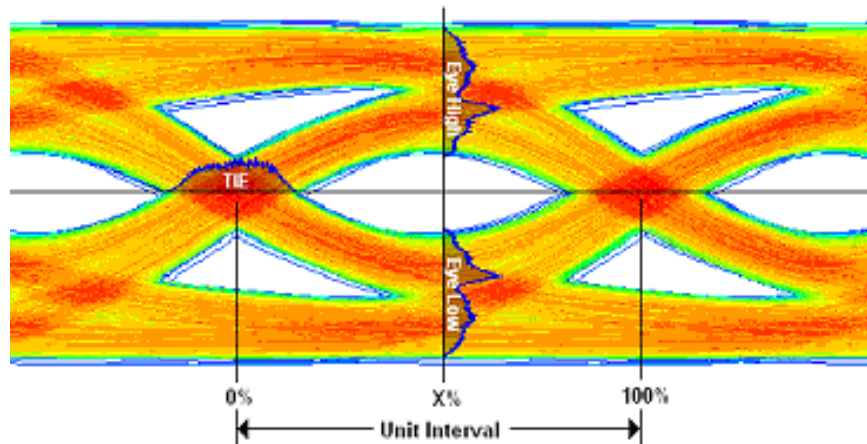

NOTE. This illustration shows how the measurement is made, and does not represent how the oscilloscope actually displays an eye diagram or histograms on an eye diagram plot.

Q-factor Quality Factor is the ratio of eye size to noise.

The final measurement value would be computed according to the equation below:

$$\text{Q-factor} = [\text{mean}(\text{EyeHigh}) - \text{mean}(\text{EyeLow})] / [\text{stddev}(\text{EyeHigh}) + \text{stddev}(\text{EyeLow})]$$

Where:

Eye High: the sample values of positive UI at x%.

Eye Low: the sample values of negative UI at x%.

For more details refer Eye Height

Mask hits The Mask hits measurement reports the number of unit intervals in the acquisition for which mask hits occurred, for a user-specified mask. In the Results Summary view, the Mask hits measurement reports the total number of unit intervals for which a mask hit occurred in at least one mask zone. In the Results Details view, the number of hits in each of three segments is reported.

The Mask hits measurement has several unique properties:

- Unlike other measurements, it requires a Mask hits plot. Adding a Mask hits measurement will cause the corresponding plot to be created automatically. If you delete a Mask hits plot, the application will remove the corresponding Mask hits measurement after verifying the action with you.
- The Mask hits measurement does not support the Worst-Case Waveforms logging feature.
- The Mask hits measurement does not support Measurement Range Limits.
- The Mask hits measurement does not support Population Limit.

Autofit mask hits Autofit Mask hits measurement reports the number of pixels in the acquisition for which mask hits occurred, for a user specified mask. In the results summary view, Autofit Mask Hits measurement reports the total number of Pixel Hits for which a mask hit occurred. In the Results Details View, the number of hits in each of three segments is reported. The population field shows the total number of unit intervals measured.

The AUTOFIT Mask Hits measurement has several unique properties:

- Unlike other measurements, it requires a Mask hits plot. Adding an Autofit Mask Hits measurement will cause the corresponding plot to be created automatically. If you delete a Mask Hits plot, the application will remove the corresponding Autofit Mask Hits measurement after verifying the action with you.
- The Autofit Mask Hits measurement does not support Worst-Case Waveforms logging.
- The Autofit Mask Hits measurement does not support Measurement Range Limits.

V-Widest Open Eye V-Widest Open Eye measurement measures the voltage at the widest eye opening in the search range from 40% to 60% of the eye amplitude.

The detailed procedure for the V-Widest open Eye requires the following:

- The Voltage level search range is from 40% to 60% of the eye amplitude (eye height measured at the center of the eye diagram).
- Scan for the widest eye opening at the mentioned search range. Use the voltage level at the widest eye opening as the result of V-Widest Open eye.

- DFE eye height** This measurement calculates the eye height non-parametrically based on the rendered eye diagram. The eye height measurement could be controlled by configuring the following parameters.
- X% of UI defines the exact time point (expressed as % of time range) in the horizontal scale to measure the eye height.
 - Resolution defines the window around the V% to search for the maximum height.

NOTE. *Select Absolute Voltage Level to enter the value in absolute instead of relative percentage.*

- DFE eye width** This measurement calculates the eye width non-parametrically based on the rendered eye diagram. The eye width measurement could be controlled by configuring the following parameters.
- V% of Pk-Pk defines the exact voltage point (expressed as % of max voltage) in the vertical scale to measure the eye width.
 - Resolution defines the window around the V% to search for the maximum width.

NOTE. *Select Absolute Voltage Level to enter the value in absolute instead of relative percentage.*

- DFE eye diagram** This measurement calculates the rendered eye diagram with specified mask. If a valid mask is present, then it returns the mask hit obtained after the rendering.

Amplitude measurements

High The High Amplitude measurement calculates the nominal amplitude of a “1” bit, in one of two ways depending on the selected Method. Note that the Mean method results in one measurement value for each “1” bit of the selected type, whereas the Mode method results in a single measurement value for the entire waveform record.

When the Method = Mean, the measurement is calculated using the following equation:

$$V_n^{Hi} = Mean[v_n^{percent}]$$

Where:

V^{Hi} is the high amplitude measurement result.

$v_n^{percent}$ is the set of all waveform samples for event n falling within the selected portion (percent) of the unit interval, ranging from 1% to 100%. If no waveform samples fall within the window for a given unit interval, the single sample nearest in time to the window is taken.

n is the index of a high bit, a high transition bit, or a high non-transition bit.

When the Method = Mode, the measurement is calculated using the following equation:

$$V^{Hi} = Mean[v_n^{present}]$$

Where $v^{present}$ represents a single histogram containing all the waveform samples selected according to the same windowing and transition type criteria as in the Mean method.

Low The Low Amplitude measurement calculates the nominal amplitude of a “0” bit, in one of two ways depending on the selected Method. Note that the Mean method results in one measurement value for each “0” bit of the selected type, whereas the Mode method results in a single measurement value for the entire waveform record.

When the Method = Mean, the measurement is calculated using the following equation:

$$V_n^{Lo} = Mean[v_n^{percent}]$$

Where:

V^{Lo} is the low amplitude measurement result.

$v_n^{percent}$ is the set of all waveform samples for event n falling within the selected portion (percent) of the unit interval, ranging from 1% to 100%. If no waveform samples fall within the window for a given unit interval, the single sample nearest in time to the window is taken.

n is the index of a low bit, a low transition bit, or a low non-transition bit.

When the Method = Mode, the measurement is calculated using the following equation:

$$V^{Lo} = Mean[v_t^{percent}]$$

Where $v^{present}$ represents a single histogram containing all the waveform samples selected according to the same windowing and transition type criteria as in the Mean method.

DC common mode The Common Mode Voltage measurement (also called DC Common Mode) calculates the mean of the Common Mode voltage waveform.

The application calculates this measurement using the following equation:

$$V_{CM} = Mean(v_{CM}(i))$$

Where:

V_{CM} is the common mode voltage measurement.

$$v_{CM} = \frac{(v_{Source 1} + v_{Source 2})}{2}$$

is the common mode voltage waveform.

i is the sample index of common mode waveform values.

AC common mode The AC Common Mode Voltage measurement is the common mode voltage between two single-ended signals. AC is defined as all the frequency components above the cutoff frequency (30 kHz).

The application calculates this measurement using the following equations (based on two single-ended sources from the DUT):

$$CM_Voltage = (Source1 + Source2) \div 2$$

$$AC_CMM_{p-p} = Peak\text{-to-Peak}(\text{High Pass filter}(CM_Voltage))$$

Where:

AV_CMM_{p-p} is the peak-to-peak common mode voltage.

T/nT ratio The T/nT Ratio measurement reports the amplitude ratio between transition and non-transition bits.

The measurement calculates the ratios of all non-transition eye voltages (2nd and subsequent eye voltages after one edge but before the next) to their nearest preceding transition eye voltage (1st eye voltage succeeding an edge). In the accompanying diagram, it is the ratio of the Black voltages to the Blue voltages. The results are given in dB.

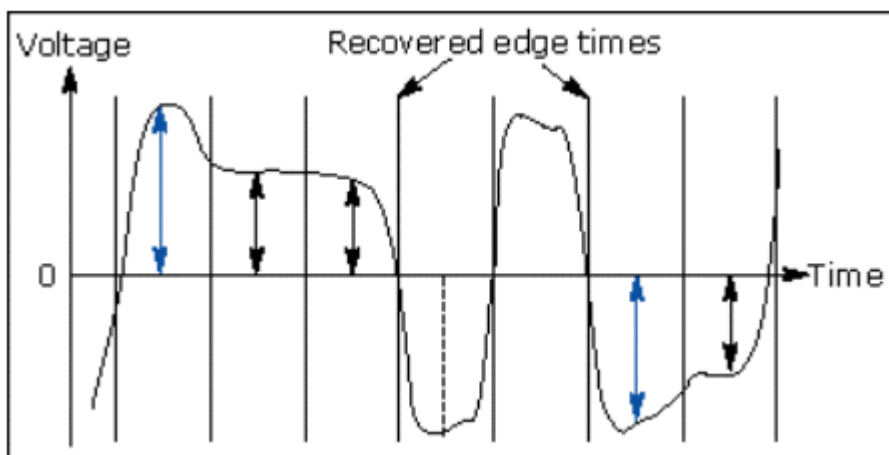

The application calculates the T/nT Ratio using the following equations:

$$TnT(m) = dB \left(\frac{v_{EYE-HI-NTRAN}(m)}{v_{EYE-HI-TRAN}(n)} \right)$$

following a rising edge.

$$TnT(m) = dB \left(\frac{v_{EYE-LO-NTRAN}(m)}{v_{EYE-LO-TRAN}(n)} \right)$$

following a falling edge.

Where:

$v_{EYE-HI-TRAN}$ is the High voltage at the interpolated midpoint of the first unit interval following a positive transition.

$v_{EYE-LO-TRAN}$ is the Low voltage at the interpolated midpoint of the first unit interval following a negative transition.

$v_{EYE-HI-NTRAN}$ is the High voltage at the interpolated midpoint of all unit intervals except the first following a positive transition.

$v_{EYE-LO-NTRAN}$ is the Low voltage at the interpolated midpoint of all unit intervals except the first following a negative transition.

m is the index for all non-transition UIs.

n is the index for the nearest transition UI preceding the UI specified by m .

In a time trend plot of the measurement results, there is one measurement for each non-transition bit in the waveform (that is the black arrows in the diagram).

High-Low High – Low is the difference between High and Low amplitude measurements that bound each selected transition. The value is always expressed as a positive number regardless of whether the transition is rising or falling. Note that the Mean method results in one measurement value for each selected transition, whereas the Mode method results in a single measurement value for the entire waveform record.

A Transition Bit is defined as a bit that is preceded by one of the opposite polarity. A Non-Transition Bit is defined as a bit that is preceded by one of the same polarity. For the High – Low measurement, the Bit Type (All, Transition or Non-Transition) refers to the first of the two bits being measured. The second of the two bits must always be a transition bit. The diagram below should help make this clear.

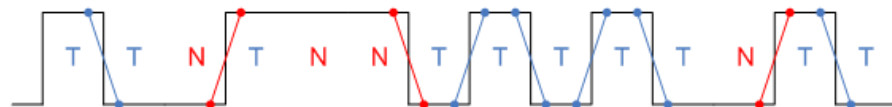

Blue: High – Low Measurement Locations for Transition (T) Bits
 Red: High – Low Measurement Locations for Non-Transition (N) Bits

When the Method = Mean, the measurement is calculated using the following equation:

For rising transitions, $V_n^{High-Low} = V_{n+1}^{Hi} - V_n^{Lo}$

For falling transitions, $V_n^{High-Low} = |V_{n+1}^{Lo} - V_n^{Hi}|$

Where:

$V^{High-Low}$ is the high-low amplitude measurement result.

V^{Hi} is a High amplitude measurement result using the Mean method.

V^{Lo} is a Low amplitude measurement result using the Mean method.

n is the index of a bit of the selected type (all, transition or non-transition)

When the Method = Mode, the measurement is calculated using the following equation:

$$\text{For rising transitions, } V_{diff}(n) = V_{n+1}^{Hi} - V_n^{Lo}$$

$$\text{For falling transitions, } V_{diff}(n) = |V_{n+1}^{Lo} - V_n^{Hi}|$$

$$V_{High-Low} = Mode[V_{diff}]$$

Where [Vdiff] represents a single histogram containing all the individual rising and falling differences.

NOTE. *If there are no waveform samples that fall within the identified percentage of the unit interval, the single nearest waveform sample preceding the center point of the unit interval will be used.*

V-Diff-Xovr

The Differential Crossover Voltage measurement (V-Diff-Xovr) calculates the voltage level at the crossover voltage of a differential signal pair. If there is timing jitter on one of the pair of signal lines relative to the other, the crossover point will be modulated by the jitter. The measurement is calculated using the following equation:

$$V_n^{Crossover} = V_n^{Source1}(T_n^{Crossover})$$

Where:

$V_{Crossover}$ is the crossing voltage.

$V_{Source1}$ is the voltage of the first source waveform.

$T^{Crossover}$ is the crossover time, when the Source1 and Source2 waveforms are equal in voltage.

Overshoot Overshoot is the maximum peak amplitude above the *Reference voltage level* (V_{REF}). Non-differential signals (Single Ended) are required for this measurement such as DQS (SE) and CK(SE). For DQS signals, Search and Mark should be enabled.

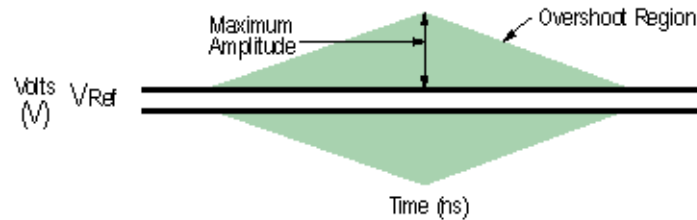

Related topics.

[High mid and low reference voltage levels](#)

Undershoot Undershoot is the maximum peak amplitude below the *Reference voltage level* (V_{REF}). Non-differential signals (Single Ended) are required for this measurement such as DQS(SE) and CK(SE). For DQS signals, Search and Mark should be enabled.

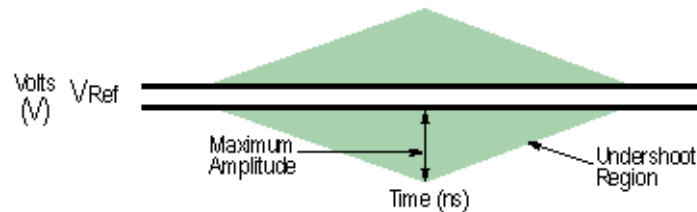

Related topics.

[High mid and low reference voltage levels](#)

Cycle max Cycle Max is a voltage measurement which measures positive peak voltage for all cycles. It is the maximum voltage for each cycle from the mid level of rise to the fall slope.

The application calculates this measurement using the following equation:

$$V_{CycleMax} = \text{Max}(f(\text{RiseIndex}(i) \text{ to } \text{FallIndex}(i+1)))$$

Where:

$I=1$ to the valid edge of the last cycle.

f is the function, which finds the maximum sample point in the defined region.

Cycle min Cycle Min is a voltage measurement which measures negative peak voltage for all cycles. It is the minimum voltage for each cycle from the mid level of Fall to the Rise slope.

The application calculates this measurement using the following equation:

$$V_{CycleMin} = \text{Min}(f(\text{FallIndex}(i) \text{ to } \text{RiseIndex}(i+1)))$$

Where:

$I=1$ to the valid edge of the last cycle.

f is the function, which finds the minimum sample point in the defined region.

Cycle Pk-Pk Cycle Pk-Pk is a voltage measurement which measures the absolute difference between the maximum and minimum amplitude for every cycle of the waveform. It calculates the peak-to-peak value for all cycles of the waveform. The peak value is measured from Fall slope to the next rise if the valid slope is a Fall. The next peak would be from Rise to next fall slope. The peak-to-peak value is calculated on all the pairs of minimum and maximum values available.

The application calculates the Cycle Pk-Pk using the following equation:

$$V_{Pk-Pk(n)} = \left| V_{CycleMax} - V_{CycleMin} \right|$$

for consecutive cycles

Where:

$V_{Max(n)}$ is the maximum peak amplitude.

$V_{Min(n)}$ is the minimum peak amplitude.

n is the number of cycles from 1 to the last valid edge.

Standard-Specific measurements

PCIe T-Tx-Diff-PP PCIe T-Tx-Diff-PP voltage swing calculates the change in voltage level across a transition in the waveform. It is the peak-to-peak differential voltage swing.

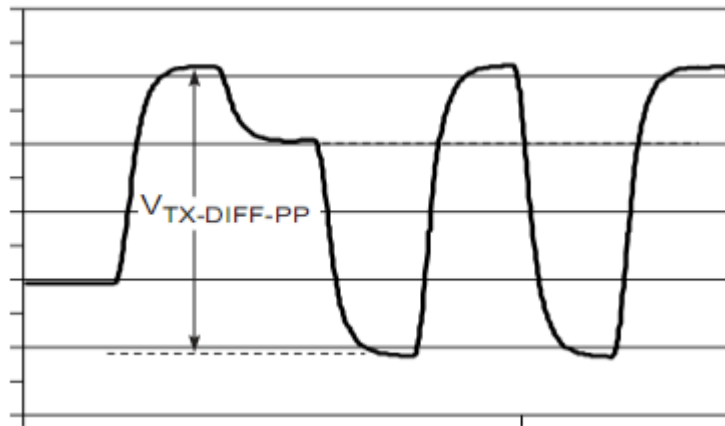

The application calculates this measurement using the following equation:

$$V_{Diff-p-p} = (V_{High} - V_{Low})$$

Where:

$V_{Diff-p-p}$ is the differential peak-to-peak voltage.

V_{High} is the maximum voltage calculated between i and $i+1$ points.

V_{Low} is the minimum voltage calculated between i and $i+1$ points.

i is the index of the UI (bit) location preceding the transition.

$i+1$ is the index of the UI (bit) location after the transition.

PCIe T-TX PCIe T-TX is based on the DPOJET measurement, Eye width. For more details, refer to the [Eye width](#).

PCIe T-Tx-Fall PCIe T-Tx-Fall is the time difference between the VRefLo(20%) reference level crossing and the VRefHi(80%) reference level crossing on the falling edge of the waveform. The VRefLo and VRefHi are calculated based on the voltage level of the previous UI. There are two distinct thresholds corresponding to de-emphasized transitions from high to low, and full swing transitions for VRefLo and VRefHi.

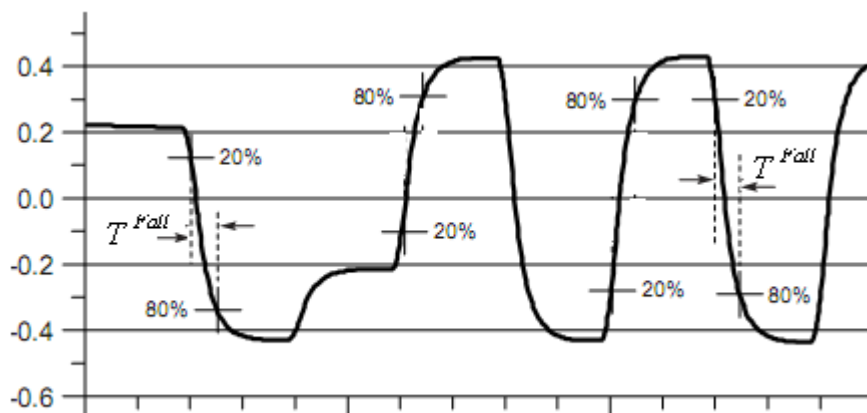

The application calculates this measurement using the following equation:

$$T_n^{Fall} = (T_n^{Lo-} - T_n^{Hi-})$$

Where:

T^{Fall} is the fall time

T^{Lo-} is the VRefLo crossing on the falling edge

T^{Hi-} is the VRefHi crossing on the falling edge

PCIe Tmin-Pulse PCIe Tmin-Pulse (minimum single pulse width $T_{\text{Min-Pulse}}$) is measured from one transition center to the next.

The application calculates this measurement using the following equation:

$$T_{\text{Min-Pulse}} = (T_{n+1} - T_n)$$

Where:

$T_{\text{Min-Pulse}}$ is the minimum pulse width

T is the transition center

PCIe DeEmph PCIe DeEmph is based on the DPOJET measurement, T/nT Ratio. For more details, refer to the [TnT ratio](#).

NOTE. PCIe DeEmph measurement uses Brick Wall filter.

PCIe T-Tx-Rise PCIe T-Tx-Rise is the time difference between the VRefHi(80%) reference level crossing and the VRefLo(20%) reference level crossing on the rising edge of the waveform. The VRefHi and VRefLo are calculated based on the voltage level of the previous UI. There are two distinct thresholds corresponding to de-emphasized transitions from low to high, and full swing transitions for VRefHi and VRefLo.

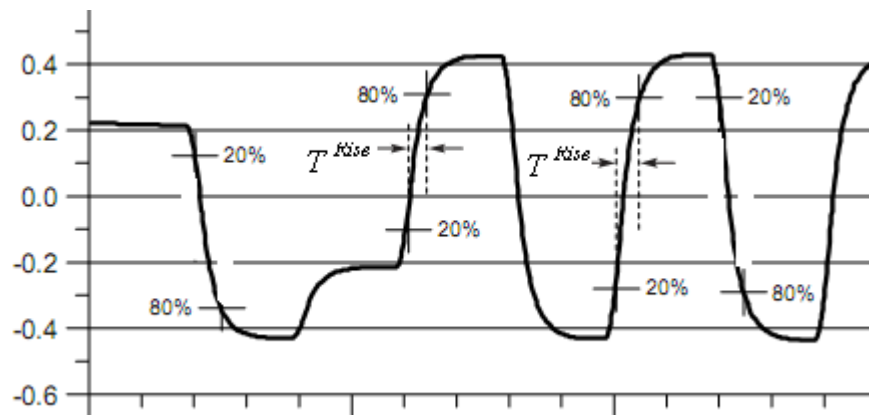

The application calculates this measurement using the following equation:

$$T_n^{\text{Rise}} = (T_n^{\text{Hi}^+} - T_n^{\text{Lo}^+})$$

Where:

T^{Rise} is the Rise time

$T^{\text{Hi}+}$ is the VRefHi crossing on the rising edge

$T^{\text{Lo}+}$ is the VRefLo crossing on the rising edge

PCIe UI PCIe UI is based on the DPOJET measurement, Period. For more details, refer to the [Period](#).

NOTE. PCIe UI uses a 3rd order LPF with the cut-off frequency of 198 kHz.

PCIe Med-Mx-Jitter PCIe Med-Mx-Jitter is the maximum time between the jitter median and the maximum deviation from the median.

The application calculates this measurement using the following equation:

$$T^{\text{Med-Max-Jitter}} = \max(T^{\text{Jitter-Median}} - TIE_n)$$

Where:

$T^{\text{Med-Max-Jitter}}$ is the median to max jitter

$T^{\text{Jitter-Median}}$ is the jitter median

TIE is the Time interval error

PCIe T-RF-Mismch PCIe T-RF-Mismch (Rise and Fall Time mismatch measurement) is the mismatch between Rise time (T^{Rise}) and Fall time (T^{Fall}). Rise time and Fall time are calculated using the “PCIe T-Tx-Rise” and “PCIe T-Tx-Fall” measurements.

The application calculates this measurement using the following equation:

$$T_n^{\text{Mismatch}} = \text{abs}(T_n^{\text{Rise}} - T_n^{\text{Fall}})$$

Where:

T^{Mismatch} is the rise and fall time mismatch

T^{Rise} is the rise time

T^{Fall} is the fall time

PCIe MAX-MIN ratio

PCIe MAX-MIN Ratio (custom name is PCIe VRX-MAX-MIN Ratio) is defined as the voltage range ratio over which a particular receiver must operate for the consecutive UI. Locate the mid edges crossover points. On the rising edge of the waveform, find the V_{SWINGMIN} . At the V_{SWINGMIN} point, trace back two unit intervals to find the V_{SWINGMAX} .

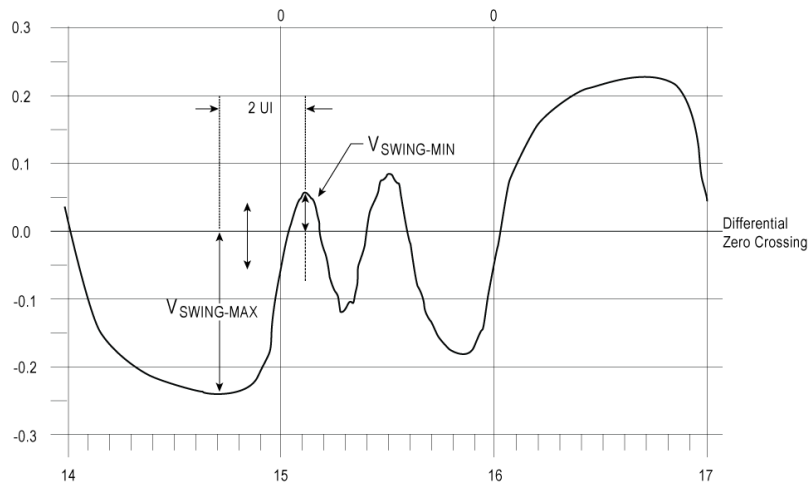

The application calculates this measurement using the following equation:

$$V_{\text{MAX-MIN-RATIO}} = (V_{\text{SWINGMAX}}) / (V_{\text{SWINGMIN}})$$

Where:

V_{SWINGMAX} is the maximum voltage swing on the rising edge of the waveform.

V_{SWINGMIN} is the minimum voltage swing on the rising edge of the waveform.

PCIe SSC PROFILE PCIe SSC Profile measurement uses the *Period* measurement with a second order low pass filter of 1.98 MHz. The PCIe SSC Profile shows the modulation profile of the Spread Spectrum Clocking. Using the SSC profile, you can find the SSC modulation rate by using vertical bar cursors and peak-to-peak frequency deviation by using horizontal bar cursors. The configurations required to be set are:

- Constant Clock Mean as the Clock Recovery method
- Low pass filter to get the SSC components
- Time Trend Plot for the Period measurement

PCIe SSC FREQ DEV PCIe SSC FREQ DEV is defined as the SSC frequency deviation in ppm (parts per million).

- Use the PCIe SSC Profile measurement to locate the mid edge cross points.
- Calculate the HIGH value between the n and n+1 edge and the LOW value between n+1 and n+2 edges.

The application calculates the measurement using the equation:

$$FREQ\ DEVIATION = HIGH - LOW$$

PCIe AC common mode The AC Common Mode Voltage measurement is the common mode voltage between two single-ended signals. AC is defined as all the frequency components above the cutoff frequency (30 kHz).

The application calculates this measurement using the following equations (based on two single-ended sources from the DUT):

$$CM_Voltage = (Source1 + Source2) \div 2$$

$$AC_CMM_{p-p} = \text{Peak-to-Peak}(\text{High Pass filter}(CM_Voltage))$$

Where:

AV_CMM_{p-p} is the peak-to-peak common mode voltage.

USB VTx-Diff-PP VTx-Diff-PP voltage swing calculates the change in voltage level across a transition in the waveform. It is the peak-to-peak differential voltage swing.

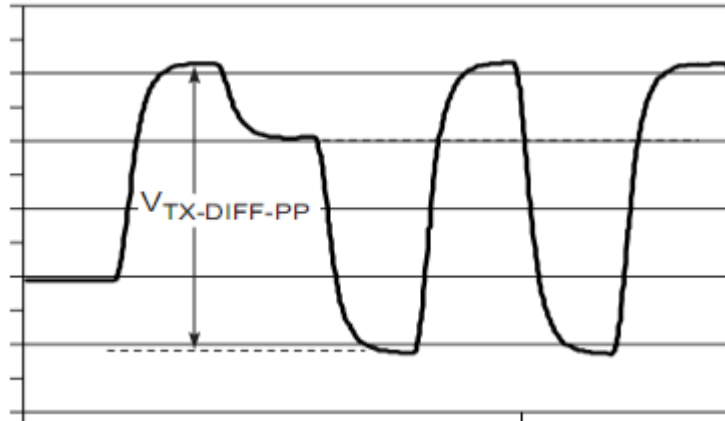

The application calculates this measurement using the following equation:

$$V_{TX-Diff-p-p} = (V_{High} - V_{Low})$$

Where:

$V_{Diff-p-p}$ is the differential peak-to-peak voltage.

V_{High} is the maximum voltage calculated between i and $i+1$ points.

V_{Low} is the minimum voltage calculated between i and $i+1$ points.

i is the index of the UI (bit) location preceding the transition.

$i+1$ is the index of the UI (bit) location after the transition.

USB TCdr-Slew-Max

Slew rate measurement finds the peak-to-peak period jitter. Period jitter can be obtained by taking the first difference of the filtered phase jitter. The application uses the Period measurement with an LPF of 1.98 MHz to find the period jitter. It calculates the phase jitter by taking the cumulative sum of the period jitter. Filters the phase jitter with the CR transfer function using the following equation:

$$H_{CDR}(s) = \frac{2s\zeta\omega_n + \omega_n^2}{s^2 + 2s\zeta\omega_n + \omega_n^2}$$

The filtered period jitter is obtained from the phase jitter to calculate peak-to-peak period jitter.

USB Tmin-Pulse-Tj Tmin-Pulse-Tj (minimum single pulse width $T_{\text{Min-Pulse}}$) is measured from one transition center to the next including all jitter sources.

The application calculates this measurement using the following equation:

$$T_{\text{Min-Pulse-Tj}} = (T_{n+1} - T_n)$$

Where:

$T_{\text{Min-Pulse}}$ is the minimum pulse width

T is the transition center

USB Tmin-Pulse-Dj USB Tmin-Pulse-Dj is defined as the minimum pulse width with only deterministic jitter components.

- Plot the time trend for the TIE measurement.
- Take the FFT of the TIE time trend to get the TIE spectrum. Then separate the RJ and DJ values from the spectrum.
- Take the IFFT of the TIE spectrum without the RJ components and reconstruct the clock based on the TIE trend without the RJ components.
- Find the minimum pulse width within the reconstructed clock.

USB SSC MOD RATE USB SSC MOD RATE is defined as the SSC modulation rate in terms of Hz. Use the SSC Profile measurement to locate the mid edge crossover points. Determine the time difference between the consecutive mid reference voltage levels as shown:

$$\Delta t = T_{n+1} - T_n$$

Where:

T_n is the V_{REFmid} crossing time

T_{n+1} is the $n+1$ V_{REFmid} crossing time

The application calculates this measurement using the following equation:

$$\text{Modulation Rate} = 1/\Delta t$$

USB SSC FREQ-DEV-MAX USB SSC FREQ DEV MAX is defined as the maximum frequency shift as a function of time. It represents the frequency deviation in terms of ppm (parts per million).

- Find the 50% edges on the SSC profile.
- Calculate the HIGH value between the n and n+1 edge.
- Find the Maximum frequency deviation as HIGH.

The application calculates the measurement using the equation:

$$\text{Freq Dev Max(ppm)} = ((\text{Maximum Freq} - \text{Nominal Data Rate}) / \text{Nominal Data Rate}) * 1e6$$

USB SSC FREQ-DEV-MIN USB SSC FREQ DEV MIN is defined as the minimum frequency shift as a function of time. Represents the frequency deviation in terms of ppm (parts per million).

- Find the 50% edges on the SSC profile.
- Calculate the LOW value between the n and n+1 edge.
- Find the Maximum frequency deviation as LOW.

The application calculates the measurement using the equation:

$$\text{Freq Dev Min(ppm)} = ((\text{Minimum Freq} - \text{Nominal Data Rate}) / \text{Nominal Data Rate}) * 1e6$$

USB SSC PROFILE USB SSC Profile measurement uses the *Period* measurement with a second order low pass filter of 1.98 MHz. The USB SSC Profile shows the modulation profile of the Spread Spectrum Clocking. Using the SSC profile, you can find the SSC modulation rate by using horizontal cursors and peak-to-peak frequency deviation by using vertical cursors. The configurations required to be set are:

- Constant Clock Mean as the Clock Recovery method
- Low pass filter to get the SSC components
- Time Trend Plot for the Period measurement

USB UI USB UI is based on the DPOJET measurement, Period. For more details, refer to the *Period*.

NOTE. USB UI uses a 3rd order LPF with the cut-off frequency of 198 kHz.

USB AC common mode The USB AC Common Mode Voltage measurement is the common mode voltage between two single-ended signals. AC is defined as all the frequency components above the cutoff frequency (30 kHz).

The application calculates this measurement using the following equations (based on two single-ended sources from the DUT):

$$CM_Voltage = (Source1 + Source2) \div 2$$

$$AC_CMM_{p-p} = \text{Peak-to-Peak}(\text{High Pass filter}(CM_Voltage))$$

Where:

AV_CMV_{p-p} is the peak-to-peak common mode voltage.

Average optical power Average optical power (AOP) is the true average component of an optical signal in Watts.

Extinction ratio Extinction ratio is the ratio of average power levels of the logic 1 level (High) to the logic 0 level (Low) of an optical signal. All level determinations are made within the Eye Aperture.

The Eye Aperture is adjustable and defaults to 20% of the signal bit time.

Optical modulation amplitude Optical modulation amplitude (OMA) is the difference between the average power levels of the logic 1 level (High) to the logic 0 level (Low) of an optical signal. All level determinations are made within the Eye Aperture.

The Eye Aperture is adjustable and defaults to 20% of the signal bit time.

Optical high The Optical high measurement calculates the nominal amplitude of a “1” bit, in one of two ways depending on the selected Method. Note that the Mean method results in one measurement value for each “1” bit of the selected type, whereas the Mode method results in a single measurement value for the entire waveform record.

When the Method = Mean, the measurement is calculated using the following equation:

$$W_n^{Hi} = \text{Mean}[w_n^{\text{percent}}]$$

Where:

W^{Hi} is the optical high measurement result.

w_n^{percent} is the set of all waveform samples for event n falling within the selected portion (percent) of the unit interval, ranging from 1% to 100%. If no waveform samples fall within the window for a given unit interval, the single sample nearest in time to the window is taken.

n is the index of a high bit, a high transition bit, or a high non-transition bit.

When the Method = Mode, the measurement is calculated using the following equation:

$$W^{Hi} = Mean[w_n^{percent}]$$

Where $w_n^{present}$ represents a single histogram containing all the waveform samples selected according to the same windowing and transition type criteria as in the Mean method.

Optical low

The Optical low measurement calculates the nominal amplitude of a “0” bit, in one of two ways depending on the selected Method. Note that the Mean method results in one measurement value for each “0” bit of the selected type, whereas the Mode method results in a single measurement value for the entire waveform record.

When the Method = Mean, the measurement is calculated using the following equation:

$$W_n^{Lo} = Mean[w_n^{percent}]$$

Where:

W^{Lo} is the Optical low measurement result.

$w_n^{percent}$ is the set of all waveform samples for event n falling within the selected portion (percent) of the unit interval, ranging from 1% to 100%. If no waveform samples fall within the window for a given unit interval, the single sample nearest in time to the window is taken.

n is the index of a low bit, a low transition bit, or a low non-transition bit.

When the Method = Mode, the measurement is calculated using the following equation:

$$W^{Lo} = Mean[w_n^{percent}]$$

Where $w_n^{present}$ represents a single histogram containing all the waveform samples selected according to the same windowing and transition type criteria as in the Mean method.

Eye Crossing Level

Eye Crossing Level is a histogram measurement which operates on two-dimensional histogram data that is collected from multiple acquisitions. By taking one dimensional slices along certain column or row indices of the 2D histogram, one dimensional histograms can be produced. The eye aperture is adjustable and defaults to 20% of the NRZ bit time.

The Eye Crossing Level measurement lists the voltage/watts level where the rising and falling edges of the eye waveform intersect ($PCross_1$ and $PCross_2$). The measurement algorithm searches for the eye waveform with narrowest crossing width.

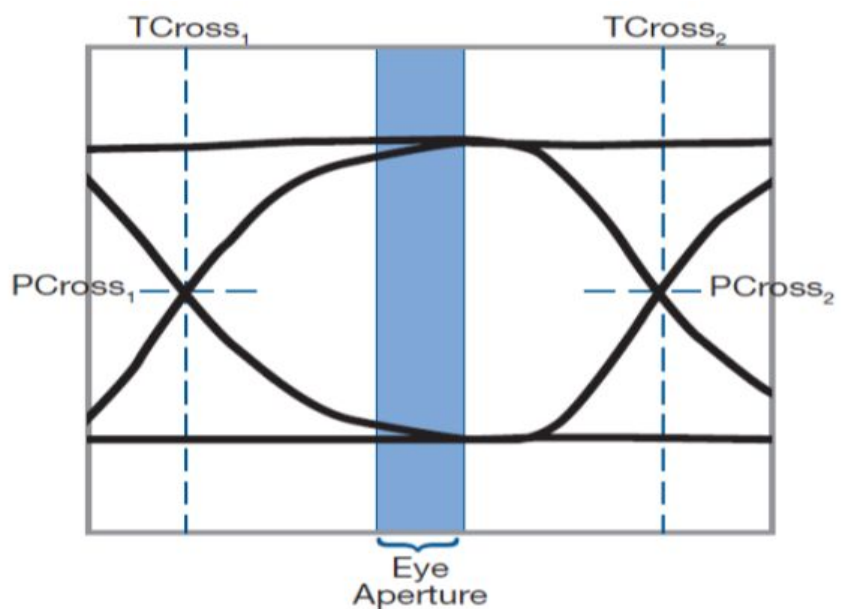

$TCross_1$ and $TCross_2$ = Eye Crossing Time in seconds

$PCross_1$ and $PCross_2$: Eye Crossing Level in volts/watts

Eye Crossing Time Eye Crossing Time is a histogram measurement which operates on two-dimensional histogram data that is collected from multiple acquisitions. By taking 1-dimensional slices along certain column or row indices of the 2D histogram, one dimensional histograms can be produced. The eye aperture is adjustable and defaults to 20% of the NRZ bit time.

The Eye Crossing Time measurement is the time of a single eye crossing waveform in seconds ($TCross_1$).

Eye Crossing Percent Eye Crossing Percent is a histogram measurement which operates on two-dimensional histogram data that is collected from multiple acquisitions. By taking one dimensional slices along certain column or row indices of the 2D histogram, one dimensional histograms can be produced. The eye aperture is adjustable and defaults to 20% of the NRZ bit time.

Eye Crossing Percent measurement is an eye crossing point expressed as a percentage of the eye waveform height.

Eye Crossing Percent = $100 * (\text{Eye Crossing Level} - \text{Zero Level}) / (\text{One Level} - \text{Zero Level})$

Eye Crossing Percent gives an indication of duty cycle distortion or pulse symmetry problems in high speed signals. It is valuable for measuring amplitude distortions caused by differences in One Level and Zero Level durations.

Mask Hit Ratio A Mask Hit Ratio is the ratio of number of UI that have a mask hit and total number of UI observed.

Mask Hit Ratio = $(\# \text{ of UI that have a mask hit}) / (\text{total } \# \text{ of UI observed})$

Mask Margin The concept of margin allows for more information to be shared than merely Pass/Fail decision. We assume the position of level values and unit interval boundary as 100% and original mask location as 0%. Hence a 20% mask margin implies that the mask violations does not occur even after scaling the original mask by this amount.

Jitter separation

Jitter analysis through RJ-DJ separation

Many of the jitter measurements are based on the concept of RJ-DJ separation. The application begins with the measured jitter-versus-time (as represented by the TIE measurement array) and analytically determines the random and deterministic components of the jitter. The deterministic part is further separated into independent subcomponents with specific characteristics.

The random jitter (RJ) is assumed to be zero-mean Gaussian, and is assumed to have a flat spectrum when viewed in the frequency domain. The measured RJ is fitted to a Gaussian mathematical model, which is parameterized by its standard deviation. Using the mathematical model for RJ, statistically probable jitter extremes may be predicted for much greater populations than actually measured.

The deterministic jitter (DJ) is predictable and can be generated consistently given known circumstances. The various DJ measurements each report the peak-to-peak value of the corresponding DJ subcomponent.

Once all the jitter components have been identified and the random jitter has been converted to a mathematical model, the components can be reassembled such that performance may be extrapolated to extremely low bit error rates. The probabilistic Total Jitter (TJ@BER) and probabilistic Eye Width (Width@BER) are examples of such measurements. The reported values are predictions that correspond to a user-specified Bit Error Rate, rather than observed values.

Two approaches are supported for performing jitter separation. The first method is based on spectrum analysis. It is only possible when the data pattern is repetitive. A clock waveform is always repetitive. Other repetitive testing data patterns are used, such as the K28.5 data pattern. Patterns may have rather long repetition lengths; for example, the CJTPAT pattern is 2640 bits. When using this method, you must specify the pattern length, and you will receive a warning if the pattern length appears to differ from that specified.

The second RJ-DJ separation method, known as arbitrary pattern analysis, may be used when the data pattern is not necessarily repetitive. This method works by correlating deterministic jitter observed over many repetitions with the bit pattern within a time-domain window surrounding each observation.

RJ-DJ separation via spectrum analysis

When the source waveform represents a repeating data pattern, Deterministic Jitter (DJ) has a frequency spectrum of impulses. The impulses due to the data pattern are equally spaced and occur at predictable frequencies related to the pattern length and bit rate. Specifically, the pattern-related jitter impulse must occur at multiples of f_0/N , where f_0 is the data bit rate and N is the data pattern length. Other spectral impulses may occur due to periodic jitter not correlated with the data pattern.

To obtain measurements of DJ and RJ, all the components of the jitter spectrum that exceed the noise floor by a chosen margin are attributed to deterministic jitter. Those components that fall at the frequency increment corresponding to the pattern length are identified as data-dependent jitter, and those occurring at other frequencies are attributed to uncorrelated periodic jitter. The remaining spectral noise floor (appropriately normalized to account for the removed deterministic jitter) is integrated to predict the standard deviation of the underlying Gaussian random noise process.

Once the spectral components corresponding to each deterministic jitter type have been identified, each component is inverse-transformed back to the time domain. From these waveforms, the peak-to-peak jitter for each component is determined. For the random jitter, the RMS deviation is directly computable from the standard deviation of the Gaussian model.

RJ-DJ separation for arbitrary patterns

When the data pattern borne by the source waveform is not cyclically repeating, any periodic jitter still has a frequency spectrum consisting of impulses but this is not true of the data-dependent jitter.

In this case, analysis of the data-dependent jitter may proceed based on the assumption that any given bit is affected by a finite (and relatively small) number of preceding bits. By averaging all events for which a given bit is preceded by a particular bit sequence, the data-dependent jitter attributable to that bit sequence is obtained. This is because PJ and RJ are not correlated to a particular data sequence and thus are averaged out.

If each bit is assumed to be affected by N preceding bits, there are a total of 2^N possible data sequences. The sequence length N is a configurable parameter. To get statistically sound average values for the data-dependent jitter, a minimum population of observations is required for each individual pattern that occurs at least once. This population limit is also configurable by the user.

By the above means, the data-dependent jitter is characterized. Once characterized, the data-dependent jitter, on a bit-by-bit basis, may be removed from the original jitter versus time record. The remaining jitter is composed of periodic and random jitter. This jitter is transformed into the frequency domain, and the spectral analysis approach is used to separate the impulsive periodic jitter from the broad noise floor of random jitter.

Separation of Non-Periodic jitter (NPJ)

Bounded Uncorrelated Jitter (BUJ) refers to all bounded jitter that is not correlated to the data pattern on the waveform. Thus, it excludes DDJ, DCD and RJ. It can be further subdivided into PJ (which is deterministic, and easily recognized using a spectral approach) and Non-Period Jitter (NPJ).

Depending on its precise nature, NPJ is often difficult to distinguish from RJ. It typically cannot be isolated using frequency domain techniques, so a different domain is used. The important difference between RJ and NPJ is that RJ has a Gaussian distribution (with unbounded tails) whereas NPJ is bounded by definition. This fact is used as a basis for separation.

In DPOJET, the jitter separation algorithms are modified as follows when the Spectral + BUJ method is selected:

1. Data-Dependent Jitter (DDJ) and Duty-Cycle jitter (DCD) are first removed using either a spectral approach for repeating patterns or a correlation approach for arbitrary data patterns.
2. PJ is identified and removed using a spectral approach.
3. The remaining jitter is assumed to contain (Gaussian) RJ and possibly NPJ. (In the Spectral Only method of jitter analysis, no further processing is done and this jitter is reported as RJ.)
4. When Spectral + BUJ processing is selected, the RJ + NPJ jitter is collected into a histogram that is typically accumulated over multiple waveform acquisitions. When the (user-configurable) minimum histogram population has been acquired, the histogram is converted to an estimate of the Cumulative Density Function (CDF) and plotted using the Q-scale for the vertical axis. The Q-scale plot has the property that a true Gaussian distribution appears as a straight line, with a slope equal to $1/\sigma$ (where σ is the standard deviation of the Gaussian distribution). If the distribution is a mixture of a true Gaussian plus some bounded distribution, the plotted curve has left and right extremes that asymptotically approach straight lines with a slope of $1/\sigma$. The horizontal offset between the two asymptotes represents the dual-dirac magnitude of the NPJ.

Estimation of TJ@BER and eye Width@BER

One of the outcomes of the RJ-DJ separation was a mathematical model for random jitter's probability density function (PDF) and measured values for the PDFs of the deterministic jitter components. Since all of these components are assumed to be statistically independent, the PDF of the total jitter can be calculated by convolution.

Integration of the PDF yields the cumulative distribution function (CDF), which can then be used to create the bit error rate curve (bathtub curve). Based on the bathtub curve, the eye opening (Width@BER) and eye closure (TJ@BER) can be estimated for a given bit error rate.

The application calculates the eye opening at the specified BER using the following equation:

$$\text{Eye opening} = 1 - \text{TJ@BER} \text{ when } \text{TJ@BER} \text{ is less than one Unit Interval}$$

Jitter estimation using Dual-Dirac models

Jitter estimation based on RJ-DJ separation depends in part on the specific jitter components modeled. For the purposes of analyzing jitter and identifying root cause, it is very useful to identify components as specifically as possible. But for the purposes of determining compliance, it has been found that a simplified jitter model yields results that are more consistent across different measurement instruments and different vendors.

A simplified model that has found acceptance in several industry standards is known as the Dual-Dirac model. This is because the probability density function (PDF) of all the deterministic jitter is replaced with a PDF consisting of two Dirac functions such that the total jitter and eye opening at very low bit error rates is unchanged. The Random Jitter and Deterministic Jitter values derived from this model are identified as RJ- $\delta\delta$ and DJ- $\delta\delta$, respectively.

Two slightly different Dual-Dirac models have been defined. Both models begin with a jitter versus BER (bathtub) curve, either created from a full jitter analysis based on RJ-DJ separation, or from direct measurement of error rate versus sample point offset. The two models differ in how the RJ- $\delta\delta$ and DJ- $\delta\delta$ values are extracted from the curve.

For the Fibre-Channel standard, values for RJ- $\delta\delta$ and DJ- $\delta\delta$ are chosen such that the Dual-Dirac bathtub curve exactly matches the measured curve at the BER = 10^{-5} and BER= 10^{-9} points.

For the PCI Express and FB-DIMM standards, the bathtub curve is re-plotted using a different y-axis. Instead of directly plotting against the log of the BER, the y-axis is converted to the Q-scale. The BER to Q-scale transformation was designed such that Gaussian distributions are converted to straight lines, with a slope that is directly related to the standard deviation of the Gaussian.

When using the Dual-Dirac jitter measurements, it is critical that you select the model that matches the applicable standard. This may be configured in the DPOJET preferences, which are found under **Analyze > Jitter and Eye Analysis (DPOJET) > Preferences**, on the Measurement tab.

Joint Jitter/Noise analysis

Differences between Jitter-Only and Jitter+Noise analysis

Traditionally, jitter has been analyzed by detecting edge crossings at a voltage, current or optical power reference level and then analyzing the distribution of these edge times relative to a reference clock. Based on various properties of the jitter distribution (observed in the time, frequency and statistical domains), the jitter has been separated into categories or components that exhibit well-known behaviors. This allows a mathematical model of the jitter to be constructed, which can then be used to extrapolate jitter behavior for higher populations of bits than were actually measured. In this process, the shape of the analog waveform between edge crossings is entirely ignored.

In Joint Jitter/Noise Analysis, the entire analog waveform is analyzed. The process is analogous in many ways to Jitter-Only analysis, but the mathematical model for jitter and noise behavior is more thorough and better fits the physical world. For example, in addition to the familiar jitter components (RJ, PJ, DDJ) there are corresponding noise components (RN, PN, DDN). Jitter is still analyzed at points where the waveform crosses a horizontal reference line, and Noise is analyzed where the waveform crosses a vertical reference line once each unit interval. These two reference planes are where the model parameters (RJ – DDJ and RN – DDN) are determined, although the process of determining the parameter values involves compensating for effects of jitter on noise and vice versa.

Because both techniques use parameterized mathematical models to extrapolate behavior, they will not yield identical results (but should be very close). Consider an analogy: You could measure the area of a circle by splitting the circle into a number of narrow wedge-shaped triangles with their points all at the center of the circle, and adding the areas of the triangles. Or you could estimate the circle's area by placing a fine rectangular grid on the circle and counting the number of squares that were mostly inside the circle. Both methods will yield a good estimate but the two models won't give the same answer.

Because the Jitter-Only model does not consider vertical effects, there are some aspects of eye closure to which the jitter-Only method is entirely blind but the Jitter+Noise method models well. The Jitter-Only method does not provide any noise measurement values at all, for obvious reasons. And the Jitter+Noise method exposes how noise is manifested as jitter, and jitter as noise, which is helpful in identifying root cause.

Use of Jitter+Noise analysis when DJAN is not enabled

The DJAN option enables noise measurements such as TN@BER, RN and DN in DPOJET. When you have enabled only DJA (DPOJET Advanced) option, then you may still select “Jitter+Noise” as the analysis method on the DPOJET Preferences > Jitter Decomp menu. Then the DPOJET uses the more complex Jitter + Noise parameter model and processing, but does not allow noise measurements to select and run. Noise measurements can be selected and run when you enable DJAN.

It may seem pointless to select the Jitter+Noise analysis method if the noise measurements are not accessible. The Jitter+Noise uses more complete model, and the jitter values may change slightly, or even markedly in rare cases.

One example is an eye that is closed at the target BER due to voltage ring-back in the middle of the eye. In that case, the traditional Jitter-Only method can entirely miss the noise induced eye closure but the Jitter+Noise approach will recognize it. Also, selection of the Jitter+Noise model with DJA can be useful if you are trying to compare jitter measurement results with a peer who is using a scope with the DJAN option enabled.

**Basic steps in joint Jitter
+Noise analysis**

The process of performing Jitter+Noise analysis includes these major steps:

1. Perform clock recovery to identify a reference clock representing the ideal transition times. This process also yields the received Boolean bit stream.
2. Measure the exact instant in time where each data transition (edge) occurs.
3. Measure the slew rate at each of these edges.
4. Measure the exact amplitude at the center (50% point) of each bit.
5. Measure the slew rate at each of these bit centers.
6. Perform a joint analysis on the prior four data sets to decouple the effects of jitter on noise and vice versa.
7. Considering the entire analog waveform (not just the edges and bit centers), derive the “correlated waveform”. This is the waveform that reflects channel effects (low-pass filtering, reflections) while filtering out variations uncorrelated to the data pattern.
8. Compare the edge times from step 2 with the clock times from step 1 to derive TIE (Time Interval Error). Use spectral analysis, time analysis and Q-scale analysis to derive model parameters such as RJ and PJ. Please see the various topics under *Jitter analysis through RJ-DJ separation* for a more thorough description of this process.
9. Compare the bit amplitudes from step 3 with the ideal bit stream (derived from the received Boolean bit stream and the nominal high and low bit amplitudes). Use spectral analysis, time analysis and Q-scale analysis to derive model parameters such as RN and PN. See *Noise Model Component Interrelationships*.
10. Use two-dimensional convolution to combine the effects of all jitter and noise model parameters into a statistical model of uncorrelated noise. This includes RJ, PJ, NPJ, RN, PN and NPN.
11. Convolve the model of uncorrelated jitter+noise with the correlated waveform to create a model of the overall eye diagram’s true PDF.
12. Integrate the PDF of step 11 from top to bottom (for ‘0’ bits only) to derive the ‘0’ bit CDF. Perform a complimentary operation to derive the ‘1’ bit CDF.
13. Superimpose the CDFs of steps 11 and 12 to get the BER eye: analogous to the bathtub curve, except two-dimensional. (In fact, the jitter bathtub or the noise bathtub can be derived directly from the BER Eye by slicing it either horizontally or vertically, respectively.)

Noise model component interrelationships

The figure below depicts graphically how the various noise model parameters relate to each other. It is only the upward-reaching portions of the lower models and the downward-reaching portions of the upper models that contribute to eye opening (or closure), and this is reflected in how the DDN, DN and TN@BER values are calculated.

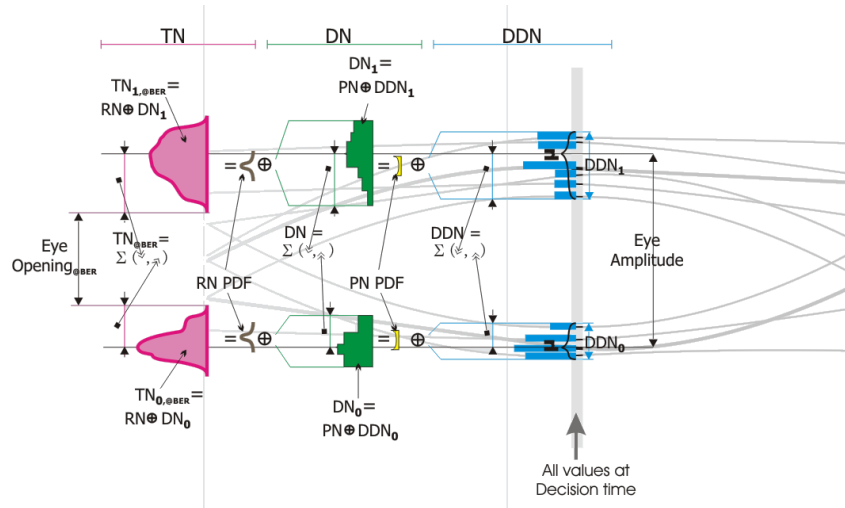

Results

The application calculates statistics for all selected measurements. The application displays the following statistics in the Results menu:

- Mean
- Std Dev (Standard Deviation)
- Max (Maximum Value)
- Min (Minimum Value)
- p-p (Peak-to-Peak)
- Population
- Max-cc (Maximum positive cycle-to-cycle variation)
- Min-cc (Maximum negative cycle-to-cycle variation)

Mean The application calculates the mean value using the following equation:

$$\text{Mean}(X) = \bar{X} = \frac{1}{N} \sum_{n=1}^N X_n$$

Standard Deviation The application calculates the standard deviation using the following equation:

$$\text{StdDev}(X) = \sigma_X = \sqrt{\frac{1}{(N-1)} \sum_{n=1}^N (X_n - \bar{X})^2}$$

It may seem odd that the equation for the estimate of the Standard Deviation contains a $1/(N-1)$ scaling factor. If you knew the true mean of X and used it in place of the estimated mean \bar{X} then you would, in fact, scale by $1/N$. But, \bar{X} is an estimate and is likely to be in error (or bias), causing the estimate of the Standard Deviation to be too small if scaled by $1/N$. This is the reason for the scaling shown in the equation. (Refer to Chapter 9.2 in A. Papoulis, Probability, Random Variables, and Stochastic Processes, McGraw Hill, 1991.)

NOTE. RMS value can be calculated using the relation $(rms) = (\text{mean value}) + (\text{stddev})$.

Maximum Value The application calculates maximum value using the following equation:

$$\text{Max}(X) = \text{Most Positive Value of } X$$

Minimum Value The application calculates minimum value using the following equation:

$$\text{Min}(X) = \text{Most Negative Value of } X$$

p-p The application calculates peak-to-peak using the following equation:
$$p-p(X) = \text{Max}(X) - \text{Min}(X)$$

Population Population is the total number of events or observations over which the other statistics were calculated.
Population (X) = N

Max-cc The application calculates Max-cc using the following equation:
$$\text{Max-cc}(X) = \text{Max}(X_{CC})$$

Where:
 X_{CC} is the first difference of X.

$$X_{CC} = X_n - X_{n-1}$$

Min-cc The application calculates Min-cc using the following equation:
$$\text{Min-cc}(X) = \text{Min}(X_{CC})$$

Where:
 X_{CC} is the first difference of X.

$$X_{CC} = X_n - X_{n-1}$$

GPIB commands

About the GPIB program

You can use remote GPIB commands to communicate with the DPOJET application. An example of a GPIB program that can execute the DPOJET application is included with the application in C:\Users\Public\Tektronix\TekApplications\DPOJET\Examples.

The example shows how a GPIB program executes the application to do the following tasks:

1. Start the application.
2. Recall a setup.
3. Take a measurement.
4. View measurement results and plots.
5. Exit the application.

NOTE. *Commands are not case and space sensitive. Your program will operate correctly even if you do not follow the capitalization and spacing precisely.*

GPIB reference materials

To use GPIB commands with your oscilloscope, you can refer to the following materials:

- The GPIB Program Example in C:\Users\Public\Tektronix\TekApplications\DPOJET\Examples for guidelines to use while designing a GPIB program.
- The Parameters topics for range of values, minimum units and default values of parameters.
- The programmer information in the online help of your oscilloscope.

Argument types

The syntax shows the format that the instrument returns in response to a query. This is also the preferred format when sending the command to the instrument though any of the formats will be accepted. This documentation represents these arguments as follows:

Table 93: Argument types

Symbol	Meaning
<NR1>	Signed integer value.
<NR2>	Floating point value without an exponent.
<NR3>	Floating point value with an exponent.
double	Double precision floating point with exponent.

DPOJET:ADDMeas

This set-only command adds the specified measurement to the bottom of the current DPOJET list of measurements and will appear in the results summary page.

Syntax DPOJET:ADDmeas {PERIod | CCPeriod | FREQuency | NPERiod | PWidth | NWidth | PDUTy | NDUTy | PCCDuty | NCCDuty | DATARATE | TIE | RJ | RDirac | TJber | DJ | DJDirac | PHASENoise | DCD | DDJ | PJ | J2 | J9 | SRJ | PJrms | SJFREQ | PKPKCLKTJ | PKPKCLKRJ | PKPKCLKDJ | PJRMS | FN | RJH | RJV | PJH | PJV | RN | RNV | RNH | DN | DDN | DDN_1 | DDN_0 | PN | PNV | PNH | NPN | TNBER | NOISESUMMARY | UNITAMPLITUDE | RISEtime | SETup | HIGHTime | FALLtime | HOLD | LOWTime | SKEW | HEIght | WIDth | MASKHits | WIDTHBer | HEIGHTBer | COMMonmode | HIGH | TNTratio | HIGHLOW | LOW | VDIFFxovr | RISESLEWrate | FALLSLEWrate | OVERShoot | UNDERShoot | CYCLEPktopk | JITTERSummary | PCIETTXDiffpp | PCIEDEemph | PCIETTx | PCIETTXRise | PCIETTXFall | PCIEUI | PCIETMinpulse | PCIEEMdxjitter | PCIETRFmismch | PCIESSCFReqdev | PCIEMAXMINratio | PCIESSCPROfile | PCIEVEye | PCIETTXUTJ | PCIETTXUDJDD | PCIETTXUPWTJ | PCIETTXUPWDJDD | PCIETTXDDJ | PCIEVTXBOOST | PCIEVTXNOEQ | PCIEVTXEIEOS | PCIEPS21TX | PCIEACCommonmode | VTXDiffpp | TMINPULSESETJ | TCDRslewmax | USBUI | USBACCommonmode | TMINPULSEDJ | QFACTOR | EYELow | EYEHIGH | TCMDTOCMD | TIMEOUTSIDELEVEL | SSCFREQDEVMAX | SSCFREQDEVMIN | SSCFREQDEV | SSCMODrate | SSCPROFILE | USBSSCFREQDEVMAX | USBSSCFREQDEVMIN | USBSSCMODrate | USBSSCPROfile | AUTOFITMaskhits | AOP | EXRATIO | OMA | OPTHIGH | OPTLOW | EYECROSSLEVEL | EYECROSSTIME | EYECROSSPERCENT | DFEW | DFEEH | DFEEYEDIAGRAM | VWOE | MASKMARGIN | MASKHITRATIO }

Inputs Same as syntax for measurement options.

Outputs None

DPOJET:APPLYAll

This command applies configuration of specified type of the specified DPOJET measurement to all other DPOJET measurements.

Syntax DPOJET: APPLYAll {FILTerS | CLOCKRecovery| RJDJ}, MEAS<x>

Inputs {FILTerS | CLOCKRecovery| RJDJ}, MEAS<x>
 For example: DPOJET:APPLYAll FILTerS, MEAS2

DPOJET:BITRatestate

This command sets or queries the user bitrate state, either on or off.

Syntax DPOJET:BITRatestate {0|1}
 DPOJET:BITRatestate?

Inputs {0|1}

Outputs {0|1}

DPOJET:CLEARALLMeas

This set-only command clears the entire current list of defined measurements in DPOJET.

Syntax DPOJET:CLEARALLMeas

Outputs None

DPOJET:DATAratelimits

This command sets or queries the reference bitrate for measurement limits.

Syntax DPOJET:DATAratelimits <NR3>
DPOJET:DATAratelimits?

Inputs <NR3>

Outputs <NR3>

DPOJET:DESKEW

This command performs a DPOJET deskew operation with the settings specified in DPOJET:DESKEW.

Syntax DPOJET:DESKEW {EXEcute}

Inputs {EXEcute}

DPOJET:DESKEW:DESKEWchannel

This command sets or queries the channel to be deskewed.

Syntax DPOJET:DESKEW:DESKEWchannel {CH1-CH4}
DPOJET:DESKEW:DESKEWchannel?

Inputs {CH1 - CH4}

Outputs {CH1 - CH4}

DPOJET:DESKEW:DESKEWHysteresis

This command sets or queries the deskew channel hysteresis value.

Syntax DPOJET:DESKEW:DESKEWHysteresis <NR3>
DPOJET:DESKEW:DESKEWHysteresis?

Inputs <NR3>

Outputs <NR3>

DPOJET:DESKEW:DESKEWMidlevel

This command sets or queries the deskew channel midlevel value.

Syntax DPOJET:DESKEW:DESKEWMidlevel <NR3>
DPOJET:DESKEW:DESKEWMidlevel?

Inputs <NR3>

Outputs <NR3>

DPOJET:DESKEW:EDGE

This command sets or queries the edge types used when calculating deskew.

Syntax DPOJET:DESKEW:EDGE {RISE | FALL | BOTH}
DPOJET:DESKEW:EDGE?

Inputs {RISE | FALL | BOTH}

Outputs {RISE | FALL | BOTH}

DPOJET:DESKEW:MAXimum

This command sets or queries the maximum deskew value possible.

Syntax DPOJET:DESKEW:MAXimum <NR3>
DPOJET:DESKEW:MAXimum?

Inputs <NR3>

Outputs <NR3>

DPOJET:DESKEW:MINimum

This command sets or queries the minimum deskew value possible.

Syntax DPOJET:DESKEW:MINimum <NR3>
DPOJET:DESKEW:MINimum?

Inputs <NR3>

Outputs <NR3>

DPOJET:DESKEW:REFChannel

This command sets or queries the reference channel used for deskew operation.

Syntax DPOJET:DESKEW:REFChannel {CH1 - CH4}
DPOJET:DESKEW:REFChannel?

Inputs {CH1 - CH4}

Outputs {CH1 - CH4}

DPOJET:DESKEW:REFHysteresis

This command sets or queries the reference channel hysteresis value.

Syntax DPOJET:DESKEW:REFHysteresis <NR3>
DPOJET:DESKEW:REFHysteresis?

Inputs <NR3>

Outputs <NR3>

DPOJET:DESKEW:REFMidlevel

This command sets or queries the reference channel midlevel value.

Syntax DPOJET:DESKEW:REFMidlevel <NR3>
DPOJET:DESKEW:REFMidlevel?

Inputs <NR3>

Outputs <NR3>

DPOJET:DIRacmodel

This command sets or queries the current dirac model.

Syntax DPOJET:DIRacmodel {FIBREchannel | PCIExpress}
DPOJET:DIRacmodel?

Inputs {FIBREchannel | PCIExpress}

Outputs {FIBREchannel | PCIExpress}

DPOJET:EXPORT

This set-only command saves the specified DPOJET plot to the specified file path. The Format is determined through the filename extension, with a default of png if no extension is specified.

Supported extensions include jpeg, jpg, tif, tiff, bmp, emf, .mat, .csv and png.

Syntax DPOJET:EXPORT {PLOT1-PLOT4, <file string>}

Inputs {PLOT1-PLOT4, <file string>}

DPOJET:EXPORTRaw

This set-only command saves the raw Eye diagram 2d histogram data to the specified file path. The format is determined through the filename extension. Supported extension include .csv

NOTE. *Ensure that the Plot window is open while sending this PI command; else a file will be not generated.*

Syntax DPOJET:EXPORTRaw {PLOT1-PLOT4, <file string>}

Inputs {PLOT1-PLOT4, <file string>}

Example DPOJET:EXPORTRAW PLOT1, "savedimage.csv".

DPOJET:GATING

This command sets or queries the gating state.

Syntax DPOJET:GATING {OFF | ZOOM | CURSOR | MARKS}
DPOJET:GATING?

Inputs {OFF | ZOOM | CURSOR | MARKS}

Outputs {OFF | ZOOM | CURSOR | MARKS}

DPOJET:HALTFreerunonlimfail

This command sets or queries the halt free-run on limit failure (On or Off).

Syntax DPOJET:HALTFreerunonlimfail {1 | 0}
DPOJET:HALTFreerunonlimfail?

Inputs {1 | 0}

Outputs {1 | 0}

DPOJET:HIGHPerfrendering

This command sets or queries the current high-performance eye rendering setting.

Syntax DPOJET:HIGHPerfrendering <NR1>
DPOJET:HIGHPerfrendering?

Inputs <NR1>

Outputs <NR1>

DPOJET:INTERp

This command sets or queries the current interpolation model.

Syntax DPOJET:INTERp {LINear | SINX}
DPOJET:INTERp?

Inputs {LINear | SINX}

Outputs {LINear | SINX}

DPOJET:JITtermode?

This command queries the current jitter mode.

Syntax DPOJET:JITtermode?

Outputs <string>

DPOJET:JITtermodel

This command sets the current jitter model.

Syntax DPOJET:JITtermodel {BUJ | Legacy}

Inputs {BUJ | Legacy}

DPOJET:ANALYSISMETHOD

This command sets or queries the current analysis method value.

Syntax DPOJET:ANALYSISMETHOD { JITTEROnly | JITTERNoise }
DPOJET:ANALYSISMETHOD?

Inputs JITTEROnly | JITTERNoise

DPOJET:LASTError?

This query-only command returns the contents of the last pop-up warning dialog box. If no errors have occurred since startup, or since the last call to DPOJET:LASTError?, this command returns an empty string.

Syntax DPOJET:LASTError?

Outputs <string>

DPOJET:LIMITRise

This command turns on or off the ability to limit Rise/Fall measurements to transition bits only.

Syntax DPOJET:LIMITRise {1 | 0}

Inputs {1 | 0}

Outputs {1 | 0}

DPOJET:MINBUJUI

This command sets or queries the minimum number of UI for BUJ analysis.

Syntax DPOJET:MINBUJUI <NR3>
DPOJET:MINBUJUI?

Inputs <NR3>

Outputs <NR3>

DPOJET:LIMits:FILEName

This command sets or queries the current limits filename.

Syntax DPOJET:LIMits:FILEName <string>
DPOJET:LIMits:FILEName?

Inputs <string>

Outputs <string>

DPOJET:LIMits:STATE

This command turns on or off the pass-fail limit system. Pass-fail status can be queried using the DPOJET:MEAS <x>:RESULTS node.

Syntax DPOJET:LIMits:STATE {1 | 0}

Inputs {1 | 0}

Outputs {1 | 0}

DPOJET:LOGging:MEASurements:FOLDer

This command sets or queries the current folder used for measurement logging.

Syntax DPOJET:LOGging:MEASurements:FOLDer <string>
DPOJET:LOGging:MEASurements:FOLDer?

Inputs <string>

Outputs <string>

DPOJET:LOGging:MEASurements:STATE

This command turns on or off the future logging of measurements. Individual measurements included in the logging are selected using the DPOJET:MEAS<x>:LOGging node. This parameter turns on or off the entire set of included measurements.

Syntax DPOJET:LOGging:MEASurements: {1 | 0}

Inputs {1 | 0}

Outputs {1 | 0}

DPOJET:LOGging:SNAPshot

This command performs a DPOJET export of the specified type, either for statistics or measurements.

Syntax DPOJET:LOGging:SNAPshot {STATistics | MEASurements}

Inputs {STATistics | MEASurements}

Outputs {STATistics | MEASurements}

DPOJET:LOGging:STATistics:FILEName

This command sets or queries the current file used for statistics logging.

Syntax DPOJET:LOGging:STATistics:FILEName <string>
DPOJET:LOGging:STATistics:FILEName?

Inputs <string>

Outputs <string>

DPOJET:LOGging:STATistics:STATE

This command turns on or off the future logging of statistics. Individual measurements included in the logging are selected using the DPOJET:MEAS<x>:LOGging node. This parameter turns on or off the entire set of included measurements.

Syntax DPOJET:LOGging:STATistics:STATE {1 | 0}

Inputs {1 | 0}

Outputs {1 | 0}

DPOJET:LOGging:WORSTcase:FOLDER

This command sets or queries the current folder used for worst case logging.

NOTE. *Waveform filenames generated while worst case logging is on will follow the syntax of “Measurement Name”-“Source”_Min1.wfm and “Measurement Name”-“Source”_Max1.wfm, For example: Period1-Ch1_Max1.wfm, Period1-Ch1_Min1.wfm, Rise Time1-Ch1_Max1.wfm, Rise Time1-Ch1_Min1.wfm.*

Syntax DPOJET:LOGging:WORSTcase:FOLDER <string>
DPOJET:LOGging:WORSTcase:FOLDER?

Inputs <string>

Outputs <string>

DPOJET:LOGging:WORSTcase:STATE

This command turns on or off the future logging of worst case waveforms. Individual measurements included in the logging are selected using the DPOJET:MEAS<x>:LOGging node. This parameter turns on or off the entire set of included measurements.

Syntax DPOJET:LOGging:WORSTcase:STATE {1 | 0}

Inputs {1 | 0}

Outputs {1 | 0}

DPOJET:MEAS<x>

This command returns the branch query for the application measurement slot with index <x>. This will always match the measurement defined at the associated index <x> displayed on the DPOJET screen, where index 1 is the first, or top, of the measurement list.

Branch queries will only contain the measurement branches for those branches that have measurements defined. This means queries to branches that do not exist will time out. This is required because the number of measurements that can be defined in DPOJET, is 99.

Syntax DPOJET:MEAS<x>?

DPOJET:MEAS<x>:BER:TARGETBER

This command sets or queries the BER value.

Syntax DPOJET:MEAS<x>:BER:TARGETBER <NR3>
DPOJET:MEAS<x>:BER:TARGETBER?

Inputs <NR3>

Outputs <NR3>

NOTE. This command is different from DPOJET:MEAS:RJDJ:BER whose configuration parameter exist in RJDJ tab.

NOTE. This command is different from DPOJET:MEAS:RNDN:BER whose configuration parameter exist in RNDN tab.

DPOJET:MEAS<x>:BITCfghmethod

This command sets or queries the measurement bit configure method.

Syntax DPOJET:MEAS<x>:BITCfghmethod {MEAN | MODE}
DPOJET:MEAS<x>:BITCfghmethod?

Inputs {MEAN | MODE}

Outputs {MEAN | MODE}

DPOJET:MEAS<x>:BITPcnt

This command sets or queries the percentage value to be measured for the Bit type selected.

Syntax DPOJET:MEAS<x>:BITPcnt <NR3>
DPOJET:MEAS<x>:BITPcnt?

Inputs <NR3>

Outputs <NR3>

DPOJET:MEAS<x>:BITConfig:STARTPercent

This command sets or queries the starting percentage of the bit to measure.

Syntax DPOJET:MEAS<x>:BITConfig:STARTPercent <NR3>
DPOJET:MEAS<x>:BITConfig:STARTPercent?

Inputs <NR3>

Outputs <NR3>

DPOJET:MEAS<x>:BITConfig:ENDPercent

This command sets or queries the ending percentage of the bit to measure.

Syntax DPOJET:MEAS<x>:BITConfig:ENDPercent <NR3>
DPOJET:MEAS<x>:BITConfig:ENDPercent?

Inputs <NR3>

Outputs <NR3>

DPOJET:MEAS<x>:BITConfig:NUMBins

This command sets or queries the number of bins per window.

Syntax DPOJET:MEAS<x>:BITConfig:NUMBins <NR3>
DPOJET:MEAS<x>:BITConfig:NUMBins?

Inputs <NR3>

Outputs <NR3>

DPOJET:MEAS<x>:BITConfig:ABSRELstate

This command sets or queries the user absolute/relative state, either on or off.

0-> sets the Absolute

1-> sets the Relative

Syntax DPOJET:MEAS<x>:BITConfig:ABSRELstate {0|1}
 DPOJET:MEAS<x>:BITConfig:ABSRELstate?

Inputs {0|1}

Outputs {0|1}

DPOJET:MEAS<x>:BITType

This command sets or queries the measurement bit type setting.

Syntax DPOJET:MEAS<x>:BITType {ALLBits | NONTRANSition | TRANSition}
 DPOJET:MEAS<x>:BITType?

Inputs {ALLBits | NONTRANSition | TRANSition}

Outputs {ALLBits | NONTRANSition | TRANSition}

DPOJET:MEAS<x>:BUSState:CLOCKPolarity

This command sets or queries the clock polarity for the clock edge.

Syntax DPOJET:MEAS<x>:BUSState:CLOCKPolarity {RISING | FALLING}
DPOJET:MEAS<x>:BUSState:CLOCKPolarity?

Inputs {RISING | FALLING}

Outputs {RISing | FALLing}

DPOJET:MEAS<x>:BUSState:FROMPattern

This command sets or queries the Pattern from which the Bus state is configured.

Syntax DPOJET:MEAS<x>:BUSState:FROMPattern <string>
DPOJET:MEAS<x>:BUSState:FROMPattern?

Inputs <string>

Outputs <string>

DPOJET:MEAS<x>:BUSState:FROMSymbol

This command sets or queries the symbol from which the Bus state is configured.

Syntax DPOJET:MEAS<x>:BUSState:FROMSymbol <string>
DPOJET:MEAS<x>:BUSState:FROMSymbol?

Inputs <string>

Outputs <string>

DPOJET:MEAS<x>:BUSState:MEASUREType

This command sets or queries the type for which the bus state is configured.

Syntax DPOJET:MEAS<x>:BUSState:MEASBUStype {SYMBOL | PATtern}
DPOJET:MEAS<x>:BUSState:MEASBUStype?

Inputs {SYMBOL | PATtern}

Outputs {SYMBOL | PATtern}

DPOJET:MEAS<x>:BUSState:MEASUREFrom

This command sets or queries where the bus is measured from.

Syntax DPOJET:MEAS<x>:BUSState:MEASUREFROM {CLOCKEdge | START | STOP}
DPOJET:MEAS<x>:BUSState:MEASUREFROM?

Inputs {CLOCKEdge | START | STOP}

Outputs {CLOCKEdge | START | STOP}

DPOJET:MEAS<x>:BUSState:MEASURETO

This command sets or queries from where the bus is measured to.

Syntax DPOJET:MEAS<x>:BUSState:MEASURETO {START | STOP | CLOCKEdge}
DPOJET:MEAS<x>:BUSState:MEASURETO?

Inputs {CLOCKEdge | START | STOP}

Outputs {CLOCKEdge | START | STOP}

DPOJET:MEAS<x>:BUSState:TOPattern

This command sets or queries the Pattern to which the Bus state is configured.

Syntax DPOJET:MEAS<x>:BUSState: TOPattern <string>
DPOJET:MEAS<x>:BUSState: TOPattern?

Inputs <string>

Outputs <string>

DPOJET:MEAS<x>:BUSState:TOSymbol

This command sets or queries the symbol to which the Bus state is configured.

Syntax DPOJET:MEAS<x>:BUSState: TOSymbol <string>
DPOJET:MEAS<x>:BUSState: TOSymbol?

Inputs <string>

Outputs <string>

DPOJET:MEAS<x>:CLOCKRecovery:CLOCKBitrate

This command sets or queries the clock bit rate. Used if DATARate is 1.

Syntax DPOJET:MEAS<x>:CLOCKRecovery:CLOCKBitrate <NR3>
DPOJET:MEAS<x>:CLOCKRecovery:CLOCKBitrate?

Inputs <NR3>

Outputs <NR3>

DPOJET:MEAS<x>:CLOCKRecovery:CLOCKFrequency

This command sets or queries the clock frequency. Used with Constant Clock - Fixed clock recovery method.

Syntax DPOJET:MEAS<x>:CLOCKRecovery:CLOCKFrequency <NR3>
DPOJET:MEAS<x>:CLOCKRecovery:CLOCKFrequency?

Inputs <NR3>

Outputs <NR3>

DPOJET:MEAS<x>:CLOCKRecovery:CLOCKMultiplier

This command sets or queries the clock multiplier.

Syntax DPOJET:MEAS<x>:CLOCKRecovery:CLOCKMultiplier <NR3>
DPOJET:MEAS<x>:CLOCKRecovery:CLOCKMultiplier?

Inputs <NR3>

Outputs <NR3>

DPOJET:MEAS<x>:CLOCKRecovery:CLOCKPath

This command sets or queries the current known clock pattern path.

Syntax DPOJET:MEAS<x>:CLOCKRecovery:CLOCKPath <string>
DPOJET:MEAS<x>:CLOCKRecovery:CLOCKPath?

Inputs <string>

Outputs <string>

DPOJET:MEAS<x>:CLOCKRecovery:DAMPing

This command sets or queries the clock recovery damping value.

Syntax DPOJET:MEAS<x>:CLOCKRecovery:DAMPing <NR3>
DPOJET:MEAS<x>:CLOCKRecovery:DAMPing?

Inputs <NR3>

Outputs <NR3>

DPOJET:MEAS<x>:CLOCKRecovery:DATARate

This command turns on or off DATARate usage.

Syntax DPOJET:MEAS<x>:CLOCKRecovery:DATARate {1 | 0}

Inputs {1 | 0}

Outputs {1 | 0}

DPOJET:MEAS<x>:CLOCKRecovery:BWType

This command sets or queries the clock recovery bandwidth type.

Syntax DPOJET:MEAS<x>:CLOCKRecovery:BWType {LOOPBW | JTFBW}
 DPOJET:MEAS<x>:CLOCKRecovery:BWType?

Inputs {LOOPBW | JTFBW}

Outputs {LOOPBW | JTFBW}

DPOJET:MEAS<x>:CLOCKRecovery:LOOPBandwidth

This command sets or queries the clock recovery loop bandwidth.

Syntax DPOJET:MEAS<x>:CLOCKRecovery:LOOPBandwidth <NR3>
 DPOJET:MEAS<x>:CLOCKRecovery:LOOPBandwidth?

Inputs <NR3>

Outputs <NR3>

DPOJET:MEAS<x>:CLOCKRecovery:MEANAUTOCalculate

This command sets or queries how often the clock is calculated, either FIRST, or on EVERY acquisition.

Syntax DPOJET:MEAS<x>:CLOCKRecovery:MEANAUTOCalculate {FIRST | EVERY}
DPOJET:MEAS<x>:CLOCKRecovery:MEANAUTOCalculate?

Inputs {FIRST | EVERY}

Outputs {FIRST | EVERY}

DPOJET:MEAS<x>:CLOCKRecovery:METhod

This command sets or queries the current Clock recovery method.

Syntax DPOJET:MEAS<x>:CLOCKRecovery:METhod {STANDARD | CUSTOM | CONSTMEAN | CONSTFIXED | EXPEDGE | EXPPLL | CONSTMEDIAN}
DPOJET:MEAS<x>:CLOCKRecovery:METhod?

Inputs {STANDARD | CUSTOM | CONSTMEAN | CONSTFIXED | EXPEDGE | EXPPLL | CONSTMEDIAN}

Outputs {STANDARD | CUSTOM | CONSTMEAN | CONSTFIXED | EXPEDGE | EXPPLL | CONSTMEDIAN}

DPOJET:MEAS<x>:CLOCKRecovery:MODEl

This command sets or queries the current clock recovery model.

Syntax DPOJET:MEAS<x>:CLOCKRecovery:MODEl {ONE | TWO}
DPOJET:MEAS<x>:CLOCKRecovery:MODEl?

Inputs {ONE | TWO}

Outputs {ONE | TWO}

DPOJET:MEAS<x>:CLOCKRecovery:NOMINALOFFset

This command sets or queries the clock offset.

Syntax DPOJET:MEAS<x>:CLOCKRecovery:NOMINALOFFset <NR3>
DPOJET:MEAS<x>:CLOCKRecovery:NOMINALOFFset?

Inputs <NR3>

Outputs <NR3>

DPOJET:MEAS<x>:CLOCKRecovery:NOMINALOFFset:AUTO?

This query-only command returns the value in the Auto text box for the Nominal Clock Offset controls. If the nominal clock offset method selection type is set to Auto and an acquisition cycle has been completed, this field shows the clock-to-data offset that was automatically determined. A positive value means that the clock leads the data (precedes it in time). If the offset has not been determined, the returned string is TBD.

Syntax DPOJET:MEAS<x>:CLOCKRecovery:NOMINALOFFset:AUTO?

Outputs <string>

DPOJET:MEAS<x>:CLOCKRecovery:NOMINALOFFset:MANual

This command sets or queries the value for Manual text box.

Syntax DPOJET:MEAS<x>:CLOCKRecovery:NOMINALOFFset:MANual <NR3>
DPOJET:MEAS<x>:CLOCKRecovery:NOMINALOFFset:MANual?

Inputs <NR3>

Outputs <NR3>

DPOJET:MEAS<x>:CLOCKRecovery:NOMINALOFFset:Recalctype

This command sets or queries the recalculation list box.

Syntax DPOJET:MEAS<x>:CLOCKRecovery:NOMINALOFFset:Recalctype {FIRST | EVERY}

DPOJET:MEAS<x>:CLOCKRecovery:NOMINALOFFset:Recalctype?

Inputs {FIRST | EVERY}

Outputs {FIRST | EVERY}

DPOJET:MEAS<x>:CLOCKRecovery:NOMINALOFFset:SELECTIONtype

This command sets or queries the selection type.

Syntax DPOJET:MEAS<x>:CLOCKRecovery:NOMINALOFFset:SELECTIONtype {AUTO | MANUAL}

DPOJET:MEAS<x>:CLOCKRecovery:NOMINALOFFset:SELECTIONtype?

Inputs {AUTO | MANUAL}

Outputs {AUTO | MANUAL}

DPOJET:MEAS<x>:CLOCKRecovery:PATtern

This command turns on or off the usage of CLOCKPath to a specific known data pattern.

Syntax DPOJET:MEAS<x>:CLOCKRecovery:PATtern {1 | 0}

Inputs {1 | 0}

Outputs {1 | 0}

DPOJET:MEAS<x>:CLOCKRecovery:STANDARD

This command sets or queries the current clock recovery standard, as specified in the user interface.

Syntax DPOJET:MEAS<x>:CLOCKRecovery:STANDARD <string>
DPOJET:MEAS<x>:CLOCKRecovery:STANDARD?

Inputs <string>

Outputs <string>

DPOJET:MEAS<x>:COMMONMode:FILTers:STATE

This command sets or queries the state of the common mode filter frequency.

Syntax DPOJET:MEAS<x>:COMMONMode:FILTers:STATE {ON | OFF}
 DPOJET:MEAS<x>:COMMONMode:FILTers:STATE?

Inputs {ON | OFF}

Outputs {1 | 0}

DPOJET:MEAS<x>:CUSTomname

This command sets or queries the custom measurement name for the measurement in slot x.

Syntax DPOJET:MEAS<x>:CUSTomname <string>
 DPOJET:MEAS<x>:CUSTomname?

Inputs <string>

Outputs <string>

DPOJET:MEAS<x>:DATA?

This query-only command returns the measurement data. This is similar to the curve query, where the output is in the format #<x><yyy><data><newline>, where <x> is the number of <y> bytes.

For Example: If <yyy>=500, <x>=3

NOTE. <x> is hexadecimal format. The letters A-F denote the number of y bytes between 10 and 15 digits.

<yyy> is the number of bytes to transfer.

<data> is curve data.

<newline> is a single-byte new line character at the end of the data.

Syntax DPOJET:MEAS<x>:DATA?

Outputs The measurement values as a stream of doubles.

DPOJET:MEAS<x>:DFE:RESOLution

This command sets or queries the resolution.

Syntax DPOJET:MEAS<x>:DFE:RESOLution <NR3>
DPOJET:MEAS<x>:DFE:RESOLution?

Inputs <NR3>

Outputs <NR3>

DPOJET:MEAS<x>:DFE:TAPState

This command sets or queries the tap value state, either on or off.

Syntax DPOJET:MEAS<x>:DFE:TAPState {0|1}
DPOJET:MEAS<x>:DFE:TAPState?

Inputs {1 | 0}

Outputs {1 | 0}

DPOJET:MEAS<x>:DFE:ABSOLUTEState

This command sets or queries the Absolute voltage/time state of the DPOJET application.

Syntax DPOJET:MEAS<x>:DFE:ABSOLUTEState {1 | 0}
DPOJET:MEAS<x>:DFE:ABSOLUTEState?

Inputs {1 | 0}

Outputs {1 | 0}

DPOJET:MEAS<x>:DFE:ABSOLUTEValue

This command sets or queries the Absolute Voltage/time value of the DPOJET application.

Syntax DPOJET:MEAS<x>:DFE:ABSOLUTEValue <NR3>
DPOJET:MEAS<x>:DFE:ABSOLUTEValue?

Inputs <NR3>

Outputs <NR3>

DPOJET:MEAS<x>:DFE:MEASatpercent

This command sets or queries the measure at X% value.

Syntax DPOJET:MEAS<x>:DFE:MEASatpercent <NR3>
DPOJET:MEAS<x>:DFE:MEASatpercent?

Inputs <NR3>

Outputs <NR3>

DPOJET:MEAS<x>:DISPLAYNAME?

This command queries the UI name of the measurement x in the measurement table.

Syntax DPOJET:MEAS<x>:DISPLAYNAME?

Outputs <string>

NOTE. *If the measurement UI name has special character δ , then it is displayed as d.*

DPOJET:MEAS<x>:DFE:TAPValue

This command sets or queries the tap value.

Syntax DPOJET:MEAS<x>:DFE:TAPValue <NR3>
DPOJET:MEAS<x>:DFE:TAPValue?

Inputs <NR3>

Outputs <NR3>

DPOJET:MEAS<x>:EDGE1

This command sets or queries the Source1 edge type.

Syntax DPOJET:MEAS<x>:EDGE1 {RISe | FALL | BOTH}
DPOJET:MEAS<x>:EDGE1?

Inputs {RISe | FALL | BOTH}

Outputs {RISe | FALL | BOTH}

DPOJET:MEAS<x>:EDGE2

This command sets or queries the Source2 edge type.

Syntax DPOJET:MEAS<x>:EDGE2 {RISe | FALL | BOTH}
DPOJET:MEAS<x>:EDGE2?

Inputs {RISe | FALL | BOTH}

Outputs {RISe | FALL | BOTH}

DPOJET:MEAS<x>:EDGEInce

This command sets or queries the measurement edge increment value.

Syntax DPOJET:MEAS<x>:EDGEInce <NR3>
 DPOJET:MEAS<x>:EDGEInce?

Inputs <NR3>

Outputs <NR1>

DPOJET:MEAS<x>:EDGES:FROMLevel

This command sets or queries the FromLevel edge for the measurement.

Syntax DPOJET:MEAS<x>:EDGES:FROMLevel {HIGH | MID | LOW}
 DPOJET:MEAS<x>:EDGES:FROMLevel?

Inputs {HIGH | MID | LOW}

Outputs {HIGH | MID | LOW}

DPOJET:MEAS<x>:EDGES:LEVel

This command sets or queries the level used for the edges configuration.

Syntax DPOJET:MEAS<x>:EDGES:LEVel
DPOJET:MEAS<x>:EDGES:LEVel?

Inputs {HIGH | MID | LOW}

Outputs {HIGH | MID | LOW}

DPOJET:MEAS<x>:EDGES:SLEWRATETechnique

This command sets or queries the slew rate technique for the measurement.

Syntax DPOJET:MEAS<x>:EDGES:SLEWRATETechnique {NOMInalmethod |
DDRmethod}
DPOJET:MEAS<x>:EDGES:SLEWRATETechnique?

Inputs {NOMInalmethod | DDRmethod}

Outputs {NOMInalmethod | DDRmethod}

DPOJET:MEAS<x>:EDGES:SUBRATEDivisor

This command sets or queries the substrate divisor value for the application measurement slot with index <x>.

Syntax DPOJET:MEAS<x>:EDGES:SUBRATEDivisor {TWO | FOUR | EIGHT}
DPOJET:MEAS<x>:EDGES:SUBRATEDivisor?

Inputs {TWO | FOUR | EIGHT}

Outputs {TWO | FOUR | EIGHT}

DPOJET:MEAS<x>:EDGES:EYEHeightstate

This command sets or queries the automated eye height state, either on or off.

Syntax DPOJET:MEAS<x>:EDGES:EYEHeightstate {1 | 0}
DPOJET:MEAS<x>:EDGES:EYEHeightstate?

Inputs {1 | 0}

Outputs {1 | 0}

DPOJET:MEAS<x>:EDGES:VOLTAGEState

This command sets or queries the user defined voltage state, either on or off.

Syntax DPOJET:MEAS<x>:EDGES:VOLTAGEState {1 | 0}
DPOJET:MEAS<x>:EDGES:VOLTAGEState {1 | 0}

Inputs {1 | 0}

Outputs {1 | 0}

DPOJET:MEAS<x>:EDGES:USERDefinedvoltage

This command sets or queries the user defined voltage.

Syntax DPOJET:MEAS<x>:EDGES:USERDefinedvoltage <NR3>
DPOJET:MEAS<x>:EDGES:USERDefinedvoltage?

Inputs <NR3>

Outputs <NR3>

DPOJET:MEAS<x>:EDGES:TOLevel

This command sets or queries the ToLevel edge for the measurement.

Syntax DPOJET:MEAS<x>:EDGES:TOLevel {HIGH | MID | LOW}
DPOJET:MEAS<x>:EDGES:TOLevel?

Inputs {HIGH | MID | LOW}

Outputs {HIGH | MID | LOW}

DPOJET:MEAS<x>:FILTerS:BLANKingtime

This command sets or queries the current filter blanking time.

Syntax DPOJET:MEAS<x>:FILTerS:BLANKingtime <NR3>
DPOJET:MEAS<x>:FILTerS:BLANKingtime?

Inputs <NR3>

Outputs <NR3>

DPOJET:MEAS<x>:FILTERs:HIGHPass:FREQ

This command sets or queries the current high pass filter frequency.

Syntax DPOJET:MEAS<x>:FILTERs:HIGHPass:FREQ <NR3>
DPOJET:MEAS<x>:FILTERs:HIGHPass:FREQ?

Inputs <NR3>

Outputs <NR3>

DPOJET:MEAS<x>:FILTERs:HIGHPass:SPEC

This command sets or queries the current high pass filter specification.

Syntax DPOJET:MEAS<x>:FILTERs:HIGHPass:SPEC {NONE | FIRST | SECOND | THIRD}
DPOJET:MEAS<x>:FILTERs:HIGHPass:SPEC?

Inputs {NONE | FIRST | SECOND | THIRD}

Outputs {NONE | FIRST | SECOND | THIRD}

DPOJET:MEAS<x>:FILTerS:LOWPass:FREQ

This command sets or queries the current low pass filter frequency.

Syntax DPOJET:MEAS<x>:FILTerS:LOWPass:FREQ <NR3>
 DPOJET:MEAS<x>:FILTerS:LOWPass:FREQ?

Inputs <NR3>

Outputs <NR3>

DPOJET:MEAS<x>:FILTerS:LOWPass:SPEC

This command sets or queries the current low pass filter specification.

Syntax DPOJET:MEAS<x>:FILTerS:LOWPass:SPEC {NONE | FIRST | SECOND | THIRD}
 DPOJET:MEAS<x>:FILTerS:LOWPass:SPEC?

Inputs {NONE | FIRST | SECOND | THIRD}

Outputs {NONE | FIRST | SECOND | THIRD}

DPOJET:MEAS<x>:FILTERs:SJBAndwidth

This command sets or queries the SJ Bandwidth of SJ@FREQ measurement for the application measurement slot with index <x>.

Syntax DPOJET:MEAS<x>:FILTERs:SJBAndwidth <NR3>
DPOJET:MEAS<x>:FILTERs:SJBAndwidth?

Inputs <NR3>

Outputs <NR3>

DPOJET:MEAS<x>:FILTERs:SJFrequency

This command sets or queries the SJ Frequency of SJ@FREQ measurement for the application measurement slot with index <x>.

Syntax DPOJET:MEAS<x>:FILTERs:SJFrequency <NR3>
DPOJET:MEAS<x>:FILTERs:SJFrequency?

Inputs <NR3>

Outputs <NR3>

DPOJET:MEAS<x>:REFVoltage

This command sets or queries the reference voltage for the measurement.

Syntax DPOJET:MEAS<x>:REFVoltage {100 | -100}
DPOJET:MEAS<x>:REFVoltage?

Inputs {100 | -100}

Outputs {100 | -100}

DPOJET:MEAS<x>:FILTerS:RAMPTime

This command sets or queries the current filter ramp time.

Syntax DPOJET:MEAS<x>:FILTerS:RAMPTime <NR3>
DPOJET:MEAS<x>:FILTerS:RAMPTime?

Inputs <NR3>

Outputs <NR3>

DPOJET:MEAS<x>:FROMedge

This command sets the FROMedge value for the measurement.

Syntax DPOJET:MEAS<x>:FROMedge {RISe | FALL | BOTH}

Inputs {RISe | FALL | BOTH}

Outputs {RISe | FALL | BOTH}

DPOJET:MEAS<x>:HIGHREFVoltage

This command sets or queries the high reference voltage value for the selected configuration.

Syntax DPOJET:MEAS<x>:HIGHREFVoltage <NR3>
DPOJET:MEAS<x>:HIGHREFVoltage?

Inputs <NR3>

Outputs <NR3>

DPOJET:MEAS<x>:LOWREFVoltage

This command sets or queries the low reference voltage value for the selected configuration.

Syntax DPOJET:MEAS<x>:LOWREFVoltage <NR3>
DPOJET:MEAS<x>:LOWREFVoltage?

Inputs <NR3>

Outputs <NR3>

DPOJET:MEAS<x>:LOGging:MEASurements:FILEname?

This command queries the current file name that will be used for the measurement when measurement logging is turned on.

Syntax DPOJET:MEAS<x>:LOGging:MEASurements:FILEname?

Outputs <string>

DPOJET:MEAS<x>:LOGging:MEASurements:SElect

This command sets or queries the given measurement to be included in any measurement logging. Statistic logging is turned on or off as a whole, using the DPOJET:LOGging branch.

Syntax DPOJET:MEAS<x>:LOGging:MEASurements:SElect {1 | 0}
DPOJET:MEAS<x>:LOGging:MEASurements:SElect?

Inputs {1 | 0}

Outputs {1 | 0}

DPOJET:MEAS<x>:LOGging:STATistics:SElect

This command sets or queries the given measurement for inclusion in any statistic logging. Statistic logging is turned on or off as a whole, using the DPOJET:LOGging branch.

Syntax DPOJET:MEAS<x>:LOGging:STATistics:SElect {1 | 0}
DPOJET:MEAS<x>:LOGging:STATistics:SElect?

Inputs {1 | 0}

Outputs {1 | 0}

DPOJET:MEAS<x>:LOGging:WORSTcase:SElect

This command sets or queries the given measurement for inclusion in any worst-case logging. Statistic logging is turned on or off as a whole, using the DPOJET:LOGging branch.

Syntax DPOJET:MEAS<x>:LOGging:WORSTcase:SElect {1 | 0}

Inputs DPOJET:MEAS<x>:LOGging:WORSTcase:SElect?
{1 | 0}

Outputs {1 | 0}

DPOJET:MEAS<x>:MARGIN:HITCOUNTValue

This command sets or queries the HitCount value.

Syntax DPOJET:MEAS<x>:MARGIN:HITCOUNTValue <NR3>
DPOJET:MEAS<x>:MARGIN:HITCOUNTValue?

Inputs <NR3>

Outputs <NR3>

DPOJET:MEAS<x>:MARGIN:HITRATIOState

This command sets or queries the HitRatio state.

Syntax DPOJET:MEAS<x>:MARGIN:HITRATIOState {1 | 0}
DPOJET:MEAS<x>:MARGIN:HITRATIOState?

Inputs {1 | 0}

Outputs {1 | 0}

DPOJET:MEAS<x>:MARGIN:HITRATIOValue

This command sets or queries the HitRatio value.

Syntax DPOJET:MEAS<x>:MARGIN:HITRATIOValue <NR3>
DPOJET:MEAS<x>:MARGIN:HITRATIOValue?

Inputs <NR3>

Outputs <NR3>

DPOJET:MEAS<x>:MARGIN:RESolution

This command sets or queries the resolution value.

Syntax DPOJET:MEAS<x>:MARGIN:RESolution <NR3>
DPOJET:MEAS<x>:MARGIN:RESolution?

Inputs <NR3>

Outputs <NR3>

DPOJET:MEAS<x>:MASKfile

This command sets or queries the current mask file name.

Syntax DPOJET:MEAS<x>:MASKfile <string>
DPOJET:MEAS<x>:MASKfile?

Inputs <string>

Outputs <string>

DPOJET:MEAS<x>:MASKOffset:HORizontal:SELECTIONtype

This command sets or queries the selection type.

Syntax DPOJET:MEAS<x>:MASKOffset:HORizontal:SELECTIONtype { AUTOFIT | MANUAL }
DPOJET:MEAS<x>:MASKOffset:HORizontal:SELECTIONtype?

Inputs {AUTOFIT | MANUAL}

Outputs {AUTOFIT | MANUAL}

DPOJET:MEAS<x>:MASKOffset:HORizontal:AUTOfit?

This query-only command returns the value in the Autofit text box for the Mask Offset controls. If the mask offset method selection type is set to Autofit and an acquisition cycle has been completed, this field shows the displacement of the mask offset that was automatically determined. A positive value means that the mask has moved to the right. If the offset has not been determined, the returned string is TBD.

Syntax DPOJET:MEAS<x>:MASKOffset:HORizontal:AUTOfit?

Outputs <string>

DPOJET:MEAS<x>:MASKOffset:HORizontal:MANual

This command sets or queries the value for Manual text box.

Syntax DPOJET:MEAS<x>:MASKOffset:HORizontal:MANual <NR3>
DPOJET:MEAS<x>:MASKOffset:HORizontal:MANual?

Inputs <NR3>

Outputs <NR3>

DPOJET:MEAS<x>:MEASRange:MAX

This command sets or queries the maximum measurement range limit value.

Syntax DPOJET:MEAS<x>:MEASRange:MAX <NR3>
DPOJET:MEAS<x>:MEASRange:MAX?

Inputs <NR3>

Outputs <NR3>

DPOJET:MEAS<x>:MEASRange:MIN

This command sets or queries the minimum measurement range limit value.

Syntax DPOJET:MEAS<x>:MEASRange:MIN <NR3>
DPOJET:MEAS<x>:MEASRange:MIN?

Inputs <NR3>

Outputs <NR3>

DPOJET:MEAS<x>:MEASRange:STATE

This command turns on or off the measurement range limits.

Syntax DPOJET:MEAS<x>:MEASRange:STATE {1 | 0}

Inputs {1 | 0}

Outputs {1 | 0}

DPOJET:MEAS<x>:MEASStart

This command sets or queries the measurement start value.

Syntax DPOJET:MEAS<x>:MEASStart <NR3>
DPOJET:MEAS<x>:MEASStart?

Inputs <NR3>

Outputs <NR1>

DPOJET:MEAS<x>:N

This command sets or queries the measurement N value.

Syntax DPOJET:MEAS<x>:N <NR3>
DPOJET:MEAS<x>:N?

Inputs <NR3>

Outputs <NR1>

DPOJET:MEAS<x>:NAME?

This query-only command returns the measurement name for the measurement in slot x. For measurements that include 16-bit characters in their UI names, such as DJDirac, the string returned will contain question marks where the UI contains nontext characters.

Syntax DPOJET:MEAS<x>:NAME?

Outputs <string>

DPOJET:MEAS<x>:PHASENoise:HIGHLimit

This command sets or queries the upper phase noise integration limit.

Syntax DPOJET:MEAS<x>:PHASENoise:HIGHLimit <NR3>
DPOJET:MEAS<x>:PHASENoise:HIGHLimit?

Inputs <NR3>

Outputs <NR3>

DPOJET:MEAS<x>:PHASENoise:LOWLimit

This command sets or queries the lower phase noise integration limit.

Syntax DPOJET:MEAS<x>:PHASENoise:LOWLimit <NR3>
 DPOJET:MEAS<x>:PHASENoise:LOWLimit?

Inputs <NR3>

Outputs <NR3>

DPOJET:MEAS<x>:REFVoltage

This command sets or queries the reference voltage for the measurement.

Syntax DPOJET:MEAS<x>:REFVoltage {100 | —100}
 DPOJET:MEAS<x>:REFVoltage?

Inputs {100 | —100}

Outputs {100 | —100}

DPOJET:MEAS<x>:RESULts?

This query-only command returns the measurement branch for the currently selected measurement for measurement slot <x>.

Syntax DPOJET:MEAS<x>:RESULts?

Outputs The measurement branch for the selected measurement for measurement slot x.

DPOJET:MEAS<x>:RESULts:ALLAcqs?

This query-only command returns the measurement results from all acquisitions.

Syntax DPOJET:MEAS<x>:RESULts:ALLAcqs?

Outputs <NR3>

DPOJET:MEAS<x>:RESULts:ALLAcqs:HITPopulation?

This query-only command returns the mask hit population.

Syntax DPOJET:MEAS<x>:RESULts:ALLAcqs:HITPopulation?

Outputs <NR3>

DPOJET:MEAS<x>:RESULts:ALLAcqs:HITS?

This query-only command returns the mask hits measurement for all segments.

Syntax DPOJET:MEAS<x>:RESULts:ALLAcqs:HITS?

Outputs <NR3>

DPOJET:MEAS<x>:RESULts:ALLAcqs:LIMits:STATus?

This query-only command returns the pass/fail status per measurement. If any of the statistics fails, the cumulative result is fail, otherwise pass.

Syntax DPOJET:MEAS<x>:RESULts:ALLAcqs:LIMits:STATus?

Outputs {PASS | FAIL}

DPOJET:MEAS<x>:RESULts:ALLAcqs:LIMits:Hgh:STATus?

This query-only command returns the pass/fail status for high limit.

Syntax DPOJET:MEAS<x>:RESULts:ALLAcqs:LIMits:Hgh:STATus?

Outputs {PASS | FAIL}

DPOJET:MEAS<x>:RESULts:ALLAcqs:LIMits:LOW:STATus?

This query-only command returns the pass/fail status for low limit.

Syntax DPOJET:MEAS<x>:RESULts:ALLAcqs:LIMits:LOW:STATus?

Outputs {PASS | FAIL}

DPOJET:MEAS<x>:RESULts:ALLAcqs:MAX?

This query-only command returns the maximum value for all accumulated measurement acquisitions for slot <x>.

Syntax DPOJET:MEAS<x>:RESULts:ALLAcqs:MAX?

Outputs <NR3>

DPOJET:MEAS<x>:RESULts:ALLAcqs:MAXCC?

This query-only command returns the maximum positive cycle-to-cycle delta of the selected measurement.

Syntax DPOJET:MEAS<x>:RESULts:ALLAcqs:MAXCC?

Outputs <NR3>

DPOJET:MEAS<x>:RESULts:ALLAcqs:MAXCC:STATus?

This query-only command returns the pass/fail status for the maximum positive cycle-to-cycle delta of the selected measurement (set via :DPOJET:LIMits:FILEName).

Syntax DPOJET:MEAS<x>:RESULts:ALLAcqs:MAXCC:STATus?

Outputs {PASS | FAIL}

DPOJET:MEAS<x>:RESULts:ALLAcqs:MAXHits?

This query-only command returns the maximum mask hits measurement for all segments.

Syntax DPOJET:MEAS<x>:RESULts:ALLAcqs:MAXHits?

Outputs <NR3>

DPOJET:MEAS<x>:RESULts:ALLAcqs:MAX:STATus?

This query-only command returns the pass/fail status for the max measurement for the currently loaded limit file (set via :DPOJET:LIMits:FILEName).

Syntax DPOJET:MEAS<x>:RESULts:ALLAcqs:MAX:STATus?

Outputs {PASS | FAIL}

DPOJET:MEAS<x>:RESULts:ALLAcqs:MAX:HIGHLimit?

This query-only command returns the high limit value of Max for measurement <x>.

Syntax DPOJET:MEAS<x>:RESULts:ALLAcqs:MAX:HIGHLimit?

Outputs <NR3>

DPOJET:MEAS<x>:RESULts:ALLAcqs:MAX:HIGHMArgin?

This query-only command returns the high margin value of Max for measurement <x>.

Syntax DPOJET:MEAS<x>:RESULts:ALLAcqs:MAX:HIGHMArgin?

Outputs <NR3>

DPOJET:MEAS<x>:RESULts:ALLAcqs:MIN:LOWLimit?

This query-only command returns the low limit value of Min for measurement <x>.

Syntax DPOJET:MEAS<x>:RESULts:ALLAcqs:MIN:LOWLimit?

Outputs <NR3>

DPOJET:MEAS<x>:RESULts:ALLAcqs:MIN:LOWMArgin?

This query-only command returns the low margin value of Min for measurement <x>.

Syntax DPOJET:MEAS<x>:RESULts:ALLAcqs:MIN:LOWMArgin?

Outputs <NR3>

DPOJET:MEAS<x>:RESULts:ALLAcqs:MEAN?

This query-only command returns the mean value for all accumulated measurement acquisitions for slot <x>.

Syntax DPOJET:MEAS<x>:RESULts:ALLAcqs:MEAN?

Outputs <NR3>

DPOJET:MEAS<x>:RESULts:ALLAcqs:MEAN:HIGHLimit?

This query-only command returns the high limit value of Mean for measurement <x>.

Syntax DPOJET:MEAS<x>:RESULts:ALLAcqs:MEAN:HIGHLimit?

Outputs <NR3>

DPOJET:MEAS<x>:RESULts:ALLAcqs:MEAN:STATus?

This query-only command returns the pass/fail status for the mean measurement for the currently loaded limit file (set via :DPOJET:LIMits:FILEName).

Syntax DPOJET:MEAS<x>:RESULts:ALLAcqs:MEAN:STATus?

Outputs {PASS | FAIL}

DPOJET:MEAS<x>:RESULts:ALLAcqs:MIN?

This query-only command returns the minimum value for all accumulated measurement acquisitions for slot <x>.

Syntax DPOJET:MEAS<x>:RESULts:ALLAcqs:MIN?

Outputs <NR3>

DPOJET:MEAS<x>:RESULts:ALLAcqs:MINCC?

This query-only command returns the maximum negative cycle-to-cycle delta of the selected measurement.

Syntax DPOJET:MEAS<x>:RESULts:ALLAcqs:MINCC?

Outputs <NR3>

DPOJET:MEAS<x>:RESULts:ALLAcqs:MINCC:STATus?

This query-only command returns the pass/fail status for the negative cycle-to-cycle delta of the selected measurement.

Syntax DPOJET:MEAS<x>:RESULts:ALLAcqs:MINCC:STATus?

Outputs {PASS | FAIL}

DPOJET:MEAS<x>:RESULts:ALLAcqs:MINHits?

This query-only command returns the minimum mask hits measurement for all segments.

Syntax DPOJET:MEAS<x>:RESULts:ALLAcqs:MINHits?

Outputs <NR3>

DPOJET:MEAS<x>:RESULts:ALLAcqs:MIN:STATus?

This query-only command returns the pass/fail status for the minimum measurement for the currently loaded limit file (set via :DPOJET:LIMits:FILEName).

Syntax DPOJET:MEAS<x>:RESULts:ALLAcqs:MIN:STATus?

Outputs {PASS | FAIL}

DPOJET:MEAS<x>:RESULts:ALLAcqs:PK2PK?

This query-only command returns the peak-to-peak value for all accumulated measurement acquisitions for slot <x>.

Syntax DPOJET:MEAS<x>:RESULts:ALLAcqs:PK2PK?

Outputs <NR3>

DPOJET:MEAS<x>:RESULts:ALLAcqs:PK2PK:STATus?

This query-only command returns the pass/fail status for the peak-to-peak measurement for the currently loaded limit file (set via :DPOJET:LIMits:FILEName).

Syntax DPOJET:MEAS<x>:RESULts:ALLAcqs:PK2PK:STATus?

Outputs {PASS | FAIL}

DPOJET:MEAS<x>:RESULts:ALLAcqs:POPULation?

This query-only command returns the mean measurement value for the currently selected measurement for measurement slot <x>.

Syntax DPOJET:MEAS<x>:RESULts:ALLAcqs:POPULation?

Outputs <NR1>

DPOJET:MEAS<x>:RESULts:ALLAcqs:POPULation:STATus?

This query-only command returns the pass/fail status for the population measurement for the currently loaded limit file (set via :DPOJET:LIMits:FILEName).

Syntax DPOJET:MEAS<x>:RESULts:ALLAcqs:POPULation:STATus?

Outputs {PASS | FAIL}

DPOJET:MEAS<x>:RESULts:ALLAcqs:SEG(x):Hits?

This query-only command returns the mask hits measurement for the given segment, either SEG1, SEG2 or SEG3.

Syntax DPOJET:MEAS<x>:RESULts:ALLAcqs:SEG<x>:Hits?

Outputs <NR3>

DPOJET:MEAS<x>:RESULts:ALLAcqs:SEG(x):MAXHits?

This query-only command returns the maximum mask hits measurement for the given segment, either SEG1, SEG2 or SEG3.

Syntax DPOJET:MEAS<x>:RESULts:ALLAcqs:SEG<x>:MAXHits?

Outputs <NR3>

DPOJET:MEAS<x>:RESULts:ALLAcqs:SEG(x):MINHits?

This query-only command returns the minimum mask hits measurement for the given segment, either SEG1, SEG2 or SEG3.

Syntax DPOJET:MEAS<x>:RESULts:ALLAcqs:SEG<x>:MINHits?

Outputs <NR3>

DPOJET:MEAS<x>:RESULts:ALLAcqs:STDDev?

This query-only command returns the standard deviation for all accumulated measurement acquisitions for slot <x>.

Syntax DPOJET:MEAS<x>:RESULts:ALLAcqs:STDDev?

Outputs <NR3>

DPOJET:MEAS<x>:RESULts:ALLAcqs:STDDEV:STATUs?

This query-only command returns the pass/fail status for the standard deviation measurement for the currently loaded limit file (set via :DPOJET:LIMits:FILEName).

Syntax DPOJET:MEAS<x>:RESULts:ALLAcqs:STDDEV:STATUs?

Outputs {PASS | FAIL}

DPOJET:MEAS<x>:RESULts:CURRentacq:MAX?

This query-only command returns the maximum value of the measurement value for the currently selected measurement for measurement slot <x>.

Syntax DPOJET:MEAS<x>:RESULts:CURRentacq:MAX?

Outputs <NR3>

DPOJET:MEAS<x>:RESULts:CURRentacq:MAXCC?

This query-only command returns the maximum positive cycle-to-cycle delta of the selected measurement.

Syntax DPOJET:MEAS<x>:RESULts:CURRentacq:MAXCC?

Outputs <NR3>

DPOJET:MEAS<x>:RESULts:CURRentacq:MAXCC:STATus?

This query-only command returns the pass/fail status for the Max cycle-to-cycle measurement for the currently loaded limit file. (Set using DPOJET:LIMits:FILEName).

Syntax DPOJET:MEAS<x>:RESULts:CURRentacq:MAXCC:STATus?

Outputs {PASS | FAIL}

DPOJET:MEAS<x>:RESULts:CURRentacq:MAX:STATus?

This query-only command returns the pass/fail status for the max measurement for the currently loaded limit file. (Set using DPOJET:LIMits:FILEName).

Syntax DPOJET:MEAS<x>:RESULts:CURRentacq:MAX:STATus?

Outputs {PASS | FAIL}

DPOJET:MEAS<x>:RESULts:CURRentacq:MEAN?

This query-only command returns the mean value of the measurement for the current acquisition or for the most recent processing cycle.

Syntax DPOJET:MEAS<x>:RESULts:CURRentacq:MEAN?

Outputs <NR3>

DPOJET:MEAS<x>:RESULts:CURRentacq:MEAN:STATus?

This query-only command returns the pass/fail status for the mean measurement for the currently loaded limit file. (Set using DPOJET:LIMits:FILEName).

Syntax DPOJET:MEAS<x>:RESULts:CURRentacq:MEAN:STATus?

Outputs {PASS | FAIL}

DPOJET:MEAS<x>:RESULts:CURRentacq:MIN?

This query-only command returns the minimum value for the currently selected measurement for measurement slot <x>.

Syntax DPOJET:MEAS<x>:RESULts:CURRentacq:MIN?

Outputs <NR3>

DPOJET:MEAS<x>:RESULts:CURRentacq:MINCC?

This query-only command returns the maximum negative cycle-to-cycle delta of the selected measurement.

Syntax DPOJET:MEAS<x>:RESULts:CURRentacq:MINCC?

Outputs <NR3>

DPOJET:MEAS<x>:RESULts:CURRentacq:MINCC:STATus?

This query-only command returns the pass/fail status for the min cycle-to-cycle measurement for the currently loaded limit file. (Set using DPOJET:LIMits:FILEName).

Syntax DPOJET:MEAS<x>:RESULts:CURRentacq:MINCC:STATus?

Outputs {PASS | FAIL}

DPOJET:MEAS<x>:RESULts:CURRentacq:MIN:STATus?

This query-only command returns the pass/fail status for the minimum measurement for the currently loaded limit file. (Set using DPOJET:LIMits:FILEName).

Syntax DPOJET:MEAS<x>:RESULts:CURRentacq:MIN:STATus?

Outputs {PASS | FAIL}

DPOJET:MEAS<x>:RESULts:CURRentacq:PK2PK?

This query-only command returns the peak-to-peak value for the currently selected measurement for measurement slot <x>.

Syntax DPOJET:MEAS<x>:RESULts:CURRentacq:PK2PK?

Outputs <NR3>

DPOJET:MEAS<x>:RESULts:CURRentacq:PK2PK:STATus?

This query-only command returns the pass/fail status for the peak-to-peak measurement for the currently loaded limit file. (Set using DPOJET:LIMits:FILEName).

Syntax DPOJET:MEAS<x>:RESULts:CURRentacq:PK2PK:STATus?

Outputs {PASS | FAIL}

DPOJET:MEAS<x>:RESULts:CURRentacq:POPulation?

This query-only command returns the population measurement value for the currently selected measurement for measurement slot <x>.

Syntax DPOJET:MEAS<x>:RESULts:CURRentacq:POPulation?

Outputs <NR1>

DPOJET:MEAS<x>:RESULts:CURRentacq:POPulation:STATus?

This query-only command returns the pass/fail status for the population measurement for the currently loaded limit file. (Set using DPOJET:LIMits:FILEName).

Syntax DPOJET:MEAS<x>:RESULts:CURRentacq:POPulation:STATus?

Outputs {PASS | FAIL}

DPOJET:MEAS<x>:RESULts:CURRentacq:STDDev?

This query-only command returns the standard deviation of the measurement value for the currently selected measurement for measurement slot <x>.

Syntax DPOJET:MEAS<x>:RESULts:CURRentacq:StdDev?

Outputs <NR3>

DPOJET:MEAS<x>:RESULts:CURRentacq:STDDev:STATus?

This query-only command returns the pass/fail status for the standard deviation measurement for the currently loaded limit file. (Set using DPOJET:LIMits:FILEName).

Syntax DPOJET:MEAS<x>:RESULts:CURRentacq:STDDev:STATus?

Outputs {PASS | FAIL}

DPOJET:MEAS<x>:RESULTS:STATus?

This query-only command returns the status of the given measurement values in slot MEAS<x>. Valid for currently valid measurements, or the error status such as “Not enough edges”.

Syntax DPOJET:MEAS<x>:RESULTS:STATus?

Outputs <string>

DPOJET:MEAS<x>:RESULTs:Vlew?

This query-only command returns the results view type.

Syntax DPOJET:MEAS<x>:RESULTs:Vlew?

Outputs {SUMmary | DETails}

DPOJET:MEAS<x>:RJDJ:BER

This command sets or queries the RJDJ Target BER value.

Syntax DPOJET:MEAS<x>:RJDJ:BER <NR3>
DPOJET:MEAS<x>:RJDJ:BER?

Inputs <NR3>

Outputs <NR3>

DPOJET:MEAS<x>:RJDJ:DETECTPLEN

This command sets or queries the current detect plan.

Syntax DPOJET:MEAS<x>:RJDJ:DETECTPLEN {0 | 1 | ON | OFF}

Inputs <NR3>
0 is Manual
1 is Auto

Outputs <NR3>

DPOJET:MEAS<x>:RJDJ:PATLen

This command sets or queries the current RJDJ pattern length.

Syntax DPOJET:MEAS<x>:RJDJ:PATLen <NR3>
DPOJET:MEAS<x>:RJDJ:PATLen?

Inputs <NR3>

Outputs <NR3>

DPOJET:MEAS<x>:RJDJ:TYPE

This command sets or queries the current RJDJ measurement type.

Syntax DPOJET:MEAS<x>:RJDJ:TYPE {ARBITrary | REPEating}
DPOJET:MEAS<x>:RJDJ:TYPE?

Inputs {ARBITrary | REPEating}

Outputs {ARBITrary | REPEating}

DPOJET:MEAS<x>:RJDJ:WINDOwlength

This command sets or queries the current RJDJ window length.

Syntax DPOJET:MEAS<x>:RJDJ:WINDOwlength <NR3>
DPOJET:MEAS<x>:RJDJ:WINDOwlength?

Inputs <NR3>

Outputs <NR3>

DPOJET:MEAS<x>:RNDN:BER

This command sets or queries the RNDN Target BER value.

Syntax DPOJET:MEAS<x>:RNDN:BER <NR3>
DPOJET:MEAS<x>:RNDN:BER?

Inputs <NR3>

Outputs <NR3>

DPOJET:MEAS<x>:RNDN:AUTODETECTpattern

This command sets or queries the current detect plan.

Syntax DPOJET:MEAS(x):RNDN:AUTODETECTpattern {1 | 0 | ON | OFF}

Inputs <NR3>
0 is Manual
1 is Auto

DPOJET:MEAS<x>:RNDN:PATLen

This command sets or queries the current RNDN pattern length.

Syntax DPOJET:MEAS<x>:RNDN:PATLen <NR3>
DPOJET:MEAS<x>:RNDN:PATLen?

Inputs <NR3>

Outputs <NR3>

DPOJET:MEAS<x>:RNDN:TYPE

This command sets or queries the current RNDN measurement type.

Syntax DPOJET:MEAS<x>:RNDN:TYPE {ARBITrary | REPEating}
DPOJET:MEAS<x>:RNDN:TYPE?

Inputs {ARBITrary | REPEating}

Outputs {ARBITrary | REPEating}

DPOJET:MEAS<x>:RNDN:WINDOwlength

This command sets or queries the current RNDN window length.

Syntax DPOJET:MEAS<x>:RNDN:WINDOwlength <NR3>
DPOJET:MEAS<x>:RNDN:WINDOwlength?

Inputs <NR3>

Outputs <NR3>

DPOJET:MEAS<x>:SIGNALType

This command sets the signal type for various measurements.

Syntax DPOJET:MEAS<x>:SIGNALType {CLOCK | DATA | AUTO}

Inputs {CLOCK | DATA | AUTO}

Outputs {CLOCK | DATA | AUTO}

DPOJET:MEAS<x>:SOUrce1

This command sets or queries the Source1 value.

Syntax DPOJET:MEAS<x>:SOUrce1 {CH1 - CH4 | MATH1 - MATH4 | REF1 - REF4 | D0 — D15}
DPOJET:MEAS<x>:SOUrce1?

Inputs {CH1 - CH4 | MATH1 - MATH4 | REF1 - REF4 | D0 — D15}

Outputs {CH1 - CH4 | MATH1 - MATH4 | REF1 - REF4 | D0 — D15}

DPOJET:MEAS<x>:SOUrce2

This command sets or queries the Source2 value. May return NONE for single-source measurement. Source2 may be the second source used in dual-source measurements, or the clock source in others. In either case, it is always the same as the rightmost displayed source on the UI.

Syntax DPOJET:MEAS<x>:SOUrce2 {CH1 - CH4 | MATH1 - MATH4 | REF1 - REF4 | D0 — D15}
DPOJET:MEAS<x>:SOUrce2?

Inputs {CH1 - CH4 | MATH1 - MATH4 | REF1 - REF4 | D0 — D15}

Outputs {CH1 - CH4 | MATH1 - MATH4 | REF1 - REF4 | D0 — D15}

DPOJET:MEAS<x>:SSC:NOMinalfreq:AUTO?

This query-only command returns the automatically-calculated nominal frequency value for SSC configurations.

Syntax DPOJET:MEAS<x>:SSC:NOMinalfreq:AUTO?

Outputs <string>

DPOJET:MEAS<x>:SSC:NOMinalfreq:MANual

This command sets or queries the user-defined nominal frequency value for SSC configurations.

Syntax DPOJET:MEAS<x>:SSC:NOMinalfreq:MANual <NR3>
DPOJET:MEAS<x>:SSC:NOMinalfreq:MANual?

Inputs <NR3>

Outputs <NR3>

DPOJET:MEAS<x>:SSC:NOMinalfreq:SELECTIONtype

This command sets or queries the Nominal frequency selection type for the SSC configurations.

Syntax DPOJET:MEAS<x>:SSC:NOMinalfreq:SELECTIONtype
DPOJET:MEAS<x>:SSC:NOMinalfreq:SELECTIONtype?

Inputs {AUTO | MANUAL}

Outputs {AUTO | MANUAL}

DPOJET:MEAS<x>:TIMEDATa?

This query-only command returns the measurement time data. It is similar to the curve query, where the output is in the format #<x><yyy><data><newline>, where <x> is the number of <y> bytes.

For Example: If <yyy>=500, <x>=3

<x> is hexadecimal format. The letters A-F denote the number of y bytes between 10 and 15 digits.

<yyy> is the number of bytes to transfer.

<data> is curve data.

<newline> is a single-byte new line character at the end of the data.

Syntax DPOJET:MEAS<x>:TIMEDATa?

Outputs After parsing the query results, the data is a stream of doubles.

NOTE. Time data is not available for all measurements. For Example: Scalar measurements.

DPOJET:MEAS<x>:TOEdge

This command sets the TOEdge value for the measurement.

Syntax DPOJET:MEAS<x>:TOEdge {SAMEas | OPPOSITEas}

Inputs {SAMEas | OPPOSITEas}

Outputs {SAMEas | OPPOSITEas}

DPOJET:MEAS<x>:ZOOMEVENT

This command zooms into the waveform where a max/min value occurs in a measurement.

Syntax DPOJET:MEAS<x>:ZOOMEVENT {"MAX" | "MIN"}

Inputs {"MAX" | "MIN"}

DPOJET:NOISEENABLED

This set-only command turns on or off the Noise measurements.

Syntax

DPOJET:NOISEENABLED {1 | 0 | ON | OFF}

Inputs

1/ON to turn-on the noise measurements

0/OFF to turn-off the noise measurements

Outputs

NA

NOTE. Configure *DPOJET option level - DJAN* to turn on/off the noise measurements.

DPOJET:NUMMeas?

This query-only command returns the current number of defined measurements.

Syntax DPOJET:NUMMeas?

Outputs <NR1>

DPOJET:ADDPlot

This set-only command creates a plot of the specified type on the specified DPOJET measurement. Up to four plots can be created.

Syntax DPOJET:ADDPlot {TIMEtrend | DATAarray | HISTOgram | SPECTrum | TRANSfer | PHASEnoise | EYE | WAVEform | BATHtub | QBathtub | QPulsewidth | COMPOSITEJitterhist | NOISEBAthtub | BERContour} | CORRELATEDEye | PDFEye | BEREye | COMPOSITENoisehist | MEAS<x>}

Inputs {TIMEtrend | DATAarray | HISTOgram | SPECTrum | TRANSfer | PHASEnoise | EYE | WAVEform | BATHtub | QBathtub | QPulsewidth | COMPOSITEJitterhist | NOISEBAthtub | BERContour} | CORRELATEDEye | PDFEye | BEREye | COMPOSITENoisehist | MEAS<x>}

For example: DPOJET:ADDPlot HISTOgram, MEAS2

DPOJET:CLEARALLPlots

This set-only command clears the entire current list of defined plots in DPOJET.

Syntax DPOJET:CLEARALLPlots

DPOJET:PLOT<x>:COMPOSITEJitterhist:VERTical:SCALE

This command sets or queries the vertical scale setting for applicable plots, either Linear or Log.

NOTE. *Undefined for non-composite jitter histogram plots.*

Syntax DPOJET:PLOT<x>:COMPOSITEJitterhist:VERTical:SCALE {LINEAR | LOG}

DPOJET:PLOT<x>:COMPOSITEJitterhist:VERTical:SCALE?

Inputs {LINEAR | LOG}

Outputs {LINEAR | LOG}

DPOJET:PLOT<x>:COMPOSITEJitterhist:NUMBins

This command sets or queries the current composite jitter histogram resolution.

NOTE. *Undefined for non-composite jitter histogram plots.*

Syntax DPOJET:PLOT<x>:COMPOSITEJitterhist:NUMBins {TWENTyfive | FIFTY | HUNDred | TWOFifty | FIVEHundred | TWOThousand | MAXimum}

DPOJET:PLOT<x>:COMPOSITEJitterhist:NUMBins?

Inputs {TWENTyfive | FIFTY | HUNDred | TWOFifty | FIVEHundred| TWOThousand | MAXimum}

Outputs TWENTyfive | FIFTY | HUNdred | TWOFifty | FIVEHundred| TWOThousand | MAXimum}

DPOJET:PLOT<x>:COMPOSITEJitterhist:TJ

This command sets or queries the TJ Jitter component settings.

NOTE. *Undefined for non-composite jitter histogram plots.*

Syntax DPOJET:PLOT<x>:COMPOSITEJitterhist:TJ {1 | 0}
DPOJET:PLOT<x>:COMPOSITEJitterhist:TJ?

Inputs {1 | 0}

Outputs {1 | 0}

DPOJET:PLOT<x>:COMPOSITEJitterhist:RJNPJ

This command sets or queries the RJ+NPJ Jitter component settings.

NOTE. *Undefined for non-composite jitter histogram plots.*

Syntax DPOJET:PLOT<x>:COMPOSITEJitterhist:RJNPJ {1 | 0}
DPOJET:PLOT<x>:COMPOSITEJitterhist:RJNPJ?

Inputs {1 | 0}

Outputs {1 | 0}

DPOJET:PLOT<x>:COMPOSITEJitterhist:PJ

This command sets or queries the PJ Jitter component settings.

NOTE. *Undefined for non-composite jitter histogram plots.*

Syntax DPOJET:PLOT<x>:COMPOSITEJitterhist:PJ {1 | 0}
DPOJET:PLOT<x>:COMPOSITEJitterhist:PJ?

Inputs {1 | 0}

Outputs {1 | 0}

DPOJET:PLOT<x>:COMPOSITEJitterhist:DDJDCD

This command sets or queries the DDJ+DCD Jitter component settings.

NOTE. *Undefined for non-composite jitter histogram plots.*

Syntax DPOJET:PLOT<x>:COMPOSITEJitterhist:DDJDCD {1 | 0}
DPOJET:PLOT<x>:COMPOSITEJitterhist:DDJDCD?

Inputs {1 | 0}

Outputs {1 | 0}

DPOJET:PLOT<x>:DATA:XDATA?

This command returns the plot X data values. This command is similar to the curve query, where the output is in the format #<x><yyy><data><newline>, where <x> is the number of <y> bytes.

For example: If <yyy>=500, <x>=3

<x> is hexadecimal format. The letters A-F denote the number of y bytes between 10 and 15 digits.

<yyy> is the number of bytes to transfer.

<data> is curve data.

<newline> is a single-byte new line character at the end of the data.

Syntax DPOJET:PLOT<x>:DATA:XDATA?

Outputs After parsing the query results, the data is a stream of doubles.

NOTE. This command does not support plots such as the Eye Diagram Height plot, Waveform Plot and Eye diagram with mask hits.

DPOJET:PLOT<x>:DATA:XDATA:TJ?

This command returns the TJ plot X data values. This command is similar to the curve query, where the output is in the format #<x><yyy><data><newline>, where <x> is the number of <y> bytes.

For example: If <yyy>=500, <x>=3

<x> is hexadecimal format. The letters A-F denote the number of y bytes between 10 and 15 digits.

<data> is curve data.

<newline> is a single-byte new line character at the end of the data.

Syntax DPOJET:PLOT<x>:DATA:XDATA:TJ?

Outputs After parsing the query results, the data is a stream of doubles.

DPOJET:PLOT<x>:DATA:XDATA:RJBUJ?

This command returns the RJ+BUJ plot X data values. This command is similar to the curve query, where the output is in the format #<x><yyy><data><newline>, where <x> is the number of <y> bytes.

For example: If <yyy>=500, <x>=3

<x> is hexadecimal format. The letters A-F denote the number of <y> bytes between 10 and 15 digits.

<yyy> is the number of bytes to transfer.

<data> is curve data.

<newline> is a single-byte new line character at the end of the data.

Syntax DPOJET:PLOT<x>:DATA:XDATA:RJBUJ?

Outputs After parsing the query results, the data is a stream of doubles.

DPOJET:PLOT<x>:DATA:XDATA:PJ?

This command returns the PJ plot X data values. This command is similar to the curve query, where the output is in the format #<x><yyy><data><newline>, where <x> is the number of <y> bytes.

For example: If <yyy>=500, <x>=3

<x> is hexadecimal format. The letters A-F denote the number of <y> bytes between 10 and 15 digits.

<yyy> is the number of bytes to transfer.

<data> is curve data.

<newline> is a single-byte new line character at the end of the data.

Syntax DPOJET:PLOTx:DATA:XDATA:PJ?

Outputs After parsing the query results, the data is a stream of doubles.

DPOJET:PLOT<x>:DATA:XDATA:DDJDCD?

This command returns the DDJ+DCD plot X data values. This command is similar to the curve query, where the output is in the format #<x><yyy><data><newline>, where <x> is the number of <y> bytes.

For example: If <yyy>=500, <x>=3

<x> is hexadecimal format. The letters A-F denote the number of <y> bytes between 10 and 15 digits.

<yyy> is the number of bytes to transfer.

<data> is curve data.

<newline> is a single-byte new line character at the end of the data.

Syntax DPOJET:PLOT<x>:DATA:XDATA:DDJDCD?

Outputs After parsing the query results, the data is a stream of doubles.

DPOJET:PLOT<x>:DATA:XDATA:TN

This command returns the TN plot X data values. This command is similar to the curve query, where the output is in the format #<x><yyy><data><newline>, where <x> is the number of <y> bytes.

For example: If <yyy>=500, <x>=3

<x> is hexadecimal format. The letters A-F denote the number of y bytes between 10 and 15 digits.

<data> is curve data.

<newline> is a single-byte new line character at the end of the data.

Syntax DPOJET:PLOT<x>:DATA:XDATA:Tn?

Outputs After parsing the query results, the data is a stream of doubles.

DPOJET:PLOT<x>:DATA:XDATA:RNNPN

This command returns the RNNPN plot X data values. This command is similar to the curve query, where the output is in the format #<x><yyy><data><newline>, where <x> is the number of <y> bytes.

For example: If <yyy>=500, <x>=3

<x> is hexadecimal format. The letters A-F denote the number of y bytes between 10 and 15 digits.

<data> is curve data.

<newline> is a single-byte new line character at the end of the data.

Syntax DPOJET:PLOT<x>:DATA:XDATA:RNNPN?

Outputs After parsing the query results, the data is a stream of doubles.

DPOJET:PLOT<x>:DATA:XDATA:PN

This command returns the PN plot X data values. This command is similar to the curve query, where the output is in the format #<x><yyy><data><newline>, where <x> is the number of <y> bytes.

For example: If <yyy>=500, <x>=3

<x> is hexadecimal format. The letters A-F denote the number of y bytes between 10 and 15 digits.

<data> is curve data.

<newline> is a single-byte new line character at the end of the data.

Syntax DPOJET:PLOT<x>:DATA:XDATa:PN?

Outputs After parsing the query results, the data is a stream of doubles.

DPOJET:PLOT<x>:DATA:XDATa:DDNZERO

This command returns the DDNZERO plot X data values. This command is similar to the curve query, where the output is in the format #<x><yyy><data><newline>, where <x> is the number of <y> bytes.

For example: If <yyy>=500, <x>=3

<x> is hexadecimal format. The letters A-F denote the number of y bytes between 10 and 15 digits.

<data> is curve data.

<newline> is a single-byte new line character at the end of the data.

Syntax DPOJET:PLOT<x>:DATA:XDATa:DDNZERO?

Outputs After parsing the query results, the data is a stream of doubles.

DPOJET:PLOT<x>:DATA:XDATa:DDNONE

This command returns the DDNONE plot X data values. This command is similar to the curve query, where the output is in the format #<x><yyy><data><newline>, where <x> is the number of <y> bytes.

For example: If <yyy>=500, <x>=3

<x> is hexadecimal format. The letters A-F denote the number of y bytes between 10 and 15 digits.

<data> is curve data.

<newline> is a single-byte new line character at the end of the data.

Syntax DPOJET:PLOT<x>:DATA:XDATa:DDNONE?

Outputs After parsing the query results, the data is a stream of doubles.

DPOJET:PLOT<x>:DATA:YDATa?

This command returns the plot Y data values. This command is similar to the curve query, where the output is in the format #<x><yyy><data><newline>, where <x> is the number of <y> bytes.

For example: If <yyy>=500, <x>=3

<x> is hexadecimal format. The letters A-F denote the number of y bytes between 10 and 15 digits.

<yyy> is the number of bytes to transfer.

<data> is curve data.

<newline> is a single-byte new line character at the end of the data.

Syntax DPOJET:PLOT<x>:DATA:XDATa?

Outputs After parsing the query results, the data is a stream of doubles.

NOTE. This command does not support plots such as the Eye Diagram Height plot, Waveform Plot and Eye diagram with mask hits.

DPOJET:PLOT<x>:DATA:YDATA:TJ?

This command returns the TJ plot Y data values. This command is similar to the curve query, where the output is in the format #<x><yyy><data><newline>, where <x> is the number of <y> bytes.

For example: If <yyy>=500, <x>=3

<x> is hexadecimal format. The letters A-F denote the number of y bytes between 10 and 15 digits.

<yyy> is the number of bytes to transfer.

<data> is curve data.

<newline> is a single-byte new line character at the end of the data.

Syntax DPOJET:PLOT<x>:DATA:YDATA:TJ?

Outputs After parsing the query results, the data is a stream of doubles.

DPOJET:PLOT<x>:DATA:YDATA:RJBUJ?

This command returns the RJ+BUJ plot Y data values. This command is similar to the curve query, where the output is in the format #<x><yyy><data><newline>, where <x> is the number of <y> bytes.

For example: If <yyy>=500, <x>=3

<x> is hexadecimal format. The letters A-F denote the number of <y> bytes between 10 and 15 digits.

<yyy> is the number of bytes to transfer.

<data> is curve data.

<newline> is a single-byte new line character at the end of the data.

Syntax DPOJET:PLOT<x>:DATA:YDATAa:RJBUJ?

Outputs After parsing the query results, the data is a stream of doubles.

DPOJET:PLOT<x>:DATA:YDATAa:PJ?

This command returns the PJ plot Y data values. This command is similar to the curve query, where the output is in the format #<x><yyy><data><newline>, where <x> is the number of <y> bytes.

For example: If <yyy>=500, <x>=3

<x> is hexadecimal format. The letters A-F denote the number of <y> bytes between 10 and 15 digits.

<yyy> is the number of bytes to transfer.

<data> is curve data.

<newline> is a single-byte new line character at the end of the data.

Syntax DPOJET:PLOT<x>:DATA:YDATAa:PJ?

Outputs After parsing the query results, the data is a stream of doubles.

DPOJET:PLOT<x>:DATA:YDATA:DDJDCD?

This command returns the DDJ+DCD plot Y data values. This command is similar to the curve query, where the output is in the format #<x><yyy><data><newline>, where <x> is the number of <y> bytes.

For example: If <yyy>=500, <x>=3

<x> is hexadecimal format. The letters A-F denote the number of <y> bytes between 10 and 15 digits.

<yyy> is the number of bytes to transfer.

<data> is curve data.

<newline> is a single-byte new line character at the end of the data.

Syntax DPOJET:PLOT<x>:DATA:YDATA:DDJDCD?

Outputs After parsing the query results, the data is a stream of doubles.

DPOJET:PLOT<x>:DATA:YDATA:TN

This command returns the TN plot Y data values. This command is similar to the curve query, where the output is in the format #<x><yyy><data><newline>, where <x> is the number of <y> bytes.

For example: If <yyy>=500, <x>=3

<x> is hexadecimal format. The letters A-F denote the number of y bytes between 10 and 15 digits.

<yyy> is the number of bytes to transfer.

<data> is curve data.

<newline> is a single-byte new line character at the end of the data.

Syntax DPOJET:PLOT<x>:DATA:YDATa:TN?

Outputs After parsing the query results, the data is a stream of doubles.

DPOJET:PLOT<x>:DATA:YDATa:RNNPN

This command returns the RNNPN plot Y data values. This command is similar to the curve query, where the output is in the format #<x><yyy><data><newline>, where <x> is the number of <y> bytes.

For example: If <yyy>=500, <x>=3

<x> is hexadecimal format. The letters A-F denote the number of y bytes between 10 and 15 digits.

<yyy> is the number of bytes to transfer.

<data> is curve data.

<newline> is a single-byte new line character at the end of the data.

Syntax DPOJET:PLOT<x>:DATA:YDATa:RNNPN?

Outputs After parsing the query results, the data is a stream of doubles.

DPOJET:PLOT<x>:DATA:YDATA:PN

This command returns the PN plot Y data values. This command is similar to the curve query, where the output is in the format #<x><yyy><data><newline>, where <x> is the number of <y> bytes.

For example: If <yyy>=500, <x>=3

<x> is hexadecimal format. The letters A-F denote the number of y bytes between 10 and 15 digits.

<yyy> is the number of bytes to transfer.

<data> is curve data.

<newline> is a single-byte new line character at the end of the data.

Syntax DPOJET:PLOT<x>:DATA:YDATA:PN?

Outputs After parsing the query results, the data is a stream of doubles.

DPOJET:PLOT<x>:DATA:YDATA:DDNONE

This command returns the DDNONE plot Y data values. This command is similar to the curve query, where the output is in the format #<x><yyy><data><newline>, where <x> is the number of <y> bytes.

For example: If <yyy>=500, <x>=3

<x> is hexadecimal format. The letters A-F denote the number of y bytes between 10 and 15 digits.

<yyy> is the number of bytes to transfer.

<data> is curve data.

<newline> is a single-byte new line character at the end of the data.

Syntax DPOJET:PLOT<x>:DATA:YDATAa:DDNONE?

Outputs After parsing the query results, the data is a stream of doubles.

DPOJET:PLOT<x>:DATA:YDATAa:DDNZERO

This command returns the DDNZERO plot Y data values. This command is similar to the curve query, where the output is in the format #<x><yyy><data><newline>, where <x> is the number of <y> bytes.

For example: If <yyy>=500, <x>=3

<x> is hexadecimal format. The letters A-F denote the number of y bytes between 10 and 15 digits.

<yyy> is the number of bytes to transfer.

<data> is curve data.

<newline> is a single-byte new line character at the end of the data.

Syntax DPOJET:PLOT<x>:DATA:YDATAa:DDNZERO?

Outputs After parsing the query results, the data is a stream of doubles.

DPOJET:PLOT<x>:XUnits?

This query-only command returns X units of the plot as a string.

Syntax DPOJET:PLOT<x>:XUnits?

Outputs <string>

NOTE. *Plot units depends on the measurement type. [Click here to see the possible](#)*

DPOJET:PLOT<x>:YUnits?

This query-only command returns Y units of the plot as a string.

Syntax DPOJET:PLOT<x>:YUnits?

Outputs <string>

NOTE. *Plot units depends on the measurement type. [Click here to see the possible](#)*

DPOJET:PLOT<x>:SOUrce?

This query-only command returns the source measurement for the selected plot.

Syntax DPOJET:PLOT<x>:SOUrce?

Outputs {MEAS1 - MEAS99}

DPOJET:PLOT<x>:TREND:TYPE

This command sets or queries the trend type setting for Trend plots.

Syntax DPOJET:PLOT<x>:TREND:TYPE {VECTOR | BAR}
DPOJET:PLOT<x>:TREND:TYPE?

Inputs {VECTOR | BAR}

Outputs {VECTOR | BAR}

DPOJET:PLOT<x>:TYPE?

This query-only command returns the current plot type for the selected plot.

Syntax DPOJET:PLOT<x>:TYPE?

Outputs {TIMEtrend | DATAarray | HISTOgram | SPECTrum | TRANSfer | PHASEnoise | EYE | WAVEform | BATHtub | QBathtub | QPulsewidth | COMPOSITEJitterhist | NOISEBAthtub | BERContour} | CORRELATEDEye | PDFEye | BEREye | COMPOSITENoisehist }

DPOJET:PLOT<x>:BATHtub:BER

This command sets or queries the bathtub BER value.

Syntax DPOJET:PLOT<x>:BATHtub:BER <NR3>
DPOJET:PLOT<x>:BATHtub:BER?

Inputs <NR3>

Outputs <NR1>

NOTE. Undefined for nonbathtub plots.

DPOJET:PLOT<x>:BATHtub:VERTical:SCALE

This command sets or queries the vertical scale setting for applicable plots, either Linear or Log.

Syntax DPOJET:PLOT<x>:BATHtub:VERTical:SCALE {LINEAR | LOG}
DPOJET:PLOT<x>:BATHtub:VERTical:SCALE?

Inputs {LINEAR | LOG}

Outputs {LINEAR | LOG}

NOTE. *Undefined for nonbathtub plots.*

DPOJET:PLOT<x>:EYE:ALIGNment

This command sets or queries eye alignment state for eye plots.

Syntax DPOJET:PLOT<x>:EYE:ALIGNment {AUTO | LEFT | CENter}
DPOJET:PLOT<x>:EYE:ALIGNment?

Inputs {AUTO | LEFT | CENter}

Outputs {AUTO | LEFT | CENter}

NOTE. *Undefined for noneye plots.*

DPOJET:PLOT<x>:EYE:ALLUI

This command sets or queries the computed mask hits or status for DFE Eye Diagram measurement for non-interpolation eye rendering.

Syntax DPOJET:PLOT<x>:EYE:ALLUI {1 | 0 }
DPOJET:PLOT<x>:EYE:ALLUI?

Inputs {1 | 0 }

Outputs {1 | 0 }

DPOJET:PLOT<x>:EYE:HORizontal:AUTOscale

This command sets or queries the horizontal auto scale setting.

Syntax DPOJET:PLOT<x>:EYE:HORizontal:AUTOscale {1 | 0 }
DPOJET:PLOT<x>:EYE:HORizontal:AUTOscale?

Inputs {1 | 0 }

Outputs {1 | 0 }

NOTE. *Undefined for noneye plots.*

DPOJET:PLOT<x>:EYE:HORizontal:RESolution

This command sets or queries the Horizontal Eye resolution.

Syntax DPOJET:PLOT<x>:EYE:HORizontal:RESolution <NR3>
DPOJET:PLOT<x>:EYE:HORizontal:RESolution?

Inputs <NR3>

Outputs <NR1>

NOTE. *Undefined for noneye plots.*

DPOJET:PLOT<x>:EYE:INTERPolationtype

This command sets or queries the interpolation type.

Syntax DPOJET:PLOT<x>:EYE:INTERPolationtype { INTERPOLATION |
NONINTERPOLATION }
DPOJET:PLOT<x>:EYE:INTERPolationtype?

Inputs { INTERPOLATION | NONINTERPOLATION }

Outputs INTERPOLATION | NONINTERPOLATION

DPOJET:PLOT<x>:EYE:MASKfile

This command sets or queries the mask file.

Syntax DPOJET:PLOT<x>:EYE:MASKfile <string>
DPOJET:PLOT<x>:EYE:MASKfile?

Inputs <string>

Outputs <string>

NOTE. Undefined for noneye plots.

DPOJET:PLOT<x>:EYE:STATE

This command sets or queries the eye state, either on or off.

Syntax DPOJET:PLOT<x>:EYE:STATE {1 | 0}
DPOJET:PLOT<x>:EYE:STATE?

Inputs {1 | 0}

Outputs {1 | 0}

NOTE. Undefined for noneye plots.

DPOJET:PLOT<x>:EYE:SUPERImpose

This command sets or queries whether superimposed eyes are generated in eye diagrams.

Syntax DPOJET:PLOT<x>:EYE:SUPERImpose {1 | 0}
DPOJET:PLOT<x>:EYE:SUPERImpose?

Inputs {1 | 0}

Outputs {1 | 0}

NOTE. *Undefined for noneye plots.*

DPOJET:PLOT<x>:EYE:VERTICALAlignment

This command sets or queries the vertical alignment state, either on or off.

Syntax DPOJET:PLOT<x>:EYE:VERTICALAlignment {1 | 0}
DPOJET:PLOT<x>:EYE:VERTICALAlignment?

Inputs {1 | 0}

Outputs {1 | 0}

DPOJET:PLOT<x>:EYE:VERTScale

This command sets or queries the vertical scale state, either on or off.

Syntax DPOJET:PLOT<x>:EYE:VERTScale {1 | 0}
DPOJET:PLOT<x>:EYE:VERTScale?

Inputs {1 | 0}

Outputs {1 | 0}

DPOJET:PLOT<x>:EYE:HORIZScale

This command sets or queries the horizontal scale state, either on or off.

Syntax DPOJET:PLOT<x>:EYE:HORIZScale {1 | 0}
DPOJET:PLOT<x>:EYE:HORIZScale?

Inputs {1 | 0}

Outputs {1 | 0}

DPOJET:PLOT<x>:EYE:VERTical:YAXISMAx

This command sets or queries the Y-Axis maximum value.

Syntax DPOJET:PLOT<x>:EYE:VERTical:YAXISMAx <NR3>
DPOJET:PLOT<x>:EYE:VERTical:YAXISMAx?

Inputs <NR3>

Outputs <NR3>

DPOJET:PLOT<x>:EYE:VERTical:YAXISMin

This command sets or queries the Y-Axis minimum value

Syntax DPOJET:PLOT<x>:EYE:VERTical:YAXISMin <NR3>
DPOJET:PLOT<x>:EYE:VERTical:YAXISMin?

Inputs <NR3>

Outputs <NR3>

DPOJET:PLOT<x>:EYE:HORizontal:XAXISMAx

This command sets or queries the X-Axis maximum value.

Syntax DPOJET:PLOT<x>:EYE:HORizontal:XAXISMAx <NR3>
DPOJET:PLOT<x>:EYE:HORizontal:XAXISMAx?

Inputs <NR3>

Outputs <NR3>

DPOJET:PLOT<x>:EYE:HORizontal:XAXISMin

This command sets or queries the X-Axis minimum value.

Syntax DPOJET:PLOT<x>:EYE:HORizontal:XAXISMin <NR3>
DPOJET:PLOT<x>:EYE:HORizontal:XAXISMin?

Inputs <NR3>

Outputs <NR3>

DPOJET:PLOT<x>:TOTALUISAnalyzed?

This command queries the total UIs analysed for Eye Diagram plot.

Syntax DPOJET:PLOT<x>:TOTALUISAnalyzed?

Output <NR3>

DPOJET:PLOT<x>:TOTALUISAcquired?

This command queries the total UIs acquired for Eye Diagram plot

Syntax DPOJET:PLOT<x>:TOTALUISAcquired?

Outputs <NR3>

DPOJET:PLOT<x>:HISTOgram:HORizontal:SPAN

This command sets or queries the histogram span.

Syntax DPOJET:PLOT<x>:HISTOgram:HORizontal:SPAN <NR3>
DPOJET:PLOT<x>:HISTOgram:HORizontal:SPAN?

Inputs <NR3>

Outputs <NR3>

NOTE. *Undefined for nonhistogram plots.*

DPOJET:PLOT<x>:HISTOgram:AUTOset

This command runs a histogram autosest for the specified slot.

Syntax DPOJET:PLOT<x>:HISTOgram:AUTOset {EXECute}

Inputs {EXECute}

NOTE. *Undefined for nonhistogram plots.*

DPOJET:PLOT<x>:HISTOgram:HORizontal:AUTOscale

This command sets or queries the horizontal auto scale settings.

Syntax DPOJET:PLOT<x>:HISTOgram:HORizontal:AUTOscale {1 | 0}
DPOJET:PLOT<x>:HISTOgram:HORizontal:AUTOscale?

Inputs {1 | 0}

Outputs {1 | 0}

NOTE. *Undefined for nonhistogram plots.*

DPOJET:PLOT<x>:HISTOgram:HORizontal:CENTer

This command sets or queries the histogram center.

Syntax DPOJET:PLOT<x>:HISTOgram:HORizontal:CENTer <NR3>
DPOJET:PLOT<x>:HISTOgram:HORizontal:CENTer?

Inputs <NR3>

Outputs <NR3>

NOTE. *Undefined for nonhistogram plots.*

DPOJET:PLOT<x>:HISTOgram:HORizontal:SPAN

This command sets or queries the histogram span.

Syntax DPOJET:PLOT<x>:HISTOgram:HORizontal:SPAN <NR3>
DPOJET:PLOT<x>:HISTOgram:HORizontal:SPAN?

Inputs <NR3>

Outputs <NR3>

NOTE. *Undefined for nonhistogram plots.*

DPOJET:PLOT<x>:HISTOgram:NUMBins

This command sets or queries the current histogram resolution.

Syntax DPOJET:PLOT<x>:HISTOgram:NUMBins {TWENTyfive | FIFTY | HUNDred | TWOFifty | FIVEHundred | TWOThousand | MAXimum}
DPOJET:PLOT<x>:HISTOgram:NUMBins?

Inputs {TWENTyfive | FIFTY | HUNDred | TWOFifty | FIVEHundred | TWOThousand | MAXimum}

Outputs {TWENTyfive | FIFTY | HUNDred | TWOFifty | FIVEHundred | TWOThousand | MAXimum}

NOTE. *Undefined for nonhistogram plots.*

DPOJET:PLOT<x>:HISTOgram:VERTical:SCALE

This command sets or queries the vertical scale setting for applicable plots, either Linear or Log.

Syntax DPOJET:PLOT<x>:HISTOgram:VERTical:SCALE {LINEAR | LOG}
DPOJET:PLOT<x>:HISTOgram:VERTical:SCALE?

Inputs {LINEAR | LOG}

Outputs {LINEAR | LOG}

NOTE. Undefined for nonhistogram plots.

DPOJET:PLOT<x>:PHASEnoise:BASEline

This command sets or queries the phase noise baseline.

Syntax DPOJET:PLOT<x>:PHASEnoise:BASEline <NR3>
DPOJET:PLOT<x>:PHASEnoise:BASEline?

Inputs <NR3>

Outputs <NR1>

NOTE. Undefined for nonphase-noise plots.

DPOJET:PLOT<x>:SPECtrum:BASE

This command sets or queries the spectrum base. Undefined for non-spectrum plots.

Syntax DPOJET:PLOT<x>:SPECtrum:BASE <NR3>
DPOJET:PLOT<x>:SPECtrum:BASE?

Inputs <NR3>

Outputs <NR1>

DPOJET:PLOT<x>:SPECtrum:HORizontal:SCALE

This command sets or queries the horizontal scale setting for applicable plots, either Linear or Log.

Syntax DPOJET:PLOT<x>:SPECtrum:HORizontal:SCALE {LINEAR | LOG}
DPOJET:PLOT<x>:SPECtrum:HORizontal:SCALE?

Inputs {LINEAR | LOG}

Outputs {LINEAR | LOG}

NOTE. Undefined for nonspectrum plots.

DPOJET:PLOT<x>:SPECtrum:MODE

This command sets or queries the spectrum mode.

Syntax DPOJET:PLOT<x>:SPECtrum:MODE {NORMal | AVErage | PEAKhold}
DPOJET:PLOT<x>:SPECtrum:MODE?

Inputs {NORMal | AVErage | PEAKhold}

Outputs {NORMal | AVErage | PEAKhold}

DPOJET:PLOT<x>:SPECtrum:VERTical:SCALE

This command sets or queries the vertical scale setting for applicable plots, either Linear or Log.

Syntax DPOJET:PLOT<x>:SPECtrum:VERTical:SCALE {LINEAR | LOG}
DPOJET:PLOT<x>:SPECtrum:VERTical:SCALE?

Inputs {LINEAR | LOG}

Outputs {LINEAR | LOG}

NOTE. *Undefined for nonspectrum plots.*

DPOJET:PLOT<x>:TRANSfer:DENominator

This command sets or queries the transfer plot denominator.

Syntax DPOJET:PLOT<x>:TRANSfer:DENominator {MEAS1 - MEAS99}
DPOJET:PLOT<x>:TRANSfer:DENominator?

Inputs {MEAS1 - MEAS99}

Outputs {MEAS1 - MEAS99}

NOTE. Undefined for non-transfer plots.

DPOJET:PLOT<x>:TRANSfer:HORizontal:SCALE

This command sets or queries the horizontal scale setting for applicable plots, either Linear or Log. Undefined for nontransfer plots.

Syntax DPOJET:PLOT<x>:TRANSfer:HORizontal:SCALE {LINEAR | LOG}
DPOJET:PLOT<x>:TRANSfer:HORizontal:SCALE?

Inputs {LINEAR | LOG}

Outputs {LINEAR | LOG}

DPOJET:PLOT<x>:TRANSfer:MODE

This command sets or queries the transfer plot mode.

Syntax DPOJET:PLOT<x>:TRANSfer:MODE {NORMal | AVErage}
DPOJET:PLOT<x>:TRANSfer:MODE?

Inputs {NORMal | AVErage}

Outputs {NORMal | AVErage}

DPOJET:PLOT<x>:TRANSfer:NUMerator

This command sets or queries the transfer plot numerator.

Syntax DPOJET:PLOT<x>:TRANSfer:NUMerator {MEAS1 - MEAS99}
DPOJET:PLOT<x>:TRANSfer:NUMerator?

Inputs {MEAS1 - MEAS99}

Outputs {MEAS1 - MEAS99}

NOTE. *Undefined for nontransfer plots.*

DPOJET:PLOT<x>:TRANSfer:VERTical:SCALE

This command sets or queries the vertical scale setting for applicable plots, either Linear or Log. Undefined for non-transfer plots.

Syntax DPOJET:PLOT<x>:TRANSfer:VERTical:SCALE {LINEAR | LOG}
DPOJET:PLOT<x>:TRANSfer:VERTical:SCALE?

Inputs {LINEAR | LOG}

Outputs {LINEAR | LOG}

DPOJET:PLOT<x>:BERContour:ALIGNment

This command sets or queries the BER contour alignment.

Syntax

DPOJET:PLOT<x>:BERContour:ALIGNment {AUTO | LEFT | CENter}

DPOJET:PLOT<x>:BERContour:ALIGNment?

Inputs

{AUTO | LEFT | CENter}

Outputs

{AUTO | LEFT | CENter}

DPOJET:PLOT<x>:BERContour:HORizontal:AUTOscale

This command sets or queries the horizontal auto scale setting.

Syntax

DPOJET:PLOT<x>:BERContour:HORizontal:AUTOscale {1 | 0}

DPOJET:PLOT<x>:BERContour:HORizontal:AUTOscale?

Inputs

{1 | 0}

Outputs

{1 | 0}

DPOJET:PLOT<x>:BERContour:HORizontal:RESolution

This command sets or queries the Horizontal Eye resolution.

Syntax

DPOJET:PLOT<x>:BERContour:HORizontal:RESolution <NR3>

DPOJET:PLOT<x>:BERContour:HORizontal:RESolution?

Inputs

<NR3>

DPOJET:PLOT<x>:BERContour:MASK

This command sets or queries the eye state, either on or off.

Syntax

DPOJET:PLOT<x>:BERContour:MASK {1 | 0}

DPOJET:PLOT<x>:BERContour:MASK?

Inputs

{1 | 0}

Outputs

{1 | 0}

DPOJET:PLOT<x>:BERContour:MASKFile

This command sets or queries the mask file.

Syntax

DPOJET:PLOT<x>:BERContour:MASKFile <string>

DPOJET:PLOT<x>:BERContour:MASKFile?

Inputs

<string>

Outputs

<string>

DPOJET:PLOT<x>:BERContour:SUPERImpose

This command sets or queries whether superimposed eyes are generated in eye diagrams.

Syntax

DPOJET:PLOT<x>:BERContour:SUPERImpose {1 | 0}

DPOJET:PLOT<x>:BERContour:SUPERImpose?

Inputs

{1 | 0}

Outputs

{1 | 0}

DPOJET:PLOT<x>:BERContour:BER1E6V

This command sets or queries the BER1E6 Contour display.

Syntax DPOJET:PLOT<x>:BERContour:BER1E6V {1 | 0}

DPOJET:PLOT<x>:BERContour:BER1E6V?

Inputs {1 | 0}

Outputs {1 | 0}

DPOJET:PLOT<x>:BERContour:BER1E9V

This command sets or queries the BER1E9 Contour display.

Syntax DPOJET:PLOT<x>:BERContour:BER1E9V {1 | 0}
DPOJET:PLOT<x>:BERContour:BER1E9V?

Inputs {1 | 0}

Outputs {1 | 0}

DPOJET:PLOT<x>:BERContour:BER1E12V

This command sets or queries the BER1E12 Contour display.

Syntax DPOJET:PLOT<x>:BERContour:BER1E12V {1 | 0}
DPOJET:PLOT<x>:BERContour:BER1E12V?

Inputs {1 | 0}

Outputs {1 | 0}

DPOJET:PLOT<x>:BERContour:BER1E15V

This command sets or queries the BER1E15 Contour display.

Syntax DPOJET:PLOT<x>:BERContour:BER1E15V {1 | 0}
DPOJET:PLOT<x>:BERContour:BER1E15V?

Inputs {1 | 0}

Outputs {1 | 0}

DPOJET:PLOT<x>:BERContour:BER1E18V

This command sets or queries the BER1E18 Contour display.

Syntax DPOJET:PLOT<x>:BERContour:BER1E18V {1 | 0}
DPOJET:PLOT<x>:BERContour:BER1E18V?

Inputs {1 | 0}

Outputs {1 | 0}

DPOJET:PLOT<x>:BERContour:TARGETBER

This command sets or queries the Target BER Contour display.

Syntax DPOJET:PLOT<x>:BERContour:TARGETBER {1 | 0}
 DPOJET:PLOT<x>:BERContour:TARGETBER?

Inputs {1 | 0}

Outputs {1 | 0}

DPOJET:PLOT<x>:VERTBATHtub:BER

This command sets or queries the noise bathtub BER value.

Syntax

DPOJET:PLOT<x>:VERTBATHtub:BER <NR3>

DPOJET:PLOT<x>:VERTBATHtub:BER?

Inputs

<NR3>

Outputs

<NR1>

DPOJET:PLOT<x>:VERTBATHtub:HORizontal:SCALE

This command sets or queries the horizontal scale setting for applicable plots, either Linear or Log.

Syntax

DPOJET:PLOT<x>:VERTBATHtub:HORizontal:SCALE {LINEAR | LOG}

DPOJET:PLOT<x>:VERTBATHtub:HORizontal:SCALE?

Inputs

{LINEAR | LOG}

Outputs

{LINEAR | LOG}

DPOJET:PLOT<x>:CORRELATEDEye:BER1E6V

This command sets or queries the BER1E6 Contour display.

Syntax DPOJET:PLOT<x>:CORRELATEDEye:BER1E6V {1 | 0}
DPOJET:PLOT<x>:CORRELATEDEye:BER1E6V?

Inputs {1 | 0}

Outputs {1 | 0}

DPOJET:PLOT<x>:EXPORTRaw?

This query command returns the raw Eye diagram 2d histogram data in binary format. This command is similar to curve query

Syntax DPOJET:PLOT<x>:EXPORTRaw?

Outputs After parsing the query results, the data is a stream of doubles.

DPOJET:PLOT<x>:CORRELATEDEye:BER1E9V

This command sets or queries the BER1E9 Contour display.

Syntax DPOJET:PLOT<x>:CORRELATEDEye:BER1E9V {1 | 0}
DPOJET:PLOT<x>:CORRELATEDEye:BER1E9V?

Inputs {1 | 0}

Outputs {1 | 0}

DPOJET:PLOT<x>:CORRELATEDEye:BER1E12V

This command sets or queries the BER1E12 Contour display.

Syntax DPOJET:PLOT<x>:CORRELATEDEye:BER1E12V {1 | 0}
DPOJET:PLOT<x>:CORRELATEDEye: BER1E12V?

Inputs {1 | 0}

Outputs {1 | 0}

DPOJET:PLOT<x>:CORRELATEDEye:BER1E15V

This command sets or queries the BER1E15 Contour display.

Syntax DPOJET:PLOT<x>:CORRELATEDEye:BER1E15V {1 | 0}
DPOJET:PLOT<x>:CORRELATEDEye:BER1E15V?

Inputs {1 | 0}

Outputs {1 | 0}

DPOJET:PLOT<x>:CORRELATEDEye:BER1E18V

This command sets or queries the BER1E18 Contour display.

Syntax DPOJET:PLOT<x>:CORRELATEDEye:BER1E18V {1 | 0}
DPOJET:PLOT<x>:CORRELATEDEye:BER1E18V?

Inputs {1 | 0}

Outputs {1 | 0}

DPOJET:PLOT<x>:CORRELATEDEye:TARGETBER

This command sets or queries the TARGETBER Contour display.

Syntax DPOJET:PLOT<x>:CORRELATEDEye:TARGETBER {1 | 0}
DPOJET:PLOT<x>:CORRELATEDEye:TARGETBER?

Inputs {1 | 0}

Outputs {1 | 0}

DPOJET:PLOT<x>:PDFEye:BER1E6V

This command sets or queries the BER1E6 Contour display.

Syntax DPOJET:PLOT<x>:PDFEye:BER1E6V {1 | 0}
DPOJET:PLOT<x>:PDFEye:BER1E6V?

Inputs {1 | 0}

Outputs {1 | 0}

DPOJET:PLOT<x>:PDFEye:BER1E9V

This command sets or queries the BER1E9 Contour display.

Syntax DPOJET:PLOT<x>:PDFEye: BER1E9V {1 | 0}
DPOJET:PLOT<x>:PDFEye: BER1E9V?

Inputs {1 | 0}

Outputs {1 | 0}

DPOJET:PLOT<x>:PDFEye:BER1E12V

This command sets or queries the BER1E12 Contour display.

Syntax DPOJET:PLOT<x>:PDFEye:BER1E12V {1 | 0}
DPOJET:PLOT<x>:PDFEye:BER1E12V?

Inputs {1 | 0}

Outputs {1 | 0}

DPOJET:PLOT<x>:PDFEye:BER1E15V

This command sets or queries the BER1E15 Contour display.

Syntax DPOJET:PLOT<x>:PDFEye:BER1E15V {1 | 0}
DPOJET:PLOT<x>:PDFEye:BER1E15V?

Inputs {1 | 0}

Outputs {1 | 0}

DPOJET:PLOT<x>:PDFEye:BER1E18V

This command sets or queries the BER1E18 Contour display.

Syntax DPOJET:PLOT<x>:PDFEye:BER1E18V {1 | 0}
DPOJET:PLOT<x>:PDFEye:BER1E18V?

Inputs {1 | 0}

Outputs {1 | 0}

DPOJET:PLOT<x>:PDFEye:TARGETBER

This command sets or queries the TARGETBER Contour display.

Syntax DPOJET:PLOT<x>:PDFEye:TARGETBER {1 | 0}
DPOJET:PLOT<x>:PDFEye:TARGETBER?

Inputs {1 | 0}

Outputs {1 | 0}

DPOJET:PLOT<x>:BEREye:BER1E6V

This command sets or queries the BER1E6 Contour display.

Syntax DPOJET:PLOT<x>:BEREye:BER1E6V {1 | 0}
DPOJET:PLOT<x>:BEREye:BER1E6V?

Inputs {1 | 0}

Outputs {1 | 0}

DPOJET:PLOT<x>:BEREye:BER1E9V

This command sets or queries the BER1E9 Contour display.

Syntax DPOJET:PLOT<x>:BEREye:BER1E9V {1 | 0}
DPOJET:PLOT<x>:BEREye:BER1E9V?

Inputs {1 | 0}

Outputs {1 | 0}

DPOJET:PLOT<x>:BEREye:BER1E12V

This command sets or queries the BER1E12 Contour display.

Syntax DPOJET:PLOT<x>:BEREye:BER1E12V {1 | 0}
DPOJET:PLOT<x>:BEREye:BER1E12V?

Inputs {1 | 0}

Outputs {1 | 0}

DPOJET:PLOT<x>:BEREye:BER1E15V

This command sets or queries the BER1E15 Contour display.

Syntax DPOJET:PLOT<x>:BEREye:BER1E15V {1 | 0}
DPOJET:PLOT<x>:BEREye:BER1E15V?

Inputs {1 | 0}

Outputs {1 | 0}

DPOJET:PLOT<x>:BEREye:BER1E18V

This command sets or queries the BER1E18 Contour display.

Syntax DPOJET:PLOT<x>:BEREye:BER1E18V {1 | 0}
DPOJET:PLOT<x>:BEREye:BER1E18V?

Inputs {1 | 0}

Outputs {1 | 0}

DPOJET:PLOT<x>:BEREye:TARGETBER

This command sets or queries the TARGETBER Contour display.

Syntax DPOJET:PLOT<x>:BEREye:TARGETBER {1 | 0}
DPOJET:PLOT<x>:BEREye:TARGETBER?

Inputs {1 | 0}

Outputs {1 | 0}

DPOJET:PLOT<x>:COMPOSITENoisehist:HORizontal:SCALE

This command sets or queries the Horizontal scale setting for applicable plots, either Linear or Log.

Syntax DPOJET:PLOT<x>:COMPOSITENoisehist:HORizontal:SCALE {LINEAR | LOG}
DPOJET:PLOT<x>:COMPOSITENoisehist:HORizontal:SCALE?

Inputs {LINEAR | LOG}

Outputs {LINEAR | LOG}

DPOJET:PLOT<x>:COMPOSITENoisehist:NUMBins

This command sets or queries the current composite noise histogram resolution.

Syntax DPOJET:PLOT<x>:COMPOSITENoisehist:NUMBins { TWENTyfive | FIFTY | HUNDred | TWOFifty | FIVEHundred | TWOThousand | MAXimum}
DPOJET:PLOT<x>:COMPOSITENoisehist:NUMBins?

Inputs { TWENTyfive | FIFTY | HUNDred | TWOFifty | FIVEHundred | TWOThousand | MAXimum}

Outputs { TWENTyfive | FIFTY | HUNDred | TWOFifty | FIVEHundred | TWOThousand | MAXimum}

DPOJET:PLOT<x>:COMPOSITENoisehist:TN

This command sets or queries the TN Noise component settings.

Syntax DPOJET:PLOT<x>:COMPOSITENoisehist:TN {1 | 0}
DPOJET:PLOT<x>:COMPOSITENoisehist:TN?

Inputs {1 | 0}

Outputs {1 | 0}

DPOJET:PLOT<x>:COMPOSITENoisehist:RNNPN

This command sets or queries the RN+NPN Noise component settings.

Syntax DPOJET:PLOT<x>:COMPOSITENoisehist:RNNPN {1 | 0}
DPOJET:PLOT<x>:COMPOSITENoisehist:RNNPN?

Inputs {1 | 0}

Outputs {1 | 0}

DPOJET:PLOT<x>:COMPOSITENoisehist:PN

This command sets or queries the PN Noise component settings.

Syntax DPOJET:PLOT<x>:COMPOSITENoisehist:PN {1 | 0}
DPOJET:PLOT<x>:COMPOSITENoisehist:PN?

Inputs {1 | 0}

Outputs {1 | 0}

DPOJET:PLOT<x>:COMPOSITENoisehist:DDNZERO

This command sets or queries the DDN(0) Noise component settings.

Syntax DPOJET:PLOT<x>:COMPOSITENoisehist:DDNZERO {1 | 0}
DPOJET:PLOT<x>:COMPOSITENoisehist:DDNZERO?

Inputs {1 | 0}

Outputs {1 | 0}

DPOJET:PLOT<x>:COMPOSITENoisehist:DDNONE

This command sets or queries the DDN(1) Noise component settings.

Syntax DPOJET:PLOT<x>:COMPOSITENoisehist:DDNONE {1 | 0}
DPOJET:PLOT<x>:COMPOSITENoisehist:DDNONE?

Inputs {1 | 0}

Outputs {1 | 0}

DPOJET:POPULATION:CONDition

This command sets or queries the current population limit condition.

Syntax DPOJET:POPULATION:CONDition {EACHmeas | LASTmeas}
DPOJET:POPULATION:CONDition?

Inputs {EACHmeas | LASTmeas}

Outputs {EACHmeas | LASTmeas}

DPOJET:POPULATION:LIMIT

This command sets or queries the current limit value.

Syntax DPOJET:POPULATION:LIMIT <NR3>
DPOJET:POPULATION:LIMIT?

Inputs <NR3>

Outputs <NR1>

DPOJET:POPULATION:LIMITBY

This command sets or queries the mechanism by limits, either acquisition or population.

Syntax DPOJET:POPULATION:LIMITBY {ACQuisitions | POPUlation}
DPOJET:POPULATION:LIMITBY?

Inputs {ACQuisitions | POPUlation}

Outputs {ACQuisitions | POPUlation}

DPOJET:POPULATION:STATE

This command turns on or off population limits.

Syntax DPOJET:POPULATION:STATE {1 | 0}

Inputs {1 | 0}

Outputs {1 | 0}

DPOJET:QUALify:ACTIVE

This command sets the active state for the qualifier source, either HIGH or LOW.

Syntax DPOJET:QUALify:ACTIVE {HIGH | LOW}

Inputs {HIGH | LOW}

Outputs {HIGH | LOW}

DPOJET:QUALify:SOUrce

This command sets the qualifier source.

Syntax DPOJET:QUALify:SOUrce {CH1 – CH4 | MATH1 - MATH4 | REF1 - REF4 | SEARCH0 – SEARCH8}

Inputs {CH1 – CH4 | MATH1 - MATH4 | REF1 - REF4 | SEARCH0 – SEARCH8}

Outputs {CH1 – CH4 | MATH1 - MATH4 | REF1 - REF4 | SEARCH0 – SEARCH8}

DPOJET:QUALify:STATE

This command turns on or off measurement qualification.

Syntax DPOJET:QUALify:STATE {1 | 0}

Inputs {1 | 0}

Outputs {1 | 0}

DPOJET:REFLevel:CH<x>:MIDZero

This command turns on or off the mid reference level voltage setting.

Syntax DPOJET:REFLevel:CH<x>:MIDZero {1 | 0}

Inputs {1 | 0}

Outputs {1 | 0}

DPOJET:REFLevels:AUTOSet

This command performs a DPOJET ref level autoselect on any sources selected using DPOJET:REFLevels:CH<x>:AUTOSet.

Syntax DPOJET:REFLevels:AUTOSet {EXECute}

Inputs {EXECute}

NOTE. All pieces of the reflevel branch have the ability to set ref levels for CH1-CH4, MATH1-MATH4, and REF1-Ref4. Only the CH<x> portion is shown in this OLH, but it exists and matches exactly for MATH (DPOJET:REFLevels:MATH<x> and REF (DPOJET:REFLevels:REF<x>)).

DPOJET:REFLevels:AUTOset:STATE?

This query-only command provides the Ref Level Autoset status.

Syntax DPOJET:REFLevels:AUTOset:STATE?

Outputs "RUNNING" | "STOPPED"

DPOJET:REFLevels:CH<x>:AUTOSet

This command sets or clears the refllevel autoset state of the given source. When set to 1, the given source will have a ref level autoset acted on it during the next acquisition.

Syntax DPOJET:REFLevels:CH<x>:AUTOSet {1 | 0}

Inputs {1 | 0}

Outputs {1 | 0}

NOTE. The Ref Level Autoset state is shown only for Ch1-Ch4 sources. It is the same for MATH and Ref waveforms. For example: DPOJET:REFLevels:MATH<x>, DPOJET:REFLevels:REF<x>.

DPOJET:REFLevels:CH<x>:ABSolute

The ABSolute branch specifies the ref levels in cases where a user chooses not to run a ref level autoset on a given source. If a user does run a ref level autoset, the percentage values of Rise, Fall and Hysteresis are used.

DPOJET:REFLevels:CH<x>:ABSolute:RISEHigh

This command sets the ref level voltage relative to base top for autoset. The default is 1.0.

Syntax DPOJET:REFLevels:CH<x>:ABSolute:RISEHigh <NR3>

Inputs <NR3>

Outputs <NR3>

DPOJET:REFLevels:CH<x>:ABSolute:RISELow

This command sets the ref level voltage relative to base top for autoset. The default is -1.0.

Syntax DPOJET:REFLevels:CH<x>:ABSolute:RISELow <NR3>

Inputs <NR3>

Outputs <NR3>

DPOJET:REFLevels:CH<x>:ABSolute:RISEMid

This command sets the ref level voltage relative to base top for autoset. The default is 0.0.

Syntax DPOJET:REFLevels:CH<x>:ABSolute:RISEMid <NR3>

Inputs <NR3>

Outputs <NR3>

DPOJET:REFLevels:CH<x>:ABSolute:FALLHigh

This command sets the ref level voltage relative to base top for autoset. The default is 1.0.

Syntax DPOJET:REFLevels:CH<x>:ABSolute:FALLHigh <NR3>

Inputs <NR3>

Outputs <NR3>

DPOJET:REFLevels:CH<x>:ABSolute:FALLLow

This command sets the ref level voltage relative to base top for autoset. The default is -1.1.

Syntax DPOJET:REFLevels:CH<x>:ABSolute:FALLLow <NR3>

Inputs <NR3>

Outputs <NR3>

DPOJET:REFLevels:CH<x>:ABSolute:FALLMid

This command sets the ref level voltage relative to base top for autoset. The default is 0.0.

Syntax DPOJET:REFLevels:CH<x>:ABSolute:FALLMid <NR3>

Inputs <NR3>

Outputs <NR3>

DPOJET:REFLevels:CH<x>:ABSolute:HYSTeresis

This command sets the hysteresis value used for autoset. The default is 0.03.

Syntax DPOJET:REFLevels:CH<x>:ABSolute:HYSTeresis <NR3>

Inputs <NR3>

Outputs <NR3>

DPOJET:REFLevels:CH<x>:BASETop

This command sets the base-top method for autoset.

Syntax DPOJET:REFLevels:CH<x>:BASETop {MINMax | FULLhistogram | EYEhistogram | AUTO}

Inputs {MINMax | FULLhistogram | EYEhistogram | AUTO}

Outputs {MINMax | FULLhistogram | EYEhistogram | AUTO}

DPOJET:REFLevels:CH<x>:PERcent

The ref level commands that follow set percent ref level parameters in the same way that the absolute parameters do, except that these commands set the various percentage levels used by the autoset.

DPOJET:REFLevels:CH<x>:PERcent:FALLHigh

This command sets the ref level voltage relative to base top for autoset.

Syntax DPOJET:REFLevels:CH<x>:PERcent:FALLHigh <NR3>

Inputs <NR3>

Outputs <NR3>

DPOJET:REFLevels:CH<x>:PERcent:FALLLow

This command sets the ref level voltage relative to base top for autoset.

Syntax DPOJET:REFLevels:CH<x>:PERcent:FALLLow <NR3>

Inputs <NR3>

Outputs <NR3>

DPOJET:REFLevels:CH<x>:PERcent:FALLMid

This command sets the ref level voltage relative to base top for autoset.

Syntax DPOJET:REFLevels:CH<x>:PERcent:FALLMid <NR3>

Inputs <NR3>

Outputs <NR3>

DPOJET:REFLevels:CH<x>:PERcent:PERCENTReflevel

This command sets or gets the Reference Levels to Percentage or Absolute.

Syntax DPOJET:REFLevels:CH<x>:PERcent:PERCENTReflevel { 1 | 0 }
DPOJET:REFLevels:CH<x>:PERcent:PERCENTReflevel?

Inputs 1 - Percentage
0 - Absolute

Outputs { 1 | 0 }

NOTE. The *reflevel* commands can be used to set ref levels for CH1-CH4, MATH1-MATH4, and REF1-REF4. The command syntax in OLH is shown only for CH<x>. Use MATH<x> and REF<x> for MATH1-MATH4, and REF1-REF4 (DPOJET:REFLevels:MATH<x> and REF (DPOJET:REFLevels:REF<x>)).

DPOJET:REFLevels:CH<x>:PERcent:HYSTeresis

This command sets the hysteresis value used for autoset.

Syntax DPOJET:REFLevels:CH<x>:PERcent:HYSTeresis <NR3>

Inputs <NR3>

Outputs <NR3>

DPOJET:REFLevels:CH<x>:PERcent:RISEHigh

This command sets the ref level voltage relative to base top for autoset.

Syntax DPOJET:REFLevels:CH<x>:PERcent:RISEHigh <NR3>

Inputs <NR3>

Outputs <NR3>

DPOJET:REFLevels:CH<x>:PERcent:RISELow

This command sets the ref level voltage relative to base top for autoset.

Syntax DPOJET:REFLevels:CH<x>:PERcent:RISELow <NR3>

Inputs <NR3>

Outputs <NR3>

DPOJET:REFLevels:CH<x>:PERcent:RISEMid

This command sets the ref level voltage relative to base top for autoset.

Syntax DPOJET:REFLevels:CH<x>:PERcent:RISEMid <NR3>

Inputs <NR3>

Outputs <NR3>

DPOJET:REPORT

These are set-only commands. EXECute executes a DPOJET report save operation for the currently defined report configuration. APPEnd appends new data to the selected report.

Syntax DPOJET:REPORT {EXECute | APPEnd}

Inputs {EXECute | APPEnd}

DPOJET:REPORT:APPLIcationconfig

This command turns on or off including complete application configuration in reports.

Syntax DPOJET:REPORT:APPLIcationconfig {1 | 0}

Inputs {1 | 0}

Outputs {1 | 0}

DPOJET:REPORT:AUTOincrement

This command turns on or off auto increment of report file names.

Syntax DPOJET:REPORT:AUTOincrement {1 | 0}

Inputs {1 | 0}

Outputs {1 | 0}

DPOJET:REPORT:COMments

This command sets or queries the comments.

Syntax DPOJET:REPORT:COMments <string>
DPOJET:REPORT:COMments?

Inputs <string>

Outputs <string>

DPOJET:REPORT:DETailedresults

This command turns on or off including detailed results in reports.

Syntax DPOJET:REPORT:DETailedresults {1 | 0}

Inputs {1 | 0}

Outputs {1 | 0}

DPOJET:REPORT:DISPunits

This command turns on or off displaying units in separate column

Syntax DPOJET:REPORT:DISPunits {1 | 0}

Inputs {1 | 0}

Outputs {1 | 0}

DPOJET:REPORT:ENABlecomments

This command sets or queries the comments enable or disable settings.

Syntax DPOJET:REPORT:ENABlecomments {1 | 0}
DPOJET:REPORT:ENABlecomments?

Inputs {1 | 0}

Outputs {1 | 0}

DPOJET:REPORT:GETIMAGE

This command returns the image which is set using
DPOJET:REPORT:SETIMAGEPath command in binary format.

Syntax DPOJET:REPORT:GETIMAGE?

Outputs Returns the image in binary format

DPOJET:REPORT:GETIMAGENAME

This query only commands gets all the PNG format image names from this directory *C:\Users\<userName>\Tektronix\TekApplications\DPOJET\Reports\Resources*.

Syntax DPOJET:REPORT:GETIMAGENAME?

Outputs After parsing the query results, the data is a stream of string

DPOJET:REPORT:GETXMLReport

This query only command retrieve the report in binary format

Syntax DPOJET:REPORT:GETXMLReport?

Outputs After parsing the query results, the data is a stream of xmlstring

DPOJET:REPORT:PASSFailresults

This command turns on or off including pass/fail results in reports.

Syntax DPOJET:REPORT:PASSFailresults {1 | 0}

Inputs {1 | 0}

Outputs {1 | 0}

DPOJET:REPORT:PLOTimages

This command turns on or off including detailed plot images in reports.

Syntax DPOJET:REPORT:PLOTimages {1 | 0}

Inputs {1 | 0}

Outputs {1 | 0}

DPOJET:REPORT:REPORTName

This command sets the current report file name.

Syntax DPOJET:REPORT:REPORTName <string>

Inputs <string>

Outputs <string>

DPOJET:REPORT:SETupconfig

This command turns on or off including setup configuration in reports.

Syntax DPOJET:REPORT:SETupconfig {1 | 0}

Inputs {1 | 0}

Outputs {1 | 0}

DPOJET:REPORT:SAVEWaveforms

This command turns on or off saving waveforms when a report save/append is invoked.

Syntax DPOJET:REPORT:SAVEWaveforms {1 | 0}

Inputs {1 | 0}

Outputs {1 | 0}

DPOJET:REPORT:SETIMAGEPath

This command sets the path of the image which you want to retrieve using DPOJET:REPORT:GETIMAGE command.

Syntax DPOJET:REPORT:SETIMAGEPath <file string>

Inputs <file string>

DPOJET:REPORT:STATE?

This query-only command provides the report status.

Syntax DPOJET:REPORT:STATE?

Outputs INPROGRESS | DONE

DPOJET:REPORT:VIEWreport

This command turns on or off viewing report after generation.

Syntax DPOJET:REPORT:VIEWreport {1 | 0}

Inputs {1 | 0}

Outputs {1 | 0}

DPOJET:RESULts:STATus?

This query-only command returns the overall pass/fail status.

Syntax DPOJET:RESULts:STATus?

Outputs {PASS | FAIL}

DPOJET:RESULts:View

This command sets or queries the results view type.

Syntax DPOJET:RESULts:View {SUMmary | DETails}
DPOJET:RESULts:View?

Inputs {SUMmary | DETails}

Outputs {SUMmary | DETails}

DPOJET:RESULts:GETALLResults?

The query only command returns all the measurement results in binary format. This command is similar to curve query.

Syntax DPOJET:RESULts:GETALLResults?

Outputs After parsing the query results, the data is a stream of xmlstring.

DPOJET:SAVE

This set-only command saves the specified DPOJET measurement result to the specified ref. For Example: DPOJET:SAVE MEAS4, REF2.

Syntax DPOJET:SAVE {MEAS1-MEAS99 | REF1-REF4}

Inputs {MEAS1-MEAS99 | REF1-REF4}

DPOJET:SETIMAGETPath

This command sets or queries the image path of the DPOJET application.

Syntax DPOJET:SETIMAGETPath <file string>
DPOJET:SETIMAGETPath?

Inputs <file string>

Outputs <file string>

DPOJET:SETLOGGINGPath

This command sets or queries the Logging path of the DPOJET application.

Syntax DPOJET:SETLOGGINGPath <file string>
DPOJET:SETLOGGINGPath?

Inputs <file string>

Outputs <file string>

DPOJET:SETREPORTPath

This command sets or queries the Report path of the DPOJET application.

Syntax DPOJET:SETREPORTPath <file string>
DPOJET:SETREPORTPath?

Inputs <file string>

Outputs <file string>

DPOJET:SOURCEAutoset

This command performs a DPOJET horizontal, vertical, or autoset on both horizontal and vertical for any sources used in current measurements.

Syntax DPOJET:SOURCEAutoset {HORIZontal | VERTical | BOTH}

Inputs {HORIZontal | VERTical | BOTH}

DPOJET:SOURCEAutoset:HORIZontal:UICount

This command sets or queries the UICount for horizontal autoset.

Syntax DPOJET:SOURCEAutoset:HORIZontal:UICount <NR3>
DPOJET:SOURCEAutoset:HORIZontal:UICount?

Inputs <NR3>. Default is 10000.

Outputs <NR3>

DPOJET:SOURCEAutoset:HORizontal:UIValue

This command sets or queries the UI value for horizontal autoset.

Syntax DPOJET:SOURCEAutoset:HORizontal:UIValue <NR3>
DPOJET:SOURCEAutoset:HORizontal:UIValue?

Inputs <NR3>

Outputs <NR3>

DPOJET:SOURCEAutoset:STATE?

This query-only command provides the Source Autoset status.

Syntax DPOJET:SOURCEAutoset:STATE?

Outputs "RUNNING" | "STOPPED"

DPOJET:STATE

This command sets or queries the current measurement state of DPOJET.

Syntax DPOJET:STATE {RUN | SINGLE | RECALC | CLEAR | STOP}
DPOJET:STATE?

Inputs {RUN | SINGLE | RECALC | CLEAR | STOP}

Outputs The current state of the DPOJET measurement sequencer, including any of the possible inputs.

DPOJET:TDCOMPensation

This command sets or queries the TD compensation state.

Syntax DPOJET:TDCOMPensation {1 | 0 | ON | OFF}
DPOJET:TDCOMPensation?

Inputs {1 | 0 | ON | OFF}

Outputs {1 | 0}

DPOJET:UNITType

This command sets or queries the current unit-type setting for DPOJET, either Unit Interval, or seconds.

Syntax DPOJET:UNITType {UNITinterval | SECONDS}
DPOJET:UNITType?

Inputs {UNITinterval | SECONDS}

Outputs {UNITinterval | SECONDS}

DPOJET:LOCKRJ

This command sets or queries the Lock RJ Value.

Syntax DPOJET:LOCKRJ {1 | 0}
DPOJET:LOCKRJ?

Inputs {1 | 0}

Outputs {1 | 0}

DPOJET:LOCKRJValue

This command sets or queries the LockRJValue.

Syntax DPOJET:LOCKRJValue <NR3>
DPOJET:LOCKRJValue?

Inputs { Min = 1fs, Max = 1s }

Outputs

DPOJET:PLOT(x):BATHtub:XAXISUnits

This command sets or queries the X-Axis Units of Bathtub.

Syntax DPOJET:PLOT<x>:BATHtub:XAXISUnits { UNITIntervals | SECOnds }
DPOJET:PLOT<x>:BATHtub:XAXISUnits?

Inputs { UNITIntervals | SECOnds }

Outputs { UNITIntervals | SECOnds }

DPOJET:PLOT(x):NOISEBATHtub:YAXISUnits

This command sets or queries the Y-Axis Units of Noise Bath tub.

Syntax DPOJET:PLOT<x>:NOISEBATHtub:YAXISUnits { UNITAmplitudes | VOLTs }
DPOJET:PLOT<x>:NOISEBATHtub:YAXISUnits?

Inputs { UNITAmplitudes | VOLTs }

Outputs { UNITAmplitudes | VOLTs }

DPOJET:VERTUNITType

This command sets or queries the vertical Unit.

Syntax DPOJET:VERTUNITType {UNITamplitude | VOLTs}
DPOJET:VERTUNITType?

Inputs {UNITamplitude | VOLTs}

Outputs {UNITamplitude | VOLTs}

DPOJET:VERsion?

This query-only command returns the current DPOJET version string.

Syntax DPOJET:VERsion?

Outputs <string>

Index

- Duty Cycle, 26
- CC-Duty, 26
- (SSC), 105
- + CC-Duty, 26
- +Duty Cycle, 26

A

- About DPOJET
 - Help › About DPOJET, 9
- About PLL loop BW, 60
- AC common mode, 300
- AC Common Mode, 33
- Advanced explicit Clock-Edge, 66
- Advanced explicit clock-PLL, 68
- Advanced filter configure parameters, 234
- Algorithms, 271
- Analysis method, 145
- Application Directories
 - installation directory for DPOJET, 13
- Apply to all, 62
- Argument Types, 330
- Auto calc every acq, 54, 55
- Auto calc first acq, 54, 55
- Autocalc every acq, 54
- Autocalc first acq, 54
- Autoset, 134
- Autoset Parameters, 223
- Autoset ref levels, 138
- Average optical power, 36

B

- Band Pass, 46
- Bathtub, 178
- Bathtub plot parameters, 238
- BER eye contour plot parameters, 239
- BER eye plot parameters, 240
- Bit config
 - eye high, 70
 - eye low, 70
 - Q-factor, 70
- Bit config for amplitude, 80

- Bit config for eye height, 70
- Bit config for Height@BER - Jitter + Nose, 72
- Bit config for Height@BER - Jitter only, 71
- Bit config for mask hits, 74
- Bit config for mask hits ratio measurement, 78
- Bit config for mask margin measurement, 79
- Bit config for TN@BER, 73
- Bit config parameters, 227
- blanking duration, 50
- Blanking time, 51
- Breakdown of jitter, 246
- Breakdown of noise, 248
- Brick wall, 48
- Brick wall filter, 48
- Browse, 11

C

- CC-Period, 26, 275
- Check Boxes, 11
- Clear, 19
- Clear log, 141
- Clock edge, 65, 66
- Clock Edge, 69
- Clock multiplier, 65, 66
- Clock Multiplier, 69
- Clock recovery, 52
- Clock recovery advanced setup, 57
- clock recovery methods, 52
- Clock recovery parameters, 230
- Clock source, 65
- CM V, 33
- Comma separated value, 152
- Command button, 11
- compatibility, 8
- Compatibility, 8
- Composite Jitter Hist, 178
- Composite jitter histogram plot parameters, 238
- Composite noise histogram plot parameters, 239
- Configure, 20, 185
- Configure a BER Eye contour plot, 199
- Configure a BER Eye plot, 200

- Configure a Correlated Eye plot, 200
 - Configure a PDF Eye plot, 201
 - Configure autosets, 117
 - Configure measurement-Jitter summary, 114
 - Configure measurement-Skew, 113
 - Configuring a noise bathtub plot, 198
 - Configuring bathtub plot, 184
 - Configuring bus states, 88
 - Configuring edges for CC-Period, 95
 - Configuring edges for DCD, 96
 - Configuring edges for DDR tCH, 102
 - Configuring edges for DDR tCL, 102
 - Configuring edges for DDR tERR(m-n), 102
 - Configuring edges for DDR tERR(n), 103
 - Configuring edges for DDR tHZDQ, 103
 - Configuring edges for DDR tLZDQ, 103
 - Configuring edges for DDR VIH.DQ(AC), 104
 - Configuring edges for DDR VIH.DQ(DC), 104
 - Configuring edges for DDR VIL.DQ(AC), 104
 - Configuring edges for DDR VIL.DQ(DC), 104
 - Configuring edges for DDRJIT, 104
 - Configuring edges for DDRtCK, 104
 - Configuring edges for differential crossOver, 93
 - Configuring edges for duty cycle, 95
 - Configuring edges for F/N - Jitter + Noise, 101
 - Configuring edges for F/N - Jitter Only, 100
 - Configuring edges for fall slew rate, 97
 - Configuring edges for hold, 95
 - Configuring edges for N-Period, 94
 - Configuring edges for overshoot, 96
 - Configuring edges for phase noise, 93
 - Configuring edges for rise slew rate, 97
 - Configuring edges for setup, 95
 - Configuring edges for skew, 92
 - Configuring edges for time outside level, 99
 - Configuring edges for undershoot, 96
 - Configuring Filters for SJ@Freq, 52
 - Configuring histogram plot, 187
 - Configuring phase noise plot, 189
 - Configuring plots, 183
 - Configuring spectrum plot, 185
 - Configuring time trend, 186
 - Configuring transfer plot, 188
 - Connecting to a device under test (DUT), 22
 - Constant clock - fixed, 53, 56
 - Constant clock - mean, 53
 - Constant clock - median, 53, 55
 - Control panel, 19
 - Control Panel Parameters, 227
 - Conventions, 2
 - Correlated eye plot parameters, 240
 - Cursors and reset cursors, 202
 - Cursors in a plot, 204
 - Custom Measurement Name, 40
 - Custom source name, 120
 - Customer Feedback, 3
 - Cycle Max, 33
 - Cycle Min, 33
 - Cycle Pk-Pk, 33
- ## D
- Damping, 61
 - Data Array, 177
 - Data Logging Parameters, 226
 - Data logging-Measurement, 154
 - Data logging-Statistics, 152
 - Data rate, 26
 - DC common mode, 300
 - DC Common Mode, 33
 - DCD, 27, 279
 - DDJ, 27, 279
 - DDR105, 254
 - DDR106, 254
 - DDR107, 254
 - DDRtJit(per), 104
 - Description, 170
 - Deskew, 22
 - Deskew Parameters, 225
 - Details, 173
 - DFE parameters, 236
 - DJ, 27, 278
 - DPOJET, xix, 2
 - DPOJET:PLOT<x>:EXPORTRaw?, 466
 - Dual Dirac Deterministic Jitter, 278
 - Dual Dirac model, 146
 - Dual Dirac Random Jitter, 277

DUT, 2
Duty Cy-Cy, 26

E

E1001, 250
E1002, 250
E1003, 250
E1004, 250
E1005, 250
E1006, 250
E1007, 250
E1008, 251
E1009, 251
E1010, 251
E1012, 251
E1013, 251
E102, 250
E1020, 251
E1021, 251
E1022, 251
E1026, 251
E1027, 251
E1028, 251
E1029, 251
E103, 250
E1035, 251
E104, 250
E1040, 251
E1041, 251
E105, 250
E1054, 251
E1055, 251
E1056, 251
E1057, 251
E1058, 251
E1059, 251
E106, 250
E1060, 251
E1061, 251
E1062, 251
E1063, 251
E1065, 251
E1066, 252
E107, 250
E108, 250
E109, 250
E2001, 252
E2002, 252
E2003, 252
E2004, 252
E2005, 252
E2006, 252
E2007, 252
E2008, 252
E202, 250
E3001, 252
E3002, 252
E3003, 252
E3004, 252
E3005, 252
E3006, 252
E3007, 252
E3008, 252
E3009, 252
E3010, 252
E3011, 252
E3012, 252
E400, 250
E4000, 252
E4001, 252
E4002, 252
E4003, 252
E4004, 252
E4005, 252
E4006, 253
E4007, 253
E4010, 253
E4011, 253
E4012, 253
E4013, 253
E4014, 253
E4015, 253
E4016, 253
E4017, 253
E4018, 253
E4019, 253

- E4020, 253
 - E4021, 253
 - E4022, 253
 - E4023, 253
 - E4024, 253
 - E4027, 253
 - E4028, 253
 - E4029, 253
 - E4030, 253
 - E4031, 253
 - E4032, 253
 - E4033, 253
 - E4034, 254
 - E4035, 254
 - E4036, 254
 - E4037, 254
 - E4038, 254
 - E4039, 254
 - E4040, 254
 - E4041, 254
 - E4042, 254
 - E411, 250
 - E424, 250
 - E425, 250
 - E426, 250
 - E427, 250
 - E500, 250
 - E5000, 254
 - E5001, 254
 - E5002, 254
 - E5003, 254
 - E5004, 254
 - E6001, 254
 - E6002, 254
 - E7001, 254
 - E7002, 254
 - E8000, 254
 - Edge increment, 94
 - Edges configuration for Jitter + Noise measurements, 91
 - Edges configuration for Jitter Only measurements, 90
 - Error log file, 13
 - Explicit clock recovery, 64
 - Explicit clock-edge, 65
 - Explicit clock-PLL, 67
 - Export data snapshot-Measurement, 149
 - Export data snapshot-Statistics, 148
 - Export figure, 202
 - Export measurement summary, 151
 - Export results to Ref, 174
 - Exporting plot files, 205
 - Extinction ratio, 36
 - Eye analysis, 5
 - Eye Crossing Level, 36
 - Eye Crossing Percent, 36
 - Eye Crossing Time, 36
 - Eye Diagram, 178
 - Eye diagram for mask hits, 192
 - Eye diagram plot for DFE EH, 194
 - Eye diagram plot for DFE EW, 194
 - Eye diagram plot for DFE Eye Diagram, 194
 - Eye diagram plot for eye height, 190
 - Eye diagram plot parameters, 237
 - Eye height, 293
 - Eye high, 295
 - Eye low, 295
 - Eye summary, 118
 - Eye width, 293
- ## F
- F/N, 28
 - Fall slew rate, 99, 289
 - Fall time, 286
 - Fall Time, 30
 - Filter Spec, 47
 - Filters, 46
 - Filters parameters, 234
 - Five-Time Free Trial, 1
 - Freq (F1), 47
 - Freq (F2), 47
 - Frequency, 26, 273
- ## G
- Gating, 41
 - General, 39

- General parameters, 235
- Global, 40
- Global parameters, 235
- GPIB Commands
 - DPOJET:PLOT<x>:BATHtub:XAXISUnits, 507
 - DPOJET:PLOT<x>:COMPOSITENoisehist:TN, 476
 - DPOJET:ADDMeas, 330
 - DPOJET:ADDPlot, 422
 - DPOJET:ANALYSISMETHOD, 342
 - DPOJET:CLEARALLMeas, 332
 - DPOJET:CLEARALLPlots, 422
 - DPOJET:DESKEW, 333
 - DPOJET:DESKEW:DESKEWchannel, 333
 - DPOJET:DESKEW:DESKEWHysteresis, 334
 - DPOJET:DESKEW:DESKEWMidlevel, 334
 - DPOJET:DESKEW:EDGE, 335
 - DPOJET:DESKEW:MAXimum, 335
 - DPOJET:DESKEW:MINimum, 336
 - DPOJET:DESKEW:REFChannel, 336
 - DPOJET:DESKEW:REFHysteresis, 337
 - DPOJET:DESKEW:REFMidlevel, 337
 - DPOJET:DIRacmodel, 338
 - DPOJET:EXPORT, 338
 - DPOJET:EXPORTRaw, 339
 - DPOJET:GATING, 339
 - DPOJET:HALTFreerunonlimfail, 340
 - DPOJET:HIGHPerfrendering, 340
 - DPOJET:INTERp, 341
 - DPOJET:LASTError?, 342
 - DPOJET:LIMITRise, 343
 - DPOJET:LIMits:FILENAME, 344
 - DPOJET:LIMits:STATE, 344
 - DPOJET:LOCKRJ, 506
 - DPOJET:LOCKRJValue, 507
 - DPOJET:LOGging:MEASurements:FOLDer, 345
 - DPOJET:LOGging:MEASurements:STATE, 345
 - DPOJET:LOGging:SNAPshot, 346
 - DPOJET:LOGging:STATistics:FILENAME, 346
 - DPOJET:LOGging:STATistics:STATE, 347
 - DPOJET:LOGging:WORSTcase:FOLDer, 347
 - DPOJET:LOGging:WORSTcase:STATE, 348
 - DPOJET:MEAS<x>, 348
 - DPOJET:MEAS<x>:BER:TARGETBER, 349
 - DPOJET:MEAS<x>:BITCfgmethod, 349
 - DPOJET:MEAS<x>:BITConfig:ENDPercent, 351
 - DPOJET:MEAS<x>:BITConfig:NUMBins, 351
 - DPOJET:MEAS<x>:BITConfig:STARTPercent, 350
 - DPOJET:MEAS<x>:BITPcnt, 350
 - DPOJET:MEAS<x>:BITType, 352
 - DPOJET:MEAS<x>:BUSState:CLOCKPolarity, 353
 - DPOJET:MEAS<x>:BUSState:FROMPattern, 353
 - DPOJET:MEAS<x>:BUSState:FROMSymbol, 354
 - DPOJET:MEAS<x>:BUSState:MEASBUStype, 354
 - DPOJET:MEAS<x>:BUSState:MEASUREFROM, 355
 - DPOJET:MEAS<x>:BUSState:MEASURETO, 355
 - DPOJET:MEAS<x>:BUSState:TOPattern, 356
 - DPOJET:MEAS<x>:BUSState:TOSymbol, 356
 - DPOJET:MEAS<x>:CLOCKRecovery:BWType, 360
 - DPOJET:MEAS<x>:CLOCKRecovery:CLOCKBitrate, 357
 - DPOJET:MEAS<x>:CLOCKRecovery:CLOCKFrequency, 357
 - DPOJET:MEAS<x>:CLOCKRecovery:CLOCKMultiplier, 358
 - DPOJET:MEAS<x>:CLOCKRecovery:CLOCKPath, 358
 - DPOJET:MEAS<x>:CLOCKRecovery:DAMPing, 359
 - DPOJET:MEAS<x>:CLOCKRecovery:DATARate, 359
 - DPOJET:MEAS<x>:CLOCKRecovery:LOOPBandwidth, 360
 - DPOJET:MEAS<x>:CLOCKRecovery:MEANAUTOCalculate, 361
 - DPOJET:MEAS<x>:CLOCKRecovery:METHod, 361
 - DPOJET:MEAS<x>:CLOCKRecovery:MODEL, 362
 - DPOJET:MEAS<x>:CLOCKRecovery:NOMINALOFFset, 362

- DPOJET:MEAS<x>:CLOCKRecovery:
NOMINALOFFset:Auto?, 363
- DPOJET:MEAS<x>:CLOCKRecovery:
NOMINALOFFset:Manual, 363
- DPOJET:MEAS<x>:CLOCKRecovery:
NOMINALOFFset:Recalctype, 364
- DPOJET:MEAS<x>:CLOCKRecovery:
NOMINALOFFset:Selectiontype, 364
- DPOJET:MEAS<x>:CLOCKRecovery:PATtern,
365
- DPOJET:MEAS<x>:CLOCKRecovery:STANDARD,
365
- DPOJET:MEAS<x>:COMMONMode:FILters:
STATE, 366
- DPOJET:MEAS<x>:CUSTomname, 366
- DPOJET:MEAS<x>:DATA?, 367
- DPOJET:MEAS<x>:DISPLAYNAME?, 370
- DPOJET:MEAS<x>:DPOJET:MEAS<x>:
REFVvoltage, 380
- DPOJET:MEAS<x>:EDGE1, 371
- DPOJET:MEAS<x>:EDGE2, 371
- DPOJET:MEAS<x>:EDGEIncre, 372
- DPOJET:MEAS<x>:EDGES:FROMLevel, 372
- DPOJET:MEAS<x>:EDGES:LEVel, 373
- DPOJET:MEAS<x>:EDGES:
SLEWRATETechnique, 373
- DPOJET:MEAS<x>:EDGES:SUBRATEDivisor,
374
- DPOJET:MEAS<x>:EDGES:TOLevel, 376
- DPOJET:MEAS<x>:FILters:BLANKingtime, 376
- DPOJET:MEAS<x>:FILters:HIGHPass:FREQ,
377
- DPOJET:MEAS<x>:FILters:HIGHPass:SPEC,
377
- DPOJET:MEAS<x>:FILters:LOWPass:FREQ,
378
- DPOJET:MEAS<x>:FILters:LOWPass:SPEC,
378
- DPOJET:MEAS<x>:FILters:RAMPTime, 380
- DPOJET:MEAS<x>:FILters:SJBAndwidth, 379
- DPOJET:MEAS<x>:FILters:SJFRequency, 379
- DPOJET:MEAS<x>:FROMedge, 381
- DPOJET:MEAS<x>:HIGHREFVvoltage, 381
- DPOJET:MEAS<x>:LOGging:MEASurements:
FILEName?, 382
- DPOJET:MEAS<x>:LOGging:MEASurements:
SELEct, 383
- DPOJET:MEAS<x>:LOGging:WORSTcase:
SELEct, 384
- DPOJET:MEAS<x>:LOWREFVvoltage, 382
- DPOJET:MEAS<x>:MASKfile, 386
- DPOJET:MEAS<x>:MASKOffset:HORIZontal:
AUTOfit?, 387
- DPOJET:MEAS<x>:MASKOffset:HORIZontal:
MANual, 388
- DPOJET:MEAS<x>:MASKOffset:HORIZontal:
SELECTIONtype, 387
- DPOJET:MEAS<x>:MEASRange, 389
- DPOJET:MEAS<x>:MEASRange:MAX, 388
- DPOJET:MEAS<x>:MEASRange:MIN, 389
- DPOJET:MEAS<x>:MEASStart, 390
- DPOJET:MEAS<x>:N, 390
- DPOJET:MEAS<x>:NAME?, 391
- DPOJET:MEAS<x>:PHASENoise:HIGHLimit,
383, 391
- DPOJET:MEAS<x>:PHASENoise:LOWLimit,
392
- DPOJET:MEAS<x>:REFVvoltage, 392
- DPOJET:MEAS<x>:RESULTS?, 393
- DPOJET:MEAS<x>:RESULTS:ALLAcqs?, 393
- DPOJET:MEAS<x>:RESULTS:ALLAcqs:
HITPopulation?, 393
- DPOJET:MEAS<x>:RESULTS:ALLAcqs:HITS?,
394
- DPOJET:MEAS<x>:RESULTS:ALLAcqs:LIMits:
High:STATus?, 394
- DPOJET:MEAS<x>:RESULTS:ALLAcqs:LIMits:
LOW:STATus?, 395
- DPOJET:MEAS<x>:RESULTS:ALLAcqs:LIMits:
STATus?, 394
- DPOJET:MEAS<x>:RESULTS:ALLAcqs:MAX?,
395
- DPOJET:MEAS<x>:RESULTS:ALLAcqs:MAX:
HIGHLimit?, 397
- DPOJET:MEAS<x>:RESULTS:ALLAcqs:MAX:
HIGHMargin?, 397
- DPOJET:MEAS<x>:RESULTS:ALLAcqs:MAX:
STATus?, 396
- DPOJET:MEAS<x>:RESULTS:ALLAcqs:
MAXCC?, 395

- DPOJET:MEAS<x>:RESULTS:ALLAcqs:
MAXCC:STATUs?, 396
- DPOJET:MEAS<x>:RESULTS:ALLAcqs:
MAXHits?, 396
- DPOJET:MEAS<x>:RESULTS:ALLAcqs:MEAN?,
398
- DPOJET:MEAS<x>:RESULTS:ALLAcqs:MEAN:
HIGHLimit?, 399
- DPOJET:MEAS<x>:RESULTS:ALLAcqs:MEAN:
STATUs?, 399
- DPOJET:MEAS<x>:RESULTS:ALLAcqs:MIN?,
399
- DPOJET:MEAS<x>:RESULTS:ALLAcqs:MIN:
LOWLimit?, 398
- DPOJET:MEAS<x>:RESULTS:ALLAcqs:MIN:
LOWMArgin?, 398
- DPOJET:MEAS<x>:RESULTS:ALLAcqs:MIN:
STATUs?, 401
- DPOJET:MEAS<x>:RESULTS:ALLAcqs:
MINCC?, 400
- DPOJET:MEAS<x>:RESULTS:ALLAcqs:MINCC:
STATUs?, 400
- DPOJET:MEAS<x>:RESULTS:ALLAcqs:
MINHits?, 400
- DPOJET:MEAS<x>:RESULTS:ALLAcqs:PK2PK?,
401
- DPOJET:MEAS<x>:RESULTS:ALLAcqs:
POPulation?, 402
- DPOJET:MEAS<x>:RESULTS:ALLAcqs:
POPulation:STATUs?, 402
- DPOJET:MEAS<x>:RESULTS:ALLAcqs:SEG<x>:
Hits?, 403
- DPOJET:MEAS<x>:RESULTS:ALLAcqs:SEG<x>:
MAXHits?, 403
- DPOJET:MEAS<x>:RESULTS:ALLAcqs:SEG<x>:
MINHits?, 403
- DPOJET:MEAS<x>:RESULTS:ALLAcqs:
STDDev?, 404
- DPOJET:MEAS<x>:RESULTS:ALLAcqs:
STDDEV:STATUs?, 404
- DPOJET:MEAS<x>:RESULTS:CURREntacq:
MAX?, 404
- DPOJET:MEAS<x>:RESULTS:CURREntacq:
MAX:STATUs?, 406
- DPOJET:MEAS<x>:RESULTS:CURREntacq:
MAXCC?, 405
- DPOJET:MEAS<x>:RESULTS:CURREntacq:
MAXCC:STATUs?, 405
- DPOJET:MEAS<x>:RESULTS:CURREntacq:
MEAN?, 406
- DPOJET:MEAS<x>:RESULTS:CURREntacq:
MEAN:STATUs?, 406
- DPOJET:MEAS<x>:RESULTS:CURREntacq:
MIN?, 407
- DPOJET:MEAS<x>:RESULTS:CURREntacq:MIN:
STATUs?, 408
- DPOJET:MEAS<x>:RESULTS:CURREntacq:
MINCC?, 407
- DPOJET:MEAS<x>:RESULTS:CURREntacq:
MINCC:STATUs?, 407
- DPOJET:MEAS<x>:RESULTS:CURREntacq:
PK2PK?, 408
- DPOJET:MEAS<x>:RESULTS:CURREntacq:
PK2PK:STATUs?, 409
- DPOJET:MEAS<x>:RESULTS:CURREntacq:
POPulation?, 409
- DPOJET:MEAS<x>:RESULTS:CURREntacq:
POPulation:STATUs?, 409
- DPOJET:MEAS<x>:RESULTS:CURREntacq:
STDDev?, 410
- DPOJET:MEAS<x>:RESULTS:CURREntacq:
STDDev:STATUs?, 410
- DPOJET:MEAS<x>:RESULTS:STATUs?, 411
- DPOJET:MEAS<x>:RESULTS:VIEw?, 411
- DPOJET:MEAS<x>:RJDJ:BER, 411
- DPOJET:MEAS<x>:RJDJ:DETECTPLEN, 412
- DPOJET:MEAS<x>:RJDJ:PATLen, 412
- DPOJET:MEAS<x>:RJDJ:TYPe, 413
- DPOJET:MEAS<x>:RJDJ:WINDOwlength, 413
- DPOJET:MEAS<x>:RNDN:
AUTODETECTpattern, 414
- DPOJET:MEAS<x>:RNDN:BER, 414
- DPOJET:MEAS<x>:RNDN:PATLen, 415
- DPOJET:MEAS<x>:RNDN:TYPe, 415
- DPOJET:MEAS<x>:RNDN:WINDOwlength, 416
- DPOJET:MEAS<x>:SIGNALType, 416
- DPOJET:MEAS<x>:SOUrce1, 417
- DPOJET:MEAS<x>:SOUrce2, 417
- DPOJET:MEAS<x>:SSC: NOMInalfreq: MANual,
418

- DPOJET:MEAS<x>:SSC:: NOMinalfreq:
SELECTIONtype, 419
- DPOJET:MEAS<x>:SSC:NOMinalfreq:AUTO?,
418
- DPOJET:MEAS<x>:TIMEDATa?, 419
- DPOJET:MEAS<x>:TOEdge, 420
- DPOJET:MEAS<x>:ZOOMEVENT, 420
- DPOJET:MINBUJUI, 343
- DPOJET:NOISEENABLED, 421
- DPOJET:NUMMeas?, 421
- DPOJET:PLOT<x>:BATHtub:BER, 441
- DPOJET:PLOT<x>:BATHtub:VERTical:SCALE,
442
- DPOJET:PLOT<x>:BERContour:ALIGNment,
459
- DPOJET:PLOT<x>:BERContour:BER1E12, 462
- DPOJET:PLOT<x>:BERContour:BER1E15, 463
- DPOJET:PLOT<x>:BERContour:BER1E18, 463
- DPOJET:PLOT<x>:BERContour:BER1E6, 461
- DPOJET:PLOT<x>:BERContour:BER1E9, 462
- DPOJET:PLOT<x>:BERContour:HORizontal:
AUTOScale, 459
- DPOJET:PLOT<x>:BERContour:HORizontal:
RESolution, 460
- DPOJET:PLOT<x>:BERContour:MASK, 460
- DPOJET:PLOT<x>:BERContour:MASKFile, 460
- DPOJET:PLOT<x>:BERContour:SUPERImpose,
461
- DPOJET:PLOT<x>:BERContour:TARGETBER,
464
- DPOJET:PLOT<x>:BEREye:BER1E12V, 473
- DPOJET:PLOT<x>:BEREye:BER1E15V, 473
- DPOJET:PLOT<x>:BEREye:BER1E18V, 474
- DPOJET:PLOT<x>:BEREye:BER1E6V, 472
- DPOJET:PLOT<x>:BEREye:BER1E9V, 472
- DPOJET:PLOT<x>:BEREye:TARGETBER, 474
- DPOJET:PLOT<x>:COMPOSITEJitterhist:
DDJDCD, 425
- DPOJET:PLOT<x>:COMPOSITEJitterhist:
NUMBins, 423
- DPOJET:PLOT<x>:COMPOSITEJitterhist:PJ, 425
- DPOJET:PLOT<x>:COMPOSITEJitterhist:RJNPJ,
424
- DPOJET:PLOT<x>:COMPOSITEJitterhist:TJ, 424
- DPOJET:PLOT<x>:COMPOSITEJitterhist:
VERTical:SCALE, 423
- DPOJET:PLOT<x>:COMPOSITENOisehist:
DDNONE, 478
- DPOJET:PLOT<x>:COMPOSITENOisehist:
DDNZERO, 477
- DPOJET:PLOT<x>:COMPOSITENOisehist:
HORizontal:SCALE, 475
- DPOJET:PLOT<x>:COMPOSITENOisehist:
NUMBins, 475
- DPOJET:PLOT<x>:COMPOSITENOisehist:PN,
477
- DPOJET:PLOT<x>:COMPOSITENOisehist:
RNNPN, 476
- DPOJET:PLOT<x>:CORRELATEDEye:
BER1E12V, 467
- DPOJET:PLOT<x>:CORRELATEDEye:
BER1E15V, 467
- DPOJET:PLOT<x>:CORRELATEDEye:
BER1E18V, 468
- DPOJET:PLOT<x>:CORRELATEDEye:
BER1E6V, 465
- DPOJET:PLOT<x>:CORRELATEDEye:
BER1E9V, 466
- DPOJET:PLOT<x>:CORRELATEDEye:
TARGETBER, 468
- DPOJET:PLOT<x>:DATA:XDATa?, 426
- DPOJET:PLOT<x>:DATA:XDATa:DDNONE?,
431
- DPOJET:PLOT<x>:DATA:XDATa:DDNZERO?,
431
- DPOJET:PLOT<x>:DATA:XDATa:PJ?, 428
- DPOJET:PLOT<x>:DATA:XDATa:PN?, 430
- DPOJET:PLOT<x>:DATA:XDATa:RNNPN?, 430
- DPOJET:PLOT<x>:DATA:XDATa:TJ?, 427
- DPOJET:PLOT<x>:DATA:XDATa:TN?, 429
- DPOJET:PLOT<x>:DATA:YDATa?, 432
- DPOJET:PLOT<x>:DATA:YDATa:DDJDCD?,
435
- DPOJET:PLOT<x>:DATA:YDATa:DDNONE?,
437
- DPOJET:PLOT<x>:DATA:YDATa:DDNZERO?,
438
- DPOJET:PLOT<x>:DATA:YDATa:PJ?, 434
- DPOJET:PLOT<x>:DATA:YDATa:PN?, 437

- DPOJET:PLOT<x>:DATA:YDATAa:RNNPN?, 436
DPOJET:PLOT<x>:DATA:YDATAa:TJ?, 433
DPOJET:PLOT<x>:DATA:YDATAa:TN?, 435
DPOJET:PLOT<x>:EYE:ALIGNment, 442
DPOJET:PLOT<x>:EYE:ALLUI, 443
DPOJET:PLOT<x>:EYE:HORizontal:AUTOscale, 443
DPOJET:PLOT<x>:EYE:HORizontal:RESolution, 444
DPOJET:PLOT<x>:EYE:MASKfile, 445
DPOJET:PLOT<x>:EYE:STATE, 445
DPOJET:PLOT<x>:EYE:SUPERImpose, 446
DPOJET:PLOT<x>:HISTOgram:AUTOset, 451
DPOJET:PLOT<x>:HISTOgram:HORizontal:AUTOscale, 451
DPOJET:PLOT<x>:HISTOgram:HORizontal:CENter, 452
DPOJET:PLOT<x>:HISTOgram:HORizontal:SPAN, 450, 452
DPOJET:PLOT<x>:HISTOgram:NUMBins, 453
DPOJET:PLOT<x>:HISTOgram:VERTical:SCALE, 453
DPOJET:PLOT<x>:NOISEBATHtub:YAXISUnits, 508
DPOJET:PLOT<x>:PDFEye:BER1E12V, 470
DPOJET:PLOT<x>:PDFEye:BER1E15V, 470
DPOJET:PLOT<x>:PDFEye:BER1E18V, 471
DPOJET:PLOT<x>:PDFEye:BER1E6V, 469
DPOJET:PLOT<x>:PDFEye:BER1E9V, 469
DPOJET:PLOT<x>:PDFEye:TARGETBER, 471
DPOJET:PLOT<x>:PHASEnoise:BASEline, 454
DPOJET:PLOT<x>:SOUrce?, 440
DPOJET:PLOT<x>:SPECTrum:BASE, 454
DPOJET:PLOT<x>:SPECTrum:HORizontal:SCALE, 455
DPOJET:PLOT<x>:SPECTrum:MODE, 455
DPOJET:PLOT<x>:SPECTrum:VERTical:SCALE, 456
DPOJET:PLOT<x>:TRANSfer:DENominator, 456
DPOJET:PLOT<x>:TRANSfer:HORizontal:SCALE, 457
DPOJET:PLOT<x>:TRANSfer:MODE, 457
DPOJET:PLOT<x>:TRANSfer:NUMerator, 458
DPOJET:PLOT<x>:TRANSfer:VERTical:SCALE, 458
DPOJET:PLOT<x>:TREND:TYPE, 440
DPOJET:PLOT<x>:TYPE?, 441
DPOJET:PLOT<x>:VERTBATHtub:BER, 464
DPOJET:PLOT<x>:VERTBATHtub:HORizontal:SCALE, 465
DPOJET:PLOT<x>:XUnits?, 439
DPOJET:PLOT<x>:YUnits?, 439
DPOJET:PLOTx:DATA:XDATAa:RJBUI?, 427
DPOJET:PLOTx:DATA:YDATAa:RJBUI?, 433
DPOJET:POPULATION:CONDition, 478
DPOJET:POPULATION:LIMIT, 479
DPOJET:POPULATION:LIMITBY, 479
DPOJET:POPULATION:STATE, 480
DPOJET:QUALify:ACTIVE, 480
DPOJET:QUALify:SOUrce, 481
DPOJET:QUALify:STATE, 481
DPOJET:REFLevel:CH<x>:MIDZero, 482
DPOJET:REFLevels:AUTOSet, 482
DPOJET:REFLevels:CH<x>:ABSolute, 484
DPOJET:REFLevels:CH<x>:ABSolute:FALLHigh, 485
DPOJET:REFLevels:CH<x>:ABSolute:FALLLow, 486
DPOJET:REFLevels:CH<x>:ABSolute:FALLMid, 486
DPOJET:REFLevels:CH<x>:ABSolute:HYSteresis, 487
DPOJET:REFLevels:CH<x>:ABSolute:RISEHigh, 484
DPOJET:REFLevels:CH<x>:ABSolute:RISELow, 484
DPOJET:REFLevels:CH<x>:ABSolute:RISEMid, 485
DPOJET:REFLevels:CH<x>:AUTOSet, 483
DPOJET:REFLevels:CH<x>:BASETop, 487
DPOJET:REFLevels:CH<x>:PERcent, 488
DPOJET:REFLevels:CH<x>:PERcent:FALLHigh, 488
DPOJET:REFLevels:CH<x>:PERcent:FALLLow, 488
DPOJET:REFLevels:CH<x>:PERcent:FALLMid, 489

DPOJET:REFLevels:CH<x>:PERcent:
HYSTeresis, 490
DPOJET:REFLevels:CH<x>:PERcent:
PERCENTReflevel, 489
DPOJET:REFLevels:CH<x>:PERcent:RISEHigh,
490
DPOJET:REFLevels:CH<x>:PERcent:RISELow,
491
DPOJET:REFLevels:CH<x>:PERcent:RISEMid,
491
DPOJET:REPORT, 492
DPOJET:REPORT:APPLicationconfig, 492
DPOJET:REPORT:AUTOincrement, 493
DPOJET:REPORT:COMMENTS, 493
DPOJET:REPORT:DETailedresults, 494
DPOJET:REPORT:ENABLecomments, 495
DPOJET:REPORT:PASSFailresults, 496
DPOJET:REPORT:PLOTimages, 497
DPOJET:REPORT:REPORTName, 497
DPOJET:REPORT:SAVEWaveforms, 498
DPOJET:REPORT:SETUpconfig, 498
DPOJET:REPORT:STATE?, 499
DPOJET:REPORT:VIEWreport, 499
DPOJET:RESULts:STATus?, 500
DPOJET:RESULts:Vlew, 500
DPOJET:SAVE, 501
DPOJET:SOURCEAutoset, 503
DPOJET:SOURCEAutoset:HORizontal:UICount,
503
DPOJET:SOURCEAutoset:HORizontal:UIValue,
504
DPOJET:STATE, 505
DPOJET:TDCOMPensation, 505
DPOJET:UNITType, 506
DPOJET:VERsion?, 508
DPOJET:VERTUNITType, 508
GPIB Program, 329
GPIB Reference Materials, 329

H

Halt free-run, 224
Height, 31
Height@BER, 31, 294
High, 33, 299, 315

High Pass filter, 46
High time,
High Time, 30
High-Low, 33, 302
Histogram, 177
Histogram plot parameters, 236
Hold, 31
Horizontal cursors, 204
Horizontal resolution, 126
Hysteresis, 168

I

Image export directory, 147
Installing the Application, 9

J

J2, 28
J9, 28
Jitter analysis, 5
Jitter analysis through RJ-DJ separation, 319
Jitter estimation using Dual-Dirac, 322
Jitter measurements map, 246
Jitter separation model, 146
Jitter summary, 277
Jitter Summary, 27
JTF BW, 62

L

Limit, 45
Limits files, 13
Lock RJ Value, 146
Log notifiers, 15
Logging export directory, 147
Loop BW, 61
Low, 33, 299, 316
Low Pass filter, 46
Low time,
Low Time, 30
Lower Frequency, 93

M

Margin parameters, 236
 Mask files, 13
 Mask Hit Ratio, 37
 Mask hits, 297
 Mask Hits, 32
 Mask Margin, 37
 Max, 170
 Max or Min value, 40
 Max-cc, 170
 Mean, 170
 Measurement Range, 40
 Measurement Select Parameters, 221
 Measurements-Amplitude, 33
 Measurements-Eye, 31
 Measurements-Period/Freq, 26
 Measurements-Time, 30
 Menu Shortcuts
 Alt+A+J, 14
 Min, 170
 Min-cc, 171
 Moving and resizing plots, 202

N

N-Period, 26
 Navigation panel, 20
 Neg Width, 26
 Noise analysis, 5
 Noise bathtub plot parameters, 239
 Noise measurements map, 248
 Nominal clock offset, 68
 Notifier duration, 141
 NPJ, 27
 NPJ measurement, 279

O

One touch jitter, 108
 Opposite as From, 92
 Optical high, 36
 Optical low, 36
 Optical measurements

 average optical power, 36
 extinction ratio, 36
 optical high, 36
 optical low, 36
 optical modulation amplitude, 36
 Oscilloscope model number, 4
 Overshoot, 33, 304

P

p-p, 170
 Path defaults, 147
 Pattern file name, 58
 Pattern Type, 89
 PCIe, 48
 PCIe AC common mode, 311
 PCIe AC Common Mode, 34
 PCIe MAX-MIN Ratio, 34
 PCIe Med-Mx-Jitter, 34, 266
 PCIe SSC FREQ DEV, 34
 PCIe SSC PROFILE, 34
 PCIe T-RF-Mismch, 34, 266
 PCIe T-TX, 34, 267
 PCIe T-Tx-Diff-PP, 34, 267
 PCIe T-Tx-Fall, 34, 267
 PCIe T-Tx-Rise, 34, 267
 PCIe T/nT Ratio, 34, 267
 PCIe Tmin-Pulse, 34, 267
 PCIe UI, 34, 267
 PDF eye plot parameters, 240
 Period, 26
 Phase Noise, 27, 178
 Phase noise plot parameters, 238
 PJ, 27, 278
 PJ(h), 28
 PJ(v), 28
 PJrms, 28, 281
 PkPkClkDJ, 28
 PkPkClkRJ, 28
 PkPkClkTJ, 28
 PLL clock recovery setup, 59
 PLL Custom BW, 63
 PLL model, 61
 PLL standard BW, 61

Plot files, 13
Plot summary views, 202
Plot usage, 179
Plots, 20
Population, 44, 89, 170
Pos Width, 26
Positive and negative CC duty, 275
Positive and negative duty cycle, 274
Positive and negative width, 272
Preferences Parameters, 224
Preferences-General, 141
Preferences-Jitter Decomp, 145
Preferences-Measurement, 142
Print figure, 202
Printing plots, 205
Probes, 8
Product description, 5
Progress indicator, 162

Q

Q-Bathtub, 178
Q-factor, 296
Q-PulseWidth, 178
Qualify
 Horizontal Sample Rate, 42

R

Ramp time, 51
Recalc, 19
recall, 16
Recalling a Default Setup, 17
Recalling a Saved Setup, 16
Ref level menu parameters, 223
Ref Levels Setup, 137
reference levels, 132
Related Documentation, 2
Report export directory, 147
Report files, 13
Reports, 20, 205, 240
Reports format, 207
Requirements and Restrictions, 8
Results, 20, 326

Results as plots, 177
Returning to the Application, 15
Rise slew rate, 288
Rise time, 286
Rise Time, 30
Rising versus falling thresholds, 133
Rj, 276
RJ, 27
RJ-DJ
 Auto, 82
 Manual, 82
RJ-DJ analysis of arbitrary pattern, 84
RJ-DJ analysis of repeating pattern, 83
RJ-DJ analysis parameters, 233
RJ-DJ separation for arbitrary patterns, 320
RJ-DJ separation via spectrum analysis, 320
RJ(h), 28
RJ(v), 28
RN-DN
 Auto, 85
 Manual, 85
RN-DN analysis of arbitrary pattern, 87
RN-DN analysis of repeating pattern, 86
RN-DN analysis parameters, 233
Run, 19

S

Same as From, 92
Save Current Stats..., 171
Saving a Setup, 16
Select, 20
Select measurement, 112
Select sources, 115
Selecting a measurement, 24
Selecting plots, 182
Separation on non-periodic jitter, 321
Sequencing, 162
Setup, 30
Show plots, 20
Sine(x)/x, 143
Single, 19
SJ@Freq, 28
Skew, 31

Source autose, 126
 Spectrum, 177
 Spectrum plot parameters, 237
 Spread spectrum clocking
 configuring, 119
 Spread spectrum clocking (SSC), 105
 SRJ, 28
 SSC, 46
 SSC FREQ DEV,
 SSC FREQ DEV MAX, 291
 SSC FREQ DEV MIN, 291
 SSC modulation, 119
 SSC parameters, 233
 SSCpProfile, 290
 Standard: b/s, 62
 Starting the Application, 11
 Stat pop, 169
 Statistical results, 170
 Statistics log files, 13
 Std Dev, 170
 Steps to deskew probes and channels, 23
 Summary, 173
 Summary-Measurement, 167
 Summary-Misc, 169
 Summary-Ref levels, 168
 Sync cursor, 202

T

T/nT ratio, 301
 T/nT-Ratio, 33
 Tab, 11
 Table of measurements-jitter, 26
 Table of measurements-Noise, 29
 TCdr-Slew-Max, 35
 tCMD-CMD, 292
 Technical Support, 3
 Test point, 37
 Text editor, 15
 TIE, 27, 276
 Time outside level, 292
 Time Trend, 177
 Time trend plot parameters, 237
 Timing analysis, 5

TJ, 27
 TJ@BER, 278
 Tmin-Pulse-Tj, 35
 Toolbar functions in plot, 202
 Transfer, 177
 Transfer function plot parameters, 238
 Tutorial, 211
 two source, 124

U

Undershoot, 33, 304
 Upper Frequency, 93
 USB AC common mode, 315
 USB AC Common Mode, 36
 USB SSC MOD-RATE, 35
 USB SSC PROFILE, 35
 USB SSC-FREQ-DEV, 35
 USB Tmin-Pulse-Dj, 35
 USB UI, 36
 user comments, 206

V

V-Diff-Xovr, 33, 303
 Vertical cursors, 204
 View log file, 149
 Viewing plots, 201
 virtual keypad, 12
 VTx-Diff-PP, 35

W

W1011, 251
 W1051, 251
 W1053, 251
 W1064, 251
 W4008, 253
 W4009, 253
 W4025, 253
 W4026, 253
 W410, 250
 W5005, 254
 Waveform, 178

Waveform files, 212

Waveform interpolation type, 143

Width, 31

Width@BER, 32, 293

Window Length, 89

Worst case logging, 158

Z

Zoom and reset zoom, 202

Zoom in a plot, 203