



**Tektronix
Digital Phosphor Oscilloscopes
Printable Help**





Tektronix
Digital Phosphor Oscilloscopes
Printable Help

Copyright © Tektronix. All rights reserved. Licensed software products are owned by Tektronix or its subsidiaries or suppliers, and are protected by national copyright laws and international treaty provisions. Tektronix products are covered by U.S. and foreign patents, issued and pending. Information in this publication supersedes that in all previously published material. Specifications and price change privileges reserved.

TEKTRONIX and TEK are registered trademarks of Tektronix, Inc.

TekScope, TekConnect, Wave Inspector, and TekLink are registered trademarks of Tektronix, Inc.

FastFrame, OpenChoice, iCapture, MyScope, MultiView Zoom, SignalVu, TekExpress, TriMode, TekSecure, TekProbe, TekVPI, TekVISA, MagniVu, DPX, and PinPoint are trademarks of Tektronix, Inc.

Microsoft, Windows, and Windows XP are registered trademarks of Microsoft Corporation.

MATLAB is a registered trademark of The Mathworks, Inc.

Mathcad is a registered trademark of MathSoft Engineering & Education, Inc.

Online Help

076-0020-xx

September 30, 2016

077-0062-xx is the printable PDF file of the Online Help

Contacting Tektronix

Tektronix, Inc.
14150 SW Karl Braun Drive
P.O. Box 500
Beaverton, OR 97077
USA

For product information, sales, service, and technical support:

- In North America, call 1-800-833-9200.
- Worldwide, visit www.tek.com to find contacts in your area.

Table of Contents

| | |
|--------------------|-------|
| Introduction | xxvii |
|--------------------|-------|

About Tektronix oscilloscopes

| | |
|--|----|
| Product description | 1 |
| Product software | 4 |
| Options and accessories | 4 |
| Recommended accessories | 4 |
| Options | 10 |
| Documentation and technical support | 15 |
| Documentation | 15 |
| Support information | 16 |
| TekScope recovery report utility | 17 |
| Feedback | 18 |
| Analysis and connectivity support | 19 |
| About TekScope | 21 |
| Working with your Tektronix oscilloscope | 22 |
| Windows environment | 22 |
| Oscilloscope interface | 27 |
| Basic operations | 33 |
| Multi-instrument configuration | 46 |
| DPO7AFP Auxiliary Front Panel (optional) | 61 |
| Waveform operations | 62 |

Controls and connectors

| | |
|---|----|
| Front panel controls and connectors | 69 |
| Front panel overview | 69 |
| Touch screen | 73 |
| Wave inspector controls | 74 |
| Vertical controls | 74 |
| Horizontal controls | 75 |
| Trigger controls | 76 |
| Trigger coupling | 78 |
| Run controls | 78 |
| General purpose controls | 79 |
| MultiView zoom controls | 80 |
| Rear and side panel connectors | 81 |

Cursor setups

| | |
|---|----|
| Cursor setup control window (YT display format) | 85 |
| Cursor type control window | 87 |
| Cursor sources (YT display) | 88 |
| Cursor style | 89 |
| Cursor position control window | 90 |
| Horizontal bar cursors | 91 |
| Vertical bar cursors | 92 |
| Waveform cursors | 92 |
| Screen cursors | 93 |
| Cursor track mode | 93 |
| Cursor measurements | 94 |
| Cursor setup control window (XY display format) | 96 |

Digital setups

| | |
|--|-----|
| Digital setup control window | 99 |
| Setting up digital signal inputs | 100 |
| Digital channel threshold and position | 101 |
| Turn on or off the digital channels D15-D8 and D7-D0 | 103 |
| Set the display size of logic channels | 104 |
| Set the global threshold for digital channels | 104 |
| Set up digital channels | 105 |

Bus setups

| | |
|---------------------------------------|-----|
| Bus setup control window (Config tab) | 107 |
| Bus selection list | 109 |
| Bus search selection list | 110 |
| Display or clear a bus | 111 |
| Label a bus | 111 |
| Change the bus position | 113 |
| Set up an I2C serial bus | 113 |
| Set up an SPI serial bus | 115 |
| Set up an RS-232 serial bus | 116 |
| Set up a USB serial bus | 118 |
| Set up a MIPI DSI-1 serial bus | 120 |
| Set up a MIPI CSI-2 serial bus | 121 |
| Set up an 8B10B serial bus | 123 |

| | |
|---|-----|
| Set up a custom serial bus | 124 |
| Set up a PCIe serial bus | 126 |
| Set up a CAN serial bus | 127 |
| Set up a LIN serial bus | 129 |
| Set up a FLEXRAY serial bus | 130 |
| Set up a MIL-1553 serial bus | 132 |
| Set up an ethernet serial bus | 133 |
| Select the number of lanes | 135 |
| Select the serial bus channel type | 135 |
| Select the serial bus channel input | 136 |
| Select the USB serial bus speed | 137 |
| Select the USB bus signal type | 138 |
| Select the data rate | 138 |
| Select the serial bus input | 139 |
| Select the USB bus threshold | 139 |
| Select the serial bus channel threshold | 140 |
| Select the SPI bus channel polarity | 141 |
| Select the RS-232 bus channel polarity | 141 |
| Select the RS-232 bus data bits | 142 |
| Select the RS-232 bus parity | 143 |
| Select the RS-232 bus bit rate | 143 |
| Select the SPI bus framing | 144 |
| Set the SPI bus idle time | 145 |
| Set the SPI bus word size | 145 |
| Select the SPI bus bit order | 146 |
| Set up a parallel bus | 147 |
| Set up a clocked parallel bus | 148 |
| Add sources to a parallel bus | 149 |
| Set up bus channel thresholds | 150 |
| Change the bit order of a channel in a parallel bus | 151 |
| Remove a channel from a parallel bus | 152 |
| Select the bus clock source channel | 152 |
| Select the bus clock channel polarity | 153 |
| Bus setup control window (Display tab) | 154 |
| Select the bus display view | 157 |
| Select the bus decode method | 158 |
| View bus packet | 159 |
| Select the bus symbol table | 159 |
| Symbol file format | 160 |

| | |
|---|-----|
| Opening a bus symbol table file | 162 |
| MagniVu setup | |
| Using MagniVu | 165 |
| Display setups | |
| Display control window (Appearance tab) | 169 |
| Display control window (Screen text tab) | 170 |
| Text properties control window | 171 |
| Display control window (Objects tab) | 172 |
| Display control window (Colors tab) | 173 |
| Display persistence | 174 |
| Select the display format | 175 |
| XY format pairs | 176 |
| Set the waveform intensity | 176 |
| Select the waveform interpolation | 177 |
| Select the graticule style | 178 |
| Define the color palette | 179 |
| Remote operation | 181 |
| Horizontal and acquisition setups | |
| Horizontal-Acquisition control window (Horizontal tab) | 183 |
| Set record length limit | 184 |
| Horizontal digital control window | 185 |
| Horizontal Position-Scale control window | 186 |
| Horizontal Position-Scale control window with delay mode on | 187 |
| Horizontal-Acquisition control window (Acquisition tab) | 188 |
| Autoset | 189 |
| Set autoset preferences | 191 |
| Undo an autoset | 191 |
| Enable enhanced effective number of bits | 192 |
| Enable fast acquisitions | 193 |
| Start and stop waveform acquisitions | 194 |
| Enable roll mode | 195 |
| Select a sampling mode | 196 |
| Set the resolution | 198 |
| Select the acquisition mode | 199 |
| Acquisition interval | 200 |

| | |
|---------------------------------|-----|
| FastFrame control windows | 200 |
| Set up zoom | 202 |

Error detector setups

| | |
|---|-----|
| Use the serial error detector | 205 |
| Set up the serial error detector | 206 |
| Set error detector advanced settings | 208 |
| Specify the error detector test pattern | 209 |
| Set the error detector stop condition | 210 |
| Error detector overview | 210 |

Link Training

| | |
|--|-----|
| Link Training environment | 213 |
| Link training connections | 214 |
| Start Link Training | 215 |
| Typical Link Training display | 216 |
| Results Table | 217 |
| Using Link Training from the programming interface | 217 |

Mask testing setups

| | |
|--|-----|
| Mask setup | 219 |
| Mask testing control window (Masks tab) | 219 |
| Serial mask testing option | 220 |
| Select a mask type | 220 |
| Mask types and standards | 221 |
| Use mask display controls | 222 |
| Mask configuration controls | 223 |
| Set up mask alignment | 226 |
| Edit a mask | 227 |
| Tolerance setup | 228 |
| Set up mask testing source-tolerance | 228 |
| Set up mask margins | 228 |
| Fail setup | 229 |
| Set up pass-fail mask testing | 229 |
| Set up mask test fail notification | 230 |
| Set up mask test completion notification | 231 |
| Set mask test parameters | 232 |
| Select the sound source | 233 |

| | |
|---|-----|
| Set the mask polarity | 234 |
| Set mask test repeat controls | 234 |
| Fail results setup | 235 |
| Mask testing control window (Pass-Fail results tab) | 235 |
| View the mask test summary | 236 |
| View the mask hits per segment | 237 |
| Start or reset a mask test | 238 |
| User mask setup | 238 |
| Set the user mask controls | 238 |
| Set user mask edit controls | 240 |
| Recall user mask | 240 |
| Limit test | 242 |
| Set up limit testing | 242 |
| Save a template | 243 |
| Set up limit test failure notification | 244 |

Math setups

| | |
|--|-----|
| Set up a math waveform | 247 |
| Set up math averaging | 248 |
| Set math variables | 249 |
| Custom analysis functions | 249 |
| Use custom analysis functions | 250 |
| MATLAB custom analysis interface | 250 |
| Basic spectral setups | 251 |
| Set up basic spectral analysis | 251 |
| Use front panel spectral controls | 252 |
| Advanced spectral setups | 252 |
| Set up advanced spectral analysis | 252 |
| Set up the frequency spectral controls | 253 |
| Set up spectral gating controls | 255 |
| Using spectral analysis | 257 |
| Spectral analysis overview | 257 |
| Spectral analysis features | 257 |
| FFT process | 257 |
| The FFT display | 258 |
| FFT windows | 259 |
| FFT window characteristics | 260 |
| Time domain gating | 260 |
| Aliasing | 261 |

| | |
|---|-----|
| Eliminate aliasing | 261 |
| Math equation editor | 262 |
| Math equation editor control window | 262 |
| Math equation editor (Time tab) | 263 |
| Math equation editor (Spectral tab) | 267 |
| Math equation editor (Var tab) | 268 |
| Math equation editor (Meas tab) | 268 |
| Math equation editor (Filter tab) | 269 |

Measurement setups

| | |
|---|-----|
| Measurement snapshot control window | 271 |
| Measurement setup control window (Amplitude tab) | 272 |
| Measurement readouts | 273 |
| Select an amplitude measurement | 274 |
| Measurement setup control window (Time tab) | 277 |
| Select a time measurement | 278 |
| Measurement setup control window (Communications tab) | 280 |
| Select a communications measurement | 282 |
| Measurement setup control window (More tab) | 284 |
| Select a miscellaneous measurement | 286 |
| Counter measurement setup | 287 |
| Set up measurement statistics | 289 |
| Set up reference levels | 290 |
| Set up measurement gating | 292 |
| Set up histogram measurements | 293 |
| Set up histograms | 294 |

Analyzing waveforms

| | |
|--|-----|
| Control marks | 299 |
| Select a search type | 300 |
| Select the search type | 301 |
| Select the search source | 301 |
| Configure a search | 303 |
| Copy search settings | 304 |
| Set advanced DDR search settings | 305 |
| Set search parameters | 306 |
| Check search results | 307 |
| View the search counts results | 308 |

| | |
|---|-----|
| View search marks | 309 |
| Set the search mode | 309 |
| Use search and mark controls | 310 |
| Control user marks in table | 312 |
| Change mark display digits | 312 |
| Export a mark table | 313 |
| View mark counts | 314 |
| Set up a visual search | 314 |
| Set up 8B10B search parameters | 316 |
| Set up RS-232 search parameters | 318 |
| Set up SPI search parameters | 321 |
| Set up I2C search parameters | 323 |
| Set up USB search parameters | 327 |
| Set up MIPI search parameters | 334 |
| Set up PCIe search parameters | 340 |
| Set up CAN search parameters | 342 |
| Set up LIN search parameters | 346 |
| Set up FLEXRAY search parameters | 349 |
| Set up MIL-1553 search parameters | 353 |
| Set up ethernet search parameters | 356 |
| Set up DDR search parameters | 361 |
| Set up custom search parameters | 363 |
| Set up parallel search parameters | 364 |
| View the results table | 365 |
| Copy the results table | 369 |
| Select columns to copy or export | 370 |
| Save the results table | 371 |

MyScope setups

| | |
|---|-----|
| Set up a MyScope control window | 373 |
| Use a MyScope control window | 374 |
| Save a MyScope file as a dialog box | 376 |
| Open or edit a MyScope dialog box | 377 |

Trigger setups

| | |
|---|-----|
| Set up trigger controls (A event tab) | 379 |
| Select the trigger type | 380 |
| Set the trigger mode controls | 382 |

| | |
|---|-----|
| Set up the trigger holdoff | 384 |
| Set to 50 | 385 |
| A event triggers | 385 |
| Set up a parallel bus trigger | 385 |
| Set up an 8B10B bus trigger | 386 |
| Set up an I2C bus trigger | 388 |
| Set up an SPI bus trigger | 390 |
| Set up an RS-232 bus trigger | 391 |
| Set up a USB bus trigger | 393 |
| Set up a PCIe bus trigger | 398 |
| Set up a CAN bus trigger | 400 |
| Set up a CAN bus trigger | 401 |
| Set up a LIN bus trigger | 402 |
| Set up a FLEXRAY bus trigger | 404 |
| Set up a MIL-1553 bus trigger | 407 |
| Set up an ethernet bus trigger | 409 |
| Set up a comm trigger | 414 |
| Set up an edge trigger | 416 |
| Set up a Freq/Period trigger | 417 |
| Set up a glitch trigger | 419 |
| Set up a logic pattern trigger | 422 |
| Set up a logic pattern trigger | 423 |
| Set up a runt trigger | 423 |
| Set up a serial pattern trigger | 425 |
| Set up a setup and hold trigger | 426 |
| Set up an SPI bus trigger | 429 |
| Set up a logic state trigger | 430 |
| Set up a logic state trigger | 431 |
| Set up a timeout trigger | 432 |
| Set up a transition time trigger | 435 |
| Set up a video trigger | 437 |
| Set up a width trigger | 439 |
| Set up a window trigger | 442 |
| Sequence triggering | 443 |
| Set up sequential triggering (Horizontal delay off) | 443 |
| A only trigger | 446 |
| Trigger after time | 450 |
| Trigger after events | 454 |

| | |
|---|-----|
| B event trigger | 461 |
| Set up trigger controls (B event tab) | 461 |
| Visual triggering | 462 |
| Visual trigger | 462 |
| Create a visual trigger area | 464 |
| Control visual triggering | 467 |
| Define an area | 469 |
| Edit expression logic | 471 |
| Set up visual trigger expression | 472 |
| Select a channel | 473 |
| Enable the visual trigger expression editor | 473 |
| Edit the visual trigger expression | 473 |
| Use the expression editor operands | 474 |
| Text edit controls | 474 |
| Save a visual setup | 475 |
| Recall a visual setup | 475 |
| Mode and holdoff | 476 |
| Set up trigger controls (Options tab) | 476 |
| Enable trigger position correction | 478 |

Vertical setups

| | |
|---|-----|
| Set up vertical controls | 481 |
| Set up input channels | 483 |
| Zoom control window | 485 |
| Waveform display control window | 486 |
| Set the Position-Offset | 487 |
| Waveform label control window | 488 |
| Vertical offset control window | 489 |
| Using offset to avoid clipping signals | 490 |
| Termination controls | 490 |
| Coupling controls | 492 |
| Deskew-Attenuation control window | 493 |
| Bandwidth control window | 495 |
| Enhanced bandwidth | 496 |
| Vertical setup control window (Aux tab) | 498 |
| Probe setup control window | 499 |
| Probe setup control window (Setup type) | 501 |
| Probe setup control window (D15-D0 tab) | 503 |
| Probe setup control window (Probe compensation) | 504 |

| | |
|--|-----|
| Probe setup control window (Probe tip selection) | 506 |
| Probe setup control window (Probe deskew) | 507 |
| Probe setup control window (Probe attenuation) | 509 |
| Probe controls window | 511 |
| Probe properties | 512 |
| Probe setup control window (Probe status) | 513 |
| Signal path compensation | 515 |
| Signal path compensation status | 517 |

Copying and printing

| | |
|--|-----|
| Copy setup | 519 |
| Copy setup (Images) | 519 |
| Copy setup (Waveforms) | 520 |
| Copy setup (Measurements) | 522 |
| Copying procedures | 523 |
| Copy waveform data | 523 |
| Copying the screen for use in other applications | 524 |
| Copying measurements for use in other applications | 524 |
| Printing | 525 |
| Page setup dialog box | 525 |
| Print preview dialog box | 525 |
| Print dialog box | 526 |
| Printing the screen to a printer | 526 |

File menu

| | |
|---------------------------------------|-----|
| Reference waveform setups | 529 |
| Reference waveform controls | 529 |
| Save as dialog box (Waveform) | 530 |
| Recall dialog box (Waveform) | 531 |
| Delete setups and reference waveforms | 532 |
| Instrument setups | 533 |
| Save as dialog box (Instrument setup) | 533 |
| Recall dialog box (Instrument setups) | 534 |
| Delete setups and reference waveforms | 535 |
| Action on event | 536 |
| Set up action on event | 536 |
| Set up save on event | 537 |

| | |
|---|-----|
| Print setups | 538 |
| Print setups | 538 |
| Saving | 538 |
| Save as dialog box (Histogram) | 538 |
| Save as dialog box (Instrument setup) | 539 |
| Save as dialog box (Measurement) | 540 |
| Save as dialog box (Screen capture) | 541 |
| Save as dialog box (User mask) | 544 |
| Save as dialog box (Waveform) | 545 |
| Auto-increment the file name | 546 |
| Save as dialog box (Digitals) | 546 |
| Save as dialog box (Timestamp) | 547 |

Utilities

| | |
|---|-----|
| Tek secure erase | 549 |
| Set time and date | 550 |
| GPIB configuration control window | 551 |
| LAN server status control window | 552 |
| External signals control window | 552 |
| Touch screen | 554 |
| Instrument calibration control window | 554 |
| Instrument diagnostics control window | 556 |
| E-mail on event control window | 557 |
| Measurement save options | 558 |
| Multipurpose knobs | 560 |
| User preferences control window | 561 |
| User preferences (Prompt before action) | 561 |
| User preferences (Keypad defaults) | 561 |
| User preferences (Readouts) | 562 |
| User preferences (Measurement annotation) | 563 |
| User preferences (Units) | 564 |
| User preferences (Front panel buttons) | 564 |
| Option installation | 565 |
| Install an option | 565 |
| Install the floating license | 568 |
| Install the fixed license | 570 |
| Return the floating license for the installed option(s) | 572 |

How to ?

| | |
|---|-----|
| Calibrating and using probes | 577 |
| Compensate the signal path | 577 |
| Compensate active probes | 577 |
| Compensate passive probes | 578 |
| Low frequency compensate a probe | 578 |
| Deskew | 578 |
| Acquiring analog signals | 579 |
| Setting up analog channels | 579 |
| Setting acquisition modes | 580 |
| Use fast acquisitions | 580 |
| View the analog characteristics of a digital signal | 581 |
| Acquiring digital signals | 582 |
| Set up digital channels | 582 |
| Displaying waveforms as a bus | 583 |
| Set up a bus | 583 |
| Set up a parallel bus | 583 |
| Set up an SPI serial bus | 584 |
| Set up an I2C serial bus | 584 |
| Set up an RS-232 serial bus | 584 |
| Set up a USB serial bus | 584 |
| Set up a MIPI DSI-1 serial bus | 585 |
| Set up a MIPI CSI-2 serial bus | 585 |
| Set up an 8B10B serial bus | 585 |
| Set up a custom serial bus | 586 |
| Set up a PCIe serial bus | 586 |
| Set up a CAN serial bus | 586 |
| Set up a LIN serial bus | 586 |
| Set up a FLEXRAY serial bus | 587 |
| Set up a MIL-1553 serial bus | 587 |
| Set up an ethernet serial bus | 587 |
| Configuring the bus display | 587 |
| Analyzing buses | 588 |
| Tracking down I2C serial bus anomalies | 588 |
| Troubleshooting circuits using a parallel bus | 589 |
| Troubleshooting an SPI serial bus | 592 |
| Creating and using MyScope control windows | 594 |
| Creating MyScope control windows | 594 |

| | |
|---|-----|
| Editing MyScope control windows | 594 |
| Taking measurements | 595 |
| Select cursor sources | 595 |
| Taking cursor measurements | 597 |
| Taking automatic measurements | 597 |
| Take automatic measurements | 598 |
| Localize a measurement | 599 |
| Save measurements | 599 |
| Creating and using math waveforms | 600 |
| Using math waveforms | 600 |
| Create a math waveform using predefined expressions | 603 |
| Create a math waveform with the equation editor | 604 |
| Create a math waveform | 604 |
| Using mask and limit testing | 605 |
| Set up mask testing | 605 |
| Create a new user mask | 607 |
| Create a user mask from a defined mask | 608 |
| Edit a user defined mask | 609 |
| Save a user mask to disk | 610 |
| Recall a user mask from disk | 610 |
| Create a user mask with mask testing | 610 |
| Use mask testing | 610 |
| Using e-mail on event | 611 |
| Send an e-mail on events | 611 |
| Creating spectral waveforms | 612 |
| Create a spectral waveform | 612 |
| Define a spectral math waveform | 613 |
| Use a predefined spectral math waveform | 616 |
| Using reference waveforms | 617 |
| Create a reference waveform | 617 |
| Save reference waveforms using Auto-Increment file name | 617 |
| Recall a reference waveform | 618 |
| Using waveforms | 618 |
| Save a waveform | 618 |
| Copy waveform data | 619 |
| Save a screen capture | 620 |
| Using horizontal delay | 621 |
| Set the horizontal delay | 621 |
| Compare data using horizontal delay | 621 |

| | |
|---|-----|
| Using roll mode | 621 |
| Set up roll mode | 621 |
| Using roll mode | 622 |
| Triggering | 622 |
| Checking trigger status | 622 |
| Set up triggering from the front panel | 623 |
| Set up triggering from the trigger setup window | 624 |
| Trigger on a sequence | 625 |
| Trigger on A event only | 626 |
| Trigger on an event after a specified delay | 626 |
| Trigger on a B event | 626 |
| Trigger on a glitch | 627 |
| Trigger on a runt pulse | 627 |
| Trigger on a pulse width | 628 |
| Trigger on a pulse timeout | 629 |
| Trigger on a pattern | 630 |
| Pattern triggers | 631 |
| Trigger on a logic state | 632 |
| Trigger on the transition time | 633 |
| Trigger on setup-hold time violations | 634 |
| Trigger on window threshold violations | 636 |
| Trigger on a video signal | 637 |
| Trigger on a communication signal | 637 |
| Trigger on a bus | 638 |
| Mark all trigger events | 638 |
| Using histograms | 641 |
| Set up a histogram | 641 |
| Take automated measurements on histogram data | 641 |
| Start or reset histogram counting | 641 |
| Using display modes | 642 |
| Display a waveform | 642 |
| Set up XY display format | 643 |
| Use MultiView zoom with waveforms | 643 |
| Choosing a color palette | 644 |
| Choose a color palette | 644 |
| Customize the display palette | 644 |
| Saving and restoring instrument setups | 645 |
| Save the instrument setups | 645 |
| Recall an instrument setup | 646 |

| | |
|--|-----|
| Delete instrument setups | 646 |
| Using the programmer online guide | 647 |
| Programmer online help | 647 |
| Using application software | 647 |
| Oscilloscope applications software | 647 |
| Add a software application to the instrument | 647 |
| Setting up a dual display | 647 |
| Set up a dual display | 647 |
| Connecting to a network | 649 |
| Enable a network connection | 649 |
| Exiting or minimizing the oscilloscope application | 649 |
| Exit the instrument application | 649 |
| Minimize the instrument application | 649 |
| Shut down the instrument | 649 |
| Adjusting display contrast | 650 |
| Adjust the display contrast | 650 |

Oscilloscope reference

| | |
|---|-----|
| Functional model | 651 |
| Process overview | 652 |
| Waveform acquisition | 653 |
| Signal connection | 653 |
| Probes and signal connection | 653 |
| Input conditioning | 654 |
| Bandwidth enhancement | 654 |
| Coupling | 655 |
| Scaling and positioning | 655 |
| Vertical acquisition window considerations | 656 |
| Horizontal acquisition window considerations | 657 |
| Horizontal acquisition window interrelated parameters | 658 |
| Independent versus shared window | 659 |
| Incompatible acquisition features | 659 |
| Autoset considerations | 660 |
| Acquisition hardware | 660 |
| Sampling process | 661 |
| Sampling modes | 662 |
| Waveform record | 662 |
| Interleaving | 663 |
| Interpolation | 663 |

| | |
|--|-----|
| Trigger function | 664 |
| Triggering concepts | 664 |
| Trigger sources | 665 |
| Trigger types | 665 |
| Trigger modes | 667 |
| Trigger holdoff | 667 |
| Trigger coupling | 668 |
| Trigger slope and level | 668 |
| Horizontal trigger position | 668 |
| Delayed trigger system | 668 |
| Advanced triggering | 669 |
| Bus trigger | 669 |
| Communication trigger | 669 |
| Communication triggering | 670 |
| Glitch trigger | 670 |
| Pattern trigger | 670 |
| Runt trigger | 671 |
| Setup and hold trigger | 671 |
| State trigger | 673 |
| Timeout trigger | 674 |
| Transition time trigger | 674 |
| Video trigger | 674 |
| Width trigger | 674 |
| Window trigger | 674 |
| Sequential triggering | 674 |
| Triggering with horizontal delay off | 675 |
| Triggering with horizontal delay on | 676 |
| Triggering and horizontal delay summary | 677 |
| Waveform display | 678 |
| Display overview | 678 |
| Display elements | 678 |
| Customizable display elements | 680 |
| Acquisition preview | 683 |
| Waveform display | 683 |
| Operations on the time base | 683 |
| Horizontal position and the horizontal reference point | 683 |
| Using the MultiZoom feature | 684 |
| Waveform measurement | 684 |
| Automatic measurements | 684 |

| | |
|---|-----|
| Measurement variables | 686 |
| Measurement algorithms | 689 |
| Measurements on envelope waveforms | 697 |
| Missing or out-of-range samples | 698 |
| Measurement warnings | 698 |
| Measurement errors | 699 |
| Cursor types | 699 |
| Histograms | 700 |
| Typical math waveforms | 701 |
| Math waveforms | 702 |
| Math waveform differentiation | 703 |
| Math waveform sources | 704 |
| Math waveform expression syntax | 705 |
| Math waveform offset, position, and scale | 706 |
| Waveform integration | 706 |
| Math plugins | 707 |
| Using math plugins | 707 |
| Writing math plugins | 707 |
| MATLAB custom functions | 713 |
| Spectral math waveforms | 715 |
| Spectral math controls | 715 |
| Spectral math time controls | 716 |
| Spectral math gating controls | 718 |
| Spectral math frequency domain controls | 719 |
| Spectral math magnitude controls | 721 |
| Spectral math phase controls | 723 |
| Spectral analyzer window types | 727 |
| FlatTop2 window | 730 |
| Gaussian window | 731 |
| Hamming window | 732 |
| Hanning Kaiser-Bessel and Blackman-Harris windows | 732 |
| Rectangular window | 734 |
| Tek-Exponential window | 734 |
| Recognizing aliasing | 735 |
| Mask testing | 736 |
| Mask key points | 736 |
| Serial mask testing with mask testing | 737 |
| Levels used in taking eye measurements | 738 |

| | |
|---|-----|
| Output | 739 |
| Saving and recalling setups | 739 |
| Saving and recalling waveforms | 740 |
| Saving and copying waveform data | 740 |
| Miscellaneous | 741 |
| ACos | 741 |
| Acquisition interval | 741 |
| Acquisition window | 741 |
| Active probes | 742 |
| Amplitude | 742 |
| Analog oscilloscope sweeps | 742 |
| Area | 742 |
| ASin | 742 |
| ATan | 742 |
| Auto trigger mode | 742 |
| B-Event scan setup | 742 |
| CAN bit rate | 743 |
| CAN format | 743 |
| CAN signal type | 743 |
| Center frequency | 743 |
| Channels selector | 744 |
| Clear button | 744 |
| Clear data control | 744 |
| Clock edge | 744 |
| Level | 744 |
| Communication trigger codes and standards | 744 |
| Set up communication trigger coding | 745 |
| Select the comm trigger pulse form | 746 |
| Set the comm trigger source | 747 |
| Control window handle | 747 |
| Cos | 747 |
| Cosh | 747 |
| Crossing percent | 747 |
| Set the cursor sources (XY display) | 747 |
| Customize color palettes | 748 |
| Cycle area | 748 |
| Cycle mean | 749 |
| Cycle RMS | 749 |
| Data direction | 749 |

| | |
|---|-----|
| Data threshold | 749 |
| Dead time between acquisitions | 749 |
| Delay edges | 749 |
| Delay | 749 |
| Trigger delay | 749 |
| Trigger events | 749 |
| Select digital input iCapture | 750 |
| Set up trigger path alignment | 750 |
| Set logic properties | 751 |
| Set the logic thresholds | 751 |
| Select the display style | 752 |
| Select the math color | 753 |
| Select the reference color | 754 |
| Select the trigger level marker | 754 |
| Duty cycle distortion | 755 |
| Edit a user mask | 755 |
| Editor button | 755 |
| Enter math equation editor (Operands) | 755 |
| Set up e-mail on trigger | 756 |
| Extinction ratio | 756 |
| Extinction ratio decibel | 756 |
| Eye base | 756 |
| Eye diagram | 756 |
| Eye height | 756 |
| Eye top | 757 |
| Eye width | 757 |
| Set up e-mail configuration | 757 |
| Send an e-mail on trigger | 759 |
| Fall time | 759 |
| FastFrame acquisitions | 759 |
| Force a trigger | 760 |
| Frequency | 760 |
| Frequency span | 760 |
| Getting the analysis and connectivity support tools | 760 |
| Ground terminal | 760 |
| Guidelines for working with math waveforms | 760 |
| High | 761 |
| High impedance probes | 761 |
| High reference | 761 |

| | |
|---|-----|
| Histogram box limits - horizontal | 761 |
| Histogram box limits - vertical | 762 |
| Histogram box location - horizontal | 763 |
| Histogram box location - vertical | 763 |
| Histogram max | 764 |
| Histogram mean | 764 |
| Histogram min | 764 |
| Hits in box | 764 |
| Maximum | 764 |
| Mean plus or minus 1 StdDev | 764 |
| Mean plus or minus 2 StdDev | 764 |
| Mean plus or minus 3 StdDev | 765 |
| Minimum | 765 |
| Peak hits | 765 |
| Pk-Pk | 765 |
| StdDev (standard deviation) | 765 |
| Waveform count | 765 |
| Median | 765 |
| Set the horizontal delay | 765 |
| Set the horizontal position | 765 |
| Horizontal Position-Scale control window (Delay mode) | 766 |
| Set the horizontal position | 766 |
| Set the horizontal scale | 766 |
| Horizontal reference marker | 767 |
| Horizontal delay mode | 767 |
| Set the horizontal delay | 767 |
| Set the horizontal scale when delay is on | 768 |
| Acquisition mode | 768 |
| Set horizontal delay and horizontal position | 772 |
| Horizontal control window readouts | 773 |
| Horizontal controls | 773 |
| I2C addressing mode | 775 |
| Installing software | 775 |
| Interactions of roll mode and other instrument settings | 775 |
| IVI drivers | 775 |
| Jitter 6 sigma | 776 |
| Jitter peak-to-peak | 776 |
| Jitter root mean square | 776 |
| Lock mask | 776 |

| | |
|--|-----|
| Logic pattern | 776 |
| Logic pattern inputs | 776 |
| Logic pattern trigger criteria | 776 |
| Logic pattern and state pattern editor (bus tab) | 777 |
| Logic pattern and state pattern editor (digital tab) | 778 |
| Logic clock inputs | 778 |
| Logic pattern format | 779 |
| Logic pattern setup | 779 |
| Logic state inputs | 779 |
| Logic state trigger criteria | 780 |
| Low | 780 |
| Low impedance probes | 780 |
| Low reference | 780 |
| Enable mask autosegment autofit | 780 |
| Mask autosegment horizontal controls | 781 |
| Select the mask autosegment mode | 781 |
| Control the mask autosegment trigger level | 782 |
| Set mask autosegment vertical controls | 782 |
| Mask hit count | 783 |
| Math arbitrary filters | 783 |
| Enter a math expression | 791 |
| Display a math equation | 791 |
| Set the math display and vertical controls | 792 |
| Maximum | 792 |
| Mean | 792 |
| Set up a histogram measurement | 792 |
| Set up the measurement list | 795 |
| Minimum | 796 |
| Natural antilog | 796 |
| Negative duty cycle | 796 |
| Negative overshoot | 796 |
| Negative width measurement | 796 |
| Noise peak-to-peak | 796 |
| Noise root mean square | 796 |
| Normal trigger mode | 796 |
| Nyquist frequency | 797 |
| Set up zoom AutoScroll | 797 |
| Set the cursor position (XY display) | 797 |
| Set display persistence | 798 |

| | |
|--|-----|
| Set the FastFrame analyze tab controls | 799 |
| Set up FastFrame setup tab controls | 800 |
| Set up FastFrame view tab controls | 801 |
| Select waveform save options | 802 |
| CSV text format | 804 |
| Set mask test controls | 805 |
| Set up a delay measurement | 806 |
| Set up a phase measurement | 807 |
| MyScope controls | 809 |
| Select timestamp save options | 809 |
| Select the graticule size | 810 |
| Select the termination-coupling | 810 |
| Offset and clipping | 811 |
| The On-Screen MultiView zoom menu | 812 |
| Peak to peak | 812 |
| Period | 812 |
| Select trigger polarity | 812 |
| Positive duty cycle | 812 |
| Positive overshoot | 813 |
| Positive width | 813 |
| Predefined functions | 813 |
| Probe calibration output | 813 |
| Probe calibration restrictions | 813 |
| Probe compensation | 814 |
| Probe compensation adjustment | 814 |
| Probe compensation output | 814 |
| Quality factor | 814 |
| Recall a template waveform | 814 |
| Recall a mask | 815 |
| Horizontal modes | 815 |
| Reference point | 817 |
| Resolution bandwidth | 817 |
| Rise time | 817 |
| RMS | 817 |
| Set the RS-232 baud rate | 817 |
| Select the RS-232 data parity | 818 |
| Set the upper and lower threshold values | 818 |
| Runt trigger criteria | 818 |
| Save a mask | 818 |

| | |
|--|-----|
| Scallop loss | 818 |
| Selecting a spectral window | 819 |
| Selected waveform versus deselected waveform | 820 |
| Sequence triggering (horizontal delay on) | 821 |
| Change the serial bit rate | 822 |
| Select the serial clock source | 822 |
| Select the serial coding standard | 822 |
| Select the serial data format | 823 |
| Select the serial data source | 823 |
| Select the serial data standard | 823 |
| Serial mask testing option | 823 |
| Define the serial pattern data | 823 |
| Define the serial trigger on pattern | 824 |
| Set up FastFrame operation | 825 |
| Set to 50 with comm triggers | 825 |
| Clock source channel | 825 |
| Set the clock threshold level | 825 |
| Select the data source channel | 826 |
| Set the data threshold level | 826 |
| Set the setup and hold times | 826 |
| Enter a spectral math equation | 826 |
| Enter a spectral math expression | 826 |
| Spectral tracking | 828 |
| Set up the spectral vertical axis | 828 |
| Set the spectral vertical controls | 830 |
| SPI bus trigger polarity | 831 |
| SPI bus trigger threshold | 831 |
| SPI data source | 831 |
| Supported ADEs | 831 |
| TekProbe-TekVPI interfaces | 831 |
| Set the timeout trigger criteria | 831 |
| Set the Time-Out value | 832 |
| Set the upper and lower threshold levels for transition time | 832 |
| Set the transition time trigger criteria | 832 |
| Trigger coupling | 832 |
| Set the glitch width criteria | 832 |
| Trigger graticule | 832 |
| Trigger holdoff (Auto) | 832 |
| Trigger holdoff (Random) | 833 |

| | |
|--|-----|
| Trigger holdoff (Time) | 833 |
| Set the trigger level | 833 |
| Select the trigger on options | 833 |
| Select the bus trigger on data | 833 |
| Select the glitch trigger polarity | 833 |
| Set the trigger qualification | 834 |
| Set the trigger occurs and qualification | 834 |
| HF filtering | 835 |
| Envelope triggering | 835 |
| Set the trigger reset conditions | 836 |
| Trigger settings (Shared - independent) | 836 |
| Trigger source | 836 |
| Trigger summary | 837 |
| Window event trigger | 837 |
| Set the trigger width limits | 837 |
| Set the trigger polarity | 837 |
| Using FastFrame acquisitions | 838 |
| Use print screen | 838 |
| Analyze menu | 838 |
| Cursors menu | 838 |
| Digital menu | 839 |
| Display menu | 839 |
| Edit menu | 839 |
| File menu | 839 |
| Horizontal-Acquisition menu | 839 |
| Mask menu | 839 |
| Math menu | 839 |
| MyScope menu | 839 |
| Measurement menu | 840 |
| Trigger menu | 840 |
| Utilities menu | 840 |
| Vertical menu | 840 |
| Set the vertical position | 840 |
| Set the vertical scale | 841 |
| Select the bandwidth | 842 |
| Bus pattern condition | 843 |
| Bus selection | 843 |
| Bus time condition | 843 |
| Trigger logic state condition | 843 |

| | |
|--|-----|
| Set the parallel bus pattern | 843 |
| Bus pattern editor (Bus tab) | 844 |
| Bus pattern editor (Bus tab) | 845 |
| Bus pattern editor (Logic tab on MSO series) | 848 |
| Bus pattern editor (Live tab) | 849 |
| Bus pattern format | 850 |
| Bus trigger on selections | 851 |
| Set logic thresholds | 851 |
| Select the coupling | 855 |
| Set display characteristics | 855 |
| Set the offset | 856 |
| Set the vertical position-scale | 857 |
| Select the probe controls | 859 |
| Select the termination | 860 |
| Set the termination voltage | 861 |
| Video trigger autoselect | 862 |
| Select the video trigger format | 862 |
| Specify the video trigger holdoff | 862 |
| Select the video trigger polarity | 862 |
| Working with your oscilloscope | 863 |
| Set the window trigger levels | 863 |

Introduction

This Tektronix oscilloscope provides the performance, simplicity, and connectivity needed for the ever-changing electronics, computer, and communications industries. The easy-to-use interface includes a large display and a touch-screen interface on a Microsoft Windows platform.

Choose the methods of controlling oscilloscope operations that are most convenient for you:

- Customary front-panel controls
- Menus and toolbar buttons
- Touch screen

What do you want to do next?

[Product description](#) on page 1

[Online help](#) on page 32

[Working with your oscilloscope](#) on page 863

About Tektronix oscilloscopes

Product description

This online help supports the following series of Tektronix Digital Phosphor oscilloscopes:

- DPO7000SX Series
- MSO7000DX and DPO7000DX Series
- MSO7000C and DPO7000C Series
- DPO7000C Series
- MSO5000B and DPO5000B Series

NOTE. The features and options that are documented in this online help are available for several instrument models. Your instrument may not have every feature discussed.

Key features

Tektronix oscilloscopes are high-performance solutions for verification, debugging, and characterization of sophisticated electronic designs. These oscilloscopes feature exceptional signal acquisition performance, operational simplicity, and open connectivity to the design environment. Classic analog-style controls, a large display with an optional touch-sensitive screen, and graphical menus provide intuitive control. Open access to the Windows operating system enables unprecedented customization and extensibility.

Key features include:

- Bandwidth:
 - DPO77002SX 70 GHz bandwidth and 200 GS/s on 1 analog channel or 33 GHz bandwidth and 100 GS/s on 2 analog channels
 - DPO75902SX 59 GHz bandwidth and 200 GS/s on 1 analog channel or 33 GHz bandwidth and 100 GS/s on 2 analog channels
 - DPO75002SX 50 GHz bandwidth and 200 GS/s on 1 analog channel or 33 GHz bandwidth and 100 GS/s on 2 analog channels
 - DPO73304SX 33 GHz bandwidth and 100 GS/s on 2 analog channels or 33 GHz bandwidth and 50 GS/s on 4 analog channels
 - DPO2304SX 23 GHz bandwidth and 100 GS/s on 2 analog channel or 23 GHz bandwidth and 50 GS/s on 4 analog channels
 - MSO73304DX, DPO73304DX, MSO72504DX, DPO72504DX, MSO72304DX, and DPO72304DX: 33, 25, and 23 GHz models with up to 100 GS/s real-time sampling rate on two channels, and 50 GS/s on four channels
 - DPO71254C, MSO71254C, DPO71604C, MSO71604C, DPO72004C, and MSO72004C: 12.5, 16, and 20 GHz models with up to 100 GS/s real-time sampling rate on two channels, and 50 GS/s on four channels
 - DPO70404C, MSO70404C, DPO70604C, MSO70604C, DPO70804C, and MSO70804C: 4, 6, and 8 GHz models with up to 25 GS/s real-time sampling rate on four channels

- DPO7054C, DPO7104C, DPO7254C, and DPO7354C: 500 MHz, 1 GHz, 2.5 GHz, 3.5 GHz models with up to 20 GS/s real-time sampling rate on two channels
- DPO5034B, MSO5034B, DPO5054B, MSO5054B, DPO5104B, MSO5104B, DPO5204B, and MSO5204B: 350 MHz, 500 MHz, 1 GHz, and 2 GHz models with up to 10 GS/s real-time sampling rate on two channels
- Record length: up to 1,000,000,000 samples on 2 channels and 500,000,000 samples on 4 channels, depending on the model and options
- Fast acquisition up to >300,000 acquisitions per second, depending on the model of instrument
- [Bandwidth enhancement](#) controls available for some models
- Up to 1% DC vertical gain accuracy
- Up to four input channels (each with 8-bit resolution)
- Auxiliary trigger input and output
- Sample, envelope, peak-detect, high-resolution, average, fast acquisition, and waveform database acquisition modes
- Full programmability, with an extensive command set and a message-based interface
- Extensive suite of advanced triggers
- Powerful built-in measurement capability, including histograms, automatic measurements, eye pattern, and measurement statistics
- Basic math as well as advanced equation editor and spectral analysis
- Customizable [MyScope control window](#)
- An intuitive graphical user interface (GUI) with online help
- Internal disk storage
- Wide array of probing solutions, options, and upgrades
- GPIB Controller available on some models
- Comprehensive suite of right-click menus
- Parallel bus decoding, triggering and analysis
- Serial bus decoding, triggering and analysis are optionally available

MSO70000C/DX Series Mixed Signal Oscilloscopes also offer:

- 16 digital channels plus 1 clock/qualifier channel
- High resolution timing as precise as 80 ps
- An analog view of any digital channel through the iCapture feature
- Enhanced Logic Pattern and Logic State triggering includes digital channels
- Differential (P6780) and single-ended (P6717A) logic probes
- Easy connection to your device-under-test through the convenient design of the P6780 and the P6717 Logic probes
- iCapture allows analyzing the analog characteristics of the digital channels

MSO5000B Series instruments offer:

- MagniVu 60.6 ps resolution

Signal processing features

- **Waveform math.** [Set up math waveforms](#) using the basic arithmetic functions, including FFT, or create more advanced math waveforms using the math expression editor. Waveform expressions can contain measurement results and other math waveforms.
- **Spectral analysis.** Display spectral magnitude and phase waveforms based on your time-domain acquisitions. Control the instrument using the traditional [Spectrum analyzer controls](#), such as span, center frequency, and resolution bandwidth.
- **Mask testing.** Use [Mask Testing](#) for signal violation detection and pass/fail testing. Test signals against a user defined mask, or, on some models, with the [Mask Testing Option](#), you can test against industry standard masks.

Display features

- **Color LCD display.** [Identify and differentiate waveforms](#) easily with color coding. Waveforms, readouts, and inputs are color matched to increase productivity and reduce operating errors.
- **Digital phosphor.** The Digital Phosphor Oscilloscope can provide visual clues as to the relative rate of occurrence of waveform features or anomalies by combining many separate acquisitions of a waveform into a single intensity-graded or color-graded display.
- **Fit to screen.** The Digital Phosphor technology performs the compression required to represent all record points on the screen, even at the maximum record length settings.
- **MultiView Zoom.** To take advantage of the full resolution of the instrument, you can [zoom in on a waveform](#) to see fine details. Both vertical and horizontal zoom are available. You can also zoom in on multiple areas of a single waveform simultaneously and on multiple waveforms at the same time.

Measurement features

- **Cursors.** Use [Cursors](#) to take simple voltage, time, and frequency measurements.
- **Automatic measurements.** Choose from a large palette of amplitude, time, histogram, and communication measurements. You can [customize the measurements](#) by changing reference levels or by adding measurement gating. Statistics (mean, maximum, minimum, standard deviation and population) are available for each measurement value.

Trigger features

- **Simple and advanced trigger types.** Choose a simple edge trigger or [advanced trigger types](#) to help you capture a specific signal fault or event.
- **Dual triggers.** Use the A (main) trigger system alone or add the B trigger to capture more complex events. You can use the [A and B triggers together](#) to set up a delay-by-time or delay-by-events trigger condition.

Convenience features

- **Autoset.** Use [Autoset](#) to quickly set up the vertical, horizontal, and trigger controls for a usable display.
- **MyScope.** Use [MyScope](#) to create your own control windows for easy access to the controls you use most often.
- **Touch screen interface.** You can operate all instrument functions (except the power switch) from the [touch screen interface](#). You can also install a mouse and keyboard.
- **Toolbar or menu bar.** You can choose a [toolbar operating mode](#) that is optimized for use with the touch screen, or a PC-style [menu-bar operating mode](#) that is optimized for use with a mouse.
- **Open desktop.** The instrument is built on a Microsoft Windows software platform; the instrument application program starts automatically when you apply power to the instrument. You can minimize the instrument application and take full advantage of the built-in PC to run other applications. Moving waveform images and data into other applications is as simple as a copy/paste operation.
- **Dedicated front panel controls.** The front panel (SX models require the DPO7AFP accessory) contains [knobs and buttons](#) to provide immediate access to the most common instrument controls. Separate [vertical controls](#) are provided for each channel. The same functions are also available through the screen interface.

- **Data storage and I/O.** The instrument has a removable hard disk drive and a DVD/CD-RW drive (not available on SX instruments) that can be used for storage and retrieval of data. The instrument has I/O ports, extended desktop support, and Ethernet ports for input and output to other devices.
- **Online help.** The instrument has a [complete online help system](#) that covers all its features. The help system is context sensitive; help for the displayed control window is automatically shown if you click the help button. Graphical aids in the help windows assist you in getting to the information you need. You can also access the help topics through a table of contents, index, or full text search.

Product software

The instrument includes the following software:

- **System Software.** The product software runs on a specially configured version of Microsoft Windows which is pre-installed and enables you to install other compatible applications. Do not attempt to substitute any version of Windows that is not specifically provided by Tektronix for use with your instrument.
- **Product Software.** This pre-installed software is the instrument application and runs on Microsoft Windows. It provides the graphical user interface (GUI) and all other instrument control functions. You can minimize or even exit/restart the instrument application as your needs dictate. However, it is recommended that you exit the instrument application only when installing new software.
- **Support Software.** The instrument, contains additional software and files that may be useful to you.
- **Readme file.** This text file contains release notes and updates that are not included in other product documentation.
- **Programmer Online Help.** Available as online help or a PDF file. It contains the information you need to program the instrument.
- **Specifications Performance Verification Procedures.** The product hard drive contains instrument specifications and instructions to perform a manual performance verification.

NOTE. *New versions of software for your instrument are available at our Web site. To find application software releases that may not be on your instrument or to find the latest versions of instrument software and application software that is on your instrument, visit www.tektronix.com/support. Order the latest versions of DPO77002SX instrument software from Tektronix.*

Firmware upgrade

Tektronix may offer firmware upgrade kits for this instrument. Contact your local Tektronix distributor or sales office for more information.

Options and accessories

Recommended accessories

The following accessories are recommended for your instrument.

MSO5000B and DPO5000B:

- GPIB-to-USB adapter, order TEK-USB-488
- TekVPI-to-TekProbe BNC adapter, order TPA-BNC
- Hard transit case, HCTEK54
- Rackmount kit, order RMD5000
- Deskew pulse generator, 067-1686-XX

- Mini keyboard, 119-7275-XX
- Service manual as a PDF, 077-0076-XX
- Programmer manual as a PDF, 077-0010-XX
- Specifications and Performance Verification manual as a PDF, 077-0063-XX

DPO7000C

- Oscilloscope cart, order K420
- Power deskew fixture, order 067-1478-XX
- Mini keyboard (USB), order 119-7275-XX
- Rackmount kit, order 016-1965-XX
- Service manual as a PDF file, 077-0076-XX

MSO/DPO7000DX, DPO7000C, and MSO7000C:

- Deskew fixture, order 067-1586-XX
- Oscilloscope cart, K4000 with brackets: order 407-5187-XX and 407-5188-XX
- Rack mount, order 016-1981-XX
- Transit case, order 016-1977-XX
- Service manual as a PDF file, 077-0076-XX

DPO7000SX

- DPO7AFP Auxiliary Front panel.
- 016-2095-xx Rackmount Kit
- 016-2102-xx SSD mounting kit (front of instrument rackmount tray)
- 016-2104-00 Transit Case (carbon fiber)
- K4000 Oscilloscope Cart
- DPO7USYNC 1M 1 meter UltraSync cable
- DPO7USYNC 2M 2 meter UltraSync cable
- 067-2431-xx Probe Deskew Fixture for SMA or solder-down connections (up to 30 GHz)
- 067-0484-xx Analog Probe Calibration and Deskew Fixture (4 GHz)
- 067-1586-xx Analog Probe Deskew Fixture (>4 GHz)
- 067-1686-xx Power Deskew Fixture

The following probes and components are recommended for your instrument:

MSO5000B and DPO5000B:

- TekProbe

| TekProbe component | Description |
|--------------------|--|
| ADA400A | 100X, 10X, 1X, and 0.1X, high gain differential amplifier |
| P5100A | 2.5 kV, 100X, 250 MHz high voltage passive probe |
| P6015A | 40 kVpk, 1000X, 75 MHz high voltage single-ended passive probe |
| TCPA300, TCPA400 | Current measurement systems amplifier (requires TPA-BNC) |

■ TekVPI

| TekVPI component | Description |
|------------------|---|
| TAP1500 | 1.5 GHz active single-ended voltage probe |
| TAP2500 | 2.5 GHz active single-ended voltage probe |
| TCP0020 | 50 MHz, 20 A AC/DC current probe |
| TCP0030A | DC to 120 MHz, 30 A AC/DC current probe |
| TCP0150 | DC to 20 MHz, 150 A AC/DC current probe |
| TDP0500 | 500 MHz active differential voltage probe |
| TDP1000 | 1 GHz active differential voltage probe |
| TDP1500 | 1.5 GHz active differential voltage probe with ± 8.5 V differential input voltage |
| TDP3500 | 3.5 GHz differential voltage probe with ± 2 V differential input voltage |
| TPP0502 | 500 MHz 2X TekVPI passive voltage probe |
| TPP0850 | 2.5 kV 800 MHz TekVPI high-voltage passive probe |
| TPP500, TPP1000 | 10X Passive Probes are compact with 10X attenuation, designed for use with Tektronix MSO/DPO4000B and MSO/DPO5000B Series instruments. The bandwidth (-3 dB) for TPP500 is 500 MHz. The bandwidth (-3 dB) for TPP1000 is 1 GHz. |
| THDP0100 | ± 6 kV, 100 MHz high-voltage differential probe |
| THDP0200 | ± 1.5 kV, 200 MHz high-voltage differential probe |
| TMDP0200 | ± 750 V, 200 MHz high-voltage differential probe |
| P5100A | 2.5 kV, 500 MHz, 100X high-voltage passive probe |

DPO7000C

■ BNC

| BNC component | Description |
|---------------|-------------------------------|
| CT1, CT2, CT6 | Current probes, AC high-speed |
| P6021, P6022 | Current probes, AC |

■ TekProbe

| TekProbe component | Description |
|--------------------|---------------------------|
| ADA400A | Differential preamplifier |
| P5100A | High-voltage probe |
| P6015A | High-voltage probe |
| P6139B | Passive probe |

| TekProbe component | Description |
|-----------------------|--|
| P6158 | 20X low-capacitance probe, 3 GHz |
| P6243 | Active probe, 1 GHz |
| P6245 | Active probe, 1.5 GHz |
| P6246 | Differential probe, 400 MHz |
| P6247 | Differential probe, 1 GHz |
| P6248 | Differential probe, 1.5 GHz |
| P6701B | Converter, optical-to-electrical (multi-mode) |
| P6703B | Converter, optical-electrical (single-mode) |
| TCP202A | Current probe |
| TCP300, TCP400 Series | Current measurement system (Requires TCPA300/TCPA400 amplifiers) |

- TekVPI

| TekVPI component | Description |
|------------------|---|
| TAP1500 | Active probe, 1.5 GHz |
| TAP2500 | Active probe, 2.5 GHz |
| TAP3500 | Active probe, 3.5 GHz |
| TCP0020 | 50 MHz TekVPI 20 Ampere AC/DC current probe |
| TCP0030A | 120 MHz TekVPI 30 Ampere AC/DC current probe |
| TDP0500 | 500 MHz TekVPI differential voltage probe with ± 42 V differential input voltage |
| TDP1000 | 1 GHz TekVPI differential voltage probe with ± 42 V differential input voltage |
| TDP1500 | 1.5 GHz TekVPI differential voltage probe with ± 8.5 V differential input voltage |
| TDP3500 | 3.5 GHz TekVPI differential voltage probe with ± 2 V differential input voltage |
| TCP0150 | DC to 20 MHz, 150 A AC/DC current probe |
| THDP0100 | ± 6 kV, 100 MHz high-voltage differential probe |
| THDP0200 | ± 1.5 kV, 200 MHz high-voltage differential probe |
| TMDP0200 | ± 750 V, 200 MHz high-voltage differential probe |
| P5100A | 2.5 kV, 500 MHz, 100X high-voltage passive probe |

MSO/DPO70000DX, DPO70000C, and MSO70000C:

- BNC

| BNC component | Description |
|---------------|-------------------------------|
| CT1, CT2, CT6 | Current probes, AC high-speed |
| P6021, P6022 | Current probes, AC |

- Logic (MSO70000C/DX Series)

| Logic component | Description |
|-----------------|--|
| P6717A | 16 data and 1 clock channel logic probe with accessories |
| P6780 | 16 data and 1 clock channel differential logic probe with accessories that you solder in |

■ TekConnect

| TekConnect component | Description |
|----------------------|---|
| P7260 | Low-capacitance active voltage probe, 6 GHz |
| P7313, P7313SMA | Differential probe, 12.5 GHz |
| P7350, P7350SMA | Differential probe, 5 GHz |
| P7360 | Differential probe, 6 GHz |
| P7380, P7380SMA | Differential probe, 8 GHz |
| P7504 | TriMode probe, 4 GHz |
| P7506 | TriMode probe, 6 GHz |
| P7508 | TriMode probe, 8 GHz |
| P7513A | TriMode probe, 13 GHz |
| P7516 | TriMode probe, 15 GHz |
| P7520A | TriMode probe, 25 GHz with optional tip |
| P7630 | TriMode probe, 30 GHz |
| TCA-BNC | Adapter, TekConnect-to-BNC |
| TCA-N | Adapter, TekConnect-to-N |
| TCA-SMA | Adapter, TekConnect-to-SMA |
| TCA-1MEG | High-impedance buffer amplifier (Includes P6139A passive probe) |
| TCA-75 | Adapter, 4 GHz: 75 Ω to 50 Ω 75 Ω BNC input |
| TCA-292MM | TekConnect to 2.92 mm connectors |

■ TekProbe

| TekProbe component | Description |
|--------------------|----------------------------------|
| ADA400A | Differential preamplifier |
| P5050 | 10X passive probe, 500 MHz |
| P5100 | High-voltage probe |
| P5200 | High-voltage differential probe |
| P5205 | High-voltage differential probe |
| P5210 | High-voltage differential probe |
| P6015A | High-voltage probe |
| P6101B | 1X passive probe, 15 MHz |
| P6139A | Passive probe |
| P6158 | 20X low-capacitance probe, 3 GHz |
| P6243 | Active probe, 1 GHz |

| TekProbe component | Description |
|-----------------------|--|
| P6245 | Active probe, 1.5 GHz |
| P6246 | Differential probe, 400 MHz |
| P6247 | Differential probe, 1 GHz |
| P6248 | Differential probe, 1.5 GHz |
| P6701B | Converter, optical-to-electrical (multimode) |
| P6703B | Converter, optical-electrical (single-mode) |
| TCP202A | Current probe |
| TCP300, TCP400 Series | Current measurement system (Requires TCPA300/TCPA400 amplifiers) |

DPO70000SX Series

■ BNC

| BNC component | Description |
|---------------|-------------------------------|
| CT1, CT2, CT6 | Current probes, AC high-speed |
| P6021, P6022 | Current probes, AC |

■ TekConnect

| TekConnect component | Description |
|----------------------|--|
| P7260 | Low-capacitance active voltage probe, 6 GHz |
| P7313, P7313SMA | Differential probe, 12.5 GHz |
| P7380, P7380SMA | Differential probe, 8 GHz |
| P7504 | TriMode probe, 4 GHz |
| P7506 | TriMode probe, 6 GHz |
| P7508 | TriMode probe, 8 GHz |
| P7513A | TriMode probe, 13 GHz |
| P7516 | TriMode probe, 15 GHz |
| P7520A | TriMode probe, 25 GHz with optional tip |
| P7625 | 25 GHz Low Noise TriMode® Probe |
| P7630 | TriMode probe, 30 GHz |
| P7633 | 33 GHz Low Noise TriMode® Probe |
| TCA-BNC | Adapter, TekConnect-to-BNC |
| TCA-N | Adapter, TekConnect-to-N |
| TCA-SMA | Adapter, TekConnect-to-SMA |
| TCA-1MEG | High-impedance buffer amplifier (Includes P6139A passive probe) |
| TCA-75 | Adapter, 4 GHz: 75 Ω to 50 Ω 75 Ω BNC input |
| TCA-292D | TekConnect to 2.92 mm connectors (33 GHz) |
| TCA75 | 8 GHz precision TekConnect® 75 Ω to 50 Ω adapter with 75 Ω BNC input connector |

■ TekProbe

| TekProbe component | Description |
|-----------------------|--|
| P5200 | High-voltage differential probe |
| P5205 | High-voltage differential probe |
| P5210 | High-voltage differential probe |
| P6015A | High-voltage probe |
| P6139A | Passive probe |
| P6701B | Converter, optical-to-electrical (multimode) |
| P6703B | Converter, optical-electrical (single-mode) |
| TCP202A | Current probe |
| TCP300, TCP400 Series | Current measurement system (Requires TCPA300/TCPA400 amplifiers) |

Options

The following options are available for your instrument.

DPO5000B, MSO5000B:

- Software:
- Opt. BRR - BroadR-Reach Compliance Testing
- Opt. DDRA - DDR Memory Bus Analysis; Available, only on 1 GHz and 2 GHz models (requires DJA)
- Opt. DJA - Jitter And Eye Analysis Tools - Advanced (DPOJET)
- Opt. ET3 - Ethernet Compliance Testing
- Opt. HSIC - USB HSIC protocol decode and electrical validation (Available on 2 GHz models only.) (requires DJA)
- Opt. MOST – MOST Essentials – Electrical Compliance and Debug Test Solution for MOST50 and MOST150
- Opt. MSOE - 16-channel MSO ¹
- Opt. MTM - Mask Testing for Serial Communication Standards (up to 1.5 Gb/s)
- Opt. PS2 - Power Solution Bundle: DPOPWR, THDP0200, TCP0030A, 067-1686-XX (Deskew Fixture)
- Opt. PS3 - Power Solution Bundle: DPOPWR, TMDP0200, TCP0020, 067-1686-XX (Deskew Fixture)
- Opt. PWR - Power Measurement and Analysis
- Opt. SR-AERO - MIL-STD-1553 Serial Triggering and Analysis
- Opt. SR-AUTO - Automotive Serial Triggering and Analysis (CAN, LIN, FLEXRAY)
- Opt. SR-COMP - Computer Serial Triggering and Analysis (RS-232/422/485/UART)
- Opt. SR-CUST - Custom Serial Analysis Kit for Developers
- Opt. SR-DPHY - MIPI-D-PHY (DSI1/CSI2) Serial Analysis
- Opt. SR-EMBD - Embedded Serial Triggering and Analysis (I2C, SPI)
- Opt. SR-ENET - Ethernet Serial Triggering and Analysis (10BASE-T and 100BASE-TX)
- Opt. SR-USB - USB Serial Triggering and Analysis (LS, FS, HS)
- Opt. SVE - SignalVu Essentials - Vector Signal Analysis Software

¹ Available for DPO5000B Series. Enabling/disabling this key does not change the model number

- Opt. USB - USB 2.0 Compliance Testing
- Opt. USBHSIC - USB2.0 and HSIC Bundle, includes options Opt. DJA, HSIC, SR-USB, and USB
- Opt. USBPWR - USB Power Adapter/ EPS Compliance Automated Test Solution
- Opt. VNM - CAN/LIN Protocol Analysis Software
- Record Length:
- Opt. 5RL - 50 MSamples/ch, 125M maximum for 1 ch and 2 ch
- Opt. 10RL - 125 MSamples/ch, 250M maximum for 1 ch and 2 ch

DPO7000C

- Hardware:
- Opt. 2SR (available only on DPO7104C instruments) - Double maximum real time sample rate
- Record Length:
- Opt. 5RL - 250 MSamples max, 50 MSamples/ch
- Opt. 10RL - 500 MSamples max, 125 MSamples/ch (Only available on DPO7254C/DPO7354C instruments)
- Service:
- Opt. R3 - Repair service 3 years, including warranty
- Opt. R5 - Repair service 5 years, including warranty
- Software:
- Opt. BRR - BroadR-Reach Compliance Testing
- Opt. DDRA - DDR Memory Bus Analysis (requires DJA)
- Opt. DJA - Jitter And Eye Analysis Tools - Advanced (DPOJET)
- Opt. ET3 - Ethernet Compliance Test
- Opt. D-PHY - MIPI® D-PHY Characterization and Compliance Testing
- Opt. HSIC - USB HSIC protocol decode and electrical validation (For models of bandwidth ≥ 2.5 GHz only.) (requires DJA)
- Opt. LSA - Low Speed Serial Analysis (CAN/LIN trigger)
- Opt. MOST – MOST Essentials – Electrical Compliance and Debug Test Solution for MOST50 and MOST150
- Opt. MTM - Serial Communications Mask Testing
- Opt. PWR - DPOPWR Power Measurement and Analysis
- Opt. PS2 - Power Solution Bundle: DPOPWR, THDP0200, TCP0030A, 067-1686-XX (Deskew Fixture)
- Opt. PS3 - Power Solution Bundle: DPOPWR, TMDP0200, TCP0020, 067-1686-XX (Deskew Fixture)
- Opt. SR-AERO - MIL-STD-1553 Serial Triggering and Analysis
- Opt. SR-AUTO - Automotive Serial Triggering and Analysis (CAN, LIN, FLEXRAY)
- Opt. SR-COMP - Computer Serial Triggering and Analysis (RS-232/422/485/UART)
- Opt. SR-CUST - Custom Serial Analysis Kit for Developers
- Opt. SR-DPHY - MIPI-D-PHY (DSI1/CSI2) Serial Analysis
- Opt. SR-EMBD - Embedded Serial Triggering and Analysis (I2C, SPI)

- Opt. SR-ENET - Ethernet Serial Analysis (10BASE-T and 100BASE-TX)
- Opt. SR-PCIE - PCI Express Compliance Module for RT-Eye Serial Data Compliance and Analysis
- Opt. SR-USB - USB Serial Triggering and Analysis (LS, FS, HS)
- Opt. SR-810B - 8b/10b Serial Triggering and Analysis
- Opt. ST1G – 64-bit NRZ Serial Trigger and 8b/10b Serial Protocol Decode (includes Opt. SR-810B) (only available on DPO7254C/DPO7354C instruments)
- Opt. SV23 - WLAN 802.11a/b/g measurement application (Requires Opt. SVE) (For models of bandwidth ≥ 2.5 GHz only)
- Opt. SV24 - WLAN 802.11n measurement application (Requires Opt. SVE and SV23) (For models of bandwidth ≥ 2.5 GHz only)
- Opt. SVA - SignalVu AM/FM/Direct Audio Measurements (requires SVE)
- Opt. SVE - SignalVu™ Essentials for Vector Signal Analysis
- Opt. SVM - General Purpose Modulation Analysis (requires SVE)
- Opt. SVO - Flexible OFDM Analysis (requires SVE)
- Opt. SVP - SignalVu Pulse — Advance Signal Analysis Software (requires SVE)
- Opt. SVT - Settling Time Measurements such as Frequency and Phase (requires SVE)
- Opt. USB - Universal Serial Bus USB2.0 Compliance Test
- Opt. USBHSIC - USB2.0 and HSIC Bundle, includes options Opt. DJA, HSIC, SR-USB, and USB
- Opt. USBPWR - USB Power Adapter/ EPS Compliance Automated Test Solution

MSO/DPO70000C/DX:

- Calibration:
 - Opt. C3 - Calibration service 3 years
 - Opt. C5 - Calibration service 5 years
 - Opt. D1 - Calibration data report
 - Opt. D3 - Calibration data report 3 years (with Opt C3)
 - Opt. D5 - Calibration data report 5 years (with Opt C5)
- Hardware:
 - Opt. 1R - Rackmount kit
- Record Length:

MSO70000C/DX, and DPO70000C/DX Series:

- Opt. 2XL - 31 MSamples/ch (standard on DPO instruments)
- Opt. 5XL - 62 MSamples/ch (standard on MSO instruments)
- Opt. 10XL - 125 MSamples/ch
- Opt. 20XL - 250 MSamples/ch
- Opt. 50XL - 500 MSamples/ch
- Service:

- Opt. CA1 - Provides single calibration event for the designated interval
 - Opt. R3 - Repair service 3 years (including warranty)
 - Opt. R5 - Repair service 5 years (including warranty)
 - Software:
- MSO70000C/DX, and DPO70000C/DX Series:
- Opt. BRR - BroadR-Reach Compliance Testing
 - Opt. DDRA - DDR Memory Bus Analysis
 - Opt. DJA - Advanced Jitter and Eye Analysis (standard on MSO instruments)
 - Opt. D - PHY MIPI D-PHY Transmitter Debug, Characterization, and Compliance Test Solution (requires DJA)
 - Opt. DP12 - DisplayPort 1.2 Source Test Automation (requires Opt. DJA and Opt.5XL or higher)
 - Opt. ERRDT - Frame and Bit Error Rate Detector in high speed serial standards (requires option ST6G).
 - Opt. ET3 - Ethernet Compliance Test
 - Opt. HSIC – HSIC Essentials - Electrical Validation and Protocol Decode Solution (Requires Opt. DJA)
 - Opt. HT3 - HDMI Compliance Test
 - Opt. HT3DS - HDMI Direct Synthesis for HDMI 1.4 Compliance Test
 - Opt. M - PHY - MIPI M-PHY Essentials – Characterization and Analysis Solution (Requires Opt. DJA)
 - Opt. M - PHYTX - M-PHY Automated Transmitter Solution (requires DJA)
 - Opt. M - PHYRX - M-PHY Automated Receiver Solution (Requires Opt. ST6G) (Requires Opt. ERRDT)
 - Opt. MTH - Mask Testing for serial standards, 4.25 GB/s (standard on MSO instruments)
 - Opt. MOST - Electrical Compliance and Debug Test Solution for MOST50 and MOST150 (Requires Opt. DJA)
 - Opt. PCE3 - PCI Express® Transmitter Compliance and Debug (Requires Opt. DJA) (For models of bandwidth ≥ 6 GHz only)
 - Opt. PWR - DPOPWR Power Measurements and Analysis
 - Opt. QPI - Intel® Quick Path Interconnect Test Automation Software (Requires Opt. DJA)
 - Opt. SAS3 - SAS3 12 GB/s Essentials (Requires Opt. DJA and 2XL or higher) (For models of bandwidth ≥ 20 GHz only)
 - Opt. SFP-TX - SFP+ Compliance and Debug Solution (Requires Opt. DJA)
 - Opt. SFP-WDP - SFP+ Compliance and Debug Solution – WDP Measurement (Requires Opt. DJA)
 - Opt. SDLA64 - Serial Data Link Analysis Visualizer
 - Opt. SR-AERO - MIL-STD-1553 Serial Triggering and Analysis
 - Opt. SR-AUTO - Automotive Serial Triggering and Analysis (CAN, LIN, FLEXRAY)
 - Opt. SR-COMP - Computer Serial Triggering and Analysis (RS-232/422/485/UART)
 - Opt. SR-DPHY - MIPI-D-PHY (DSI1/CSI2) Serial Analysis
 - Opt. SR-EMBD - Embedded Serial Triggering and Analysis (I2C, SPI) (standard on MSO instruments)
 - Opt. SR-ENET - Ethernet Serial Analysis (10BASE-T and 100BASE-TX)
 - Opt. SR-PCIE - PCI Express Compliance Module for RT-Eye Serial Data Compliance and Analysis
 - Opt. SR-USB - USB Serial Triggering and Analysis (LS, FS, HS)

- Opt. SR-810B - 8b/10b Serial Triggering and Analysis
- Opt. ST6G - Serial Protocol Trigger Software to trigger and decode 8 B/10 B data on high-speed serial or data protocols. Protocol triggering up to 6.25 GS/s. (standard on MSO instruments)
- Opt. SVA - AM/FM/PM Audio Signal Analysis (Requires Opt. SVE)
- Opt. SVE - SignalVu Essentials for Vector Signal Analysis
- Opt. SVM - SignalVu Essentials for General Purpose Modulation Analysis (requires option SVE)
- Opt. SVO - Flexible OFDM Analysis (requires SVE)
- Opt. SVP - SignalVu Pulse — Advance Signal Analysis Software (requires SVE)
- Opt. SVT - Settling Time Measurements such as Frequency and Phase (requires SVE)
- Opt. TBT-TX - Thunderbolt Transmitter Characterization, Debug, and Compliance Testing (Requires Opt. DJA and Opt. 2XL or higher) (For models of bandwidth ≥ 16 GHz only)
- Opt. UHS2 - UHS-II-Host-Tx and UHS-II-Device-Tx Measurements (For models of bandwidth ≥ 6 GHz only)
- Opt. USB - Universal Serial Bus USB 2.0 Compliance Test
- Opt. USBHSIC - USB2.0 and HSIC Bundle, includes options Opt. DJA, HSIC, SR-USB, and USB
- Opt. USBPWR - USB Power Adapter/ EPS Compliance Automated Test Solution (Not supported on 70000DX models)
- Opt. USB3 - Universal Serial Bus USB 3.0 Compliance and Analysis
- Opt. VET - Visual Trigger and Search
- Opt. 10G-KR - 10GBASE-KR/KR4 Compliance and Debug Solution (Requires Opt. DJA) (For models of bandwidth ≥ 16 GHz only)

DPO70000SX Series

- Calibration:
 - Opt. C3 - Calibration service 3 years
 - Opt. C5 - Calibration service 5 years
 - Opt. D1 - Calibration data report
 - Opt. D3 - Calibration data report 3 years (with Opt C3)
 - Opt. D5 - Calibration data report 5 years (with Opt C5)
- Hardware:
 - Opt. SSD Additional Removable Disk - Solid State Drive
- Record Length:

DPO70000SX Series:

- Opt. 10XL - 125 MSamples/ch
- Opt. 20XL - 250 MSamples/ch
- Opt. 50XL - 500 MSamples/ch, 1 G/Ch on 2 channels
- Service:
 - Opt. CA1 - Provides single calibration event for the designated interval
 - Opt. G3 Complete Care 3 Years (includes loaner, scheduled calibration, and more)

- Opt. G5 Complete Care 5 Years (includes loaner, scheduled calibration, and more)
- Opt. IF Upgrade Installation Service
- Opt. R3 - Repair service 3 years (including warranty)
- Opt. R5 - Repair service 5 years (including warranty)
- Software:

DPO7000SX Series:

- Opt. ASM - Advanced Event Search and Mark
- Opt. DJA - Advanced Jitter and Eye Analysis (standard on MSO instruments)
- Opt. DJAN - DPOJET Noise, Jitter and Eye Analysis Tools (requires DJA)
- Opt. PAM4 transmitter and channel testing for four-level Pulse Amplitude Modulation (PAM4) devices and interfaces.
- Opt. SDLA64 - Serial Data Link Analysis Visualizer
- Opt. LT - Waveform Limit Testing
- Opt. SR-810B - 8b/10b Serial Triggering and Analysis
- Opt. SVA - AM/FM/PM Audio Signal Analysis (Requires Opt. SVE)
- Opt. SVE - SignalVu Essentials for Vector Signal Analysis
- Opt. SVM - SignalVu Essentials for General Purpose Modulation Analysis (requires option SVE)
- Opt. SVO - Flexible OFDM Analysis (requires SVE)
- Opt. SVP - SignalVu Pulse — Advance Signal Analysis Software (requires SVE)
- Opt. SVT - Settling Time Measurements such as Frequency and Phase (requires SVE)
- Opt. SV23 - WLAN802.11a/b/g/j/p measurement application (requires Opt. SVE)
- Opt. SV24 - WLAN 802.11n measurement application (requires Opt SV23)
- Opt. SV25 - WLAN 802.11ac measurement application (requires Opt SV24)
- Opt. SV27 - SignalVu Bluetooth Basic LE TX SIG measurements
- Opt. SV28 - SignalVu LTE Downlink RF measurements (requires Opt. SVE)
- Opt. VET - Visual Trigger and Search

Documentation and technical support

Documentation

In addition to the instrument online help, the following documents are available:

MSO/DPO70000, DPO7000, and MSO/DPO5000 Series:

- **Digital Phosphor Oscilloscopes User Manual (071-2980-XX).** The Quick Start User Manual has information about installing and operating your instrument. The Quick Start User Manual is available in several languages, in addition to English.
- **Digital Phosphor Oscilloscopes Programmer Online Guide.** The Programmer Guide is provided as online help and as a printable PDF file. See the product software DVD for installation information.

- **Digital Phosphor Oscilloscopes Specifications and Performance Verification Technical Reference Manual (077-0063-XX)**. This is a PDF only manual that includes both the specifications and the performance verification procedure.
- **Digital Phosphor Oscilloscopes Service Manual (077-0076-XX)**. A service manual is available as a PDF file; it includes procedures to service the instrument to the module level.

DPO7000SX Series:

- **Digital Phosphor Oscilloscopes User Manual (071-3357-XX)**. The User Manual has information about installing and operating your instrument. The User Manual is available in several languages, in addition to English.
- **Digital Phosphor Oscilloscopes Programmer Online Guide**. The Programmer Guide is provided as online help and as a printable PDF file.
- **Digital Phosphor Oscilloscopes Specifications and Performance Verification Technical Reference Manual (077-1043-XX)**. This is a PDF only manual that includes both the specifications and the performance verification procedure.

Other documentation. Your instrument includes PDF files of relevant information on the product hard drive.

For quick access to PDF files of the user manual, probe manuals, programmer guide, primers and applications, specifications and performance verification manual, service and installation manuals, and a printable version of the online help, click the Documentation icon on your instrument desktop.

What do you want to do next?

[Find out about using online help.](#)

[Learn how to access Tektronix Support.](#)

[Provide feedback on this Tektronix product.](#)

Support information

Tektronix offers the following services in support of our products:

- **Technical Support.** For application-related questions about a Tektronix product, [contact us by telephone or e-mail](#).
- **Service Support.** For service-related questions about a Tektronix product, [contact us by telephone or e-mail](#).

Tektronix also offers extended warranty and calibration programs as options on many products. Contact your local Tektronix distributor or sales office.

- **Write to Tektronix:**

Tektronix, Inc.

Department or name (if known)

14200 SW Karl Braun Drive

P.O. Box 500

Beaverton, OR 97077 USA

What do you want to do next?

[Find out what other documents are available.](#)

[Find out about using online help.](#)

[Provide feedback on this Tektronix product.](#)

TekScope recovery report utility

The TekScope Recovery Report Utility is designed to gather logs and other files that may contain data useful to Tektronix in the diagnosis of TekScope Errors, and it creates a .zip file on the desktop to hold all of the gathered data. This compressed file is easily copied from the desktop to a removable flash drive, or the file can be sent to Tektronix as an email attachment.

If you contact Tektronix for help in diagnosing TekScope Errors, you may be asked to run this utility and supply Tektronix with the .zip file.

NOTE. The utility will erase temporary data created under the account of the user that runs the utility. This allows TekScope to generate fresh files the next time it starts.

Finding the utility. A link to the utility can be found under the Start\All Programs\Tektronix\TekScope\ directory.

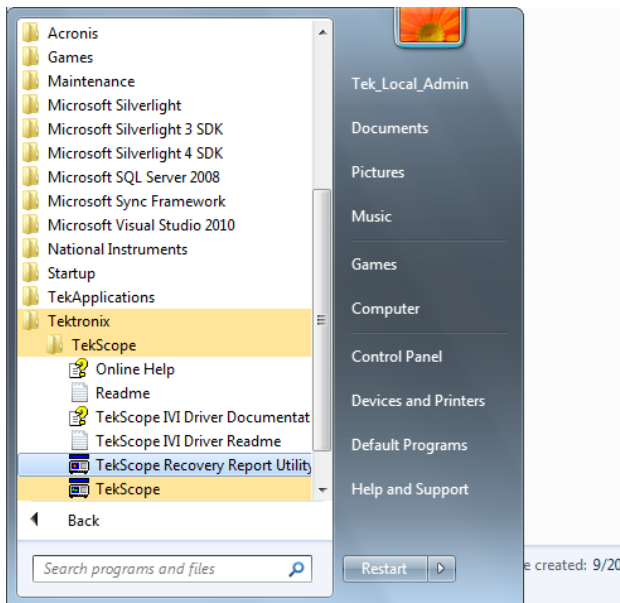

Running the utility. Click on the utility link.

If TekScope is running when the utility is invoked, the utility will warn the user that TekScope must be stopped. This is necessary to allow the utility to access some of the files. The utility will automatically stop TekScope after it queries the serial number of the instrument. Click Yes to allow the utility to stop TekScope and collect files for the report.

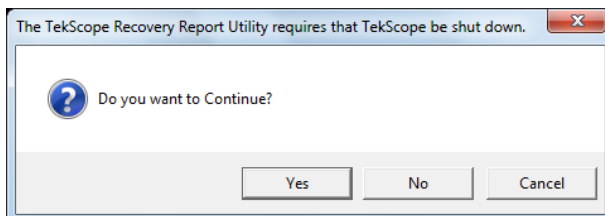

If TekScope is not running, the recovery utility will still run and will collect files for the report.

Finding the report. When the utility is finished running, the zipped report file is on the desktop.

- a) In the case where TekScope was running when the utility was invoked, the name of the .zip report file created on the desktop will contain the type of instrument and the serial number. For example:
TekScope_Recovery_Report_MS071254C_123456789.zip.
- b) However, if TekScope was not running when the utility was invoked, the name of the .zip report file will not contain the serial number. For example: TekScope_Recovery_Report_MS071254C.zip

Data contained in the report. When the utility is finished running, if these files exist on the instrument, the report will contain copies of these specific files:

```
C:\windows\Sysnative\winevt\logs\Application.evtx C:\programdata\tektronix\ISD.XML C:\programdata\Tektronix\TekScope\Calibration\console.log C:\programdata\Tektronix\TekScope\Calibration\console.logOld C:\programdata\Tektronix\TekScope\Calibration\calSPCConst.dat C:\programdata\Tektronix\TekScope\Calibration\caldiag.log C:\programdata\Tektronix\TekScope\Calibration\caldiag.logOld C:\programdata\Tektronix\TekScope\Calibration\error.log
```

When the utility is finished running, the zipped report file will also contain copies of all files found in the following directories:

```
C:\programdata\Tektronix\TekScope\Internal\*. * C:\programdata\Tektronix\TekScope\Calibration\CalDramDump\*. * C:\programdata\Tektronix\TekScope\Calibration\CalDramDumpFact\*. *
```

Data deleted by the utility. Running this utility will delete the following files:

```
C:\users\<current_user>\AppData\LocalLow\Tektronix\tekScope\Internal\*. *
```

Because TekScope was having difficulties, some files may have been corrupted. Deleting these files will allow TekScope to regenerate them on the next start-up. Deleting these files may resolve the initial problem.

The utility log file. You can see a log file of the operation performed by the recovery report utility at: C:\Temp\TekScopeRecoveryReportUtility_log.txt

Feedback

Tektronix values your feedback on our products. To help us serve you better, please send any suggestions, ideas, or other comments you may have regarding your instrument.

- Direct your feedback to us via e-mail at www.tektronix.com/contact-us.

Include the following information in the subject field: "NEW and IMPROVED Scope Customer Feedback."

Please be as specific as possible.

Recommended information to include.

- Instrument hardware, for example, display, chassis, and so on
- Application software version
- Probes

Optional information. Your name, company, mailing address, phone number, and FAX number.

What do you want to do next?

[Find out what other documents are available](#)

[Find out about using online help.](#)

[Learn how to access Tektronix Support.](#)

[Return to the beginning of the introduction.](#)

Analysis and connectivity support

This instrument includes tools you can install to support data export for use with data-analysis tools.

You can use the analysis and connectivity tools included with your instrument to do the following:

- Gather instrument data (waveforms and measurements) and port it to familiar, off-the-shelf, analysis tools, such as Microsoft Excel
- Interface with a popular software development environments, such as Lab Windows and LabVIEW

Click the following tools to find out how they can help you connect to your instrument and analyze the data that it collects:

- VXI Plug-and-Play Instrument Driver
- TekVISA
- TekVISA ActiveX Control (TVC)
- TekVISA Excel Toolbar
- VXI 11.2 LAN Server
- Report Generator
- IVI Drivers
- Tek LXI

For more information, see the *Getting Started with OpenChoice Solutions Manual*.

VXI Plug-and-Play instrument driver

The VXIplug&play instrument driver is a collection of software components, organized according to the standard VXIplug&play model established by the VXIplug&play Systems Alliance. Use this VXIplug&play instrument driver to simplify programming tasks when using the following software development environments:

- LabWindows/CVI
- LabVIEW
- MATLAB
- Visual C++ 6.0
- Visual Basic 6.0
- HP-VEE

TekVISA

TekVISA is a library of industry-standard compliant software components, organized according to the standard VISA model established by the VXIplug&play Systems Alliance. Use TekVISA in software to write interoperable instrument drivers to handle communicating between software applications and your oscilloscope. TekVISA offers the following features and benefits:

- Provides end users with a consistent methodology for using instrument drivers from a variety of vendors
- Provides programmers with language interface libraries for use with multiple application development environments, such as Microsoft C /C++, Microsoft Visual Basic, LabVIEW graphics software using the G language, and MATLAB analysis software.
- Provides a configuration utility for setting up additional VISA resources
- Allows software installation and connectivity on any number of PCs

TekVISA ActiveX Control (TVC)

The TekVISA Control (TVC) uses Microsoft Windows ActiveX control technology to simplify access from Microsoft Office and Visual BASIC applications to TekVISA and the underlying instrument.

This is accomplished by providing support for key TekVISA features within an ActiveX control object that is compatible with Excel's Visual BASIC for Applications, Visual BASIC 6.0, and other popular programming environments for Microsoft Windows.

TekVISA excel toolbar

The TekVISA Excel Toolbar allows direct, fast transfer of instrument measurements or captured waveforms to an Excel 97 and/or Excel 2000 worksheets. Transfer is via a toolbar that is integrated into Excel, implemented using the TekVISA ActiveX Control (TVC) and the Visual BASIC for Applications macro editor built into Excel.

Source code for the toolbar is accessible through Excel's built-in VBA editor for use as a learning tool for using the TekVISA ActiveX Control, or to cut-and-paste selected components to new VB applications.

VXI 11.2 LAN server

The VXI 11.2 LAN Server provides software connectivity between your instrument and remote PCs over an Ethernet LAN. This tool is a client-side component built-in with TekVISA on each remote PC, you must install another copy of TekVISA to make use of its client-side component.

The VXI-11 standard specifies a protocol for communication with devices over a network via a network instrument server. This protocol uses the ONC/RPC (Open Network Computing/Remote Procedure Call) standard that, in turn, is based on TCP/IP.

Report generator

Report Generator, a Microsoft Windows application, lets you create custom reports for displaying your oscilloscope data.

Report Generator enables you to generate and print reports directly from the oscilloscope, enhancing your application capabilities by simplifying the process of creating and maintaining reports.

IVI drivers

IVI drivers conform to specifications produced by the IVI Foundation.

Unlike VXI-plug&play drivers, IVI drivers provide a standard interface to different classes of instruments, including oscilloscopes and spectrum analyzers.

IVI drivers have the ability to simulate instruments, automatically check ranges, and multithread safety features.

Tek LXI

Tek LXI conforms to the LAN eXtensions for Instrumentation (LXI) standard. The LXI standard defines the communications protocols that allow communication with the instrument over a local area network (LAN).

About TekScope

From the Help menu, select About TekScope.

Overview. Provides the details of the instrument such as the model name, identification number, serial number, and version of the software that is installed. The options name and the key details of the applications that are installed in the instrument are also listed.

On MSO/DPO70000C models, About TekScope also indicates if TekProtect is Installed or Not Installed on the instrument. TekProtect provides protection from electrical overstress (EOS) and electrostatic discharge (ESD) on the four analog input channels.

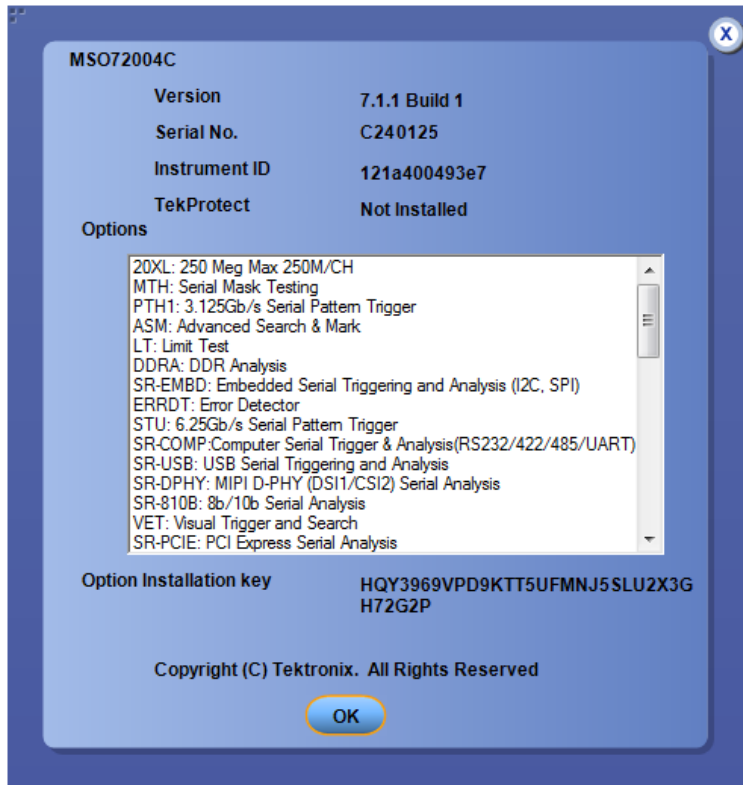

Working with your Tektronix oscilloscope

Windows environment

Windows interface guidelines. Because the instrument uses the Microsoft Windows interface, you have open access to the Windows operating system. You can access the Windows desktop to load and run other Windows-based applications such as Microsoft Excel, WordPad, and Paint.

Although you have access to the Windows interface, you should avoid making operating system changes that may cause problems or annoyances while trying to use the instrument. Here are some guidelines:

- The instrument has been tested with the version of Microsoft Windows provided and is not intended to operate with any other versions.
- If the instrument powers on in Windows Safe Mode, the touch screen is inoperative. You may need to use a mouse or keyboard to restore normal operation.
- To keep the start-up time to a minimum, keep the network support to a minimum.
- Be careful when making changes in the Control Panel. Avoid making changes to any controls with which you are unfamiliar.
- Do not change the LCD color quality (Highest 32 bit) and screen resolution settings (1024 by 768 pixels) or the video port may not work properly.
- Some third-party applications may not work properly with the instrument. If your instrument stops working after you install third-party software, try reloading the instrument software.
- If you do not have an external monitor attached to the instrument, avoid changing the taskbar properties to "Always on top" and "Auto hide." The Windows taskbar may obscure buttons or readouts on the screen. However, if you do have an external monitor attached and the instrument is set to dual monitor mode, you can drag the taskbar from the instrument display to the external monitor display and use these settings.
- Disable the Windows screen saver to prevent it from turning on while you are taking measurements or viewing the display. If the screen saver comes on while taking measurements, touch the screen (if the touch screen is installed and enabled), move the mouse, or press any key on the attached keyboard.
- Do not delete or change any system fonts. Changing, removing, or resizing fonts may affect the quality of the display and corrupt the TekScope buttons and menus.
- Avoid personalizing or changing the system Display Properties, such as the theme, Background, Appearance, Effects, or Settings. Making such changes can affect the usability of the instrument and the touch screen.
- Avoid making changes to the contents of the Windows folder or to the contents of the TekScope folder.
- Avoid making changes to the BIOS settings. Changing the BIOS settings can affect the overall operation of the instrument.
- Avoid changing the Windows power management system.

If you think that your Windows interface may cause problems with the instrument, contact your local [Tektronix support center](#) for assistance.

Connecting to a network. The instrument is built on a PC-based platform that runs Microsoft Windows as its operating system. Like any other Windows computer, you can connect the instrument to a network to enable printing, file sharing, Internet access, and other communications functions.

Use the Windows Remote Desktop feature to remotely access the instrument.

Enabling a network connection

Use the following steps to enable network access to the instrument. You must begin this procedure with the instrument powered off.



TIP. Consult your network administrator for further assistance.

You may want to print these instructions before you proceed.

1. Attach a keyboard and mouse to the instrument.
2. Power on the instrument.
3. Use the Windows Network Connection Wizard to define the instrument as a network client and configure it for your network. You can find the network setup program in the Windows Start menu if you select Settings > Control Panel, and then double-click Network Connections.
4. Consult with your network administrator for specific instructions for these settings.

Using tek LXI. Tek LXI conforms to the LAN eXtensions for Instrumentation (LXI) standard. The LXI standard defines the communications protocols that allow communication with the instrument over a local area network (LAN). After the TekScope application is running, the LXI application starts. The LXI system tray icon appears when LXI is running.

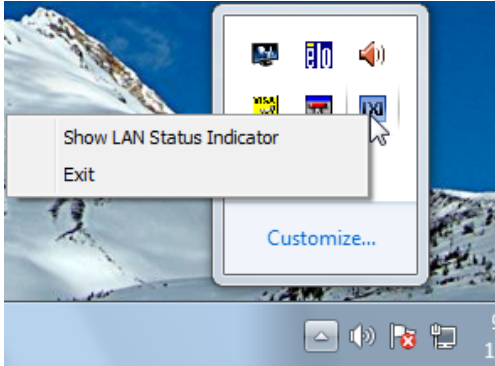

Right click on the icon and select Show LAN Status Indicator. LAN status is indicated in red or green with an appropriate message.

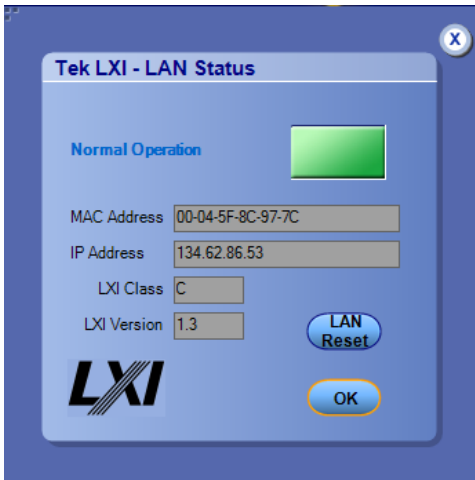

NOTE. Pushing the LAN Reset button does a LAN configuration initialization: enables DHCP, enables Auto-IP, enables ICMP ping responder, sets the Web password to default (No password), and updates the LXI XML identification. Refer to the LXI specification for more information.

Enter the IP Address in the Address Bar of your Web browser and click return. The browser finds and displays the instrument home page. Instrument information, instrument network information, and instrument LXI information is displayed on the home page. Click on the SUPPORT Help link to see help on the Welcome Web page.

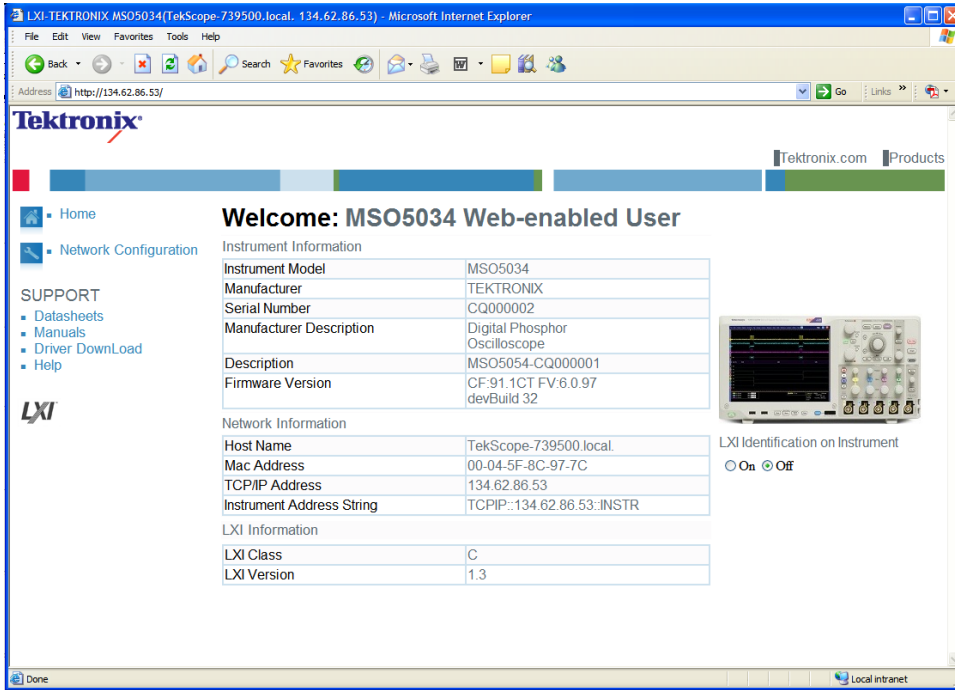

To display network configuration information, click on Network Configuration. The Web page displays the network configuration, and allows you to submit changes to some of the instrument configuration. Click on the Help SUPPORT link to see help on the configuration information.

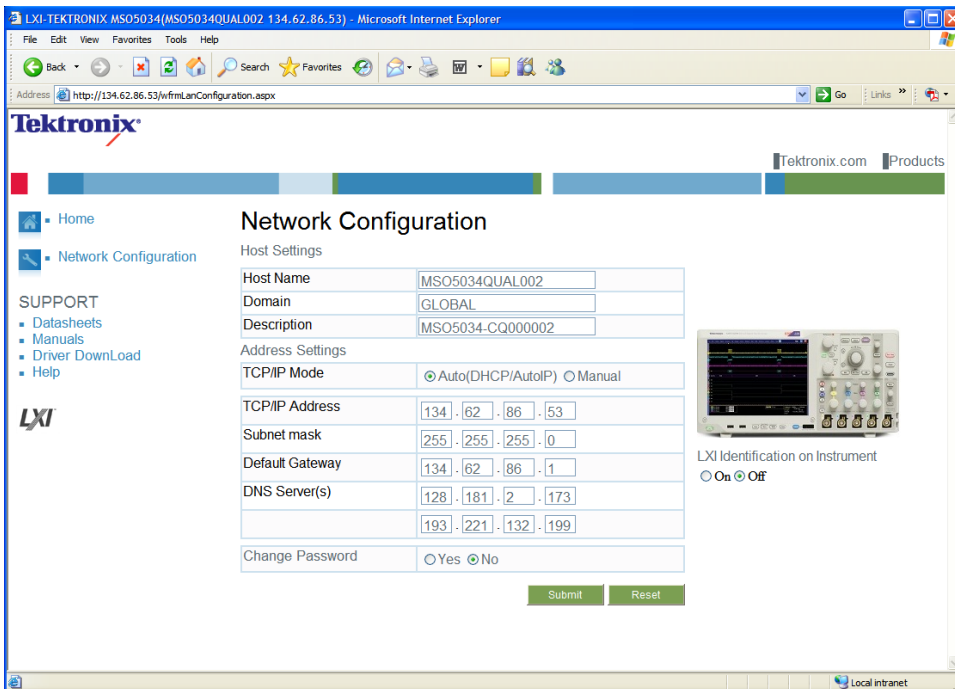

Click on Datasheets, Manuals, or Driver Download to go to the Tektronix Oscilloscopes Web page to access the information.

NIST USGCB compliance. Tektronix oscilloscopes are compatible with the security configuration for Information Technology products specified in the United States Government Configuration Baseline (USGCB) settings for Windows 7 and Internet Explorer.

The National Institute of Standards and Technology (NIST) USGCB baseline operating system security requirements (Version 1.1.x) were implemented and tested on our oscilloscopes. The oscilloscopes passed the Security Content Automation Protocol (SCAP) tests. Our oscilloscopes operate with the USGCB security settings implemented.

NOTE. *Since the USGCB turns off the ISS server, LXI Class C compliance does not work with this data security standard.*

As shipped from the factory, your oscilloscope has none of the USGCB security settings implemented.

Making your oscilloscope compliant. To put their oscilloscope in a USGCB compliant state, follow instructions from the [NIST Web site](#). Click on the Content and then Microsoft Content links. Implement the settings in the GPO files found on the site. After implementing all of the settings, run the SCAP tool to verify compliance.

Restoring your oscilloscope to its factory state. To back out of the USGCB compliant state and restore the oscilloscope to its factory condition, follow the Operating System Restore procedures for your instrument. See your user manual.

Hard copy printing. To make hard copies, use a printer attached to one of the rear-panel ports or connect to a network printer, if your instrument is on a network.

You can print the full screen or just the graticule area.

The instrument uses Windows print drivers, so the process to install printers is the same as it is on any other PC.

The Page Setup dialog box contains some useful options to optimize your printing:

- Choose a print palette that is independent from the display palette. For example, you can print gray-scale images to a black and white laser printer while you choose to view the display in color. The color and gray scale palettes both render the intensity-graded waveform information generated by the DPO display.
- Choose the Ink Saver feature to print a hard copy with a white background. This function saves printer ink while it preserves the color coding of the waveforms and readouts. Ink Saver also works with the monochrome print palettes.

Other PC applications. Transferring images and data from the oscilloscope to other PC applications is as simple as a copy/paste operation. With a word processing, spreadsheet, or analysis application running on the built-in PC, you can easily transfer the following items using the familiar Windows clipboard system:

- Copy a full screen or graticule-only image, and paste it into your document in either .bmp, .png, .tif, or .jpg format.
- Copy a waveform, and paste the waveform data into a spreadsheet in a comma-delimited (.csv) format.
- Copy a waveform, and paste the waveform data into an analysis program in Mathcad (.dat) format.
- Copy the displayed values of all measurements, and paste them into a document in text (.txt) format.
- Copy the displayed values of all measurements, and paste them into a spreadsheet in a comma-delimited (.csv) format.

Second monitor use. To optimize your access to the PC that is built into the oscilloscope, connect a keyboard, mouse, and monitor to the instrument, and then configure Windows for dual-display mode.

In this configuration, the oscilloscope retains full dynamic oscilloscope performance while Windows and other applications such as publishing, analysis, or Web browsing tools reside on the external monitor. You can copy/paste bitmap and waveform data from the oscilloscope to the locally running application or view Web-based reference information while using the oscilloscope for design work.

Dockable windows. You can drag up to five dockable half-screen control windows from the TekScope application onto the display of a second monitor. For example, this feature allows you to have the Horizontal/Acquisition, the Horizontal Zoom, and the Display Setup Control Windows (half screen) open on the second monitor at the same time.

In addition to the five dockable windows on the second monitor, you can have one dockable window open on the main display. If you open a seventh dockable window, the window that has not been used for the longest amount of time will automatically close.

To drag a half-screen control window, click and drag on the left edge of the window.

Connect to other instruments.

- Use the rear-panel vertical signal output (Signal Out) to connect to a buffered version of the signal that is attached to the Channel 3 input (DPO7000C models only).
- Use the rear-panel auxiliary output (Aux Out) to obtain a TTL-compatible, negative polarity pulse when the oscilloscope triggers, or when certain other events occur, such as a mask test failure or completion.
- Use the rear-panel external reference input (Ext Ref) to synchronize the oscilloscope time base to an external 9.8 MHz to 10.2 MHz reference frequency source.

Oscilloscope interface

Instrument interface. On MSO and DPO instruments, you can use the familiar knobs and buttons on the oscilloscope front panel to perform most vertical, horizontal, and triggering functions. It allows you to make quick adjustments to your displayed signals with the dedicated vertical controls for each channel. On a DPO7000SX instrument, use the optional DPO7AFP to access the knobs and buttons.

The screen interface gives you access to the complete functionality of the instrument. This user interface is built on the Windows operating system and has a similar look and feel. It is also fully compatible with a wide range of PC hardware and software accessories, such as networked instrumentation and printers. On a DPO7000SX instrument, use an external monitor to access the screen interface.

The toolbar at the top of the screen is optimized for touch screen operation. Touching (or clicking) a button on the toolbar opens a control window that you can use to select the instrument settings.

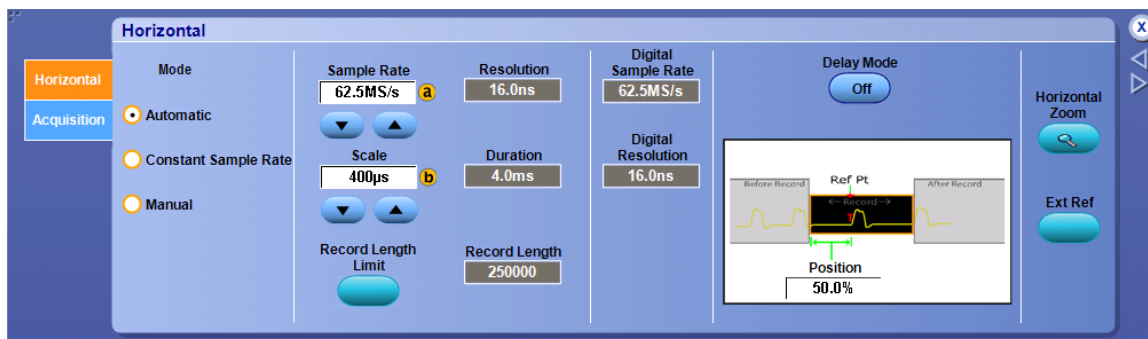

With a mouse, you may prefer to use the PC-style menu bar to open control windows or directly select many instrument settings.

Click the  button, in the upper-right corner of the screen, to switch between *Menu Bar Mode* and *Toolbar Mode*.

Menu bar mode. The menu bar menus provide access to commands that control all of the instrument features and functions.



When you select a feature setup command, the instrument displays the associated control window on the lower half of the screen. Each control window provides access to the individual instrument controls.

The display graticule is redrawn to fit in the upper half of the screen.

What do you want to do next?

[Display help on the File menu.](#)

[Display help on the Edit menu.](#)

[Display help on the Vertical menu.](#)

[Display help on the Digital menu.](#)

[Display help on the Horizontal/Acquisition \(Horiz /Acq\) menu.](#)

[Display help on the Trigger \(Trig\) menu.](#)

[Display help on the Display menu.](#)

[Display help on the Cursors menu.](#)

[Display help on the Measurement \(Measure\) menu.](#)

[Display help on the Math menu.](#)

[Display help on the Mask menu.](#)

[Display help on the Analyze menu.](#)

[Display help on the Utilities menu.](#)

[Display help on the Help menu.](#)

Toolbar mode. The toolbar buttons give you instant access to most instrument features without having to navigate through several menus.



Click a toolbar button to display an associated control window on the lower half of the screen. Each control window provides access to the individual instrument controls. The display graticule is redrawn to fit in the upper half of the screen.

Not all features of the instrument are accessible from the toolbar. To access some of the less common controls, you can change to [Menu Bar Mode](#). To do this, click the Menu button (with the arrow) in the upper-right corner of the screen.

You can also customize the toolbar to add menus you use more frequently. Click the Menu button (with the arrow) to see the list of menus you can add and to access the Customize Toolbar dialog box.



What do you want to do next?

[Display help on the Vertical Setup control window.](#)

[Display help on the Digital Setup control menu.](#)

[Display help on the Horizontal/Acquisition Setup control window.](#)

[Display help on the Trigger Setup control window.](#)

[Display help on the Display Setup control window.](#)

[Display help on the Cursors Setup control window.](#)

[Display help on the Measurement Setup control window.](#)

[Display help on the Math Setup control window.](#)

[Display help on the Mask Setup control window.](#)

[Display help on the Save As dialog box.](#)

[Display help on the Recall dialog box.](#)

[Learn to Customize the Toolbar.](#)

Toolbar customizing. The Customize option of toolbar mode gives you access to add or remove menu buttons, configure the order of the menu buttons, and set the toolbar back to its default configuration. You can customize the toolbar to view the menu buttons that you use more frequently.

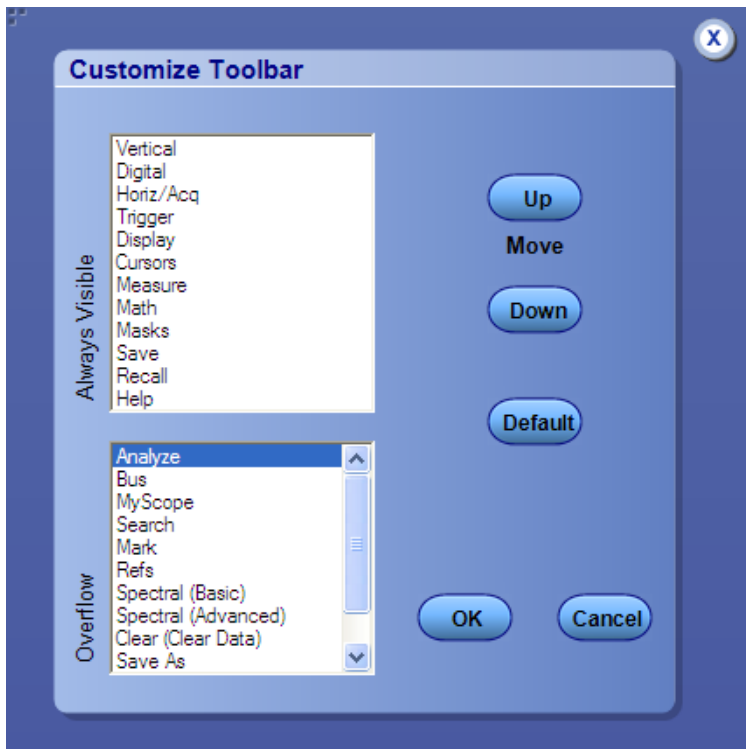

To access some of the less common controls, click the [Menu Bar Mode](#). To do this, click the Menu button (with the arrow) in the upper-right corner of the screen and select Customize to display the Customize Toolbar dialog box.

Use the Up and Down buttons to move buttons within or between the Always Visible and Overflow panes.

Click the Default button to restore the default configuration on the toolbar.

User interface map. See the next figure for a description of the elements of the user interface. These elements provide complete control of the instrument.

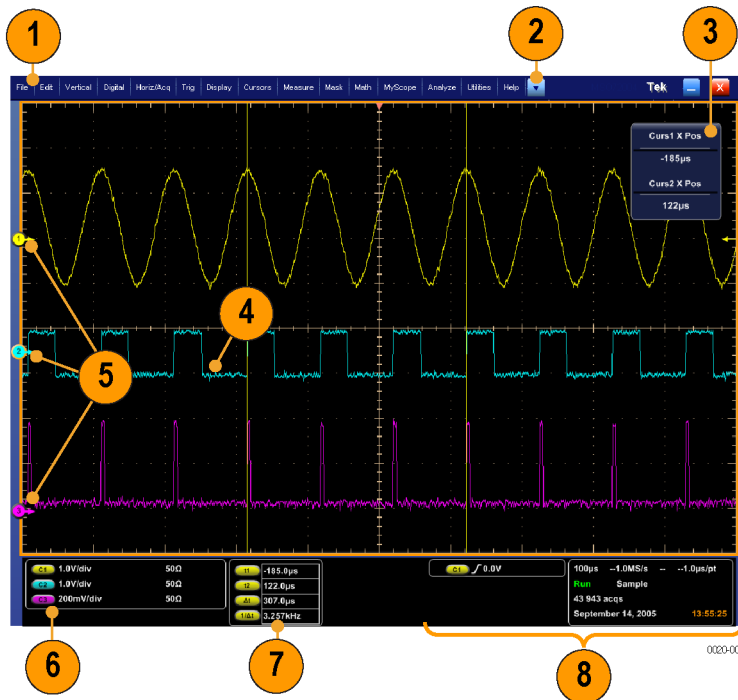

1. **Menu bar:** Access to data I/O, printing, online help, and instrument functions.
2. **Buttons or Menu bar:** Click to toggle between toolbar and menu bar modes.
3. **Multipurpose knob readouts:** Adjust and display parameters controlled by the multipurpose knobs.
4. **Display:** Waveforms from live, reference, math, and digital channels display here, along with buses and cursors.
5. **Waveform handle:** Click and drag to change the waveform vertical position.
6. **Controls status:** Quick reference to vertical selections, scale, and parameters. Probe status is provided for some probe tips. TekConnect events may include Tip Fault (Line-open, Self-Test Failure of Tip, and Tip broken), Tip Temp Change, Tip Overheating, and Tip Thermal Shutdown.
7. **Readouts:** Display of cursor and measurement readouts in this area. You can select measurements from the menu bar or toolbar.
8. **Status:** Display of acquisition status, mode, and number of acquisitions; trigger status; date; time; quick reference to horizontal parameters.

Online help. The online help is designed to assist you with all the features of the instrument.

Context-Sensitive help. Use the instrument online help to quickly get information about a function or assistance in performing a task:

- In Toolbar mode, click Help to display online help for the active window.
- From the menu bar, click Help to display a list of help options.
- If you are using the touch screen, you can touch the Help button in either mode.
- The keyboard F1 function key displays help for the active window in either mode.

Microsoft Windows Help. Help is also available as part of Windows. For information about Windows features, refer to the Windows online help by clicking Start in the Windows toolbar, and then selecting Help and Support.

What do you want to do next?

[Learn how to navigate the online help.](#)

[Find out what other documents are available.](#)

[Learn how to contact Tektronix Support.](#)

[Provide feedback on this Tektronix product.](#)

[Provide information about Tekscope](#)

Navigating the online help. To open the online help select Help, and then select Contents and Index. From the online help finder, select one of the following tabs:

- **Contents Tab.** Click any entry to display information on the subject.
- **Index Tab.** Double-click an entry to display information on the subject. Or, enter a keyword you are looking for (the list scrolls to that topic). Click Display to open the topic.
- **Search Tab.** Type in the keyword you are looking for; then click List Topics. Every topic that contains the keyword will be displayed. Select a topic, and then click Display to open the topic.
- **Favorites Tab.** To save the current topic to the Favorites list, click the Favorites tab; then right-click and select Add. Double-click to return to a topic at any time.

What do you want to do next?

[Find out what other documents are available.](#)

Basic operations

Preventing ESD. A direct electrostatic discharge can damage the instrument input. To learn how to avoid this damage, read the following information.

Electrostatic discharge (ESD) is a concern when handling any electronic equipment. The instrument is designed with robust ESD protection, however it is still possible that large discharges of static electricity directly into the signal input may damage the instrument. To avoid damage to the instrument, use the following techniques to prevent electrostatic discharge to the instrument.

1. Discharge the static voltage from your body by wearing a grounded antistatic wrist strap while connecting and disconnecting cables and TekConnect adapters. The instrument provides a front panel connection for this purpose.

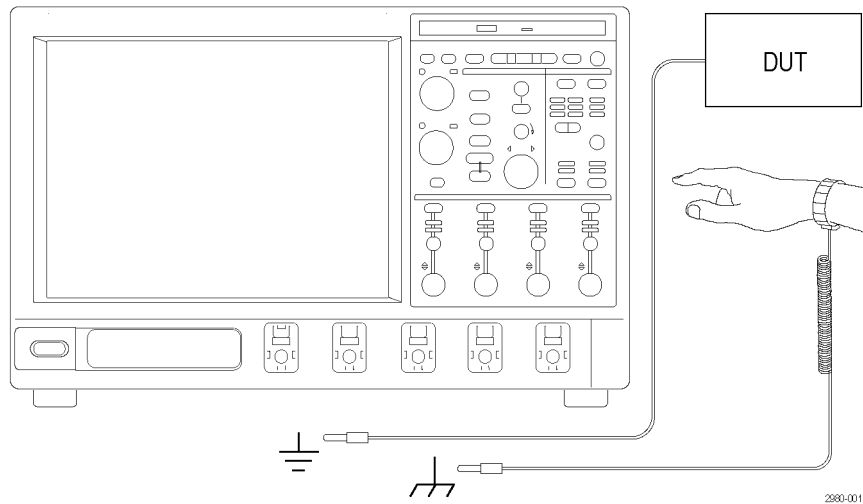
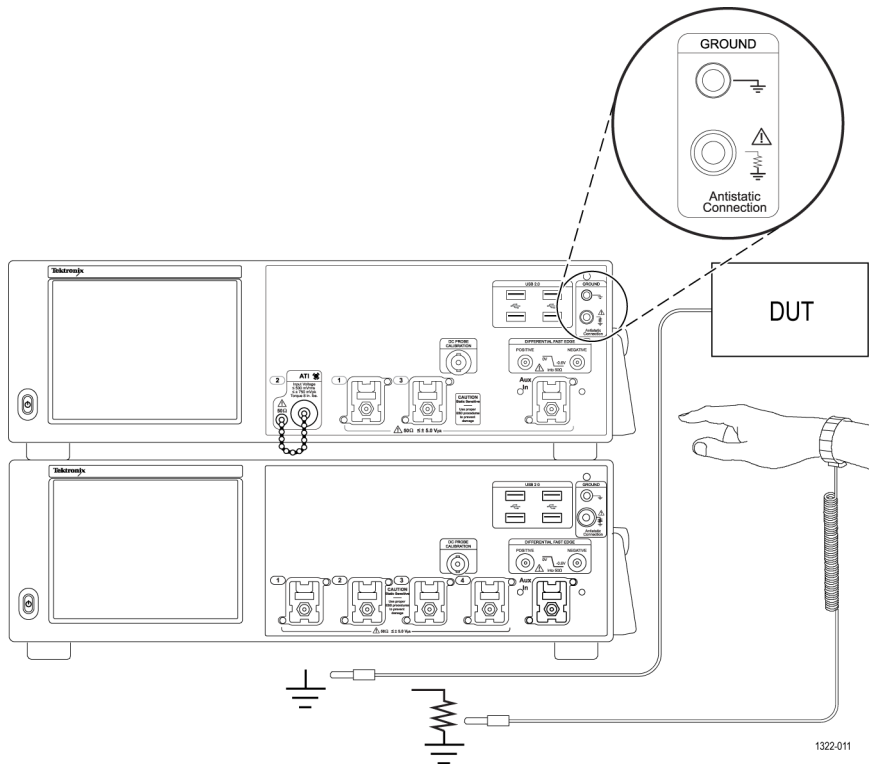

2. A cable that is left unconnected on a bench, or carried across a room, can develop a large static charge. Discharge the static voltage from all cables before connecting them to the instrument or device under test by momentarily grounding the center conductor of the cable, or by connecting a 50 Ω termination to one end, before attaching the cable to the instrument.

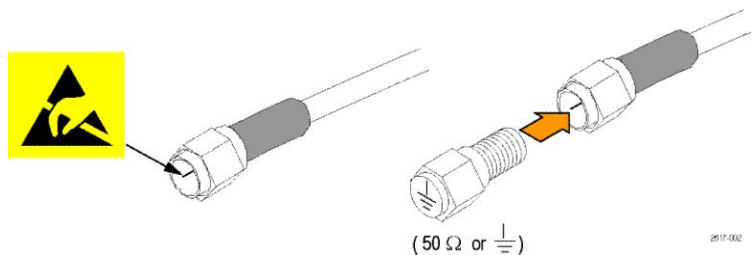



CAUTION. Do not use a tool (such as a screwdriver, wrench end, etc) to short the center conductor to the ground shell on the connector, as any sort of scratch or nick may damage the RF response of the cable.

ESD precautions. To avoid damage to the instrument, observe the following ESD (electrostatic discharge) precautions:

- Before you apply power, connect the instrument to an electrically-neutral reference point, such as earth ground. To do this, plug the three-pronged power cord into an outlet grounded to earth ground.
- If you are working with static sensitive components, ground yourself. Static electricity that builds up on your body can damage static-sensitive components. Wear a wrist strap to safely send static charges on your body to earth ground.

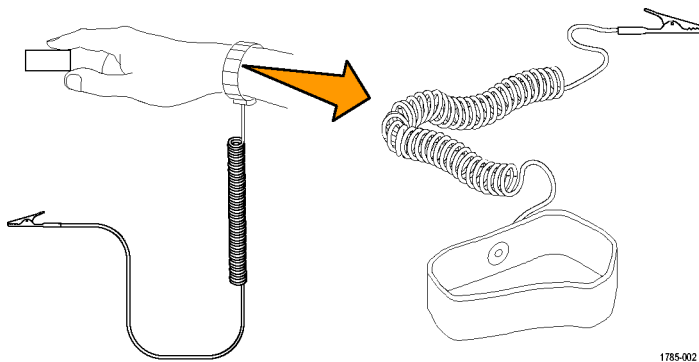

Grounding the oscilloscope is necessary to ensure safety and to take accurate measurements. The oscilloscope must share the same ground as any circuits that you plan to test.

Observe maximum input voltage. Observe all terminal ratings. To avoid damaging the instrument, observe all rating and markings on the product. Consult the product manual for further ratings information before making connections to the product.

Do not apply a potential to any terminal, including the common terminal, that exceeds the maximum rating of that terminal.

The maximum input voltage for the ATI (Asynchronous Time-Interleaved) input is $\pm 0.75 V_{pk}$. This is the maximum voltage before damage occurs.

The maximum input voltage for the TekConnect inputs is $\pm 1.5 V$ relative to the termination bias (30 mA maximum) on $\leq 1.2 V$ full scale settings and 8 V on $>1.2 V$ full scale settings.

Selecting the proper attenuator. The ATI input has a maximum voltage range of 300 mV_{FS}. Use of an attenuator can increase the maximum voltage range.

Table 1: Maximum ATI voltage range

| Attenuator | Maximum ATI voltage range |
|----------------------------------|---------------------------|
| None | 300 mV _{FS} |
| 3 dB | 420 mV _{FS} |
| 6 dB | 600 mV _{FS} |
| 10 dB | 950 mV _{FS} |
| 16 dB (6 dB + 10 dB attenuators) | 1.88 V _{FS} |
| 20 dB | 3 V _{FS} |

Connector cleaning. All connectors must be kept clean. Dirt in connectors can damage the connector and any connectors the dirty connector is used with. Dirt will also likely impair the RF performance. All cables, attenuators, and adapters should be stored with connector covers to keep dust out.

Before each use do the following:

1. Verify that the connectors are free of dirt, metal particles, scratches and deformations.
2. Verify the connectors are the correct size.



WARNING. To avoid eye damage, wear eye protection when using compressed air.

3. With the connector pointed down, use low pressure compressed air, at an angle to the connector, to clean the connectors.
4. If the connector still needs cleaning, use an appropriately sized swab moistened with isopropyl alcohol to clean the connector threads and mating surfaces. Do not snag the center conductor.



CAUTION. Never put pressure on the center pin of the connectors. Applying pressure to the center pin could damage the connector.

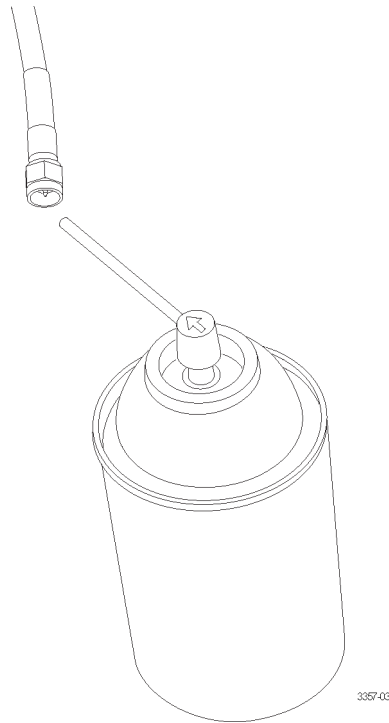

Proper connection technique. Use 8 inch-pounds of torque when making connections to the ATI 1.85 mm connector, SMA connectors, adapters, DC Blocks, or cables. Using the improper torque or connection technique may degrade your signals and damage the connectors.

Use the following procedure to make connections to the ATI input:



CAUTION. Failure to use the supplied backing wrench and torque wrench when making connections to the ATI input may damage your instrument.

1. Discharge the static voltage from your body by wearing a grounded antistatic wrist strap while connecting and disconnecting cables and adapters. The instrument provides a front panel connection for this purpose. Use the ground connection with the black plastic grommet, as this has a 1 M Ω series isolation resistance, so that there is no chance of shock, but the static voltage can be discharged.

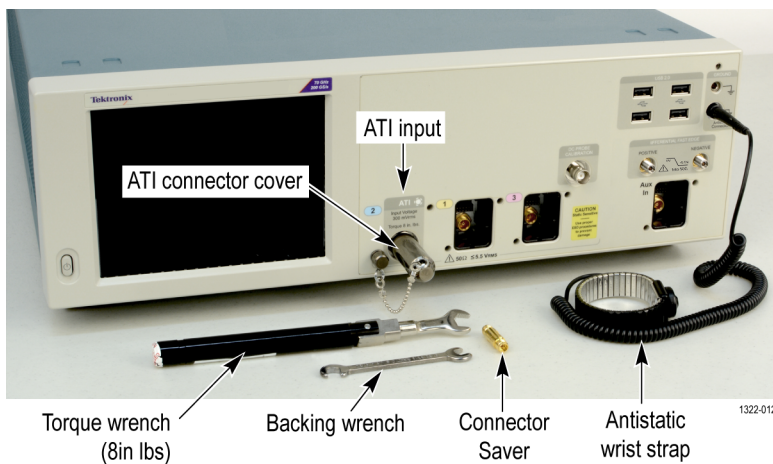
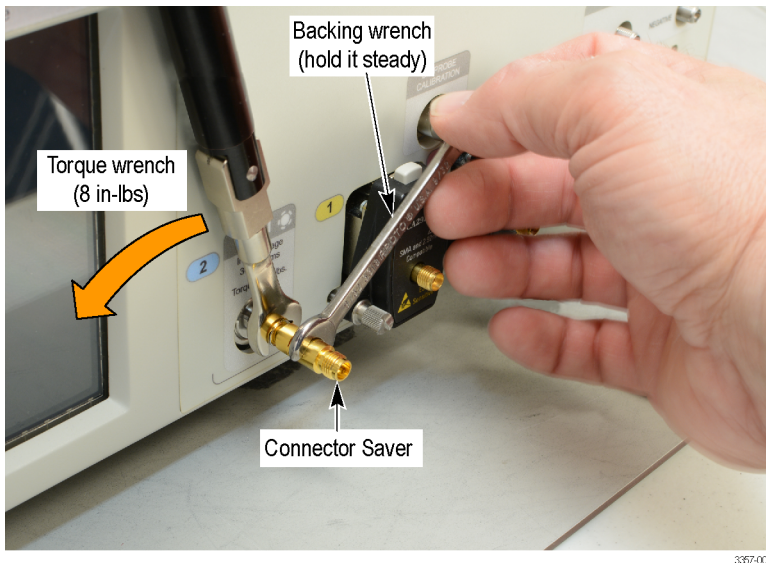

Figure 1: Wear an antistatic wrist strap

2. Use the supplied connector saver to protect the instrument connector. When not in use, protect against dirt and ESD damage by installing the end cap. Alternate locations to store the ATI protective cover include the upper right corner of the front panel and to the right of the audio connectors on the rear panel. When installing the connector saver tighten to 8 inch-pounds.



CAUTION. The connector saver can appear to tighten/loosen opposite to expectations because the oscilloscope ATI input connector is a male connector.



3357-002

Figure 2: Installing a connector saver

3. Use the backing wrench on the connector saver to prevent damage caused by rotation of the connectors when installing a connector.
4. Use the supplied torque wrench to tighten (8 inch-pounds) your cable connector to the connector saver.

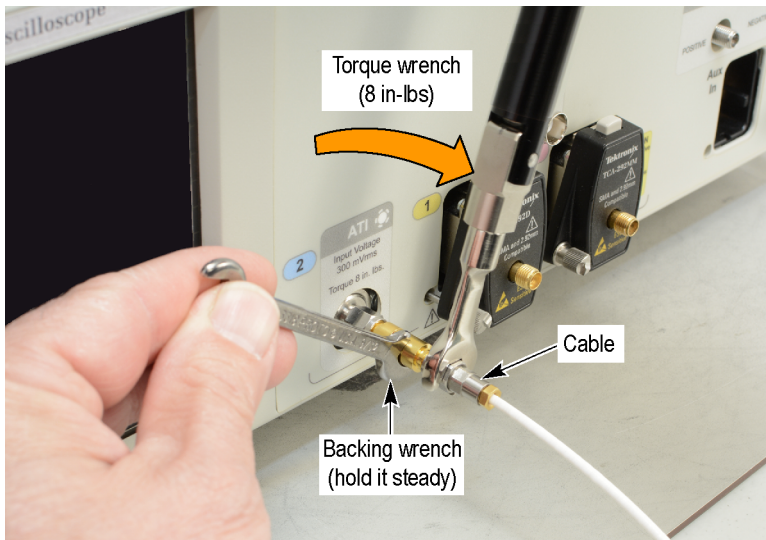

3357-003

Figure 3: Installing a cable



CAUTION. Failure to prevent rotation of the center conductors when making connections to the AT1 input will damage your instrument. If necessary use a second backing wrench on the cable, to prevent its rotation. Use the supplied torque wrench to tighten (8 inch-pounds) all connectors.

5. If necessary use a second backing wrench on the cable, to prevent its rotation.

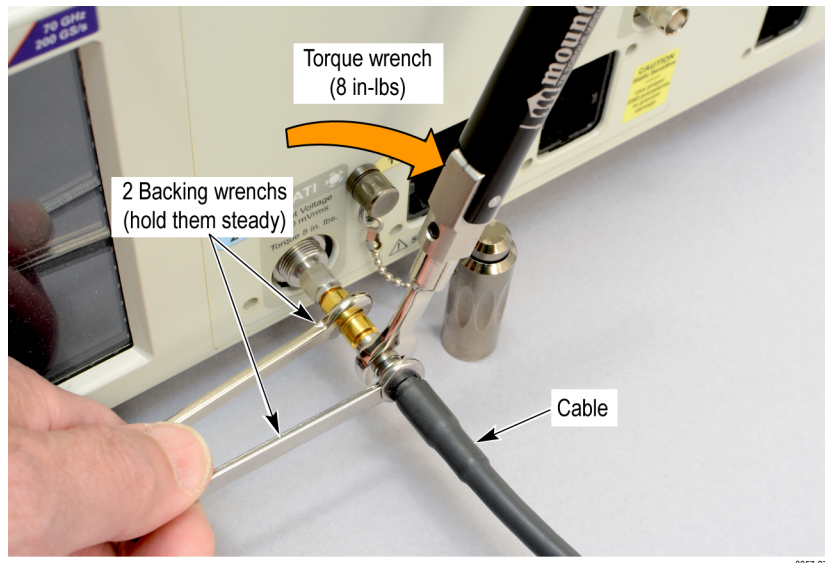

Figure 4: Use a second backing wrench

Changing control settings. As you configure the instrument, you may need to set a numerical parameter such as a reference level or delay time.

There are several different ways to set these parameters in a control window (On DPO70000SX instruments, front panel control knobs are available on the optional DPO7AFP accessory):

- Touch or click the parameter to select it. Once selected, one of the *multipurpose knobs* is assigned to the parameter.
- To adjust a setting, turn a front panel upper knob (a) or lower knob (b) as indicated by the knob graphic indicator next to the control window parameter.
- Push the front panel Fine button to use the knob to make small changes, for example to add another decimal place for greater accuracy.

This online help usually refers to using the multipurpose knobs to change control settings, although the following methods are generally available:

- Some parameters with discrete values have increment/decrement buttons. Touch or click them to change to the next available value.
- Some parameters supply a pop-up keypad or keyboard that you can use to enter a new value. Some features provide other pop-up keypads.
- If you have an external keyboard attached, you can also use it to type in a new value.
- You can also adjust parameter values using the mouse wheel. Press the mouse wheel to access fine mode. Press it again to return to normal mode.

Multipurpose knobs



The multipurpose knobs on MSO/DPO5000B Series instruments are as follows:

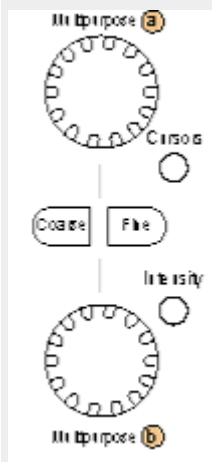

Graphic indicator

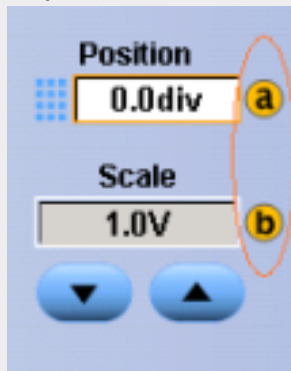

Increment/Decrement buttons

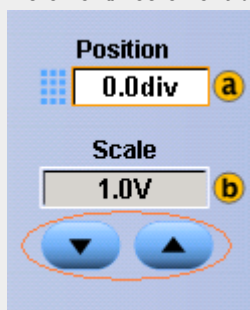

Pop-up keypad

1. Double click in a data entry box, or:

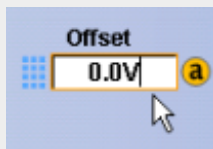

- Click in a data entry box.



- Click on the keypad icon.

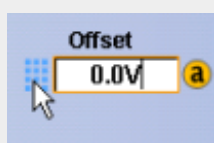

2. Use the pop-up keypad to enter data.

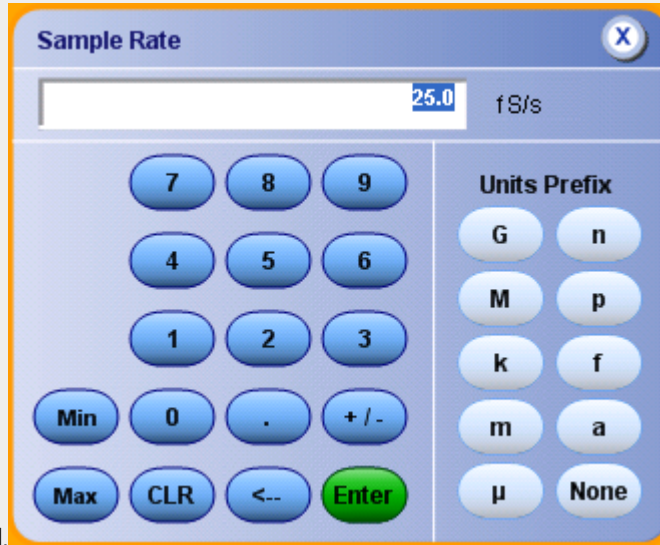

Sample Rate Keypad.

3. Click the Enter Button.

Other keypads

- 1.

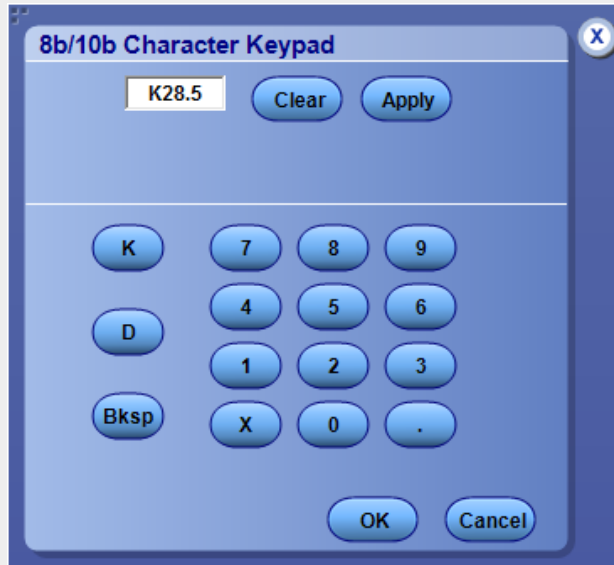

8b10b Character Keypad.

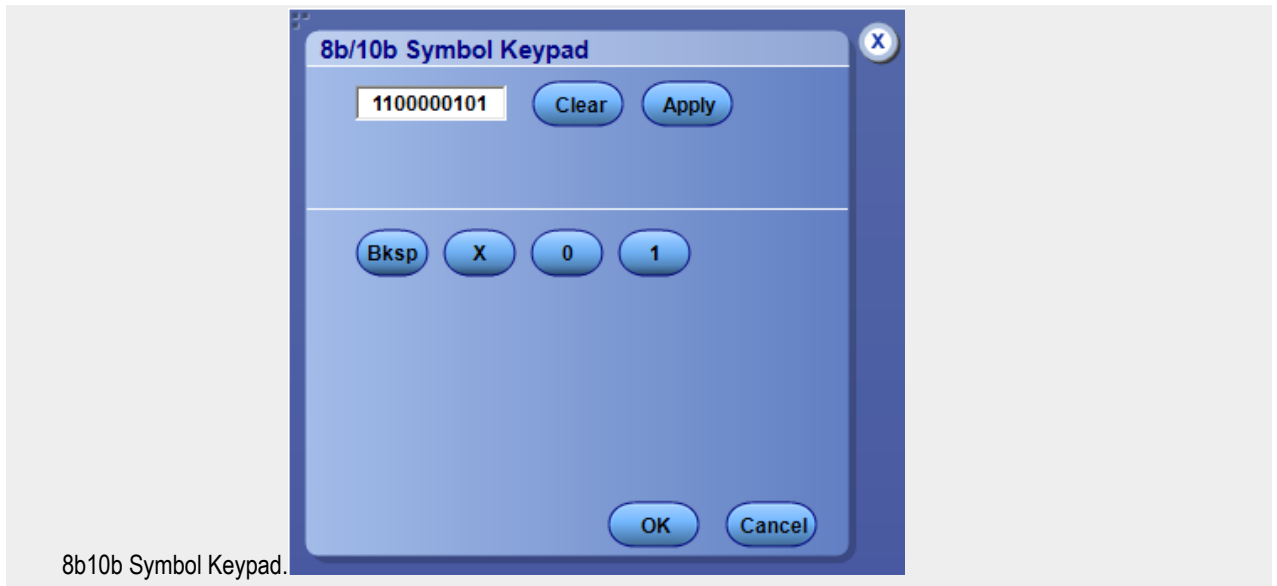

Moving and docking control windows. Control windows that open on the lower half of the screen can be moved to any location. To do this, move the cursor to the upper left-most corner of the window until the hand appears. Left-click the mouse button to grab the *handle*. Hold the button and drag with the mouse to another position on the screen.

You can move freely to any position on the screen or to a second monitor (if you have set up a dual display) by dragging the window. All controls on the window can be accessed and function as usual.

NOTE. The window cannot be resized.

Control window handle

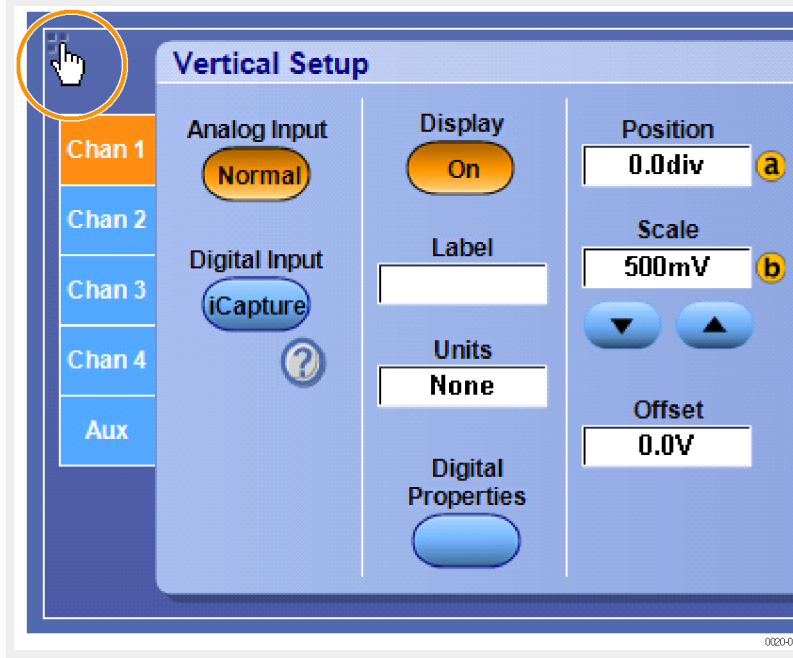

Controlling from within the graticule area. Use the mouse or your finger in the graticule area to click and drag (or touch and drag) the following:

- An on-screen cursor to another position on the waveform.
- A waveform handle to change the vertical position of a waveform.
- A waveform label or other screen text that you have entered to reposition it.
- The horizontal reference marker to set the horizontal position.
- The trigger level marker to set the trigger level.

You can also click and drag (or touch and drag) across part of a waveform to select it and investigate it further. Once the selection is made, choose one of the following actions:

- Create a Zoom waveform that covers just the selected area
- Create a histogram to analyze the selected area
- Turn on measurement gates that take measurements only in the selected area
- Create a visual trigger area.
- Cancel the selection

Waveform handle



Waveform label

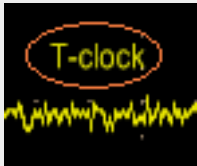

Horizontal reference marker



Trigger level marker

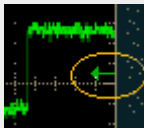

Accessing shortcut menus by right-clicking. You can right-click to gain quick access to most common commands.

Right-click on a graticule, an object, or a readout to access their shortcut menus. The menus are dynamic; their contents will vary, depending on the area or the object you right click.

You can right-click on any of the following to open a dynamic shortcut menu:

- Waveform handle
- Cursors
- Labels
- Histogram display
- Masks
- Templates
- Trigger level marker
- Visual trigger area
- Readouts (the menu varies with the type of readout)
- Graticule
- Control window
- Entry boxes
- Regions (Menu bar, Toolbar, Multipurpose Knobs)

Creating your own control windows. For quick access to the controls that you use most often, you can create your own [MyScope control window](#). Choose from a list of controls to include, and make each control window unique to your needs.

MyScope allows you to have up to eight tabs in a control window, increasing the flexibility and ease of use for your unique MyScope control windows. You can create and save any number of control windows for future use.

Initialize the instrument. After you complete a task, you may want to initialize the instrument settings before using the instrument with your next task. This may be especially important if you share the instrument with others; previous settings may make it difficult for you to perform the required task.

To quickly restore the instrument to its default settings, push the front-panel Default Setup button.

Choosing and connecting probes.

To avoid damage to the instrument, observe [ESD \(electrostatic discharge\) precautions](#).

Choose from a wide variety of passive, active, and specialty probes to use with your instrument. The instrument automatically configures the input impedance when you attach a probe that is compatible with the TekProbe or TekVPI interface.

Remember the following when connecting a probe:

- For most passive probes, adjust the low-frequency compensation after you connect them to a channel input.
- To compensate for gain (and offset) error in many probes, connect the probe tip to the probe compensation connectors; then execute the built-in compensation procedure to optimize system accuracy.
- To compensate for propagation delay differences between voltage probes using the probe deskew feature, attach up to two probe tips at a time to the probe compensation terminals; then execute the deskew procedure to time align the display for each channel. The deskew adjustment range is ± 75 ns.

Multi-instrument configuration

Connect instruments in a multi-instrument configuration to create an up to 4 channel, highest bandwidth, and highest sample rate system with synchronized trigger and sample clock.

Instrument stacking. Multiple instruments may be stacked to save space and allow shorter cables and more convenient connections.



WARNING. When using an instrument upside down, be careful to avoid pinching your fingers.

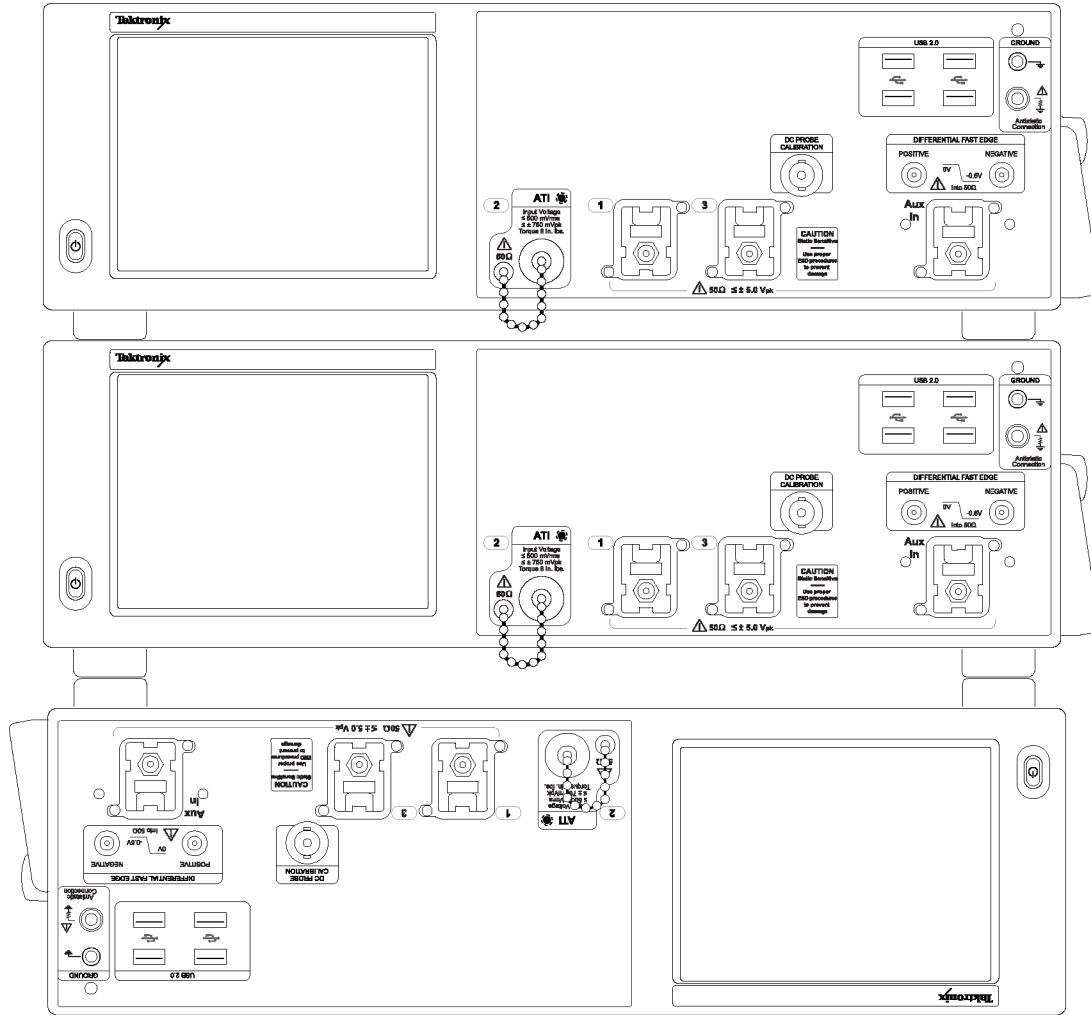

3367-034

Standard orientation of the top feet is useful when placing an instrument inverted on the work bench. Standard orientation of the top feet is also use when stacking an OM4000 on the instrument.



Use the rotated orientation of the top feet to stack two instruments on top of each other.

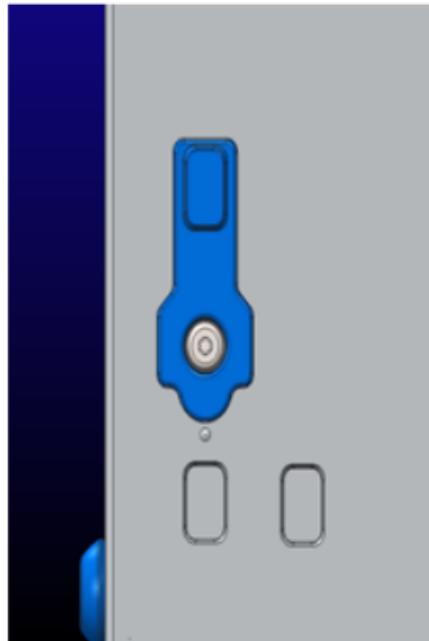

When stacking two instruments, the bottom feet sit in the holes exposed when the top feet are rotated.

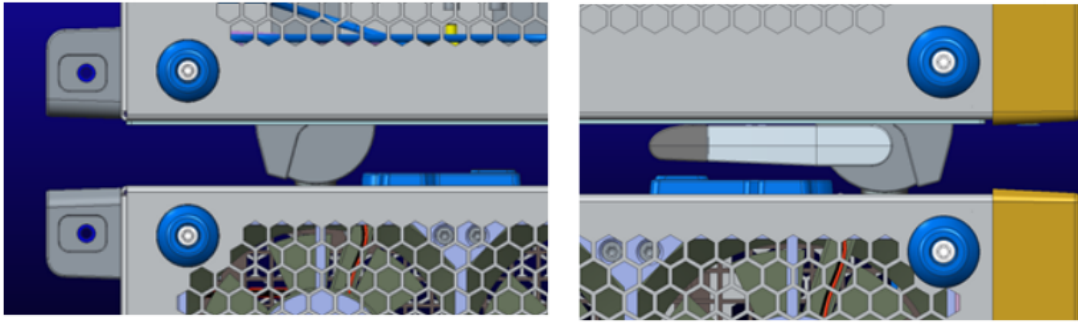

Before startup. All instruments in a multi-Instrument configuration must be connected properly before powering on the instruments. If the configuration is changed after the instruments are powered on, a system restart may be required.

If an instrument is not connected in a multi-instrument configuration, the instrument powers on in its stand alone mode, not multi-instrument mode.

UltraSync™ bus cable. An UltraSync bus cable will connect any multi-instrument configuration capable instrument.

All cables must be connected to the instruments prior to power up. A restart will be required if the instruments are turned on before the cables are connected.

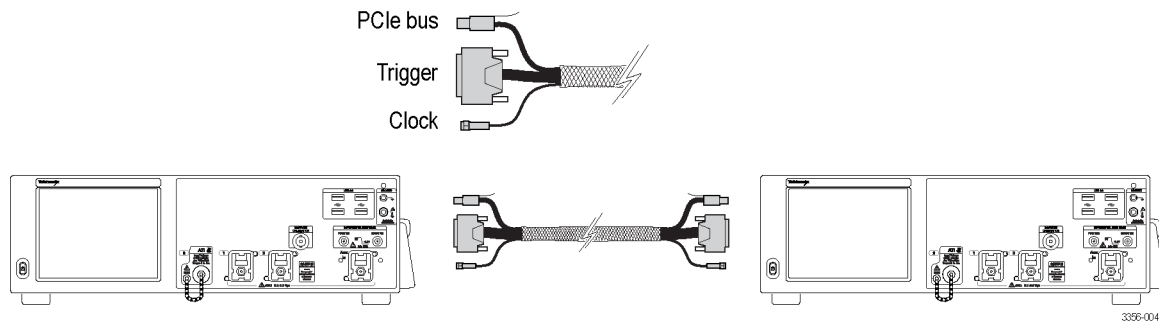

UltraSync™ bus cable connection order. Connect UltraSync bus cable bundles to the Master:

1. Select which instrument will be the Master instrument.

At the Master instrument connect each UltraSync cable bundle set to the designated ports (start with the To Extension B ports; then if connecting a third instrument use the To Extension C ports, and then if connecting a fourth instrument use the To Extension D ports):

2. Connect the clock cable to the 12.5 GHz Clock Out connector (8 in-lbs torque).
3. Connect the Trigger cable to the Trigger connector.
4. Connect the PCIe cable to the PCIe connector.

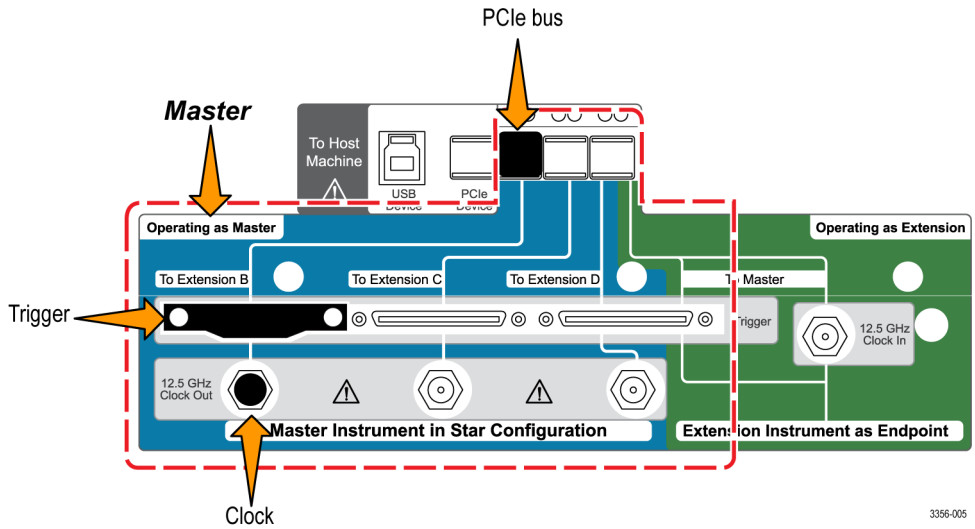

Connect UltraSync bus cable bundles to the Extension.

At the Extension, connect each UltraSync cable bundle set to the designated ports:

1. Connect the clock cable to the 12.5 GHz Clock In connector (8 in-lbs torque).
2. Connect the trigger cable to the To Master Trigger connector.
3. Connect the PCIe cable to the PCIe connector

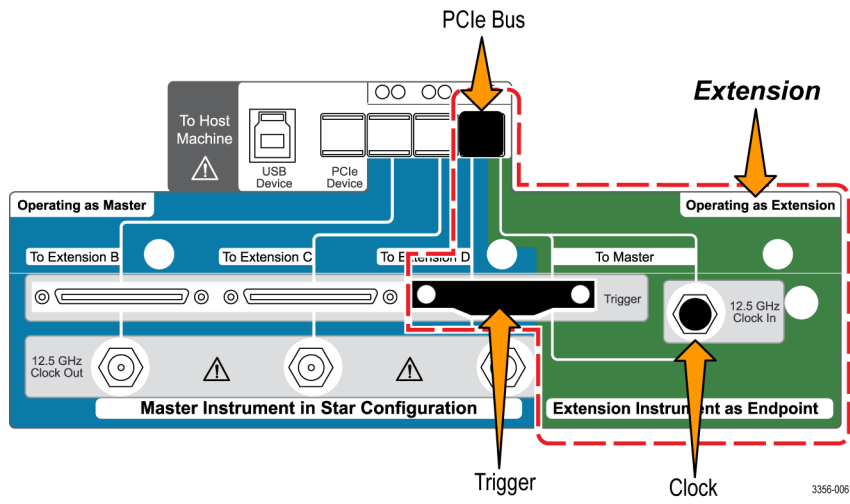

Master and extension connection order. Connect each extension instrument to the master instrument sequentially from left to right (Extension B, C, and then D).

NOTE. Connect the extensions to the master in a star pattern, do not daisy chain the instruments.

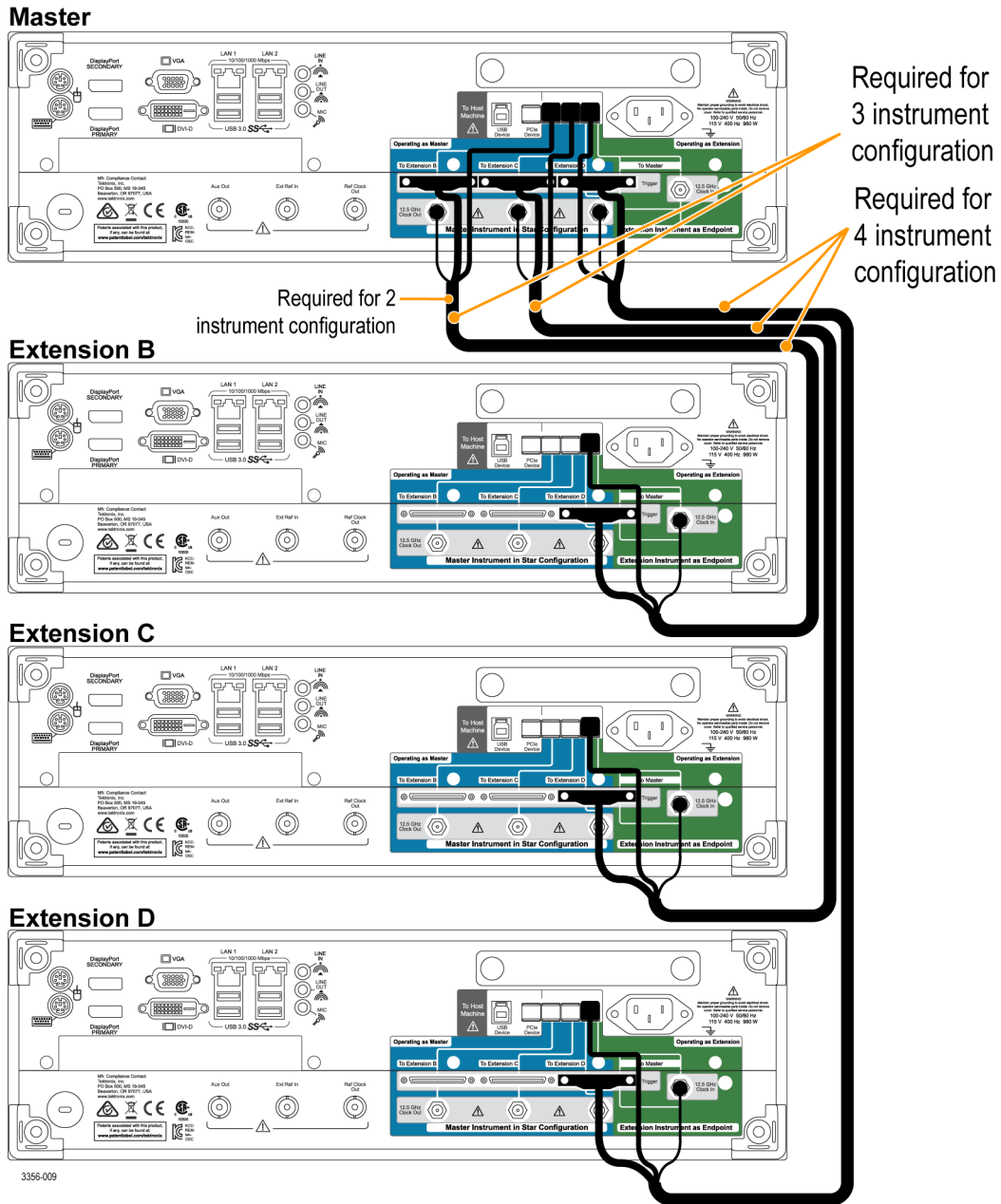

If powering off a multi-instrument system, power off the master first.

Multi-instrument power on. During the start-up process the instrument checks to see if instruments are connected in a Multi-instrument configuration. If instruments are not connected, the instrument powers up in stand-alone mode. If instruments are connected, the configuration is validated. If the configuration is not valid, guidance is provided to help you create a valid configuration.

NOTE. After successful power on of your multi-instrument system, wait for the warm-up time to complete, and then run Signal Path Compensation.

The following image shows an extension with a connection that is invalid and provides guidance to correct the connection (provide the missing connection to the master).

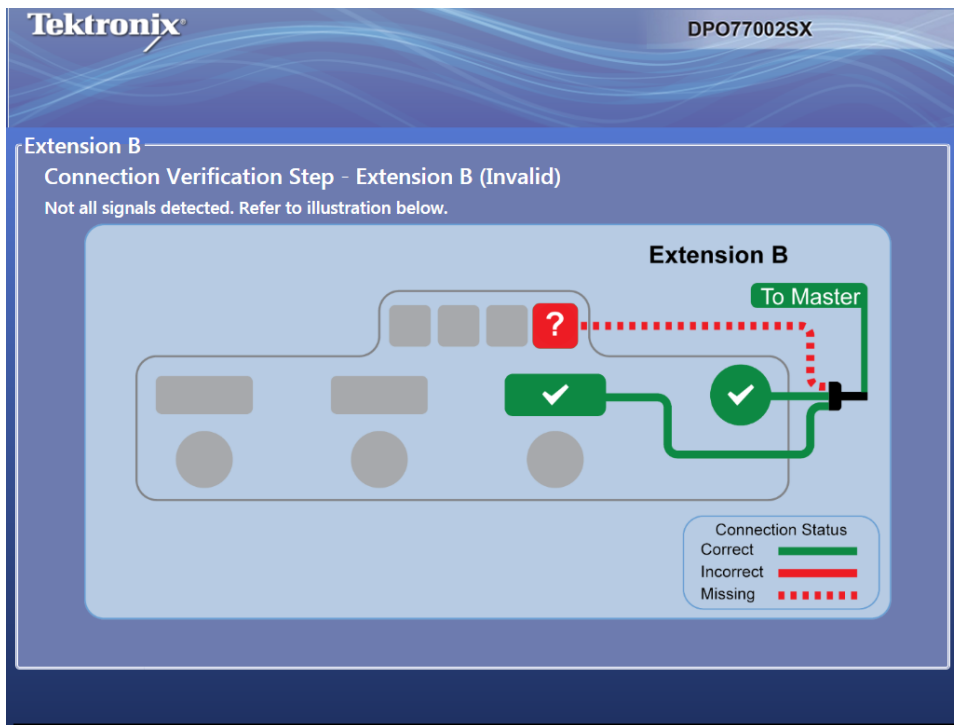

The following image shows a master connected incorrectly and provides guidance to fix the problem (provide the missing connection to the extension).

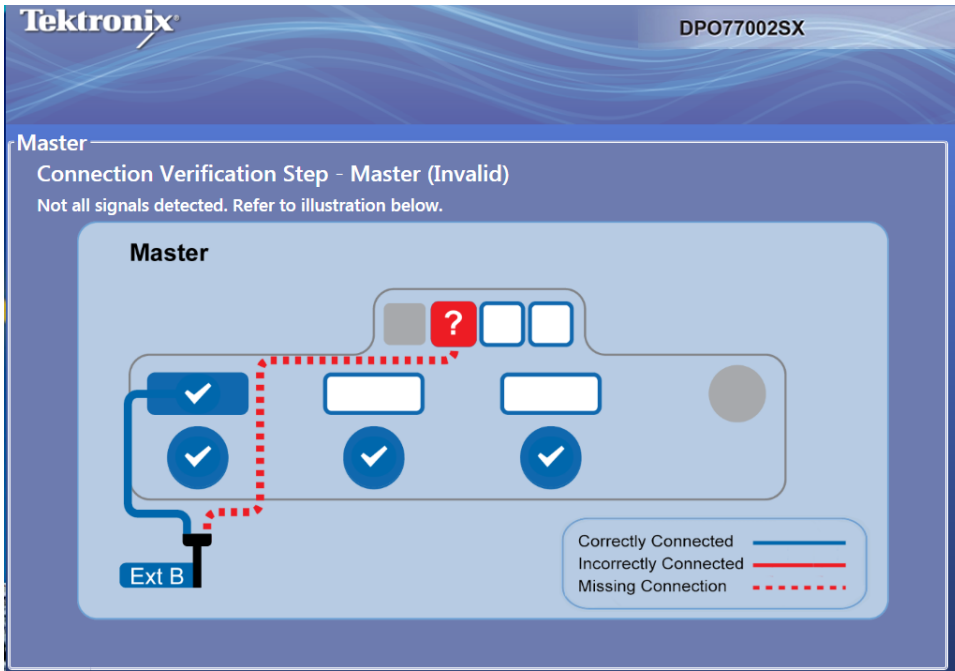

The following images show the master and extension with valid connections.

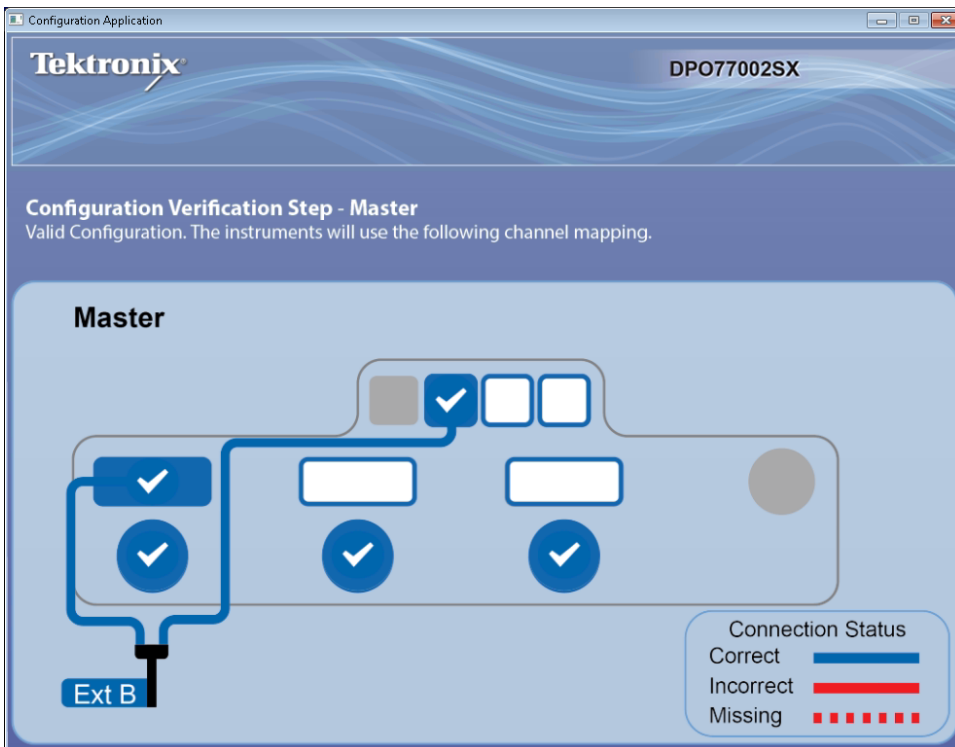

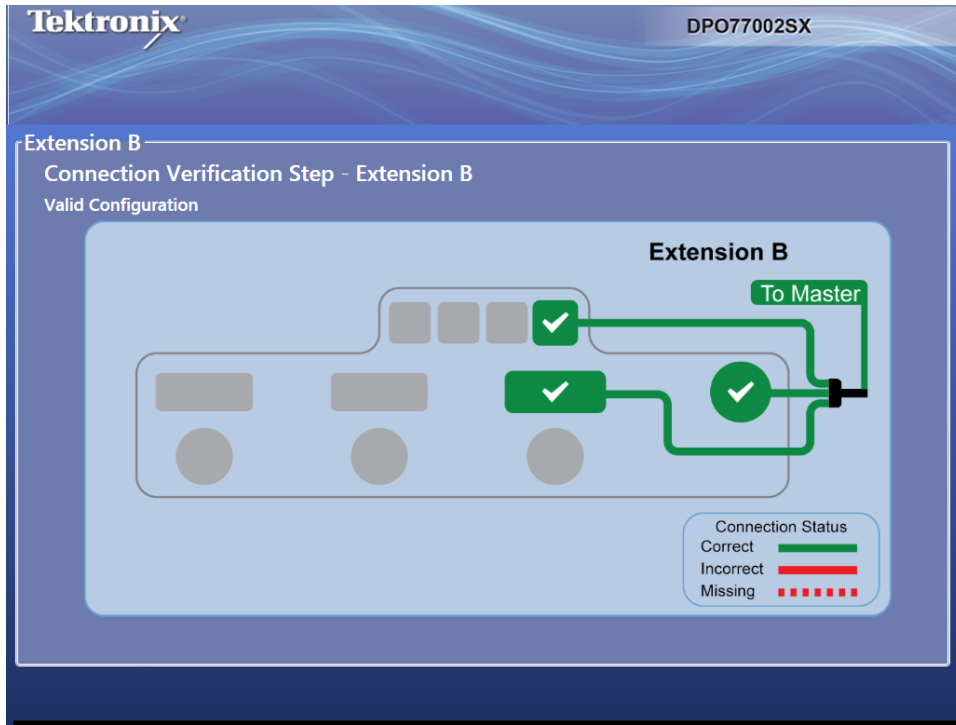

After the multi-instrument connections are verified and the instruments display their operating status displays, the master displays its status and timer display. Pause the timer if you have additional changes to make before the oscilloscope application starts. Press Start Scope to bypass the timer. When the timer runs down, the oscilloscope application starts.

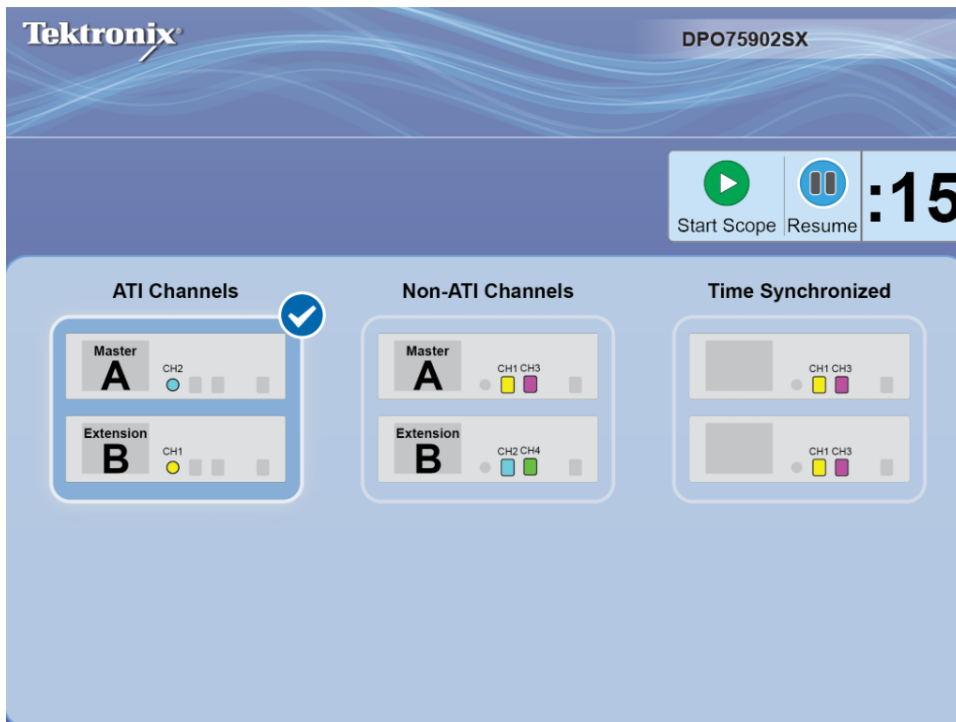

If your multi-instrument configuration includes ATI instruments, you have the opportunity to select either ATI Channels or non-ATI (TekConnect) Channels. In this example ATI Channels are selected.

NOTE. You also have the option to select **Time Synchronized** mode of all TekConnect channels. In this mode acquisitions are time synchronized and the Master controls the horizontal, record length, and trigger settings of all TekConnect channels. To ensure all channels are synchronized, operate the multi-instrument configuration in single sequence mode. Retrieve all TekConnect channel data using programmable interface commands. Waveform data is not sent to the Master. If you plan to use Time Synchronized mode, contact your Tektronix representative for additional information.

After the multi-instrument connections are verified, the instruments display their operating status displays. In this example the Master (A) is acquiring on channel 2 (ATI). The Extension (B) is acquiring on channel 2 (ATI) and is displayed as channel 1.

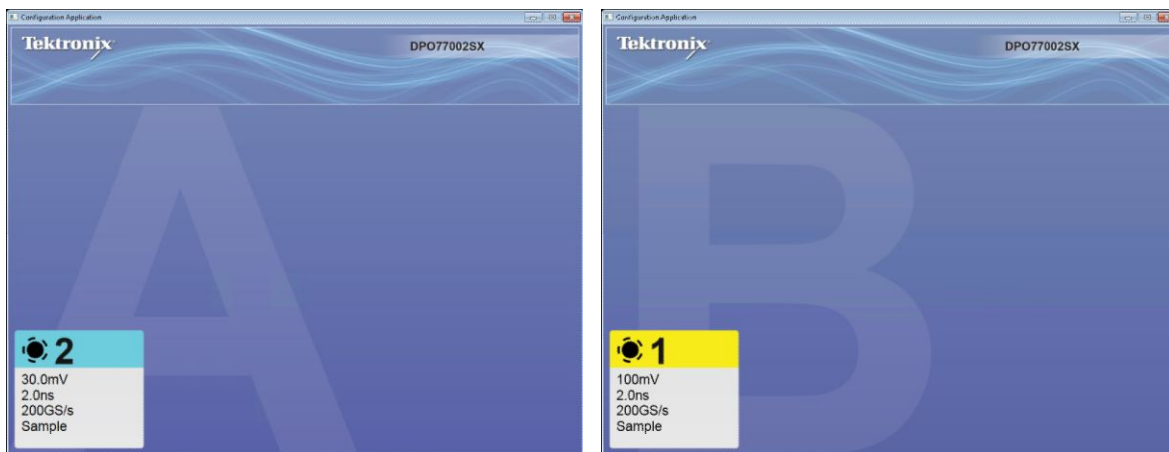

The master display identifies itself as the Master and identifies the channels being acquired.

To switch between the Configuration Application and the oscilloscope display (on the oscilloscope), use Alt-Tab. To close the Configuration Application, click the x. If the x is not visible, make the x visible by double clicking in the upper right hand corner of the Configuration Application.



3357-080

Switching between multi-instrument modes. To switch among ATI channels, TekConnect channels, and Time Synchronized modes, use the following procedure:

1. From the Vertical > Configuration menu select either ATI, TekConnect, or TimeSync.

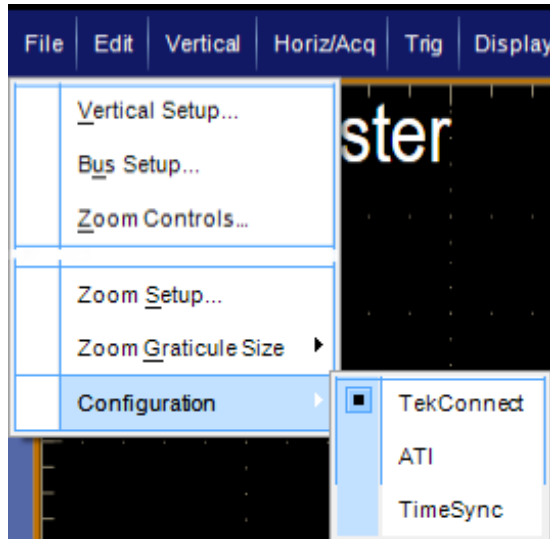

2. Click Yes to continue.

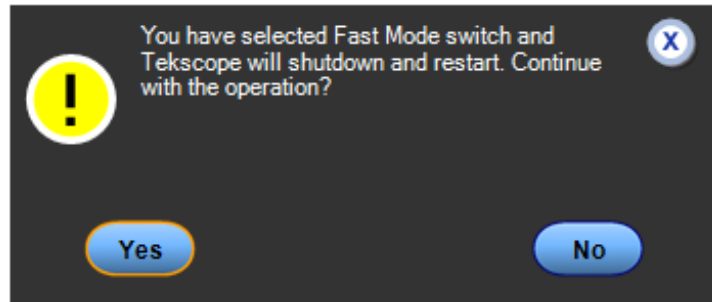

Restart of a multi-instrument system. To restart your multi-instrument system without powering down the oscilloscopes, do the following step:

1. To shut down the Configuration Manager and all of the Scope applications and then restart them without changing the configuration mode, select File > Restart.

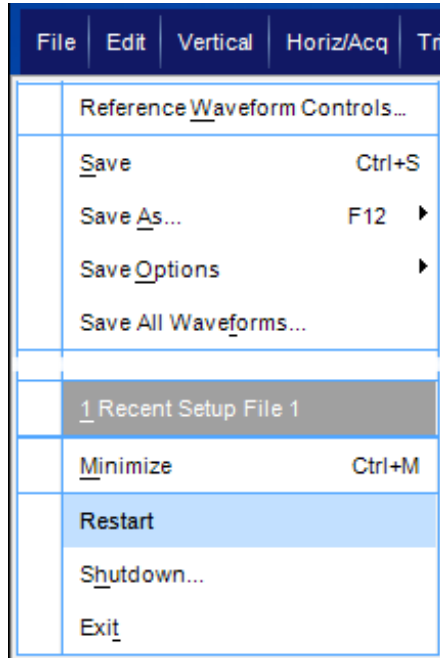

ATI versus TekConnect channels. ATI channels provide up to 70 GHz bandwidth and 200 GS/s sample rate and the lowest noise. When using the ATI channel, the TekConnect channels are not available.

TekConnect channels have up to 33 GHz bandwidth and 100 GS/s sample rate. TekConnect channels offer multiple connection options with TCA adapters, and are compatible with a wide range of performance probes.

Multi-instrument status displays. In a multi-instrument configuration, the display shows status information such as: channel numbers, on/off, run/stop, Arm/trig'd, and UltraSync connectivity information. The master instrument also displays the trigger setup and the channels being acquired and displayed.

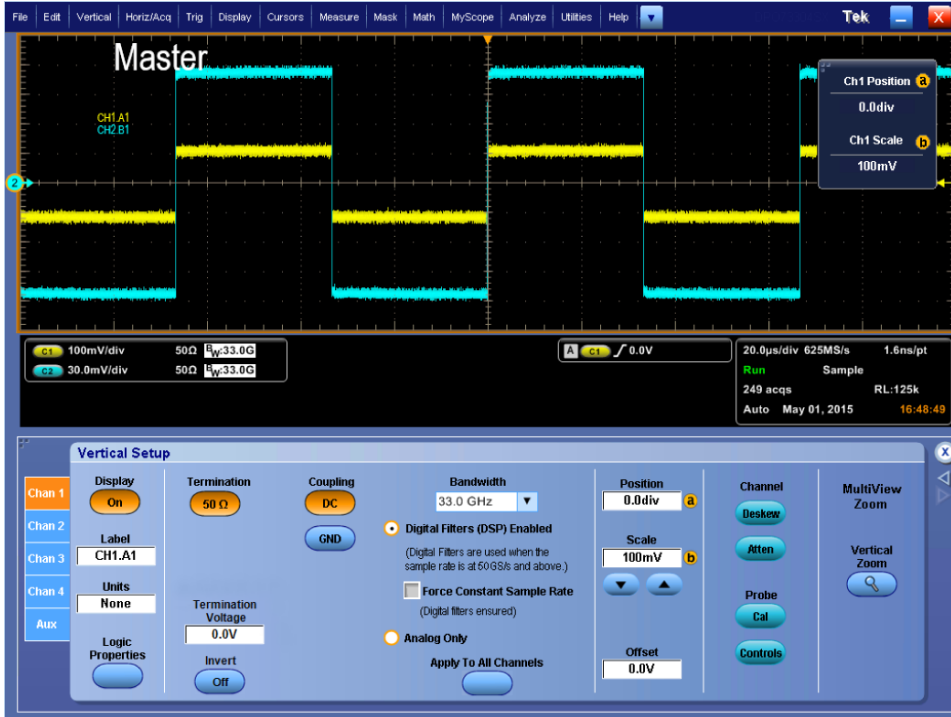

3357-080

Available features. Features discussed in this manual that are available on some instruments or configurations are noted in the tables.

Table 2: Stand-Alone instrument

| Feature | DPO77002SX | DPO75902SX | DPO75002SX | DPO73304SX | DPO72304SX |
|---------------------------------|----------------------------------|----------------------------------|----------------------------------|------------|------------|
| State (Clocked Pattern) trigger | Available on TekConnect channels | Available on TekConnect channels | Available on TekConnect channels | Available | Available |
| XYZ mode | Available on TekConnect channels | Available on TekConnect channels | Available on TekConnect channels | Available | Available |
| Equivalent time acquisitions | Available on TekConnect channels | Available on TekConnect channels | Available on TekConnect channels | Available | Available |
| HiRes and peak detect | Available on TekConnect channels | Available on TekConnect channels | Available on TekConnect channels | Available | Available |
| FastAcq | Available on TekConnect channels | Available on TekConnect channels | Available on TekConnect channels | Available | Available |
| Roll mode | Available on TekConnect channels | Available on TekConnect channels | Available on TekConnect channels | Available | Available |
| IRE and MV graticule modes | Available on TekConnect channels | Available on TekConnect channels | Available on TekConnect channels | Available | Available |

DPO7AFP Auxiliary Front Panel (optional)

The DPO7AFP is an optional plug-in panel that provides physical knobs and buttons to control the DPO70000SX series oscilloscope. To connect the DPO7AFP:

1. Close the TekScope application.

NOTE. The TekScope application must be closed before connecting the DPO7AFP.

2. Plug the DPO7AFP into any USB port on the DPO7000SX. Wait until the Windows OS recognizes and loads the required drivers.
3. Start the TekScope application. The panel LEDs will light when TekScope connects to the panel.
4. To verify that the DPO7AFP is working, push any channel button and observe that the TekScope application enables or disables the selected channel

NOTE. If you unplug the DPO7AFP while TekScope is running, you will need to close TekScope, reconnect the DPO7AFP, and restart TekScope to use the DPO7AFP.

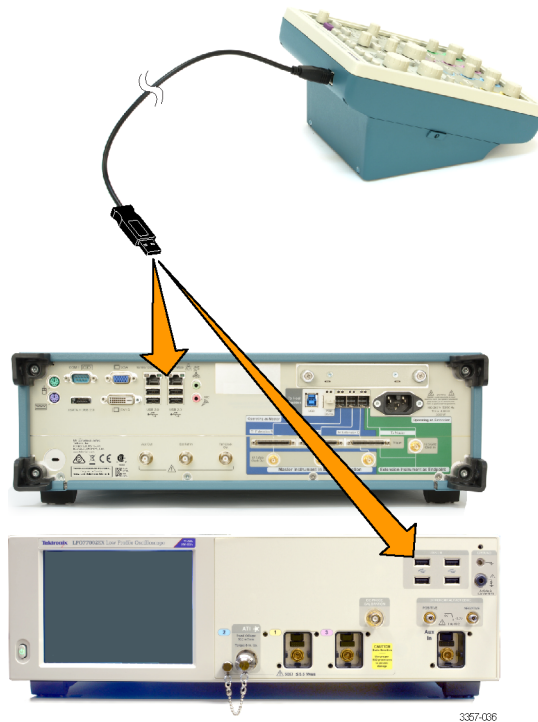

Waveform operations

Triggering timebase and horizontal delay. The architecture of an analog oscilloscope requires its time bases and triggering to be linked. The main trigger triggers the main time base, and then you can use a delayed trigger to trigger a delayed time base. Many digital oscilloscopes have also been designed using this traditional, but complex, paradigm.

This instrument uses a simpler paradigm that cleanly separates the concepts of triggering and time bases. You can still do everything that you could with an analog oscilloscope and more. Now these features are easier to set up and use.

The trigger event can be simple or complex. Examples of a simple trigger are the rising edge of the Channel 1 signal or a glitch narrower than 10 ns on Channel 2. You can set up a complex trigger where the trigger system is armed by a condition on one channel and then is triggered by a condition on another channel. In either case, simple or complex, there is just one trigger event.

The time base can be either delayed or not delayed. If it is not delayed, acquisition occurs surrounding the trigger event depending on the amount of pretrigger and posttrigger data that you have selected. If you turn on horizontal delay, you can delay the acquisition to a point well beyond the trigger event (similar in effect to a delayed time base). By alternately turning horizontal delay on and off, you can make quick, detailed comparisons between two segments of a signal that are separated from each other by a fixed amount of time. In any case, the time base is always triggered by one trigger event.

Pretrigger data

The data points of the waveform acquired and displayed before the trigger event. You can set the amount of pretrigger data with the Horizontal Position control.

Posttrigger data

The data acquired and displayed after the trigger event. You can set the amount of pretrigger data with the Horizontal Position control.

Looking at waveform details. Use the instrument Zoom function to magnify an acquisition vertically, horizontally, or in both dimensions to let you see the fine detail in your signals. The MultiView Zoom function affects only the display, not the actual waveform that is being acquired.

Set up Zoom. The fastest way to set up a MultiView Zoom display is to click (or touch) and drag across the segment of the waveform that you want to see in greater detail. Then, when you touch or click the on-screen Zoom menu item, that waveform appears in the Zoom (lower) graticule, while the entire waveform appears in the Acquisition (upper) graticule. Markers in the main graticule give you position context for what you are seeing in the Zoom graticule.

Another way to set up the MultiView Zoom function is to push the front-panel MultiView Zoom button. Then you can set parameters in a control window to focus your Zoom waveform on the signal segment of interest.

NOTE. If zoom is on but the readouts are not attached to the zoom controls, press the MultiView Zoom button to attach the readouts to the zoom controls. Press the MultiView Zoom button again to turn zoom off.

To see more waveform detail you can also use horizontal delay (as described in the previous topic) to focus the acquisition on a segment of a waveform separated from the trigger event by a significant interval of time. This technique lets you increase the horizontal resolution (sample faster) on a segment of a signal, even when you cannot trigger on that particular segment.

Zoom function. The Zoom function also allows you to zoom on multiple areas of a waveform or on multiple waveforms simultaneously. You can lock the zoomed areas and scroll through them together or unlock the zoomed areas and scroll through them independently.

On-screen MultiView Zoom menu item

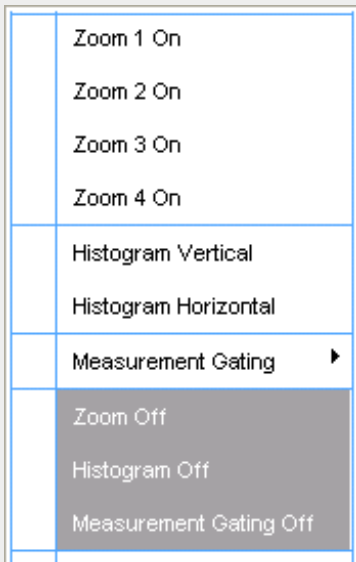

Front-panel MultiView Zoom button



Triggering, timebase, and horizontal delay

The architecture of an analog oscilloscope requires its time bases and triggering to be linked. The main trigger triggers the main time base, and then you can use a delayed trigger to trigger a delayed time base. Many digital oscilloscopes have also been designed using this traditional, but complex, paradigm.

This instrument uses a simpler paradigm that cleanly separates the concepts of triggering and time bases. You can still do everything that you could with an analog oscilloscope and more. Now these features are easier to set up and use.

The trigger event can be simple or complex. Examples of a simple trigger are the rising edge of the Channel 1 signal or a glitch narrower than 10 ns on Channel 2. You can set up a complex trigger where the trigger system is armed by a condition on one channel and then is triggered by a condition on another channel. In either case, simple or complex, there is just one trigger event.

The time base can be either delayed or not delayed. If it is not delayed, acquisition occurs surrounding the trigger event depending on the amount of pretrigger and posttrigger data that you have selected. If you turn on horizontal delay, you can delay the acquisition to a point well beyond the trigger event (similar in effect to a delayed time base). By alternately turning horizontal delay on and off, you can make quick, detailed comparisons between two segments of a signal that are separated from each other by a fixed amount of time. In any case, the time base is always triggered by one trigger event.

Pretrigger data

The data points of the waveform acquired and displayed before the trigger event. You can set the amount of pretrigger data with the Horizontal Position control.

Posttrigger data

The data acquired and displayed after the trigger event. You can set the amount of pretrigger data with the Horizontal Position control.

Using fast acquisition and DPO. When you turn on FastAcq, you can acquire up to 250,000 waveforms per second. In fast acquisition mode, the dead time between acquisitions can be very short, approaching that of the finest analog oscilloscopes. Reduced dead time means that your chances of capturing an infrequent event are greatly improved. More time is spent acquiring and displaying your signal. And with the digital phosphor (DPO) technology, you can easily differentiate between the normal shape of your signal and that infrequent anomaly that you want to capture.

As a comparison, high quality analog real-time oscilloscopes can sweep at high repetition rates with little dead time between sweeps, which makes it possible to capture an infrequent event. Typical digital oscilloscopes (DSOs) have relatively long dead times between acquisitions; infrequent events are much more difficult to capture. With fast acquisition and digital phosphor technology, the oscilloscope acquires at a high repetition rate and then overlays the acquired information into a three-dimensional database that is updated on the display 30 times per second.

The digital phosphor oscilloscope shows you not only the displayed waveform, but also the sample density. You can choose to see sample density represented in a color palette or as shades of gray or shades of green. The DPO display in monochrome green bears a strong resemblance to the CRT of a high-quality analog oscilloscope. When you increase waveform brightness with the front-panel Intensity knob, areas of lower sample density appear more clearly.

DPO provides display benefits, whether fast acquisition is on or off. When it is on, DPO helps you identify an infrequent anomaly in a repetitive signal, especially when either the spectral or temporal color palettes are used. The repetitive signal appears in one color and the anomalies appear in another. When fast acquisition is off, DPO improves the waveform display quality when long records are compressed for display with the 1000 horizontal pixels in the graticule. The compression algorithm works with the intensity-graded display to show brighter pixels where many points have been compressed and dimmer pixels where fewer points have been compressed.

Fast acquisition

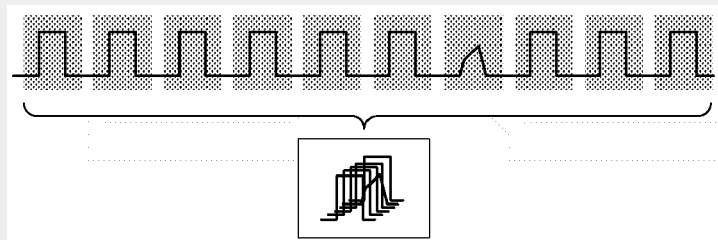

Analog oscilloscope sweeps

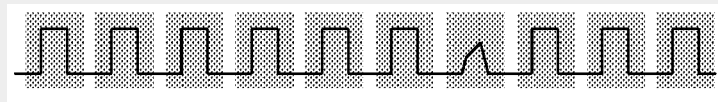

“Dead time” between acquisitions

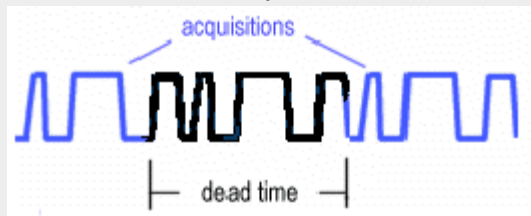

Typical DSO acquisitions

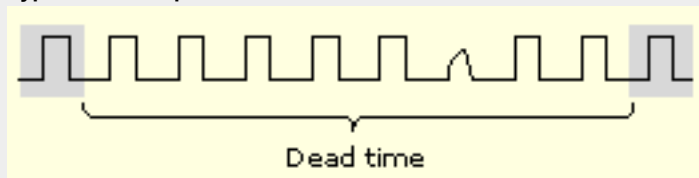

Using logic waveforms. This online help supports many oscilloscope models from Tektronix. This feature is only available on some models.

The instrument can display logic waveforms of analog or digital signals in bus views with bus decoding. You can use digital, analog, and math waveforms to define up to 16 buses (serial or parallel) in the Bus Setup window.

You can use a logic probe to connect the D15-D0 channels to signals in your system under test. If you need more than 16 digital channels in a bus, you can designate Ch1-Ch4 and Math1-Math4 to be logic waveforms in the Bus Setup window.

The instrument acquires and displays data from digital signals as follows:

- Stores a high or low state of the logic waveform for each sample. You can set the voltage threshold level on individual channels.
- Depicts data as a waveform, a busform, or both.
- Decodes data as numeric or symbolic values.
- Displays a logic high level as green and a logic low level as blue.
- Color codes the channel labels and on-screen indicators for the D15-D8 and the D7-D0 channels that follow the color code used on the logic probes.
- Adds custom labels for easier channel-to-signal identification.
- Uses iCapture to display the analog view of up to four signals connected to the logic probe. If you want to see the analog characteristics of signals connected to the logic probe, you can assign up to four of the D15-D0 channels to the Ch1-Ch4 function with iCapture.

NOTE. *iCapture is available on MSO70000C/DX Series instruments.*

What do you want to do next?

[Learn about iCapture.](#)

[Learn about bus setups.](#)

[Learn about digital setups.](#)

Using waveform math. Waveform math in the instrument can be as simple as basic arithmetic or as powerful as building a complicated math expression.

Equation editor. You can build a complicated math waveform expression using multiple waveform sources, constants, variables, operators, and functions. The waveform sources can be any channel, reference, or math waveform.

You can enter constants with a keypad. Live results from the measurement system can be used as variables, and there is a full assortment of arithmetic operators and math functions to use. As you enter the waveform expression, you will see it appear as an equation in the control window.

You can define up to four separate math waveforms.

Using spectral analysis. When you are displaying an FFT (spectral) math waveform, you can use either of these two ways to operate the instrument:

- Use the conventional time-domain instrument controls, such as vertical and horizontal position and scale.
- Use the spectrum analyzer controls, such as center frequency, span, resolution bandwidth, and reference level.

When you use the Basic Spectrum Analyzer controls, the instrument automatically sets its time domain parameters, including record length and sample rate, as necessary to give you the view of the spectral waveform that you want to see. You can switch back to using the conventional time-domain controls at any time.

Spectral waveforms can be simple magnitude or phase waveforms calculated from the data acquired on a single channel. Or you can combine spectral operations with other math operations to do complex analysis of your signals.

Characterizing a signal. Signal characterization begins with taking measurements. To gain even more insight into your measurements, you can add measurement statistics to calculate the average measurement value, the standard deviation, and the maximum range of the measurement value.

Another way to characterize a signal is to compile a histogram from the acquired waveform. You can set up either a vertical histogram to analyze amplitude values or a horizontal histogram to analyze timing. For example, the vertical histogram is useful for characterizing noise and the horizontal histogram is useful for characterizing jitter.

While the histogram is being compiled from the acquired waveform, you can take continuous measurements on the histogram data to determine its mean value and other useful statistics.

Application-Specific measurements. You can load optional measurement extensions as needed to enhance the capabilities of the instrument for specific applications. These applications build on the precision signal acquisition performance of the instrument to address your specific design requirements.

Here are some examples of the application packages:

- **Jitter and Timing Analysis.** Use the DPOJET software to characterize the timing performance of semiconductor systems. Analyze clock jitter, setup and hold times, and many other timing measurements on a cycle-by-cycle basis over long, single-shot acquisitions. Measurement statistics are presented as numerical statistics, or graphically in a histogram, cycle trend, time trend, or spectral plot.
- **Ethernet Compliance Testing.** Use the ET3 software to perform 10/100/1000 Base T Ethernet compliance testing.
- **USB Signals.** Use the USB or USB3 software to characterize USB 2.0 or USB 3.0 universal serial bus signals, including mask testing and parametric testing.
- **Power Measurements.** Use the DPOPWR software to quickly measure and analyze power dissipation in power supply switching devices and magnetic components.
- **DDR Memory Bus Analysis.** Automatically identify DDR1, LP-DDR1 DDR2, DDR3, and GDDR3 Reads and Writes and make JEDEC conformance measurements with pass/fail results on all edges in every Read and Write burst.
- **MIPI® D-PHY Characterization and Compliance Testing.** Verify to the D-PHY specification, rapidly characterize and discover sources of jitter and signal integrity concerns.
- **SignalVu™ Vector Signal Analysis.** Easily validate wideband designs and characterize wideband spectral events.
- **CAN and LIN Timing and Protocol Decode Software.** When you need to ensure seamless and reliable operation of a CAN or LIN network, this option enables CAN bus triggering and provides the solution to measure oscillator tolerance, propagation delay, and simultaneously decode CAN and LIN messages, with the protocol leveraging the trigger capabilities.
- **8b10b Serial Triggering and Analysis.** Use the 8b10b software to trigger on and analyze 8b10b serial bus signals.

Additional packages may be available. Contact your Tektronix representative for more information.

Controls and connectors

Front panel controls and connectors

Front panel overview

The instrument features the following front-panel controls and connectors.

DPO70000SX Series instruments only have front-panel connectors and the On/Standby switch on the front panel.

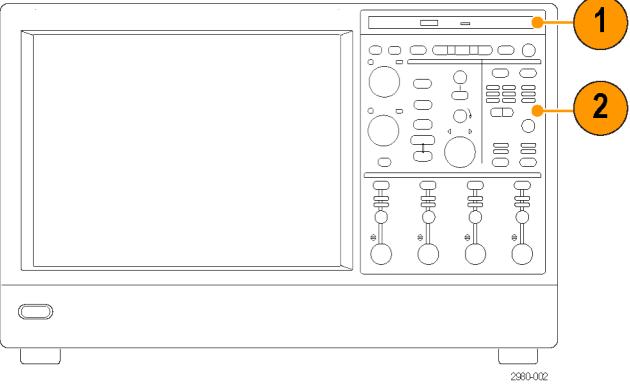
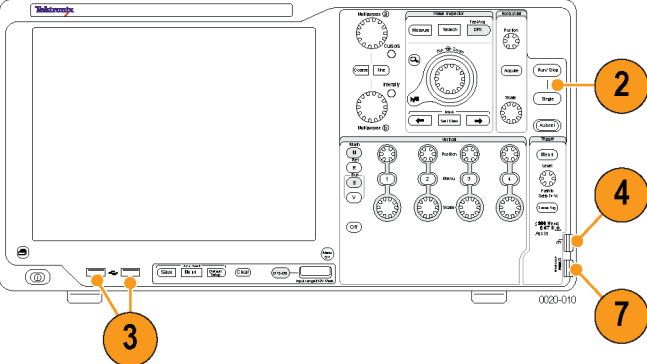
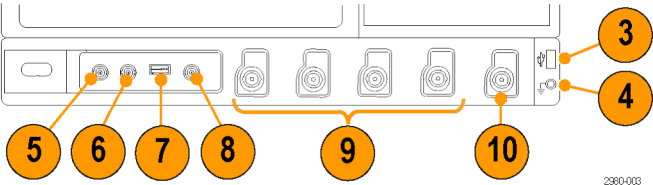
| Description | Location |
|--|--|
| <ol style="list-style-type: none"> 1. DVD/CD-RW drive 2. Front-panel controls 3. USB port 4. Ground terminal 5. Recovered data output 6. Recovered clock output 7. Probe compensation output 8. PROBE CALIBRATION output 9. Channel inputs 10. Auxiliary trigger input 11. Fast Edge output used for probe compensation 12. DC Probe Cal output 13. Logic probe input, inactive on DPO models. MSO capabilities are available as a user upgradeable option on DPO7000DX instruments. <p><i>On / Standby switch.</i></p> <ol style="list-style-type: none"> 14. Clear button 15. Save/Recall buttons 16. Digital Channel setup menu 17. Menu Off button 18. Print screen image button | <p>For all DPO7000C, MSO/DPO70000C, and MSO/DPO70000DX models:</p>  <p>Only for MSO5000B and DPO5000B models:</p>  <p>For DPO7000C Series models:</p>  |

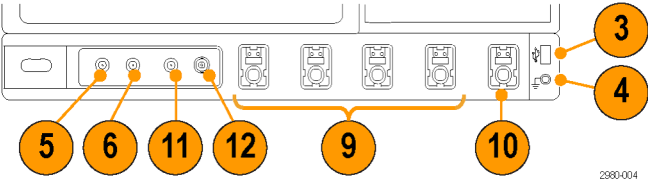
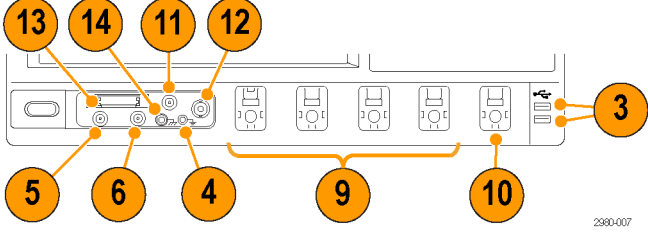
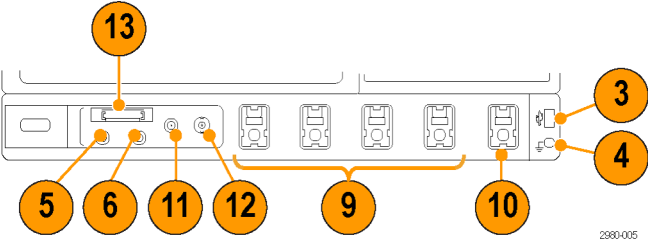
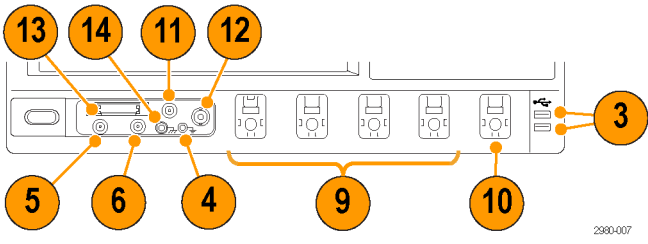
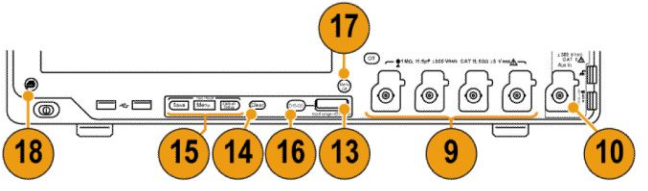
| Description | Location |
|--|---|
| <ol style="list-style-type: none"> 1. DVD/CD-RW drive 2. Front-panel controls 3. USB port 4. Ground terminal 5. Recovered data output 6. Recovered clock output 7. Probe compensation output 8. PROBE CALIBRATION output 9. Channel inputs 10. Auxiliary trigger input 11. Fast Edge output used for probe compensation 12. DC Probe Cal output 13. Logic probe input, inactive on DPO models. MSO capabilities are available as a user upgradeable option on DPO7000DX instruments. <p><i>On / Standby switch.</i></p> <ol style="list-style-type: none"> 14. Clear button 15. Save/Recall buttons 16. Digital Channel setup menu 17. Menu Off button 18. Print screen image button |  <p>Figure 5: For DPO7000C models:</p>  <p>Figure 6: For DPO7000DX models:</p>  <p>Figure 7: For MSO7000C models:</p>  <p>Figure 8: For MSO7000DX models:</p>  <p>Figure 9: For MSO5000B and DPO5000B models:</p> |

| Description | Location |
|--|--|
| <ol style="list-style-type: none"> 1. USB port 2. Ground terminal 3. PROBE CALIBRATION output 4. Channel inputs 5. Auxiliary trigger input 6. Differential Fast Edge output <p><i>On / Standby switch.</i></p> | <p>Figure 10: For DPO70002SX models:</p> |
| | <p>Figure 11: For DPO70004SX models:</p> |

Probe Compensation output

Use the Probe Compensation output to compensate or deskew passive probes or active voltage probes. On some models, this is the Fast Edge output.

Probe Calibration output

Use the Probe Calibration output to calibrate or deskew passive or active voltage probes.

Channel inputs

You can connect up to four probes to the inputs of the instrument. Each vertical input channel has its own vertical control settings.

D15–D0 inputs

You can connect one logic probe to the logic port on the front of the instrument. Each digital channel has its own control settings.

Auxiliary trigger input

The trigger level range for the Auxiliary Input is adjustable.

Ground terminals

Use these terminals to connect the instrument to the same ground as the unit under test, and if you are working with static sensitive components, ground yourself. Static electricity that builds up on your body can damage static-sensitive components. Wear a wrist strap to safely send static charges on your body to earth ground.

On/Standby switch. Use this button to power on the instrument or to set the instrument to standby.

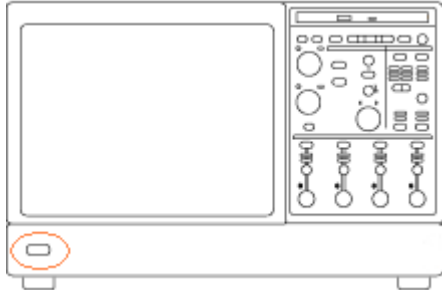

Figure 12: MSO and DPO instruments

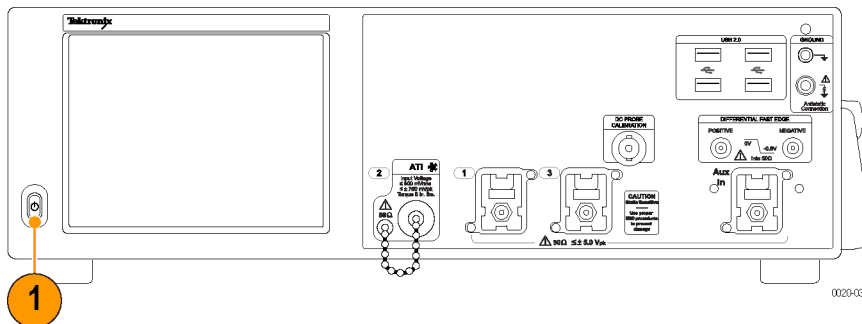

Figure 13: DPO7000SX instruments

Before shutting down, it is recommended that you first exit the instrument application and any other active Windows applications to avoid error messages on shutdown or the next power up.



TIP. To exit the instrument application and shut down in one step, select *Shutdown* in the *File* menu.

Touch screen

You can use touch to control the instrument in addition to the front-panel controls, toolbar buttons, and menu options. Generally, touch can be used anywhere that click is mentioned in this online help.



To disable the touch screen (SX instruments require the DPO7AFP Auxiliary Front Panel), push the front-panel Touch Screen button. When the touch screen is off, the button is lit. You can still access the on-screen menus with a mouse or keyboard.





To adjust the touch screen operation to your personal preferences, select *Touch Screen > Calibrate* from the *Utilities* menu.

NOTE. If the instrument is powered on in *Windows Safe Mode*, the touch screen is inoperative. You may need to use a mouse or keyboard to restore normal operation.

Wave inspector controls

NOTE. Wave Inspector Controls are available only on MSO/DPO5000B Series instruments.





The Wave Inspector controls (zoom/pan, play/pause, mark, and search) help you to efficiently work with long record length waveforms.

| Controls | Description |
|--|---|
|  | <p>Use Measure to perform automated measurements, Search to search through an acquisition for user-defined events/criteria, or DPX/FastAcq to start or stop fast acquisitions.</p> |
| | <p> Push  to turn on MultiView Zoom and add a magnified graticule to the display. Zooming a waveform: Enable or disable the zoom mode by pushing the zoom button. Rotate the inner knob on the Pan-Zoom control clockwise to zoom in on a selected part of the waveform. Rotate the knob counterclockwise to zoom back out.</p> |
| | <p>Use the Pan knob to scroll through a zoomed waveform. Panning a waveform: Rotate the pan (outer) knob of the pan-zoom controls to pan the waveform. Turn the knob clockwise to pan forward. Turn it counterclockwise to pan backwards. The further you turn the knob, the faster the zoom window pans.</p> |
| | <p>Use the play-pause knob  to automatically pan through a waveform record. Playing and Pausing a Waveform: Enable the play-pause mode by pushing the play-pause button. Adjust the play speed by turning the pan (outer) knob further. The further you turn it, the faster it goes.</p> |
| <p>Use to search and mark waveforms, to establish or delete a waveform mark, or to jump to the previous or next waveform mark.</p> | |

Vertical controls

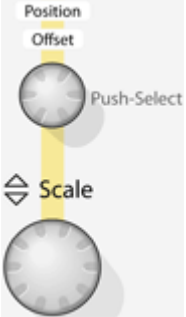

Use the Vertical controls to adjust the vertical display parameters of live data channels connected to the vertical inputs. Each input channel has identical controls.

Requires optional front panel accessory on DPO70000SX Series instruments.

| Controls | Description |
|---|--|
|  | <p>Use the dedicated channel (Ch <1–4>) buttons to turn channel displays on and off. The channel button is lighted when the selected channel is on.</p> |
|  | <p>Use the dedicated push-to-toggle Position/Offset and Scale knobs to adjust the vertical position and scale of the waveform.</p> <p>NOTE. The Offset button is not available on MSO/DPO5000B Series instruments.</p> <p>For channel waveforms (waveforms connected to the vertical inputs), the scale setting controls the vertical size of the <i>acquisition window</i> as well as the display scale. The range and resolution of the scale value depends on the attached probes and on any other external factors you have specified. For reference or math waveforms, the scale setting controls the display only. Scaling these waveforms has no effect on the acquisition hardware.</p> |
| <p>Math</p>  <p>Ref</p>  <p>Bus</p>  <p>Vertical</p>  | <p>Use the front panel controls to display the math (M), reference (R), bus (B), or vertical (V) setup menus.</p> <p>NOTE. The M, R, B, V buttons are available only on MSO/DPO5000B Series instruments.</p> |



Horizontal controls





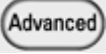

Use the Horizontal controls to adjust the horizontal parameters of waveforms. The horizontal controls globally affect all displayed waveforms.

| Controls | Description |
|---|---|
|  | <p>Use the dedicated Position knob to adjust the horizontal position of all waveforms. Use this knob to adjust the trigger point so that you can select the amount of pretrigger data or posttrigger data. In Delay Mode, this knob can be used to set the delay time.</p> <p>Use the dedicated Scale knob to adjust the horizontal scale (time base) of all channel waveforms.</p> |
|  | <p>Use the Resolution knob to change the number of acquired points (record length, in the Automatic and Constant Sample Rate horizontal modes). The actual resolution cannot be set directly but is derived and displayed on the horizontal readouts.</p> <p>NOTE. The Resolution knob is not available on MSO/DPO5000B Series instruments.</p> |
|  | <p>Push the Delay button to turn on horizontal delay, and then use the Position knob to set the delay time. Delay is useful when you want to acquire waveform details that are separated from the trigger event by a significant interval of time.</p> <p>NOTE. The Delay button is not available on MSO/DPO5000B Series instruments.</p> |

Trigger controls

Use the Trigger controls to set basic trigger parameters.

| Controls | Description |
|---|---|
|  | <p>By default, the instrument uses the Edge trigger. To return to the Edge trigger from any other A (main) event trigger, push the Edge button. Pushing this button does not open the Edge Trigger control window unless another A event trigger is already displayed.</p> <p>NOTE. The Edge button is not available on MSO/DPO5000B Series instruments.</p> |
|  | <p>To select other trigger types, push the Advanced button. In the Trigger control window, click the Select button to choose one of the other trigger types.</p> |
|  | <p>Select the trigger source for the Edge trigger by pushing the left or right arrow buttons until the desired Source is lighted. These buttons are only valid for the A event Edge trigger.</p> |

| Controls | Description |
|---|---|
|    | <p>Select Trig in the menu bar to open the Trigger control window. Use the Coupling drop-down menu to select <i>trigger coupling</i> for an A event or B event Edge trigger.</p> <p>To open the Trigger control window, push the Menu button (Available only on MSO/DPO5000B Series instruments only). Push the Force Trig button for the running trigger (Available only on MSO/DPO5000B Series instruments only).</p> |
|  | <p>Push the button in the Slope column to toggle between positive, negative, or both trigger slopes for the Edge trigger. The selected trigger slope(s) are lighted. These buttons are only valid for the A event Edge trigger.</p> <p>NOTE. The trigger slope selection button is not available on MSO/DPO5000B Series instruments.</p> |
|  | <p>Push the button in the Mode column to toggle between Normal (Norm) and Auto (Automatic) modes; the selected trigger mode is lighted.</p> <p>NOTE. The trigger mode selection button is not available on MSO/DPO5000B Series instruments.</p> |
|  | <p>Push the Level knob to set the trigger level to 50%. To set a different trigger level, rotate the Level knob. The trigger level appears on the screen. The trigger level knob affects Edge, Width, Glitch, Timeout, Serial, Video and some Communications trigger types.</p> |

Trigger source

The trigger source determines the source of the trigger signal. The input channels are the most commonly used trigger sources and are available for all trigger types.

Trigger slope

The trigger slope determines whether the instrument finds the trigger point on the rising edge, falling edge, or both edges of the signal.

Normal trigger mode

Normal trigger mode causes the instrument to wait for a valid trigger event before displaying waveform data. Normal trigger mode is most useful during single-shot acquisitions.

Trigger level

The trigger level determines the voltage level where the trigger point occurs.

Adjust the trigger level with the front-panel Level knob.

Click in the Level entry box in a Trigger control window and use the multipurpose knob to adjust the level.

Auto trigger mode

Auto trigger mode causes the instrument to trigger if a valid trigger event does not occur within a set amount of time.

Auto trigger mode is useful when probing DC signal levels such as power supplies or logic levels that are stuck high or low. It is also useful when looking for activities on signal nodes such as oscillations when you first set up the instrument. The length of time it waits for a trigger event depends on the time base setting.

Trigger coupling

The trigger coupling determines what part of the signal is passed to the trigger circuitry. All trigger types except edge triggering use DC coupling only. Edge triggering can use all available coupling choices.

DC. This coupling passes all input signals to the trigger circuitry.

AC. This coupling passes the input signals above 60 Hz to the trigger circuitry.

HF Reject. This coupling attenuates signals above 50 kHz before passing the signal to the trigger circuitry.

LF Rej. This coupling attenuates signals below 80 kHz before passing the signal to the trigger circuitry.

Noise Rej. This coupling provides stable triggering by increasing the trigger hysteresis. Increased hysteresis reduces the trigger sensitivity to noise but may require greater signal amplitude.

RF. This coupling provides increased sensitivity and bandwidth at the highest operating frequencies (SX models only).

Run controls





Use the Run controls to start, stop, and to monitor the status of acquisitions.



| Controls | Description |
|---|---|
|  | <p>Push the Run/Stop button to start and stop acquisitions. Push the Run/Stop button once to stop the acquisition. Push the Run/Stop button a second time to begin acquisitions again.</p> <p>Push the Single button to exit Run mode and start a single sequence of acquisitions.</p> <p>Push Clear to remove any acquired data.</p> <p>In Sample, Peak Detect, or High Res mode, the instrument acquires a waveform record with the first trigger event and then stops.</p> <p>In Envelope, Average, or WfmDB mode, the instrument makes the specified number of acquisitions to complete the averaging or enveloping task, and then stops.</p> |

| Controls | Description |
|--|--|
| <p>The Acquisition Status readouts, and lights on some instruments, indicate the state of the acquisition.</p>  | <p>Arm indicates the instrument is filling the pretrigger portion of the waveform record.</p> <p>Ready indicates the instrument can accept a valid trigger event and is waiting for the trigger event to occur.</p> <p>Trig'd or Triggered indicate that instrument has recognized a valid trigger and is filling the posttrigger portion of the waveform.</p> <p>When Arm, Ready, and Trig'd are not on, the acquisitions have stopped.</p> <p>When Ready and Trig'd are both on, the instrument has recognized a valid trigger and is waiting for a delayed trigger.</p> <p>When the instrument recognizes a delayed trigger, it will fill in the posttrigger portion of the waveform.</p> |

General purpose controls

Use the following front-panel controls to perform general-purpose tasks such as to Autose the instrument, to send items to the printer, or to enable cursors.

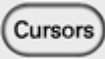
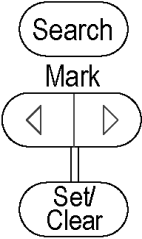
| Controls | Description |
|--|--|
| <p>Autoset</p>  | <p>Push the Autoset button to automatically set up the instrument to obtain and display a stable waveform of usable size. For information on the Autoset default settings click Autoset.</p> |
| <p>Default Setup</p>  | <p>Push the Default Setup button to reset the instrument to the factory default settings.</p> |
|  | <p>Push the Menu Off button to turn off a displayed menu.</p> <p>NOTE. <i>Menu Off is available only on MSO/DPO5000B Series instruments.</i></p> |
|  | <p>Push the Print button to make a hard copy of the screen. The printed image is sent directly to the selected (internal or attached) printer. To change the print settings, click the File menu Print command, and change the settings in the Print dialog box.</p> |

| Controls | Description |
|---|--|
|  | <p>Push the Cursors button to enable cursors on the screen. The Cursor Type control window opens so that you can specify the cursor parameters.</p> <p>NOTE. If cursors are on but the multipurpose knob readouts are not attached to the Position controls, press the Cursors button to attach the controls to the readouts. Press the Cursors button again to turn cursors off.</p> |
|  | <p>Push the Search and Mark buttons to find and place a mark on a waveform at a point of interest, or to edit marks. You can return to a mark and analyze the waveform at a later time.</p> |
|  | <p>Push the FastAcq DPX button to turn Fast Acquisition On or Off. The FastAcq button is lighted when Fast Acquisition is turned on.</p> |
|  | <p>Use the Intensity knob to adjust the brightness of the waveform. High intensity settings show less frequently acquired points more clearly.</p> |

MultiView zoom controls

Push the front panel MultiView Zoom button to do the following:

| Controls | Description |
|---|---|
|  | <p>Open a magnified window or windows in the upper half of the screen.</p> <p>Open the Zoom control window to set the position and factor of the selected waveform in the Zoom window, select the Zoom Area and Source, and lock and scroll the zoomed areas.</p> <p>Assign the multipurpose knobs to the horizontal or vertical position and scale controls in the Zoom graticule.</p> |



NOTE. If zoom is on but the multipurpose knob readouts are not attached to the zoom Position and Factory controls, press the MultiView Zoom button to attach the controls to the readouts. Press the MultiView Zoom button again to turn zoom off. The MultiView Zoom button is lighted when the Zoom mode is on.



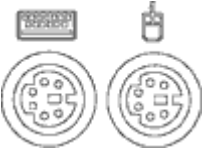
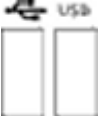
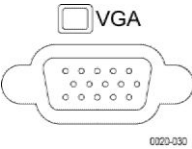
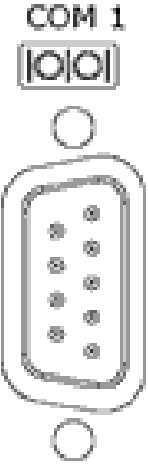

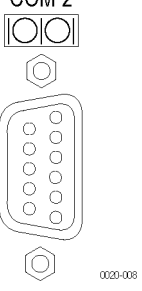
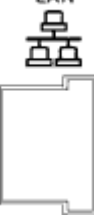
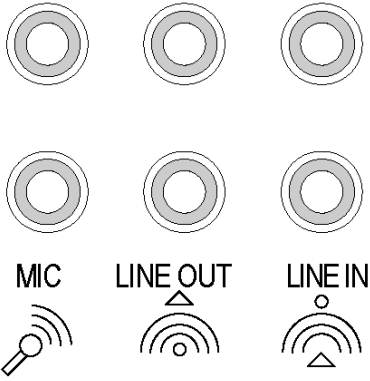
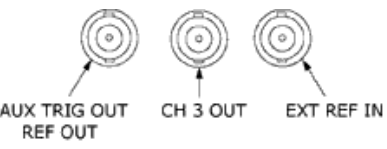
Rear and side panel connectors

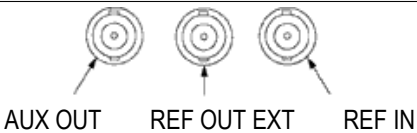
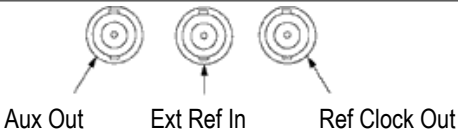
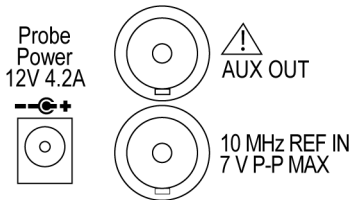
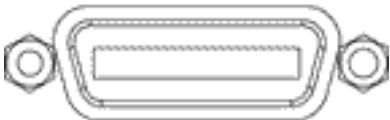
The instrument features the following rear and/or side panel connectors:

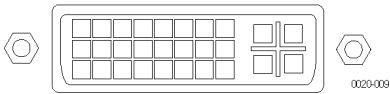
| Controls | Description |
|--|--|
|  | <p>Use the PS-2 connectors to connect a PS-2 keyboard or a mouse to the instrument.</p> |
|  | <p>Use the USB connectors to connect a USB mouse, a keyboard, or other USB devices to the instrument.</p> <p>NOTE. Plug USB devices directly into the USB connectors on the instrument to improve reliability rather than connecting the devices serially. If the USB mouse locks up, disconnect and reconnect the USB connector to restore normal operation. If the instrument front panel and/or touch screen do not respond, press the On/Standby switch for 5 seconds to cycle power.</p> |
|  | <p>Use this VGA port to connect a monitor for extended desktop operation. For example, use the front panel to display the contents of the instrument, and use an additional monitor for Windows operation.</p> <p>NOTE. This port is available on all instruments except MSO70000C and DPO70000C Series instruments.</p> |
| <p>COM 1</p>  | <p>Use the COM 1 serial port to connect to other devices through the serial port.</p> <p>NOTE. The COM1 port is available on all instruments except MSO/DPO5000B and DPO70000SX Series instruments.</p> |

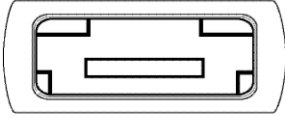
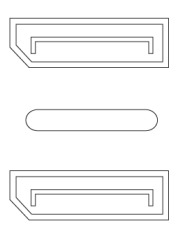
| Controls | Description |
|--|---|
| <p>COM 2</p>  <p>0020-008</p> | <p>Use the COM 2 serial port to connect to other devices through the serial port.</p> <p>NOTE. The COM2 port is not available on some instruments.</p> |
| <p>LAN</p>  | <p>Use the RJ-45 connector to connect the instrument to a network.</p> |
| <p>SIDE REAR CTR BASS</p>  <p>MIC LINE OUT LINE IN</p> | <p>Use the Audio ports for stereo microphone input and stereo line output.</p> |
|  <p>AUX TRIG OUT CH 3 OUT EXT REF IN</p> | <p>For MSO/DPO5000B and DPO7000C instruments:</p> <p>Use the AUX TRIG OUT / REF OUT connector to obtain a TTL-compatible, negative polarity pulse when the instrument triggers.</p> <p>Use the CH 3 OUT connector to connect to a buffered version of the signal that is attached to the Channel 3 input. The amplitude is 50 mV/div $\pm 20\%$ into a 1 MΩ load, or 25 mV/div $\pm 20\%$ into a 50 Ω load.</p> <p>Use the EXT REF IN connector to synchronize the instrument time base to an external 9.8 – 10.2 MHz reference frequency source. When not using the external reference, disconnect signals from the EXT REF IN BNC connector.</p> |

| Controls | Description |
|---|--|
|  <p>AUX OUT REF OUT EXT REF IN</p> | <p>For MSO/DPO70000C and MSO/DPO70000DX instruments: Use the AUX OUT connector to obtain a TTL-compatible, negative polarity pulse when the instrument triggers or when certain other events occur, such as a mask test failure or completion. Use the REF OUT connector to obtain a copy of the internal reference. Use the EXT REF IN connector to synchronize the instrument time base to an external 9.8 – 10.2 MHz reference frequency source. When not using the external reference, disconnect signals from the EXT REF IN BNC connector.</p> |
|  <p>Aux Out Ext Ref In Ref Clock Out</p> | <p>For DPO70000SX instruments: Use the Aux Out connector to obtain a TTL-compatible, negative polarity pulse when the instrument triggers or when certain other events occur, such as a mask test failure or completion. Use the Ref Clock Out connector to obtain a copy of the internal reference. Use the Ext Ref In connector to synchronize the instrument time base to an external 9.8 – 10.2 MHz reference frequency source. When not using the external reference, disconnect signals from the Ext Ref In BNC connector.</p> |
|  <p>Probe Power 12V 4.2A</p> <p>AUX OUT</p> <p>10 MHz REF IN 7 V P-P MAX</p> | <p>For MSO/DPO5000B instruments: Use the Probe Power to input the probe power. Use the REF IN to input the external reference. When not using the external reference, disconnect signals from the REF IN BNC connector. Use the AUX OUT connector to obtain a TTL-compatible, negative polarity pulse when the instrument triggers or when certain other events occur, such as a mask test failure or completion. You may also set the AUX OUT connector to obtain a copy of the internal reference.</p> |
| <p style="text-align: center;">GPIB</p>  | <p>Use the GPIB connector to connect the instrument to a GPIB controller for GPIB operation.</p> <p>NOTE. The GPIB connector is available on all instruments except MSO/DPO5000B and DPO70000SX Series instruments.</p> |
| <p style="text-align: center;">TekLink </p>  | <p>This connector is not used.</p> |
| <p style="text-align: center;">DVI-I Video port</p>  <p style="text-align: right; font-size: small;">0020-009</p> | <p>Use the DVI-I Video port (some instruments have a DVI-D Video port) to send the instrument display to a projector or to a flat-panel LCD monitor.</p> |

| Controls | Description |
|---|--|
|  | <p>Use the eSATA port as an external interface for SATA support devices.</p> <p>NOTE. This port is available only on MSO7000C/DX, DPO7000C/DX, and DPO7000C Series instruments.</p> |
| <p>For DPO7000SX instruments:</p> | |
|  <p>0200-034</p> | <p>Use the Display Port to connect to a monitor.</p> |
|  | <p>Use the PCIe ports to connect to a PC or to set up a multi-instrument configuration.</p> |
|  | <p>Use the Trigger ports to set up a multi-instrument configuration.</p> |
|  | <p>Use the 12.5 GHz Clock In and Out to set up a multi-instrument configuration.</p> |

Cursor setups

Cursor setup control window (YT display format)

From the Cursor menu, select Cursor Setup.

Overview

Use the Cursor Setup controls to configure cursor parameters. The available controls vary depending on the [Display Format](#) and the rest of the cursor window settings.

NOTE. *Cursor measurements on digital channels require that at least one analog channel be displayed. Alternatively, to take a measurement of a digital channel, you can first send the waveform acquired on the digital channel to an analog channel using iCapture. This online help supports many oscilloscope models from Tektronix. This feature is only available on some models.*

For information on the controls, click the buttons.

- [Track Mode](#)
- [H Bars](#)
- [V Bars](#)
- [Waveform](#)
- [Screen](#)
- [Source](#)
- [Position](#)
- [Cursor style](#) on page 89

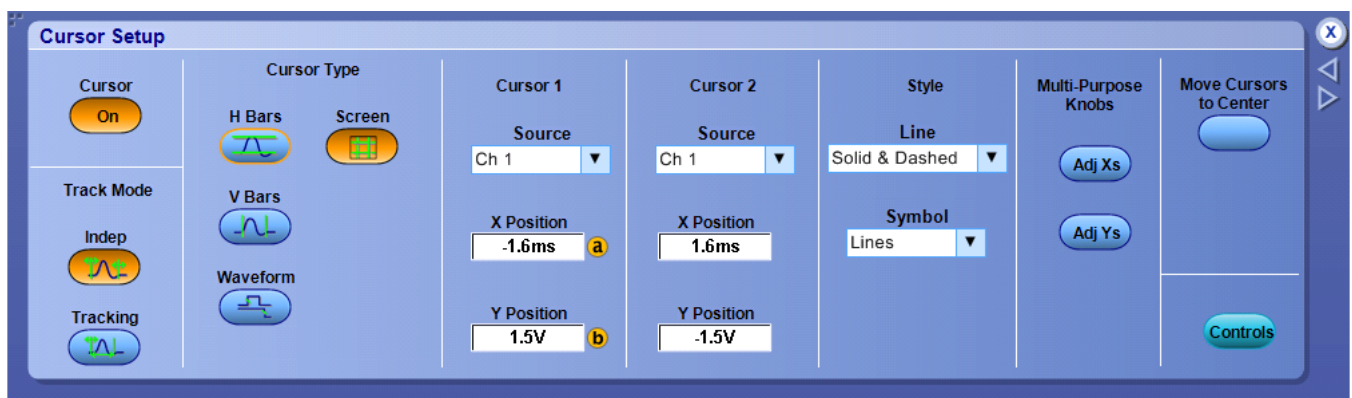

To use

1. Click the Cursor button to turn cursors on and off.

NOTE. If cursors are on but the readouts are not attached to the cursor controls, press the Cursors button to attach the readouts to the cursor controls. Press the Cursors button again to turn the cursors off.

2. To select the cursor Track Mode, click either the Indep (independent) or Tracking button.
3. Select a cursor type by clicking one of the Cursor Type buttons.
4. Select the waveform you want to measure from the Source drop-down lists. Cursor 1 and Cursor 2 each have their own source.



TIP. If are using H Bar or V Bar Cursors and want the cursor source to be the same for both cursors, set the source for Cursor 1. Cursor 2 will have the same value as Cursor 1, unless you change it.

5. Click in the Position entry boxes to map the cursors to the multipurpose knobs, and then use the knobs to move the cursors.
6. Select a Line style from the drop-down list. Line styles are available for all cursor types.
7. Select a Symbol style from the drop-down list. Symbol styles are only available on Waveform and Screen cursors.

NOTE. If you are using XY or XYZ display format, you can also select the type of readout from the XY Readout Type drop-down list. Only Waveform and Screen cursors are available in the XY or XYZ display format.



TIP. The Cursors menu Cursors On command can also be used to toggle the cursors on and off. The cursors are on when a check mark appears next to this command.

Behavior

When cursors are turned on, the front panel Cursors button illuminates.

Track mode

- Indep (Independent) moves the cursors independent of each other.
- Tracking moves Cursor 1 and Cursor 2 in tandem. However, moving Cursor 2 does not move Cursor 1.

Style

Applies only to Waveform and Screen cursors. The Line & X symbol style displays only an X when used with waveform cursors in XY display mode such that the vertical line is not drawn, only the X.

If you change the display format to XY when H Bar cursors are enabled, the cursor type will change to Screen. In normal acquisition mode, changing the display format to XY when V Bar cursors are enabled, changes the cursor type to Waveform.



TIP. To turn the cursors off, push the front-panel Cursors button.

What do you want to do next?

[Go to a step-by-step procedure for taking cursor measurements.](#)

[Learn about the cursor types.](#)

[Cursor style](#) on page 89

Cursor type control window

From the Cursor menu, select Cursor Controls, or press the front panel Cursors button.

Overview

Use the Cursor Type control window to select the source for each cursor and the type of cursors used for waveform measurements.

For information on the controls, click the buttons.

- [Source](#)
- [H Bars](#)
- [V Bars](#)
- [Waveform](#)
- [Screen](#)
- [Setup](#)



To use

1. Click the Source drop-down list to select the source for the cursor.
2. Click one of the Cursor Type buttons to select a cursor type.



TIP. Select a cursor type directly from the Cursors menu Cursor Type submenu.

Behavior

If you are using H-Bar or V-Bar Cursors, and want to measure the same waveform with both cursors, select the waveform for Cursor 1. Cursor 2 will have the same value as Cursor 1, unless you change it.

Click Setup to open the Cursor control window where you can specify other cursor parameters.

What do you want to do next?

[Learn about the Cursor Position controls.](#)

[Learn about the Cursor Setup controls.](#)

Cursor sources (YT display)

From the Cursor menu, select Cursor Setup.

Overview

Use these controls to define the source for both Cursor 1 and Cursor 2 for any cursor type.

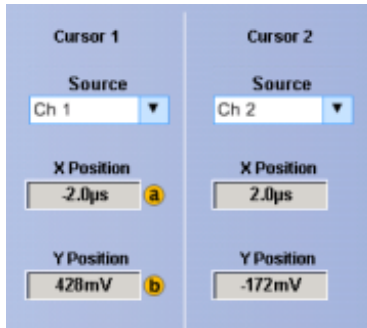

To use

1. Click the Source drop-down list to select the measurement source for the cursor.
2. Click in an X Position entry box and use a multipurpose knob to adjust the position of the cursor.

Behavior

If the cursor type is V Bars or H Bars, setting the Cursor 1 source sets the Cursor 2 source to the same value. To have different sources for Cursor 1 and Cursor 2, set the Cursor 1 source first, and then set the Cursor 2 source.

NOTE. Only Screen Cursors have both an X and Y Position controls.

The Multipurpose Knobs Adj buttons appear only with Screen cursors. Click the Adj buttons to assign the multipurpose knobs to the X-axis and the Y-axis controls.

What do you want to do next?

[Learn about cursor types.](#)

[Learn about cursor styles.](#)

[Learn about Cursor Readouts in XY display format.](#)

Cursor style

From the Cursor menu, select Cursor Setup.

Overview

Use these controls to change the appearance of the cursors.

To use

1. Select a Line style from the drop-down list: Solid, Dashed, or Solid and Dashed.
2. Select a Symbol style from the drop-down list: Lines, Line & X, or X.

NOTE. Symbol styles are only available for [waveform](#) and [Screen](#) cursors.

If you are in XY display format, you can also select the XY Cursor Readout from the drop-down list.

Behavior

Cursor positions are displayed according to line style, symbol style, cursor type, and waveform display format. See the following table. The Line & X symbol style displays only the X when used with waveform cursors in XY display mode. (The vertical line is not drawn.)

| Symbol style | Cursor type | Display format | Cursor position |
|--------------|---------------------|----------------|--|
| Lines | Waveform and Screen | YT | Intersection of horizontal and vertical lines. Default style for Screen cursors. |
| Line & X | Waveform and Screen | YT | Horizontal position is shown by a vertical line, the Y-axis is shown by an X. Default style for Waveform cursors in YT mode. |
| X | Waveform and Screen | XY | Single X indicates the horizontal and vertical position. Default style for Waveform Cursors in XY mode. |

Cursor readouts are displayed based on the selection in the XY cursor Readout drop-down list. This list is only available for Waveform and Screen cursors when you are using XY display format.

| XY cursor readout | Cursor type | Display format | Cursor position |
|-------------------|---------------------|----------------|--|
| Rectangular | Waveform and Screen | XY | Shown as rectangular coordinate positions. There are nine readouts for Waveform cursors and six for Screen cursors. |
| Polar | Waveform and Screen | XY | Shown as polar coordinate positions. There are nine readouts for Waveform cursors and six for Screen cursors. |
| Product | Waveform and Screen | XY | Shown as rectangular coordinates and the X vertical value is multiplied by the Y vertical value. There are six readouts for Waveform cursors and three for Screen cursors. |
| Ratio | Waveform and Screen | XY | Shown as rectangular coordinates and the Y vertical value is divided by X vertical value. |

Cursor position control window

From the Cursor menu, select Cursor Position.

Overview

Use the Cursor Position control window to position the cursors with the multipurpose knobs.

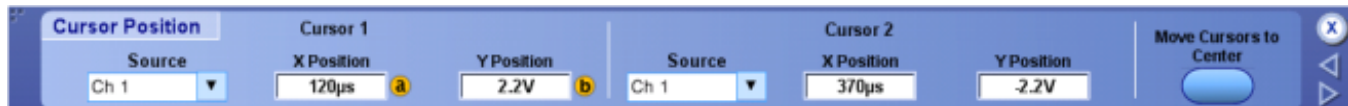

To use

1. Click the Source drop-down list to select the measurement source for the cursor.
2. Click in one of the cursor Position entry boxes, and use a multipurpose knob to enter the cursor position.

Behavior

The cursor units depend on the cursor type. The cursor position readouts appear on the display graticule. When using the IRE graticule style, amplitude cursor readouts are shown in IRE units.

Cursor position does not change if the cursor source changes or if the waveform is repositioned.



TIP. Use the pop-up keypad or your external keyboard to specify exact numerical cursor coordinates.

What do you want to do next?

[Learn about the Cursor Setup controls.](#)

[Learn about the cursor types.](#)

Horizontal bar cursors

From the Cursor menu, select Cursor Controls, or press the front panel Cursors button.

To use

1. To use the horizontal bar cursors, click H Bars in one of the cursor control windows, or from the Cursors menu, highlight Cursor Type, and then select H-bars from the submenu.
2. Use the multipurpose knobs to move the cursors.
3. Use the cursor Source drop-down list boxes to select the waveform you want to measure.

Behavior

Horizontal bar cursors measure vertical parameters (amplitude). Typically the vertical parameters are in volts, but depend on the Vertical Units selected for the measurement window.

The cursor readouts appear near the bottom of the graticule when a control window is open. When the control windows are closed, the readouts appear at the bottom of the screen. Each cursor has its own readout with respect to the zero-reference. The Δ (delta) value shows the difference between the cursor values.

What do you want to do next?

[Learn more about the Cursor controls.](#)

[Go to a step-by-step procedure for taking cursor measurements.](#)

Vertical bar cursors

From the Cursor menu, select Cursor Controls, or press the front panel Cursors button.

To use

1. To use the vertical bar cursors, click V Bars in one of the cursor control windows or highlight Cursor Type from the Cursors menu, and then select V-bars from the submenu.
2. Use the multipurpose knobs to move the cursors.
3. Use the cursor Source drop-down list boxes to select the waveform you want to measure.

Behavior

Vertical bar cursors measure horizontal parameters. Typically horizontal parameters are in time or frequency.

The cursor readouts appear near the bottom of the graticule when a control window is open. When the control windows are closed, the readouts appear at the bottom of the screen.

For time domain waveforms, each cursor has its own readout relative to the trigger point. The Δ (delta) value shows the time difference between the cursor values, or the frequency associated with the period between the cursors ($\text{Hz} = 1/\text{time}$).

For frequency domain signals, each cursor has its own readout relative to 0 Hz. The Δ value shows the difference in the frequencies between the cursors.

You can also use vertical bar cursors with measurement gating. Measurement gating enables you to limit automatic measurements to within the boundaries of the vertical bar cursors rather than use the entire display width.

What do you want to do next?

[Learn more about the Cursor controls.](#)

[Go to a step-by-step procedure for taking cursor measurements.](#)

[Learn more about measurement gating.](#)

Waveform cursors

From the Cursor menu, select Cursor Controls, or press the front panel Cursors button.

To use

1. To use the waveform cursors, click Waveform in one of the cursor control windows or from the Cursors menu, highlight Cursor Type, and then select Waveform from the submenu.
2. Use the multipurpose knobs to move the cursors.
3. Use the cursor Source drop-down list boxes to select the waveform you want to measure.

Behavior

Waveform cursors can measure parameters on the same waveform or on different waveforms. The cursors measure vertical parameters (typically volts) and horizontal parameters (typically time or frequency) simultaneously. An X identifies the cursor location at the point where the cursors intersect the waveform.

The cursor readouts appear near the bottom of the graticule when a control window is open. When the control windows are closed, the readouts appear at the bottom of the screen.

One Δ (delta) value shows the voltage difference between the two cursors while the other Δ value shows the time (or frequency) difference between the cursor values.

What do you want to do next?

[Learn more about the Cursor controls.](#)

[Go to a step-by-step procedure for taking cursor measurements](#)

Screen cursors

From the Cursor menu, select Cursor Controls, or press the front panel Cursors button.

To use

1. To use the screen cursors, click Screen in one of the cursor control windows or from the Cursors menu highlight Cursor Type, and then select Screen from the submenu.
2. Use the multipurpose knobs to move the cursors.
3. Use the cursor Source drop-down list boxes to select the waveform you want to measure.

Behavior

Use screen cursors to indicate an arbitrary X and Y position in the waveform display area represented by the intersection of a vertical and horizontal cursor line. Screen cursors measure both vertical parameters (typically volts) and horizontal parameters (typically time or frequency).

Readouts display measurement parameters for both cursors. Vertical readouts display voltage values for each cursor with respect to the zero reference point and with respect to each other. Horizontal readouts display time or frequency values for each cursor with respect to the trigger point and with respect to each other.

The cursor readouts appear near the bottom of the graticule when a control window is open. When the control windows are closed, the readouts appear at the bottom of the screen.

What do you want to do next?

[Learn more about the Cursor controls.](#)

[Go to a step-by-step procedure for taking cursor measurements.](#)

Cursor track mode

From the Cursor Setup control window, click the Indep or Tracking button. From the Cursor menu highlight Cursor Mode; then select Indep or Tracking in the submenu.

Overview

Use this control to define the tracking relationship between cursors.

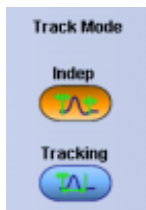

To use

To select a cursor tracking mode, click either the Indep or Track button.

Behavior

- Click Indep (Independent) to move one cursor at a time using the multipurpose knobs.
- Click Tracking to move Cursor 1 and Cursor 2 in tandem so that Cursor 2 will always remain a fixed distance (time or voltage) from the Cursor 1. However, moving Cursor 2 does not move Cursor 1.

Cursor measurements

Because cursor measurements give immediate feedback on the amplitude or time values they measure, they are usually quick to take and are more accurate than graticule measurements. Also, since you can position cursors wherever you want them on the waveform, they are easier to localize to a waveform segment or feature than automatic measurements.

Cursors can measure channel, reference, and math waveforms. You must set the source of each cursor explicitly in the Cursor Control window.

Any cursor type can be used for YT display format. XY display format can only use Screen or Waveform cursors.

To use cursors, simply move the cursors on screen and read the results in the cursor readouts. The following key points will help you use the cursors effectively.

NOTE. *Cursor measurements on digital channels require that at least one analog channel be displayed. Alternatively, to take a measurement of a digital channel, you can first send the waveform acquired on the digital channel to an analog channel using iCapture. This online help supports many oscilloscope models from Tektronix. This feature is only available on some models.*

Cursor types overview

There are two [cursors types](#) available for the displays, Cursor 1 and Cursor 2. You can move cursors with the multipurpose knobs or the cursor position controls in the Cursor Control window, or click and drag them to a new location.

Cursors are limited by the display

You cannot move a cursor off the graticule unless you are in Zoom mode. Also, if you resize waveforms, the cursors do not track. That is, a cursor stays at its screen position, ignoring changes to horizontal and vertical scale and position and vertical offset (Waveform and Screen cursors will track a waveform vertically).

Cursors ignore the selected waveform

Each cursor measures its source, defined in the Cursor Control window. Selecting a waveform for scaling on screen (by pushing the Ch 3 front-panel button, for example) does not change the source that each cursor measures.

After you have selected the source from the Cursor Control window, you can operate the cursor from the front-panel knobs and buttons.

NOTE. *If a cursor readout does not seem correct, check the source of each cursor in the Cursor Setup dialog box. Each cursor readout relates to the amplitude and time base settings of its source.*

Vertical cursors measure from the trigger point

Remember that each vertical cursor measures the time from the trigger point to itself. This relationship is shown in the next figure.

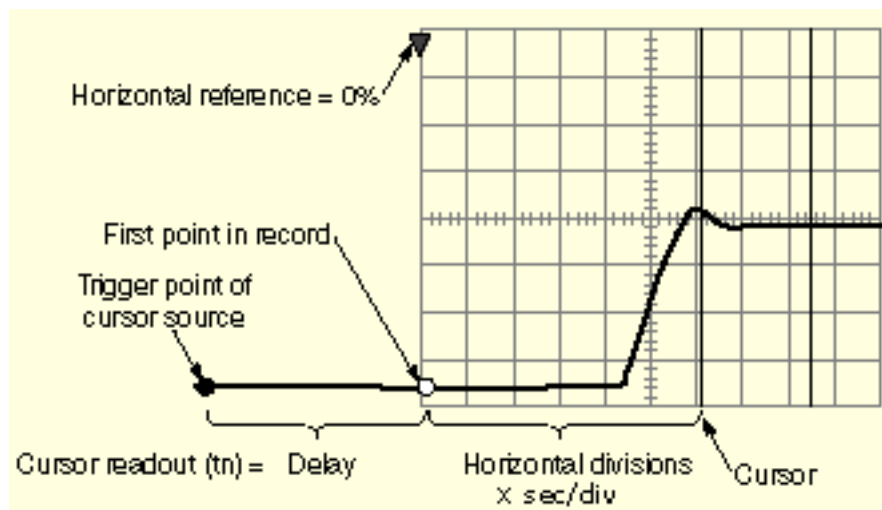

A vertical cursor readout includes and varies directly with the Delay time, which varies directly with the horizontal position set for the time base. To see the amount of time to the first point, set horizontal delay to 0.0 and set the horizontal reference point to 0%. Now the horizontal position readout shows the time following the first point, and adding this value to the cursor readout yields the cursor position on screen relative to first point. (You can find the horizontal readout both in the control window and in the readout at the bottom of the screen.)

The following relationships hold:

Time from First Point = Horiz Position (when Horiz Delay and Ref Position are zero)

T1 readout = Time to First Point + Additional Time to Cursor

Cursor units depend on sources

A cursor that measures amplitude or time will read out in the units of its source as indicated in the table below. Mixed sources require delta cursor readouts to use the units of the Cursor 1 source.

| Cursors | Standard units ¹ | Readout names |
|------------------|------------------------------------|------------------------|
| Horizontal | volts, watts, IRE | V1, V2, ΔV |
| Vertical | seconds, bits, Hertz | T1, T2, ΔT, ΔF |
| Waveform, Screen | volts, watts, seconds, bits, Hertz | V1, V2, ΔV, T1, T2, ΔT |

¹ If the V1 and V2 units do not match, the ΔV readout defaults to the units used by the V1 readout.

Changing cursor positions

Change cursor positions by using the position controls in the Cursor Position window, dragging the cursor into position using the touch screen or mouse, or by turning the front-panel multipurpose knobs.

NOTE. To make small changes with the multipurpose knobs, push the Fine button before turning the knobs. When a Fine button is lighted, its multipurpose knob makes smaller adjustments.

What do you want to do next?

[Learn about cursor types.](#)

[Go to a step-by-step procedure for taking automatic measurements.](#)

Cursor setup control window (XY display format)

From the Cursors menu, select Cursor Setup.

Overview

Use these controls to set the cursor parameters when you are using *XY display format*. The available controls vary depending on the rest of the cursor window settings.

For information on the controls, click the buttons.

- [Track Mode](#)
- [Waveform](#)
- [Screen](#)
- [Source](#)
- [Position](#)
- [Style](#)

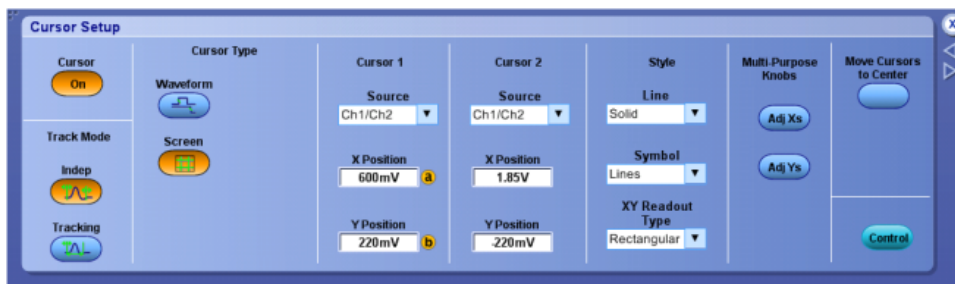

To use

1. Use the same [Cursor Control Window \(YT format\)](#) guidelines to setup up the cursor controls.
2. Select the readout format from the XY Readout drop-down list.

Behavior

When you are using XY display format, only Waveform and Screen cursors are available. If you change the display format to XY when H Bar cursors are enabled, the cursor type will change to Screen. In normal acquisition mode, changing the display format to XY when V Bar cursors are enabled, changes the cursor type to Waveform. In FastAcq acquisition mode, changing the display format to XY when V Bar cursors are enabled, changes the cursor type to Screen.

If you change the display format from XY to YT when Screen cursors are enabled, the cursor type is changed to H Bars.

XY

These cursor Readouts only appear when you are using XY display format. Rectangular XY readouts are the default.

Rectangular

Shows the cursor readouts as rectangular coordinate positions. Waveform cursors display nine rectangular readouts (ΔX , ΔY , Δt , $X1$, $X2$, $Y1$, $Y2$, $t1$, and $t2$). Screen cursors display six readouts (ΔX , ΔY , $X1$, $X2$, $Y1$, and $Y2$).

Polar

Shows the cursor position as polar coordinate positions. Waveform cursors display nine polar readouts (Δr , $\Delta \theta$, Δt , $r1$, $r2$, $\theta1$, $\theta2$, $t1$, and $t2$). Screen cursors display six polar readouts (Δr , $\Delta \theta$, $r1$, $r2$, $\theta1$, and $\theta2$).

Product

Shows the cursor position as rectangular coordinates and the X vertical value is multiplied by the Y vertical value. Waveform cursors display seven product readouts ($\Delta X \times \Delta Y$, $X1 \times Y1$, $X2 \times Y1$, $X2 \times 2$, Δt , $t1$, and $t2$). Screen cursors display three product readouts ($\Delta X \times \Delta Y$, $X1 \times Y1$, and $X2 \times Y2$).

Ratio

Shows the cursor position as rectangular coordinates and the Y vertical value is divided by the X vertical value. Waveform cursors display six ratio readouts ($\Delta Y \div \Delta X$, $Y1 \div X1$, $Y2 \div Y1$, Δt , $t1$, and $t2$). Screen cursors display three ratio readouts ($\Delta Y \div \Delta X$, $Y1 \div X1$, and $Y2 \div Y1$).

Digital setups

Digital setup control window

From the Digital menu, select Digital Setup.

NOTE. The Digital Setup is available only on MSO5000B and MSO70000C/DX Series instruments and DPO5000B Series instruments with option MSOE installed, and DPO70000DX instruments with option MSOU installed.

Overview

Use the Digital Setup control windows to set parameters for the D15-D0 digital channels. Use the D15-D8 tab to set up the upper eight bits and the D7-D0 tab to set up the lower eight bits.

For information on the controls, click the buttons.

- [Threshold & Position](#)
- [Size](#)
- [Global Threshold](#)
- [D15-D0 Tabs](#)
- [Turn D7 - D0](#)
- [Turn D15 - D8](#)

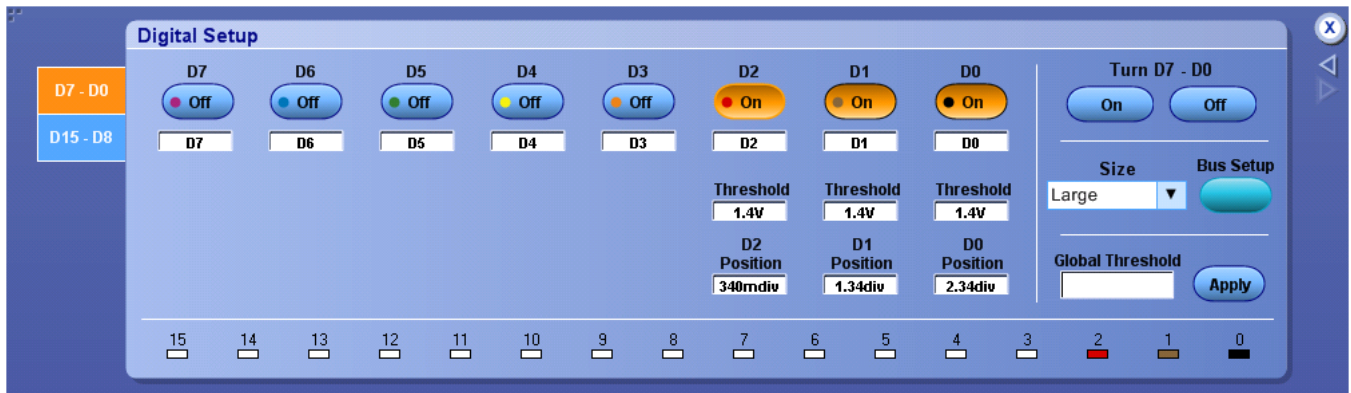

To use

- Click the digital channels buttons to turn the waveforms on and off.
- Set the voltage level thresholds for individual channels or set the same threshold level for all channels.
- Adjust the vertical position of each channel.
- Set the vertical height of the channel in the display.



TIP. Click the *Bus Setup* button to quickly access the *Bus Setup* control window.

What do you want to do next?

[Learn how to connect a logic probe to signals in your system under test.](#)

[Learn how to turn on or turn off the digital channels.](#)

[Learn how to set up the digital channels.](#)

[Learn about bus setups.](#)

[Learn about bus configuration.](#)

[Learn how to set up a bus.](#)

[Learn how to set up digital waveforms.](#)

[Learn how to view analog characteristics of a digital waveform.](#)

[Learn how to trigger on a bus.](#)

[Learn how to track down serial bus anomalies.](#)

[Learn how to troubleshoot circuits using a parallel bus.](#)

[Learn how to troubleshoot a serial bus.](#)

Setting up digital signal inputs

Use the Digital setup menu to set up the digital channels to acquire signals.

NOTE. *Digital Setup* is available only on MSO5000B and MSO7000C/DX Series instruments and DPO5000B Series instruments with option MSOE installed, and DPO7000DX instruments with option MSOU installed.

To use

1. Connect the logic probe to the instrument.
2. Connect the probe to the input signal sources.

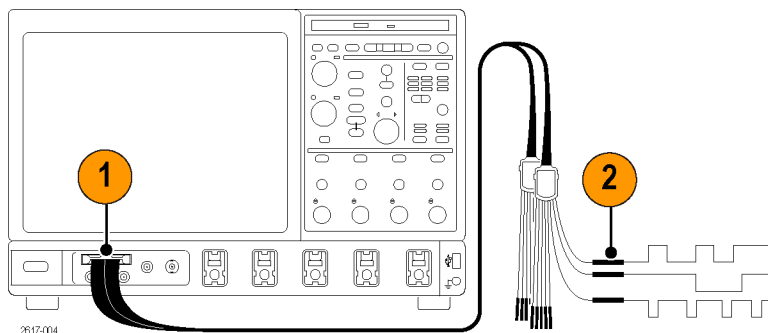
**CAUTION.**

To prevent damage to the instrument always wear an antistatic wrist strap when making connections to the instrument and observe the maximum input voltage ratings for input connectors.

3. Set up digital channels and buses using the Digital Setup and Bus Setup control windows through the Digital menu. The Bus Setup window is also accessible through the Vertical menu.

What do you want to do next?

[Learn about setting up the digital channels.](#)

[Learn about bus setups.](#)

[Learn about bus configuration.](#)

Digital channel threshold and position

NOTE. The Digital Channel Threshold and Position option is available only on MSO5000B and MSO7000C/DX Series instruments and DPO5000B Series instruments with option MSOE installed, and DPO7000DX instruments with option MSOU installed.

From the Digital menu, select Digital Setup.

Overview

Use these controls to define the voltage threshold level of digital channels and their vertical position in the display.

To use

1. Use the Channel Selectors to select a channel.
2. Use the Threshold and Position controls to set the voltage threshold level and the vertical position of the selected channel.

Set digital channel threshold

NOTE. The Digital Channel Threshold option is available only on MSO5000B and MSO7000C/DX Series instruments and DPO5000B Series instruments with option MSOE installed, and DPO7000DX instruments with option MSOU installed.

From the Digital menu, select Digital Setup and use the Threshold entry box to set the voltage threshold level of the digital channel.

NOTE. The instrument displays the Threshold entry box when you turn on the digital channel.

To use

- Click in the Threshold entry box and use the keypad to enter a value or use the multipurpose knobs to select a voltage level.



Behavior

The voltage threshold level determines when a voltage level on a digital channel is considered to be a logic high and a logic low.

Set digital channel position

NOTE. The Digital Channel Position option is available only on MSO5000B and MSO7000C/DX Series instruments and DPO5000B Series instruments with option MSOE installed, and DPO7000DX instruments with option MSOU installed.

From the Digital menu, select Digital Setup and use the Position entry box to move the digital channel vertically in the display.

NOTE. The instrument displays the Position entry box when you turn on the digital channel.

To use

- Double-click in the Position entry box, and use the keypad or the multipurpose knobs to adjust the position of the digital channel.



What do you want to do next?

[Learn about setting up digital signals.](#)

[Learn more about digital setups.](#)

[Learn about bus setups.](#)

[Learn about bus configuration.](#)

Turn on or off the digital channels D15-D8 and D7-D0

NOTE. The Turn On or Off the Digital Channels D15-D8 and D7-D0 option is available only on MSO5000B and MSO7000C/DX Series instruments and DPO5000B Series instruments with option MSOE installed, and DPO7000DX instruments with option MSOU installed.

From the Digital Setup menu, select the D15-D8 or D7-D0 tab.

To use

- Click Turn D7–D0 or Turn D15-D8 On button to turn on the digital channels D0 to D7 or D8 to D15 respectively.
- Click the Threshold entry box and use the keypad to enter a value for the voltage level or use the multipurpose knobs to select a voltage level.
- Click the Position entry box and move the channel using the multipurpose knob.

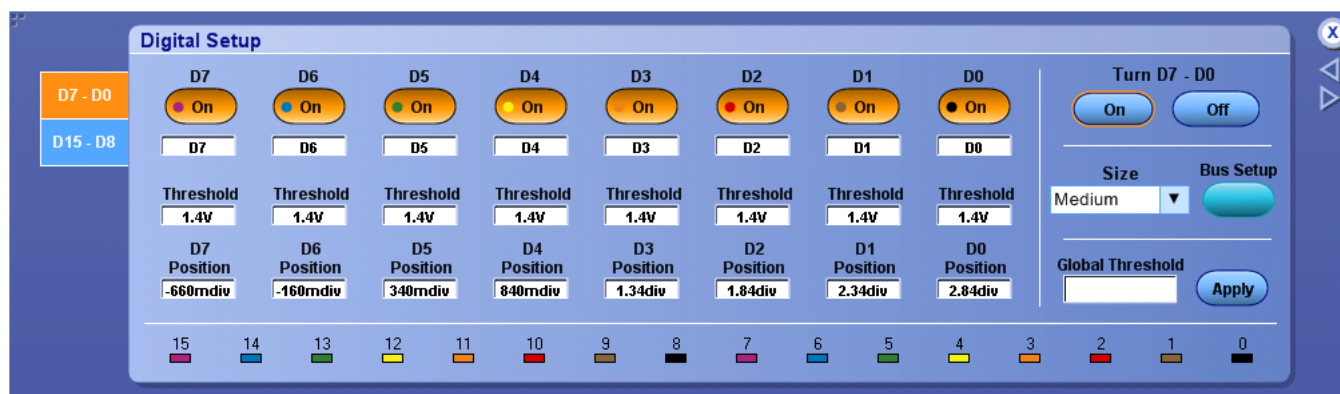

Behavior

As you turn on the digital channels, the corresponding channel indicator along the bottom of the menu changes to match the color on the digital channel button.

What do you want to do next?

[Learn about bus setups.](#)

[Learn about bus configuration.](#)

[Learn more about digital setups.](#)

Set the display size of logic channels

NOTE. The Display Size of Logic Channels option is available only on MSO5000B and MSO7000C/DX Series instruments and DPO5000B Series instruments with option MSOE installed, and DPO7000DX instruments with option MSOU installed.

From the Digital menu, select Digital Setup and use the Size selection box to define the height of the digital channel in the display.

To use

- Click Size and select from the drop-down list: Large, Medium, Small, and Extra Small.



Behavior

- Large displays the channel as a division.
- Medium displays the channel as half a division.
- Small displays the channel as a quarter of a division.
- Extra Small displays the channel as a fifth of a division.

What do you want to do next?

[Learn about setting up digital signals.](#)

[Learn more about digital setups.](#)

[Learn about bus setups.](#)

[Learn about bus configuration.](#)

Set the global threshold for digital channels

NOTE. The Global Threshold for Digital Channels option is available only on MSO5000B and MSO7000C/DX Series instruments and DPO5000B Series instruments with option MSOE installed, and DPO7000DX instruments with option MSOU installed.

From the Digital menu, select Digital Setup and use the Global Threshold entry box to define the same voltage threshold level for all digital channels.

To use

- Click the Global Threshold entry box and enter a value for the voltage threshold level with the keypad.
- Click the Apply button.



Behavior

The instrument sets the thresholds for all digital channels to the same voltage level.

What do you want to do next?

[Learn how to set the threshold for Ch1-Ch4 \(live\) and Math1-Math4 channels to use as logic waveforms.](#)

[Learn more about digital setups.](#)

[Learn about bus setups.](#)

[Learn about bus configuration.](#)

Set up digital channels

NOTE. The Digital Channels D15-D8 and D7-D0 Tabs option is available only on MSO5000B and MSO7000C/DX Series instruments and DPO5000B Series instruments with option MSOE installed, and DPO7000DX instruments with option MSOU installed.

From the Digital Setup menu, select the D15-D8 or the D7-D0 tab to set up digital channels.

To use

- Click a digital channel to turn on or turn off the display of the channel.
- Click the Threshold entry box and use the keypad to enter a value for the voltage level or use the multipurpose knobs to select a voltage level.
- Click the Position entry box and move the channel using the multipurpose knob.
- Select the size of the waveform in the display.

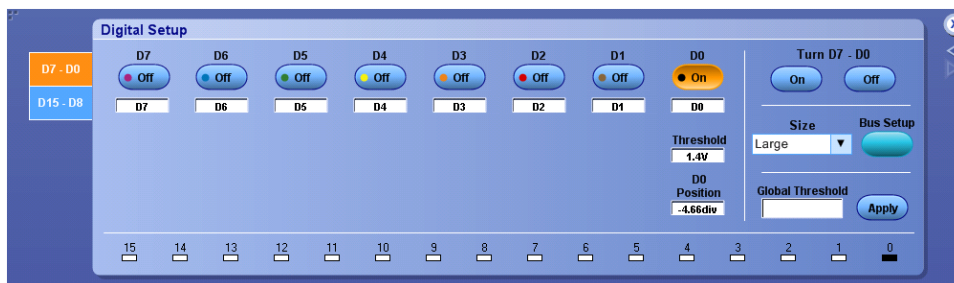

Behavior

As you turn on digital channels, the corresponding channel indicator along the bottom of the menu changes to match the color on the digital channel button.

What do you want to do next?

[*Learn about bus setups.*](#)

[*Learn about bus configuration*](#)

[*Learn more about digital setups.*](#)

[*Learn how to turn on or turn off the digital channels.*](#)

Bus setups

Bus setup control window (Config tab)

From the Digital menu (or the Vertical menu), select Bus Setup.

Some instruments support serial data standards: SPI, I²C, USB, RS232, 8b10b, and MIPI. When you select a serial bus, the instrument assigns specific bus signals (called components) to default digital channels and sets the threshold to an appropriate voltage level.

Overview

Use the Bus Setup Control windows to define up to 16 buses from which to acquire, decode, and display data. You can set up serial buses for the SPI, I²C, USB, RS232, 8b10b, and MIPI serial data standards. You can also set up clocked or unclocked parallel buses.

NOTE. The instrument displays I2C as the IC (Inter-IC Bus) serial bus selection.

Buses are not available on DPO7000SX instruments.

For information on the controls, click the buttons.

- [Bus List](#)
- [Display & Clear](#)
- [Label](#)
- [Position](#)
- [I2C Bus](#)
- [SPI Bus](#)
- [RS232 Bus](#)
- [USB Bus](#)
- [MIPI CSI-2 Bus](#)
- [MIPI DSI-1 Bus](#)
- [8B10B Bus](#)
- [PCIe Bus](#)
- [CAN Bus](#)
- [LIN Bus](#)
- [FLEXRAY Bus](#)
- [MIL-1553 Bus](#)
- [Ethernet Bus](#)
- [Custom Bus](#)
- [Parallel Bus](#)
- [Clocked Parallel Bus](#)

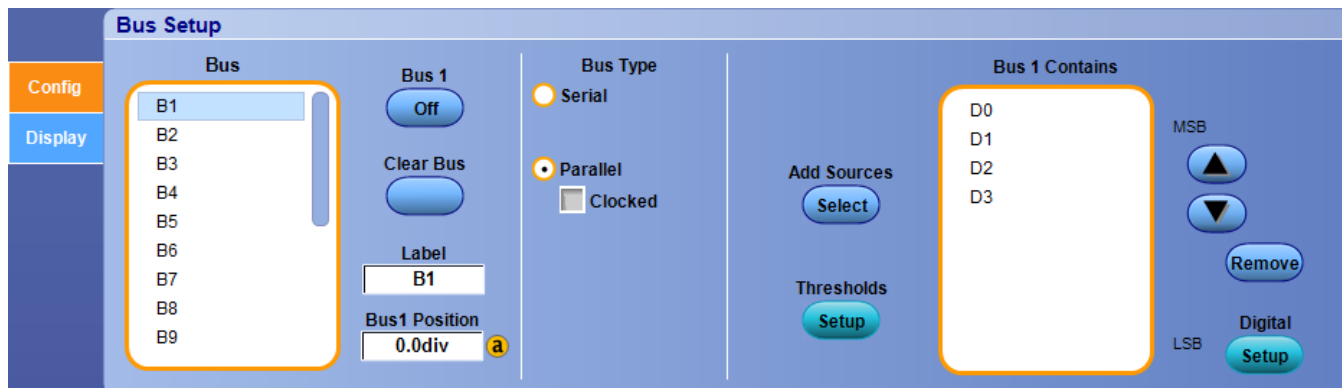

To use

- Click and drag the scroll bar until the desired Bus number <B1-B16> or name is visible
- Click on a Bus number or name
- Click the corresponding Bus number Off/On button
- To name the bus, click the Label entry box and enter a name with the keyboard
- To change the vertical position of the bus on the display, click the Bus Position entry box and use the keypad or the multipurpose knob to move the bus
- Click a Bus Type: Serial or Parallel
- For Parallel buses, click the Add Sources button and build your bus with any combination of D15-D0, Ch1-Ch4, and M1-M4 channels
- For Serial buses, select one of the available options from the drop-down list; the instrument provides additional parameters to set up for each standard

Behavior

Click the Clear Bus button to clear all the channels from the selected bus and remove the bus from the display.

TIP. Click the Digital Setup button to quickly access the Digital Setup control window for the parallel bus type.

What do you want to do next?

- [Learn about bus configuration.](#)
- [Learn about digital setups.](#)
- [Learn how to set up digital waveforms.](#)
- [Learn how to view analog characteristics of a digital waveform.](#)
- [Learn how to set up a bus.](#)
- [Learn how to trigger on a bus.](#)
- [Learn how to track down serial bus anomalies.](#)
- [Learn how to troubleshoot circuits using a parallel bus.](#)

[Learn how to troubleshoot a serial bus.](#)

Bus selection list

From the Bus Setup window, select a bus to set up from the list of Bus selections <B1-B16>.

To use

- Click and drag the scroll bar until the desired Bus number or name is visible.
- Click the Bus number <B1–B16> or name to be set up.

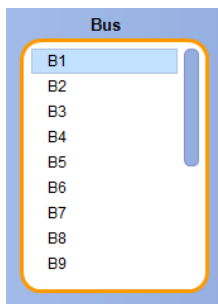

Behavior



Click the Bus button  to display the bus (On) or to remove it from the display (Off).

What do you want to do next?

[Learn more about bus setups.](#)

[Learn about bus configuration.](#)

[Learn about digital setups.](#)

Bus search selection list

From the Search Configure window, select a bus source to set up from the list of Source selections <B1-B16>.

To use

- Select the Search Slot from the drop-down list.
- Click and turn (drag) the scroll wheel or click the up/down arrows until the desired Bus number or name is visible.
- Click the Bus number <B1–B16> or name to be set up.
- Click OK.

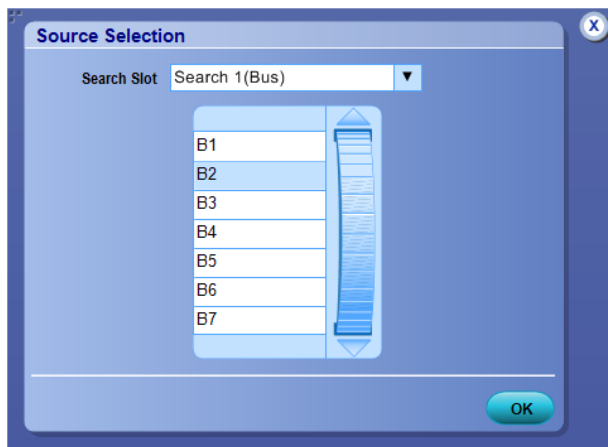

Behavior

Click the OK to return to the Search Configure .

What do you want to do next?

[Learn more about bus setups.](#)

[Learn about bus configuration.](#)

[Learn about digital setups.](#)

Display or clear a bus

From the Bus Setup window, select the Bus number <B1-B16> or name that you want to display or clear from the display.

To use

- Select the bus number or name from the list.
- Click the Bus button to select On and display the bus.
- To clear and remove a bus, click the Clear Bus button.

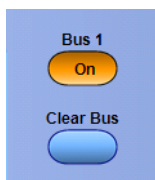

Behavior

A parallel bus must be defined before it can be displayed.

When you click the Clear Bus button, the instrument removes the bus with the channels used to build the bus, and the Bus button changes to Off.

What do you want to do next?

[Learn more about bus setups.](#)

[Learn about bus configuration.](#)

[Learn about digital setups.](#)

Label a bus

From the Bus Setup window, select a Bus number <B1-B16> to label from the Bus list.

To use

Double-click the Label entry box and enter a name up to 7 characters long with the keyboard.



Here is an example of a setup for an SPI bus with a label.

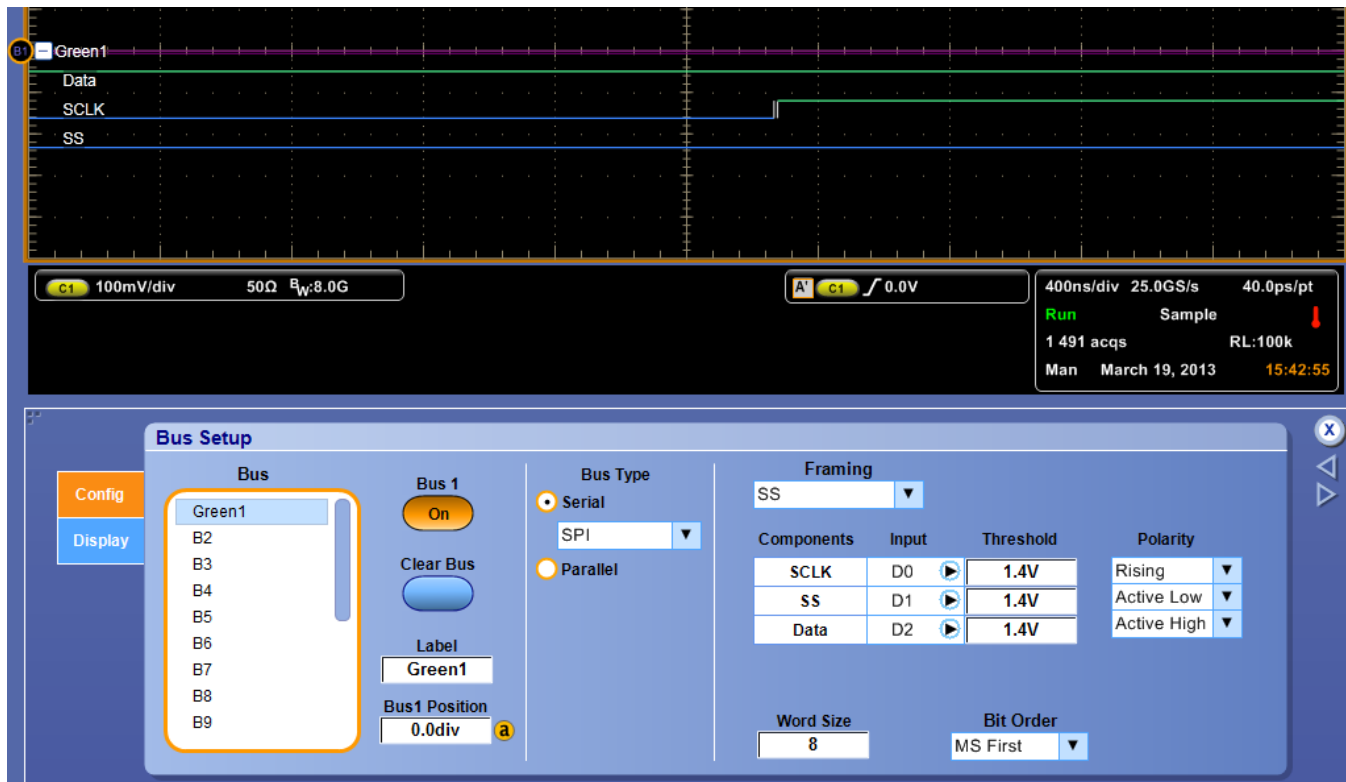

Behavior

The bus label appears in the list of bus setups in the Config and Display tabs. The instrument also displays the label adjacent to the bus number on the screen for easy identification.

What do you want to do next?

[Learn more about bus setups.](#)

[Learn about bus configuration.](#)

[Learn about digital setups.](#)

Change the bus position

From the Bus Setup window, select the Bus number <B1-B16> or name to position on the display from the Bus list.

To use

To change the vertical position of the bus on the display, click the Bus Position entry box and use the keypad or the multipurpose knob to enter a new position.

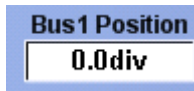

Behavior

The instrument moves the bus on the screen to the new position.

What do you want to do next?

[Learn more about bus setups.](#)

[Learn about bus configuration.](#)

[Learn about digital setups.](#)

Set up an I²C serial bus

NOTE. I²C serial bus setup is available only on instruments with the SR-EMBD option.

From the Bus Setup window, select Serial from the Bus Type list and then select the I²C Serial bus type.

NOTE. The Components for the I²C bus standard are set by the instrument.

For information on the controls, click the buttons.

- [Bus List](#)
- [Display & Clear](#)
- [Label](#)
- [Position](#)
- [Serial Input](#)
- [Serial Threshold](#)

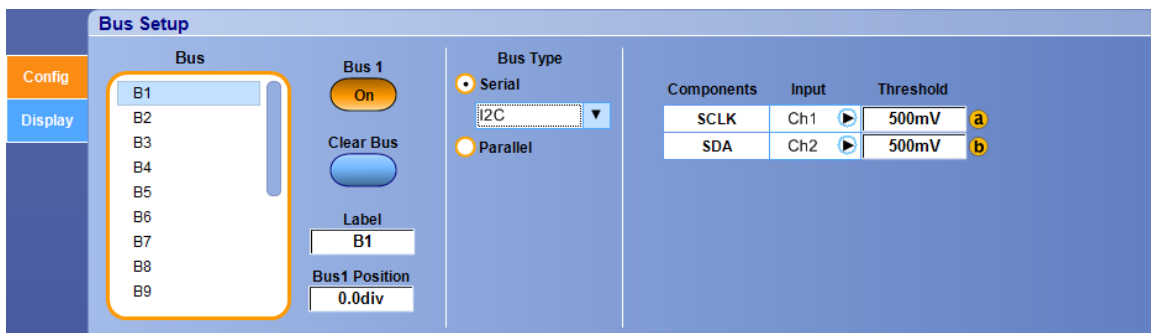

To use

- To change the input for a component, click the Input arrow and select a channel from the cascading list.
- To change the voltage threshold level, click the Threshold entry box and use the keypad to enter a value or use the multipurpose knobs to select a voltage level.

Behavior

The instrument changes the components and voltage threshold levels, and uses those to decode the selected I2C bus.

What do you want to do next?

[Learn more about bus setups.](#)

[Learn about bus configuration.](#)

[Learn about digital setups.](#)

[Learn how to set up an I2C serial bus.](#)

[Learn how to set up an SPI serial bus.](#)

[Learn how to set up a USB serial bus.](#)

[Learn how to set up an RS-232 serial bus.](#)

[Learn how to set up a MIPI DSI1 Serial Bus](#)

[Learn how to set up a MIPI CSI2 Serial Bus](#)

[Learn how to set up an 8B10B Serial Bus](#)

[Learn how to set up a CAN Bus](#)

[Learn how to set up a MIL-1553 Bus](#)

[Learn how to set up an Ethernet Bus](#)

[Learn how to set up a Custom serial bus.](#)

[Learn how to troubleshoot a serial bus.](#)

[Learn how to track down serial bus anomalies.](#)

[Learn how to view analog characteristics of a digital waveform.](#)

[Learn how to trigger on a bus.](#)

Set up an SPI serial bus

NOTE. SPI serial bus setup is available only on instruments with the SR-EMBD option.

From the Bus Setup window, select a bus from the Bus list and then select the SPI Serial bus type.

NOTE. The Components for the SPI bus standard are set by the instrument.

For information on the controls, click the buttons.

- [Bus List](#)
- [Display & Clear](#)
- [Label](#)
- [Position](#)
- [Serial Input](#)
- [Framing](#)
- [Serial Threshold](#)
- [Polarity](#)
- [Idle Time](#)
- [Word Size](#)
- [Bit Order](#)

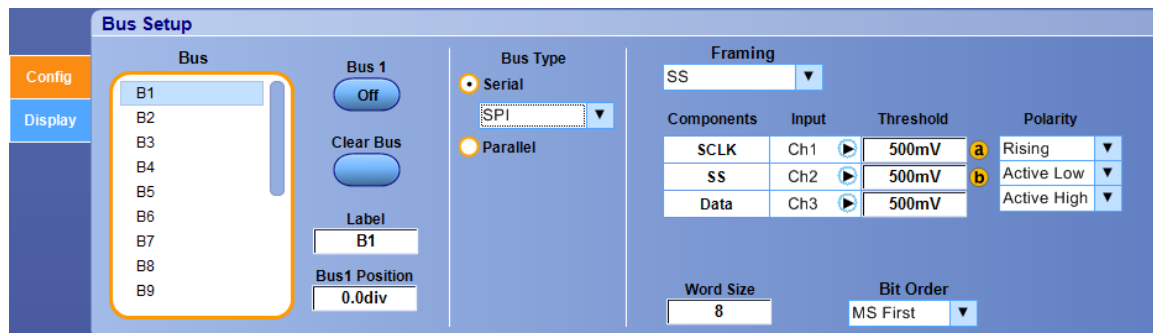

To use

- To change the input for a component, click the Input and select a channel from the cascading lists.
- To change the voltage threshold level, click the Threshold entry box and use the keypad to enter a value or use the multipurpose knobs to select a voltage level.
- To set the polarity, click the Polarity entry box and select from the drop-down list. The selections vary by component.
- To set the word size, click the Word Size entry box and use the keypad to enter a value.
- To set the bit order, click the Bit Order entry box and select from the drop-down list.

Behavior

The instrument changes the components, voltage threshold levels, polarity, word size, and bit order, and uses those to decode the selected SPI bus.

What do you want to do next?

[Learn more about bus setups.](#)

[Learn about bus configuration.](#)

[Learn about digital setups.](#)

[Learn how to set up an I2C serial bus.](#)

[Learn how to set up an SPI serial bus.](#)

[Learn how to set up a USB serial bus.](#)

[Learn how to set up an RS-232 serial bus.](#)

[Learn how to set up a MIPI DSI1 Serial Bus](#)

[Learn how to set up a MIPI CSI2 Serial Bus](#)

[Learn how to set up an 8B10B Serial Bus](#)

[Learn how to set up a CAN Bus](#)

[Learn how to set up a LIN Serial Bus](#)

[Learn how to set up a FLEXRAY Serial Bus](#)

[Learn how to set up a MIL-1553 Bus](#)

[Learn how to set up an Ethernet Bus](#)

[Learn how to set up an Custom serial bus.](#)

[Learn how to troubleshoot a serial bus.](#)

[Learn how to track down serial bus anomalies.](#)

[Learn how to view analog characteristics of a digital waveform.](#)

[Learn how to trigger on a bus.](#)

Set up an RS-232 serial bus

NOTE. RS-232 serial bus setup is available on instruments with the SR-COMP option.

From the Bus Setup window in the Config tab, select a bus from the Bus list and then select the RS-232 Serial bus type.

NOTE. The Components for the RS-232 bus standard are set by the instrument.

For information on the controls, click the buttons.

- [Bus List](#)
- [Display & Clear](#)
- [Label](#)
- [Position](#)
- [Serial Input](#)

- [Serial Threshold](#)
- [Polarity](#)
- [Data Bits](#)
- [Parity](#)
- [Bit Rate](#)

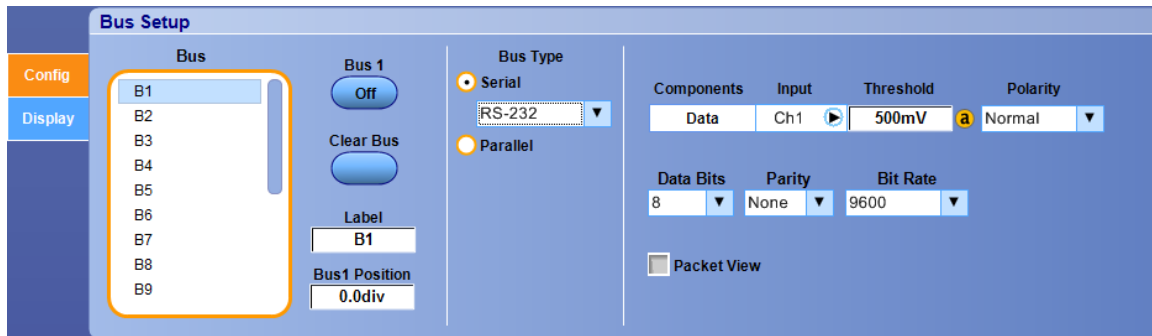

To use

- To change the input for a component, click the Input and select a channel from the cascading lists.
- To change the voltage threshold level, click the Threshold entry box and use the keypad to enter a value or use the multipurpose knobs to select a voltage level.
- To set the polarity, click the Polarity entry box and select from the drop-down list.
- To set the data bits, click the Data Bits entry box and select from the drop-down list.
- To set the parity, click the Parity entry box and select from the drop-down list.
- To set the bit rate, click the Bit Rate entry box and select from the drop-down list.

Behavior

The instrument changes the components, voltage threshold levels, polarity, data bits, parity, and bit rate, and uses those to decode the selected RS-232 bus.

What do you want to do next?

[Learn more about bus setups.](#)

[Learn about bus configuration.](#)

[Learn about digital setups.](#)

[Learn how to set up an I2C serial bus.](#)

[Learn how to set up an SPI serial bus.](#)

[Learn how to set up a USB serial bus.](#)

[Learn how to set up an RS-232 serial bus.](#)

[Learn how to set up a MIPI DSI1 Serial Bus](#)

[Learn how to set up a MIPI CSI2 Serial Bus](#)

[Learn how to set up an 8B10B Serial Bus](#)

- [Learn how to set up a CAN Bus](#)
- [Learn how to set up a MIL-1553 Bus](#)
- [Learn how to set up an Ethernet Bus](#)
- [Learn how to set up an Custom serial bus.](#)
- [Learn how to troubleshoot a serial bus.](#)
- [Learn how to track down serial bus anomalies.](#)
- [Learn how to view analog characteristics of a digital waveform.](#)
- [Learn how to trigger on a bus.](#)

Set up a USB serial bus

NOTE. USB serial bus setup is available only on instruments with the SR-USB option.

From the Bus Setup window in the Config tab, select a bus from the Bus list and then select the USB Serial bus type.

NOTE. The Components for the USB bus standard are set by the instrument.

For information on the controls, click the buttons.

- [Bus List](#)
- [Display & Clear](#)
- [Label](#)
- [Position](#)
- [Serial Input](#)
- [Speed](#)
- [Signal Type](#)
- [Input](#)
- [Serial Threshold \(H\)](#)
- [Serial Threshold \(L\)](#)

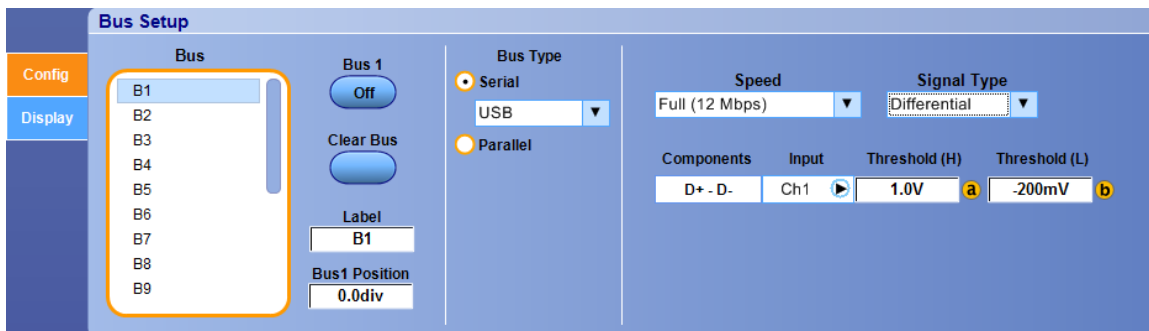

Figure 14: USB bus setup.

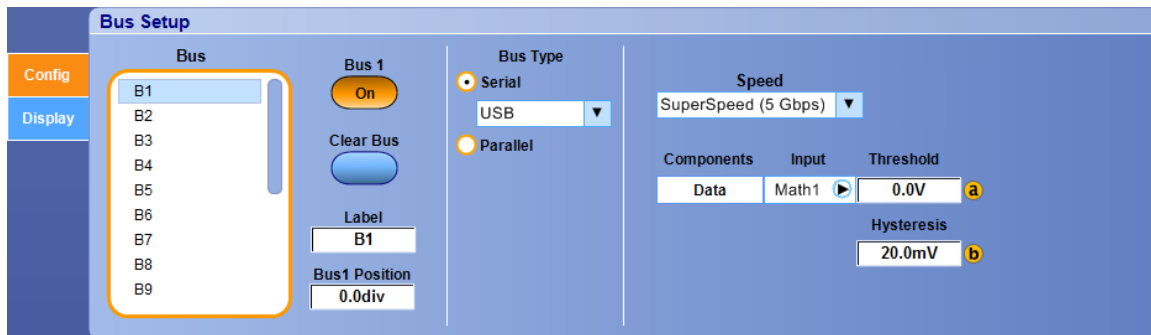

Figure 15: USB bus setup with SuperSpeed selected.

To use

- To change the input for a component, click the Input and select a channel from the cascading lists.
- To change the voltage threshold level, click the Threshold (H) or Threshold (L) entry box and use the keypad to enter a value or use the multipurpose knobs to select a voltage level.
- To set the speed, click the Speed entry box and select from the drop-down list.
- To set the signal type, click the Signal Type (not available with SuperSpeed) entry box and select from the drop-down list.

Behavior

The instrument changes the components, voltage threshold levels, speed, and signal type, and uses those to decode the selected USB bus.

What do you want to do next?

[Learn more about bus setups.](#)

[Learn about bus configuration.](#)

[Learn about digital setups.](#)

[Learn how to set up an I2C serial bus.](#)

[Learn how to set up an SPI serial bus.](#)

[Learn how to set up a USB serial bus.](#)

[Learn how to set up an RS-232 serial bus.](#)

[Learn how to set up a MIPI DSI1 Serial Bus](#)

[Learn how to set up a MIPI CSI2 Serial Bus](#)

[Learn how to set up an 8B10B Serial Bus](#)

[Learn how to set up a CAN Bus](#)

[Learn how to set up a MIL-1553 Bus](#)

[Learn how to set up an Ethernet Bus](#)

[Learn how to set up a Custom serial bus.](#)

[Learn how to troubleshoot a serial bus.](#)

[Learn how to track down serial bus anomalies.](#)

[Learn how to view analog characteristics of a digital waveform.](#)

[Learn how to trigger on a bus.](#)

Set up a MIPI DSI-1 serial bus

NOTE. MIPI DSI-1 serial bus setup is available only on instruments with the SR-DPHY option.

From the Bus Setup window in the Config tab, select a bus from the Bus list and then select the MIPI DSI-1 Serial bus type.

NOTE. The Components for the MIPI DSI-1 bus standard are set by the instrument.

For information on the controls, click the buttons.

- [Bus List](#)
- [Display & Clear](#)
- [Label](#)
- [Position](#)
- [Serial Input](#)
- [Lanes](#)
- [Channel Type](#)
- [Serial Threshold](#)

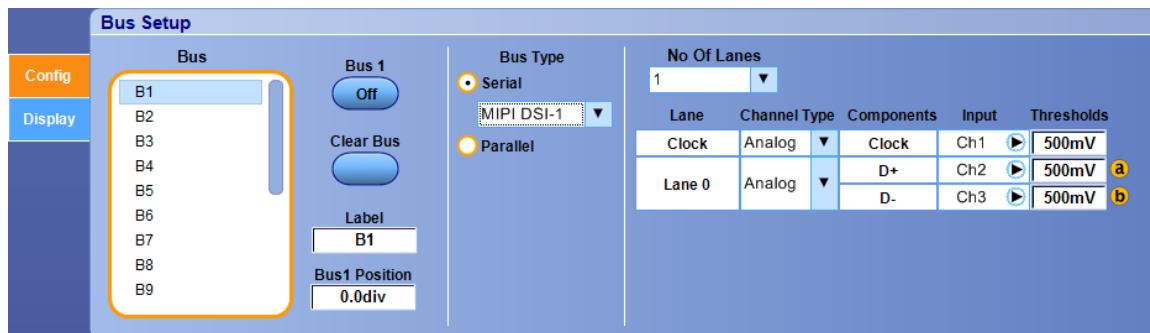

To use

- To set the channel type, click the Channel Type entry box and select from the drop-down list.
- To change the input for a component, click the Input and select a channel from the cascading lists.
- To change the voltage threshold level, click the Threshold entry box and use the keypad to enter a value or use the multipurpose knobs to select a voltage level. Set the threshold on the low power portion of the waveform.

Behavior

The instrument changes the components, voltage threshold levels, polarity, data bits, parity, and bit rate, and uses those to decode the selected MIPI DSI-1 bus.

What do you want to do next?

[Learn more about bus setups.](#)

[Learn about bus configuration.](#)

[Learn about digital setups.](#)

[Learn how to set up an I2C serial bus.](#)

[Learn how to set up an SPI serial bus.](#)

[Learn how to set up a USB serial bus.](#)

[Learn how to set up an RS-232 serial bus.](#)

[Learn how to set up a MIPI DSI1 Serial Bus](#)

[Learn how to set up a MIPI CSI2 Serial Bus](#)

[Learn how to set up an 8B10B Serial Bus](#)

[Learn how to set up a CAN Bus](#)

[Learn how to set up a MIL-1553 Bus](#)

[Learn how to set up an Ethernet Bus](#)

[Learn how to set up a Custom serial bus.](#)

[Learn how to troubleshoot a serial bus.](#)

[Learn how to track down serial bus anomalies.](#)

[Learn how to view analog characteristics of a digital waveform.](#)

[Learn how to trigger on a bus.](#)

[Learn to view the bus packets.](#)

Set up a MIPI CSI-2 serial bus

NOTE. MIPI CSI-2 serial bus setup is available only on instruments with the SR-DPHY option.

From the Bus Setup window in the Config tab, select a bus from the Bus list and then select the MIPI CSI-2 Serial bus type.

NOTE. The Components for the MIPI CSI-2 bus standard are set by the instrument.

For information on the controls, click the buttons.

- [Bus List](#)
- [Display & Clear](#)
- [Label](#)
- [Position](#)
- [Serial Input](#)
- [Lanes](#)
- [Channel Type](#)
- [Serial Threshold](#)

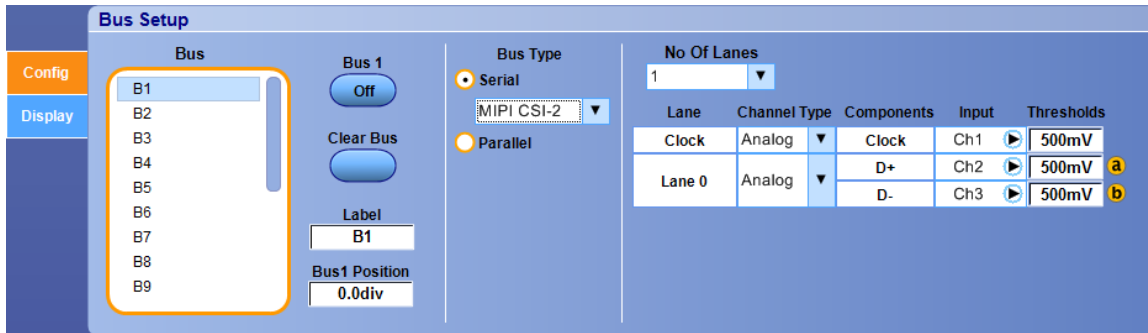

To use

- To set the channel type, click the Channel Type entry box and select from the drop-down list.
- To change the input for a component, click the Input and select a channel from the cascading lists.
- To change the voltage threshold level, click the Threshold entry box and use the keypad to enter a value or use the multipurpose knobs to select a voltage level.

Set the thresholds for the low power data so no high speed data gets mistakenly decoded as low power. This typically means the threshold should be above the high speed levels. The high speed is a differential signal, so the decoder handles the subtraction of the two inputs and automatically applies a threshold of zero to the result.

Behavior

The instrument changes the components, voltage threshold levels, polarity, data bits, parity, and bit rate, and uses those to decode the selected MIPI CSI-2 bus.

What do you want to do next?

[Learn more about bus setups.](#)

[Learn about bus configuration.](#)

[Learn about digital setups.](#)

[Learn how to set up an I2C serial bus.](#)

[Learn how to set up an SPI serial bus.](#)

[Learn how to set up a USB serial bus.](#)

[Learn how to set up an RS-232 serial bus.](#)

[Learn how to set up a MIPI DSI1 Serial Bus](#)

[Learn how to set up a MIPI CSI2 Serial Bus](#)

[Learn how to set up an 8B10B Serial Bus](#)

[Learn how to set up a CAN Bus](#)

[Learn how to set up a MIL-1553 Bus](#)

[Learn how to set up an Ethernet Bus](#)

[Learn how to set up an Custom serial bus.](#)

[Learn how to troubleshoot a serial bus.](#)

[Learn how to track down serial bus anomalies.](#)

[Learn how to view analog characteristics of a digital waveform.](#)

[Learn how to trigger on a bus.](#)

[Learn to view the bus packets.](#)

Set up an 8B10B serial bus

NOTE. 8B10B serial bus setup is available only on instruments with the SR-810B or ST6G options.

From the Bus Setup window in the Config tab, select a bus from the Bus list and then select the 8B10B Serial bus type.

NOTE. The Components for the 8B10B bus standard are set by the instrument.

For information on the controls, click the buttons.

- [Bus List](#)
- [Display & Clear](#)
- [Label](#)
- [Position](#)
- [Serial Input](#)
- [Data Rate](#)
- [Input](#)
- [Serial Threshold](#)

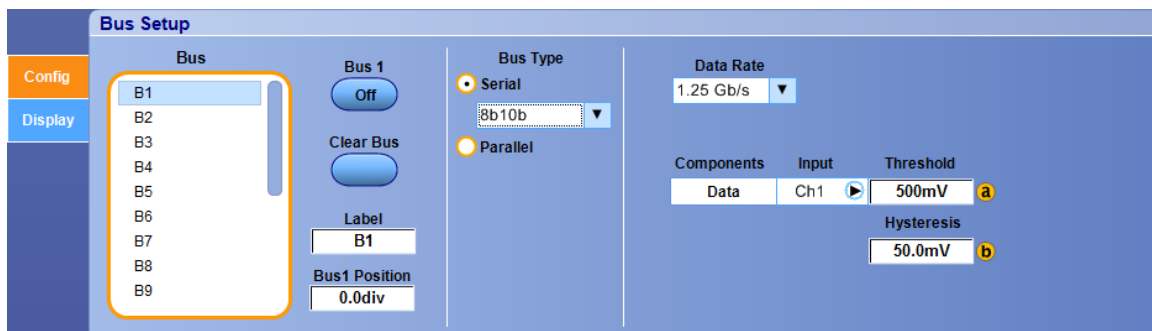

To use

- To change the input for a component, click the Input and select a channel from the cascading lists.
- To change the voltage threshold level, click the Threshold entry box and use the keypad to enter a value or use the multipurpose knobs to select a voltage level.
- To change the voltage hysteresis level, click the Hysteresis entry box and use the keypad to enter a value or use the multipurpose knobs to select a voltage level.
- To set the data rate, click the Data Rate entry box and select from the drop-down list.
- To set the serial bus type, click the Serial Bus Type entry box and select from the drop-down list.

Behavior

The instrument changes the components, voltage threshold levels, speed, and signal type, and uses those to decode the selected 8B10B bus.

What do you want to do next?

[Learn more about bus setups.](#)

[Learn about bus configuration.](#)

[Learn about digital setups.](#)

[Learn how to set up an I2C serial bus.](#)

[Learn how to set up an SPI serial bus.](#)

[Learn how to set up a USB serial bus.](#)

[Learn how to set up an RS-232 serial bus.](#)

[Learn how to set up a MIPI DSI1 Serial Bus](#)

[Learn how to set up a MIPI CSI2 Serial Bus](#)

[Learn how to set up an 8B10B Serial Bus](#)

[Learn how to set up a CAN Bus](#)

[Learn how to set up a MIL-1553 Bus](#)

[Learn how to set up an Ethernet Bus](#)

[Learn how to set up an Custom serial bus.](#)

[Learn how to troubleshoot a serial bus.](#)

[Learn how to track down serial bus anomalies.](#)

[Learn how to view analog characteristics of a digital waveform.](#)

[Learn how to trigger on a bus.](#)

Set up a custom serial bus

NOTE. Custom serial bus setup is available only on instruments with the SR-CUST option.

From the Bus Setup window, select Serial from the Bus Type list and then select the Custom Serial bus type.

NOTE. The Components for the Custom bus standard are set by the installed custom decoder.

For information on the controls, click the buttons.

- [Bus List](#)
- [Display & Clear](#)
- [Label](#)
- [Position](#)
- [Serial Input](#)
- [Serial Threshold](#)

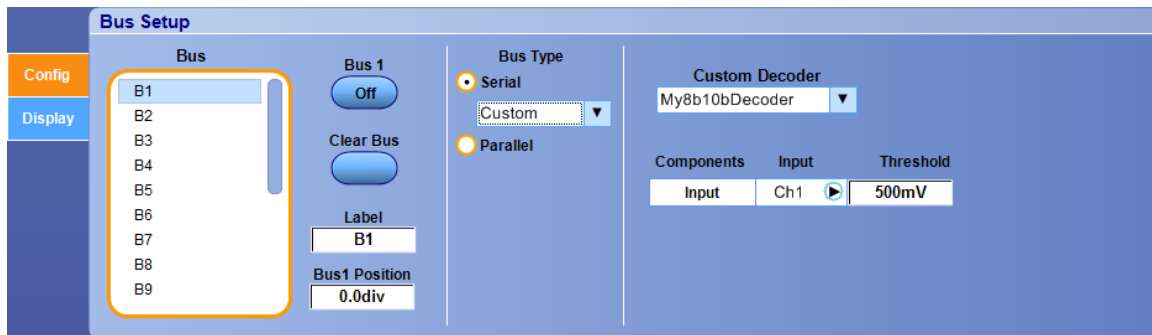

To use

- To change the custom decoder, click the Custom Decoder arrow and select the decoder from the cascading list.
- To change the input for a component, click the Input arrow and select a channel from the cascading list.
- To change the voltage threshold level, click the Threshold entry box and use the keypad to enter a value or use the multipurpose knobs to select a voltage level.

Behavior

The instrument changes the components and voltage threshold levels, and uses those to decode the selected Custom bus.

What do you want to do next?

[Learn more about bus setups.](#)

[Learn about bus configuration.](#)

[Learn about digital setups.](#)

[Learn how to set up an I2C serial bus.](#)

[Learn how to set up an SPI serial bus.](#)

[Learn how to set up a USB serial bus.](#)

[Learn how to set up an RS-232 serial bus.](#)

[Learn how to set up a MIPI DSI1 Serial Bus](#)

[Learn how to set up a MIPI CSI2 Serial Bus](#)

[Learn how to set up an 8B10B Serial Bus](#)

[Learn how to set up a CAN Bus](#)

[Learn how to set up a MIL-1553 Bus](#)

[Learn how to set up an Ethernet Bus](#)

[Learn how to set up a Custom serial bus.](#)

[Learn how to troubleshoot a serial bus.](#)

[Learn how to track down serial bus anomalies.](#)

[Learn how to view analog characteristics of a digital waveform.](#)

[Learn how to trigger on a bus.](#)

Set up a PCIe serial bus

NOTE. PCIe serial bus setup is available only on instruments with the SR-PCIE option.

From the Bus Setup window, select Serial from the Bus Type list and then select the PCIe Serial bus type.

For information on the controls, click the buttons.

- [Bus List](#)
- [Display & Clear](#)
- [Label](#)
- [Position](#)
- [Serial Input](#)
- [Framing](#)
- [Data Rate](#)
- [Serial Threshold](#)

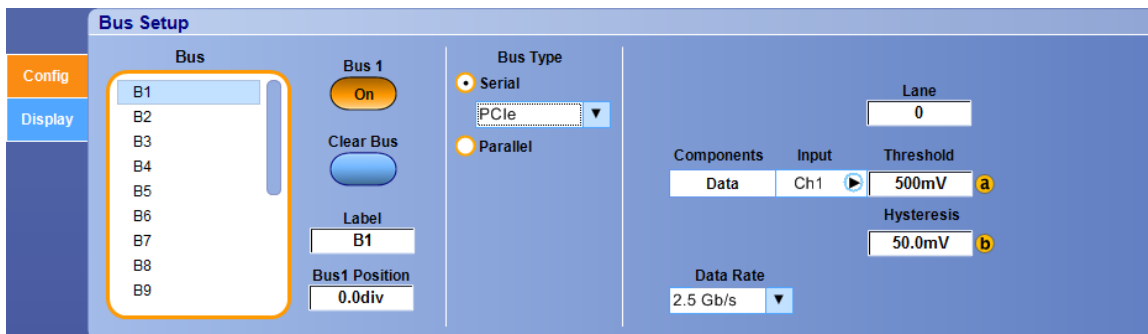

To use

- To change the input for a component, click the Input and select a channel from the cascading lists.
- To set the serial bus type, click the Serial Bus Type entry box and select from the drop-down list.
- To change the voltage threshold level, click the Threshold entry box and use the keypad to enter a value or use the multipurpose knobs to select a voltage level.
- To change the voltage hysteresis level, click the Hysteresis entry box and use the keypad to enter a value or use the multipurpose knobs to select a voltage level.
- To set the data rate, click the Data Rate entry box and select from the drop-down list.

Behavior

The instrument changes the components and voltage threshold levels, and uses those to decode the selected bus.

What do you want to do next?

[Learn more about bus setups.](#)

[Learn about bus configuration.](#)

[Learn about digital setups.](#)

[Learn how to set up an I2C serial bus.](#)

[Learn how to set up an SPI serial bus.](#)

[Learn how to set up a USB serial bus.](#)

[Learn how to set up an RS-232 serial bus.](#)

[Learn how to set up a MIPI DSI1 Serial Bus](#)

[Learn how to set up a MIPI CSI2 Serial Bus](#)

[Learn how to set up an 8B10B Serial Bus](#)

[Learn how to set up a CAN Bus](#)

[Learn how to set up a LIN Serial Bus](#)

[Learn how to set up a FLEXRAY Serial Bus](#)

[Learn how to set up a MIL-1553 Bus](#)

[Learn how to set up an Ethernet Bus](#)

[Learn how to set up a PCIe Serial Bus](#)

[Learn how to set up a Custom serial bus.](#)

[Learn how to troubleshoot a serial bus.](#)

[Learn how to track down serial bus anomalies.](#)

[Learn how to view analog characteristics of a digital waveform.](#)

[Learn how to trigger on a bus.](#)

Set up a CAN serial bus

NOTE. CAN serial bus setup is available only on instruments with the SR-AUTO option.

From the Bus Setup window, select Serial from the Bus Type list and then select the CAN Serial bus type.

For information on the controls, click the buttons.

- [Bus List](#)
- [Display & Clear](#)
- [Label](#)
- [Position](#)
- [Serial Input](#)
- [Serial Threshold](#)

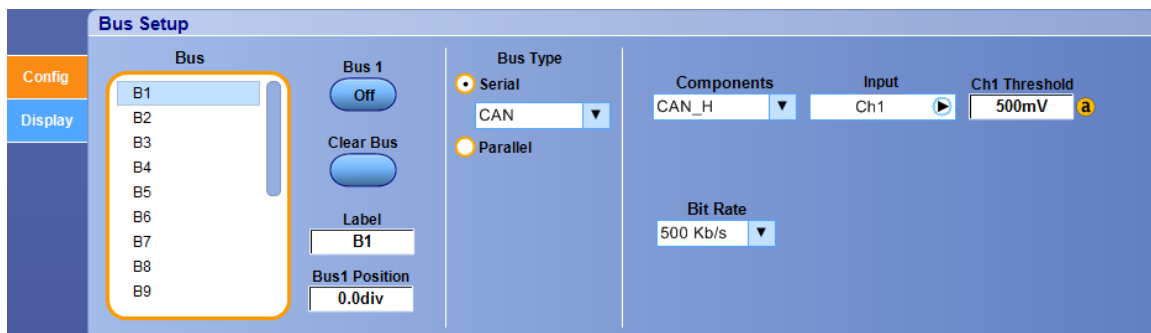

To use

- To change the input for a component, click the Input and select a channel from the cascading lists.
- To set the serial bus type, click the Serial Bus Type entry box and select from the drop-down list.
- To change the voltage threshold level, click the Threshold entry box and use the keypad to enter a value or use the multipurpose knobs to select a voltage level.
- To change the bit rate, click the Bit Rate and select the rate from the cascading list.

Behavior

The instrument changes the components and voltage threshold levels, and uses those to decode the selected bus.

What do you want to do next?

[Learn more about bus setups.](#)

[Learn about bus configuration.](#)

[Learn about digital setups.](#)

[Learn how to set up an I2C serial bus.](#)

[Learn how to set up an SPI serial bus.](#)

[Learn how to set up a USB serial bus.](#)

[Learn how to set up an RS-232 serial bus.](#)

[Learn how to set up a MIPI DSI1 Serial Bus](#)

[Learn how to set up a MIPI CSI2 Serial Bus](#)

[Learn how to set up an 8B10B Serial Bus](#)

[Learn how to set up a CAN Bus](#)

[Learn how to set up a LIN Serial Bus](#)

[Learn how to set up a FLEXRAY Serial Bus](#)

[Learn how to set up a MIL-1553 Bus](#)

[Learn how to set up an Ethernet Bus](#)

[Learn how to set up an Custom serial bus.](#)

[Learn how to troubleshoot a serial bus.](#)

[Learn how to track down serial bus anomalies.](#)

[Learn how to view analog characteristics of a digital waveform.](#)

[Learn how to trigger on a bus.](#)

Set up a LIN serial bus

NOTE. LIN serial bus setup is available only on instruments with the SR-AUTO option.

From the Bus Setup window, select Serial from the Bus Type list and then select the LIN Serial bus type.

For information on the controls, click the buttons.

- [Bus List](#)
- [Display & Clear](#)
- [Label](#)
- [Position](#)
- [Serial Input](#)
- [Serial Threshold](#)

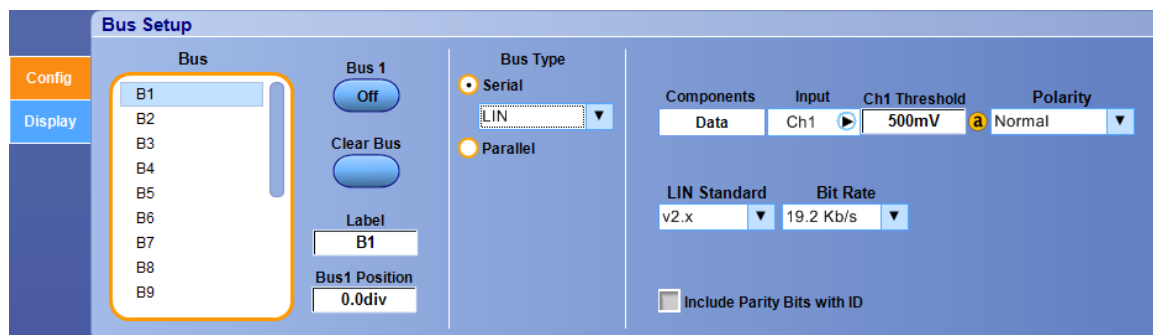

To use

- To change the input for a component, click the Input and select a channel from the cascading lists.
- To set the serial bus type, click the Serial Bus Type entry box and select from the drop-down list.
- To change the voltage threshold level, click the Threshold entry box and use the keypad to enter a value or use the multipurpose knobs to select a voltage level.
- To set the polarity, click the Polarity entry box and select from the drop-down list.
- To set the LIN standard, click the LIN Standard entry box and select from the drop-down list.
- To set the bit rate, click the Bit Rate entry box and select from the drop-down list.

Behavior

The instrument changes the components and voltage threshold levels, and uses those to decode the selected bus.

What do you want to do next?

[Learn more about bus setups.](#)

[Learn about bus configuration.](#)

[Learn about digital setups.](#)

[Learn how to set up an I2C serial bus.](#)

- [Learn how to set up an SPI serial bus.](#)
- [Learn how to set up a USB serial bus.](#)
- [Learn how to set up an RS-232 serial bus.](#)
- [Learn how to set up a MIPI DSI1 Serial Bus](#)
- [Learn how to set up a MIPI CSI2 Serial Bus](#)
- [Learn how to set up an 8B10B Serial Bus](#)
- [Learn how to set up a CAN Bus](#)
- [Learn how to set up a LIN Serial Bus](#)
- [Learn how to set up a FLEXRAY Serial Bus](#)
- [Learn how to set up a MIL-1553 Bus](#)
- [Learn how to set up an Ethernet Bus](#)
- [Learn how to set up a PCIe Serial Bus](#)
- [Learn how to set up an Custom serial bus.](#)
- [Learn how to troubleshoot a serial bus.](#)
- [Learn how to track down serial bus anomalies.](#)
- [Learn how to view analog characteristics of a digital waveform.](#)
- [Learn how to trigger on a bus.](#)

Set up a FLEXRAY serial bus

NOTE. FLEXRAY serial bus setup is available only on instruments with the SR-AUTO option.

From the Bus Setup window, select Serial from the Bus Type list and then select the FLEXRAY Serial bus type.

For information on the controls, click the buttons.

- [Bus List](#)
- [Display & Clear](#)
- [Label](#)
- [Position](#)
- [Serial Input](#)
- [Serial Threshold](#)

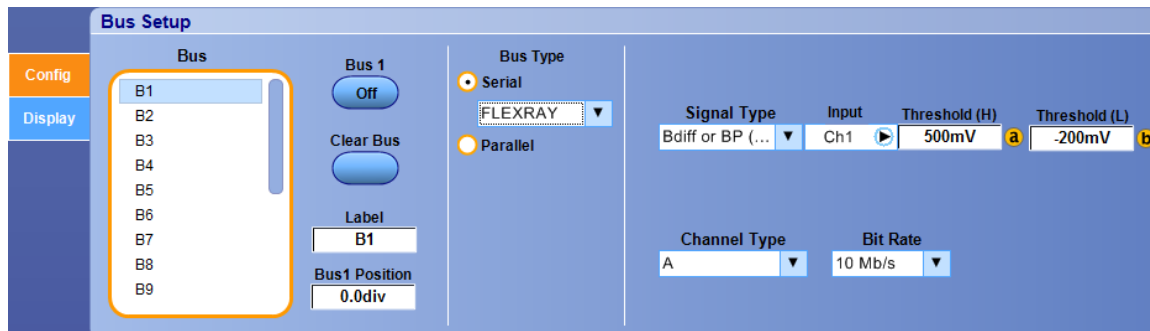

To use

- To change the input for a component, click the Input and select a channel from the cascading lists.
- To set the signal type, click the Signal Type entry box and select from the drop-down list.
- To change a voltage threshold level, click the Threshold entry box and use the keypad to enter a value or use the multipurpose knobs to select a voltage level.
- To set the channel type, click the Channel Type entry box and select from the drop-down list.
- To set the bit rate, click the Bit Rate entry box and select from the drop-down list.

Behavior

The instrument changes the components and voltage threshold levels, and uses those to decode the selected bus.

What do you want to do next?

[Learn more about bus setups.](#)

[Learn about bus configuration.](#)

[Learn about digital setups.](#)

[Learn how to set up an I2C serial bus.](#)

[Learn how to set up an SPI serial bus.](#)

[Learn how to set up a USB serial bus.](#)

[Learn how to set up an RS-232 serial bus.](#)

[Learn how to set up a MIPI DSI1 Serial Bus](#)

[Learn how to set up a MIPI CSI2 Serial Bus](#)

[Learn how to set up an 8B10B Serial Bus](#)

[Learn how to set up a CAN Bus](#)

[Learn how to set up a LIN Serial Bus](#)

[Learn how to set up a FLEXRAY Serial Bus](#)

[Learn how to set up a MIL-1553 Bus](#)

[Learn how to set up an Ethernet Bus](#)

[Learn how to set up a PCIe Serial Bus](#)

[Learn how to set up a Custom serial bus.](#)

[Learn how to troubleshoot a serial bus.](#)

[Learn how to track down serial bus anomalies.](#)

[Learn how to view analog characteristics of a digital waveform.](#)

[Learn how to trigger on a bus.](#)

Set up a MIL-1553 serial bus

NOTE. MIL-STD-1553 serial bus setup is available only on instruments with the SR-AERO option.

From the Bus Setup window, select Serial from the Bus Type list and then select the MIL-1553 Serial bus type.

For information on the controls, click the buttons.

- [Bus List](#)
- [Display & Clear](#)
- [Label](#)
- [Position](#)
- [Serial Input](#)
- [Serial Threshold](#)

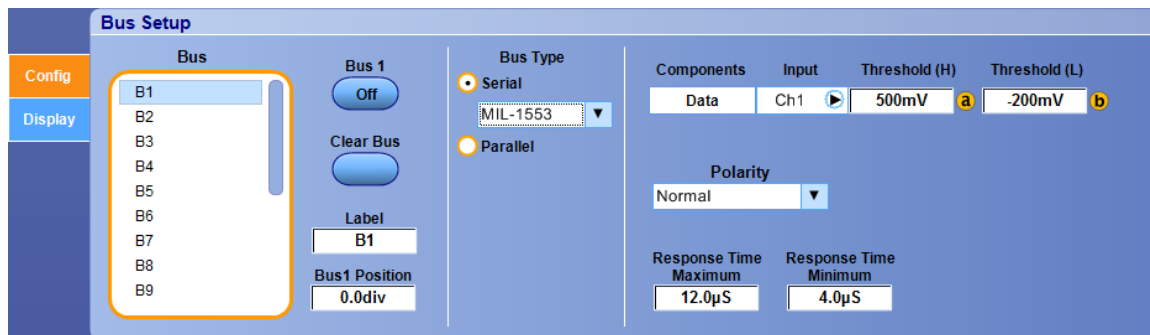

To use

- To change the input for a component, click the Input and select a channel from the cascading lists.
- To set the serial bus type, click the Serial Bus Type entry box and select from the drop-down list.
- To change a voltage threshold level, click the Threshold entry box and use the keypad to enter a value or use the multipurpose knobs to select a voltage level.
- To select the polarity, click the Polarity and select the polarity from the drop-down list.
- To change the response time maximum and minimum, click a Response Time entry box and use the keypad to enter a value or use the multipurpose knobs to select a time.

Behavior

The instrument changes the components and voltage threshold levels, and uses those to decode the selected bus.

What do you want to do next?

[Learn more about bus setups.](#)

[Learn about bus configuration.](#)

[Learn about digital setups.](#)

[Learn how to set up an I2C serial bus.](#)

[Learn how to set up an SPI serial bus.](#)

[Learn how to set up a USB serial bus.](#)

[Learn how to set up an RS-232 serial bus.](#)

[Learn how to set up a MIPI DSI1 Serial Bus](#)

[Learn how to set up a MIPI CSI2 Serial Bus](#)

[Learn how to set up an 8B10B Serial Bus](#)

[Learn how to set up a CAN Bus](#)

[Learn how to set up a LIN Serial Bus](#)

[Learn how to set up a FLEXRAY Serial Bus](#)

[Learn how to set up a MIL-1553 Bus](#)

[Learn how to set up an Ethernet Bus](#)

[Learn how to set up a PCIe Serial Bus](#)

[Learn how to set up a Custom serial bus.](#)

[Learn how to troubleshoot a serial bus.](#)

[Learn how to track down serial bus anomalies.](#)

[Learn how to view analog characteristics of a digital waveform.](#)

[Learn how to trigger on a bus.](#)

Set up an ethernet serial bus

NOTE. Ethernet serial bus setup is available only on instruments with the SR-ENET option.

From the Bus Setup window, select Serial from the Bus Type list and then select the Ethernet Serial bus type.

For information on the controls, click the buttons.

- [Bus List](#)
- [Display & Clear](#)
- [Label](#)
- [Position](#)
- [Serial Input](#)
- [Serial Threshold](#)

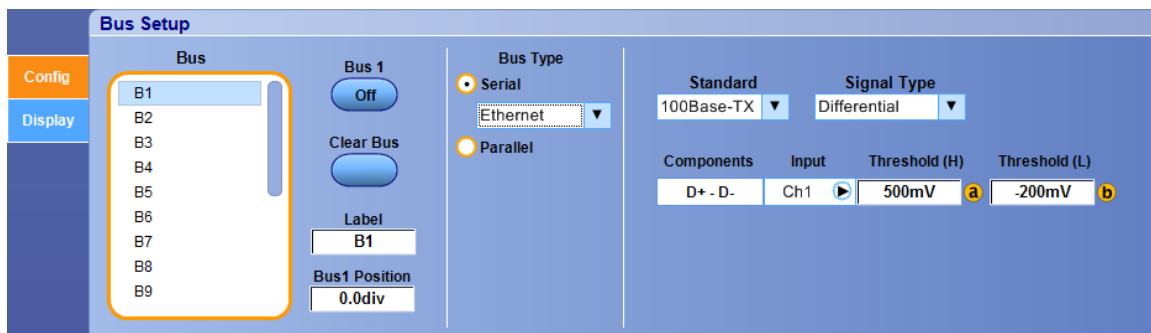

To use

- To set the serial bus type, click the Serial Bus Type entry box and select from the drop-down list.
- To select the standard, click the Standard and select the standard from the drop-down list.
- To select the signal type, click the Signal Type and select the signal type from the drop-down list.
- To change the input for a component, click the Input and select a channel from the cascading lists.
- To change a voltage threshold level, click the Threshold entry box and use the keypad to enter a value or use the multipurpose knobs to select a voltage level.

Behavior

The instrument uses the selected components and voltage threshold levels to decode the selected bus.

What do you want to do next?

[Learn more about bus setups.](#)

[Learn about bus configuration.](#)

[Learn about digital setups.](#)

[Learn how to set up an I2C serial bus.](#)

[Learn how to set up an SPI serial bus.](#)

[Learn how to set up a USB serial bus.](#)

[Learn how to set up an RS-232 serial bus.](#)

[Learn how to set up a MIPI DSI1 Serial Bus](#)

[Learn how to set up a MIPI CSI2 Serial Bus](#)

[Learn how to set up an 8B10B Serial Bus](#)

[Learn how to set up a CAN Bus](#)

[Learn how to set up a LIN Serial Bus](#)

[Learn how to set up a FLEXRAY Serial Bus](#)

[Learn how to set up a MIL-1553 Bus](#)

[Learn how to set up an Ethernet Bus](#)

[Learn how to set up a PCIe Serial Bus](#)

[Learn how to set up a Custom serial bus.](#)

[Learn how to troubleshoot a serial bus.](#)

[Learn how to track down serial bus anomalies.](#)

[Learn how to view analog characteristics of a digital waveform.](#)

[Learn how to trigger on a bus.](#)

Select the number of lanes

From the Bus Setup window, select Serial from the Bus Type list and then select one of the bus types.

To use

To change the number of lanes for the bus, click the No Of Lanes and select from the cascading list.

| No Of Lanes | | | | |
|-------------|--------------|------------|-------|------------|
| No Of Lanes | Channel Type | Components | Input | Thresholds |
| 1 | | | | |
| 2 | | | | |
| 3 | Analog | Clock | Ch1 | 500mV |
| 4 | Lane 0 | D+ | Ch2 | 500mV |
| | | D- | Ch3 | 500mV |
| Lane 1 | Analog | D+ | Ch2 | 1.4V |
| | | D- | Ch3 | 1.4V |
| Lane 2 | Analog | D+ | Ch2 | 1.4V |
| | | D- | Ch3 | 1.4V |

Behavior

The instrument acquires data from the number of lanes you select. You can select a maximum of 4 lanes on MSO instruments, other instruments only allow 1 lane.

What do you want to do next?

[Learn more about bus setups.](#)

[Learn about bus configuration.](#)

[Learn about digital setups.](#)

Select the serial bus channel type

NOTE. Serial bus Channel Type is only available on MSO7000C/DX models.

From the Bus Setup window, select Serial from the Bus Type list and then select one of the bus types.

To use

To change the channel type for the displayed components of the bus, click the Channel Type and select from the cascading list.

| Channel Type | |
|--------------|---|
| Analog | ▼ |
| Digital | |

Behavior

The instrument acquires data from the channel you select for each component. The channel type supported are analog or digital (MSO models only) input. The analog input consists of two analog signals (D+ and D-). The digital input consists of three digital signals (D+, D-, and D+/D- [differential probing between D+ and D-]).

What do you want to do next?

[Learn more about bus setups.](#)

[Learn about bus configuration.](#)

[Learn about digital setups.](#)

Select the serial bus channel input

From the Bus Setup window, select Serial from the Bus Type list and then select one of the bus types.

To use

To change the input for the displayed components of the bus, click the Input and select from the cascading list. Digital channels are not available on SX models.

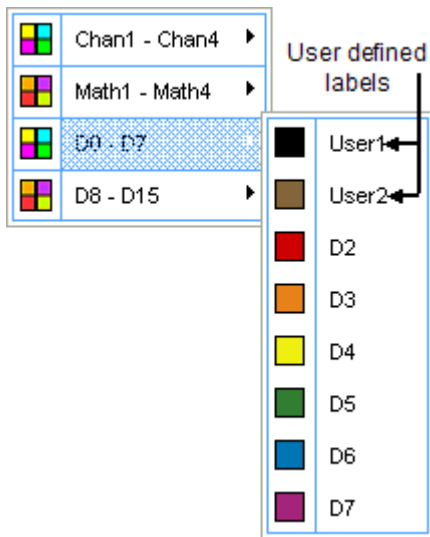

NOTE. You have the option to add user-defined labels for the bus sources.

Behavior

The instrument acquires data from the channel you select for each component.

What do you want to do next?

[Learn more about bus setups.](#)

[Learn about bus configuration.](#)

[Learn about digital setups.](#)

Select the USB serial bus speed

NOTE. USB serial bus Speed selection is available only on instruments with option SR-USB.

From the Bus Setup window, select Serial from the Bus Type list and then select the USB Serial bus type.

To use

To change the speed for the displayed component of the bus, click Speed and select from the cascading list.

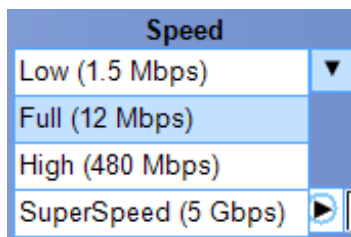

Behavior

The instrument acquires data from the channel you select for each component. SuperSpeed is only available on instruments with a bandwidth of ≥ 8 GHz.

What do you want to do next?

[Learn more about bus setups.](#)

[Learn about bus configuration.](#)

[Learn about digital setups.](#)

Select the USB bus signal type

NOTE. The USB bus Signal Type is available only on instruments with option SR-USB. Signal Type is not available if you select SuperSpeed in the Bus Setup menu.

From the Bus Setup window, select Serial from the Bus Type list and then select the USB Serial bus type.

To use

To change the signal type for the displayed components of the bus, click Signal Type and select from the cascading list.

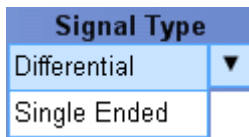

Behavior

The instrument acquires data from the channel you select for each component.

What do you want to do next?

[Learn more about bus setups.](#)

[Learn about bus configuration.](#)

[Learn about digital setups.](#)

Select the data rate

From the Bus Setup window, select Serial from the Bus Type list and then select the Serial bus type.

To use

To change the data rate for the displayed component of the bus, click Data Rate and select from the cascading list. Items in the list depend on the serial bus type.

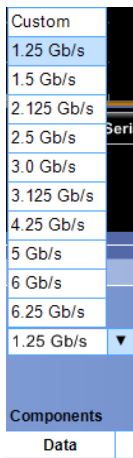

Behavior

The instrument acquires data from the channel you select for each component.

What do you want to do next?

[Learn more about bus setups.](#)

[Learn about bus configuration.](#)

[Learn about digital setups.](#)

Select the serial bus input

From the Bus Setup window, select Serial from the Bus Type list and then select from the cascading list. Digital channels are not available on SX models.

To use

To change the input for the displayed components of the bus, click the Input and select from the cascading list.

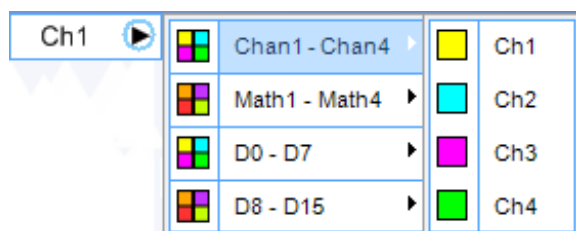

Select the USB bus threshold

From the Bus Setup window, select Serial from the Bus Type list and then select USB Serial bus type.

NOTE. USB bus threshold high and low are available only on instruments with option SR-USB.

To use

To change the voltage high or low threshold level of the component Input, click or entry box respectively and use the keypad to enter a value or use the multipurpose knobs to select a voltage level. Setting the low threshold is only available when the signal type is differential.

Behavior

The instrument acquires data from the channel you select for each component.

What do you want to do next?

[Learn more about bus setups.](#)

[Learn about bus configuration.](#)

[Learn about digital setups.](#)

Select the serial bus channel threshold

From the Bus Setup window, select Serial from the Bus Type list and then select from the cascading list.

NOTE. The serial bus channel Threshold option is available only on instruments with one or more of the SR- options.

To use

To change the voltage threshold level of the component Input, click the Threshold entry box and use the keypad to enter a value or use the multipurpose knobs to select a voltage level.



Behavior

The instrument can use different voltage thresholds levels for each component.

What do you want to do next?

[Learn more about bus setups.](#)

[Learn about bus configuration.](#)

[Learn about digital setups.](#)

Select the SPI bus channel polarity

NOTE. The SPI Bus Channel Polarity option is available only on instruments with option SR-EMBD.

From the Bus Setup window, select the Select tab and the SPI Serial bus type.

To use

- Scroll through the Bus list and select the SPI bus to configure.
- Click the Polarity box and select the polarity from the drop-down list.

Behavior

For the SCLK component:

- Rising causes the instrument to acquire data on the rising edge of the signal.
- Falling causes the instrument to acquire data on the falling edge of the signal.

For the SS component:

- Active Low causes the instrument to decode the bus when the Slave Select signal is at a low level.
- Active High causes the instrument to decode the bus when the Slave Select signal is at a high level.

For the Data component:

- Active Low causes the instrument to decode signals at a low level.
- Active High causes the instrument to decode signals at a high level.

What do you want to do next?

[Learn more about bus setups.](#)

[Learn about bus configuration.](#)

[Learn about digital setups.](#)

Select the RS-232 bus channel polarity

NOTE. The RS-232 Bus Channel Polarity option is available on instruments with option SR-COMP.

From the Bus Setup window, select the Select tab and the RS-232 Serial bus type.

To use

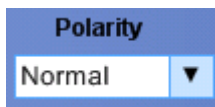

- Scroll through the Bus list and select the RS-232 bus to configure.
- Click the Polarity box and select the polarity from the drop-down list.

Behavior

For the Data component:

- Normal causes the instrument to decode signals at a high level as a binary 1.
- Inverted causes the instrument to decode signals at a high level as a binary 0.

What do you want to do next?

[Learn more about bus setups.](#)

[Learn about bus configuration.](#)

[Learn about digital setups.](#)

Select the RS-232 bus data bits

NOTE. The RS-232 Bus Data Bits option is available only on instruments with option SR-COMP.

From the Bus Setup window, select the Select tab and the RS-232 Serial bus type.

To use



- Scroll through the Bus list and select the RS-232 bus to configure.
- Click the Data Bits box and select the data bits from the drop-down list.

Behavior

You have the option to set the number of data bits in a frame for RS-232 bus to:

- 7.
- 8, the default.
- 9.

What do you want to do next?

[Learn more about bus setups.](#)

[Learn about bus configuration.](#)

[Learn about digital setups.](#)

Select the RS-232 bus parity

NOTE. The RS-232 Bus Parity option is available on instruments with option SR-COMP.

From the Bus Setup window, select the Select tab and the RS-232 Serial bus type.

To use

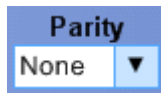

- Scroll through the Bus list and select the RS-232 bus to configure.
- Click the Parity box and select the parity from the drop-down list.

Behavior

Set the bus parity selection to:

- None, the default.
- Odd.
- Even.

NOTE. There is no parity selection when the number of data bits is 9.

What do you want to do next?

[Learn more about bus setups.](#)

[Learn about bus configuration.](#)

[Learn about digital setups.](#)

Select the RS-232 bus bit rate

NOTE. The RS-232 Bus Bit Rate option is available on instruments with option SR-COMP.

From the Bus Setup window, select the Select tab and the RS-232 Serial bus type.

To use

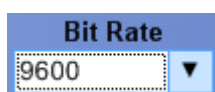

- Scroll through the Bus list and select the RS-232 bus to configure.
- Click the Bit Rate box and select the bit rate from the drop-down list.

Behavior

Set the bus bit rate to:

- 50, 300, 1200, 2400, 9600, 19200, 38400, 115200, 921600, or 10000000. The default value is 9600.
- Custom. To change the bit rate, click the Bit Rate entry box and use the keypad to enter a value.

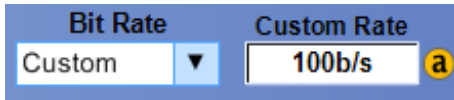

What do you want to do next?

[Learn more about bus setups.](#)

[Learn about bus configuration.](#)

[Learn about digital setups.](#)

Select the SPI bus framing

NOTE. The SPI bus Framing option is available only on instruments with option SR-EMBD.

From the Bus Setup window, select the Select tab and the SPI Serial bus type.

To use

- Select the framing from the drop-down list.
- Select SS framing for three wire SPI decode.
- Select Idle framing for two wire SPI decode.

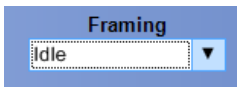

Behavior

The instrument changes the framing and uses that to decode the selected SPI bus.

What do you want to do next?

[Learn more about bus setups.](#)

[Learn about bus configuration.](#)

[Learn about digital setups.](#)

Set the SPI bus idle time

NOTE. The SPI bus Idle Time option is available only on instruments with option SR-EMBD.

From the Bus Setup window, select the Select tab and the SPI Serial bus type.

To use

- Select the Idle framing from the drop-down list.
- To change the idle time, click the Idle Time entry box and use the keypad to enter a value.

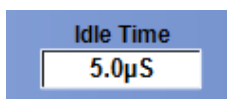

Behavior

The instrument changes the idle time and uses that to decode the selected SPI bus.

What do you want to do next?

[Learn more about bus setups.](#)

[Learn about bus configuration.](#)

[Learn about digital setups.](#)

Set the SPI bus word size

NOTE. The SPI Bus Word Size option is available only on instruments with option SR-EMBD.

From the Bus Setup window, select the Select tab and the SPI Serial bus type.

To use

- Scroll through the Bus list and select the SPI bus to configure.
- Click the Word Size box and enter a size using the key pad. You can also edit the value with the keyboard or multipurpose knob.

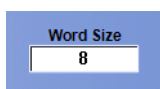

Behavior

The instrument changes the word size and uses that to decode the selected SPI bus.

What do you want to do next?

[Learn more about bus setups.](#)

[Learn about bus configuration.](#)

[Learn about digital setups.](#)

Select the SPI bus bit order

NOTE. The SPI Bus Bit Order option is available only on instruments with option SR-EMBD.

From the Bus Setup window, select the Select tab and the SPI Serial bus type.

To use

- Scroll through the Bus list and select the SPI bus to configure.
- Click the Bit Order box and select the direction from the drop-down list: MS First or LS First.

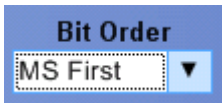

Behavior

- MS First causes the instrument to decode the data sequence from the MSB to the LSB.
- LS First causes the instrument to decode the data sequence from the LSB to the MSB.

What do you want to do next?

[Learn more about bus setups.](#)

[Learn about bus configuration.](#)

[Learn about digital setups.](#)

Set up a parallel bus

From the Bus Setup window, select a bus from the Bus list, select the Parallel bus type, and then click the Add Sources button.

Overview

When you acquire data from a Parallel bus, you can set up the bus to be clocked or unclocked.

To use

For information on the controls, click the buttons.

- [Bus List](#)
- [Display & Clear](#)
- [Label](#)
- [Position](#)
- [Add Sources](#)
- [Thresholds](#)
- [Bit Order](#)
- [Remove](#)

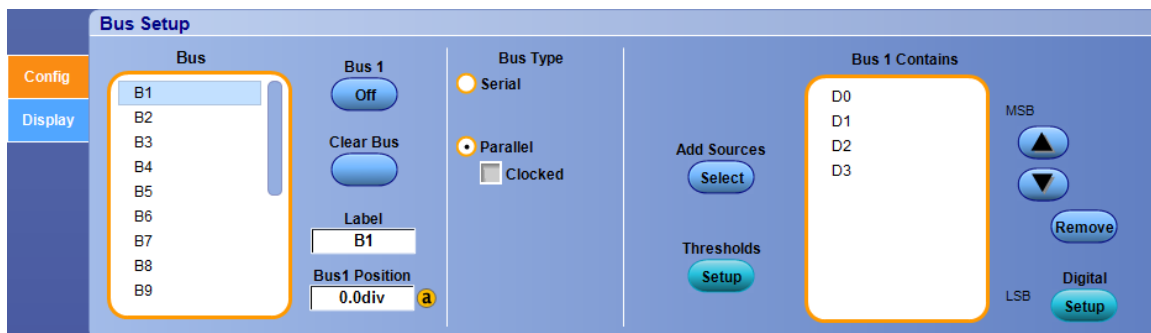

Behavior

If the bus is not clocked, the instrument acquires all data from the parallel bus at the sample rate of the instrument.

Digital channels are not available on SX models.

What do you want to do next?

[Learn more about bus setups.](#)

[Learn about bus configuration.](#)

[Learn about digital setups.](#)

[Learn how to set up a parallel bus.](#)

[Learn how to troubleshoot circuits using a parallel bus.](#)

[Learn how to view analog characteristics of a digital waveform.](#)

[Learn how to trigger on a bus.](#)

Set up a clocked parallel bus

From the Bus Setup window, select a bus from the Bus list and then select the Parallel bus type.

Overview

The instrument can trigger parallel bus data only when the Clock Source is Channel 4.

For information on the controls, click the buttons.

- [Bus List](#)
- [Display & Clear](#)
- [Label](#)
- [Position](#)
- [Clock Source](#)
- [Clock Polarity](#)
- [Add Sources](#)
- [Thresholds](#)
- [Bit Order](#)
- [Remove](#)

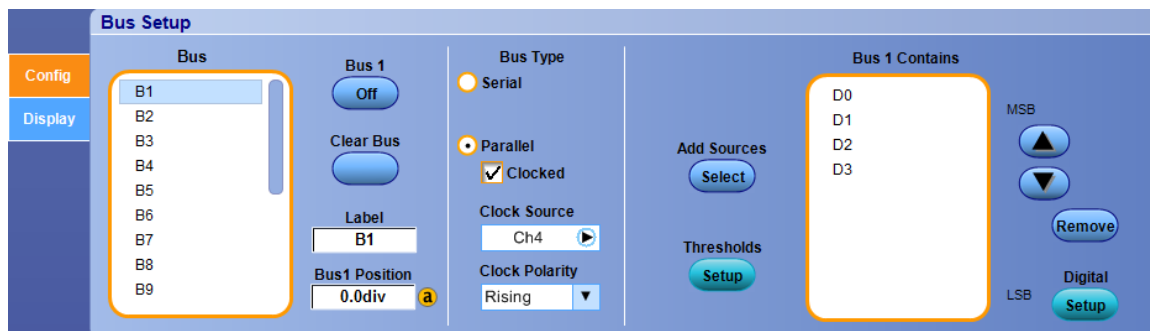

To use

- To change the Clock Source, select a channel from the cascading list. (Digital channels are not available on SX models.)
- To change the Clock Polarity, select from Rising, Falling, or Either.

Behavior

- Rising causes the instrument to decode data on the rising edge of the signal.
- Falling causes the instrument to decode data on the falling edge of the signal.
- Either causes the instrument to decode data on the rising and the falling edges of the signal.

What do you want to do next?

[Learn more about bus setups.](#)

[Learn about bus configuration.](#)

[Learn about digital setups.](#)

[Learn how to set up a parallel bus.](#)

[Learn how to troubleshoot circuits using a parallel bus.](#)

[Learn how to view analog characteristics of a digital waveform.](#)

[Learn how to trigger on a bus.](#)

Add sources to a parallel bus

From the Bus Setup window, click the Add Sources Select button.

To use

- Click the button for each channel to add to the bus.
- Click the OK button.

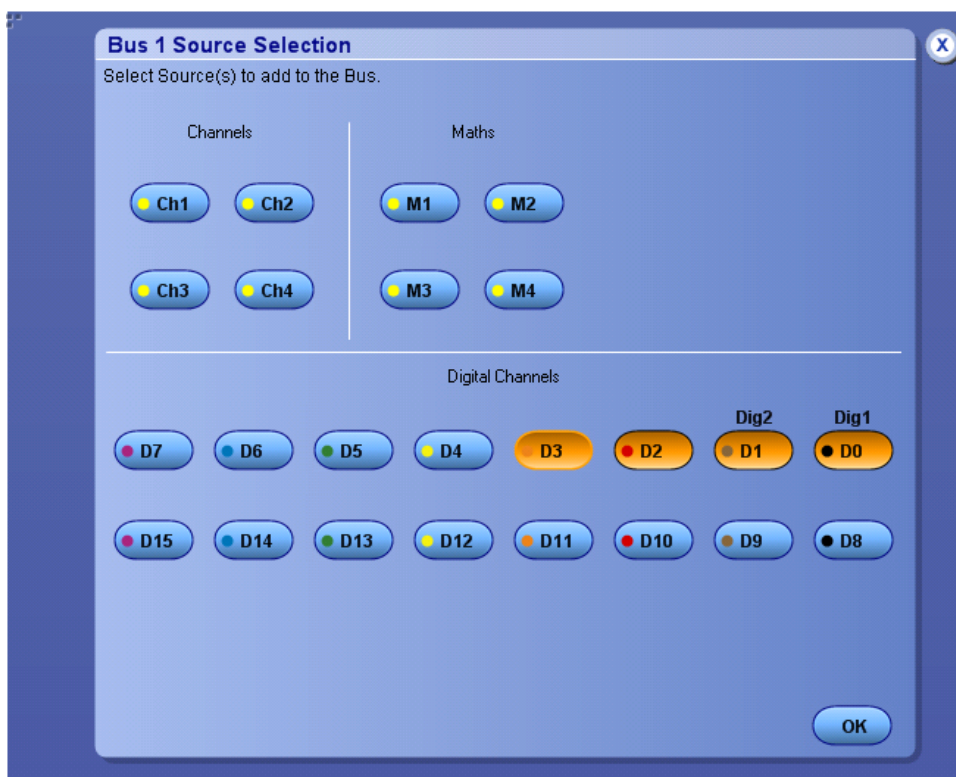

NOTE. You have the option to add user-defined labels for the analog, reference, bus, and digital sources. Digital sources are only available on MSO series instruments.

Behavior

The instrument adds the channels to the parallel bus starting with the Most Significant Bit (MSB). As you select each subsequent channel, the instrument adds the channel to the bus as the next lower bit. The last channel you select is the Least Significant Bit (LSB).

What do you want to do next?

[Learn more about bus setups.](#)

[Learn about bus configuration.](#)

[Learn about digital setups.](#)

Set up bus channel thresholds

NOTE. Serial Bus Channel Type is only available on instruments with an SR-xxxx option.

From the Bus Setup window, select a bus number from the Bus list.

To use

- Click the Thresholds Setup button.
- Double-click the Threshold entry box for the desired channel, and use the keypad to enter a value or use the multipurpose knobs to select a voltage level.

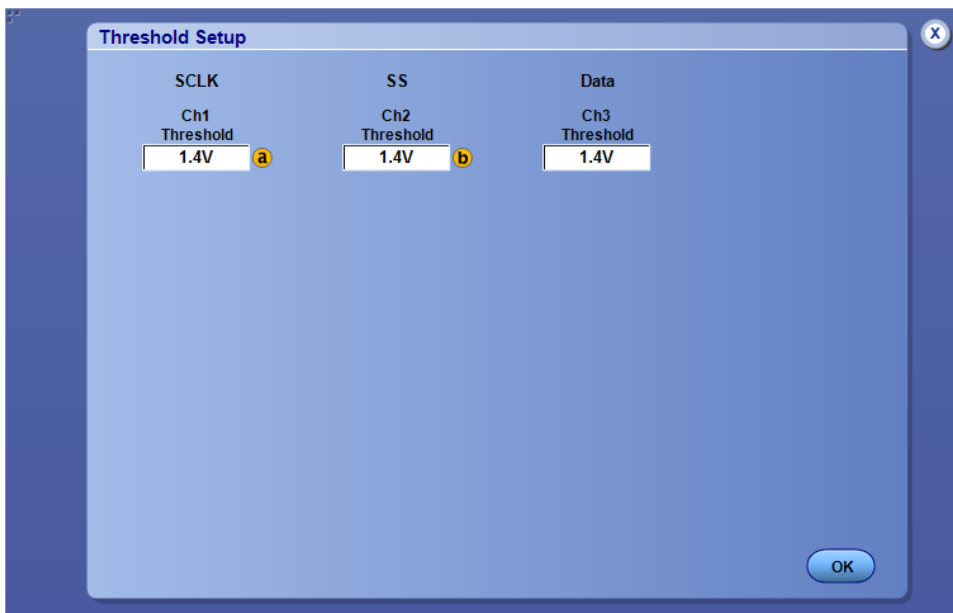

TIP. To quickly set the thresholds for all channels to the same voltage level, use the [Global Threshold](#) entry box to set the value, and click the Apply button.

What do you want to do next?

[Learn more about bus setups.](#)

[Learn about bus configuration.](#)

[Learn about digital setups.](#)

Change the bit order of a channel in a parallel bus

NOTE. Serial Bus Channel Type is only available on instruments with an SR-xxxx option.

From the Bus Setup window, select a channel to move to a different bit order position within a parallel bus.

To use

- Select a parallel bus from the Bus list.
- Click the channel for which you want to change the bit order in the Bus Contains list.
- Click the Up or Down arrows to change the bit order of the selected channel.

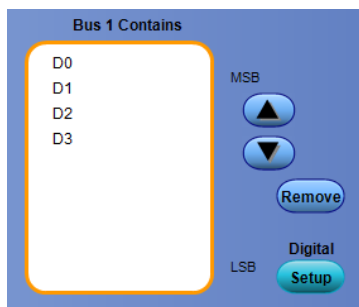

Behavior

- Moves the selected channel towards the MSB (most significant bit) position in the bit order when you click the arrow that points up.
- Moves the selected channel towards the LSB (least significant bit) position in the bit order when you click the arrow that points down.



TIP. To quickly remove any channel from the parallel bus, double-click the channel in the Bus List control.

What do you want to do next?

[Learn more about bus setups.](#)

[Learn about bus configuration.](#)

[Learn about digital setups.](#)

Remove a channel from a parallel bus

From the Bus Setup window, select a channel to remove from a parallel bus.

To use

- Select a parallel bus from the Bus list.
- Click the channel you want to remove from the Bus Contains list.
- Click the Remove button.

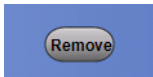

Behavior

The instrument removes the channel from the bus and shifts the bit order accordingly.

What do you want to do next?

[Learn more about bus setups.](#)

[Learn about bus configuration.](#)

[Learn about digital setups.](#)

Select the bus clock source channel

From the Bus Setup window, select a bus, select the Parallel bus type, and click Clocked.

To use

- Connect a probe between the instrument and the clock signal in your system under test.
- Click the Clock Source selection box and select the appropriate channel from the cascading list.

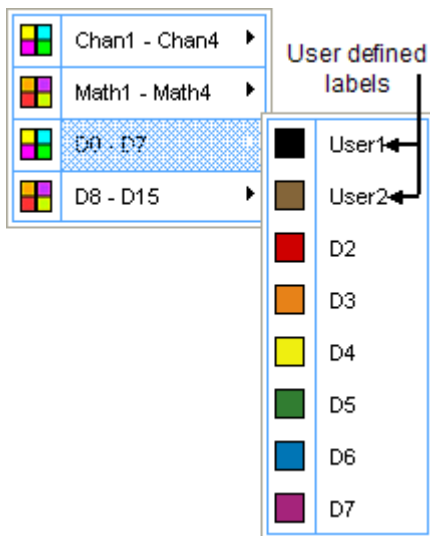

NOTE. You have the option to add user-defined labels for the analog, reference, bus, and digital sources. Digital sources are only available on MSO models.

Behavior

The instrument acquires data from the parallel bus only when the signal used as the Clock Source changes logic levels.

What do you want to do next?

[Learn more about bus setups.](#)

[Learn about bus configuration.](#)

[Learn about digital setups.](#)

Select the bus clock channel polarity

From the Bus Setup window, select a bus, select the Parallel bus type, and click Clocked.

To use

- Connect a probe between the instrument and the clock signal in your system under test.
- Click the Clock Polarity selection box and select from Rising, Falling, or Either.



Behavior

- Rising causes the instrument to acquire data on the rising edge of the signal.
- Falling causes the instrument to acquire data on the falling edge of the signal.
- Either causes the instrument to acquire data on the rising and the falling edges of the signal.

What do you want to do next?

[Learn more about bus setups.](#)

[Learn about bus configuration.](#)

[Learn about digital setups.](#)

Bus setup control window (Display tab)

From the Bus Setup window, select the Display tab.

Overview

Use the Bus Setup Display window to define how the instrument displays data acquired from the selected bus.

To use

- [Bus List](#)
- [Bus Components](#)
- [Busform Decode](#)
- [Symbol Table](#)
- [Packet View](#)
- [Results Table](#)

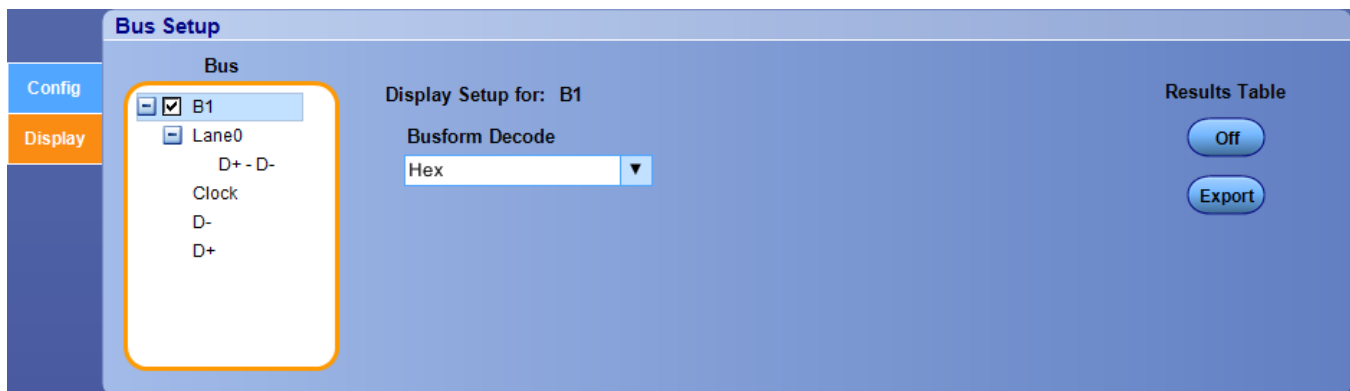

Behavior

The instrument displays data from the bus based on the selected Bus Components, Busform Decode option, and the symbol file.

For the LIN, FLEXRAY, MIL1553, MIPI DSI-1, MIPI CSI-2, and Custom serial bus, you can also display the decode of the bus in mixed, Hex, and Binary method.

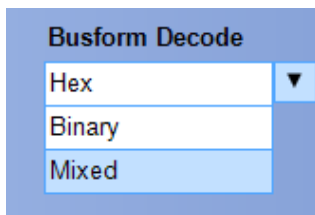

For the CAN serial bus, you can display the decode of the bus in Hex and Binary.

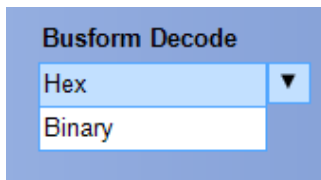

For the 8B10B serial bus, you can also display the decode of the bus in Symbol, Character, Data Hex, and Data Binary method.

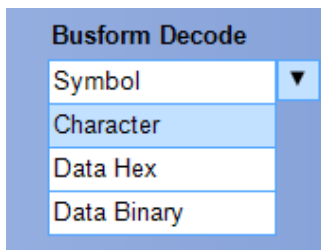

For the PCIe serial bus, you can display the decode of the bus in Symbol, Character Symbol, Character KCode, Data Hex, Data Binary, Descrambled Hex, and Descrambled Binary. Select the decode from the drop down list.

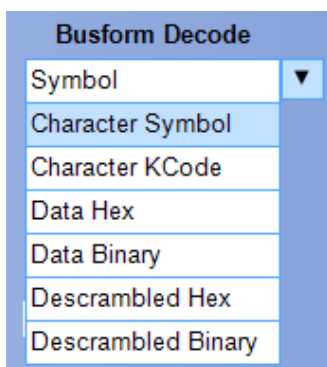

NOTE. PCIe serial bus with a data rate of 8 Gb/s and above does not support Character Symbol and Character KCode.

For the RS232 serial bus, you can also display the decode of the bus in ASCII, Binary, and Hex.

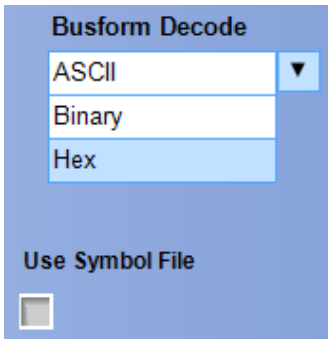

For the USB serial bus, you can display the decode of the bus in Mixed Hex, Mixed ASCII, Hex, Binary, Packet, and Details. The speed you select determines the available decodes. Select the decode form the drop down list.

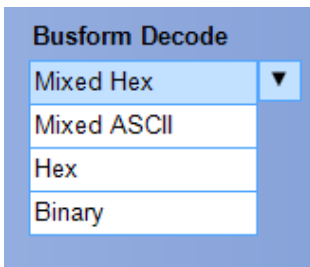

For the Ethernet serial bus, you can display the decode of the bus in Mixed Hex, Mixed ASCII, Hex, and Binary. Select the decode form the drop down list.

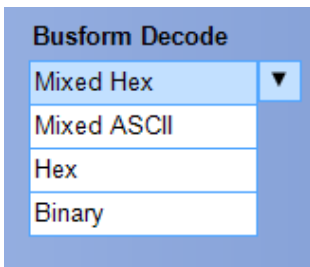

What do you want to do next?

[Learn about bus setups.](#)

[Learn about digital setups.](#)

[Learn how to set up digital waveforms.](#)

[Learn how to view analog characteristics of a digital waveform.](#)

[Learn how to set up a bus.](#)

[Learn how to trigger on a bus.](#)

[Learn how to track down serial bus anomalies.](#)

[Learn how to troubleshoot circuits using a parallel bus.](#)

[Learn how to troubleshoot a serial bus.](#)

Select the bus display view

From the Bus Setup window, select the Display tab.

To use

- Scroll through the Bus list and select the bus to configure.
- Click a + box to display additional views, or click a - box to remove views.

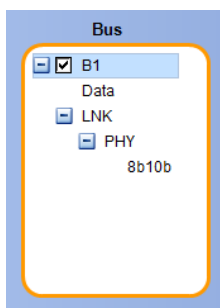

Bus views may also be added or removed from the display by clicking on the + box or - box in the display. Available views may include Transaction/transport, link/framing/packets, physical/bytes/symbols, and bit level.

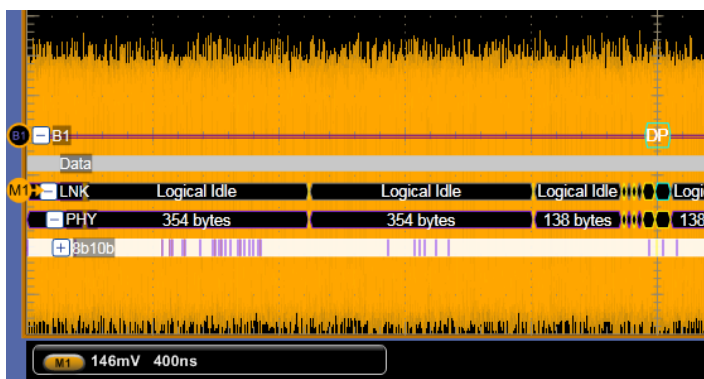

Behavior

- Clicking on a + box displays additional views of a bus.
- Clicking on a - box removes bus views from the display.

What do you want to do next?

[Learn more about bus setups.](#)

[Learn about bus configuration.](#)

[Learn about digital setups.](#)

Select the bus decode method

From the Bus Setup window, select the Display tab.

To use

- Scroll through the Bus list and select the bus to configure.
- Click the Busform Decode drop down list and select the method to interpret and display the data from the bus.

Behavior

The instrument displays the busform based on the selected decode method. Available decode methods vary with the selected bus.

- Hex causes the instrument to decode and display the bus as a hexadecimal value.
- Binary causes the instrument to decode and display the bus as a binary value.
- ASCII causes the instrument to decode and display the bus as an ASCII value.
- Mixed causes the instrument to decode and display the bus frame and address in decimal. You have the option to display the data either as a hexadecimal or an ASCII value. Mixed displays the data type as symbols, and it displays the virtual channel and word count in decimal. All other fields are displayed in hexadecimal.

Mixed decoding methods like symbol for DT (Data Type MIPI element), decimal for VC (Virtual Channel MIPI element) and WC (Word Count MIPI element), and hexadecimal for all other fields are available for MIPI DSI-1 serial bus type.

What do you want to do next?

[Learn more about bus setups.](#)

[Learn about bus configuration.](#)

[Learn about digital setups.](#)

[Learn about the symbol file format.](#)

[Learn to view the bus packets.](#)

View bus packet

NOTE. Serial Bus Channel Type is only available on instruments with option SR-COMP.

From the Bus Setup window, select Serial from the Bus Type list and then select the RS-232 in the Config tab.

To use

- Select the Packet View check box in the Config tab. The bus display shows decoded packet level information on the bus and displays the value in hexadecimal, binary, or ASCII in the bus waveform.
- Select one of the available options in the End of Packet list.

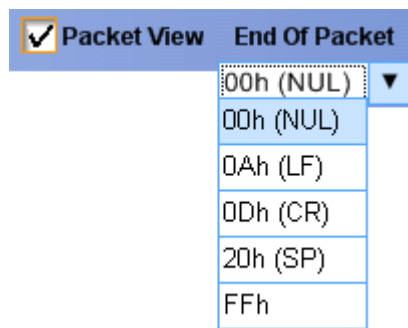

RS-232 decoding displays a stream of bytes. You can organize the stream into packets with an end-of-packet character.

Select the bus symbol table

NOTE. Symbol tables are only available when a parallel bus is selected.

Symbol files are files of alphanumeric symbol names and associated data values, and are used to map a group value to a text string. The instrument displays the symbol in place of the numeric value. For example, a symbol file could map an address group value to a specific bus cycle. This decoding makes it easier to recognize and locate specific numeric values on the bus.

Symbol files must follow a specific format to be compatible with the file reader of the instrument.

From the Bus Setup window, select the Configure tab.

To use

- Scroll through the Bus list <B1-B16> and select the bus to configure.
- Select the Display tab.
- Click the Use Symbol File check box.
- [Click the Browse button to locate the file.](#)



NOTE. The instrument looks for decode symbol table files in the `C:\Users\[Username]\Tektronix\TekScope\BusDecodeTables` directory.

Behavior

The instrument searches for the numeric value in the symbol table file and displays the corresponding symbol. For example, you might define a numeric value to display as RESET. If the instrument does not find a symbol assigned to a numeric value, the numeric value displays.

What do you want to do next?

[Learn about the symbol file format.](#)

[Learn how to find and open a symbol table file.](#)

[See an example of parallel bus values displayed as symbols](#)

[Learn more about bus setups.](#)

[Learn about bus configuration.](#)

[Learn about digital setups.](#)

Symbol file format

NOTE. Symbol tables are only available when a parallel bus is selected.

The instrument requires a specific format to be compatible with the instrument reader. The instrument uses a format called TSF, which is the TLA Symbol Format used with Tektronix logic analyzers.

The file extension is `.tsf`. You can use any text editor to create the file.

The file contains a TSF header line and lines to define the symbol names and values. White space (blank spaces or tabs) separates fields on a line. The first few lines of a file are typically comment lines to describe the file.

All lines in the file that begin with a number sign (`#`) character are treated as comments, unless the very next character is a plus sign (`+`). The plus sign signifies a reader directive. The number sign character can also initiate a comment on the end of a symbol definition. All text between the number sign and the end of the line is treated as a comment and ignored.

A TSF header identifies the file format version to the reader in the instrument. The header also specifies that the file contains pattern symbols and the number system radices used to specify symbol values.

The next graphic shows an example of a TSF header in a symbol file. The first few lines are comments that describe the file and are not required as part of the file header.

After the comment lines (if any), the file must contain the TSF header line that starts with the `#+` characters and the Version number. The Version number contains three fields. The first two fields are the file format major and minor version numbers. The instrument only reads TSF files where the major and minor version number of the file is less than or equal to that of the instrument reader. The third field denotes minor format changes, which do not impact the file reader.

In the header, the Version number is followed by the word PATTERN.

Next in the header are two radix fields: Display and File. The Display Radix field sets the default radix that will be used to display the numeric symbol value. This field must be HEX, OCT, DEC, or BIN.

The File Radix field specifies the radix used by the symbol values in the file. The File Radix field must be HEX, OCT, DEC, or BIN.

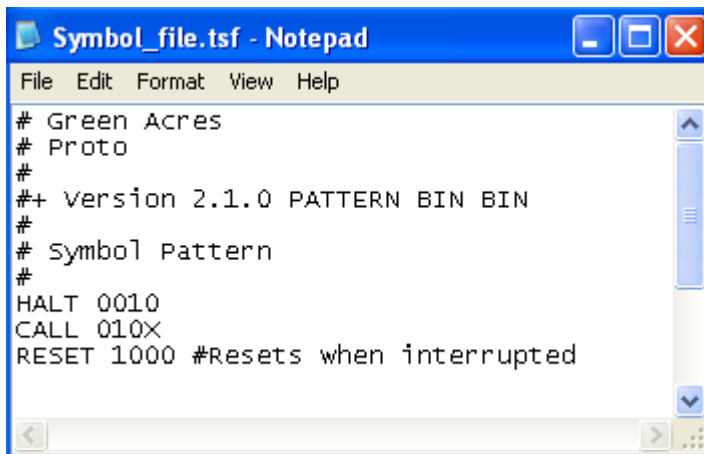

```

# Green Acres
# Proto
#
#+ Version 2.1.0 PATTERN BIN BIN
#
# Symbol Pattern
#
HALT 0010
CALL 010X
RESET 1000 #Resets when interrupted

```

You can create symbol names from ASCII with up to 220 characters. The numeric values must reflect the base specified by the File Radix field. An X represents a “don't care” value. The number of bits represented by each character depends on the radix. For a HEX value, each character represents 4 bits. For an OCT value, each character represents 3 bits. For a BIN value, each character represents 1 bit.

NOTE. The order of the symbols in the file is important. The instrument scans the list of pattern symbols starting from the top of the file and displays the first symbol that matches the bits with numeric values (not Xs).

To use

- Create a TSF file with symbols and numeric values.
- Copy the file to the C:\Users\[Username]\Tektronix\TekScope\BusDecodeTables directory on the instrument.
- From the Bus Setup window, select the Config tab and select a bus to decode.
- In the Display tab, select the Use Symbol File check box.
- Click the Browse button to locate the file.



Behavior

The instrument searches for the numeric value in the symbol table file and displays the corresponding symbol. If the instrument does not find the numeric value, there is no symbol and the numeric value displays.

What do you want to do next?

[See an example of parallel bus values displayed as symbols.](#)

[Learn how to find and open a symbol table file.](#)

[Learn more about bus setups.](#)

[Learn about bus configuration.](#)

[Learn about digital setups.](#)

Opening a bus symbol table file

NOTE. Symbol tables are only available when a parallel bus is selected.

From the Bus Setup window, select the Display tab, and then select the Use Symbol File check box.

To use

1. Click the Browse button to locate the file.
2. Navigate to the file location or select a symbol table file from the dialog box.
3. Click Open.

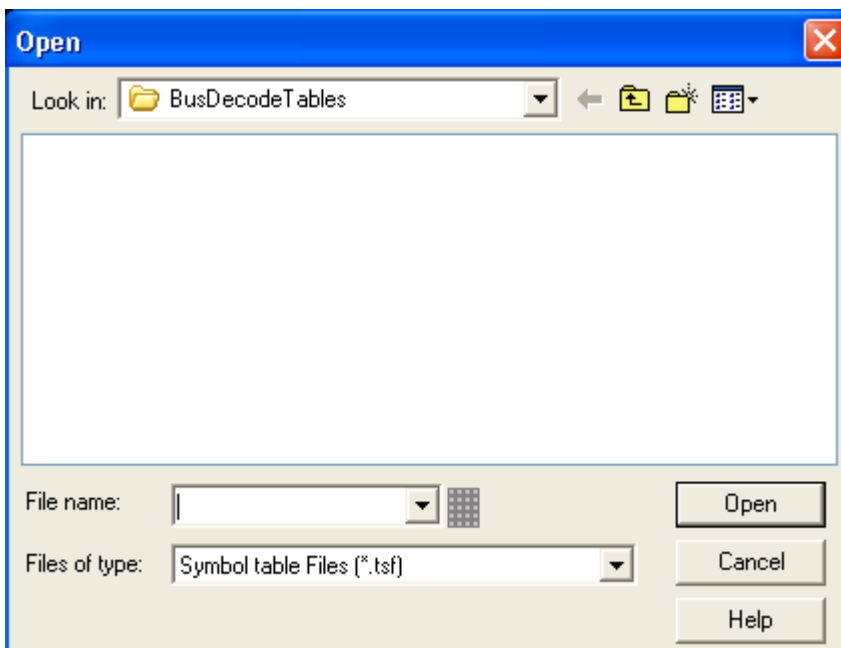

Behavior

This dialog box opens to the default directory `C:\Users\[Username]\Tektronix\TekScope\BusDecodeTables`. If you saved the file in another directory, you need to copy the file to the `C:\Users\[Username]\Tektronix\TekScope\BusDecodeTables` directory, where the instrument expects to find it. When you open a symbol table file, the instrument uses the values to decode and display bus values to be easier to recognize.

NOTE. The only available file is in TSF format.

What do you want to do next?

[Learn about bus symbol tables.](#)

[Learn about the format.](#)

See an example of parallel bus values displayed as symbols.

MagniVu setup

Using MagniVu

NOTE. The MagniVu feature is available on MSO5000B models and on DPO5000B models with option MSOE..

Select MagniVu in one of the following ways:

- Digital menu.
- Horiz/Acq menu.
- Horiz/Acq > Horizontal/Acquisition Setup and click Acquisition tab.

Overview

Turn on or turn off MagniVu.

To use

Select MagniVu to increase the resolution.

Behavior

MagniVu gives you higher resolution to accurately determine edge placement. This helps you make precise timing measurements on digital edges. You can see up to 32 times more detail than with normal digital channel sampling. The MagniVu record is acquired in parallel to the main digital acquisition and is available at any time, running or stopped. MagniVu provides an ultra high resolution view of your data sampled at a maximum resolution of 60.6 ps for 10,000 points centered around the trigger.

With MagniVu option disabled:



With MagniVu option enabled (the Sample Rate and Resolution values set):

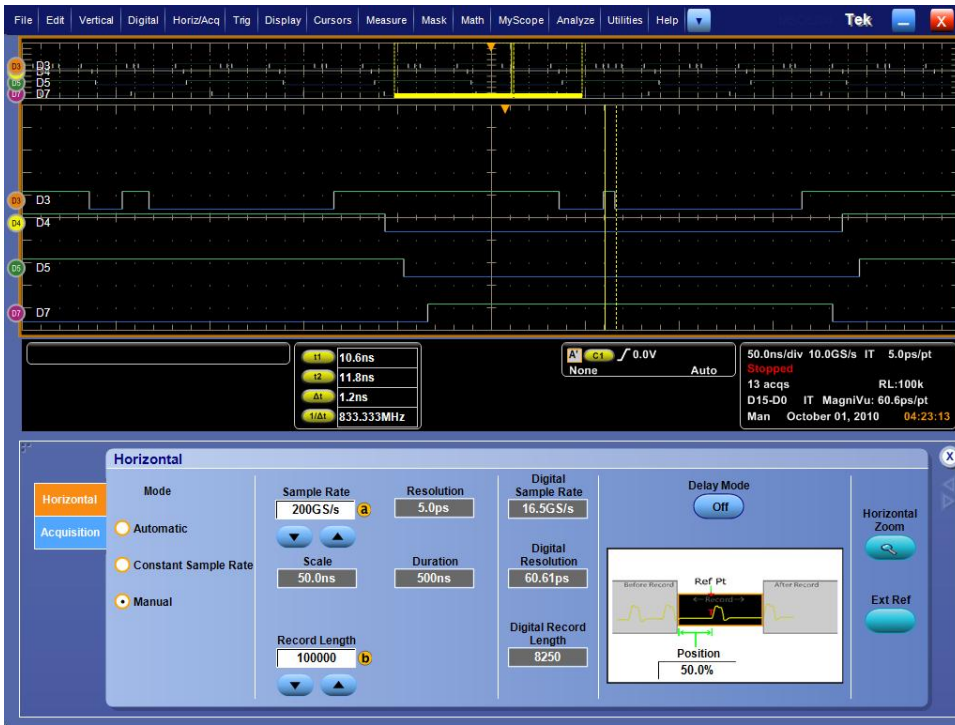

NOTE. *The MagniVu record must always contain the trigger. If the trigger point is moved prior to the display region using Horizontal Delay, then the MagniVu record will not be available. In most of these cases, you can find the digital record by looking for the digital signal in the upper overview and panning accordingly.*

NOTE. *You should turn on MagniVu when light gray shading is displayed to indicate the uncertainty of the edge position. If the shading is not displayed, you do not need to use MagniVu.*

Display setups

Display control window (Appearance tab)

From the Display menu, select Display Setup.

Overview

Use the Display General tab controls to change the display style, persistence, intensity, format, and interpolation.

For information on the controls, click the buttons.

- [Style](#)
- [Persistence](#)
- [Intensity](#)
- [Format](#)
- [Interpolation](#)

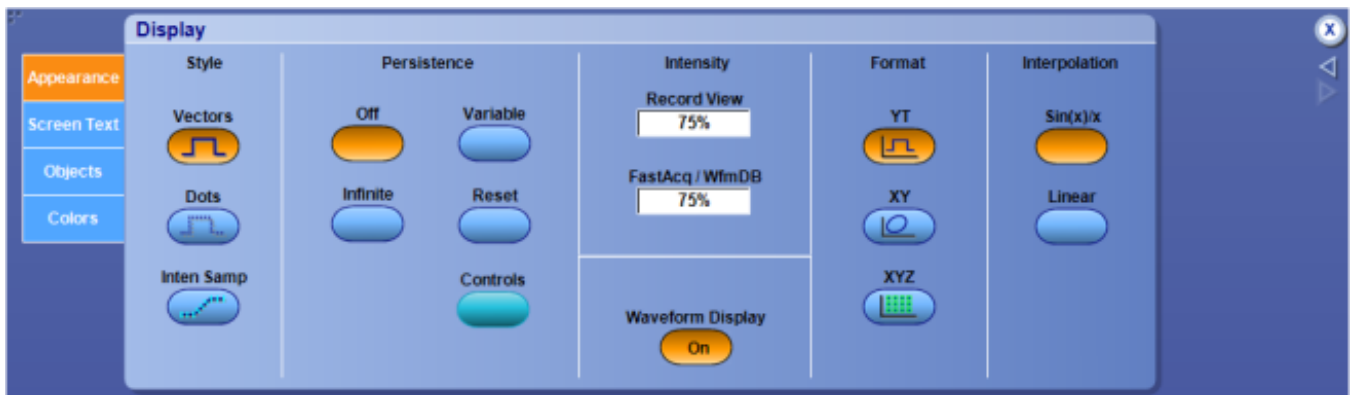

NOTE. The following screen appears on MSO/DPO5000B Series instruments.

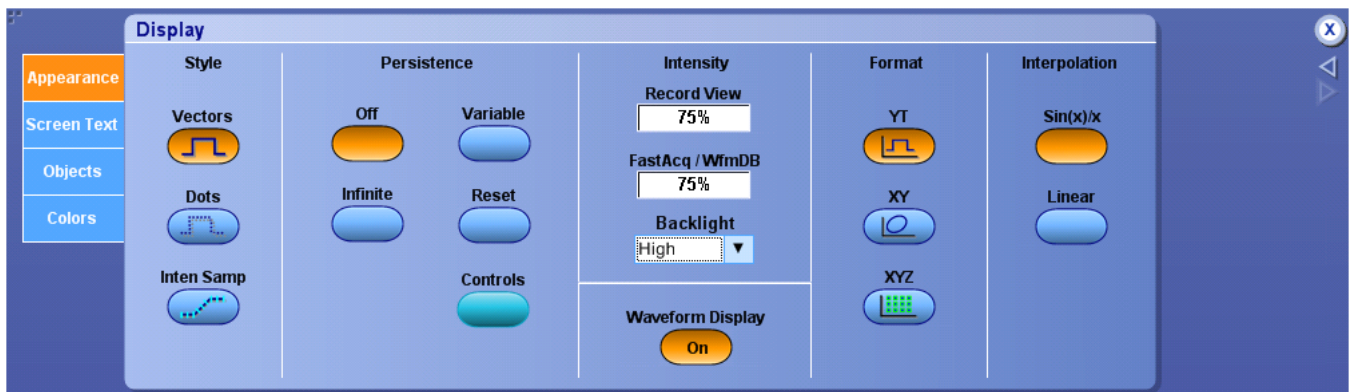

What do you want to do next?

[Learn about using text with screen displays.](#)

[Learn about changing the appearance of objects in the display.](#)

[Learn about changing the display colors.](#)

Display control window (Screen text tab)

From the Display menu, select Screen Text, or open the Screen Text tab in the Display control window.

Overview

Use the controls on the Screen Text tab to define text captions that you can add to the instrument display.

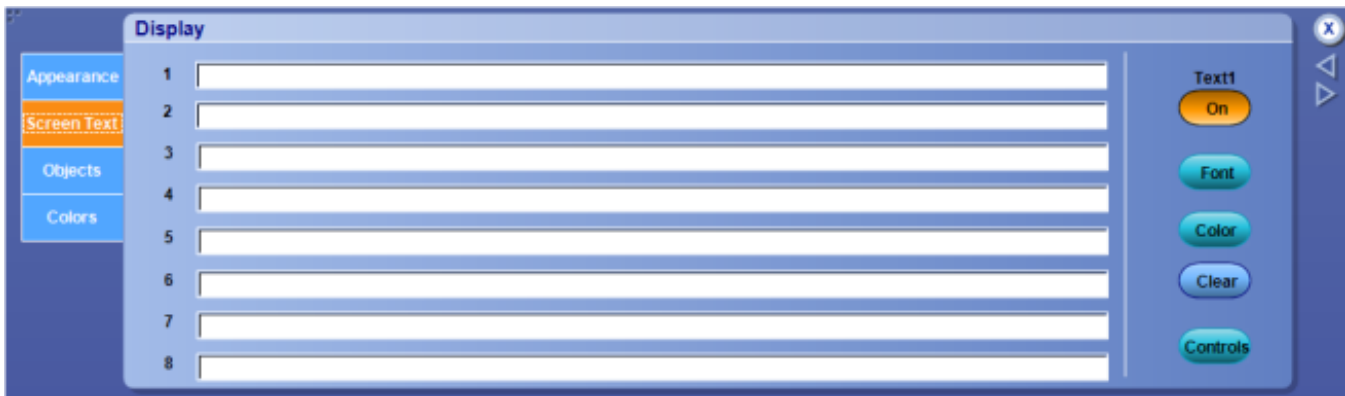

To use

You can create up to eight lines of text to provide notes for screen shots, printouts, or for other instrument users.

- Click in a text field, 1 through 8.
- Click the Text <1–8> button to turn the message text On or Off on the display.
- Click the Font button to open the Font dialog box and change the font properties of the text.
- Click the Color button to open the Color dialog box and change the color properties of the text.
- Click the Clear button to delete the message text. (Text button must be On)
- Click Controls button to open the [Text Properties control window](#), where you can define the positioning of the message on the display.

Behavior

Click on one of the numbered lines and use the pop-up keyboard to enter up to 64 alphanumeric characters of text per line.

Click Clear to clear the entire text of the selected line. The screen text that you enter is not related to any waveform labels that you may have created. The waveform labels help you identify waveforms on the screen, while the screen text is intended to provide information or notes for screen shots or printouts.



TIP. Position the text on the screen by clicking and dragging the text to the desired location on the graticule.

What do you want to do next?

[Learn about defining screen text properties.](#)

[Learn about changing the overall display appearance.](#)

[Learn about changing the display colors.](#)

[Learn about changing the appearance of objects in the display.](#)

Text properties control window

From the Display menu, select Display Setup; then open the Screen Text tab and click the Controls button.

Overview

Use the Text Properties control window to position text to specific locations on the graticule.



To use

Select the line of text from the Screen Text drop-down list; then use the X Pos and Y Pos controls to define the location of the text on the graticule.

Behavior

The text from the drop-down list is the text you defined under the Screen Text tab of the Display control window.

The units for the position controls are in pixels. The minimum values are 1 for both X and Y positions. The maximum X value is 450; the maximum Y value is 390. The origin of the X position is the left vertical graticule boundary, while the origin of the Y position is the upper horizontal graticule boundary.

Setup opens the Display control window with the Screen Text tab selected. Click Setup to enter new lines of text.



TIP. You can also position the text on the screen by clicking and dragging it to the desired location.

What do you want to do next?

[Learn about using text with screen displays.](#)

[Learn about changing the overall display appearance.](#)

[Learn about changing the appearance of objects in the display.](#)

[Learn about changing the display colors.](#)

Display control window (Objects tab)

From the Display menu, select Objects, or open the Objects tab in the Display control window.

Overview

Use the Objects tab controls to change the appearance of objects on the oscilloscope display.

For information on the controls, click the buttons.

- [Graticule Style](#)
- [Trigger Level Marker](#)



To use

- Click the Date/Time button to show the current date and time on the graticule.
- Click the Trigger T button to turn this display marker on and off.

What do you want to do next?

[Learn about changing the overall display appearance.](#)

[Learn about changing the display colors.](#)

[Learn about using text with screen displays.](#)

Trigger T marker

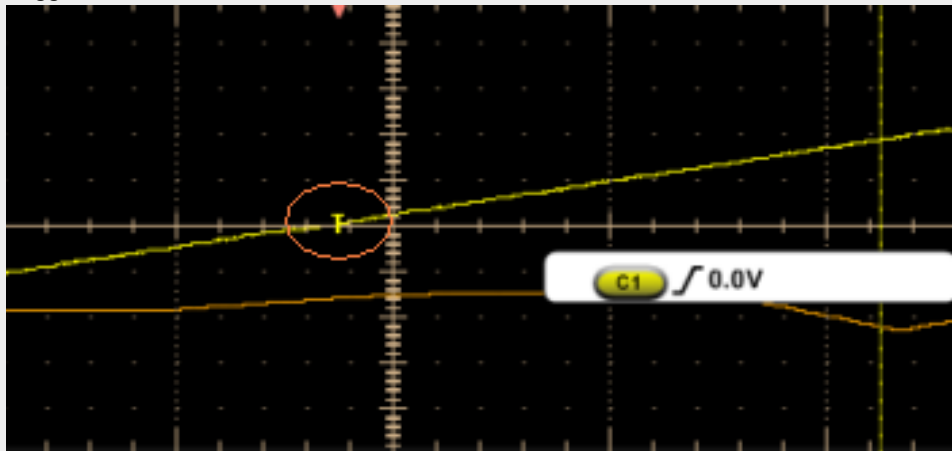

Display control window (Colors tab)

From the Display menu, select Colors, or open the Colors tab in the Display control window.

Overview

Use the controls on the Colors tab to change waveform color palettes. You can define colors for the live, math, and reference waveforms.

If you are using Waveform Database acquisition mode, select the FastAcq/WfmDB Palette. For all other acquisition modes, use the Record View Palette.

For information on the controls, click the buttons.

- [Palette](#)
- [Reference Color](#)
- [Math Color](#)

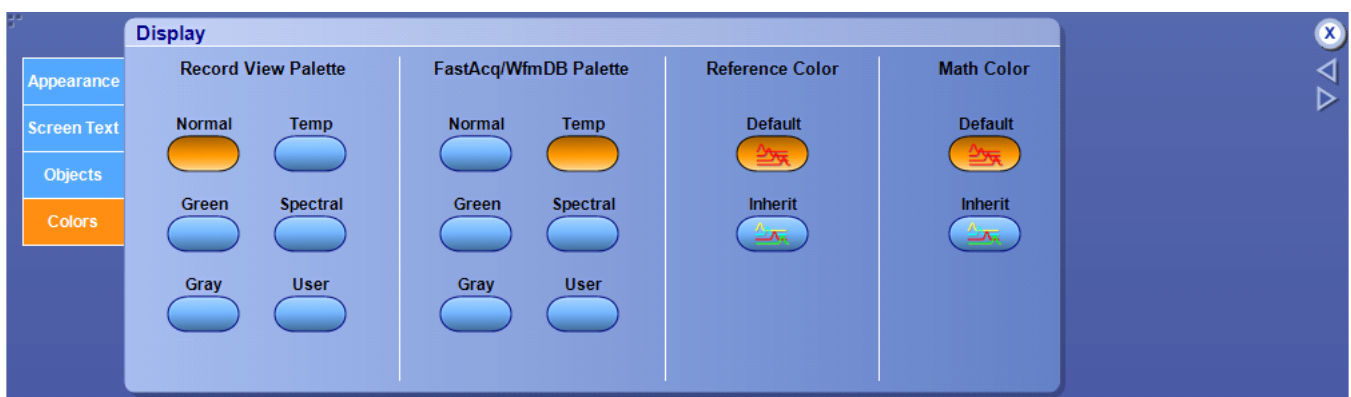

What do you want to do next?

[Learn about changing the overall display appearance.](#)

[Learn about changing the appearance of objects in the display.](#)

[Learn about using text with screen displays.](#)

Display persistence

From the Display menu, select Display Setup; then open the Appearance tab.

To use

Click one of the buttons to select the display persistence.

- Click Infinite (persistence) to continuously accumulate record points on the waveform until you change one of the acquisition display settings.
- Click Variable; then click in the Time entry box and use the multipurpose knobs to set the persistence time.
- Click Reset to clear the persistence.
- Click the Controls to activate the Persistence Control window.

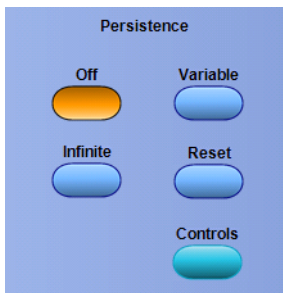

Behavior

- Use infinite persistence for displaying record points that may occur outside the normal acquisition envelope.
- Use Variable to accumulate record points on the waveform for a specified time interval. Each record point decays independently according to the time interval.
- If you click Off, the waveform record points appear for the current acquisition only.



TIP. Use the Display menu Display Persistence submenu or right-click in the graticule and select Display Persistence from the shortcut menu to directly access the persistence options.

What do you want to do next?

[Learn about changing the display colors.](#)

[Learn about using text with screen displays.](#)

[Learn about changing the appearance of objects in the display.](#)

Select the display format

From the Display menu, select Display Setup; then open the Appearance tab.

To use

Click one of the buttons to select the display format.



Behavior

YT format is the conventional oscilloscope format:

- Amplitude appears on the vertical axis as the signal varies over time on the horizontal axis.
- When you set the vertical position to center the display in YT format, the XY display is at center screen, and each division of display in YT mode produces a division of display in XY mode.

XY format plots the amplitude of one waveform against the amplitude of another waveform on a point-by-point basis:

- This format is useful for showing the relationship between two signals, such as current and voltage waveforms that combine to form an I-V characteristic.
- When using this format, waveforms appear according to their [channel pairings](#). XY format is a dot-only display, although it can have persistence.
- The Vector style selection has no effect when you using XY format.
- When using this format, the horizontal scale continues to control the time base and the horizontal position continues to control the portion of the waveform that is shown.
- [Vectors and Intensified Samples](#) selections are not available when using the XY Display Format.

XYZ format compares the voltage levels of the X and Y channel waveform records point-by-point, as in XY format. The displayed waveform intensity is modulated by the Z channel waveform record. Refer to the table below for channel assignments. XYZ format is not available on instruments with an ATI channel.

| X-Axis input | Y-Axis input | Z-Axis input |
|--------------|--------------|--------------|
| Ch 1 | Ch 2 | Ch 3 |

A -5.0 division signal, including position and offset, on the Z channel produces a blank screen; a +5.0 division signal produces full intensity.

NOTE. Selecting YT or XY only affects the display. The Horizontal, Vertical, and Position knobs (and menus) control the same parameters except in the Fast Acquisition XY format where the horizontal scale setting is not used.



TIP. Use the Display menu Display Format submenu to directly access the format types.

What do you want to do next?

[Learn about changing the display colors.](#)

[Learn about using text with screen displays.](#)

[Learn about changing the appearance of objects in the display.](#)

XY format pairs

When you use the XY display format, channel and reference waveforms are assigned to the axis indicated in the following table.

| XY Pair | X Axis | Y Axis |
|-----------------|--------|--------|
| Ch 1 and Ch 2 | Ch 1 | Ch 2 |
| Ch 3 and Ch 4 | Ch 3 | Ch 4 |
| Ref 1 and Ref 2 | Ref 1 | Ref 2 |
| Ref 3 and Ref 4 | Ref 3 | Ref 4 |

On instruments with an ATI channel, channel waveforms are assigned to the axis indicated in the following table.

| XY Pair | X Axis | Y Axis |
|---------------|--------|--------|
| Ch 1 and Ch 3 | Ch 1 | Ch 3 |

If you only display one source when you enter the XY format, the instrument automatically turns on the other source waveform to complete the XY pair.

NOTE. You cannot display math waveforms in XY format. You cannot display logic waveforms in XY or XYZ format.

Set the waveform intensity

From the Display menu, select Display Setup; then open the Appearance tab.

To use

- Click in the Record View entry box and use a multipurpose knob to adjust the intensity of live waveforms, except when using Fast Acquisition or Waveform Database acquisition mode.

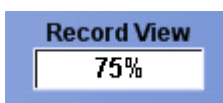

- Click in the FastAcq/WfmDB entry box and use a multipurpose knob to adjust the intensity of live waveforms when using Fast Acquisition or Waveform Database acquisition mode.

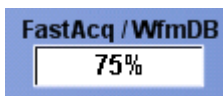

NOTE. Backlight control option is available only on MSO/DPO5000B and DPO7000C Series instruments.

- Click in the Backlight list box and use the multipurpose knob to adjust the intensity of the backlight to the required option.

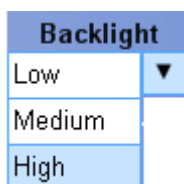

What do you want to do next?

[Learn about using text with screen displays.](#)

[Learn about changing the appearance of objects in the display.](#)

[Learn about changing the display colors.](#)

Select the waveform interpolation

From the Display menu, select Display Setup; then open the General tab.

To use

Click one of the buttons to select the interpolation that best displays the waveforms. Interpolation globally affects all displayed waveforms.



Behavior

The instrument interpolates waveforms in Zoom mode when there is less than one sample for each pixel column. These functions are performed on the acquired data as compared to the displayed data.

- Click Sin(x)/x to compute record points along a curve between the actual acquired samples. This form of interpolation is useful when acquiring rounded waveforms such as sine waves. It is good for general-purpose uses but may introduce overshoot or undershoot in signals with fast rise times. This interpolation is also useful for looking at high-frequency signals, especially where the frequency components are just below the Nyquist frequency.
- Click Linear to compute record points between actual acquired samples using a straight-line fit. This interpolation is useful for measuring waveforms with fast rise times, such as pulse trains.



TIP. Use the Display menu Waveform Interpolation submenu to directly access the interpolation options. You may want to set the display style so that the real samples are intensified and interpolated samples are dimmed.

What do you want to do next?

[Learn about using text with screen displays.](#)

[Learn about changing the appearance of objects in the display.](#)

[Learn about changing the display colors.](#)

Nyquist frequency

The highest frequency that any digital oscilloscope can measure without errors is one-half of the sample rate or frequency. This frequency is called the Nyquist frequency.

The FFT waveform displays the input signal frequency components from DC (0 Hz) to the Nyquist frequency.

Select the graticule style

From the Display menu, select Objects, or open the Objects tab in the Display control window.

To use

Click one of the buttons to select the graticule (display grid) style.

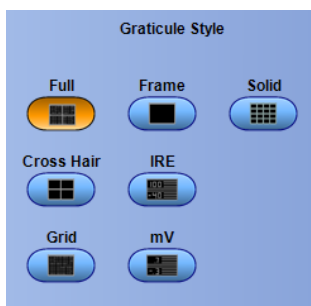

Behavior

- Full provides a grid, cross hairs, and frame on the instrument display. Use Full to make quick estimates of waveform parameters.
- Cross Hair shows cross hairs and a frame on the instrument display. This style is useful for making quick estimates of waveforms while leaving more room on the display for automatic readouts and other data.
- Grid shows a frame and a grid on the instrument display. This style is useful for making quick, full-screen measurements with cursors and automatic readouts when cross hairs are not needed.
- Frame shows only a frame on the instrument display. This style is useful with automatic readouts and other screen text when other display features are not needed.
- Use IRE if you are working with NTSC video signals. The instrument sets the graticule to accommodate the vertical position and scale of the signal.
- Use mV if you are working with video signals other than NTSC. The instrument sets the graticule to accommodate the vertical position and scale of the signal.
- Solid is similar to Full, but the grid, cross hairs, and frame are drawn using solid lines.



TIP. Use the Display menu Graticule Style submenu to directly access the graticule style options.

What do you want to do next?

[Learn about changing the overall display appearance.](#)

[Learn about changing the display colors.](#)

[Learn about using text with screen displays.](#)

Define the color palette

From the Display menu, select Colors, or open the Colors tab in the Display control window.

To use

Click the buttons to define the color for displayed waveforms.

- Use the buttons under FastAcq/WfmDB Palette to define the color for live waveforms when using Waveform Database acquisition mode.
- For some models, click the Edit button to activate the *Display Palette*, where you can customize a waveform color.

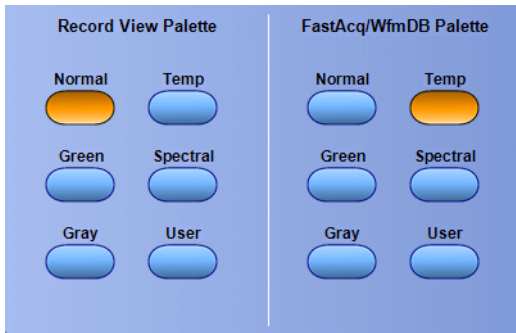

TIP. Use the Display menu Record View Palette or the WfmDB Palette submenu to directly access the color palettes.

Behavior

- Click Normal to define hues and lightness levels for best overall viewing. The color of each channel waveform matches the color of the corresponding front-panel vertical SCALE knob.
- Click Spectral (Spectral Grading) to define areas of the waveform with the highest sample density appear in blue shades while the areas of lowest sample density appear in red shades.
- Click Temp (Temperature Grading) to define areas of the waveform with the highest sample density appear in warmer colors (red shades) while the areas of lowest sample density appear in cooler colors (blue shades).
- Click Gray (Monochrome Gray) to define waveforms in shades of gray. Areas of the waveform with the highest sample density appear in lighter gray shades while the areas of lowest sample density appear in darker gray shades.
- Click Green (Monochrome Green) to define waveforms in shades of green. Areas of the waveform with the highest sample density appear in lighter green shades while the areas of lowest sample density appear in darker green shades.
- Click User to display a color that you have previously defined with the User Palette.



TIP. The Green palette simulates the display of an analog oscilloscope.

What do you want to do next?

[Learn about changing the overall display appearance.](#)

[Learn about changing the appearance of objects in the display.](#)

[Learn about using text with screen displays.](#)

Remote operation

Remote desktop connection

You can find the network setup program in the Windows Start menu. Either select All Programs > Accessories > Remote Desktop Connection, or select Programs > Accessories > Communications > Remote Desktop Connection.

Horizontal and acquisition setups

Horizontal-Acquisition control window (Horizontal tab)

From the Horiz/Acq menu, select Horizontal/Acquisition Setup; then open the Horizontal tab.

Overview

The Horizontal control window manages the horizontal parameters of waveforms. The controls in the Horizontal tab are common to all channels.

Use the Horizontal tab to set up the horizontal mode and to adjust the horizontal scale. Normally, the horizontal axis displays time information. However, in some cases, the horizontal axis can represent frequency rather than time.

NOTE. This document is for more than one instrument. Your instrument, or instrument setup, may not include some of these features.

For information on the controls, click the buttons.

- [Mode](#)
- [Controls](#)
- [Readouts](#)
- [Delay Mode](#)
- [Horiz Zoom](#)
- [Ext Ref](#)

In the following two screens, Digital Sample Rate, Digital Resolution, and Digital Record Length only appear on MSO series instrument.

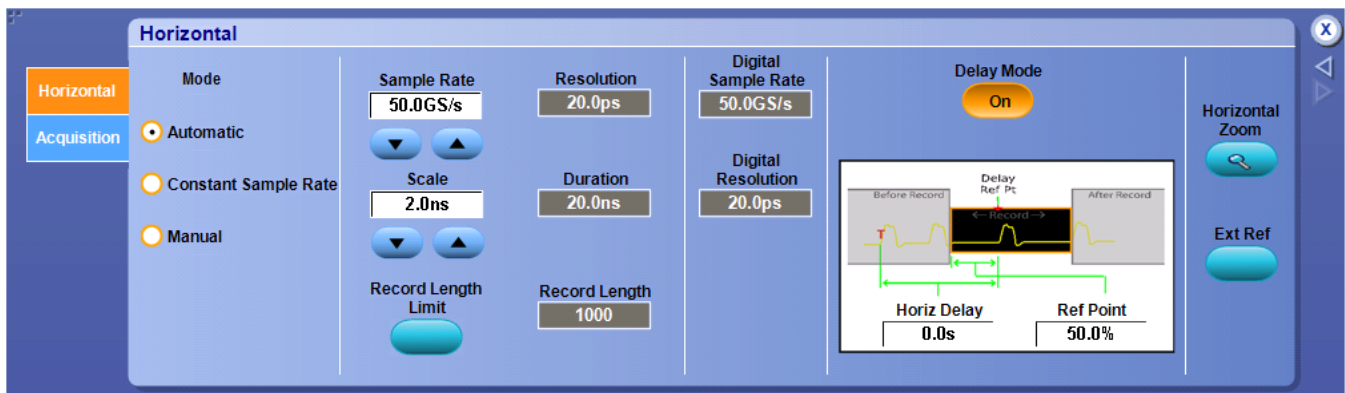

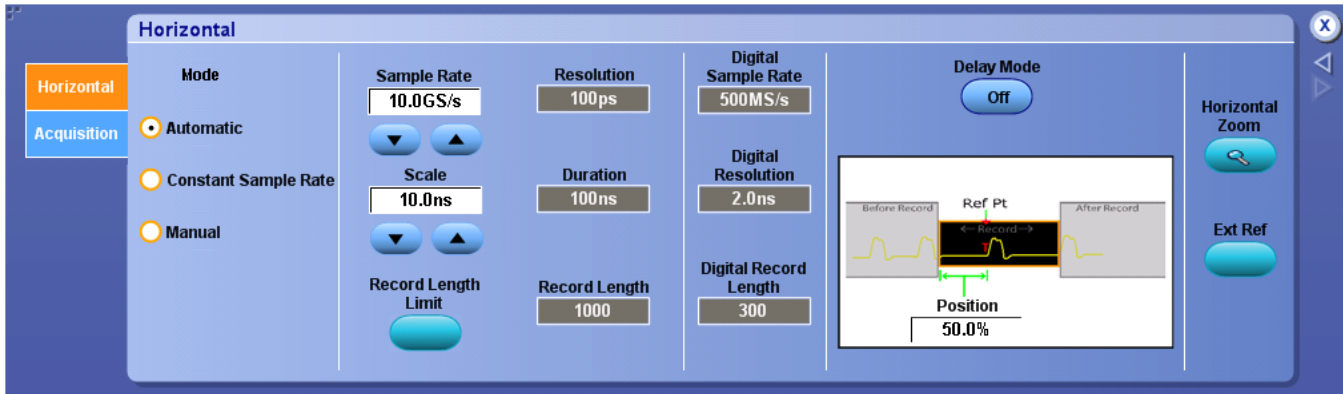

What do you want to do next?

[Learn more about the Horizontal Setup controls.](#)

[Learn about the Acquisition Setup controls](#)

Set record length limit

From the Horiz /Acq menu, select Horizontal/Acquisition Setup; then click Record Length Limit.

To use

- Use the Record Length Limit entry box to set the maximum record length.
- Use the Max button to set the record length limit to its maximum value.
- Use the Min button to set the record length limit to its minimum value.

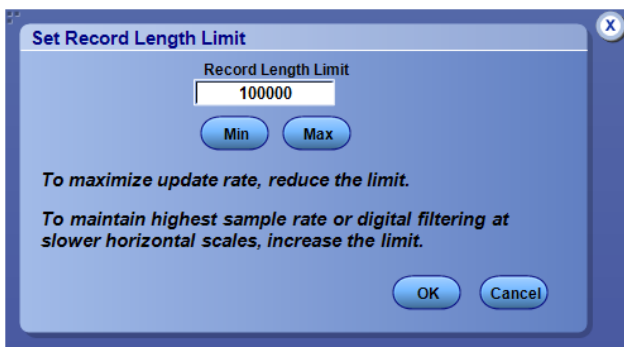

To increase the update rate, lower the record length limit. To enable higher sample rates or digital filtering at slower horizontal scales, increase the record length limit.

What do you want to do next?

[Learn more about the Horizontal Setup controls.](#)

[Learn about the Acquisition Setup controls](#)

Horizontal digital control window

NOTE. The Horizontal Digital control window is only available when a parallel bus is selected on MSO models and on DPO5000B models with option MSOE installed, and DPO7000DX instruments with option MSOU installed.

From the Horiz /Acq menu, you can view the Digital Sample Rate and Digital Resolution of logic waveforms. The values track the sample rate and resolution of the analog system.

To use

- Use the Sample Rate and Scale entry boxes to set the Digital Sample Rate and the Digital Resolution.

The following screen is captured on MSO7000C/DX Series instruments:

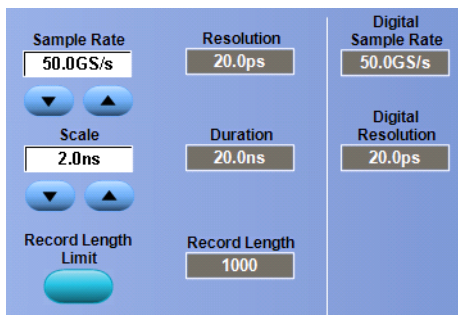

The following screen is captured on MSO/DPO5000B Series instruments:

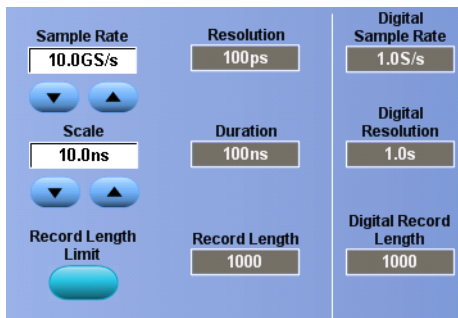

What do you want to do next?

[Learn more about the Horizontal Setup controls.](#)

[Learn about the Acquisition Setup controls.](#)

Horizontal Position-Scale control window

From the Horiz /Acq menu, select Position/Scale.

Overview

Use the Horizontal control window to set the horizontal position and scale of displayed waveforms.

For information on the controls, click the buttons.

- [Delay Mode](#)
- [Position](#)
- [Scale](#)



To use

- Click the Delay Mode button to toggle the [horizontal delay on](#).

Behavior

You can use this control window to turn on horizontal delay so the acquisition window can be focused on events that occur at a fixed delay after the trigger point.

NOTE. The dedicated Horizontal controls on the front panel also perform the same functions.

What do you want to do next?

[Learn more about the Horizontal Position controls.](#)

[Learn more about the Horizontal Scale controls.](#)

[Learn more about the Horizontal Delay Mode.](#)

[Learn more about the Horizontal controls.](#)

Horizontal Position-Scale control window with delay mode on

From the Horiz /Acq menu, select Position/Scale.

Overview

Use the Horizontal control window to set the horizontal delay and the horizontal scale of the displayed waveforms when the horizontal delay is on.

For information on the controls, click the buttons.

- [Delay Mode](#)
- [Horiz Delay](#)
- [Scale](#)

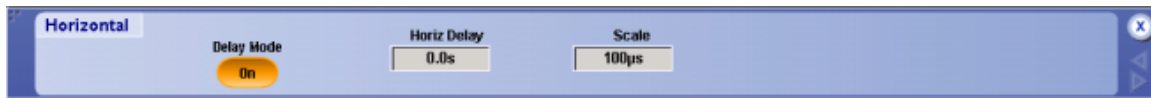

To use

- Click the Delay Mode button to toggle the horizontal delay on or off.

Behavior

You can use this control window to turn on horizontal delay so the acquisition window can be focused on events that occur at a fixed delay after the trigger point.

NOTE. The dedicated Horizontal controls on the front panel also perform the same functions.

What do you want to do next?

[Learn more about the Horizontal Delay Mode.](#)

[Learn more about the Horizontal Scale controls.](#)

[Learn more about the Horizontal controls.](#)

Horizontal-Acquisition control window (Acquisition tab)

From the Horiz /Acq menu, select Horizontal/Acquisition Setup; then open the Acquisition tab.

Overview

Use the Acquisition tab to set the acquisition parameters for all live waveforms. The Acquisition controls are common to all channels. This means that you cannot acquire in Sample mode on channel 1 while channel 2 acquires in Envelope mode.

NOTE. This document is for more than one instrument. Your instrument, or instrument setup, may not include some of these features.

To use

For information on the controls, click the buttons.

- [Acquisition Mode](#)
- [ENOB](#)
- [Fast Acq](#)
- [Roll Mode](#)
- [Sampling Modes](#)
- [FastFrame](#)
- [Ext Ref](#)

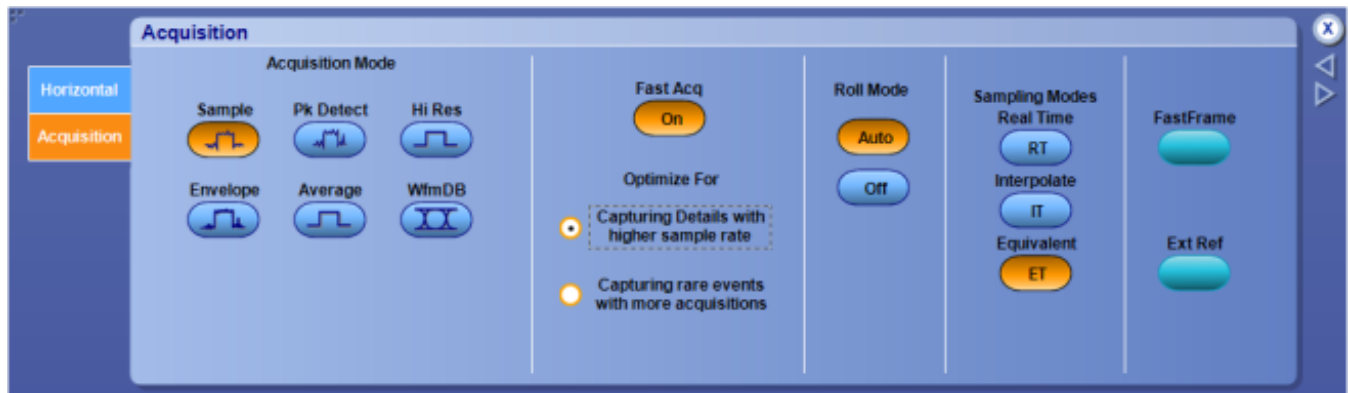
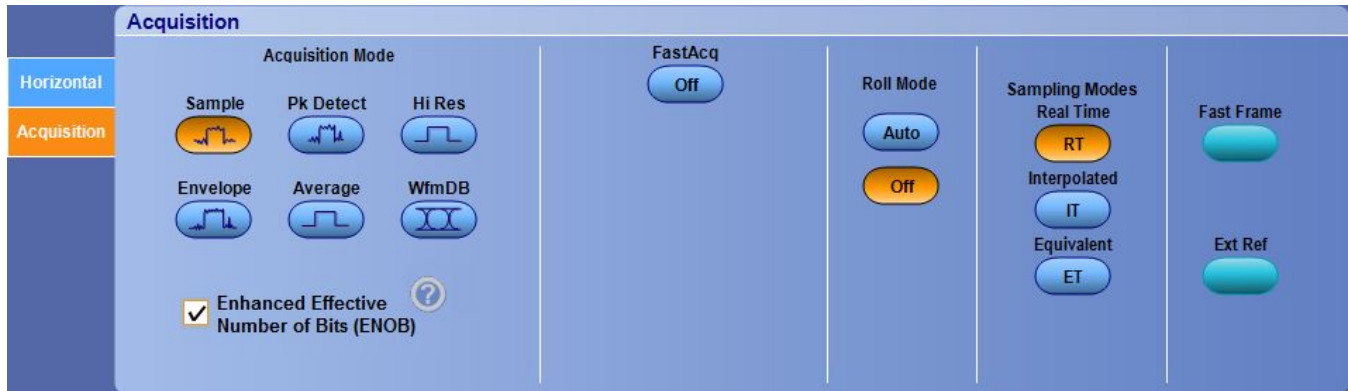

The following screen appears on MSO/DPO5000B Series instruments:

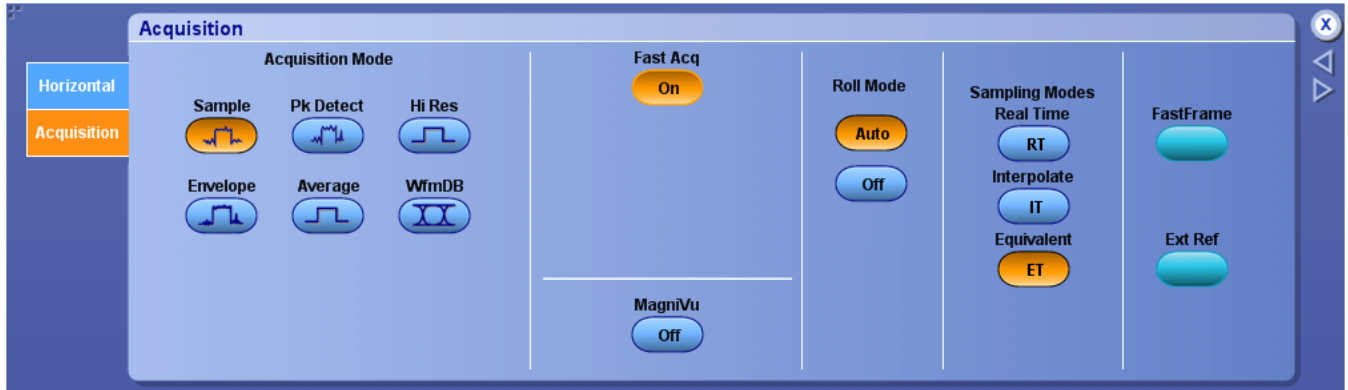

Behavior

Acquisition is the process of sampling the analog input signal, digitizing the signal to convert it into digital data, and then assembling the signal information into a waveform record. The instrument creates a digital representation of the input signal by sampling the voltage level of the signal at regular time intervals. The sampled and digitized points are stored in memory along with the corresponding timing information. The instrument uses the digital representation of the signal for display, measurements, or for further processing.

Use the controls on this tab to define the sampling method, the acquisition mode, turn Fast Acquisitions on or off, and activate an external reference.

On MSO5000B models and DPO5000B models with option MSOE, you can turn on or turn off MagniVu.

What do you want to do next?

[Learn about Acquisition modes.](#)

[Learn about MagniVu.](#)

Autoset

From the Horiz/Acq menu, select Autoset or push the front panel Autoset button.

Overview

Use Autoset to automatically set up the front-panel controls based on the characteristics of the input signal. This is much faster and easier than manually setting up the controls.



Autoset may change the vertical position to place the waveform appropriately on screen. The instrument always sets vertical offset to 0 V.

To use

If you use Autoset when one or more channels are displayed, the instrument selects the lowest numbered channel for horizontal scaling and triggering. The instrument individually scales all displayed vertical channels. If you use Autoset with no vertical channels displayed, the instrument turns on and scales channel 1.

The [Autoset Undo](#) button opens in a control window after the instrument completes the operation. Click this button to undo only the parameters adjusted by the last Autoset.

NOTE. The Autoset Undo control window remains on the screen until you open another control window. After Autoset Undo closes, you can still undo the last Autoset by selecting the Undo Last Autoset command from the Edit menu or the Horiz/Acq menu. Although the last Autoset is immediately undone, the Autoset Undo control window does not open again.

- Select User Preferences from the Utilities menu to display the [Prompt Before Action](#) window.
- Click Autoset to toggle between Off and On. Off immediately performs an Autoset when the Autoset button is pushed. On displays a prompt when the Autoset button is pushed.
- Click Close to save your selection.

The following table lists the Autoset default settings.

| Control | Changed by Autoset to |
|-------------------------------|--|
| Selected Channel | Last channel selected |
| Acquisition Mode | Sample |
| Run/Stop | Run |
| Deskew, Channel/Probe | Unchanged |
| Display Style | Vectors |
| Display Intensity–Record View | If less than 50%, set to 75% |
| Display Format | YT |
| Horizontal Position | Centered within the graticule window |
| Graticule Setting | Unchanged |
| Horizontal Scale | As determined by the signal frequency, or 100 μ s/div |
| Record Length and Sample Rate | When a new time per division is calculated, the sample rate changes to maintain the current record length. If the sample rate cannot be changed because of hardware limitations, the sample rate is set to maximum while the record length is reduced to maintain the time per division. |
| Trigger Position | Delay Off |
| Trigger A >B Sequence | A Only |
| Main Trigger Type | Edge |
| Trigger Source | Numerically lowest displayed channel (the selected channel) |
| Trigger Level | 50% of selected channel amplitude |
| Trigger Slope | Positive |
| Trigger Coupling | DC |
| Trigger Holdoff | Minimum setting |
| Vertical Scale | As determined by the signal level |
| Vertical Position | As determined by the number of active channels |
| Vertical Coupling | DC unless AC was previously set. AC remains unchanged. |

| Control | Changed by Autoset to |
|--------------------|-----------------------|
| Vertical Bandwidth | Full |
| Vertical Offset | 0 volts |
| Zoom | Off |

Set autoset preferences

From the Utilities menu, select User Preferences and the Prompts tab.

Overview

You can set the instrument to display a prompt asking you to confirm the requested action before applying the Autoset function.

To use

Select User Preferences from the Utilities menu to display the *Prompt Before Action* window.

- Click Autoset to toggle between Off and On. Off immediately performs an Autoset when the Autoset button is pushed. On displays a prompt when the Autoset button is pushed.
- Click Close to save your selection.

Undo an autoset

Press Autoset on the instrument front panel to undo the last autoset operation.

Overview

The Autoset Undo window opens automatically following an autoset. Use this control to undo the last autoset operation.

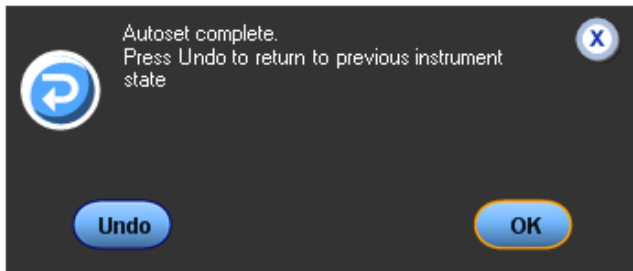

To use

- Click Undo. Only the parameters set by the last autoset are undone. The settings you have changed since the last autoset (that are not controlled by Autoset) remain unchanged.
- Click OK to close the window and proceed without an Undo.

Behavior

The Autoset Undo window remains open until you click Undo or OK. After the Autoset Undo window closes, you can still undo the last autoset by selecting Undo Last Autoset from the Edit or Horiz/Acq menus; the last autoset is immediately undone but the Autoset Undo control window does not open again.

To suppress the AutoSet Undo window following an autoset, do the following:

1. From the Utilities menu, select User Preferences.
2. Open the Prompts tab.
3. Under Prompt user before performing requested action, toggle the Autoset Undo button to Off.

What do you want to do next?

[Learn about Autoset.](#)

Enable enhanced effective number of bits

From the Horiz /Acq menu, select Horizontal/Acquisition Setup, and then select the Acquisition tab.

Overview

Use this control to turn the Enhanced Effective Number of Bits (ENOB) on or off to optimize waveform detail.

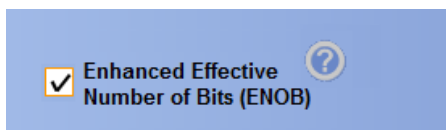

To use

1. Click the **Enhanced Effective Number of Bits** check box to turn ENOB On or Off. You will find this control in the Acquisitions tab of the [Horizontal/Acquisition control window](#),

Behavior

Enhanced Effective Number of Bits enables interleave correction DSP that improves the effective number of bits. This control is only available in some instrument models. This control is not available in Hi Res mode.

When Enhanced Effective Number of Bits is enabled, EB⁺ is displayed in the horizontal/acquisition readout.

Enable fast acquisitions

From the Horiz /Acq menu, select Fast Acquisitions, or press the front panel Fast/Acq button.

Overview

Use these controls to turn the Fast Acquisition feature on or off and to optimize waveform detail.

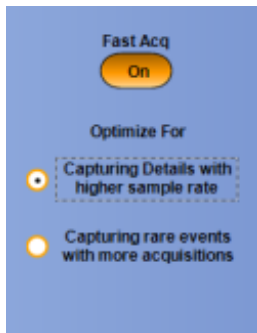

To use

1. Click the Fast Acq button to turn Fast Acquisitions On or Off. You will also find this control in the Acquisitions tab of the [Horizontal/Acquisition control window](#),
2. Click the option boxes to optimize acquisitions for your measurement: Capturing Details with Higher Sample Rate enhances waveforms detail, Capturing Rare Events with More acquisitions provides the fastest update rate.

NOTE. The options *Capturing Details with higher sample rate* and *Capturing rare events with more acquisitions* are not available on MSO/DPO5000B Series instruments.

Behavior

Fast Acquisitions mode keeps the dead time between acquisitions very short. This improves the chances of acquiring infrequent events. When Fast Acquisitions are turned on, the front-panel FastAcq button is lighted.

If Fast Acquisitions mode is on and you attempt to activate a feature that conflicts with this mode, Fast Acquisitions mode will be inhibited. When the conflicting feature is turned off, in most cases, Fast Acquisitions will resume.

What do you want to do next?

[Learn about Roll mode.](#)

Dead time

Dead time is the time that the instrument requires to process an acquisition.

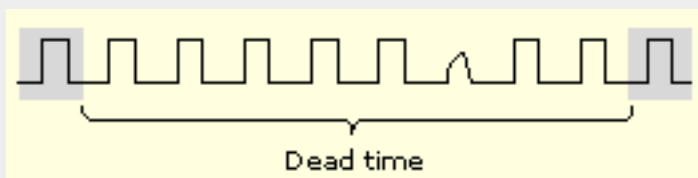

The instrument cannot acquire any new data until the previous data has been processed. If dead time is long, the instrument can miss acquiring infrequent events.

Start and stop waveform acquisitions

From the Horiz/Acq menu, select Run/Stop.

Overview

Use the Run/Stop control window to start and stop waveform acquisition.



To use

- Click Run/Stop to toggle waveform acquisition. (You can also press the front panel Run/Stop button.)
- Click Single Sequence to complete a single acquisition sequence.
- Click Force Trigger to immediately start acquiring waveform data without a valid trigger event.

Behavior

These controls operate identically to the front-panel controls.

- Click Run/Stop once to stop waveform acquisition. The Status readout at the top of the graticule changes from Running to Stopped and shows the number of acquisitions. Click Run/Stop again to resume waveform acquisition.
- Click Single Sequence to provide a single sequence of acquisitions each time you click the button. When Single Sequence is enabled, the front-panel single sequence (Single) button is lighted.
- In Sample, Peak Detect, or Hi Res acquisition modes, the instrument acquires waveform records with the first valid trigger event and then stops. In Average or Envelope acquisition modes, the instrument makes the specified number of acquisitions to complete the averaging or enveloping task.
- In Waveform Database mode, the instrument acquires and displays a waveform that is the accumulation of several acquisitions. In addition to time and amplitude, the waveform displays a count of the number of times a specific sample point has been acquired.
- When you click Single Sequence (or press the Single button) in Equivalent Time mode, the instrument continues to recognize trigger events and acquires samples until the waveform record is filled.
- Click Force Trigger once to acquire a waveform record without a trigger event. Forcing a trigger is useful when the input signal does not contain a valid trigger. The instrument recognizes and acts upon the forced trigger even when you click the button before the end of the pretrigger holdoff. The button has no effect when acquisitions are stopped.

What do you want to do next?

[Go to the Horizontal/Acquisition control window.](#)

[Return to the Acquisition Setup control window.](#)

[Return to the Trigger Setup control window.](#)

Enable roll mode

From the Horiz /Acq menu, select Roll Mode Auto, or click Roll Mode in the Acquisition tab of the [Horizontal/Acquisition control window](#).

Overview

Use these controls to turn Roll Mode on or off.



Roll mode lets you see acquired data without waiting for the acquisition of a complete waveform record. It gives you immediate feedback. For slow time base settings, Roll mode provides a rolling display similar to a strip-chart recorder.

To use

- The resolution appears near the lower-right corner of the graticule and is controlled by the Resolution knob.
- Use Untriggered Roll Mode to continuously observe a slow process. Apply math and measurement operations after you stop the acquisition.
- When Roll mode is on, the Acquisition Status Indicator Readout displays Roll.

Behavior

When using Roll mode, you do not have to wait for slow acquisitions to fill the display. When Roll mode is enabled, the instrument displays newly acquired data points at the right edge of the display while moving the older waveform data points to the left.

Using single sequence with roll mode causes the acquisition to automatically stop after a complete waveform record is acquired. Roll mode is useful when observing a slow process where you always want to see the most recent view of that process. Roll mode with single sequence is useful to save data for later viewing. For example, at 20 seconds per division and 30 K record length, there are 12,000 seconds of acquired data points.

The maximum record length where Roll mode is allowed is 10 M.

What do you want to do next?

[Learn how Roll mode interacts with other instrument settings.](#)

[Learn about Equivalent Time mode.](#)

Select a sampling mode

From the Horiz /Acq menu, select Sampling Modes, or select a sampling Mode in the Acquisition tab of the [Horizontal/Acquisition control window](#).

To use

To enable a sampling mode, click one of the Sampling Modes button.



- In Real Time, the instrument acquires all the points in a waveform record after one trigger event.
- In Interpolated time, the instrument interpolates between the samples it acquires when it cannot acquire all the real samples it needs to fill up its waveform record after one trigger event. The instrument can interpolate either as part of an acquisition or as part of the zoom/display behavior.
- In Equivalent time, the instrument uses multiple trigger events to fill all the points in its waveform record. Equivalent time sampling begins when the time base setting (horizontal scale) is too fast for the instrument to acquire all the points in a waveform in one trigger event.

NOTE. In real-time sampling, the instrument digitizes all of the points it acquires after one trigger event. Always use real-time or interpolated sampling to capture single-shot or transient events.

Equivalent time sampling mode is not available on DPO70000SX instruments in multiscopes mode.

Behavior

Equivalent Time mode lets you accurately acquire repetitive waveforms at sample rates much higher than the base analog-to-digital converter sample rate. Equivalent time sampling is generally not useful for acquiring time-varying, random, or single-shot events.

The instrument takes a few samples with each trigger event and eventually obtains enough samples to construct a waveform record. The instrument takes samples independent of the trigger position and displays them based on the time difference between the sample and the trigger. You should only use Equivalent Time mode on repetitive signals.

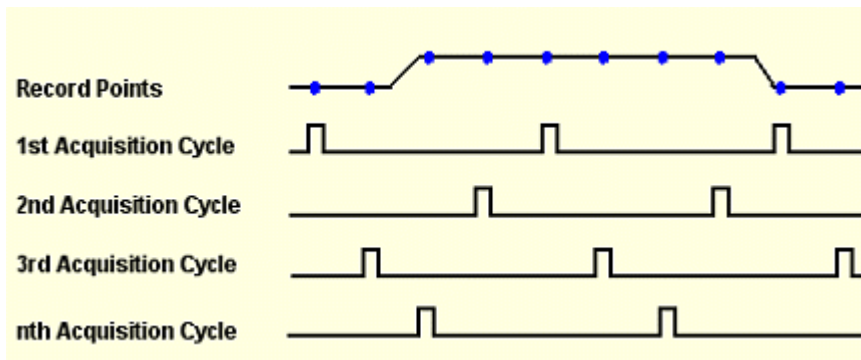

The sampling speeds and the number of channels you choose affect the mode the instrument uses to sample waveforms. The instrument always uses real-time sampling at slower time base settings; faster time settings force the instrument to switch from real-time sampling to equivalent-time sampling.

The following tables show the time base setting(s) at which the switch from real-time sampling (RT) to equivalent-time sampling (ET) occurs for your instrument.

| Sampling mode selection DPO7354C, DPO7254C, and DPO7104C with Option 2SR | | | |
|--|-------|-------|--------|
| Channels on | 1 | 2 | 3 or 4 |
| Time base ≥ 100 ps/pt | RT | RT | RT |
| 50 ps/pt | RT | RT | ET |
| 25 ps/pt | RT | ET | ET |
| ≤ 25 ps/pt | ET | ET | ET |
| Channels on | 1 | 2 | 3 or 4 |
| Time base ≥ 200 ps/pt | RT | RT | RT |
| 100 ps/pt | RT | RT | ET |
| 50 ps/pt | RT | ET | ET |
| ≤ 50 ps/pt | ET | ET | ET |
| Channels on | 1 | 2 | 3 or 4 |
| Time base ≥ 400 ps/pt | RT | RT | RT |
| 200 ps/pt | RT | RT | ET |
| 100 ps/pt | RT | ET | ET |
| ≤ 100 ps/pt | ET | ET | ET |
| Channels on | 1 | 2 | 3 or 4 |
| Time base ≥ 40 ps/pt | RT | RT | RT |
| ≤ 20 ps/pt | ET/IT | ET/IT | ET/IT |
| Channels on | 1 | 2 | 3 or 4 |
| Time base ≥ 20 ns/div | RT | ET | RT |
| 10 ns/div | ET/IT | ETIT | ET/IT |
| Channels on | 1 | 2 | 3 or 4 |
| Time base ≥ 20 ns/div | RT | RT | RT |

| Sampling mode selection DPO7354C, DPO7254C, and DPO7104C with Option 2SR | | | |
|--|-------|-------|-------|
| 10 ns/div | RT | RT | ET |
| ≤5 ns/div | ET/IT | ET/IT | ET/IT |

The type of equivalent-time sampling the instrument uses is called random equivalent-time sampling. Although it takes the samples sequentially in time, it takes them randomly with respect to the trigger. Random sampling occurs because the instrument sample clock runs asynchronously with respect to the input signal and the signal trigger. The instrument takes samples independently of the trigger position and displays them based on the time difference between the sample and the trigger.

What do you want to do next?

[Go to the Horizontal Setup control window.](#)

[Return to the Acquisition Setup control window.](#)

Set the resolution

From the Horiz /Acq menu, select Resolution.

Overview

Use the Resolution control window to select the number of samples per division for all acquired waveforms.



To use

Click in the Record Length control box and use the multipurpose knob or keypad to change the setting.

Behavior

The Duration, Sample Rate, and Resolution controls are readouts only. Their settings are impacted by other controls.

- Duration specifies the time across the 10-division screen.
- Sample Rate specifies the number of samples per second that will be acquired for each waveform. The faster the sample rate, the more accurately the instrument can represent fine details in a fast signal.
- Resolution is similar to the acquisition interval. It can be thought of as the time between sample points. In most cases, the acquisition interval is the same as the resolution.
- Record Length specifies the total number of samples in the waveform acquisition. The maximum record length depends on the amount of memory in the instrument. Because the instrument can only store a finite number of waveform data points, there is a trade-off between the waveform details and the record length. You can acquire either a detailed picture of a waveform for a shorter period of time or a less detailed picture for a longer period of time.

What do you want to do next?

[Learn about the Horizontal Setup control window.](#)

[Learn about the Acquisition Setup control window.](#)

Select the acquisition mode

From the Horiz /Acq menu, highlight Acquisition Mode; then select Mode.

Overview

The acquisition mode determines how the waveform data points are produced from the sampled data.



To use

Select the acquisition mode by clicking the appropriate button.

- If you use Average or Envelope mode, select the number of waveforms for that mode using the multipurpose knob.
- If you use Waveform Database mode, select the number of samples using the multipurpose knob.

Behavior

A single waveform data point can be made up of several sequentially acquired data points. The waveform data points can also be created from a composite of sampled data taken from multiple acquisitions.

- Sample mode acquisition creates a record point by saving one or more samples during each *acquisition interval*. Sample mode is the default acquisition mode. The instrument does no post processing of the acquired samples in this mode.
- Pk Detect (Peak Detect) acquisition alternates between saving the highest sample in one acquisition interval and the lowest sample in the next acquisition interval. Peak Detect mode only works with real-time, noninterpolated sampling.
- Hi Res (High Resolution) acquisition averages all samples taken during an acquisition interval to create a record point. This average results in a higher-resolution, lower-bandwidth waveform. This mode only works with real-time, noninterpolated sampling.
- Envelope acquisition acquires and displays a waveform record that shows the extremes in variations over several acquisitions. The instrument saves the highest and lowest values in two adjacent intervals similar to the Peak Detect mode. Unlike Peak Detect mode, the peaks are gathered over many trigger events.
- Average acquisition acquires and displays a waveform record that is the average result of several acquisitions. This mode reduces random noise. Use the multipurpose knob to specify the number of waveforms that you want to average.

After each trigger event, the instrument acquires data and then compares the minimum and maximum values from the current acquisition with those stored from the previous acquisition. The final display shows the most extreme values for all the acquisitions for each point in the waveform record.

- WfmDB (Waveform Database) acquisition acquires and displays a waveform that is the accumulation of several acquisitions. In addition to time and amplitude, the waveform displays a count of the number of times a specific sample point has been acquired. The value at each point on the waveform is a counter that reflects the hit intensity. The instrument acquires data after each trigger event using Sample mode. It then determines the location of each sample point and accumulates it with shared data from previous acquisitions. This is the only mode that can be used when doing mask testing with an optical standard. Fast Acq is inhibited in Waveform Database mode.

What do you want to do next?

[Learn about the Horizontal Setup control window.](#)

[Learn about the Acquisition Setup control window.](#)

Acquisition interval

The acquisition interval is the time between sample points. For mathematical purposes, it is the time covered by the waveform record divided by the record length.

FastFrame control windows

From the Horiz /Acq menu, select FastFrame Setup.

Overview

Use the FastFrame control windows to capture and view a series of triggered acquisitions without wasting acquisition memory on the dead time between the trigger events.

NOTE. On DPO7000SX instruments, FastFrame is not available in multiscope mode.

For information on the controls, click the buttons.

- [Setup](#)
- [View](#)
- [Analyze](#)

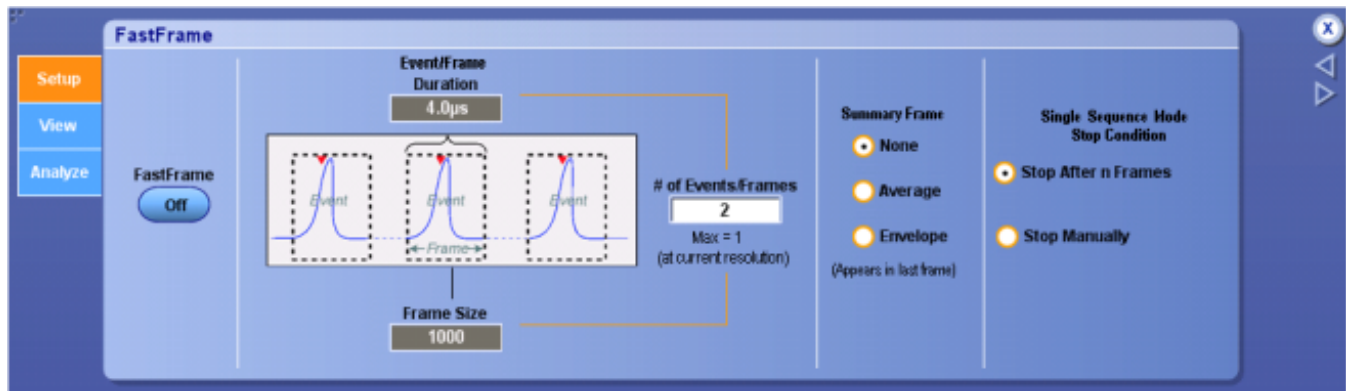

Behavior

FastFrame mode combines multiple acquisitions into one large data record. By carefully defining the trigger conditions, you can use FastFrame to capture only multiple events of the waveform that you are interested in. Each captured event is stored sequentially in its own frame. The frames are in the order they were captured.

FastFrame mode lets you jump to and view the desired frame. Time Stamps can display the absolute trigger time for a specific frame and the relative time between triggers of two specified frames. FastFrame lets you compare different waveforms. Math is performed on each frame.

FastFrame provides the following features:

- Measure time between triggered acquisitions using time stamps in Sample, Peak Detect, and Hi Res mode.
- Save and recall FastFrame waveforms.
- Display waveforms in YT mode.
- Apply math functions to FastFrame waveforms.

- Confine automatic measurements only to the displayed frame.
- Overlay multiple frames for easy comparison.

FastFrame is not compatible with the following features or modes:

- Equivalent Time
- Histograms
- Fast Acquisitions
- Average
- Envelope

What do you want to do next?

[Learn about the frame setup controls.](#)

[Learn more about the Selected Frame controls.](#)

[Learn about the reference frame and time stamps.](#)

[Learn how to set up the instrument for FastFrame operation.](#)

[Learn some tips for using FastFrame.](#)

FastFrame acquisitions

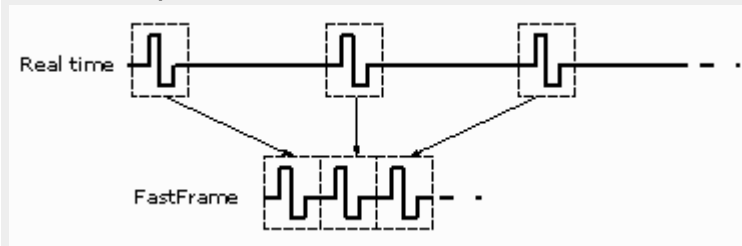

Dead time

Dead time is the time that the instrument requires to process an acquisition.

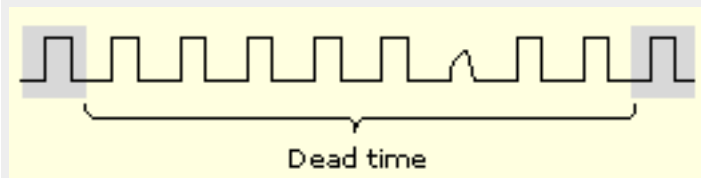

The instrument cannot acquire any new data until the previous data has been processed. If dead time is long, the instrument can miss acquiring infrequent events.

Frame

A frame is a segment of the entire data record. When used with FastFrame, each segment contains all of the data of a single acquisition. Each captured event is stored sequentially in its own frame. Frames appear in the order they were captured.

Time stamps

Time stamps are a convenient way of measuring the time between triggers when using FastFrame.

Set up zoom

From the Vertical or Horiz/Acq menu, select Zoom Setup.

Overview

Use these control windows to define the overall settings of the Zoom controls.

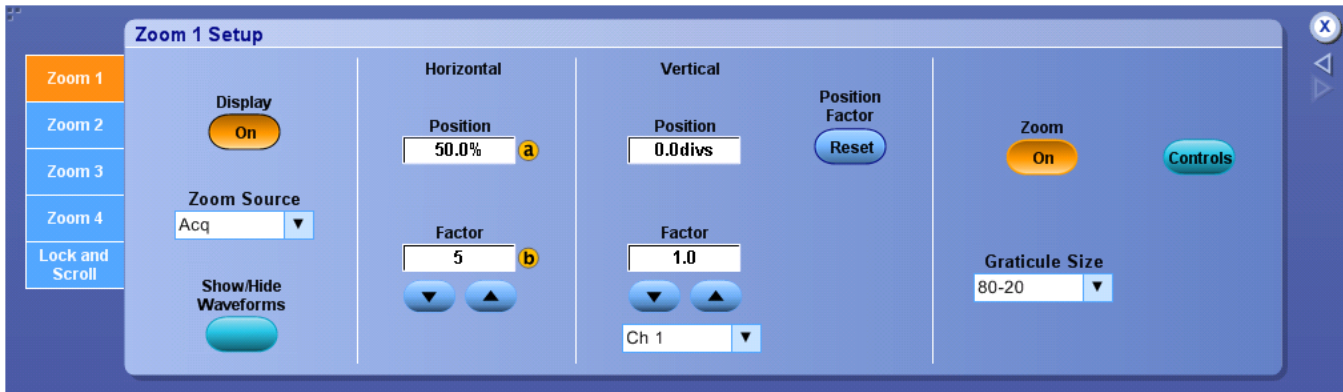

To use

- Click the Zoom <1–4> tabs to set up each zoom area. The controls under each tab apply only to that zoom area. Click the Display On to turn on the display of that area. (MultiView Zoom must also be turned on to display any of the zoom areas.)
- Click in the Zoom Source entry box, and then use the drop-down list to select a source for the zoomed area.
- Click the Show/Hide Waveforms button to open the Show/Hide Waveforms dialog box; here you can identify waveforms you do not want to display in the selected zoom area.
- Click the Zoom button On to turn on Zoom. You can also toggle Zoom on and off with the MultiView Zoom button on the front panel.
- Click the Ch <1–4> entry box, and then use the drop-down list to select which waveform, (Ch <1– 4>, Math <1–4>, or Ref <1– 4>), the Vertical Position and Factor controls adjust.
- Click in the Position and Factor entry boxes, and then use the controls to change the position and factor (or scale) in the Zoom area. They can be adjusted with the multipurpose knobs. To reset the Position and Factor controls, click Reset.
- Click the Graticule Size down arrow and select the size of the Acquisition and Zoom windows from the drop-down list. Select 80-20 to allocate 80% of the available display for the zoomed graticule and 20% for the acquisition window. Select 50-50 to allocate half of the available display for the zoomed graticule and half of the available display for the acquisition window. Select Full to use the entire display for the zoomed graticule.
- Click the Lock and Scroll tab to scroll the zoomed area(s). To scroll a single zoomed area, select the zoom area (1–4), and then click an Auto Scroll button. You can also set the scroll speed. To scroll multiple zoomed areas simultaneously, click Lock, and then click the zoomed areas (1–4) you want to scroll through. This locks the zoomed areas in their relative horizontal positions.



TIP. Use the Vertical or Horiz/Acq menu Zoom Graticule Size submenu to directly access the Graticule Split options.

Behavior

Use the Zoom Setup control window to magnify (zoom in on) a waveform without changing the main acquisition parameters. Use Zoom when you want to temporarily look at details of a waveform.

If the zoom areas are unlocked, the Horizontal Position and Factor controls affect only the selected zoom area. The Horizontal Position and Factor will affect all zoom areas that are locked together, such that a change to one zoom area will change the horizontal position and factor of all the locked zoom areas.

On the Vertical Zoom tab, the Scale and Factor controls only affect the selected waveform.

What do you want to do next?

[Return to the Vertical Setup control window overview.](#)

[Return to the Horizontal Setup control window.](#)

Error detector setups

Use the serial error detector

From the Analyze menu, select Serial Error Detector. Error detector is not available on DPO70000SX instruments.

Overview

The Serial Error Detector requires option ERRDT. The oscilloscope Error Detector conducts Bit, Frame, Symbol, and Character tests much like a BERT. It has the advantage that it not only counts the errors and computes the error rates, but it also shows you where the error occurs in the signal and it allows you to connect probes to other channels to debug the source of the errors, such as crosstalk.

The Error Detector is often used in conjunction with TekExpress software applications to conduct receiver and margin testing.

The Error Detector has built-in preset setups that cover the most common use cases. These can be modified and saved as custom setup files for later recall. Sample arbitrary waveform generator (AWG) setup files are included for various SATA Gen3 and USB3 signals. These files make it easy to verify correct operation of the Error Detector, and may be used to test a device-under-test (DUT).

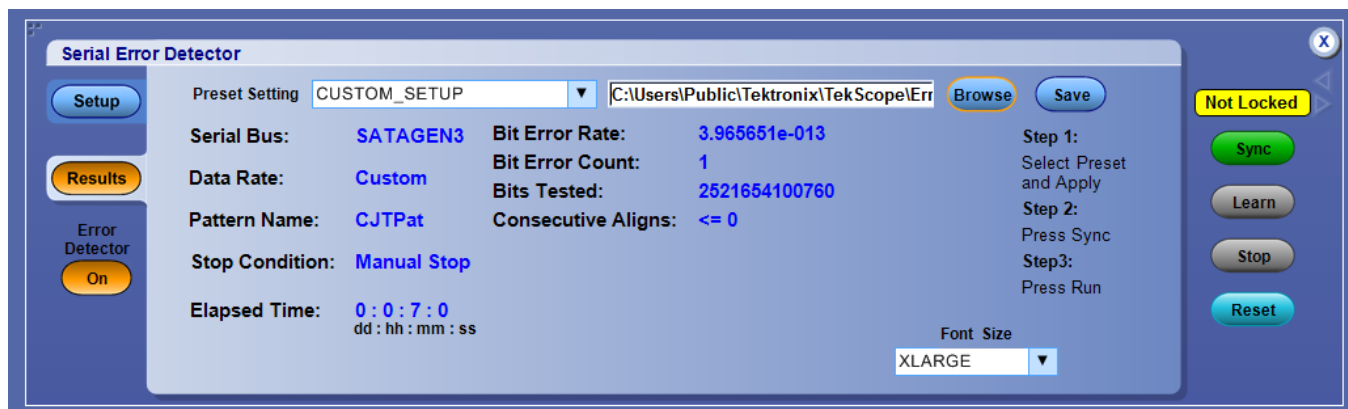

To use

- Select **Analyze > Serial Error Detector** to display the Error Detector control window.
- Select a setup from the **Preset Setting** drop-down list and press **Apply**.
- Press the **Sync** button and wait for a status of Not Counting (about 6 seconds). Depending on the signal quality, you may need to press the Sync button more than once.

Sync gets the oscilloscope synchronized to the signal.

A status of **No Signal** indicates that the oscilloscope cannot detect the signal. You may need to turn on the output of the signal generator or AWG. A status of **No Sync** may arise for Bit tests that require a known pattern length, sync pattern, or alignment character.

- Press the **Learn** button, if visible. Learn only applies to some Bit Error Tests. Frame, Symbol, and Character tests do not require the learn operation. Learn discovers the repeating pattern in the signal and stores it into system memory for comparison to the signal to determine errors in the signal. Once a signal is in memory, it remains there until the next Learn operation, so you do not have to use the Learn button every time you start testing for errors.

- Press the **Run** button to start the error detector.
If desired, you may press Stop or Reset at anytime. After a Stop, you can press Run again.
Run starts the Error Detector testing for errors.
- Select the Results tab to see the results of running the error detector.

NOTE. The Serial Error Detector automatically resyncs and resets all counts to zero if you press or disconnect and then reconnect the signal.

If you are using one of the supplied AWG signal patterns, you can press the **Force Event** button on the AWG to induce an error in the signal to verify the operation of the Error Detector. These AWG setup files are located in Win7 in the directory C:\User\Public\Tektronix\Tekscope\ErrorDetector\AWG

Alternatively, you can verify operation by disconnecting and reconnecting the signal. There will be massive errors when the signal is disconnected, but after the signal is reconnected the Error Detector will resynchronize to the signal, clear the error counts and rates, and resume testing.

- Press the Error Detector Off button to end the error detector session. A popup will appear saying the trigger has changed to Edge.

What do you want to do next?

[Set up the serial error detector.](#)

[Set error detector advanced settings.](#)

[Specify the error detector test pattern.](#)

[Set the error detector stop condition.](#)

Set up the serial error detector

From the Analyze menu, select Serial Error Detector, press Setup, and then select the **Source Setup** tab. Error detector is not available on DPO7000SX instruments.

Overview

If you select the Custom Setup or you select one of the presets, but want to make some changes to its settings, then you will need to make selections in the Setup tab.

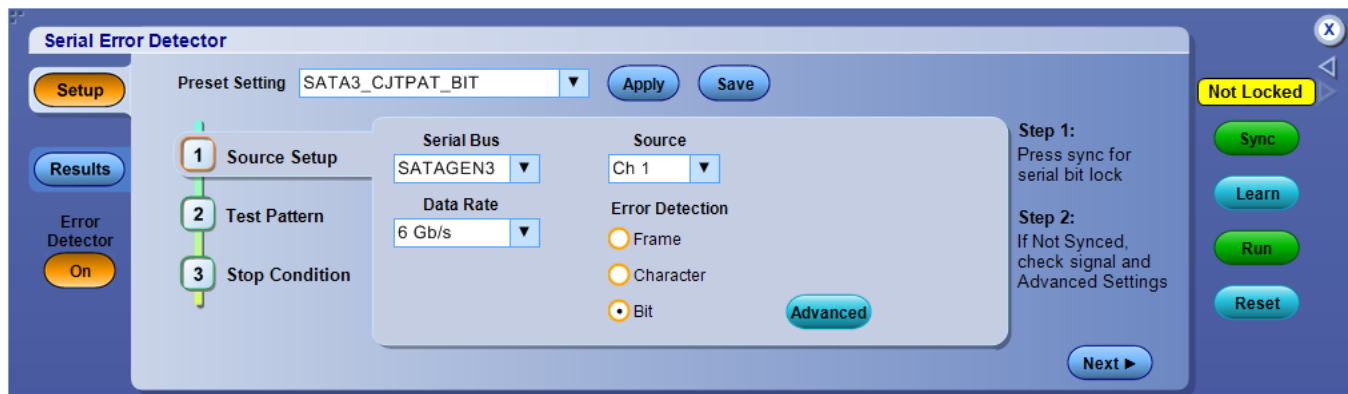

To use

- When you select the **Custom_Setup**, additional controls are put on the display so you can browse for a setup file. The usual idea is to start with a setup that is close to what you want, use the UI to specify the settings you desire, and then save the result. When you enter a new name for the file in the file name text control, press **Enter** to have your editing changes accepted. Then select the **Save** button to actually save the setup into the file. To recall a setup file, just browse to the file you want and select Open. The default location for Error Detector setup files in Win7 is C:\Users\Public\Tektronix\TekScope\ErrorDetector.
- From the **Source Setup** tab, select the Serial Bus, Data Rate and signal Source from the drop-down lists.
- Click the Error Detection option button for the type of error you want to detect.
- Press **Advanced**, to open the Advanced Settings window.

Click Error Detector Data Rates and Error Detector Standards and Buses to display the data rates, standards and buses supported by the Serial Error Detector.

What do you want to do next?

[Use the Error Detector.](#)

[Set error detector advanced settings.](#)

[Specify the error detector test pattern.](#)

[Set the error detector stop condition.](#)

Data Rates Supported by the Error Detector

The range of data rates supported by the serial error detector matches the 8b/10b serial pattern trigger range. The serial error detector will test 8b/10b-encoded data with following range of data rates: 1.25 to 1.65, 2.0 to 3.25, 3.5 to 5.2, and 5.3 to 6.25 GBaud.

Standards and Buses Supported by the Error Detector

The serial error detector has several presets for industry standards. In addition, there is a generic 8b/10b preset. Each of these presets configure the error detector for the test types specified by the industry standard or for the test type that makes sense for the current setup.

The test types (bit, frame, symbol, or character error) supported for each industry standard and for the generic 8b/10b bus are listed in the following table.

Table 3: (Category) specifications

| Standard | Test type | | | |
|-------------|-----------|-------|--------|-----------|
| | Bit | Frame | Symbol | Character |
| SATA | Yes | Yes | No | Yes |
| USB | Yes | No | Yes | Yes |
| PCI Express | Yes | No | No | Yes |
| 8b/10b | Yes | No | No | Yes |

Set error detector advanced settings

From the Analyze menu, select Serial Error Detector, press Setup, elect the **Source Setup** tab, and then press the **Advanced** button. Error detector is not available on DPO70000SX instruments.

Overview

Advanced Settings allow you to set the Align Primitives and enable or disable spread spectrum clock tracking.

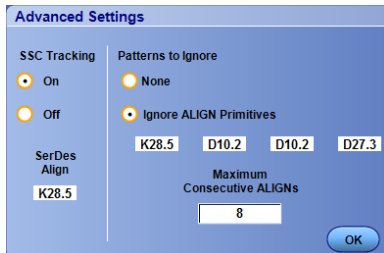

To use

- Click **On** or **Off** to turn Spread Spectrum Clocking (SSC Tracking) on or off.
SSC is ON by default and Tektronix recommends that it should always be ON, even if there is no SSC on the signal.
- To ignore align primitives, select the **Ignore Align Primitives** option button and specify the primitives using the keypad or keyboard.
The Align Character informs the SerDes to align to 10-bit character boundaries when this character is found in the signal. Alignment Primitives, also known as skip ordered sets, are inserted into the signal by the DUT for purposes of pacing (keeping transmitter from overrunning the receiver).
- Enter the Maximum consecutive ALIGNs using the keypad or keyboard.
The maximum consecutive aligns is a design parameter of the particular DUT that indicates how many consecutive aligns are allowed.

What do you want to do next?

[Use the Error Detector.](#)

[Set up the serial error detector.](#)

[Specify the error detector test pattern.](#)

[Set the error detector stop condition.](#)

Specify the error detector test pattern

From the Analyze menu, select Serial Error Detector, press Setup, and then select the **Test Pattern** tab. Error detector is not available on DPO70000SX instruments.

Overview

The Test Pattern Setup provides control of the signal test pattern length and the Sync Pattern description. These are often the most difficult settings, because they require knowledge of the signal. The Pattern Length is the number of bits in the repeating signal being sent to the DUT or oscilloscope by the signal generator or AWG. The Sync Pattern is a 10-, 20-, 30-, or 40-bit unique pattern in the signal that the error detector uses to align the signal to the acquired comparison pattern. The Advanced check box just allows you to set the Disparity of each of the Sync Pattern symbols individually. The 'X' means "don't care." The Preset Setups set these parameters to make the job easier for the common cases.

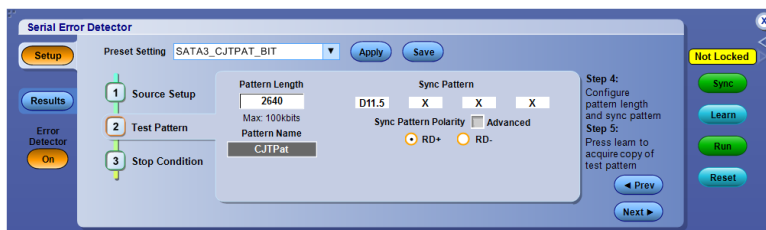

To use

- Specify the Sync Pattern, Sync Pattern Polarity, and the Pattern Length.

NOTE. Signal test patterns may be 800 to 100K bits in length, modulo 40, e.g. 800, 840, 880, 920....

What do you want to do next?

[Use the Error Detector.](#)

[Set up the serial error detector.](#)

[Set error detector advanced settings.](#)

[Set the error detector stop condition.](#)

Set the error detector stop condition

From the Analyze menu, select Serial Error Detector, press Setup, and then select the **Stop Condition** tab. Error detector is not available on DPO70000SX instruments.

Overview

Use this control window to specify the action performed when the error detector detects an error.

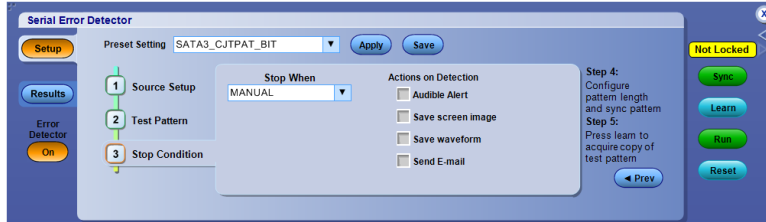

To use

- From the **Stop Condition** tab, select the Stop When condition. You can stop manually, after a preset count or time that you specify, or on an error.

NOTE. Use large numbers for bit count tests: at 6 Gb/s, 60 billion tests take 10 seconds.

- Select and setup the actions to perform when the stop condition is met. Using these actions, you can preserve the information captured by the oscilloscope. You must setup the email address and the SMTP server for Send E-mail to work.

What do you want to do next?

[Use the Error Detector.](#)

[Set up the serial error detector.](#)

[Set error detector advanced settings.](#)

[Specify the error detector test pattern.](#)

Error detector overview

Error detector is not available on DPO70000SX instruments.

The typical error detector startup sequence can be summarized as:

- Select a Preset Setup
- Press Sync
- Press Learn (if visible)
- Press Run

The Sync operation gets the oscilloscope synchronized to the signal, the Learn operation acquires the signal pattern into oscilloscope memory, and the Run operation starts the Error Detector testing for errors. Note that the Learn operation only applies to some Bit error tests. Remember, Frame, Symbol, and Character error tests do not require a Learn operation.

Then the typical sequence is to connect the DUT between the oscilloscope and the signal generator or AWG for actual testing. After recabling, only a reSync and Run are needed, even for Bit testing, because the signal test pattern has already been acquired into the oscilloscope memory.

There are several cable arrangements you can use with the Serial Error Detector. The first cable setup specifically applies to SATA, PCIe, and generic 8b10b bit testing, when a Learn operation is required to acquire the signal test pattern into Error Detector memory. However, you can use this same cable arrangement to verify Error Detector operation.

Connect the cabling as shown for the Learn operation in SATA, PCIe, and generic bit testing.

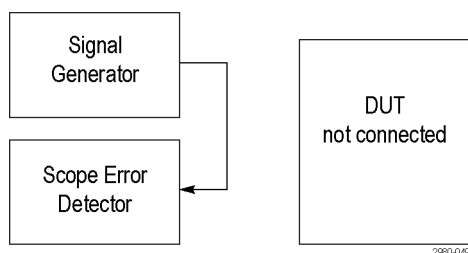

Having done the Learn operation, you can now insert the DUT in-between the Signal Generator and the Error Detector as shown.

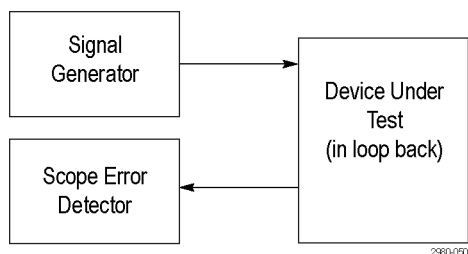

With the DUT inserted between the Signal Generator and the Serial Error Detector, all you need to do to get the Error Detector running is to press the Sync and Run buttons, because the Learn operation was completed in the previous step. If you do another Learn operation, you risk learning errors created by the DUT.

To avoid having to rearrange the cables after the Learn operation, you may split the output of the signal generator, putting one branch into the Error Detector and one branch into the DUT. Here the Learn Operation is done on Ch1, but the actual error detection occurs on Ch2. You can adjust the amplitude of the signal generator to account for the loss due to splitting the signal. This works because the Error Detector learn operation stores the signal test pattern into error detector memory, not channel memory.

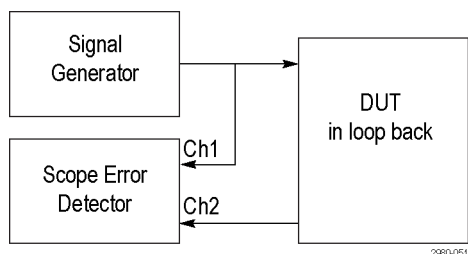

When the Error Detector is driven from the user interface, bus triggers are used whenever possible, so that bus decoding is automatically enabled. The Decoding indicates the location of the error in the signal by highlighting the decoded value in red, as shown in the screen capture below. You can use additional oscilloscope channels to simultaneously probe other signals to debug the cause of the error.



What do you want to do next?

[Use the Error Detector.](#)

[Set up the serial error detector.](#)

[Set error detector advanced settings.](#)

[Specify the error detector test pattern.](#)

[Set the error detector stop condition.](#)

Link Training

Link training can facilitate debugging the high speed serial link training protocol found in 100G Datacom applications. Standards include Ethernet and InfinBand using NRZ electrical signaling at 25 Gbps, such as 100GBASE-CR4, CEI LR, 100GBASE-LR4 and CAUI4.

Link Training environment

Oscilloscope channels are used to monitor both directions of a serial lane and present Tx and Link Partner request/response information for each direction. Analog waveform signaling activity is captured along with Control Channel protocol information to provide a complete view of the link training process.

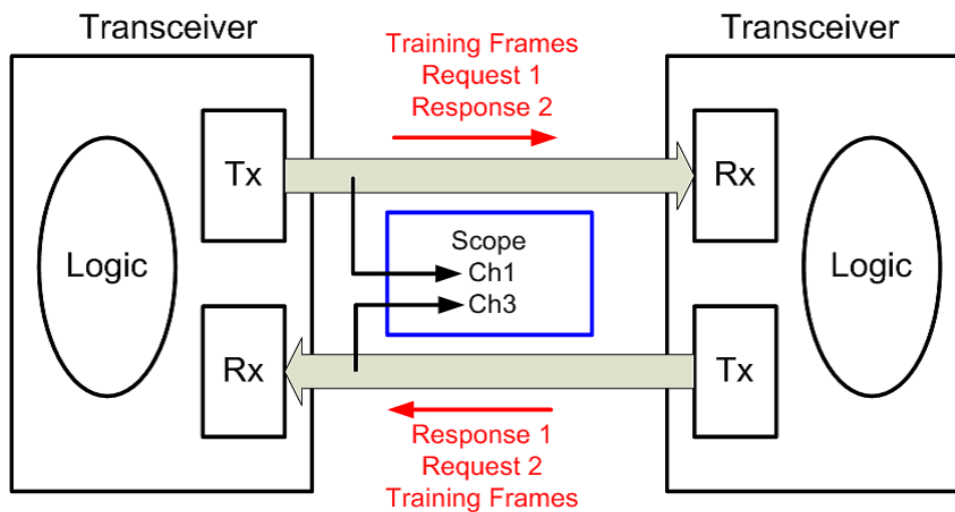

Each left/right side of the lane transmits, Coefficient Update Requests for the far transmitter changes, and Status Report Responses to confirm near transmitter changes.

The oscilloscope eavesdrops on both full-duplex conversations.

Link training activity is passively observed using 20/80 power dividers and differential probing for each lane. The following figure illustrates typical connection using breakout fixtures, power dividers and P7633 active probes.

ACQUIRE DIFFERENTIAL TX & RX

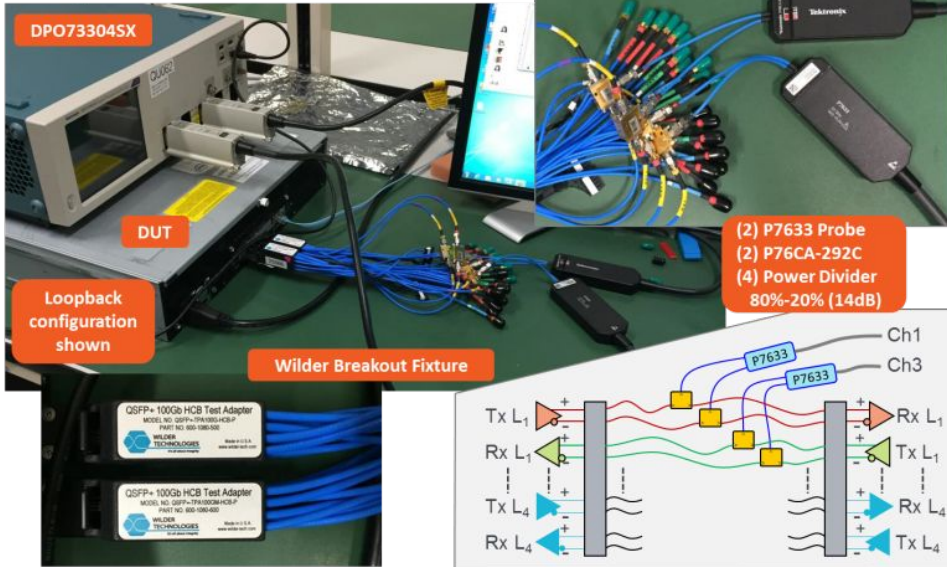

Link training connections

The oscilloscope can monitor two connected DUTs, or a single DUT in a loopback configuration. The signals are accessed using breakout fixtures, 80/20 power splitters, and P7633 differential probes. Lane1 uses oscilloscope Ch1 and Ch3, while Lane2 uses oscilloscope Ch2 and Ch4 (to maximize sample rate).

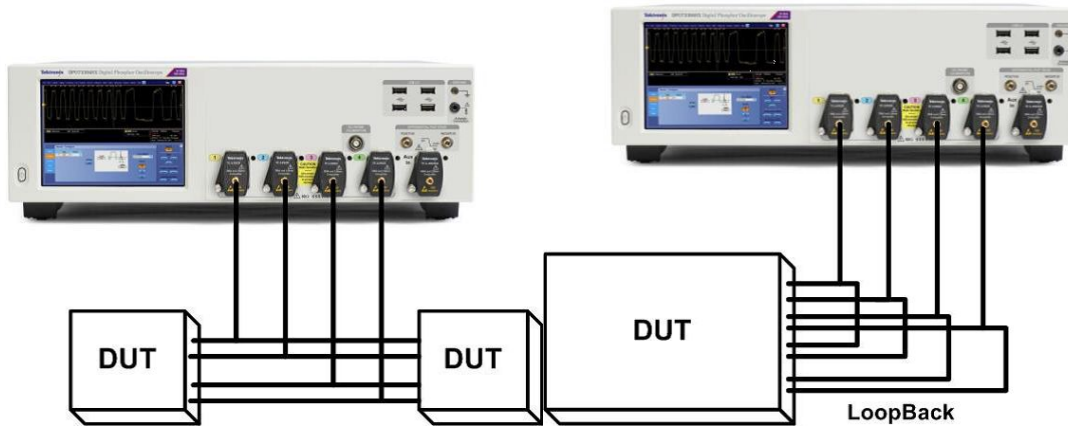

Start Link Training

To start Link Training do the following steps:

1. From the Menu Bar select **Analyze > Link Training**.



2. Press the **Arm** button.

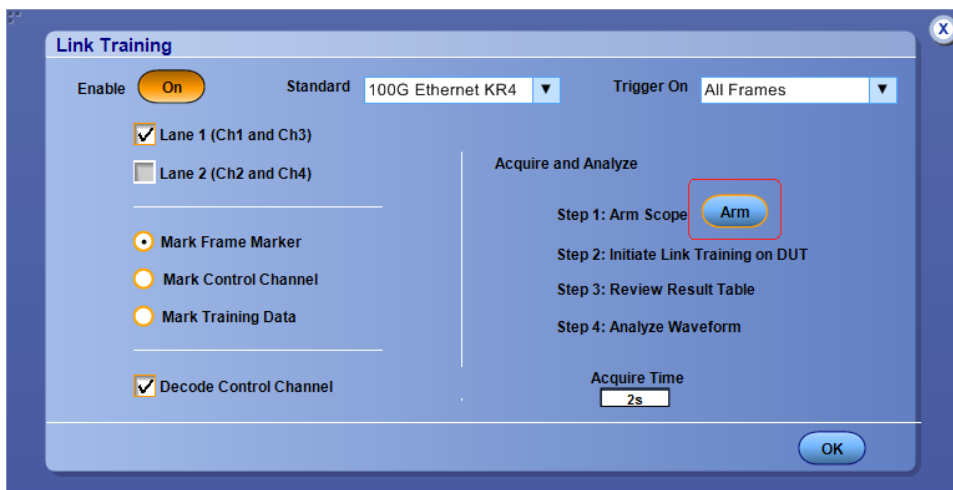

3. Start Link Training on the device under test (DUT).
Starting Link Training on the DUT is DUT-specific, but is typically done from a command line console program.

Typical Link Training display

Protocol activity is filtered during real time acquisition of the Training Sequence and each significant change is captured and time-stamped while redundant messages are discarded. This dramatically reduces the volume of data stored and expedites viewing of results.

Waveform data is recorded with each captured protocol event using FastFrame acquisition mode in the oscilloscope. This provides analog signaling information coincident with key training events for additional insight.

Because two asynchronous training conversations are taking place on a lane at one time and monitored by a single oscilloscope, it is possible that some recorded Control Channel events will occur closer in time than the oscilloscope FastFrame rearm time. For example, a Control Channel event triggers storage of a Frame (analog waveform data) but a closely-following Control Channel event in the other direction occurs before the next Frame is available for trigger. In this case, the first protocol event will have corresponding waveform information but the second event will not. In all cases, protocol events and their time of occurrence are captured.

Protocol information is decoded and marked in both a waveform view and results table view.



FastFrame records are shown in the upper view with time-aligned Hex and bit-level decoding. Marks indicating Frame, Control Channel and Training Data are also shown above the view depending on the duration and information contained within an acquisition.

Results Table

The Results Table displays all control channel information with columns indicating Request and Response activity for each direction. Each row is time-stamped and contains a unique protocol event. Click on a row of the Results Table to see a decoded waveform for the Control Channel. Rows with *** in the Frame Column do not have a waveform.

All Control Channel information is captured in the Results Table, whether or not a waveform is available.

Frame Column

| Lane1 | B1 | B3 | Marks | c1_Co[+1] | c1_Co[0] | c1_Co[-1] | c3 Preset | c3 Init | c3 Parity | c3 Co[+1] | c3 Co[0] | c3 Co[-1] | c3 Ready | c3_Co[+1] | c3_Co[0] | c3_Co[-1] | Frame |
|-------|---------|---------|---------|-----------|----------|-----------|-----------|---------|-----------|-----------|----------|-----------|----------|-----------|----------|-----------|-------|
| | Not Upd | Not Upd | Not Upd | | | | Normal | Normal | Odd | Hold | Hold | Hold | Continue | Not Upd | Not Upd | Not Upd | 1 |
| | | | | | | | | | | | | | | | | | 2 |
| | | | | | | | | | | | | | | Max | Max | Max | *** |
| | | | | | | | Preset | | | | | | | | | | 3 |
| | | | | | | | | | | | | | | | | | *** |
| | Max | Max | Max | | | | | | | | | | | | | | 4 |
| | | | | | | | | | | | | | | Not Upd | Not Upd | Not Upd | *** |
| | | | | | | | Normal | | | | | | | | | | 5 |
| | Not Upd | Not Upd | Not Upd | | | | | | | | | | | | | | *** |
| | | | | | | | | | | | | | | | | | 6 |
| | | | | | | | | | | | | | | | | | 7 |
| | | | | | | | | | | | | | | | | | *** |
| | | | | | | | | | | | | | | | | | 8 |
| | | | | | | | | | | | | | | | | | *** |
| | | | | | | | | | | | | | | | | | 9 |

Contents of the Results Table may be exported to a comma separated value (.CSV) file or queried over the instrument programming interface (PI) for further post processing or formatting.

Using Link Training from the programming interface

Use the following commands to start Link Training:

```
LINKTraining:STate ON
```

```
LINKTraining:ARMScope ON
```

Start Link Training on the DUT. Initiation of Link Training on the DUT is DUT-specific, but is typically done from a command line console program.

The oscilloscope captures the Link Training information into a Results Table in real-time, and displays the marked and decoded waveforms.

The following programming commands are available for Link Training:

```
:LINKTRaining:STATE <OFF | ON> //Default: OFF
```

```
:LINKTRaining:ARMScope <OFF | ON> //Default: OFF
```

```
:LINKTRaining:STANdard <Ethernet_100G_KR4 | Ethernet_100G_CR4> //Default:  
Ethernet_100G_KR4
```

```
:LINKTRaining:LANE1 <OFF | ON> //Default: ON
```

```
:LINKTRaining:LANE2 <OFF | ON> //Default: OFF
```

```
:LINKTRaining:LANE3 <OFF | ON> //Default: OFF
```

```
:LINKTRaining:LANE4 <OFF | ON> //Default: OFF
```

```
:LINKTRaining:MARK <FRame | CONTro1 | TRAIning> //Default: FRame
```

```
:LINKTRaining:TRIGgeron <FIRSt_frame | LAsT_frame | ALL_frames> //Default  
ALL_frames
```

```
:LINKTRaining:ARMScope <OFF | ON> //Default: OFF
```

Mask testing setups

Mask setup

Mask testing control window (Masks tab)

From the Mask menu, select Mask Setup.

Overview. Use these controls to set up a mask test. You can set the type of mask, polarity, display, and alignment.

NOTE. The Comm Trigger is designed to work with communications mask and standard testing. Mask testing automatically uses Communication triggers. You must install the [Serial Communications Mask Testing Option](#) on some instruments before you can access the Comm triggers. DPO7000SX instruments only have the User Mask type.

For information on the controls, click the buttons.

- [Type](#)
- [Display](#)
- [Lock Mask](#)
- [Hit Count](#)
- [Autoset](#)
- [Autofit](#)

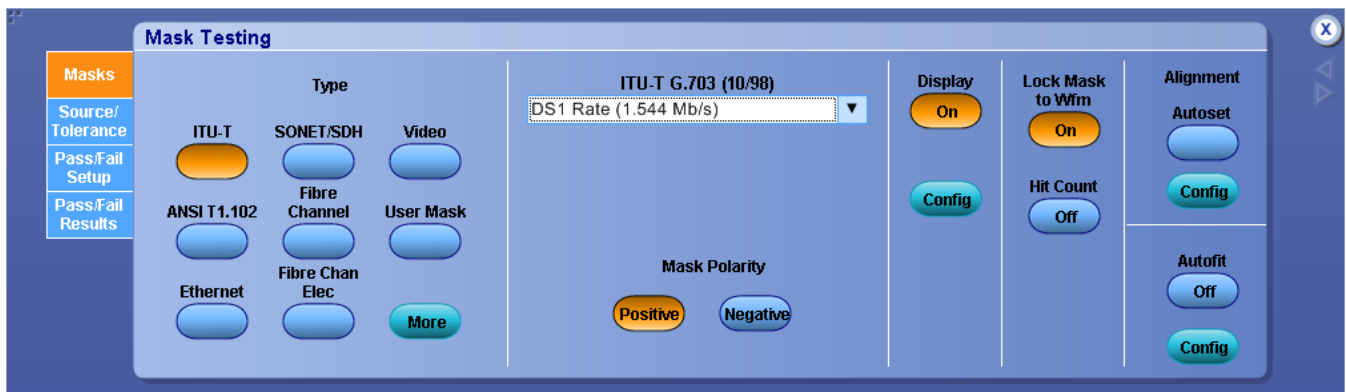

What do you want to do next?

[Learn more about mask setups.](#)

[Learn more about mask test setups.](#)

Serial mask testing option

Some instruments require mask testing options:

- Install Option MTM on DPO7000C and MSO/DPO5000B Series instruments.
- Install Option MTH on MSO70000C/DX and DPO70000C/DX Series instruments.

Select a mask type

From the Mask menu, select Mask Setup; then open the Masks tab.

Overview. Use the Type controls to choose a mask. Use the standard drop-down list to select a standard for the mask test. The Mask Polarity control will appear, depending on the standard selected. Use the Mask Polarity controls to choose whether to test the positive pulse, negative pulse, or both.

NOTE. The Comm Trigger is designed to work with communications mask and standard testing. Mask testing automatically uses Communication triggers. You must install the Serial Communications Mask Testing Option on some instruments before you can access the Comm triggers. DPO70000SX instruments only have the User Mask type.

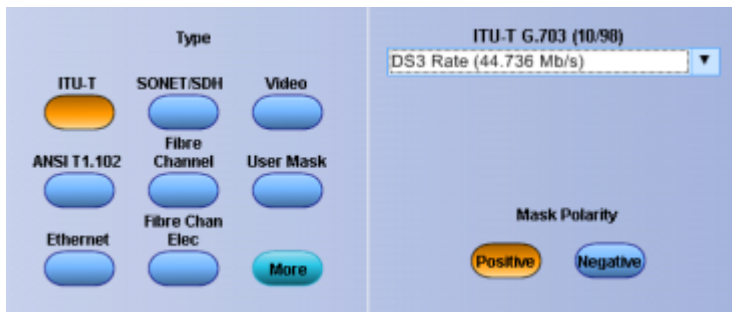

To use.

1. Click one of the Type controls to select the mask type.
2. Click More for additional selections.
3. Click the standard drop-down list to select the mask standard.
4. If the Mask Polarity control is displayed, click it to select positive or negative.

Behavior. The type of mask you choose will determine which standards are available from the standard drop-down list. The standard selected will determine whether the Mask Polarity control is displayed.

NOTE. For some masks, you may see a pop-up message that reads, "Consider System Bandwidth when testing at this bit rate." This message appears if the bandwidth of the measurement system falls below 1.5 – 1.8 times the bit rate of the data signal. Because the T11 committee has published a strict rule of 1.8 times the bit rate for electrical standards, be aware that useful qualitative information can be gathered at the current system bandwidth but quantitative rise-time measurements may not be reliable. A Consider System Bandwidth message will appear for all optical standards, since optical filtering is not available.

Alternatively, you can select Edge Setup from the Trigger menu to improve the stability.

What do you want to do next?

[Learn about the Mask Display control window.](#)

[Learn more about mask alignment.](#)

[Go to the Mask Setup control window.](#)

Mask types and standards

The following tables list the Mask Types and Standards available with Mask Testing. The standards available for your instrument depend on the bandwidth and configuration of your instrument.

The Comm Trigger is designed to work with communications mask and standard testing. Mask testing automatically uses Communication triggers. You must install the [Serial Communications Mask Testing Option](#) on some instruments before you can access the Comm triggers.

| ITU-T masks | | | |
|------------------------------|-----------------------------|-----------------------------|------------------------------|
| None | 32 Mb 32.064 Mb/s | 97 Mb 97.728 Mb/s | DS1 Rate 1.544 Mb/s |
| DS2 Rate Sym 6.312 Mb/s | DS2 Rate Coax 6.312 Mb/s | DS3 Rate 44.736 Mb/s | E1 Sym Pair 2.048 Mb/s |
| E1 Coax Pair 2.048 Mb/s | E2 8.448 Mb/s | E3 34.368 Mb/s | E4 Binary 0 139.26 Mb/s |
| E4 Binary 1 139.26 Mb/s | STM1E Binary 0 155.52 Mb/s | STM1E Binary 1 155.52 Mb/s | |
| None | DS1 1.544 Mb/s | DS1A 2.048 Mb/s | DS1C 3.152 Mb/s |
| DS2 6.312 Mb/s | DS3 44.736 Mb/s | DS4NA 139.26 Mb/s | DS4NA Max Output 139.26 Mb/s |
| STS-1 Pulse 51.84 Mb/s | STS-1 Eye 51.84 Mb/s | STS-3 155.52 Mb/s | STS-3 Max Output 155.52 Mb/s |
| None | 100Base-TX STP 125 Mb/s | 100Base-TX UTP 125 Mb/s | Gigabit Ethernet 1.25 Gb/s |
| 1000B-CX Norm, TP2 1.25 Gb/s | 1000B-CX Abs, TP2 1.25 Gb/s | 1000B-CX Abs, TP3 1.25 Gb/s | XAUI, Near 3.125 Gb/s |
| XAUI, Far 3.125 Gb/s | 1000B-SX/LX 1.25 Gb/s | | |
| None | OC1/STM0 51.84 Mb/s | OC3/STM1 155.52 Mb/s | OC12/STM4 622.08 Mb/s |
| OC48/STM16 2.4883 Gb/s | OC48-FEC 2.666 Gb/s | | |
| None | FC133 Optical 132.8 Mb/s | FC266 Optical 265.6 Mb/s | FC531 Optical 531.2 Mb/s |
| FC1063 Optical 1.0625 Gb/s | FC1063 Optical Draft Rev 11 | FC2125 Optical 2.125 Gb/s | |
| None | FC133E Elec. 132.8 Mb/s | FC266E Elec. 265.6 Mb/s | FC531E Elec. 531.2 Mb/s |
| FC1063E Elec. 1.0625 Gb/s | FC1063E Norm, Beta, Transm | FC1063E Norm, Delta, Transm | FC1063E Norm, Gamma, Transm |
| FC1063E Abs, Beta, Transm | FC1063E Abs, Delta, Transm | FC1063E Abs, Gamma, Transm | FC1063E Abs, Beta, Recv |
| FC1063E Abs, Delta, Recv | FC1063E Abs, Gamma, Recv | FC2125E Norm, Beta, Transm | FC2125E Norm, Delta, Transm |

| ITU-T masks | | | |
|------------------------------|----------------------------|----------------------------|----------------------------|
| FC2125E Norm, Gamma, Trans | FC2125E Abs, Beta, Transm | FC2125E Abs, Delta, Transm | FC2125E Abs, Gamma, Transm |
| FC2125E Abs, Beta, Recv | FC2125E Abs, Delta, Recv | FC2125E Abs, Gamma, Recv | |
| None | 2.5 Optical 2.5 Gb/s | 2.5 Electrical 2.5 Gb/s | |
| None | G1 Tx 1.5 Gb/s | G1 Rx 1.5 Gb/s | |
| G2 Tx 3.0 Gb/s | G2 Rx 3.0 Gb/s | | |
| None | FS 12 Mb/s | HS:T1 480 Mb/s | HS:T2 480 Mb/s |
| HS:T3 480 Mb/s | HS:T4 480 Mb/s | HS:T5 480 Mb/s | HS:T6 480 Mb/s |
| None | S400b T1 491.5 Mb/s | S400b T2 491.5 Mb/s | S400b Optical 491.5 Mb/s |
| S800b T1 983.0 Mb/s | S800b T2 983.0 Mb/s | S800b Optical 983.0 Mb/s | S1600b T1 1.966 Gb/s |
| S1600b T2 1.966 Gb/s | S1600b Optical 1.966 Gb/s | | |
| None | Drv 500 Mb/s | Drv 750 Mb/s | Drv 1.0 Gb/s |
| Drv 1.5 Gb/s | Drv 2.0 Gb/s | Ext Drv 500 Mb/s | Ext Drv 750 Mb/s |
| Ext Drv 1.0 Gb/s | Ext Drv 1.5 Gb/s | Ext Drv 2.0 Gb/s | Rcv 500 Mb/s |
| Rcv 750 Mb/s | Rcv 1.0 Gb/s | Rcv 1.5 Gb/s | Rcv 2.0 Gb/s |
| None | RIO Serial 1.25 Gb/s | RIO Serial 2.5 Gb/s | RIO Serial 3.125 Gb/s |
| None | 4FSC NTSC "D2" 143.18 Mb/s | 4:4:2 "D1" 270Mb/s | DVB ASI 270 Mb/s |
| 4:2:2 SMPTE 259-M-D 360 Mb/s | SMPTE 292M 1.485 Gb/s | | |

Use mask display controls

From the Mask menu, select Mask Setup; then open the Masks tab.

To use.

- Click the On/Off control to turn the mask display on or off.
- Click the Config control to activate the [Mask Configuration Display](#) control window.



Behavior. When the On/Off control is on, the mask is displayed on the graticule. When the On/Off control is off, the mask is not displayed.

Click the Config button to replace the Mask Testing control window with the Mask Configuration Display control window.

What do you want to do next?

[Learn about the Mask Configuration Display control window.](#)

[Learn about mask types.](#)

[Learn about mask alignment.](#)

[Go to the Mask Setup control window.](#)

Mask configuration controls

Mask configuration control window - display. From the Mask menu, highlight Mask Configure; then select Display. From the Mask Testing control window, click the Display Config button.

Overview. Use this control window to set whether changes in the scale will also be made in the mask. You can also use this control window to return to the Mask Setup control window.

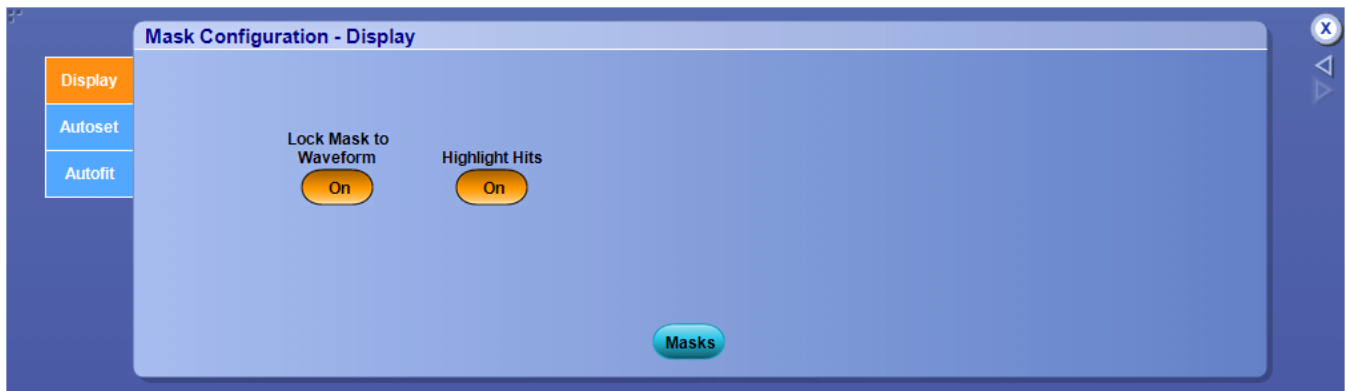

To use.

- Click the Lock Mask to Waveform button to turn it on and off.
- Click the Masks button to go to the Mask Testing control window.

Behavior. When the Lock Mask to Waveform button is turned on, any changes you make to the scale, vertical position or horizontal position will be reflected in the mask. Turning on Highlight Hits displays the hits in a different color so they can be easily seen. When you click the Mask button this window closes, and the Mask Setup control window opens.

What do you want to do next?

[Go to the Mask Setup control window.](#)

[Learn more about mask configuration.](#)

Configure mask autoset. From the Mask menu, highlight Mask Configure; then select Autoset. From the Mask Testing control window, click the Autoset Config button.

Use this control window to set the vertical, horizontal, and trigger autoset parameters, activate autofit or autoset, choose the autoset mode, return to the default autoset configuration, or go to the Mask Testing control window.

For information on the controls, click the buttons.

- [Vertical](#)
- [Horizontal](#)
- [Trigger](#)
- [Mode](#)
- [Autofit](#)

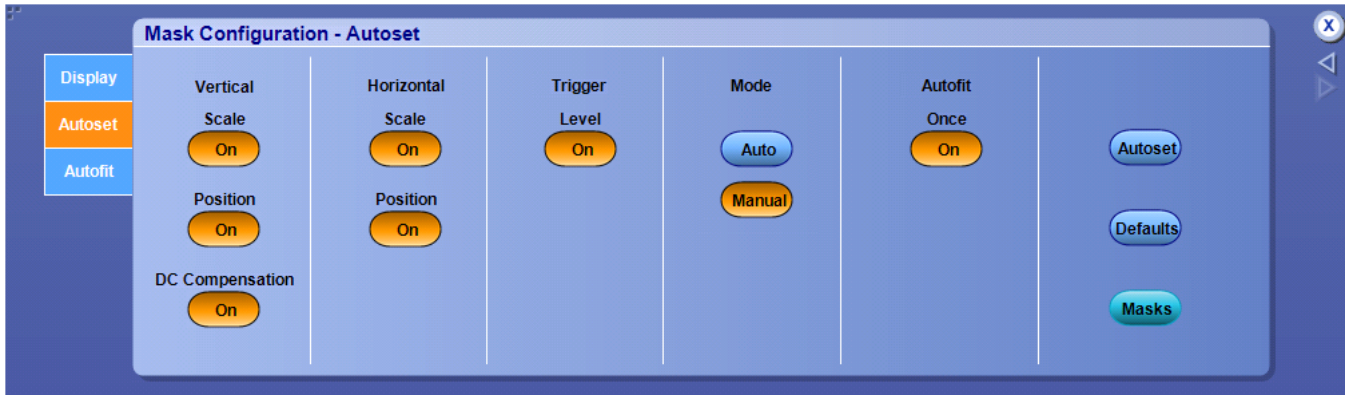

To use.

- Click Autoset to align the signal within the mask. This operates the same as the Autoset button on the front panel.
- Click Defaults to return the instrument to the default autoset configuration.
- Click Masks to replace this control window with the Mask Testing control window.

What do you want to do next?

[Go to the Mask Setup control window.](#)

[Learn about mask display configuration.](#)

[Learn about mask autofit configuration.](#)

Configure mask autofit. From the Mask menu, highlight Mask Configure; then select Autofit. From the Mask Testing control window, click the Autofit Config button.

Overview. Use this control window to configure the limits for minimizing mask hits, return to default setting, or return to the Mask Testing control window.

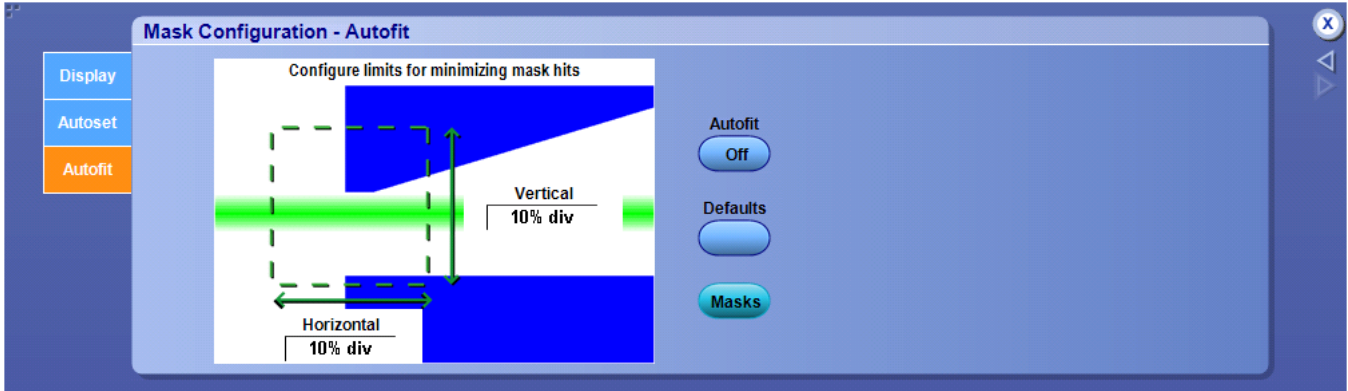

To use.

- Set the vertical and horizontal maximum levels of adjustment by clicking in the entry boxes and use the multipurpose knobs or double-clicking in the control and use the pop-up keypad.
- Click Autofit to align the signal within the mask.
- Click Defaults to reset the autofit configuration to the default values.
- Click Masks to return to the Mask Testing control window.

Behavior. The maximum level of adjustment determines how far Autofit will search for the best fit to minimize hits. For example, if you set the Vertical Maximum to 10% per division, Autofit searches up to and including 10 percent of the vertical divisions for the best fit. Autofit minimizes hits by aligning the signal within the mask.

Clicking Masks replaces the Mask Configuration Autofit control window with the Mask Testing control window.

NOTE. The interaction between Autofit and Persistence can affect the display of persistence data. Autofit moves the waveform vertically and/or horizontally to reduce the number of hits within a given mask. If either infinite or variable persistence is enabled these movements will clear any persistence data. If Autofit makes frequent adjustments, there can be little or no persistence data.

What do you want to do next?

[Learn about display configuration.](#)

[Learn about autoset configuration.](#)

Set up mask alignment

From the Mask menu, select Mask Setup; then open the Masks tab.

To use.

- Click the Autoset control to perform an autoset on the signal.
- Click the Autofit control to turn the minimize hits function on or off.
- Click the Config control to access the [Autoset](#) or [Autofit](#) Configuration control window.



Behavior. Clicking the Autoset control automatically aligns the mask based on the characteristics of the input signal. This function is done once, and that setting is not changed until you run the autoset command again or until you change any settings. This is the same as pushing the front-panel Autoset control.

When Autofit is used, the signal is aligned within the mask to minimize the number of hits on each acquisition. Settings may change after each acquisition when autofit is used.

NOTE. The interaction between Autofit and Persistence can affect the display of persistence data. Autofit moves the waveform vertically and/or horizontally to reduce the number of hits within a given mask. If either infinite or variable persistence is enabled, these movements will clear any persistence data. If Autofit makes frequent adjustments, there can be little or no persistence data.

Clicking the Autoset Config button will replace the control window with the Autoset Mask Configuration control window. Clicking the Autofit Config control will replace this control window with the Autofit Mask Configuration control window.

What do you want to do next?

[Learn about autoset configuration.](#)

[Learn about autofit configuration.](#)

[Learn about mask display setup.](#)

[Learn about mask types.](#)

[Go to the Mask Setup control window.](#)

Edit a mask

From the Mask menu, select Mask Edit Setup, or click the Edit User Mask button in the Mask Testing control window.

Overview. Use this control window to select the Segment and Vertex for editing, set the Horizontal and Vertical mask values, and Save or Recall masks.

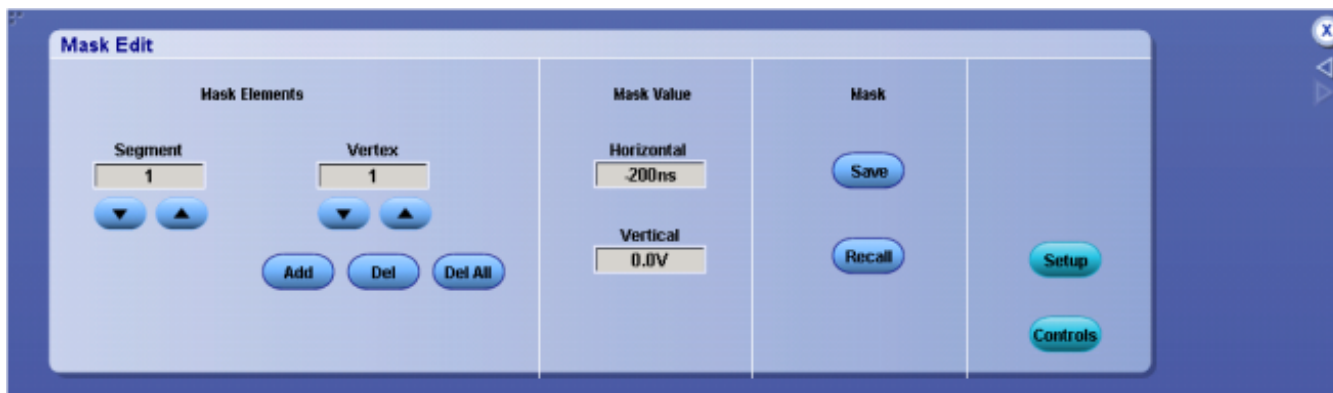

To use.

- Click the Mask Segment and Vertex up and down arrows to select the segment or the vertex of the mask to be edited.
- Click Add to add a point to the boundary in the selected segment and just after the selected vertex.
- Click Del to delete the selected vertex from the selected segment.
- Click Del All to remove all points in the selected segment.
- To change the horizontal or vertical mask values for the selected segment and vertex, click in the Horizontal or Vertical entry boxes, and then use the multipurpose knobs to set the values.
- To save a mask, click Save to activate the Save As dialog box.
- To recall a previously saved mask, click Recall to activate the Recall dialog box.

Behavior. The Segment up and down arrows increase or decrease the segment number by one. The Vertex up and down arrows increase or decrease the vertex by 1. To set a specific number, click in the Vertex entry box to activate the pop-up calculator.

Clicking the Add button adds a point to the boundary in the selected segment and just after the selected vertex in addition to moving any points that follow the newly added point in the boundary up one. For example, if there are 6 points in the boundary of the selected segment and you add a point when the selected vertex is 4, then the vertex which was 4 becomes vertex number 5, number 5 becomes 6, and vertex 6 is changed to vertex 7.

Clicking Del deletes the selected vertex from the selected segment and moves any points that follow the deleted point down one in the boundary. Clicking Del All deletes all points in the selected segment, effectively deleting that segment.

Clicking the Setup button will return you to the Masks Testing control window. Clicking the Controls button will activate the [User Mask Edit control window](#) where you can make quick changes to a User mask.

What do you want to do next?

[Learn about saving masks.](#)

[Learn about recalling saved masks.](#)

[Learn more about mask types.](#)

[Learn more about mask setups.](#)

Tolerance setup

Set up mask testing source-tolerance

From the Mask menu, select Source.

Overview. Use this control window to select the source of the signal you want to test.

For information on the controls, click the buttons.

- [Channels](#)
- [Margins Tolerance](#)

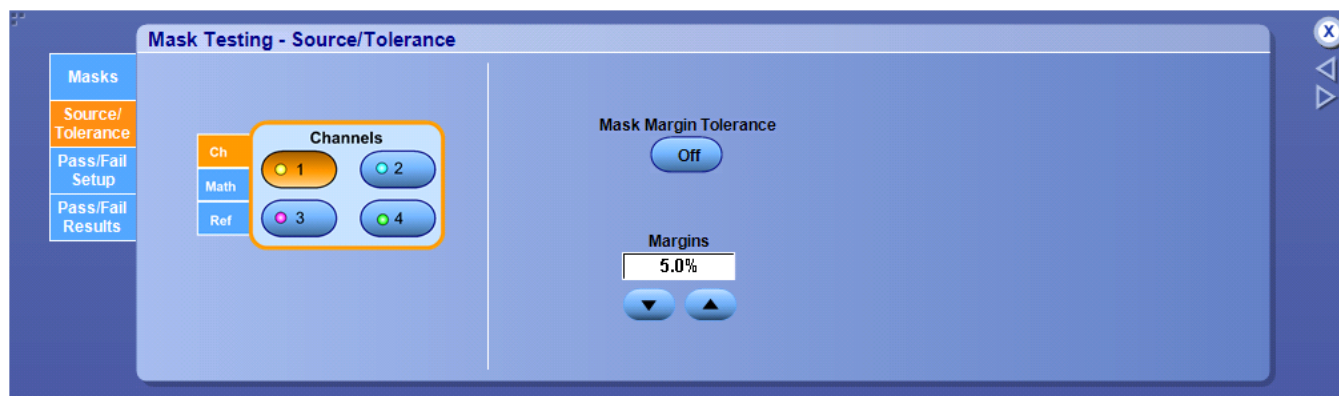

To use.

1. Click the Ch, Math, or Ref tab to select the source for mask testing.
2. Click the number (1–4) of the channel, math expression, or reference you want to use.

Behavior. When you click the Ch tab and select a channel number, it is used as the source for mask testing. You can select only one source at a time for mask testing.

What do you want to do next?

[Learn more about mask setups.](#)

[Learn more about mask test setups.](#)

[Go to the Mask Setup control window.](#)

Set up mask margins

From the Mask menu, select Tolerance Setup.

Overview. Use this control to turn the margin mode on or off and to set the percentage of margin used for the mask test.



To use.

1. Click the On/Off button to turn the mask margin tolerance on or off.
2. Click the up and down arrows or click in the Margins entry box to activate the pop-up keyboard and set the percentage of margin tolerance.

Behavior. When the mask margin tolerance is on, you can control the percentage of margin used in the mask test.

Use the up and down arrow buttons to increase or decrease the percentage in 1% increments. A tolerance that is > 0 makes passing a mask test more difficult.

A mask test that passes with a tolerance that is > 0 demonstrates that the signal passes the test with a margin for further error. Setting the tolerance to < 0 makes a mask test easier to pass. A tolerance that is < 0 can be used to demonstrate by how much of a margin the signal fails.

What do you want to do next?

[Learn more about mask testing setup.](#)

[Go to the Mask Setup control window.](#)

Fail setup

Set up pass-fail mask testing

From the Mask menu, select Pass/Fail Setup.

Overview. Use this control window to set the parameters for passing or failing the mask test, to set the test notification mode, to select the polarity for testing, and whether to repeat the test.

For information on the controls, click the buttons.

- [Mask Controls](#)
- [Test Fail Notification](#)
- [Test Completion Notification](#)
- [Polarity](#)
- [Pass Fail Test / Repeat](#)

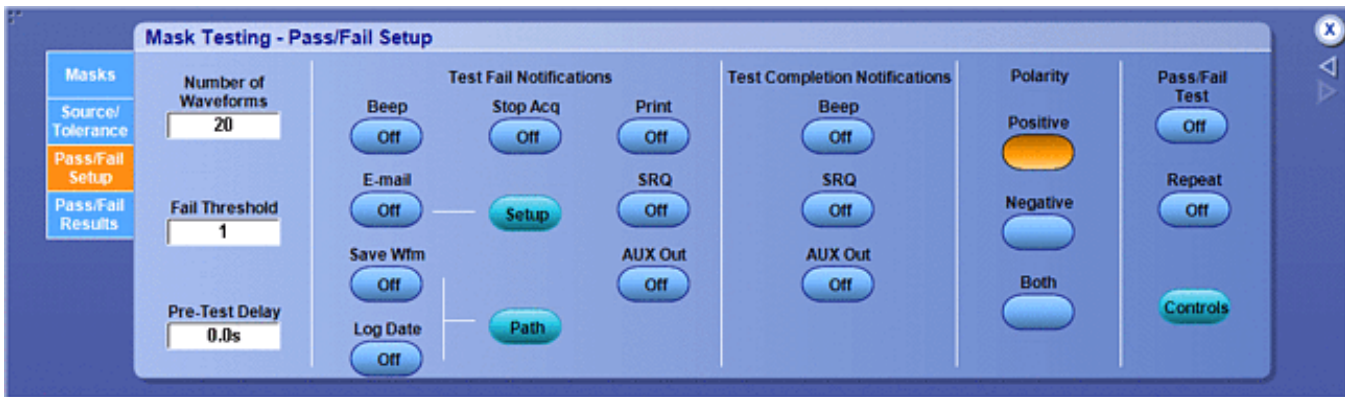

What do you want to do next?

[Learn more about mask testing.](#)

[Go to the Mask Setup control window.](#)

Set up mask test fail notification

From the Mask menu, select Pass/Fail Setup.

Overview. Use the Test Fail Notification controls to set the mode of notification when a waveform fails a mask test.



To use. Click a button to switch the control on or off. Use this control window to save a failed waveform, log the date and time of a failed waveform, and specify the directory where you want to save the waveform or send E-mail on a failed waveform.

Behavior.

- Beep. When Beep is turned on, the instrument beeps when a mask test fails.
- E-mail. When E-mail is turned on, the instrument sends an E-mail when a mask test fails. Click the Setup button and complete the [E-mail on Event Setup](#) information.
- Save WFM. When Save WFM is turned on, failed waveform data is saved to a file. Click the Path button and enter the path location for the file.
- Log Date. When Log Date is turned on, the date and time for each failed mask test is recorded to a file. Click the Path button and enter the path location for the file.
- Print. When Print is turned on, the instrument sends the waveform to a printer when a mask test fails.
- SRQ. When SRQ is turned on, the instrument sends a GPIB SRQ command when a mask test fails.
- AUX Out. When AUX Out is turned on, the instrument sends a trigger to the Auxiliary Out connector when a mask test fails. See [External Signals Control Window](#) for additional details on this feature.

What do you want to do next?

[Learn about mask polarity.](#)

[Learn about waveform parameters.](#)

[Go to the Test Setup control window.](#)

Set up mask test completion notification

From the Mask menu, select Pass/Fail Setup.

Overview. Use the Test Completion Notification controls to beep, execute a command, or send an external trigger when a waveform passes a mask test.

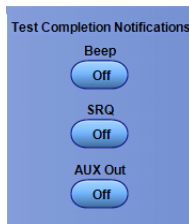

To use. Click a button to switch a control on or off.

Behavior.

- Beep. When Beep is turned on, the instrument beeps when the test is completed. Beep is not available on MSO/DPO5000B Series instruments.
- SRQ. When SRQ is turned on, the instrument sends a GPIB SRQ command when a test is completed.
- AUX Out. When AUX Out is turned on, the instrument sends a trigger to the Auxiliary Out connector when the test is completed. See [External Signals Control Window](#) for additional details on this feature.

What do you want to do next?

[Learn about mask polarity.](#)

[Learn about waveform parameters.](#)

[Go to the Test Setup control window.](#)

Set mask test parameters

From the Mask menu, select Pass/Fail Setup.

Overview. Use the Number of Waveforms (Samples), Fail Threshold, and Pre-Test Delay controls to set the parameters for the mask test.

NOTE. If you are using Waveform Database mode, the Number of Waveforms entry box changes to a Samples entry box.

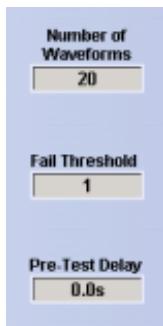

To use.

1. Click in the Number of Waveforms (Samples) entry box to activate the multipurpose knobs to enter a value.
2. Click in the Fail Threshold entry box to activate the multipurpose knobs and enter the minimum number of waveforms that must fail for the test to fail.
3. Click in the Pre-Test Delay entry box to activate the multipurpose knobs to enter the number of seconds to wait before starting the test.

Behavior. Entering a number in the Number of Waveforms (Samples) entry box stops the test when that number has been reached.

If the waveforms or samples that fail are equal to or greater than the number in the Fail Threshold entry box, the test has failed. If the failed waveforms or samples are less than the number in the Fail Threshold entry box, the test passes.

The instrument begins sampling after the number of seconds has passed set in the Pre-Test Delay entry box. Use the Test Delay if you need to give the signal source time to stabilize.

What do you want to do next

[Learn about test notification.](#)

[Learn about mask polarity.](#)

[Learn about test results.](#)

[Go to the Test Setup control window.](#)

Select the sound source

NOTE. This feature is not available on MSO/DPO5000B Series instruments.

Your instrument is shipped with an internal speaker that some of the software features use to send an audible alert to the user. To enable this speaker, the sound card in your instrument must be turned off. With the sound card off, you will not have access to standard Windows audio features, such as the ability to listen to a music CD.

If you turn the sound card on, the internal speaker is disabled. You will need to connect headphones or an amplified speaker to the headphone jack on the instrument to hear the alerts.

NOTE. The default setting disables the sound card.

Use the following procedure to turn the sound card on or off.

1. Access the Device Manager:
 - a. From the File menu, click Minimize, or press CTRL+M to minimize the instrument application.
 - b. On your Windows desktop, right-click the My Computer icon.
 - c. Click Properties.
 - d. In the System Properties dialog box, click the Hardware tab.
 - e. Click the Device Manager button.
2. Select the Source:
 - a. Double-click Sound, video, and game controllers.
 - b. Double-click SigmaTel C-Major Audio.
 - c. In the Device usage drop-down list, click either Use this device (enable) or Do not use this device (disable).
3. Save Your Changes:
 - a. Click OK.
 - b. Close the Device Manager dialog box.
 - c. Close the System Properties dialog box.

Set the mask polarity

From the Mask menu, select Pass/Fail Setup.

Overview. Use the Mask Polarity control to select whether to test the positive or negative pulse or both.



To use.

- Click Positive to set the pulse polarity to positive.
- Click Negative to set the pulse polarity to negative.
- Click Both to set the pulse polarity to both negative and positive.

Behavior. When the Positive control is selected, the mask test is performed on the positive pulse. When the Negative control is selected, the mask test is performed on the negative pulse.

When the Both control is selected, the mask test is performed on both the positive and negative pulses.

NOTE. The mask polarity controls operate for pulse mask testing only; they have no affect on eye masks.

What do you want to do next?

[Learn about test notification.](#)

[Learn about waveform parameters.](#)

[Learn about test results.](#)

[Go to the Test Setup control window.](#)

Set mask test repeat controls

From the Mask menu, select Pass/Fail Setup.

Overview. Use the Pass/Fail Test controls to start the test or to run the test continuously.



To use.

- Click the On/Off button to start the test.
- Click the Repeat button to run the test continuously.
- Click the Controls button to open the Mask Test control window.

Behavior. When the Repeat control is on, the test runs continuously. When you click the On/Off button, the test starts using the parameters from the Mask Test control window and the Pass/Fail Results window is displayed.

What do you want to do next?

[Learn about waveform parameters.](#)

[Learn about test notification.](#)

[Learn about mask polarity.](#)

[Learn about the Mask Test Controls window.](#)

[Go to the Test Setup control window.](#)

Fail results setup

Mask testing control window (Pass-Fail results tab)

From the Mask menu, select Pass/Fail Results.

Overview. Use this control window to view real time test results, start the test, reset the test at the beginning, activate the waveform failure log file, and open the Mask Test Controls control window.

For information on the controls, click the buttons.

- [Test Summary](#)
- [Hits Per Segment](#)
- [Pass / Fail Test](#)
- [Controls](#)

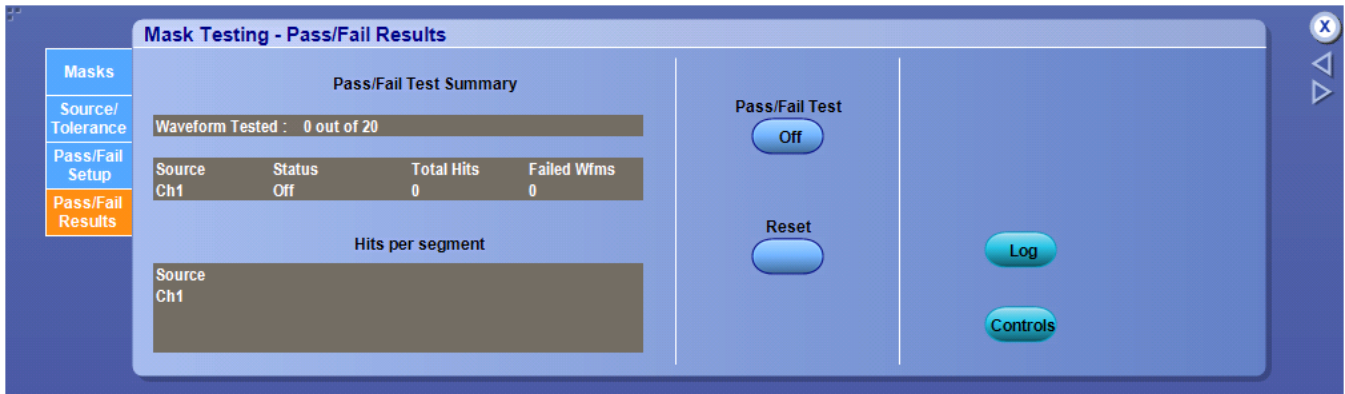

What do you want to do next?

[Learn about test summary.](#)

[Learn about hits per segment.](#)

[Learn about the Mask Test Controls window.](#)

[Go to the Test Setup control window.](#)

View the mask test summary

From the Mask menu, select Pass/Fail Results.

Overview. Use this window to view real time test results.

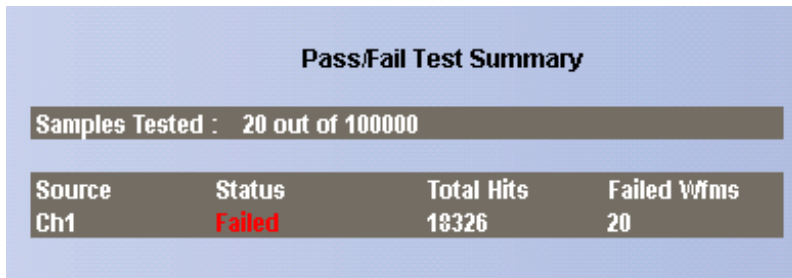

To use. The Pass/Fail Test Summary is a read only field.

Behavior. The Pass/Fail Test Summary fields provide a real time summary of the test results. Waveforms or samples tested shows how many waveforms or samples have been tested in relation to how many were specified in the test setup.

- Source indicates what signal source was used for the test.
- Status indicates whether the test has passed, failed, or is passing.

Passing appears in yellow, passed in green, and failed in red.

- Total Hits shows the total number of data points that violated the mask.
- Failed Wfms shows the total number of waveforms that failed during the test sequence.

What do you want to do next?

[Learn about hits per segment.](#)

[Learn about the Mask Test Controls window.](#)

[Learn about test results.](#)

View the mask hits per segment

From the Mask menu, select Pass/Fail Results.

Overview. Use this window to view the hits for each mask segment of the test.



| Source | Seg1 | Seg2 | Seg3 |
|--------|-------|------|------|
| Ch1 | 10136 | 3140 | 0 |

To use. The Hits per segment is a read only field.

Behavior. Each mask test can have up to 16 segments. The data point violations per segment are shown in this window. Source indicates the input signal in use for the test. The segments are identified by Seg followed by the number of the segment. Only the number of segments used in a test is shown. A scroll bar appears if there are more segments used than can be seen at one time.

The segments of a mask are the polygonal regions on the screen. Segment one is the left upper most polygon. Segments are assigned from top to bottom and left to right on the screen.

What do you want to do next?

[Learn about test summary.](#)

[Learn about the Mask Test Controls window.](#)

[Learn about test results](#)

Start or reset a mask test

From the Mask menu, select Pass/Fail Results.

Overview. Use these controls to start a test or reset the test to the starting point.

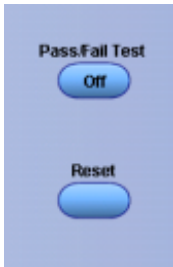

To use.

- Click the On/Off control to start the test.
- Click the Reset control to reset the test to the beginning.

Behavior. When the test starts, it uses the parameters in the Pass/Fail Test Setup control window. When the test is reset, the Total Hits, Failed Wfms, Hits per segment, and Waveform Tested fields are reset to zero.

What do you want to do next?

[Learn about test summary.](#)

[Learn about hits per segment.](#)

[Learn about the Mask Test Controls window.](#)

[Learn about test results.](#)

User mask setup

Set the user mask controls

From the Mask menu, select Mask Setup; then open the Masks tab and click the User Mask button.

Overview. Use this control window to access the Edit User Mask control window or to copy a standard mask as a user mask. You can also select the standard you want to copy or edit from the standard drop-down list.

NOTE. The Comm Trigger is designed to work with communications mask and standard testing. Mask testing automatically uses Communication triggers. You must install the Serial Communications Mask Testing Option on some instruments before you can access the Comm triggers.

For information on the controls, click the buttons.

- [Type](#)
- [Edit User Mask](#)
- [Display](#)
- [Autoset](#)
- [Autofit](#)

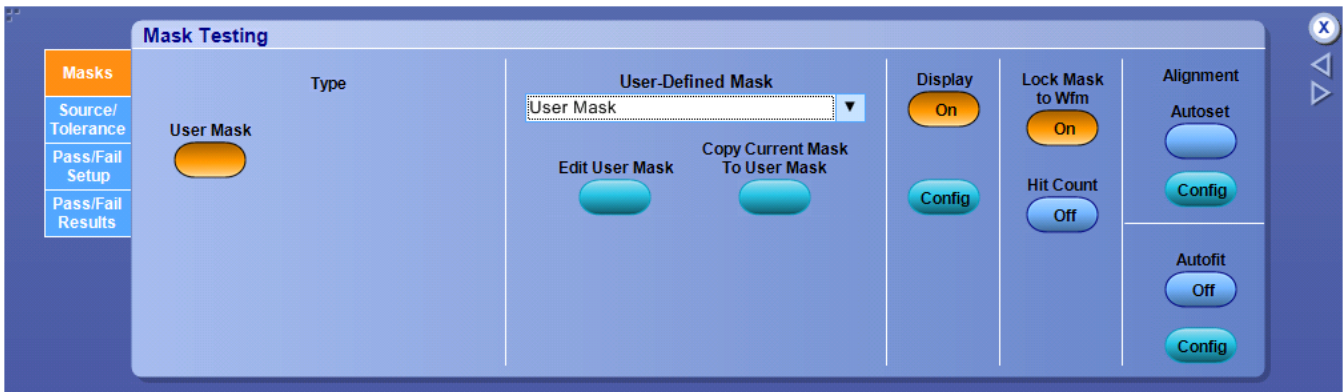

To use.

- Click the Edit User Mask button to access the Mask Edit control window.
- Click the Copy Current Mask button To User Mask to make the current mask a user mask.

Behavior. Clicking the User Mask button gives you access to the User Mask in the standard drop-down list. Clicking the Edit User Mask control will replace this control window with the Mask Edit control window. Clicking the Copy Current Mask to User Mask control will activate a dialog box where you can overwrite the user mask.

What do you want to do next?

[Learn about editing masks.](#)

[Learn more about mask types.](#)

[Learn more about mask setups.](#)

Set user mask edit controls

From the Mask menu, select Mask Edit Controls.

Overview. Use this control window to select the segment and vertex for editing and set the Vertical and Horizontal Mask Values.



To use.

- Click the up and down arrows to select the segment or the vertex of the mask to be edited.
- Click the Add button to add a point to the boundary in the selected segment and just after the selected vertex.
- Click Del button to delete the selected vertex from the selected segment.
- To change the horizontal or vertical values for the selected segment and vertex, click in the Horizontal or Vertical entry boxes to activate the multipurpose knobs to enter a value.

Behavior. The Segment up and down arrows increase or decrease the segment number by one. The Vertex up and down arrows increase or decrease the vertex by 10. To set a specific number click the Vertex entry box to activate the pop-up calculator. Clicking the Add control adds a point to the boundary in the selected segment and just after the selected vertex in addition to moving any points that follow up one. Clicking Del deletes the selected vertex from the selected segment and moves any points that follow down one.

What do you want to do next?

[Learn about saving masks.](#)

[Learn about recalling saved masks.](#)

[Learn more about mask types.](#)

[Learn more about mask setups.](#)

Recall user mask

From the File menu, select Recall, or from the [Reference Waveform controls](#), click the Recall button.

Overview. Use this dialog box to recall a saved user mask.

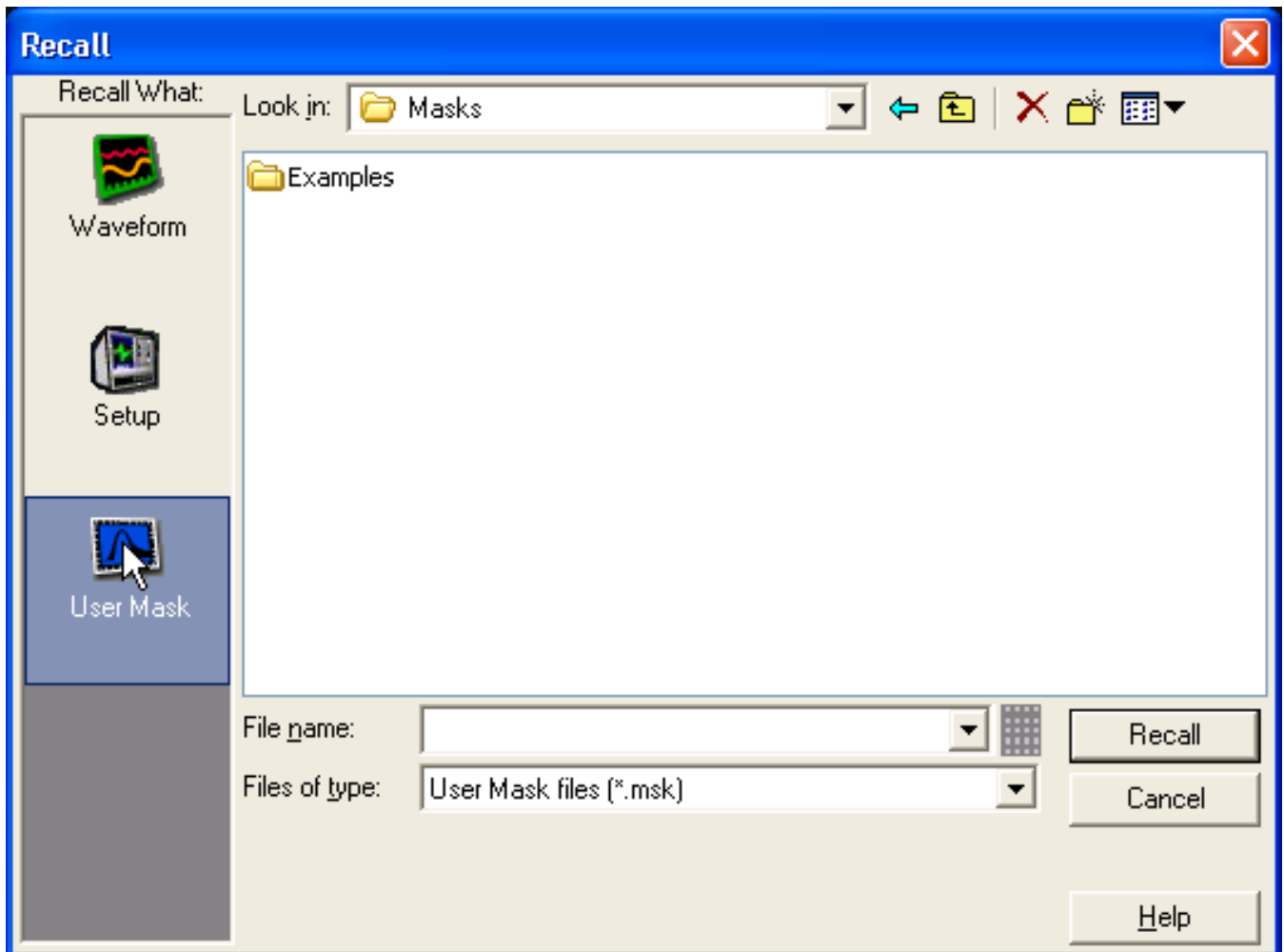

To use.

- Under Recall What, click User Mask.
- In the Look in drop-down list box, navigate to the location of the user mask.
- Click on the name of the mask file you want to recall. You can also click the keyboard icon to access the pop-up keyboard and enter the file name.
- Click Recall.

Behavior. The Recall dialog box displays when you click Recall in the Mask Edit control window. Clicking Recall replaces the current mask with the mask that you selected in the Recall dialog box.

Masks are saved in C:\Users\[Username]\Tektronix\TekScope\Masks unless you choose another directory.

What do you want to do next?

[Learn about saving masks.](#)

[Learn more about mask types.](#)

[Learn more about mask setups.](#)

Limit test

Set up limit testing

From the Mask menu, select Limit Test Setup; then open the Setup tab.

Overview. Limit testing allows you to compare an active signal to a template waveform.

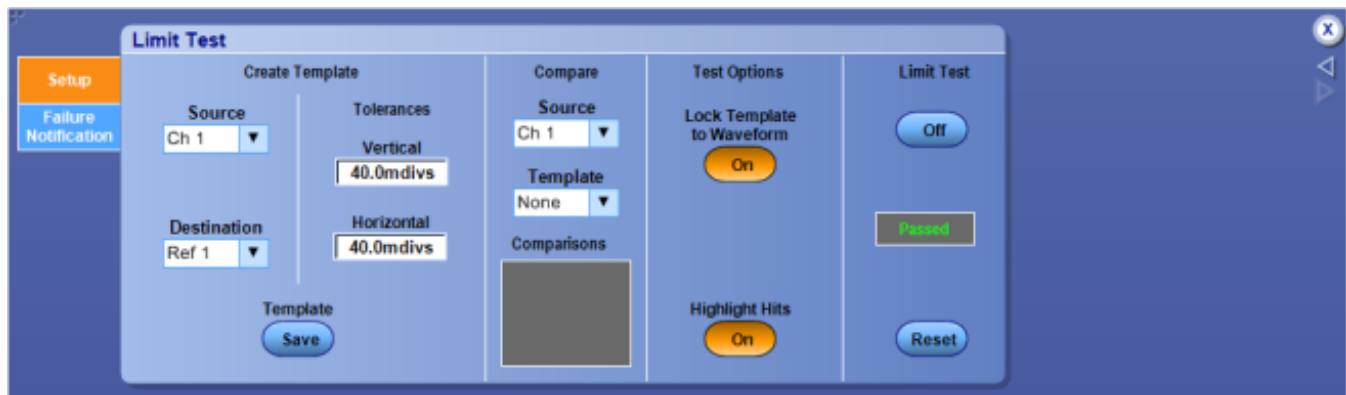

To use. Use the following procedure to build a template from a known signal and compare it to an active signal.

1. Create a template:
 - a. Select the signal Source and template Destination in the drop-down list boxes.
 - b. Click in the Vertical and Horizontal Tolerances entry boxes and use the multipurpose knobs to specify the test limit tolerances. The Tolerances specify the margins allowed before a limit test fails.
 - c. Click Save to save the template as a reference waveform or save to a file. You can create and save multiple templates.
1. Compare a source waveform to a template:
 - a. In the Source drop-down list box, select the source waveform to compare to a template.
 - b. In the Template drop-down list box, select the template to compare to the source waveform. Normally, this is the template you created in the steps above, but you can compare multiple waveforms to multiple templates at the same time.
2. Failure Notification:
 - a. Open the Failure Notification tab and set up the mode you prefer for failure notification.
 - b. Click the Setup tab to return to the Limit Test setup window.
3. Select Test Options:
 - a. Click the Lock Template to Waveform button On to lock the vertical scale or position of the template to the source waveform.
 - b. Click the Highlight Hits button On to show points on the waveform that fall outside the template. These will occur in a different color.
4. Run Limit Test:
 - a. Click the Limit Test button On to start the test.
 - b. Click the Reset button to clear all violations in preparation for another test.



TIP. Use the Average acquisition mode to create a smoother template waveform; use the Envelope acquisition mode to create a template that allows occasional overshoots.

NOTE. Limit testing is not available on digital channels.

Limit testing is not available on DPO70000SX instruments in multiscope mode.

Save a template

From the Mask menu, select Limit Test Setup. In the Destination drop-down list, select File to open the Save Template dialog box. From the dialog box, click the Save button.

Overview. Use this dialog box to save the limit test template to a specified file.

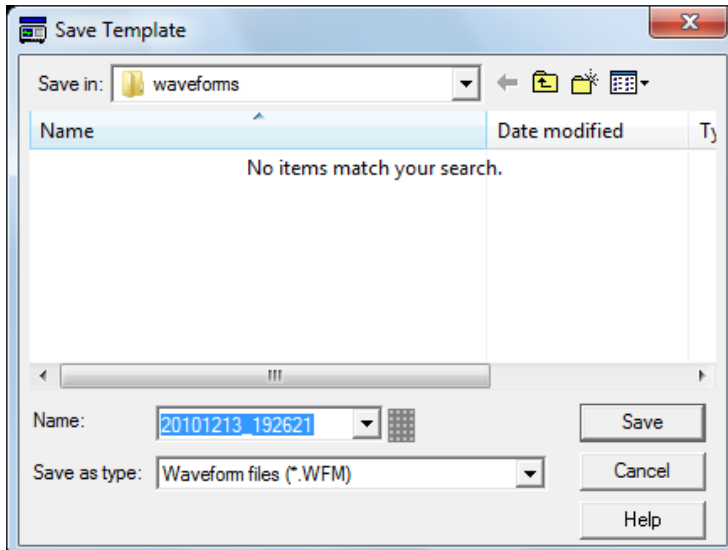

To use.

- To save to a file, enter a Name or use the default file name. The file extension specified in the Save as type list will automatically be appended to the file name.

Behavior. This dialog box opens when you select File from the Limit Test Setup control window. The default file type is a waveform (.WFM).

The default folder is C:\Users\[Username]\Tektronix\TekScope\waveforms.

NOTE. Any characters that you enter in the file name box become part of the file name. The instrument does not use any user-defined file extensions.

Set up limit test failure notification

From the Mask menu, select Limit Test Setup; then open the Failure Notification tab.

Overview. Use the Limit Test controls to set the mode of failure notification when a mask limit test fails.



To use. Click a button to switch the control on or off. Use the controls to indicate the failure notification method, if a waveform fails a mask limit test.

Behavior.

- **Beep.** When Beep is On, the instrument beeps if a mask test fails.
- **E-mail.** When E-mail is On, the instrument sends an E-mail if a mask test fails. Click the Setup button and complete the [E-mail on Event Setup](#) setup information.
- **Save WFM.** When Save WFM is On, failed waveform data is saved to a file. Click the Path button and enter a location to save the file.
- **Log Date.** When Log Date is On, the date and time for each failed mask test is recorded to a file. Click the Path button and enter a location to save the file.
- **Print.** When Print is On, the instrument sends the waveform to a printer if a mask test fails.
- **SRQ.** When SRQ is On, the instrument sends a GPIB SRQ command if a mask test fails.

Math setups

Set up a math waveform

From the Math menu, select Math Setup.

Overview

Use the Math Setup control window to *set up and define math waveforms*.

NOTE. Math calculations are not available on digital channels.

This document is for more than one instrument. Your instrument, or instrument setup, may not include some of these features.

For information on the controls, click the buttons.

- [Display & Vertical Control](#)
- [Logic Properties](#)
- [Predefined Functions](#)
- [Editor](#)
- [Custom Analysis Functions](#)
- [MATLAB Analysis](#)
- [Basic Spectral](#)
- [Advanced Spectral](#)

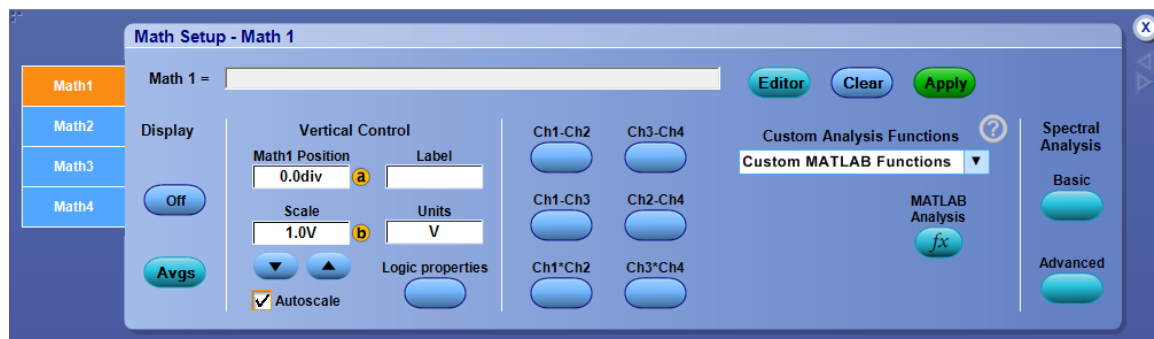

You can define up to four math waveforms. The controls for each waveform are similar, but independent of each other.



TIP. To easily change the vertical position and scale of a math waveform, click the waveform handle on the left side of the screen. Use the multipurpose knobs to change the waveform position and scale.



TIP. To open the Math Equation Editor, double-click in the math expression field or click the Editor button.

What do you want to do next?

[Learn about the Math Waveform controls.](#)

[Learn about the Equation Editor.](#)

Set up math averaging

From the Math menu, select Set Math Averages.

Overview

Use this control window to specify the number of times the selected *math waveform* is averaged.

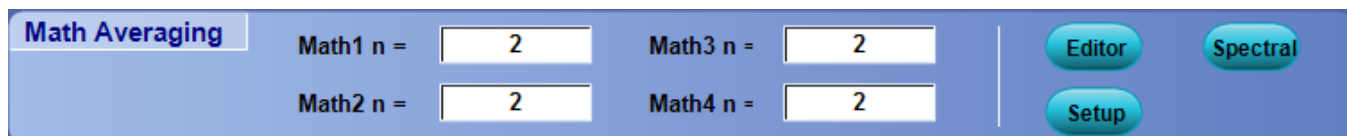

To use

1. Click in a Math <1–4> n = entry box to map it to one of the multipurpose knobs.
2. Use the multipurpose knob to specify the number of times the selected waveform should be averaged.

Behavior

The selected math waveform is averaged over the number of acquisitions shown in the control. Each math waveform has its own set of controls.

The following buttons allow you to change other setups after you set the averaging:

- Click Editor to open the Math Equation Editor control window.
- Click Spectral to open the Spectral Setup control window.
- Click Setup to open the Math Setup control window.

What do you want to do next?

[Learn about the Spectral Setup controls.](#)

[Learn more about the Math Setup controls.](#)

Set math variables

From the Math menu, select Set Math Variables.

Overview

Use this control window to quickly set the math variables to use in your math expression.

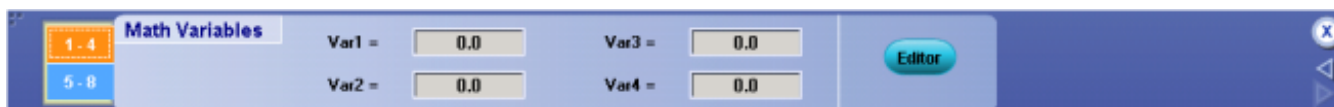

To use

- Use the 1 – 4 or 5 – 8 tabs to access the variables you want.
- Click in a Var <1–4> = or Var <5–8> = entry box and use the multipurpose knobs to set the value for the variable.
- Click the Editor button to access the Math Equation Editor.

Behavior

You can set or change the variable values in this control window. To add a variable to a math expression, go to the math editor, and click the VAR <1–8> buttons.

What do you want to do next?

[Learn about the Edit controls.](#)

Custom analysis functions

This window provides information on MATLAB and .NET plugin functions you can use in math equations.

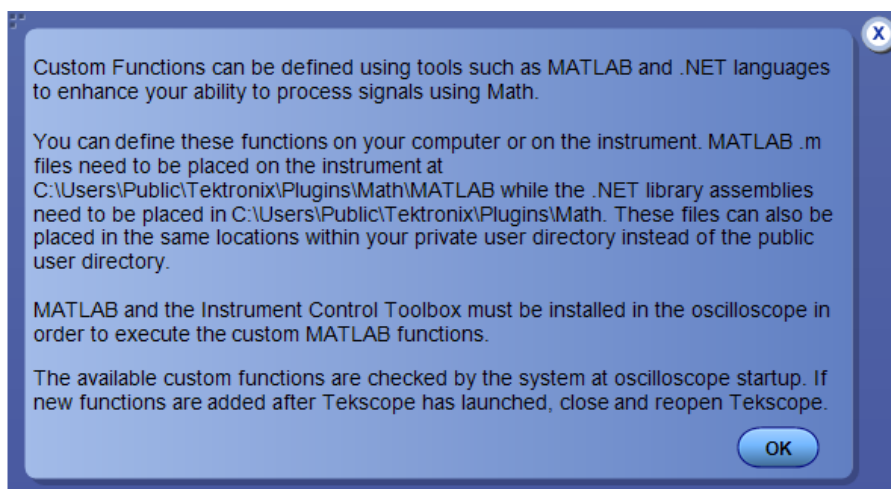

What do you want to do next?

[Learn about using Math Plugins](#)

[Learn about writing Math Plugins](#)

[Learn about writing MATLAB custom function plugins](#)

Use custom analysis functions

From the Math menu, select Math Setup.

To use

1. Select a custom function from the Custom Analysis Functions drop-down list.

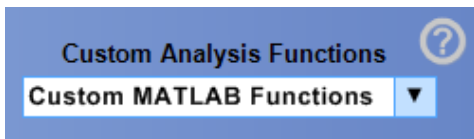

Behavior

Custom functions are math functions that you have created and installed on the instrument. Once installed you can select and use them just like the instrument built in functions.

Click the question mark to display information on custom analysis function plugins. [Custom analysis functions](#).

What do you want to do next?

[Learn about using Math Plugins](#)

[Learn about writing Math Plugins](#)

[Learn about writing MATLAB custom function plugins](#)

MATLAB custom analysis interface

This window provides information on MATLAB plugin functions you can use in math equations.

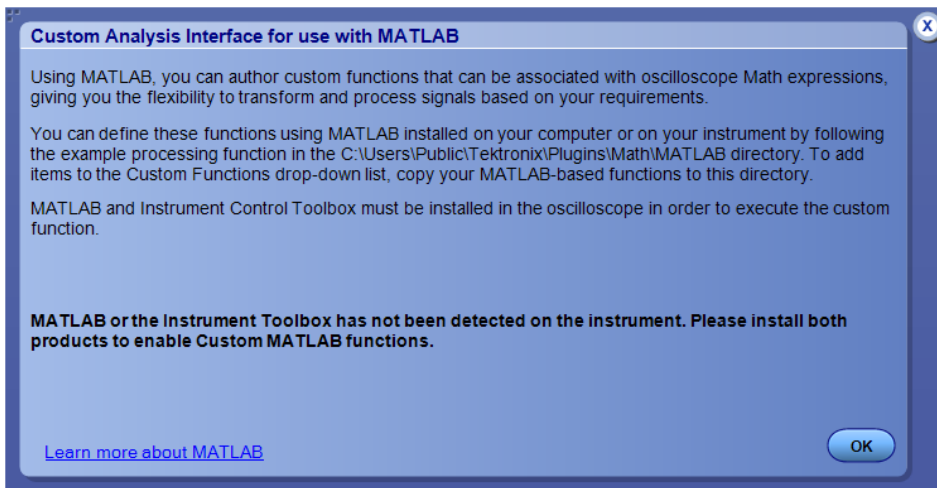

Behavior

Clicking on the link takes you to the MathWorks Web site.

Use the drop down list to select a MATLAB plugin to insert in your math equation. If MATLAB or the instrument toolbox is not installed, the drop down list is replaced with a instructions to install MATLAB and the toolbox.

What do you want to do next?

[Learn about using Math Plugins](#)

[Learn about writing Math Plugins](#)

[Learn about writing MATLAB custom function plugins](#)

Basic spectral setups

Set up basic spectral analysis

From the Math menu, select Basic Spectral, or click Basic in the Math Setup control window.

Overview. Use these controls to for simple spectral analysis.

To use. For information on the controls, click the buttons.

- [Source](#)
- [Editor](#)
- [?](#)
- [Vertical Controls](#)

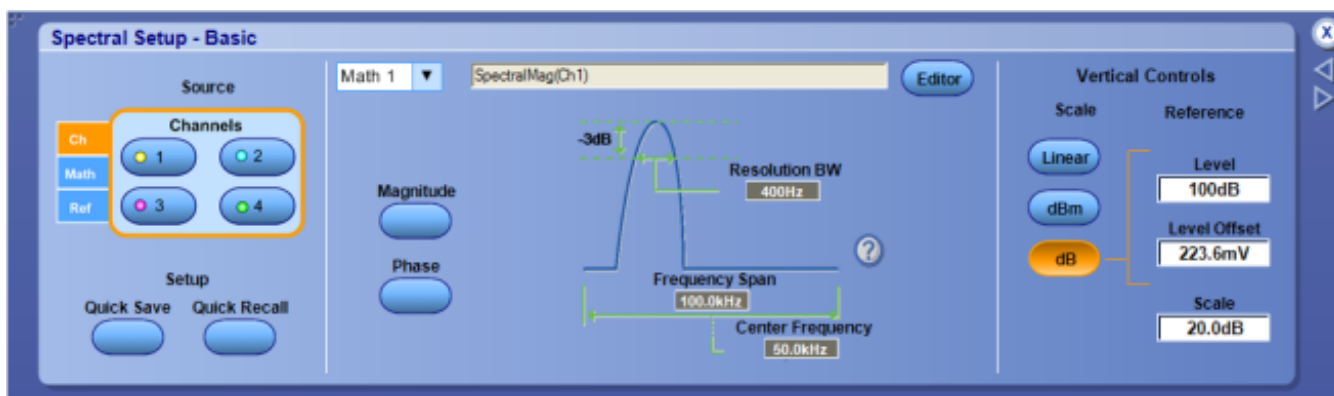

Changing the Horizontal Mode to Manual activates the Frequency Span and Resolution BW controls.

Use front panel spectral controls

From the Math menu, select Basic or Advanced Spectral; in the Spectral Setup window, click the ? mark.

Not available on DPO5000 and DPO70000SX Series instruments.

To use. To map the spectral controls to the instrument front panel, do the following:

1. From the Horz/Acq menu, select Horizontal/Acquisition Setup.
2. Open the Horizontal tab.
3. Under Mode, click the Manual option box.
4. Return to the Spectral Setup control window.
5. Use the front panel Resolution knob to directly control Frequency Span.
6. Use the Horizontal Scale knob to directly control Resolution Bandwidth.

Advanced spectral setups

Set up advanced spectral analysis

From the Math menu, select Advanced Spectral, or click Advanced in the Math Setup control window.

Overview. Use the controls in this window to set up advanced math waveforms for spectral analysis. Using the tabs, you can create a spectral waveform, define the vertical units, and adjust the measurement parameters. You can also lock waveforms together.

To use. For information on the controls, click the buttons.

- [Create / Edit](#)
- [Vert Axis](#)
- [Tracking](#)
- [Home < - > Apply](#)
- [Editor](#)
- [Frequency](#)
- [?](#)
- [Gating](#)

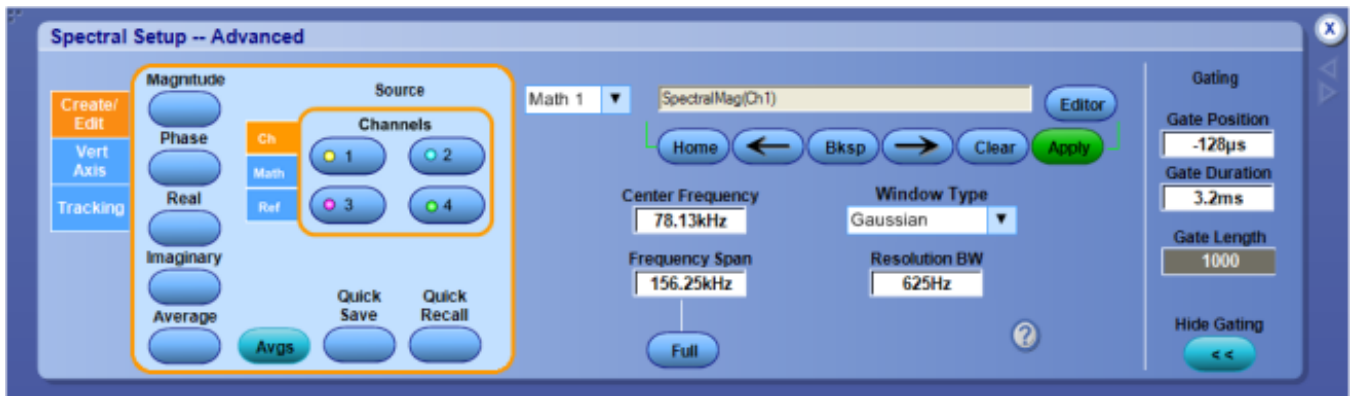

After you create the spectral waveform, use the controls on the right side of the control window to position and adjust the waveform so that you can view the data you are interested in.

You can operate the instrument and view spectral (FFT) waveforms using the time-domain controls, gating controls, or frequency domain controls. Some of these controls are interactive; making changes with one set of controls will sometimes change settings in another control set.

What do you want to do next?

[Learn about creating spectral waveforms.](#)

[Learn about the Math Setup controls.](#)

Set up the frequency spectral controls

From the Math menu, select Advanced Spectral, or click Advanced in the Math Setup control window.

To use.

- Click in an entry box, and then use the multipurpose knobs to set the Center Freq , Freq Span, and Res BW.
- Click Full to set the frequency span to full.



Behavior. The maximum frequency span is equal to half of the sample rate. If you need a higher frequency span, set the sample rate to a larger value.

The Resolution Bandwidth determines how small of a frequency difference can be resolved in the frequency domain output data. It defines the bandwidth of filters used to perform the frequency domain analysis. The resolution bandwidth is measured in hertz at the 3 dB points on each side of the peak spectral lobe. Adjusting the resolution bandwidth controls the gate duration to obtain the desired resolution bandwidth.

NOTE. *The frequency domain controls interact with the gating and acquisition controls; changing one set of controls may change the other control settings.*

What do you want to do next?

[Learn about the Gating controls.](#)

[Learn about the Math Setup controls.](#)

Center frequency

The center frequency is the frequency at the center of the frequency span. The maximum center frequency is equal to the sample rate divided by two (the Nyquist frequency) minus one half the span. The minimum center frequency is equal to one half of the span.

If the frequency span is set to maximum, then the center frequency will not move. To increase the center frequency beyond the present limits, either reduce the frequency span or increase the sample rate. To decrease the center frequency beyond the present limits, reduce the frequency span.

Frequency span

The frequency span is the range of frequencies over which the spectral analysis is performed. The maximum span is from DC to one half of the sample rate (the Nyquist frequency). A smaller frequency span allows a greater range of center-frequency adjustment. If a larger frequency span is desired, increase the sample rate.

Resolution bandwidth

The resolution bandwidth controls the bandwidth of the spectral analyzer filters. You can adjust the resolution bandwidth in units of hertz. The resolution bandwidth is measured at the -3 dB points on each side of the peak spectral lobe of the filter.

Resolution bandwidth is inversely proportional to the gate duration in the time domain. Changing the gate duration changes the resolution bandwidth. Changing the spectral analyzer window function also changes the resolution bandwidth but will not affect the gate duration.

To decrease the resolution bandwidth beyond the present limits, increase the time domain gate duration. If this is insufficient, increase the record length and then increase the gate duration again. You can also try the rectangular or Hamming window to maximize the frequency resolution (minimize resolution bandwidth).

Set up spectral gating controls

From the Math menu, select Advanced Spectral, or click Advanced in the Math Setup control window.

To use.

1. Select an FFT window type from the Window Type list.

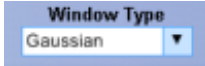

2. Click in the Gate Position, Gate Duration, or Gate Length entry boxes and use the multipurpose knobs to set the gating parameters.

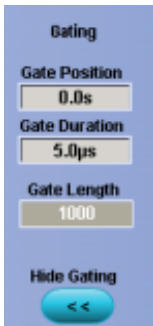

Behavior. An *FFT Window Type* can help reduce spectral noise for many types of signals. Some windows provide better frequency resolution at the expense of better amplitude measurements. Other windows provide better amplitude accuracy over frequency resolution. The choice of window also affects the resolution bandwidth.

- Gate Position moves the gate that selects the data for the spectral waveform. The gate position is the center point in the gate measured in seconds with respect to the trigger point. In most cases the phase reference point is located at the center of the gated data. However, if you use a Tek Exponential window, the phase reference point is at the 20% point of the gated data.
- Gate Duration sets the gate time duration in seconds. The default gate duration is the duration of the entire waveform record. The resolution bandwidth is inversely proportional to the gate duration.
- Gate Length displays the gate length in points. The default gate duration is the duration of the entire waveform record.

NOTE. *The gating controls interact with the acquisition and frequency domain controls; changing one set of controls may change the other control settings.*

What do you want to do next?

[Learn about selecting an FFT window.](#)

[Learn about the Math Setup controls.](#)

[Learn about the Frequency controls.](#)

Using spectral analysis

Spectral analysis overview

You can use math waveforms to perform FFT (Fast Fourier Transform) measurements with the instrument. The FFT process mathematically converts the standard time-domain signal (repetitive or single-shot acquisition) into its frequency components, providing spectral analysis capabilities.

The ability to quickly look at signal frequency components and spectrum shape is a powerful research and analysis tool. FFT is an excellent troubleshooting aid for the following:

- Testing the impulse response of filters and systems
- Measuring harmonic content and distortion in systems
- Identifying and locating noise and interference sources
- Analyzing vibration
- Analyzing harmonics in 50 and 60 Hz power lines
- [Continue](#)

Spectral analysis features

You can display an FFT waveform on any actively acquired signal (periodic or single-shot), the last acquired signal, or any signal stored in reference memory.

FFT windows. The instrument allows you to match the optimum window to the signal you are analyzing.

- The Rectangular window is best for nonperiodic events such as transients, pulses, and single-sequence acquisitions.
- The Hamming, Hanning, and Blackman-Harris windows are better for periodic signals.
- The Kaiser Bessel window has less spectral leakage than the Hanning, Hamming, or Rectangular windows.
- The Gaussian window provides optimal localization in both the time and frequency domain.
- The FlatTop2 window is good for high accuracy magnitude measurements for signals that do not require narrow resolution bandwidth.
- The Tek Exponential window is useful for impulse response testing.

Vertical scales. The FFT vertical graticule can be set to either dB or Linear RMS.

- A dB scale is useful when the frequency component magnitudes cover a wide dynamic range, letting you show both lesser and greater magnitude frequency components on the same display.
- A Linear scale is useful when the frequency component magnitudes are all close in value, enabling direct comparison of their magnitudes.

Spectral and Time-Domain displays. Time signals and FFT waveforms can be shown together on the display. The time signal highlights the problem; the FFT waveform helps you determine the cause of the problem.

- [Continue](#)
- [Previous](#)

FFT process

The FFT process mathematically converts the standard time-domain signal (repetitive or single-shot acquisition) into its frequency components.

The FFT function processes the waveform record and displays the FFT frequency domain record, which contains the input signal frequency components from DC (0 Hz) to $\frac{1}{2}$ the sample frequency (also called the Nyquist frequency).

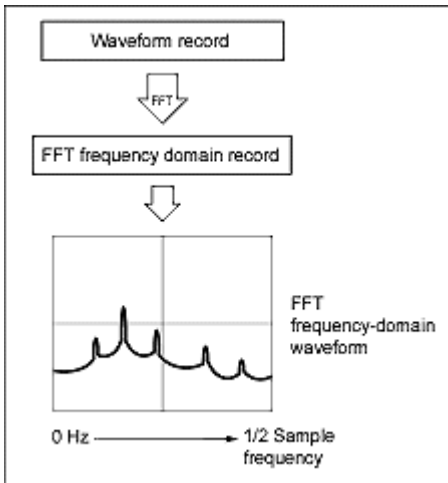

Nyquist frequency

The highest frequency that any digital oscilloscope can measure without errors is one-half of the sample rate. This frequency is called the Nyquist frequency.

The FFT waveform displays the input signal frequency components from DC (0 Hz) to the Nyquist frequency or frequency.

- [Continue](#)
- [Previous](#)

The FFT display

The following illustration shows a typical time-domain waveform and the frequency components of that signal as part of the math FFT waveform.

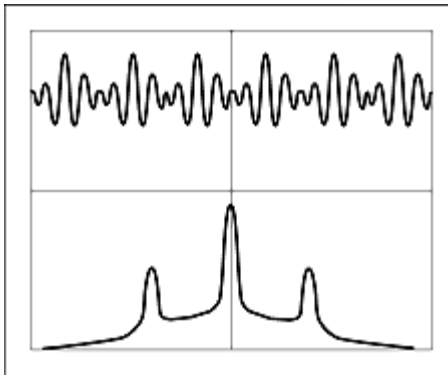

- [Continue](#)
- [Previous](#)

FFT windows

The FFT process assumes that the part of the waveform record used for FFT analysis represents a repeating waveform that starts and ends at or near the same voltage of a cycle. In other words, it is an integer number of cycles. When a waveform starts and ends at the same amplitude, there are no artificial discontinuities in the signal shape, and both the frequency and amplitude information is accurate.

A nonintegral number of cycles in the waveform record causes the waveform start and end points to be at different amplitudes. The transitions between the start and end points cause discontinuities in the waveform that introduce high-frequency transients. These transients add false frequency information to the frequency domain record.

Applying a window function to the waveform record changes the waveform so that the start and stop values are close to each other, reducing the discontinuities. This results in an FFT measurement that more accurately reflects the actual signal frequency components. The shape of the window determines how well it resolves frequency or magnitude information.

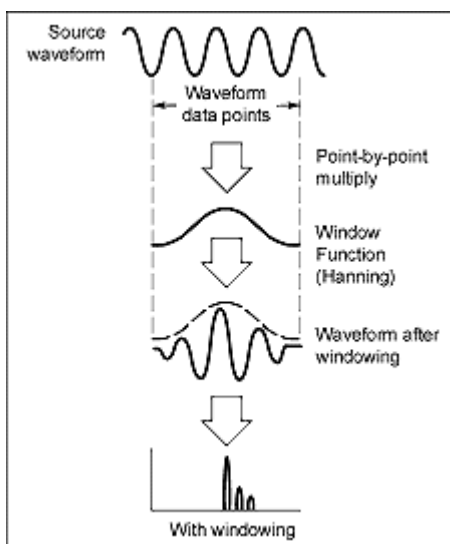
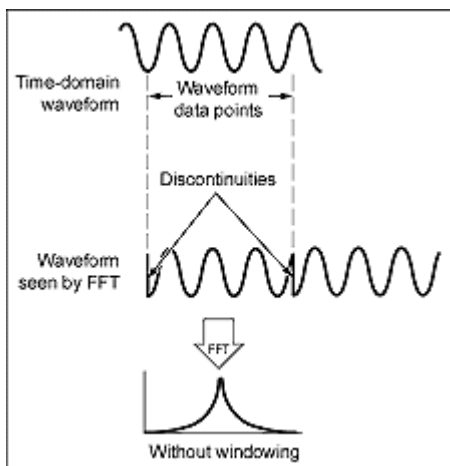

- [Continue](#)
- [Previous](#)

FFT window characteristics

Each FFT window is a trade-off between frequency resolution and magnitude accuracy. What you want to measure and your source signal characteristics help determine which window to use. Use the following guidelines to select the best window.

| FFT window | Characteristics | Best for measuring |
|------------------|--|---|
| Rectangular | Best frequency, worst magnitude resolution. This is essentially the same as no window. | Transients or bursts where the signal levels before and after the event are nearly equal. Equal-amplitude sine waves with frequencies that are very close. |
| Hamming, Hanning | Better frequency, poorer magnitude accuracy than Rectangular. Hamming has slightly better frequency resolution than Hanning. | Sine, periodic, and narrow-band random noise. Transients or bursts where the signal levels before and after the event are significantly different. |
| Blackman-Harris | Best magnitude, worst frequency resolution. | Predominantly single frequency signals to look for higher order harmonics. |

You can also determine the best window empirically by first selecting the Rectangular window, and then selecting (in the following order) the Hamming, Hanning, and Blackman-Harris windows until the frequency components merge. Use the window just prior to where the frequencies emerge for the best compromise between resolution and amplitude accuracy.

- [Continue](#)
- [Previous](#)

Time domain gating

You can use time domain gating to select a specific segment of your signal for spectral analysis. Two controls, gate position and gate duration, determine the location and size of the gate.

The resulting spectrum corresponds to the frequency components of the signal in the gated segment.

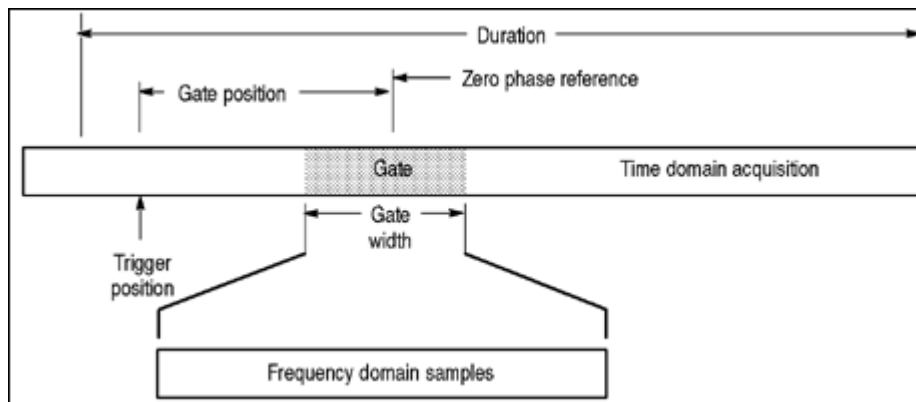

Time domain gating is inversely proportional to the resolution bandwidth of the spectral waveform. The narrower the gate, the larger the resolution bandwidth and the lower the frequency resolution. To obtain the best frequency resolution, use as wide a gate as possible.

- [Continue](#)
- [Previous](#)

Aliasing

Problems occur when the instrument acquires a signal containing frequency components that are higher in frequency than the *Nyquist frequency*. The frequency components that are above the Nyquist frequency are under sampled and appear to "fold back" around the Nyquist frequency, showing as lower frequency components. These incorrect components are called aliases.

To quickly check for aliasing, slowly decrease the horizontal time scale. If the shape of the displayed waveform changes drastically or becomes stable, your waveform is probably aliased. You can also check for aliasing by turning on peak detect acquisition mode. To remove aliasing, modify the record length.

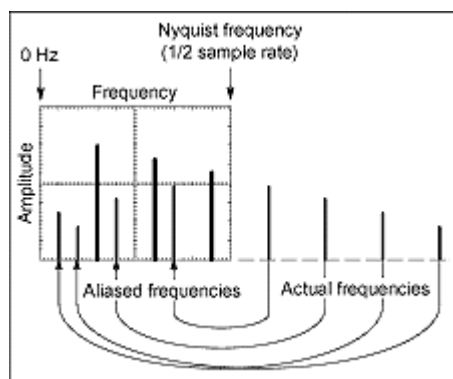

- [Continue](#)
- [Previous](#)

Eliminate aliasing

Use the following methods to eliminate aliases:

- Increase the sample rate by adjusting the horizontal scale to a faster time-per-division setting. Since you increase the *Nyquist frequency* as you increase the time per division, the aliased frequency components should appear at their proper frequency. If the increased number of frequency components shown on the screen makes it difficult to measure individual components, use MultiView Zoom to magnify the FFT waveform.
- Use a filter on the source signal to limit the bandwidth of the signal to frequencies below that of the Nyquist frequency. If the frequency components that you want to view are below the built-in bandwidth settings, set the source channel bandwidth to the appropriate value.
- Push the Autoset button.
- [Switch the acquisition to Envelope mode or Peak Detect mode](#). Envelope mode searches for samples with the highest and lowest values over multiple acquisitions and can detect faster signal components over time. In Peak Detect mode, the acquisition alternates between saving the highest sample in one acquisition interval and lowest sample in the next acquisition interval.
- [Beginning of Overview](#)
- [Previous](#)

Math equation editor

Math equation editor control window

From the Math menu, select Equation Editor, or click the Editor button in the Math Setup or Spectral Setup control windows.

Overview. Use the Math Equation Editor control window to define or edit math waveforms. The readout shows the math expression as you construct it. New functions are added at the beginning of the expression each time you click one of the function buttons.

To use. For information on the controls, click the buttons.

- [Display](#)
- [Time](#)
- [Spectral](#)
- [Var](#)
- [Meas](#)
- [Filter](#)
- [Home < - > End](#)
- [Channels](#)
- [Operands](#)
- [Syntax](#)



Behavior. You can create a math expression using one or more of the following approaches:

- Open the tabs and click one or more of the buttons to insert functions into the math expression. Then select one of the waveforms as an operand by clicking one of the [Channels Selector](#). Use the edit controls to add additional numbers and operators to complete the math expression.
- Connect an external keyboard and use it to enter the math expression.
- Create a math expression using an external text editor or another application. Copy the text to the Windows clipboard. Right-click with the mouse to paste the text into the math expression.

If you create a math expression that is longer than the physical space in the control window readout, you can scroll through the expression using the [Text Edit controls](#).

To edit another math waveform, select the waveform from the Math (n) drop-down list in the Equation Editor control window.

To open a [Math Averaging](#) control window, where you can specify the number of times the math waveform is to be averaged, click Avgs.

Click Apply to apply the math expression to the selected waveform.

For additional information on creating math waveforms, see [Guidelines for Working with Math Waveforms](#).

What do you want to do next?

[Learn about the Math Setup controls.](#)

[Learn about using math functions with math waveforms.](#)

Math equation editor (Time tab)

From the Math menu, select Equation Editor; then open the Time tab.

To use. Click a control to insert time domain functions into the math expression.

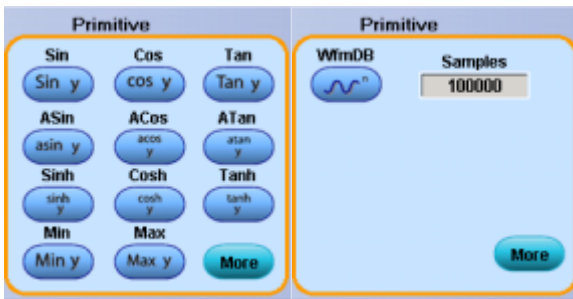
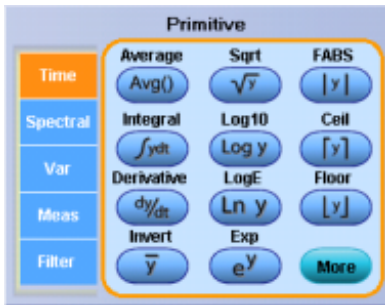

1. Click one of the Primitive buttons to insert a Time function into the math expression.

| Primitive buttons | | | | | |
|-------------------|--------|-------|------|------|-------|
| Average | Sqrt | FABS | Sin | Cos | Tan |
| Integral | Log 10 | Ceil | ASin | ACos | ATan |
| Derivative | Log e | Floor | Sinh | Cosh | Tanh |
| Invert | Exp | | Min | Max | WfmDB |

2. Click More to add additional functions.

Behavior. You can use any of the channels as arguments for the function. You can also create nested functions by inserting one function into the argument portion of another.

Consider the following when working with math waveforms:

- Scale and position the source waveform so it is contained on-screen; off-screen waveforms may be clipped, resulting in errors in the math waveform.
- Use the vertical position and vertical offset to position the source waveform. The vertical position will not affect the math waveform unless you position the source waveform off screen so that it is clipped.

What do you want to do next?

[Learn about the Spectral Setup controls.](#)

[Learn about using the measurement list with math waveforms.](#)

Absolute value

Inserts the text `FABS(` into the math expression. The FABS function takes the absolute value of the expression.

Arc sine

Inserts the text `ASIN(` into the math expression.

Arc cosine

Inserts the text `ACOS(` into the math expression.

Arc tangent

Inserts the text `ATAN(` into the math expression.

Average

Inserts the text `AVG(` into the math expression. Enter an argument to the function. The average function produces the average of the argument.

Base 10 logarithm

Inserts the text `LOG(` into the math expression. Enter an argument to the function. The log function produces the base 10 logarithm of the argument.

Cosine

Inserts the text `COS(` into the math expression.

Derivative

Inserts the text `DIFF(` into the math expression. Enter an argument to the function. The derivative function produces the derivative of the argument.

Hyperbolic sine

Inserts the text `SINH(` into the math expression.

Hyperbolic cosine

Inserts the text `COSH(` into the math expression.

Hyperbolic tangent

Inserts the text `TANH(` into the math expression.

Integral

Inserts the text `INTG(` into the math expression. Enter an argument to the function. The integral function produces the integral of the argument.

Invert

Inserts the text INV(into the math expression. Enter an argument to the function. The invert function inverts the argument within the parentheses.

Largest integer

Inserts the text FLOOR(into the math expression. The FLOOR function takes the largest integer < the expression.

Maximum value

Inserts the text MAX(into the math expression. The MAX function accumulates over time the maximum value at each point in the vector.

Minimum value

Inserts the text MIN(into the math expression. The MIN function accumulates over time the minimum value at each point in the vector.

Natural antilog

1. Inserts the text EXP(into the math expression.
2. Enter an argument to the function.

The natural antilog function raises e to the power of the argument.

Natural logarithm

1. Inserts the text LN(into the math expression.
2. Enter an argument to the function.

The LN function produces the natural logarithm of the argument.

Sine

Inserts the text SIN(into the math expression.

Smallest integer

Inserts the text CEIL(into the math expression. The CEIL function takes the largest integer > the expression.

Square root

Inserts the text SQRT(into the math expression. Enter an argument to the function. The square root function produces the square root of the argument.

Tangent

Inserts the text TAN(into the math expression.

WfmDB

Inserts the text WFMDB(into the math expression. The WfmDB features accumulates sampling information into a data base.

Math equation editor (Spectral tab)

From the Math menu, select Equation Editor; then open the Spectral tab.

To use. Click a control to insert spectral analysis functions into the math expression.

1. Click one of the Predefined Functions to insert a Spectral function into the math expression.

| Spectral functions | | | |
|--------------------|------|-------|-----------|
| Mag | Real | Phase | Imaginary |

2. Select one of the defined waveforms as an argument using the [Channels Selector](#).

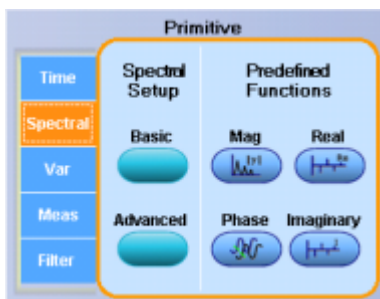

Behavior. You can use any of the channels as arguments for the function. Create nested functions by inserting a function into the argument portion of another.

What do you want to do next?

[Learn about the Spectral Setup controls.](#)

[Learn about using math functions with math waveforms.](#)

[Learn about using the Measurement list with math waveforms.](#)

Magnitude

Inserts the text SpectralMag(into the math expression. Select one of the waveforms as an argument to the function. This function creates an FFT magnitude waveform.

Real number

Inserts the text SpectralReal(into the math expression. Select one of the waveforms as an argument to the function. This function creates a waveform that displays only the real part of the FFT.

Phase

This timing measurement is the amount of time that one waveform leads or lags another waveform. The measurement is expressed in degrees where 360° comprise one waveform cycle.

Imaginary number

Inserts the text SpectralImag(into the math expression. Select one of the waveforms as an argument to the function. This function creates a waveform that displays only the imaginary part of the FFT.

Math equation editor (Var tab)

From the Math menu, select Equation Editor; then open the Var tab.

To use.

1. Click in a Var <1-8> = entry box and use the multipurpose knobs to enter a value for the variable.
2. Click More to add additional variables
3. Click the associated button to enter that variable into the math expression.
4. Click Controls to access the [Math Variables](#) control window.

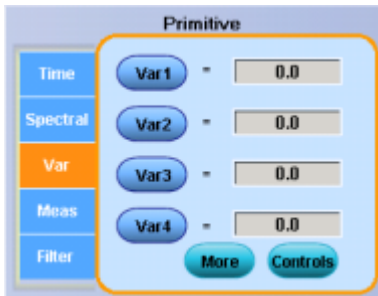

Behavior. You can assign up to eight different variables to add to your math expression.

- Clicking a Var <1-8> button enters the variable into the math expression.
- Clicking the More button accesses the other four variables.
- The Controls button activates the Math Variables control window where you can quickly set or change the math variables.

What do you want to do next?

[Learn about the Edit controls.](#)

[Learn about the Math Variable controls.](#)

Math equation editor (Meas tab)

From the Math menu, select Equation Editor; then open the Meas tab.

To use.

1. Use the list to enter one of the predefined measurements into the math expression.
2. Click the button adjacent to an item to insert the measurement into the expression.



Behavior. The list contains the measurements defined in the Measurement control window. The buttons are only active for defined measurements; they are unavailable for any undefined measurements.

Measurements are continuously updated on live acquisitions. The most recent measurement values are always used in math expressions.

What do you want to do next?

[Learn about the Edit controls.](#)

Math equation editor (Filter tab)

From the Math menu, select Equation Editor; then open the Filter tab.

To use. Use these controls to insert spectral analysis-based functions into the math expression.

1. In the Math Equation Editor control window, click a Load button.
2. In the Open dialog box, navigate to the location of the filter you want to load. You will find a selection of available *Math Arbitrary Filters* in C:/TekScope/Math Arbitrary Filters, or browse to the location of any custom filters.
3. Select the filter you want to use; then click Open.
4. Click the corresponding Fit <1–8> button (that you used to load the filter) to insert its function into the math expression.
5. You can select one of the defined waveforms as an argument using the *Channels Selector*.
6. Edit the math expression using the Operands and edit controls if needed.
7. When you finish building the expression, click Apply.

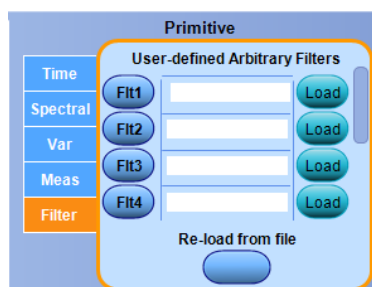

Behavior. You can use any of the channels as arguments for the function. Create nested functions by inserting a function into the argument portion of another.

What do you want to do next?

[Learn about the Spectral Setup controls.](#)

[Learn about using math functions with math waveforms.](#)

[Learn about using the Measurement list with math waveforms.](#)

Measurement setups

Measurement snapshot control window

From the Measure menu, select Measurement Snapshot.

Overview

Measurement Snapshot lists all of the automated measurements that are available for a selected waveform.

| Measurement Snapshot on Ch 2 | | | |
|------------------------------|----------|------------|----------|
| Period | 998.8µs | Freq | 1.0kHz |
| Pos Width | 496.56µs | Neg Width | 502.24µs |
| Burst Wld | 3.01ms | | |
| Rise Time | 251.69µs | Fall Time | 251.45µs |
| + Duty Cyc | 49.72% | - Duty Cyc | 50.28% |
| +Overshoot | 4.73% | -Overshoot | 5.41% |
| Max | 2.61V | High | 2.38V |
| Min | -2.61V | Low | -2.35V |
| Amplitude | 4.74V | Pk-Pk | 5.22V |
| Mean | 11.57mV | Cycle Mean | 11.37mV |
| RMS | 1.76V | Cycle RMS | 1.76V |
| Area | 46.28µVs | Cyc Area | 11.35µVs |

Measurement Context

| | |
|----------------|----------------|
| Base, Top Form | Histogram Mode |
| High Ref | 90.0% |
| Mid Ref | 50.0% |
| Low Ref | 10.0% |

Snapshot Type

General Comm Setup

Refresh

To use

1. Select the waveform for which you want to take a snapshot.
2. Click the Snapshot button in the Measurement control window, or select Snapshot from the Measure menu.
3. Click either General or Comm in the Snapshot Type group box to begin the snapshot.

Behavior

When the instrument has completed all of the measurements, the snapshot window is updated with the measurements.

Measurement Snapshot executes all of the single waveform measurements once; the measurements are not continuously updated. Any measurements previously taken are retained on the display until you complete a new snapshot. To take another snapshot, click the Refresh button.

NOTE. Automatic measurements are not available on digital channels.



TIP. Before taking a snapshot, be sure to properly display the waveform. Measurement Snapshot does not warn you if a waveform is improperly scaled (for example, clipped, low signal amplitude, low resolution, and so on).

To change the source for taking a snapshot, select another channel, math, or reference memory waveform and then execute snapshot again.



TIP. For information on measurement algorithms, refer to the *Automatic Measurement Algorithms and Methods for High-Performance Communications Applications* application note, [85w_15763.pdf](#). This application note is available from the www.tektronix.com Web site.

What do you want to do next?

[Return to the Measurement control window overview.](#)

Measurement setup control window (Amplitude tab)

From the Measure menu, select Measurement Setup; then open the Ampl tab.

Overview

Use this control window to set up the instrument for taking automatic amplitude measurements.

To use

For information on the controls, click the buttons.

- [Measurements](#)
- [Channel](#)
- [Measure | Source](#)
- [Ref Levels](#)
- [Gating](#)
- [Statistics](#)
- [Snapshot](#)
- [Histogram](#)

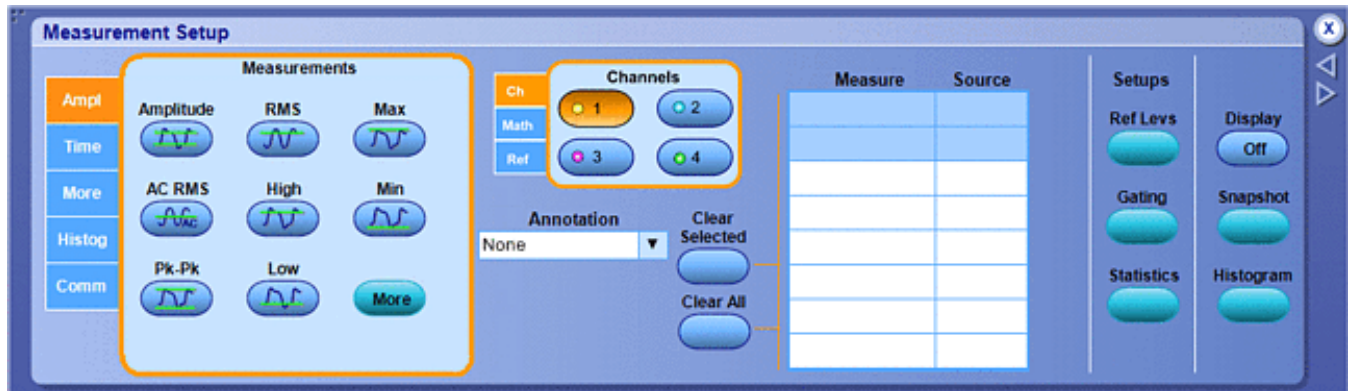

Behavior

From this control window, you can do the following:

- Define amplitude measurements for the selected waveforms.
- Select a waveform source using the [Channels Selector](#). You can measure live waveforms, math waveforms, or reference waveforms.
- Create a list of measurements to appear in the main graticule or in a separate measurement window.
- Define the unique reference levels for each measurement.
- Use gating to limit the measurements to a specific area of the waveform.
- Set up measurement statistics.
- Set up histograms to evaluate specific regions of the waveform.



TIP. Turn on *Fast Acquisitions* to enhance your measurements. In *Fast Acquisitions* mode, measurements are calculated on an array of acquired waveforms.

If three or more channels are displayed, *Fast Acquisitions* mode is turned off, and then the requested measurements are made. *Fast Acquisitions* mode is not automatically turned back on when you select fewer than three channels.

NOTE. Some measurements are less accurate using *Fast Acquisitions* mode, for example, timing measurements. Automatic measurements are not available on digital channels.

What do you want to do next?

[Go to a step-by-step procedure to set up the instrument for taking measurements.](#)

[Learn about taking automatic phase measurements.](#)

[Learn about taking amplitude measurements.](#)

[Learn about taking timing measurements.](#)

[Learn about taking histogram measurements.](#)

[Learn about communications measurements.](#)

[Learn more about the Measurements list](#)

[Learn more about the Measurement controls.](#)

Measurement readouts





An Info (information) column in the measurement readout area displays icons that indicate the status of each measurement. When an error icon displays, the instrument also displays an error code.

For a list of instrument error codes, messages, and definitions, refer to the Programmer guide available on the product software DVD or from www.tektronix.com/manuals.

The next table shows some of the icons with examples of their meaning.



TIP. If you hover the mouse pointer over the displayed icon, the instrument displays more specific information on the measurement status.

| Icon | Meaning example |
|---|---|
|  | The instrument is in the process of acquiring data and calculating the measurement. |
|  | The instrument encountered an error. |
|  | The instrument cannot locate the specified edge of the signal. |
|  | The instrument cannot measure a waveform that is “clipped” on the screen. |
|  | The instrument cannot locate the specified signal. |

Null waveform data that is seen during measurements is usually seen when using ET mode, when the instrument is still filling the waveform record. Warnings appear in the measurement readouts because of ET mode, but eventually go away once the waveform record fills in. Filters can also cause null waveform data, and measurements on the resulting math waveforms result in warnings.

Select an amplitude measurement

From the Measure menu, select Measurement Setup; then open the Ampl tab.

To use

Use the Ampl tab to select automatic amplitude measurements.

1. Select a source with the [Channels Selector](#).
2. Click a Measurements button to add an Amplitude measurement to the Measure list:

| Measurement buttons | | |
|---------------------|-----------|------------|
| Amplitude | Low | +Ovrshoot |
| AC RMS | Max | -Ovrshoot |
| Pk-Pk | Min | Mean |
| RMS | Cycle RMS | Cycle Mean |
| High | | |

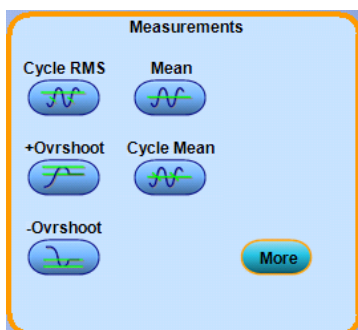
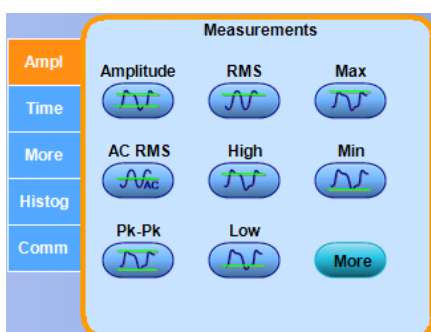

3. Click Display On in the upper-right corner of the [Measurement Setup Control Window](#) to turn the measurement display on and off.

Behavior

Measurements are updated approximately three times a second, or less for long record lengths. Measurements are calculated after each acquisition. You can display up to eight automatic measurements.



TIP. Select the individual measurements directly from the Measure menu Amplitude submenu.

What do you want to do next?

[Learn about taking timing measurements.](#)

[Learn about taking histogram measurements.](#)

[Learn about other measurements.](#)

[Learn about communication measurements.](#)

[Learn more about the Measurements list.](#)

[Learn more about the Measurement controls.](#)

Amplitude

This voltage measurement is the high value minus the low value measured over the entire waveform or gated region:

Amplitude = High – Low

AC RMS

This voltage measurement is the true Root Mean Square voltage over the measurement region.

Peak to Peak

This voltage measurement is the absolute difference between the maximum and minimum amplitude in the entire waveform or gated region.

RMS

This voltage measurement is the true Root Mean Square voltage over the entire waveform or gated region.

High

The high level measurement is the value used as 100% whenever high reference, mid reference, or low reference values are needed, such as in fall time or rise time measurements. This value can be calculated using either the min/max or histogram method. The min/max method uses the maximum value found. The histogram method uses the most common value found above the midpoint. This value is measured over the entire waveform or gated region.

Low

The low level measurement is the value used as 0% whenever high reference, mid reference, or low reference values are needed, such as in fall time or rise time measurements.

This value can be calculated using either the min/max or histogram method. The min/max method uses the minimum value found. The histogram method uses the most common value found below the midpoint. This value is measured over the entire waveform or gated region.

Maximum

This voltage measurement is the maximum amplitude. It is typically the most positive peak voltage and is measured over the entire waveform or gated region.

Minimum

This voltage measurement is the minimum amplitude. It is typically the most negative peak voltage and is measured over the entire waveform or gated region.

Cycle RMS

This voltage measurement is the true Root Mean Square voltage over the first cycle in the waveform or the first cycle in the gated region.

Positive Overshoot

This voltage measurement is measured over the entire waveform or gated region.

Positive Overshoot = (Maximum – High) × Amplitude 100%

Negative Overshoot

This voltage measurement is measured over the entire waveform or gated region and is expressed as:

Negative Overshoot = (Low – Minimum) × Amplitude × 100%

Mean

This voltage measurement is the arithmetic mean over the entire waveform or gated region.

Cycle Mean

This voltage measurement is the arithmetic mean over the first cycle in the waveform or the first cycle in the gated region.

Measurement setup control window (Time tab)

From the Measure menu, select Measurement Setup; then open the Time tab.

Overview

Use this control window to set up the instrument for taking automatic time measurements.

To use

For information on the controls, click the buttons.

- [Measurements](#)
- [Channel](#)
- [Measure | Source](#)
- [Ref Levels](#)
- [Gating](#)
- [Statistics](#)
- [Snapshot](#)
- [Histogram](#)

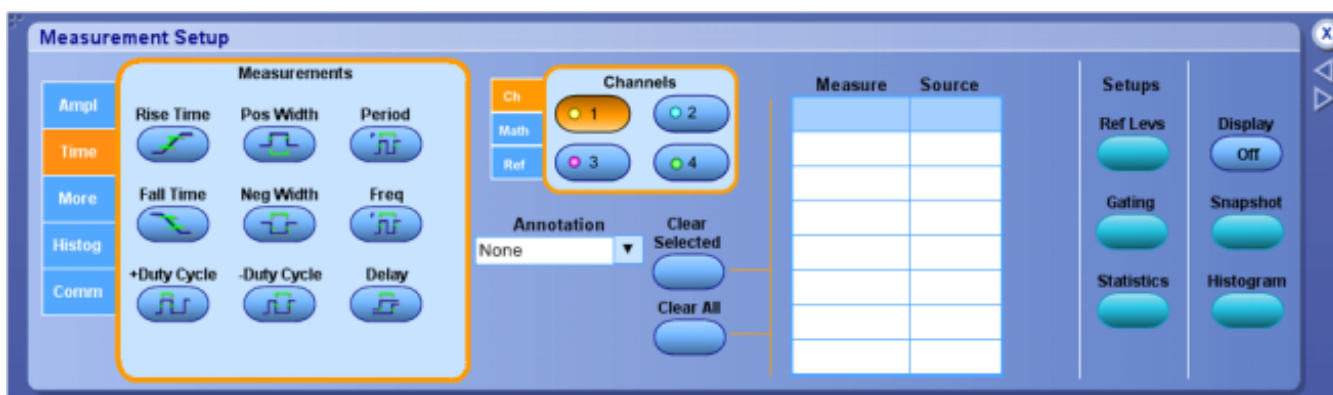

Behavior

From this control window, you can do the following:

- Define time measurements for the selected waveforms.
- Select a waveform source using the [Channels Selector](#). You can measure live waveforms, math waveforms, or reference waveforms.
- Create a list of measurements to appear in the main graticule or in a separate measurement window.
- Define the unique reference levels for each measurement.
- Use gating to limit the measurements to a specific area of the waveform.
- Set up measurement statistics.
- Set up histograms to evaluate specific regions of the waveform.

NOTE. Automatic measurements are not available on digital channels.



TIP. Turn on Fast Acquisitions to enhance your measurements. In Fast Acquisitions mode, measurements are calculated on an array of acquired waveforms. As the waveforms accumulate (with persistence on), your measurement accuracy may increase. However, only one or two channels can be displayed when you take automatic measurements using Fast Acquisitions mode.

If three or more channels are displayed, Fast Acquisitions mode is turned off, and then the requested measurements are made. Fast Acquisitions mode is not automatically turned back on when you select fewer than three channels.

What do you want to do next?

[Go to a step-by-step procedure to set up the instrument for taking measurements.](#)

Select a time measurement

Type From the Measure menu, select Measurement Setup; then open the Time tab.

To use

Use the Time tab to select automatic time measurements.

1. Select a source with the [Channels Selector](#).
2. Click a Measurements button to add a Time measurement to the Measure list:

| Time measurements | | |
|-------------------|-------------|--------|
| Rise Time | Pos Width | Period |
| Fall Time | Neg Width | Freq |
| +Duty Cycle | -Duty Cycle | Delay |

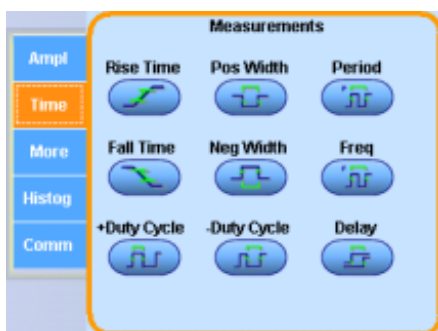

3. Click Display On in the upper-right corner of the [Measurement Setup Control Window](#) to turn the measurement display on and off.

Behavior

Measurements are updated approximately three times a second, or less for long record lengths. Measurements are calculated after each acquisition. You can display up to eight automatic measurements.

A new control window opens when you [click Delay](#). Enter the parameters for the delay measurement, and then click Ok to return to the Measurement Setup control window. The delay measurement is added to the list.



TIP. Select the individual measurements directly from the Measure menu Time submenu.

Rise Time

This timing measurement is the time required for the leading edge of the first pulse in the waveform or gated region to rise from the low reference value (default = 10%) to the high reference value (default = 90%) of the final value.

Fall Time

This timing measurement is the time required for the falling edge of the first pulse in the waveform or gated region to fall from the high reference value (default = 90%) to the low reference value (default = 10%) of the final value.

Positive Duty Cycle

This timing measurement is the ratio of the positive pulse width to the signal period expressed as a percentage.

The duty cycle is measured on the first cycle in the waveform or gated region.

Positive Duty Cycle = (Positive Width) × Period × 100%

Positive Width

This timing measurement is the distance (time) between the mid reference (default 50%) amplitude points of a positive pulse. The measurement is made on the first pulse in the waveform or gated region.

Negative Width measurement

This timing measurement is the distance (time) between the mid reference (default 50%) amplitude points of a negative pulse. The measurement is made on the first pulse in the waveform or gated region.

Negative Duty Cycle

This timing measurement is the ratio of the negative pulse width to the signal period expressed as a percentage. The duty cycle is measured on the first cycle in the waveform or gated region.

Negative Duty Cycle = (Negative Width) × Period × 100%

Period

This measurement is the time required to complete the first cycle in a waveform or gated region. Period is the reciprocal of frequency and is measured in seconds.

Frequency

This timing measurement is a measure of the first cycle in a waveform or gated region. Frequency is the reciprocal of the period; it is measured in Hertz (Hz) where one Hz is one cycle per second.

Delay

This timing measurement is the time between the mid reference (default 50%) amplitude point of two different waveforms

Measurement setup control window (Communications tab)

From the Measure menu, select Measurement Setup; then open the Comm tab.

Overview

Use this control window to set up the instrument for taking automatic communications measurements.

To use

For information on the controls, click the buttons.

- [Measurements](#)
- [Channel](#)
- [Measure | Source](#)
- [Ref Levels](#)
- [Gating](#)
- [Statistics](#)
- [Snapshot](#)
- [Histogram](#)



Behavior

From this control window, you can do the following:

- Define communications measurements for the selected waveforms.
- Select a waveform source using the [Channels Selector](#). You can measure live waveforms, math waveforms, or reference waveforms.
- Create a list of measurements to appear in the main graticule or in a separate measurement window.
- Define the unique reference levels for each measurement.
- Use gating to limit the measurements to a specific area of the waveform.
- Set up measurement statistics.
- Set up histograms to evaluate specific regions of the waveform.

NOTE. Automatic measurements are not available on digital channels.



TIP. Turn on Fast Acquisitions to enhance your measurements. In Fast Acquisitions mode, measurements are calculated on an array of acquired waveforms. As the waveforms accumulate (with persistence on), your measurement accuracy may increase. However, only one or two channels can be displayed when you take automatic measurements using Fast Acquisitions mode.

If three or more channels are displayed, Fast Acquisitions mode is turned off, and then the requested measurements are made. Fast Acquisitions mode is not automatically turned back on when you select fewer than three channels.

What do you want to do next?

[Go to a step-by-step procedure to set up the instrument for taking measurements.](#)

Select a communications measurement

From the Measure menu, select Measurement Setup; then open the Comm tab.

To use

Use the Comm tab to select automatic communications measurements.

1. Select a source with the [Channels Selector](#).
2. Click a Measurements button to add a Communications measurement to the Measure list:

| Communication measurements | | | |
|----------------------------|-----------|------------|---------------|
| Ext Ratio | Eye Width | Jitter P-P | Noise RMS |
| ExtRatio% | Crossing% | Jitter RMS | S/N Ratio |
| Ext Ratio (dB) | Eye Top | Jitter 6s | CycDistortion |
| Eye Height | Eye Base | Noise P-P | Q-Factor |

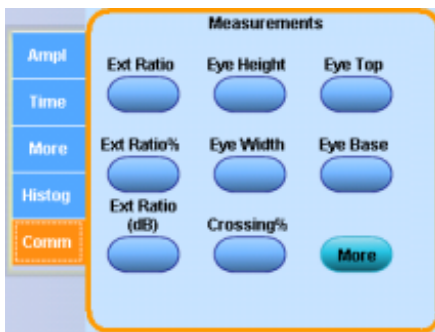

3. Click Display On in the upper-right corner of the [Measurement Setup Control Window](#) to turn the measurement display on and off.

Behavior

Measurements are updated approximately three times a second (or less for long record lengths). Measurements are calculated after each acquisition. You can display up to eight automatic measurements.



TIP. Most Comm measurements require either *WfmDB* or *FastAcq* mode.

You may need to select [Infinite Persistence display mode](#) to accumulate enough data for the Comm measurement to work.

NOTE. You can also select the individual measurements directly from the Measure menu Comm submenu.

What do you want to do next?

[Learn about taking amplitude measurements.](#)

[Learn about taking timing measurements.](#)

[Learn about other measurements.](#)

[Learn more about the measurement list.](#)

[Learn more about the measurement controls.](#)

Extinction Ratio

Extinction ratio is the ratio of eye top to base. This measurement is only valid when the acquisition mode is set to WfmDB, FastAcq is enabled, or the measurement is taken on a reference waveform saved in FastAcq mode.

$$\text{Ext Ratio} = p\text{TopMean}/p\text{BaseMean}$$

Extinction Ratio Percent

Extinction ratio percent is the ratio of eye base to top expressed as a percentage.

This measurement is only valid when the acquisition mode is set to WfmDB, FastAcq is enabled, or the measurement is taken on a reference waveform saved in FastAcq mode.

$$\text{Ext Percent} = 100 \times (p\text{TopMean}/p\text{BaseMean}).$$

Extinction Ratio Decibel

Extinction ratio decibel is the ratio of eye top to base expressed in decibels.

This measurement is only valid when the acquisition mode is set to WfmDB, FastAcq is enabled, or the measurement is taken on a reference waveform saved in FastAcq mode.

$$\text{Ext dB} = 10 \times \text{Log}(p\text{TopMean}/p\text{BaseMean})$$

Eye Height

Eye height is the measurement of the eye height in volts.

$$\text{Eye Height} = (p\text{TopMean} - 3 \times p\text{TopSigma}) - (p\text{BaseMean} + 3 \times p\text{BaseSigma})$$

Eye Width

Eye width is the measurement of eye width in seconds.

$$\text{Eye Width} = (t\text{Cross2Mean} - 3 \times p\text{TopSigma}) - (t\text{Cross1Mean} + t\text{Cross1Sigma})$$

Crossing Percent

Crossing percent measurement is the eye crossing point expressed as a percentage of eye height.

$$\text{Crossing Percent} = 100 \times [(p\text{Cross1Mean} - p\text{BaseMean}) / (p\text{TopMean} - p\text{BaseMean})]$$

Eye Top

Eye Top is the top value used in the extinction ratio measurements.

$$\text{Eye Top} = p\text{TopMean}$$

Eye Base

Eye Base is the base value used in the extinction ratio measurements.

$$\text{Eye Base} = p\text{BaseMean}$$

Jitter Peak-to-Peak

Jitter p-p is the peak-to-peak value for the edge jitter in the current horizontal units.

$$\text{Jitter PP} = T\text{Cross1PP}$$

Jitter Root Mean Square

Jitter RMS is the RMS value of the edge jitter in the current horizontal units.

$$\text{Jitter RMS} = T\text{Cross 1sigma}$$

Jitter 6 Sigma

Jitter 6 sigma is six times the RMS value of the edge jitter in the current horizontal units.

$$\text{Jitter 6 sigma} = 6 \times (\text{JitterRMS})$$

Noise Peak-to-Peak

Noise p-p is the peak-to-peak value of the noise of the top or base of the signal as specified by you.

To ensure accurate noise values, be sure to set the signal type to Eye when measuring an Eye signal.

$$\text{Noise Pk-Pk} = \text{PToppk-pk or PBBasepk-pk}$$

Noise Root Mean Square

Noise RMS is the RMS value of the noise of the top or base of the signal as specified by you.

To ensure accurate noise values, be sure to set the signal type to Eye when measuring an Eye signal.

$$\text{Noise RMS} = \text{PTopsigma or PBasesigma}$$

Signal to Noise Ratio

S/N ratio is the ratio of the signal amplitude to the noise of the top or base of the signal as specified by you.

$$\text{S/N Ratio} = (\text{Ptop} - \text{Pbase}) / (\text{PTopsigma or PBasesigma})$$

Duty Cycle Distortion

Duty cycle distortion is the peak-to-peak time variation of the first eye crossing measured at the MidRef as a percent of the eye period.

$$\text{DCD(sec)} = 100\% \times \text{TDCDp-p} / (\text{TCross2mean} - \text{TCross1mean})$$

Quality Factor

Quality factor is the ratio of eye size to noise.

$$\text{Quality Factor} = (\text{PTopmean} - \text{PBasemean}) / (\text{PTopsigma} + \text{PBasesigma})$$

Measurement setup control window (More tab)

From the Measure menu, select Measurement Setup; then open the More tab.

Overview

Use this control window to set up the instrument for taking miscellaneous measurements.

To use

For information on the controls, click the buttons.

- [Measurements](#)
- [Channel](#)
- [Measure | Source](#)
- [Ref Levels](#)
- [Gating](#)
- [Statistics](#)
- [Snapshot](#)
- [Histogram](#)

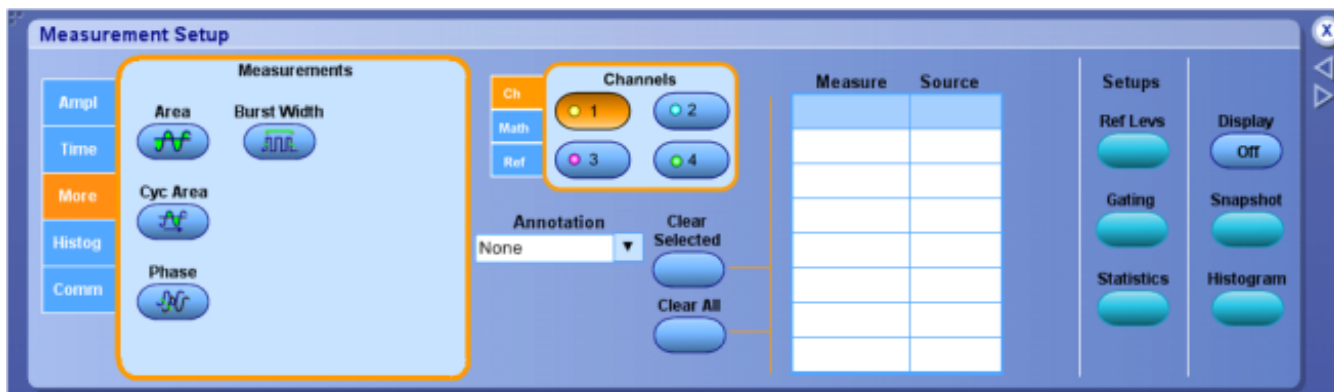

Behavior

From this control window, you can do the following:

- Define miscellaneous measurements for the selected waveforms.
- Select a waveform source using the [Channels Selector](#). You can measure live waveforms, math waveforms, or reference waveforms.
- Create a list of measurements to appear in the main graticule or in a separate measurement window.
- Define the unique reference levels for each measurement.
- Use gating to limit the measurements to a specific area of the waveform.
- Set up measurement statistics.
- Set up histograms to evaluate specific regions of the waveform.

NOTE. Automatic measurements are not available on digital channels.



TIP. Turn on Fast Acquisitions to enhance your measurements. In Fast Acquisitions mode, measurements are calculated on an array of acquired waveforms. As the waveforms accumulate (with persistence on), your measurement accuracy may increase. However, only one or two channels can be displayed when you take automatic measurements using Fast Acquisitions mode.

If three or more channels are displayed, Fast Acquisitions mode is turned off, and then the requested measurements are made. Fast Acquisitions mode is not automatically turned back on when you select fewer than three channels.

What do you want to do next?

[Go to a step-by-step procedure to set up the instrument for taking measurements.](#)

Select a miscellaneous measurement

From the Measure menu, select Measurement Setup; then open the More tab.

To use

Use the More tab to select measurements not found under any of the other measurement tabs.

1. Select a source with the [Channels Selector](#).
2. Click a Measurements button to add a More measurement to the Measure list:

| More measurements | |
|-------------------|-------------|
| Area | Cyc Area |
| Phase | Burst Width |

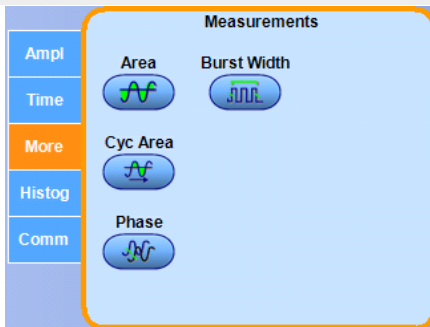

3. Click Display On in the upper-right corner of the [Measurement Setup Control Window](#) to turn the measurement display on and off.

Behavior

Measurements are updated approximately three times a second, or less for long record lengths. Measurements are calculated after each acquisition. You can display up to eight automatic measurements.

A new control window opens when you click Phase. Enter the parameters for the phase measurement, and then click Ok to return to the Measurement Setup control window. The phase measurement is added to the list.



TIP. Select the individual measurements directly from the Measure menu More submenu.

What do you want to do next?

[Learn about taking automatic phase measurements.](#)

[Learn about taking amplitude measurements.](#)

[Learn about taking timing measurements.](#)

[Learn about taking histogram measurements.](#)

[Learn about communications measurements.](#)

[Learn more about the Measurements list](#)

[Learn more about the Measurement controls.](#)

Area

Area is a voltage-over-time measurement. The measurement is the area over the entire waveform or gated region expressed in volt-seconds. The area above the common reference point is positive while the area below the common reference point is negative.

Burst Width

This timing measurement is the duration of a burst (a series of transient events) and is measured over the entire waveform or gated region.

Cycle Area

The cycle area is a voltage over time measurement. The measurement is the area over the first cycle in the waveform or the first cycle in the gated region expressed in volt-seconds. The area above the common reference point is positive while the area below the common reference point is negative.

Phase

This timing measurement is the amount of time that one waveform leads or lags another waveform. The measurement is expressed in degrees where 360° comprise one waveform cycle.

Counter measurement setup

NOTE. This online help documents features and options available for several instrument models. Your instrument, or instrument setup may not have some features discussed in this online help.

From the Measure or Analyze menu, select Counter > Time or Frequency, or from the Trigger A-B Sequence or Trigger Options menu, select Counter Measurements Setup.

To use

Click the **Counter** button to toggle the counter on and off.

Click the **A-B Trigger Time Interval** button to measure time.

Click the **Trigger Source Frequency** button to measure frequency:

- Click **Show Frequency** to display the frequency in units of frequency (Hz).
- Click **Show Period** to display the measurement in units of time (seconds).

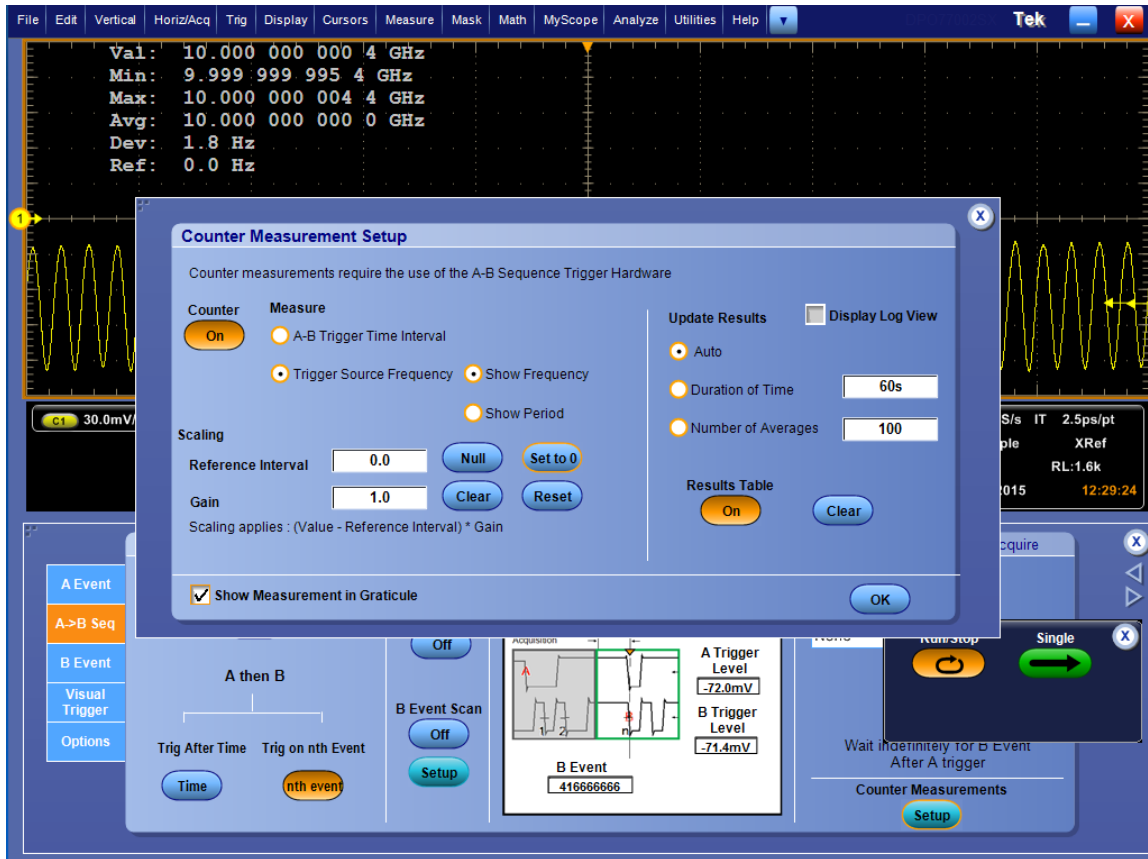

The resultant count, minimum, maximum, average, and deviation values are shown in the upper-left corner of the display.

Scaling. The measurement is scaled by subtracting the reference interval from the measurement and then multiplying the result by the gain.

- Click **Set to 0** to set the Reference Interval to 0.
- Click **Null** to copy the current count value to the Reference Interval. If the Reference Interval is not 0, the displayed count values are deltas from the Reference Interval.
- Click **Reset** to zero the displayed minimum, maximum, and average values. Their derived values restart with the next count.
- Click **Clear** to set the Gain back to 1.0.

Results table. Click the Results Table button to toggle the counter results table on and off. You can update the results table automatically, after a specified time duration, or a specified number of averages.

Trigger Source Frequency. The Trigger Source Frequency Application uses trigger hardware, rather than the acquired waveform, to measure the frequency of the signal on the trigger source to a very high precision. Best results are obtained when the External Reference is tied between the instrument and the source of the trigger signal. As a result of using the trigger hardware, the measurement update rate is very fast, 1/3 second by default. An A-Event Edge to B-Event Edge A->B Sequence is used. Statistics are derived from the measured values: Minimum, Maximum, Average (mean), and Standard Deviation. The number of measurements made so far is also included. Long record lengths are not needed for this application, because the measurements are made from the trigger hardware, not from the acquired waveform. When the reference is non-zero, the measured value and the derived statistics are shown or queried as delta values from the reference.

A-B Trigger Time Interval. The A-B Trigger Time Interval Application also uses trigger hardware to measure the time between the A-Event and the B-Event in an A-B Sequence trigger. The A- and B-Events may be any combination of trigger types: edge, glitch, width, and so on. When the reference value is non-zero, the measured value is displayed or queried as a delta from the reference.

Set up measurement statistics

From the Measure menu, highlight Statistics; then select Statistics Controls from the submenu, or click the Statistics button in the Measurement Setup window.

Overview

Use the Measurement Statistics control window to display statistical calculations on measurements. The control window contains controls that determine which statistics are displayed in the measurement window.

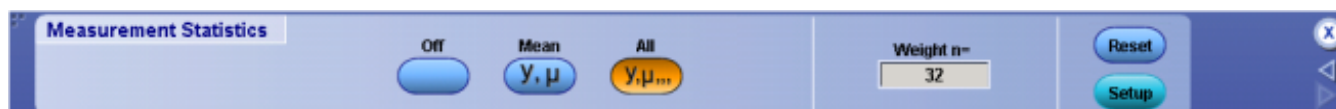

To use

- Click Off to turn the measurement statistics display off.
- Click Mean to display the value and the mean (μ) of each measurement.
- Click All to display the statistics for each measurement value.

(μ) Mean

(m) Minimum

(M) Maximum

(s) Standard Deviation

(n) Population

- Click in the Weight entry box, and then use the multipurpose knobs to set the statistics weight.
- Click Reset to restart the statistics calculations.



TIP. Select the individual statistics directly from the Measure menu Statistics submenu.

Behavior

Measurement values continue as live updates while the statistics accumulate over time. The statistics appear on the main screen when a control window is open or on the right side of the screen when no control windows are open and there are less than four measurements active. The color of the statistics match the color of the waveform from which the measurement was taken.

The statistics weight specifies the constant used to calculate the mean and standard deviation; the minimum and maximum values are unaffected by weighting. A large value produces statistics that vary less over time.

All statistics (mean, minimum, maximum, standard deviation, and population) are always gathered even though the mean may be the only statistic shown. When measurements are turned on, the acquisitions take longer because measurements and statistic calculations are done on each acquisition.

What do you want to do next?

[Return to the Measurement Setup control window overview.](#)

[Learn about setting the Reference Level controls.](#)

[Learn about using gating to specify measurement areas.](#)

Set up reference levels

From the Measure menu, select Reference Levels, or click the Ref Levs button in the Measurement Setup window.

Overview

Use the Reference Levels control window to define unique reference levels for each measurement. The default reference levels serve most general-purpose measurements. You can customize all measurements to use different reference levels.

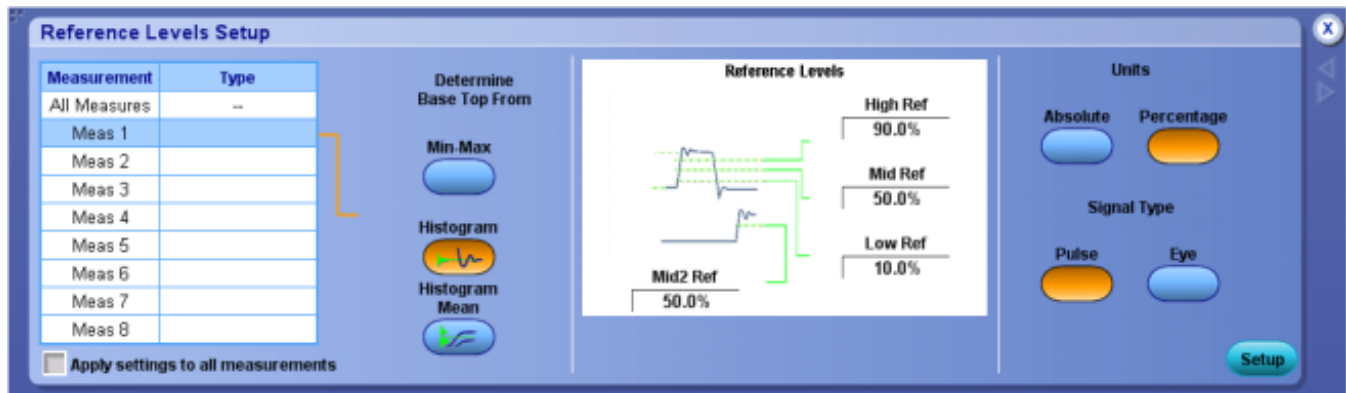

To use

- Click the Min-Max button to derive the reference levels from the minimum and maximum values of the waveform record. If you want to derive the reference levels based on statistical data, click the Histogram or the Histogram mean button.
- Refer to the graphic in the center of the control window and determine the reference levels you want to define. Click in the entry boxes associated with the desired reference level, and use the multipurpose knobs to adjust the value.
- If you want the reference levels to be measured by volts, click the Absolute button under Units. To measure the reference levels as a percentage, click the Percentage button.
- Click either Eye or Pulse to select the signal type.

Behavior

The following reference levels are included: High Reference, Low Reference, Mid Reference, and Mid2 Reference.

Define the reference levels as percentages of the signal amplitude or as absolute values in vertical units by clicking the appropriate button to define the Units selection. Use Percentage to have reference levels track the signal. Use Absolute to set the reference levels to fixed values.

The top and base levels that the measurement system derives from a waveform influence the fidelity of measurements. The measurement system can derive the reference levels from either the minimum and maximum values of the waveform or from statistical data.

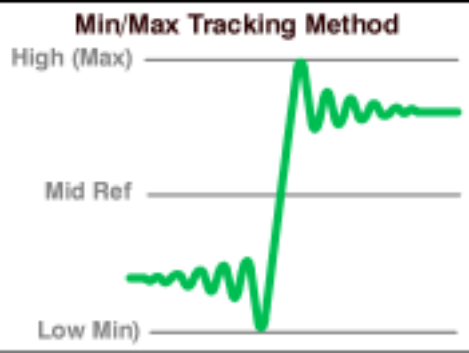
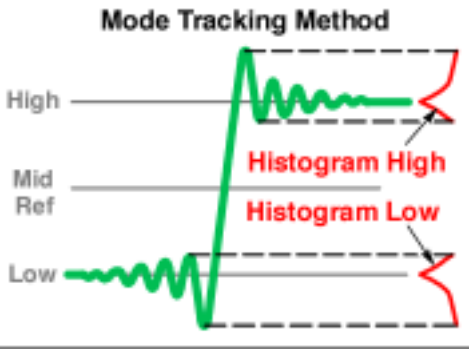
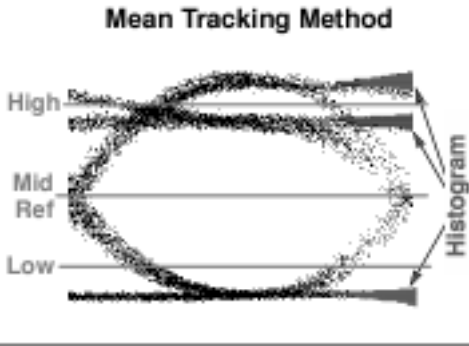
| Reference levels | |
|--|--|
| <p>Min-max uses the highest and lowest values of the waveform record. This setting is best for examining waveforms that have no large, flat portions at a common value, such as sine waves and triangle waves - almost any waveform except for pulses.</p> |  <p>The diagram shows a green waveform on a grid. Three horizontal reference lines are labeled: 'High (Max)' at the top, 'Mid Ref' in the middle, and 'Low Min)' at the bottom. The waveform's highest peak is aligned with the 'High (Max)' line, and its lowest trough is aligned with the 'Low Min)' line.</p> |
| <p>Histogram Mode sets the values statistically. Using a histogram, it selects the most common value either above or below the midpoint (depending on whether it is defining the high or low reference level). Since this statistical approach ignores short-term aberrations (overshoot, ringing, and so on), Mode is the best setting for examining pulses.</p> |  <p>The diagram shows a green waveform on a grid with reference lines for 'High', 'Mid Ref', and 'Low'. Dashed lines extend from the 'High' and 'Low' levels to the right, where they meet a red histogram. The peak of the histogram at the 'High' level is labeled 'Histogram High', and the peak at the 'Low' level is labeled 'Histogram Low'.</p> |
| <p>Histogram Mean sets the values statistically. Using a histogram, it selects the mean or average value derived using all values either above or below the midpoint (depending on whether it is defining the high or low reference level). This setting is best for examining eye patterns and optical signals.</p> |  <p>The diagram shows a dense, circular eye pattern of black dots on a grid with reference lines for 'High', 'Mid Ref', and 'Low'. A vertical histogram is shown on the right side of the pattern, with arrows pointing to the 'High', 'Mid Ref', and 'Low' levels.</p> |

Mid reference. The Mid reference defines the middle reference level of a waveform; the default level is 50%. This reference value is primarily used for making measurements between edges such as pulse widths. To change this level, click the control, and then set the level with the multipurpose knob.

Mid2 reference. The Mid2 reference defines the middle reference used on the second waveform specified in delay or phase measurements; the default level is 50%. To change this level, click the control, and then set the level with the multipurpose knob.

What do you want to do next?

[Return to the Measurement Setup control window overview.](#)

[Learn more about Measurement controls.](#)

[Learn about using Gating to specify measurement areas.](#)

[Learn about using measurement Statistics.](#)

High reference

The High Reference defines the high reference level of a waveform; the default level is 90%. This reference level is used with the Low Reference level in the calculation of rise and fall times. To change this level, click the control, and then set the level with the multipurpose knob.

Low reference

The Low Reference defines the low reference level of a waveform; the default level is 10%. This reference level is used with the High Reference level in the calculation of rise and fall times. To change this level, click the control and then, set the level with the multipurpose knob.

Set up measurement gating

From the Measure menu, highlight Gating; then select Gating from the submenu or click the Gating button in the Measurement Setup window.

Overview

Use the Gating control window to limit the measurement area of the waveform to the region bounded by the vertical bar cursors or to the left and right edges of a Zoom window.

**To use**

- To define the gating area with the vertical bar cursors, click Cursor, and then click either Indep or Tracking to select the Track Mode. These buttons are only displayed when you click Cursor.
- To define the gating area from a Zoom area, click one of the four Zoom buttons.
- To turn off measurement gating, click the Off button.
- Click Setup to return to the Measurement control window.

Behavior

Normally the instrument takes measurements over the entire waveform record. Gating lets you limit measurements to a specific portion of the waveform. You can limit gating to the region bounded by the vertical bar cursors or to the left and right edges of a Zoom area.

When you click Zoom (1–4) the Zoom window appears in the lower half of the display. Measurements are taken within the boundaries of the Zoom area. You can only take measurements on one Zoom area at a time.

When you click Cursor, measurements are taken within the boundaries of the vertical cursors. Use the multipurpose knobs to move the cursors.

When you use vertical cursors to control the gating, you can also specify the *cursor mode*. Use the independent cursor mode to move the cursors one at a time with the multipurpose knobs. Use the tracking mode to have the cursors track one another; moving Cursor 1 automatically moves Cursor 2 in tandem.



TIP. Click, hold, and drag across the part of the graticule that you want to measure. After you define the measurement area, select Measurement Gating from the shortcut menu to place gating cursors around the measurement area.

Use the same click, hold, and drag method to turn measurement gating off; just select Measurement Gating Off in the shortcut menu.

What do you want to do next?

[Return to the Measurement Setup control window overview.](#)

[Learn more about using vertical bar cursors.](#)

[Learn more about the Measurement controls.](#)

[Learn about setting the Reference Level controls.](#)

[Learn about using Measurement Statistics.](#)

Set up histogram measurements

From the Measure menu, select Measurement Setup; then open the Histog tab.

To use

Use this control window to set up the instrument for taking histogram measurements.

For information on the controls, click the buttons.

- [Measurements](#)
- [Measure | Source](#)
- [Ref Levels](#)
- [Gating](#)
- [Statistics](#)
- [Snapshot](#)
- [Histogram](#)

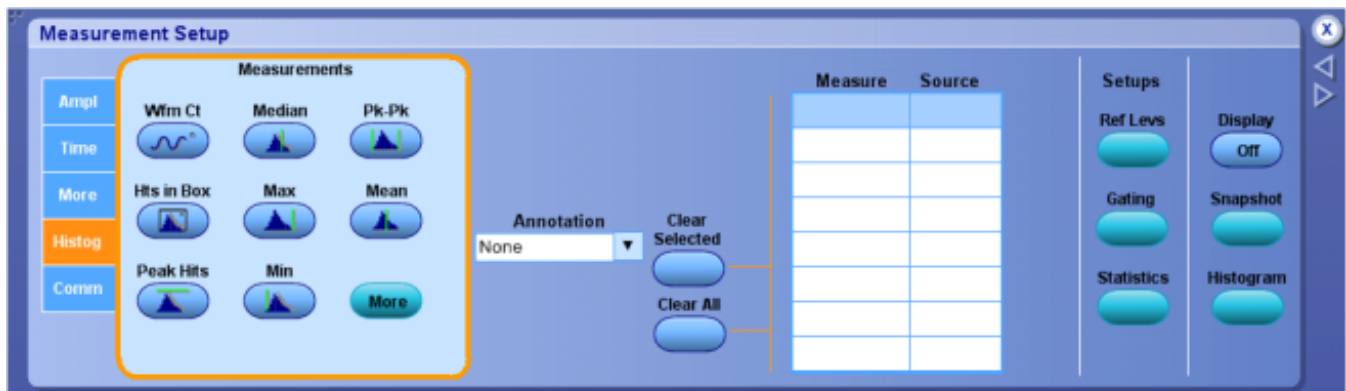

Behavior

From this control window, you can do the following:

- Define histogram measurements for the selected waveforms.
- Select a waveform source using the [Channels Selector](#). You can measure live waveforms, math waveforms, or reference waveforms.
- Create a list of measurements to appear in the main graticule or in a separate measurement window.
- Define the unique reference levels for each measurement.
- Use gating to limit the measurements to a specific area of the waveform.
- Set up measurement statistics.
- Set up histograms to evaluate specific regions of the waveform.

NOTE. Automatic measurements are not available on digital channels.



TIP. Turn on Fast Acquisitions to enhance your measurements. In Fast Acquisitions mode, measurements are calculated on an array of acquired waveforms. As the waveforms accumulate (with persistence on), your measurement accuracy may increase. However, only one or two channels can be displayed when you take automatic measurements using Fast Acquisitions mode.

If three or more channels are displayed, Fast Acquisitions mode is turned off, and then the requested measurements are made. Fast Acquisitions mode is not automatically turned back on when you select fewer than three channels.

What do you want to do next?

[Go to a step-by-step procedure to set up the instrument for taking measurements.](#)

Set up histograms

From the Measure menu, select Waveform Histograms, or click the Histogram button in the Measurement Setup window.

Overview

Use the Histogram control window to set up a vertical or horizontal histogram. Use vertical histograms to measure signal noise and horizontal histograms to measure signal jitter.

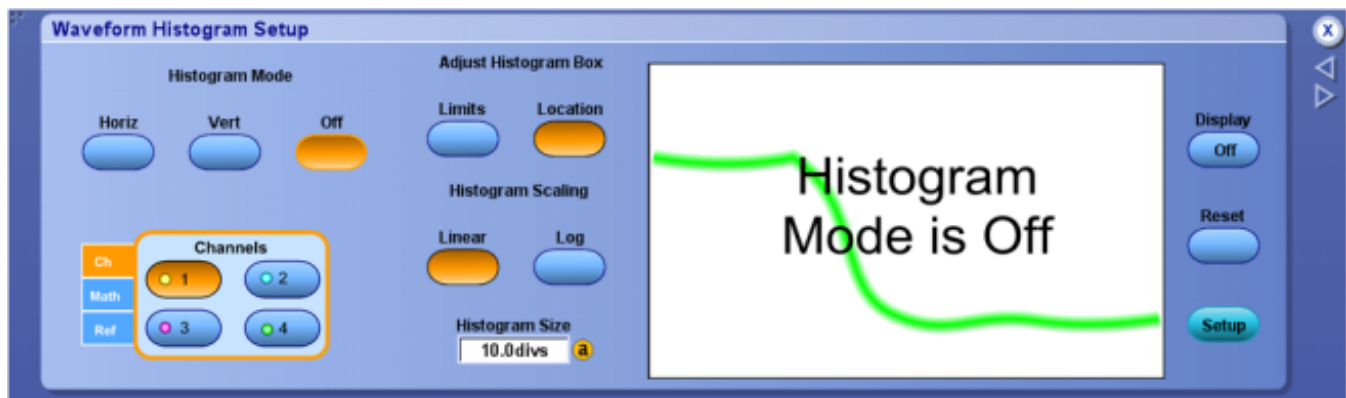

To use

1. Use the [Channels Selector](#) to select the source waveform for the histogram measurements.
2. Click the type of histogram you want to use for your measurement, Horiz (Horizontal) or Vert (Vertical). When you make this selection, the instrument continues to calculate histograms until you set Display to Off.
3. Click either Linear or Log to set the scaling.
4. Adjust the size of the histogram box (Horiz or Vert) by clicking Limits under Adjust Histogram Box. Use the multipurpose knobs or keypad keypad to set the box boundaries.
5. Move the location of the histogram box (Horiz or Vert) by clicking Location under Adjust Histogram Box, and then use the multipurpose knobs or keypad to set the X and Y locations.

NOTE. You must explicitly click the *Histogram Mode Off* button to stop accumulating histogram data. You can also click *Reset* to start a new histogram.

Behavior

A histogram consists of a series of narrow bins into which samples are counted. The histogram box defines the graticule area of the histogram and the number of vertical or horizontal bins. Horizontal histograms have a maximum of 1000 bins while vertical histograms have a maximum of 252 bins. The upper-most and bottom-most bins are not displayed. They are used for tracking over-range and under-range hits and can be obtained by saving the histogram data to a file.

The displayed width or height of the bin that contains the most counts is determined by the Histogram Size control. The relative sizes for all other bins are scaled proportionally to the bin that contains the most counts.

Histogram limits use the same units as the horizontal and vertical scale controls. When you specify the histogram box in terms of location, the Y location control adjusts the bottom edges of the histogram while the X location control adjust the left edge of the histogram box.

TIP. Here are several tips for using histograms:



Right-click in the Histogram box to access a shortcut menu that will allow you to quickly make changes to the histogram.

Use the Measure menu or shortcut menu *Reset Histogram* command to reset all bin counts to 0.

Click, hold, and drag across part of the graticule where you want to set up a histogram and select *Histogram* from the shortcut menu.

Use the same click, hold, and drag method to remove a histogram from the display. Select *Histogram Off* from the shortcut menu.

You can turn the histogram display off and still accumulate histogram data. This enables you to view the waveform without having the histogram obscure the data. Turn the histogram display on (use the *Display* button on the right side of the control window) at any time to view the histogram.

Use the front-panel channel buttons to turn the source waveform display off so that the waveform does not obscure the histogram. Data accumulation continues whether the waveform display is on or off.

The instrument can perform up to eight [automated statistical measurements](#) on the histogram. Allow the histogram to accumulate data for a while, and then turn on the desired measurements.

You can use *Fast Acquisitions* mode with histograms. However, only one or two channels can be displayed. If three or more channels are displayed, the *Fast Acquisitions* mode is turned off. The *Fast Acquisition* mode is automatically turned back on when you select fewer than three channels.

What do you want to do next?

[Return to the Measurement Setup control window overview.](#)

Histogram box limits - horizontal

1. Select a mode:

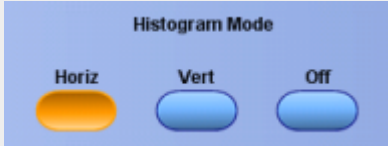

2. Specify the adjustment:

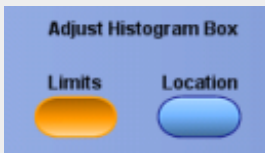

3. Enter limits:

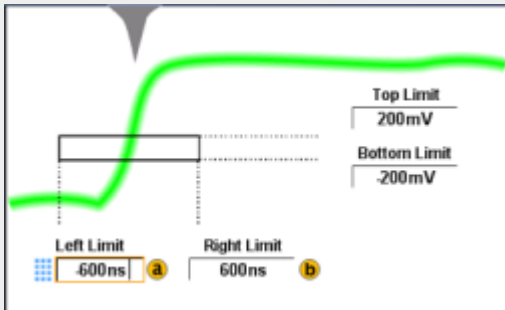

Set histogram box limits - vertical

1. Select a mode:

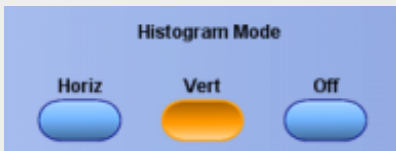

2. Specify the adjustment:

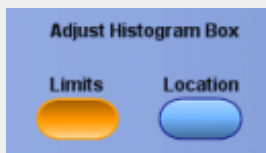

3. Enter limits:

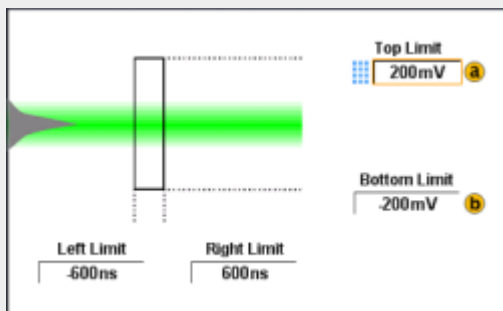

Set histogram box location - horizontal

1. Select a mode:

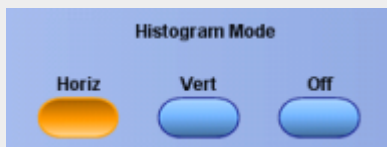

2. Specify the adjustment:

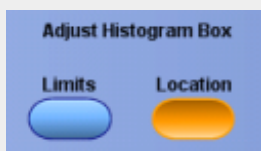

3. Enter limits:

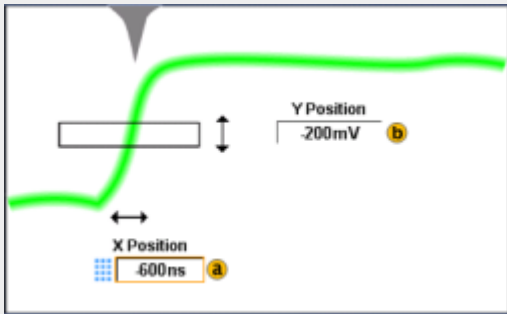

Set histogram box location - vertical

1. Select a mode:

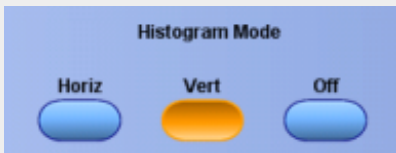

2. Specify the adjustment:

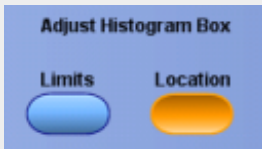

3. Enter limits:

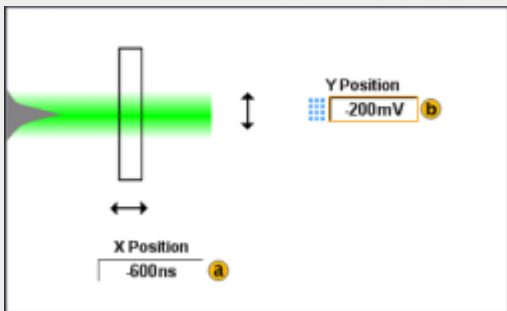

Analyzing waveforms

Control marks

From the Analyze menu, select Mark.

Overview

Use the Mark Control Window to manually set and clear marks on acquired waveforms in areas of interest.



To use

Use the controls in this window to set a mark on a waveform. You can return to the mark and analyze the waveform in the area at a later time.

1. Press the MultiView Zoom button on the instrument front panel. The instrument uses Zoom 1 to set marks.
2. From the Menu bar, select Analyze > Mark.
3. Move the zoom box to the area of interest on the waveform with the multipurpose knob.
4. Use the controls described below to set and clear marks.

NOTE. Marks appear as either green or white triangles on-screen. Green triangles represent locations placed automatically by the instrument; white triangles represent locations placed manually by the user.

Behavior

Use the Mark controls to set marks and analyze waveforms.

- **Description.** Click in the entry box and use the pop-up keyboard to enter a description for the mark you place.
- **Set/Clr.** Click this button to add or delete a mark. Marks are placed on the waveform at center screen.
- **Prev/Next.** Click these buttons to advance from one mark to another along the waveform.
- **Cursor 1/Cursor 2.** Click one of these buttons to position a cursor at the active mark.
- **Zoom 2/Zoom 3.** Click one of these buttons to zoom the area around the active mark. Zoom 1 is the default used by the Search and Mark feature.

Select a search type

From the Analyze menu, select Search; then open the Select tab.

Overview

Use the controls in this window to set up the instrument to automatically search and place mark(s). The instrument can search for and mark many of the same conditions that are available for triggers.

NOTE. Search and mark operations are not available on digital channels.

This document is for more than one instrument. Your instrument, or instrument setup, may not include some of these features. For DPO70000SX instruments see [Features not available](#).

To use

For information on the controls, click the buttons.

- [Type](#)
- [Source](#)
- [Search/Mark Controls](#)

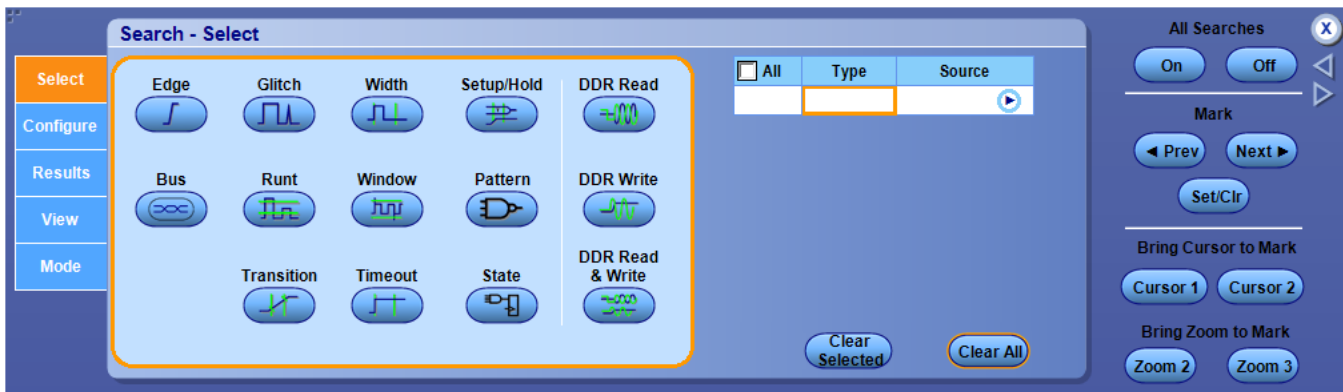

NOTE. The Edge search type is standard, all other search types are optional.

Behavior

You can search for and mark regions with particular edges, pulse widths, runts, logic states, rise and fall times, setup and hold violations and bus types. You can also search on math and reference waveforms.

Select the search type

From the Analyze menu, select Search; then open the Select tab.

Overview

Use these controls to select the type of search you want the instrument to perform to automatically place marks on a waveform.

NOTE. This document is for more than one instrument. Your instrument, or instrument setup, may not include some of these features. For DPO70000SX instruments see [Features not available](#).

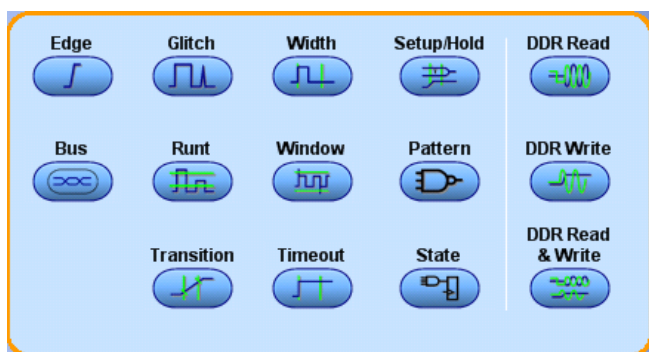

To use

- Click a button to identify the type of search to perform.
- The search Type will appear under Type in the Type-Source table.

Behavior

Clicking a button places the search selection in the Type column of the Type-Source table

Select the search source

From the Analyze menu, select Search; then open the Select or Configure tabs.

Overview

The Source Selection windows allow you to specify the channel parameters used in the search.

To use

1. In the Type-Source table, identify the search Type you want to use; then click the right arrow for that search type under Source.
2. After the Source Selection window opens, identify the Channel, Source, Clock, or Logic parameters to be used in the search.
3. Click OK

Behavior

Use the single Source Selection window to set the Channel parameters for an Edge, Glitch, Runt, Transition, Width, Window, or Timeout search.



Use the dual Source Selection window to set the Clock and Data Source parameters for a Setup and Hold search.

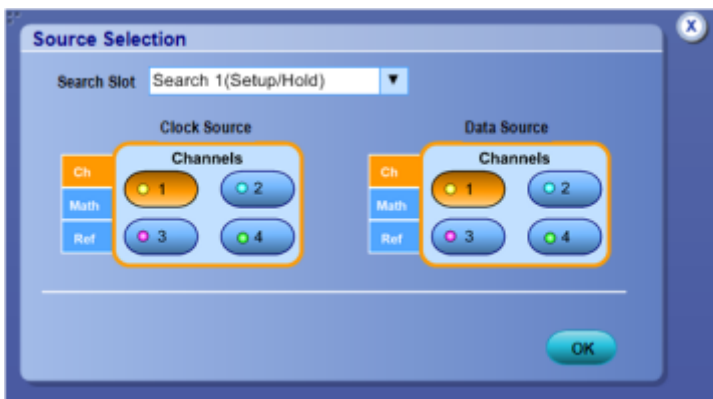

Use the Logic Source Selection window to set the threshold parameters for a Pattern or State logic search.

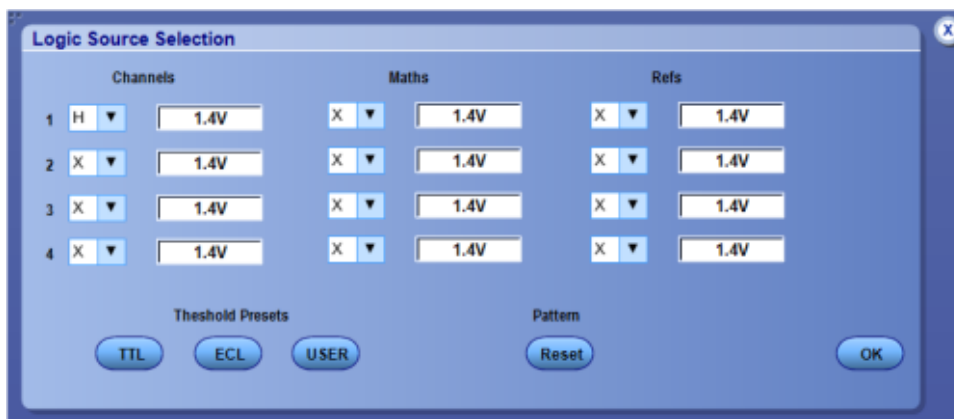

Configure a search

From the Analyze menu, select Search; then open the Configure tab.

Overview

Use the controls in this window to set up the instrument to automatically search and place marks.

NOTE. Search and mark operations are not available on digital channels.

To use

For information on the controls, click the buttons.

- [Type](#)
- [Source](#)
- [Copy Settings](#)
- [Search Parameters](#)
- [Search / Mark Controls](#)

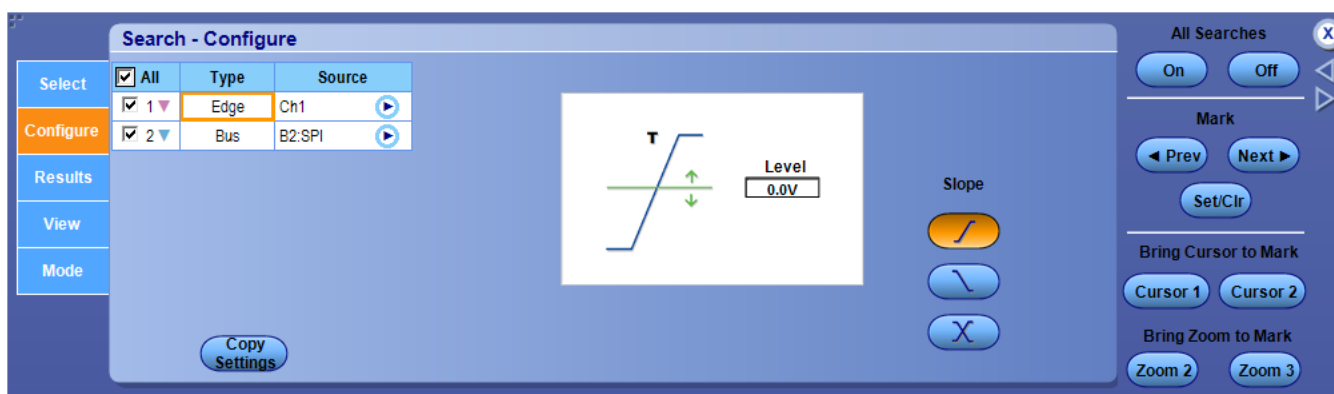

Behavior

Clicking an entry in the Type column activates the individual search controls, similar to the one shown above. These controls vary depending on the search Type. Setting the search conditions is similar to setting the parameters for an *Event Trigger*.

NOTE. No information will be displayed in this window until you specify at least one search Type in the *Search Select Control Window*.

Copy search settings

From the Analyze menu, select Search; then open the Configure tab and press the Copy Settings button.

Overview

Use these controls to copy settings from one search to another. You can also copy a trigger setting to a search.



To use

1. Set up the desired search(s) in the Search - Select window.
2. Set up the parameters for the search in the Search - Configure window.
3. Click the Copy Settings button to open the Copy Settings window.
4. In the From drop-down list box, select the search or trigger you want to copy.
5. In the To drop-down list box, select the search to copy the settings to.
6. Click the Copy button.

What do you want to do next?

[Learn about Search Advanced DDR Control Settings.](#)

Set advanced DDR search settings

From the Analyze menu, select Search; then open the Configure tab.

Overview

Use the controls in these windows to set conditions for the instrument to automatically search and place marks.

To use

1. Under Type, select one of the following entries DDR Read, DDR Write, and DDR Read & Write in the Select tab.
2. Specify a source for the selected DDR search in the Configure tab.
3. Click the Settings button to configure the advanced DDR settings.

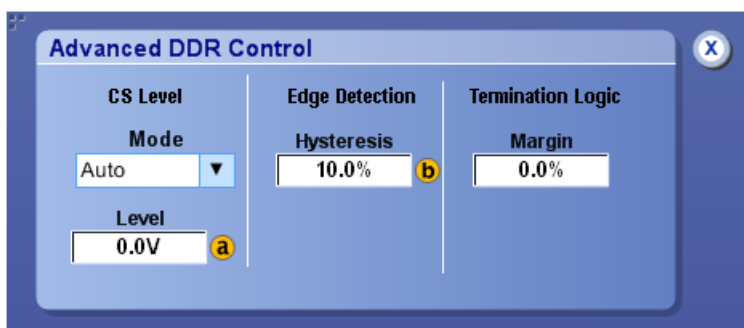

- Use either Auto or Manual option in the Mode drop-down (under CS Level). When auto is selected, the midlevel of the chip select source is automatically calculated, and values above or below this voltage are used to gate mark generation. In custom mode, the specified level is used as the midlevel.
- Specify a value in the Level entry box (under CS Level). This value is used when the CS Level Mode is set to manual.
- Specify a value in the Hysteresis entry box (under Edge Detection). This value is used for edge detection in the DDR algorithm.
- Specify a value in the Margin entry box (under Termination Logic).

What do you want to do next?

[Learn about Search Copy Settings.](#)

[Learn about setting up DDR search parameters.](#)

Set search parameters

From the Analyze menu, select Search; then open the Configure tab.

Overview

Use the controls in these windows to set conditions for the instrument to automatically search and place marks.

To use

The available controls depend on the searches you selected in the Search - Select Control Window.

1. Under Type, click on an entry in the Type-Source table.
2. Set up the controls for each search you want to perform.
3. Click the Search button to On to initiate a search.

Behavior

Refer to the following table for information on automated searches the instrument can perform. The search controls are functionally similar to the trigger controls.

| Search type | Description | Equivalent trigger |
|----------------|--|---|
| Edge | Searches for edges (rising or falling) with a user-specified threshold level. | Edge Trigger Control Window |
| Glitch | Searches for pulses narrower (or wider) than the specified width, or ignores glitches narrower (or wider) than the specified width. | Glitch Trigger Control Window |
| Pattern | Search for a logic pattern (AND, OR, NAND, or NOR) across multiple waveforms with each input set to either High, Low, or Don't Care. Search for when the event goes true, goes false, or stays valid for >, <, =, or ≠ a user-specified time. Additionally, you must define one of the inputs as a clock for synchronous (state) searches. | Serial Pattern Control Window |
| Pulse Width | Searches for positive or negative pulse widths that are >, <, =, or ≠ a user-specified pulse width | Width Trigger Control Window |
| Runt | Searches for positive or negative pulses that cross one amplitude threshold but fail to cross a second threshold before crossing the first again. Search for all runt pulses or only those with a duration >, <, =, or ≠ a user-specified time. | Runt Trigger Control Window |
| Setup and Hold | Search for violations of user-specified setup and hold times. | Setup and Hold Trigger Control Window |
| State | Searches for the condition when all logic inputs to the selected logic function cause the function to be True or False when the clock input changes state. | Logic State Trigger Control Window |

| Search type | Description | Equivalent trigger |
|--------------|--|---|
| Timeout | Searches for no pulse in a specified time. | Timeout Trigger Control Window |
| Transition | Search for rising and or falling edges that are >, <, =, or ≠ a user-specified time. | Transition Time Trigger Control Window |
| Window | Searches for a signal that is entering or leaving the threshold window. Qualify the search in terms of time by using the When Wider option, or by the logical state of other channels using the When Logic option. | Window Trigger Control Window |
| DDR Searches | Searches for DDR read or write events on source waveforms. | None |
| Bus | Search for bus events on source waveforms. | Bus Trigger Control Window for Parallel Bus Trigger Control Window for I2C Serial Bus Trigger Control Window for SPI Serial Bus Trigger Control Window for RS232 Serial Bus Trigger Control Window for USB Serial Search MIPI Bus Bus Trigger Control Window for PCIe Serial Bus Trigger Control Window for CAN Serial Bus Trigger Control Window for LIN Serial Bus Trigger Control Window for FLEXRAY Serial |

Check search results

From the Analyze menu, select Search; then open the Results tab.

Overview

The table in this window displays timing information for all marks placed during a search.

To use

For information on the controls, click the buttons.

- [User Marks in Table](#)
- [Digits](#)
- [Export](#)
- [View](#)

Results: Mark Table

| Index | Type | Src | Location | Time Delta | | | | | Description |
|-------|------|-----|----------|------------|-----|-----|-----|-----|-----------------|
| | | | | sec | ms | us | ns | ps | |
| 1 | Edge | C1 | -980ps | | | | | | +Edge: level=0V |
| 2 | Edge | C1 | -928ps | 000 | 000 | 000 | 000 | 052 | +Edge: level=0V |
| 3 | Edge | C1 | -862ps | 000 | 000 | 000 | 000 | 066 | +Edge: level=0V |
| 4 | Edge | C1 | -808ps | 000 | 000 | 000 | 000 | 054 | +Edge: level=0V |
| 5 | Edge | C1 | -762ps | 000 | 000 | 000 | 000 | 046 | +Edge: level=0V |
| 6 | Edge | C1 | -688ps | 000 | 000 | 000 | 000 | 074 | +Edge: level=0V |

User Marks in Table: $\Delta Z1.Z2$, $\Delta Z2.Z3$, $\Delta Z1.Z3$

Total Marks: 24

Behavior

The Location and Time Delta columns list the search results for each mark placed by the instrument for the search Type indicated. You can also use the buttons to edit or change the format of the table and save results to a file.

View the search counts results

From the Analyze menu, select Search; then open the Results tab and click the Count button.

Overview

Use the controls in this window to view the number of times the search criteria was met and the instrument placed a mark on the waveform.

To use

For information on the controls, click the buttons.

- [User Marks in Table](#)
- [Export](#)
- [View](#)

Results: Counts

| Type | Source | Count |
|--------|--------|-------|
| 1 Edge | C1 | 3 |

User Marks in Table: $\Delta Z1.Z2$, $\Delta Z2.Z3$, $\Delta Z1.Z3$

View Time

Behavior

The table in this window displays count results for automated search and mark operations. The Count column displays the number of times the search conditions were met for a specific Type of search.

You can also use the buttons to edit the Results Mark Table and save results to a file.

View search marks

From the Analyze menu, select Search; then open the View tab.

Overview

Use the controls in this window to display marks.



To use

- Click the Show Marks button On or Off to display the marks placed on a waveform.

Set the search mode

From the Analyze menu, select Search; then open the Mode tab.

Overview

You can set up the instrument to stop acquiring waveforms when a search criteria is met and the instrument finds a match.

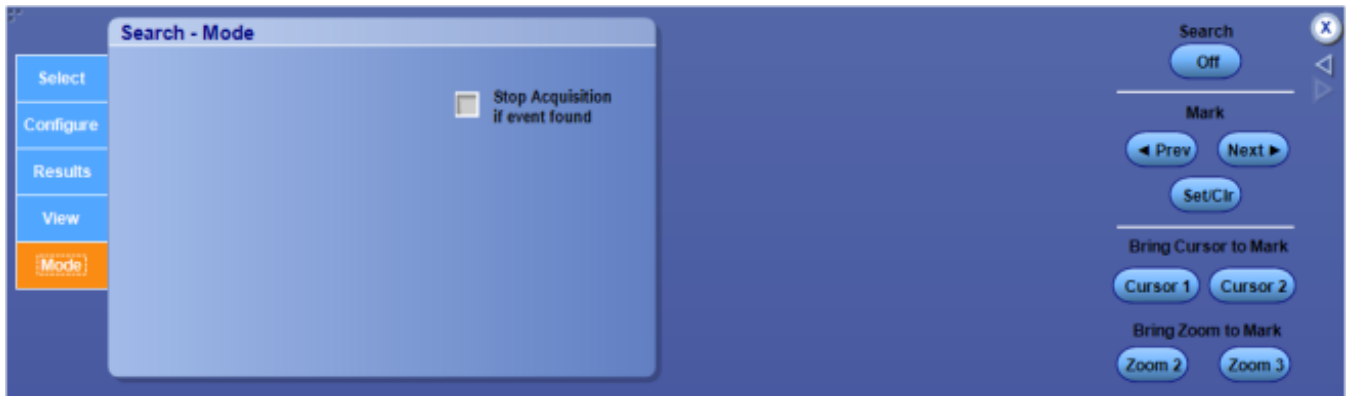

To use

- Check the Stop Acquisitions if event found option box to stop acquisitions during a search, if a match is found.

Use search and mark controls

From the Analyze menu, select Search, and then open any of the tabs.

Overview

Use these controls to find points of interest, and place or edit marks on the waveform. The Search and Mark controls are also available through front panel buttons (DPO7AFP required by DPO7000SX instruments).

NOTE. Search and mark operations are not available on digital channels.

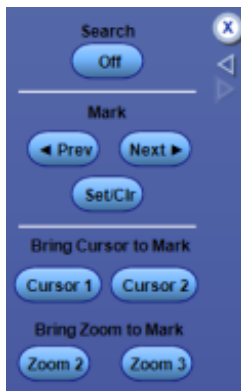

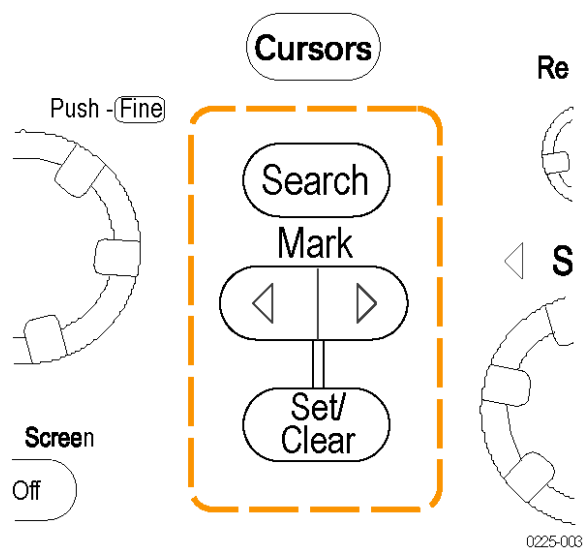

To use

- **Search.** Click this button to turn the Search and Mark feature On or Off. Use the corresponding **Search** button on the front panel to also turn the feature On or Off.
- **Prev /Next.** Click this button to advance from one mark to another along the waveform. Use the corresponding **Mark** ◀ and ▶ buttons on the front panel to also move from mark to mark.
- **Set /Clr.** Click this button to add or delete a user mark. User marks are placed on the waveform at center screen. Use the corresponding **Mark Set/Clr** button on the front panel to also add or delete a user mark.
- **Cursor 1/Cursor 2.** Click one of these buttons to position a cursor at the active mark.
- **Zoom 2 / Zoom 3.** Click one of these buttons to zoom the area around the active mark. Zoom 1 is the default used by the Search and Mark feature.

Behavior

Use the Search and Mark controls to set a mark on a waveform at a point of interest. You can return to a mark and analyze the waveform at a later time.

Marks appear as either green or white triangles on-screen. White triangles represent locations placed manually by the user. Other triangles represent locations placed automatically by the instrument; the color of the triangles depend on the selected search index.

Control user marks in table

From the Analyze menu, select Search; then open the Results tab.

Overview

Use these controls to convert search marks to user marks and to edit the Result: Mark Table.



To use

- **Set.** Click this button to add a user mark where a search mark was placed by the system. If a search mark is not selected, then you are asked to select a search mark.
- **Set All.** Click this button to add a user mark at all places where there is a search mark.
- **Clear.** Click to remove the currently selected user mark. If a user mark is not selected, you are asked to first select a user mark.
- **Clear All.** Click this button to remove all user marks from the Results: Mark Table.

Change mark display digits

From the Analyze menu, select Search; then open the Results tab.

Overview

Use this control to change the type of notation used in the Results: Mark Table.



To use

- Click the Digits button to toggle the display notation between engineering or high precision form.

Export a mark table

From the Analyze menu, select Search; then open the Results tab.

Overview

Use these controls to export the Mark Table to a file.



To use

- **Export.** Click this button to open the Save Marks Table dialog box and export the table to a file in CSV format.

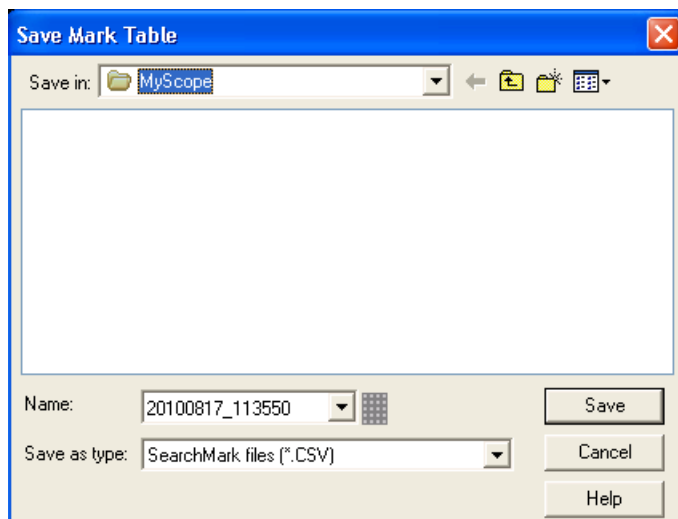

View mark counts

From the Analyze menu, select Search; then open the Results tab.

Overview

Use this control to view event and timing information for marks.



To use

- Click the View Time / Count button to toggle between the Results Mark and Results Count tables.

Set up a visual search

Overview

A visual search is performed with the same settings as the main trigger. The results of a visual search are displayed as marks with a color distinct from those of an Analyze search.

To use

Do the following steps to set up a visual search.

- Set up pinpoint triggers. [Set up trigger controls A Event tab](#)
- Set up a visual trigger. [Visual Trigger Setup](#)
- Click **Mark All Trigger Events in Record**.

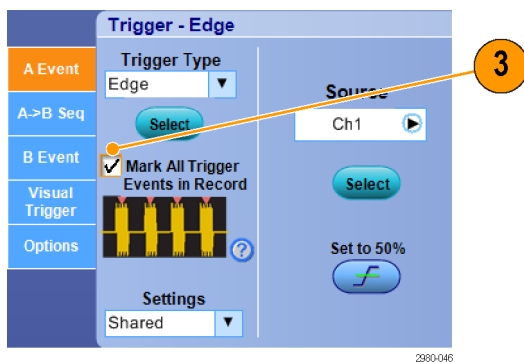

- Visual Trigger areas are displayed in blue, or they inherit the source channel color.

- Visual Search areas are displayed in green.

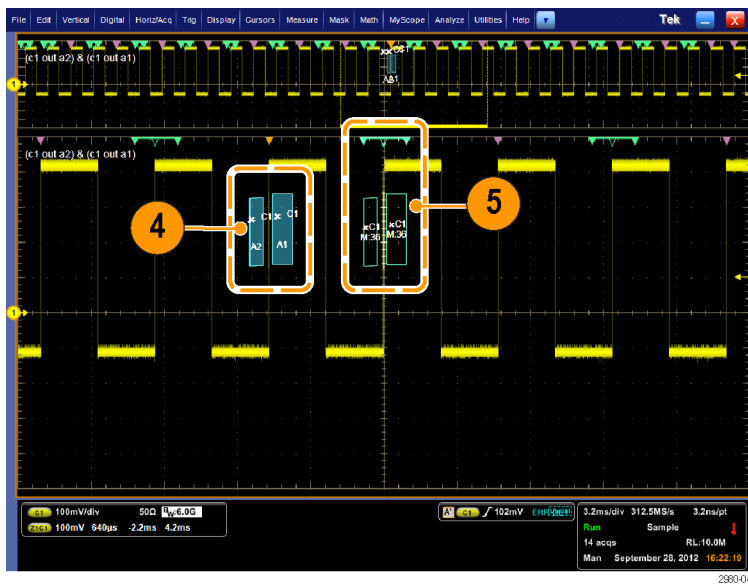

- Only the active visual search area is displayed. Press the **Mark Next** and the **Mark Prev** buttons to move the active area to other visual search areas. Active search areas only appear in the zoom window.

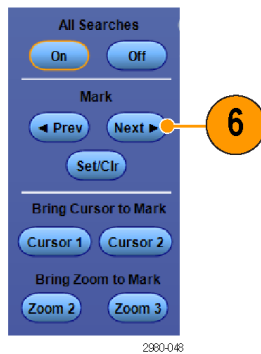

Use the other Analyze Search control windows to control or view the results of the Visual Search.

What do you want to do next?

[Learn about bus setups.](#)

[Learn about trigger setups.](#)

[Learn about setting up a Visual Trigger.](#)

[Learn about setting up a search.](#)

Set up 8B10B search parameters

After setting up an 8B10B bus, go to the Analyze menu, select Search, and then select the Bus trigger type; then open the Configure tab.

Overview

Use the controls to set up the 8B10B Bus parameters.

To use

For information on the controls, click the buttons.

- [Type](#)
- [Source](#)
- [Copy Settings](#)
- [Search Parameters](#)
- [Search / Mark Controls](#)

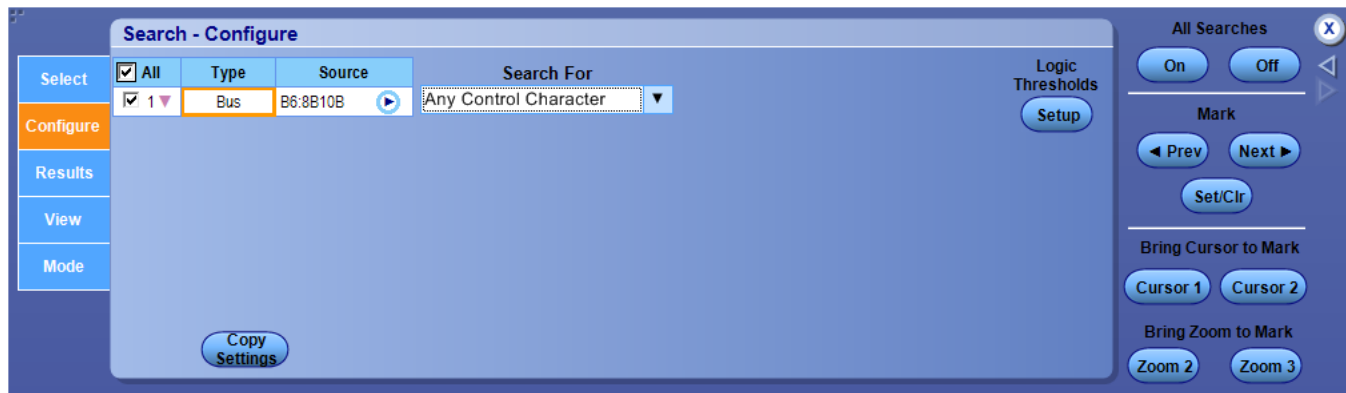

Behavior

Clicking an entry in the Type column activates the individual search controls, similar to the one shown above. These controls vary depending on the search Type. Setting the search conditions is similar to setting the parameters for an [Event Trigger](#).

NOTE. No information will be displayed in this window until you specify at least one search Type in the [Search Select Control Window](#).

To use

- Click the Source box and select the bus number or name from the window. [Bus Search Selection List](#)
- Select the type of bus cycle or activity to search for from the Search For drop-down list.

- For some Search For selections, you must set additional fields to define other parameters such as for an Error.
In this example, you need to the errors to search for. Optionally, you can also set the component threshold levels through the Logic Thresholds Setup button.

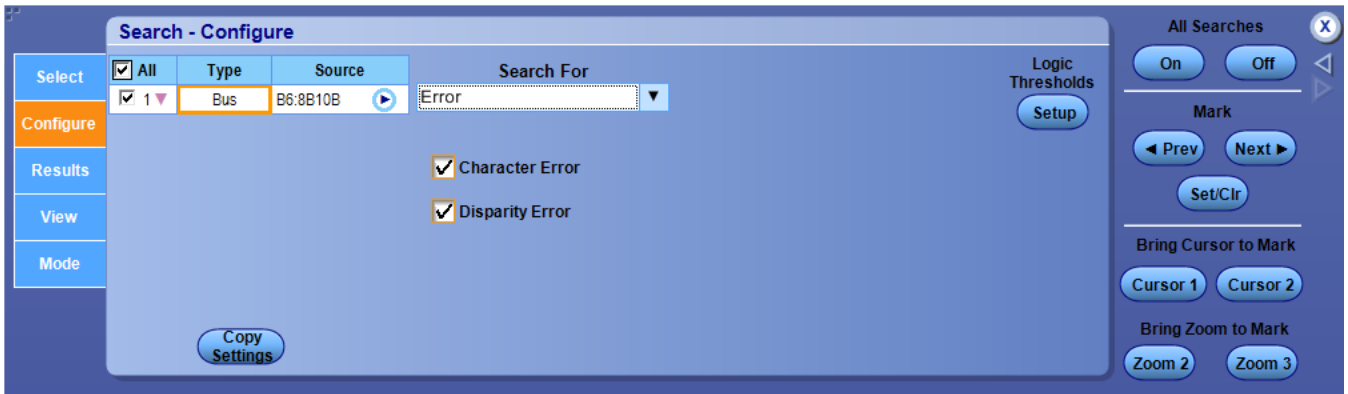

Click the Search For selections Error, Pattern, Character/Symbol, or Any Character to view their parameters.
What do you want to do next?

[Learn about bus setups.](#)

Search for error

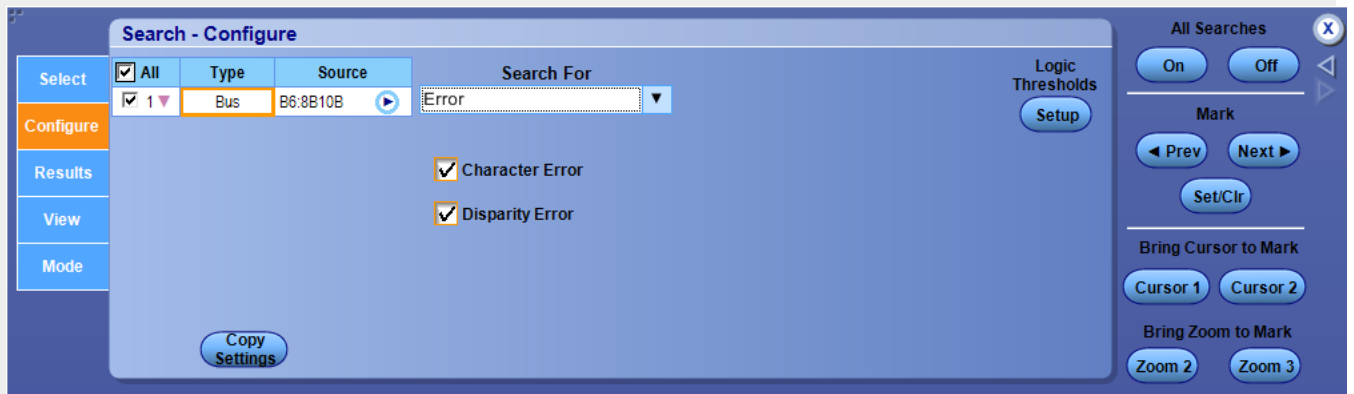

Search for pattern

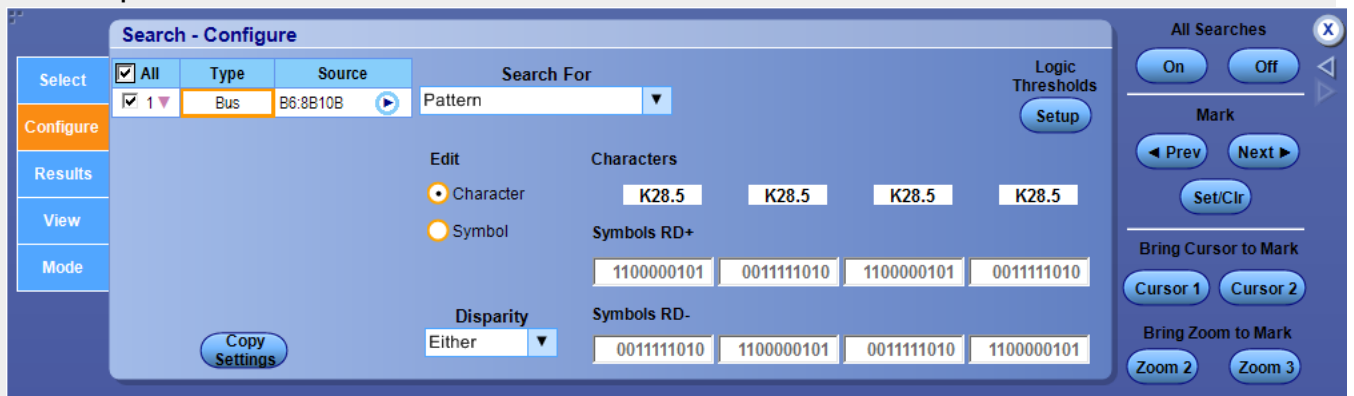

Search for character/symbol

The mode options available in Search For Character/Symbol are Character, Symbol, and Disparity.

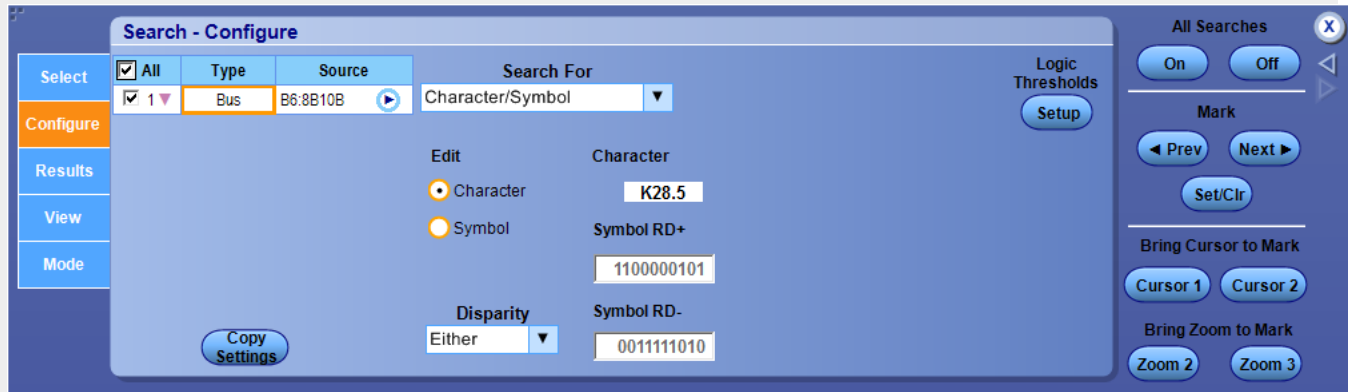

Select the Disparity from the drop-down list. Click Character to search for a character. Click Symbol to search for a symbol. Click Setup to adjust the logic thresholds.

Search for any character

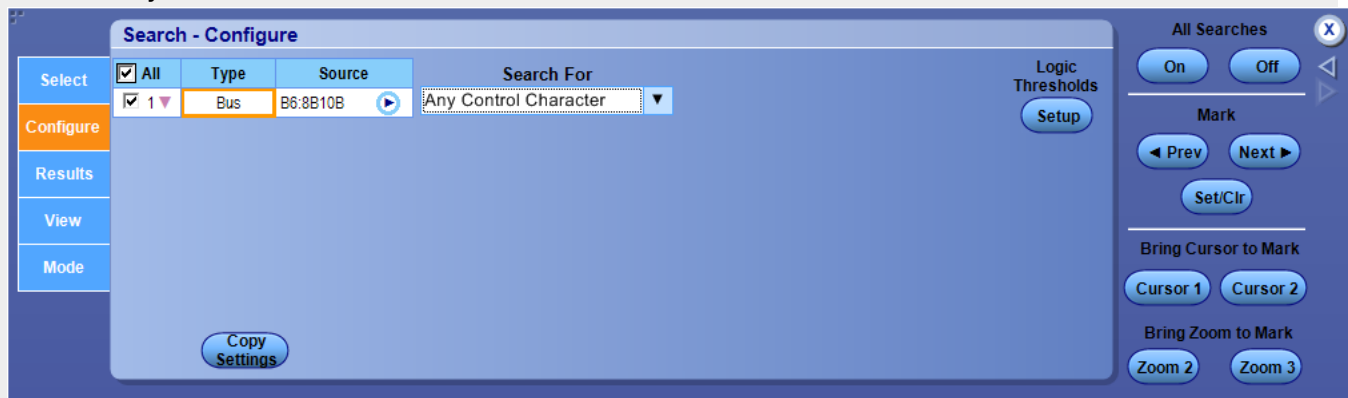

Set up RS-232 search parameters

After setting up an RS-232 bus, go to the Analyze menu, select Search, and then select the Bus trigger type; then open the Configure tab.

Overview

Use the controls to set up the RS-232 Bus parameters.

To use

For information on the controls, click the buttons.

- [Type](#)
- [Source](#)
- [Copy Settings](#)
- [Search Parameters](#)
- [Search / Mark Controls](#)

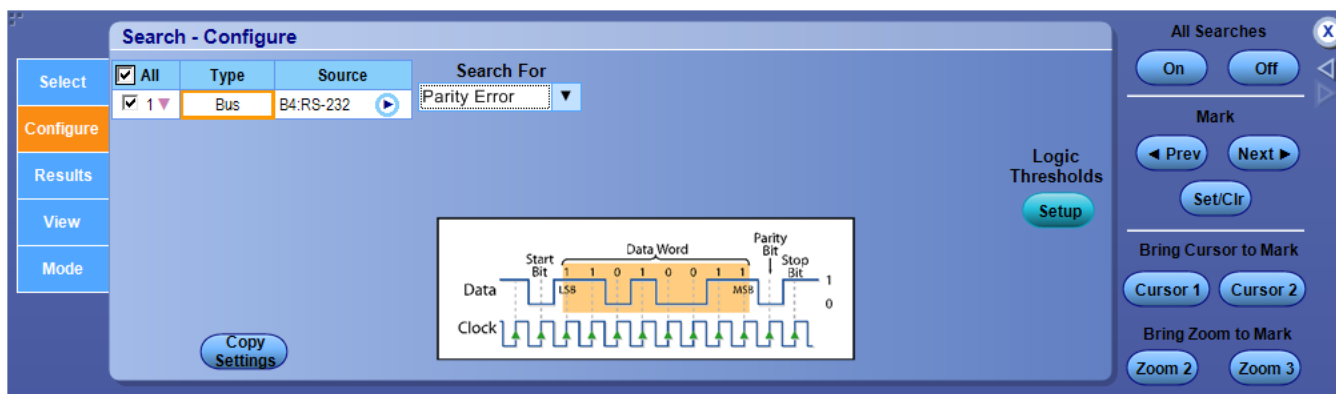

Behavior

Clicking an entry in the Type column activates the individual search controls, similar to the one shown above. These controls vary depending on the search Type. Setting the search conditions is similar to setting the parameters for an [Event Trigger](#).

NOTE. No information will be displayed in this window until you specify at least one search Type in the [Search Select Control Window](#).

To use

- Click the Source box and select the bus number or name from the window. [Bus Search Selection List](#)
- Select the type of bus cycle or activity to search for from the Search For drop-down list.

- For some Search For selections, you must set additional fields to define other parameters such as for a Data. In this example, you need to set a Number of Bytes, Data Format, and Data Value (click the *Edit* button). Optionally, you can also set the component threshold levels through the Logic Thresholds Setup button.

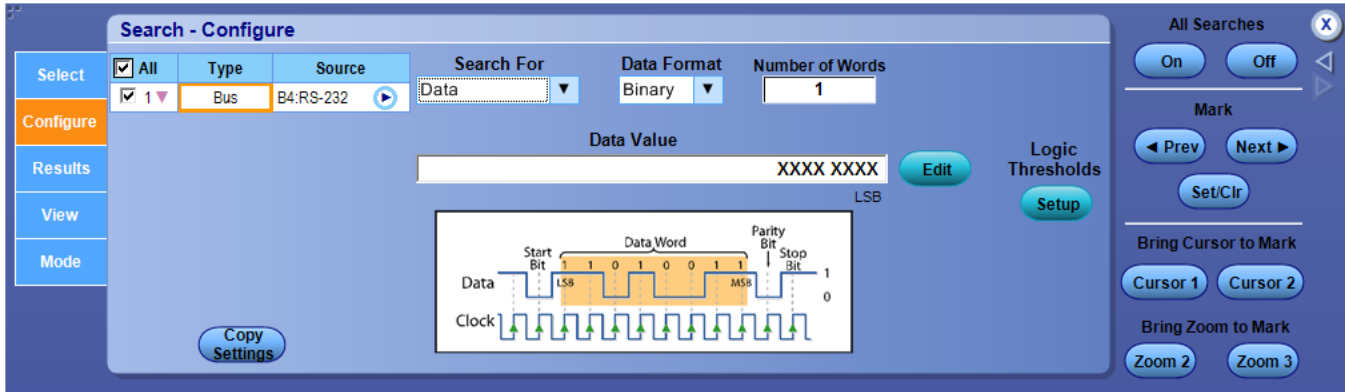

Click the Search For selections Start, Parity Error, or Data to view their parameters.
 What do you want to do next?

[Learn about bus setups.](#)

Search for start

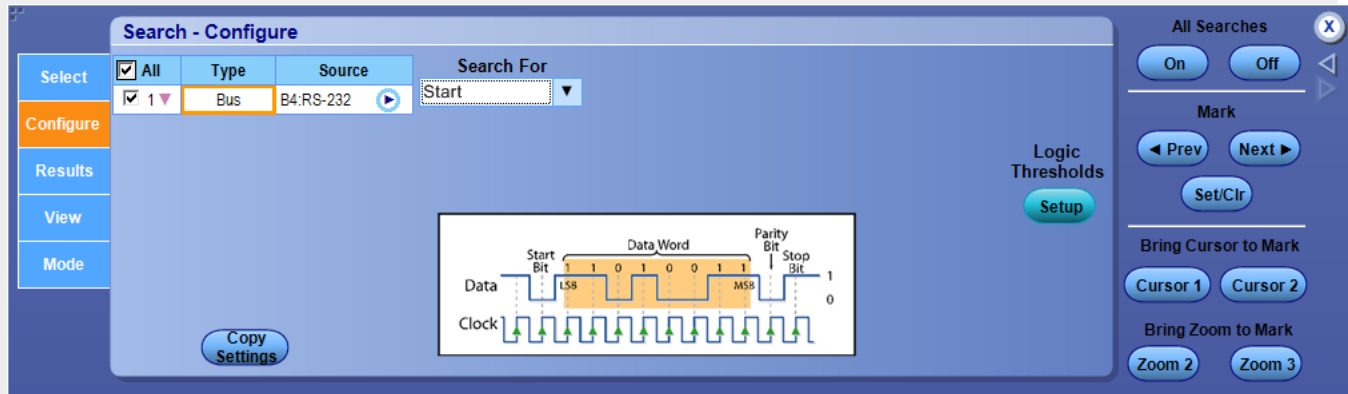

Search for parity error

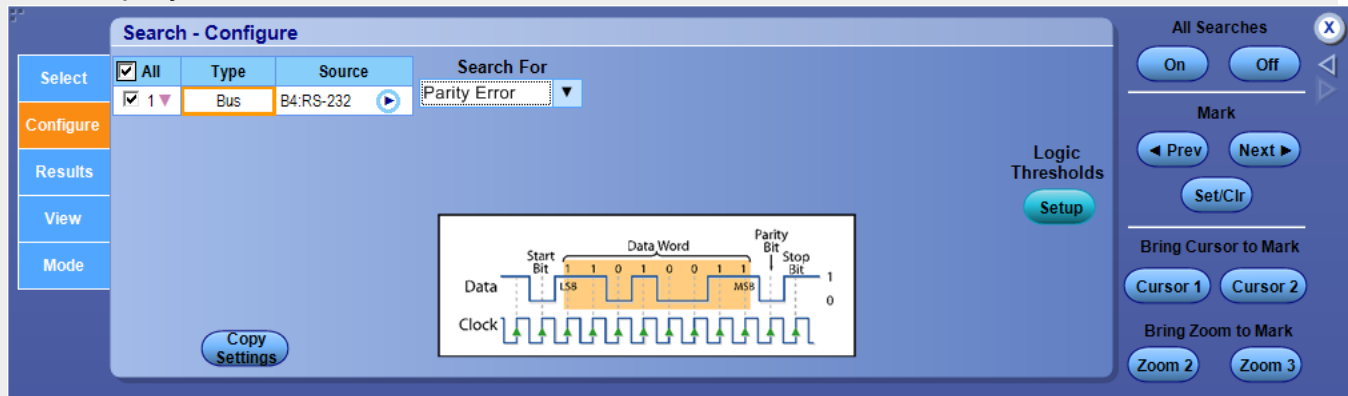

Search for data

The data type options available in Search For Data are Number of Bytes, Data Format, and Data Value.

The screenshot shows the 'Search - Configure' dialog box. On the left is a sidebar with 'Configure' selected. The main area has a 'Search For' dropdown set to 'Data', 'Data Format' set to 'Binary', and 'Number of Words' set to '1'. The 'Data Value' field contains 'XXXX XXXX'. Below this is a diagram of a data word with labels for Start Bit, Data Word (LSB to MSB), Parity Bit, and Stop Bit. On the right, there are buttons for 'All Searches' (On/Off), 'Mark' (Prev/Next/Set/Clr), 'Bring Cursor to Mark' (Cursor 1/Cursor 2), and 'Bring Zoom to Mark' (Zoom 2/Zoom 3). A 'Logic Thresholds Setup' button is also present.

Select the Data Format from the drop-down list. Click Edit to enter the data value. Click Setup to adjust the logic thresholds.

Set up SPI search parameters

After setting up an SPI bus, go to the Analyze menu, select Search, and then select the Bus trigger type; then open the Configure tab.

Overview

Use the controls to set up the SPI Bus parameters.

To use

For information on the controls, click the buttons.

- [Type](#)
- [Source](#)
- [Copy Settings](#)
- [Search Parameters](#)
- [Search / Mark Controls](#)

The screenshot shows the 'Search - Configure' dialog box for an 'SS Active' search. The 'Search For' dropdown is set to 'SS Active'. The 'Data Value' field is empty. Below this is a timing diagram showing SCLK, SS, and Data (Bit 0 to Bit N). On the right, there are buttons for 'All Searches' (On/Off), 'Mark' (Prev/Next/Set/Clr), 'Bring Cursor to Mark' (Cursor 1/Cursor 2), and 'Bring Zoom to Mark' (Zoom 2/Zoom 3). A 'Logic Thresholds Setup' button is also present.

Behavior

Clicking an entry in the Type column activates the individual search controls, similar to the one shown above. These controls vary depending on the search Type. Setting the search conditions is similar to setting the parameters for an [Event Trigger](#).

NOTE. No information will be displayed in this window until you specify at least one search Type in the [Search Select Control Window](#).

To use

- Click the Source box and select the bus number or name from the window. [Bus Search Selection List](#)
- Select the type of bus cycle or activity to search for from the Search For drop-down list.
- For some Search For selections, you must set additional fields to define other parameters such as for Data.

In this example, you need to set a Data Format, Number of Words, and Data Value (click the [Edit](#) button). Optionally, you can also set the component threshold levels through the Logic Thresholds Setup button.

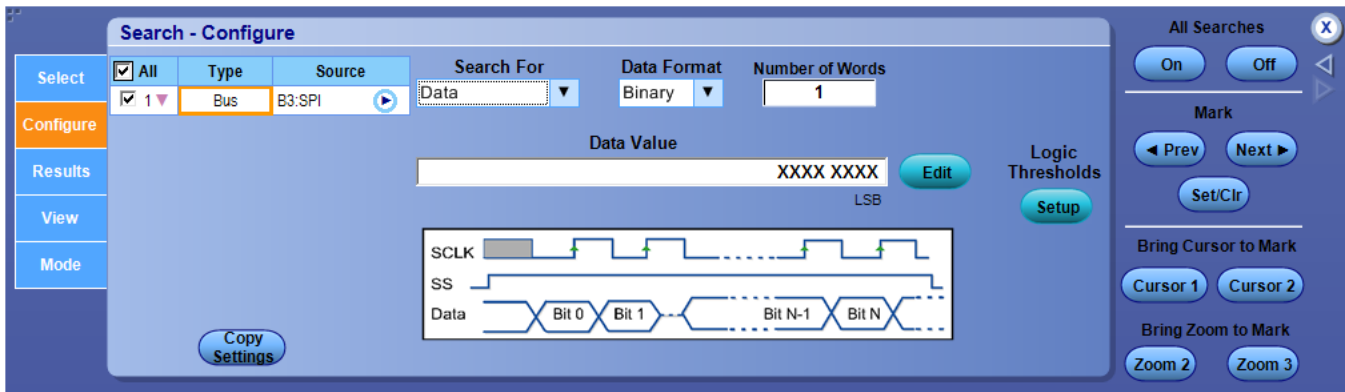

Click the Search For selections Data or SS Active, to view their parameters.

What do you want to do next?

[Learn about bus setups.](#)

Search for SS Active

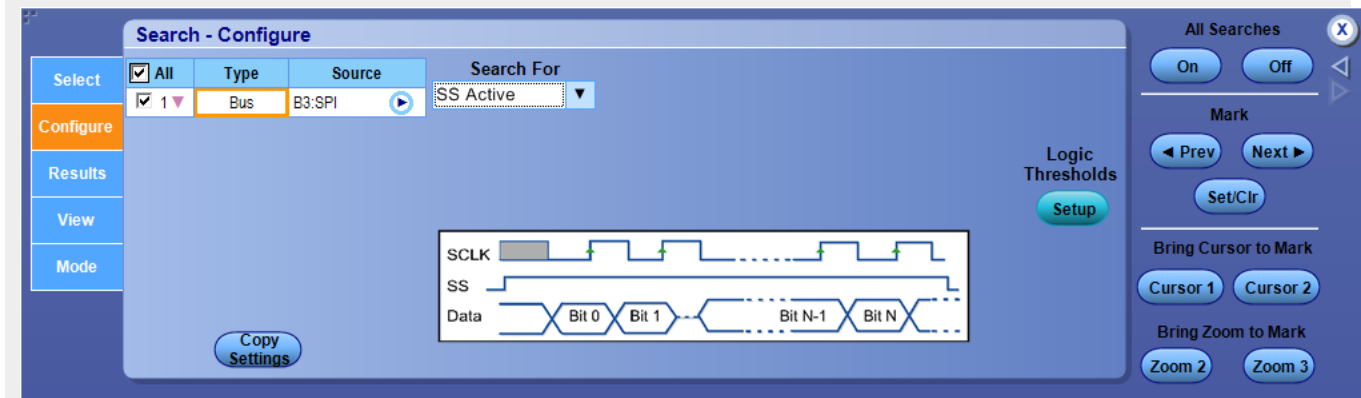

Search for data

The data type options available in Search For Data are Number of Bytes, Data Format, and Data Value.

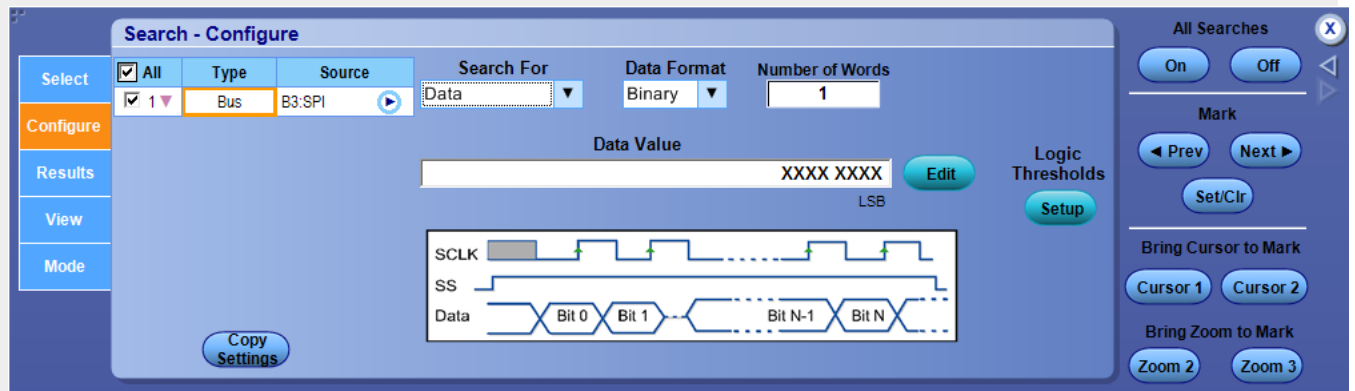

Select the Data Format from the drop-down list. Click Edit to enter the data value. Click Setup to adjust the logic thresholds.

Set up I2C search parameters

After setting up an I2C bus, go to the Analyze menu, select Search, and then select the Bus trigger type; then open the Configure tab.

Overview

Use the controls to set up the I2C Bus parameters.

To use

For information on the controls, click the buttons.

- [Type](#)
- [Source](#)
- [Copy Settings](#)
- [Search Parameters](#)
- [Search / Mark Controls](#)

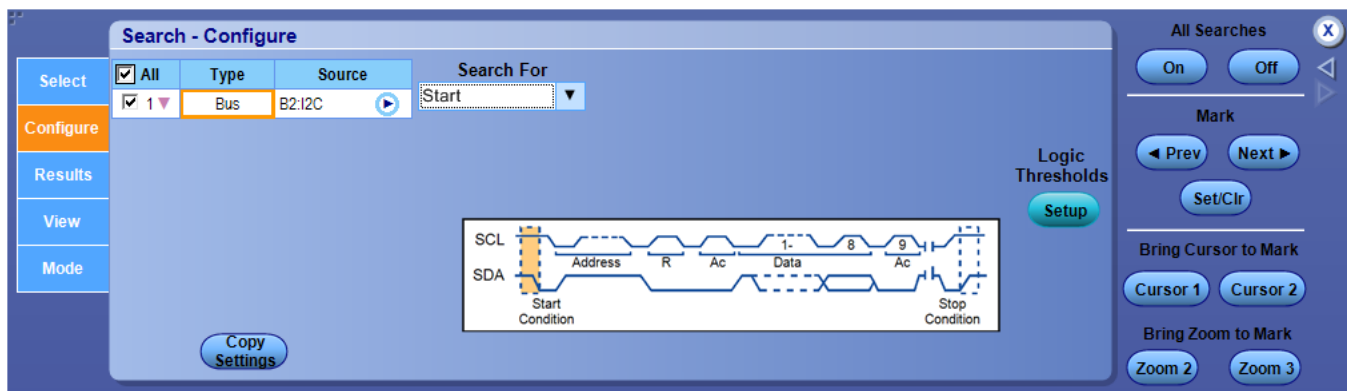

Behavior

Clicking an entry in the Type column activates the individual search controls, similar to the one shown above. These controls vary depending on the search Type. Setting the search conditions is similar to setting the parameters for an [Event Trigger](#).

NOTE. No information will be displayed in this window until you specify at least one search Type in the [Search Select Control Window](#).

To use

- Click the Source box and select the bus number or name from the window. [Bus Search Selection List](#)
- Select the type of bus cycle or activity to search for from the Search For drop-down list.
- For some Search For selections, you must set additional fields to define other parameters such as for a Data.

In this example, you need to set a Addressing Mode, Number of Bytes, Data Format, and Data Value (click the [Edit](#) button). Optionally, you can also set the component threshold levels through the Logic Thresholds Setup button.

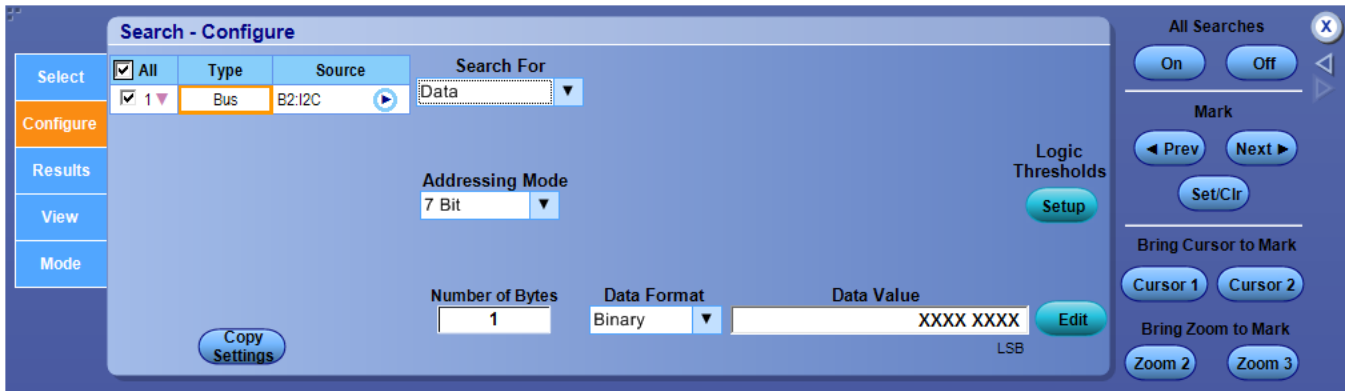

Click the Search For selections Start, Stop, Repeated Start, Missing ack, Address, Data, or Address and Data to view their parameters.

What do you want to do next?

[Learn about bus setups.](#)

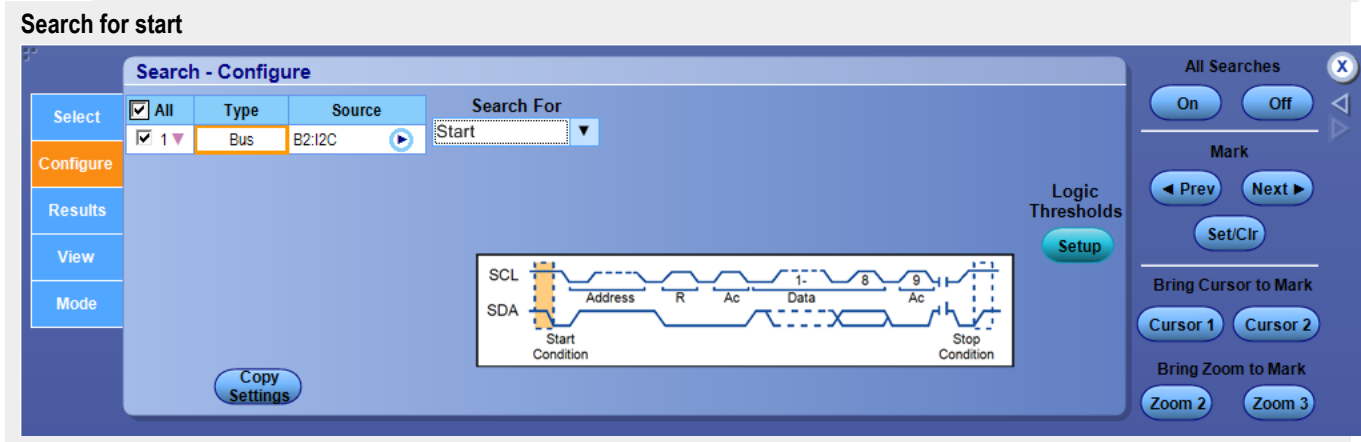

Search for stop

The screenshot shows the 'Search - Configure' dialog with the following settings:

- Select:** All
- Type:** Bus
- Source:** B2:12C
- Search For:** Stop

The waveform diagram shows SCL and SDA signals. A vertical orange bar highlights the 'Stop Condition' at the end of the transaction, which occurs after the 9th data bit. The transaction includes a Start Condition, Address, Read (R), Acknowledge (Ac), Data (1-8), and another Acknowledge (Ac).

On the right side, the 'All Searches' panel has 'On' selected. Below it are 'Mark' buttons (Prev, Next, Set/Clr), 'Bring Cursor to Mark' buttons (Cursor 1, Cursor 2), and 'Bring Zoom to Mark' buttons (Zoom 2, Zoom 3). A 'Logic Thresholds Setup' button is also present.

Search for repeated start

The screenshot shows the 'Search - Configure' dialog with the following settings:

- Select:** All
- Type:** Bus
- Source:** B2:12C
- Search For:** Repeated Start

The waveform diagram shows SCL and SDA signals. A vertical orange bar highlights the 'Repeated Start' condition, which occurs when a Start Condition is detected while the bus is still busy with a previous transaction. The transaction includes a Start Condition, Address, Read (R), Acknowledge (Ac), Data (1-8), and another Acknowledge (Ac).

On the right side, the 'All Searches' panel has 'On' selected. Below it are 'Mark' buttons (Prev, Next, Set/Clr), 'Bring Cursor to Mark' buttons (Cursor 1, Cursor 2), and 'Bring Zoom to Mark' buttons (Zoom 2, Zoom 3). A 'Logic Thresholds Setup' button is also present.

Search for missing ack

The screenshot shows the 'Search - Configure' dialog with the following settings:

- Select:** All
- Type:** Bus
- Source:** B2:12C
- Search For:** Missing ack

The waveform diagram shows SCL and SDA signals. Two vertical orange bars highlight 'Missing ack' conditions. The first occurs after the Read (R) phase, and the second occurs after the 9th data bit. The transaction includes a Start Condition, Address, Read (R), Data (1-8), and another Acknowledge (Ac).

On the right side, the 'All Searches' panel has 'On' selected. Below it are 'Mark' buttons (Prev, Next, Set/Clr), 'Bring Cursor to Mark' buttons (Cursor 1, Cursor 2), and 'Bring Zoom to Mark' buttons (Zoom 2, Zoom 3). A 'Logic Thresholds Setup' button is also present.

Search for address

The address mode options available in Search For Address are Address Format, Address Value, Addressing Mode, Special Address, and Direction.

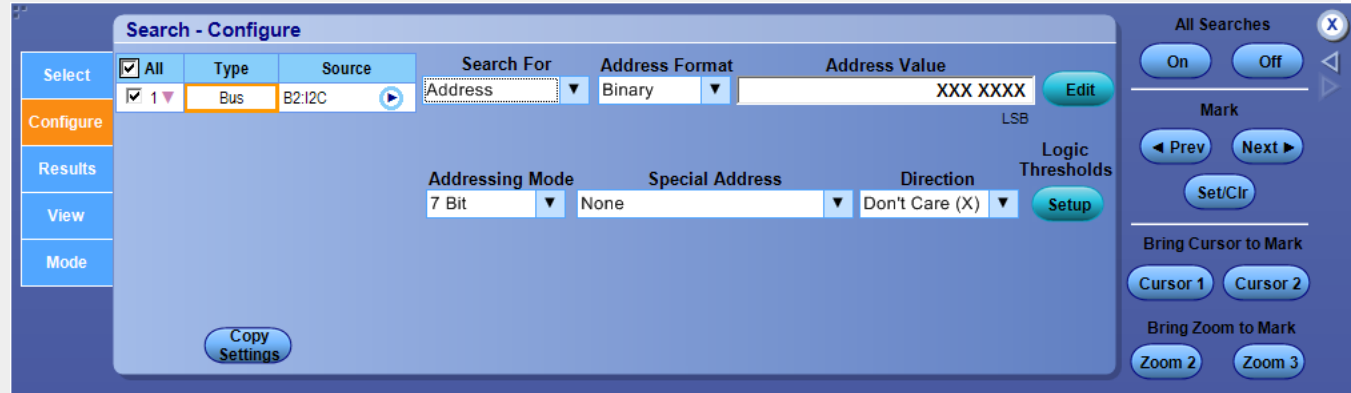

Select the Address Format, Addressing Mode, special Address, and Direction from the drop-down lists. Click Edit to enter the address value. Click Setup to adjust the logic thresholds.

Search for data

The data type options available in Search For Data are Addressing Mode, Number of Bytes, Data Format, and Data Value.

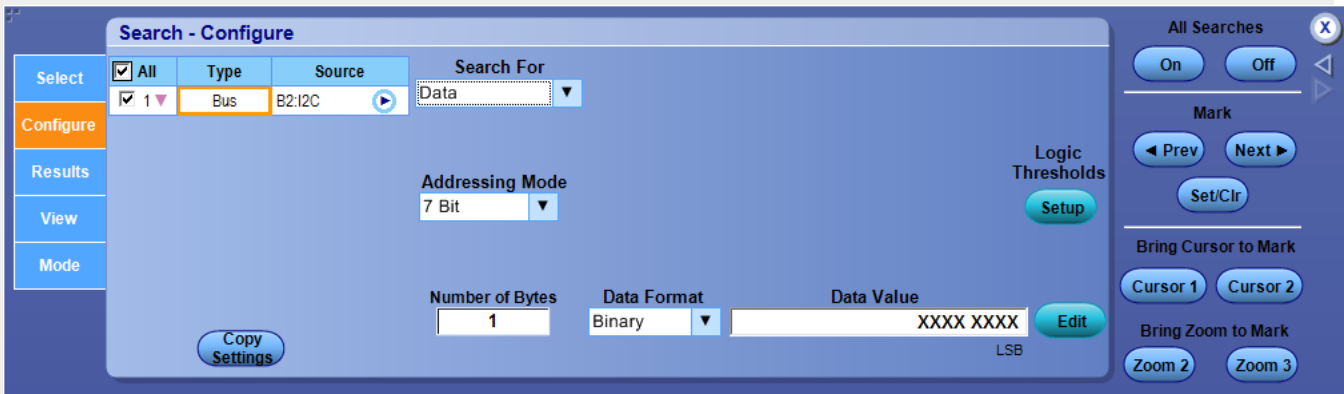

Select the Addressing Mode and Data Format from the drop-down lists. Click Edit to enter the data value. Click Setup to adjust the logic thresholds.

Search for address and data

The address and data mode options available in Search For Address are Address Format, Address Value, Addressing Mode, Special Address, Direction, Number of Bytes, Data Format, and Data Value.

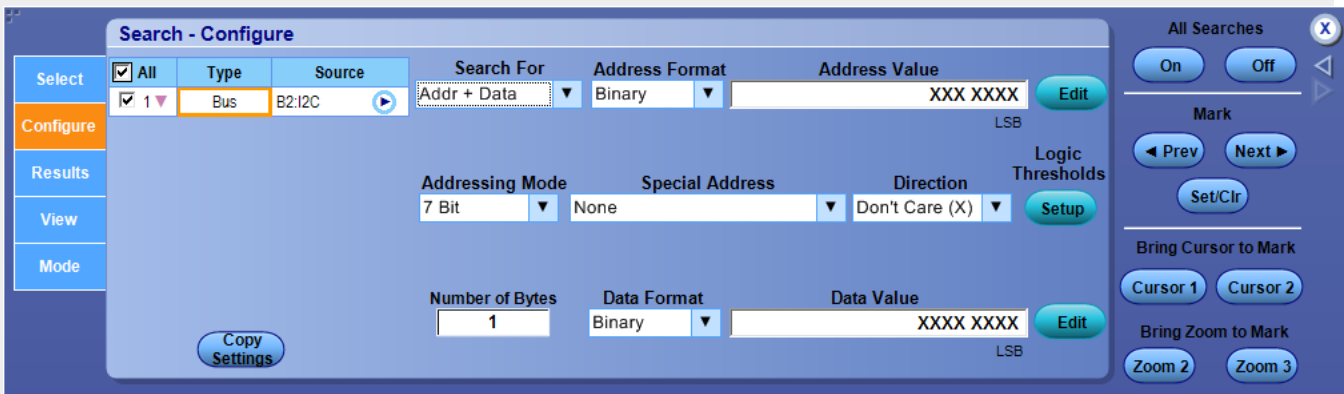

Select the Address Format, Addressing Mode, special Address, Direction, and Data Format from the drop-down lists. Click Edit to enter the address and data values. Click Setup to adjust the logic thresholds.

Set up USB search parameters

After setting up an USB bus, go to the Analyze menu, select Search, and then select the Bus trigger type; then open the Configure tab.

Overview

Use the controls to set up the USB Bus parameters.

To use

For information on the controls, click the buttons.

- [Type](#)
- [Source](#)
- [Copy Settings](#)
- [Search Parameters](#)
- [Search / Mark Controls](#)

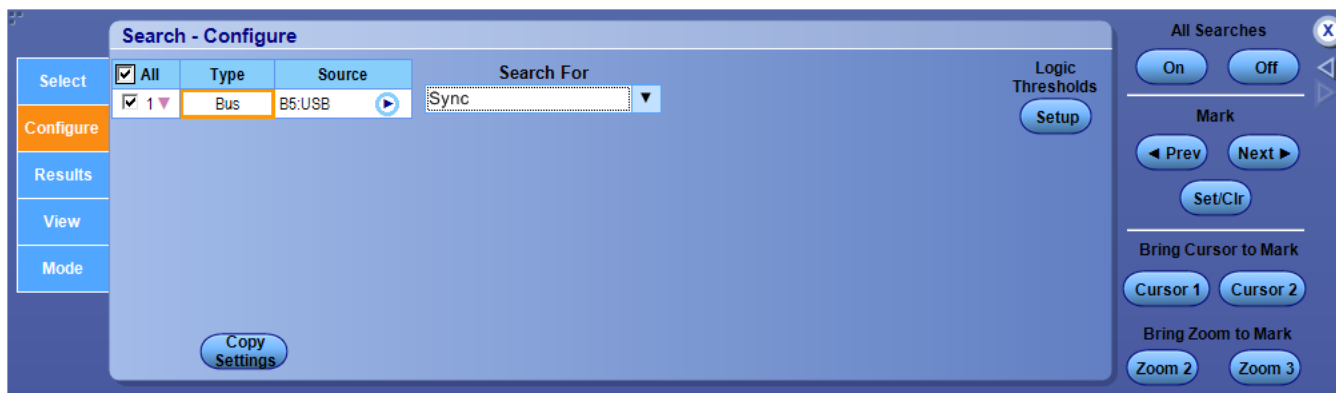

Behavior

Clicking an entry in the Type column activates the individual search controls, similar to the one shown above. These controls vary depending on the search Type. Setting the search conditions is similar to setting the parameters for an [Event Trigger](#).

NOTE. No information will be displayed in this window until you specify at least one search Type in the [Search Select Control Window](#).

To use

- Click the Source box and select the bus number or name from the window. [Bus Search Selection List](#)
- Select the type of bus cycle or activity to search for from the Search For drop-down list.

- For some Search For selections, you must set additional fields to define other parameters such as for a Error.
In this example, you need to set an Error Type. Optionally, you can also set the component threshold levels through the Logic Thresholds Setup button.

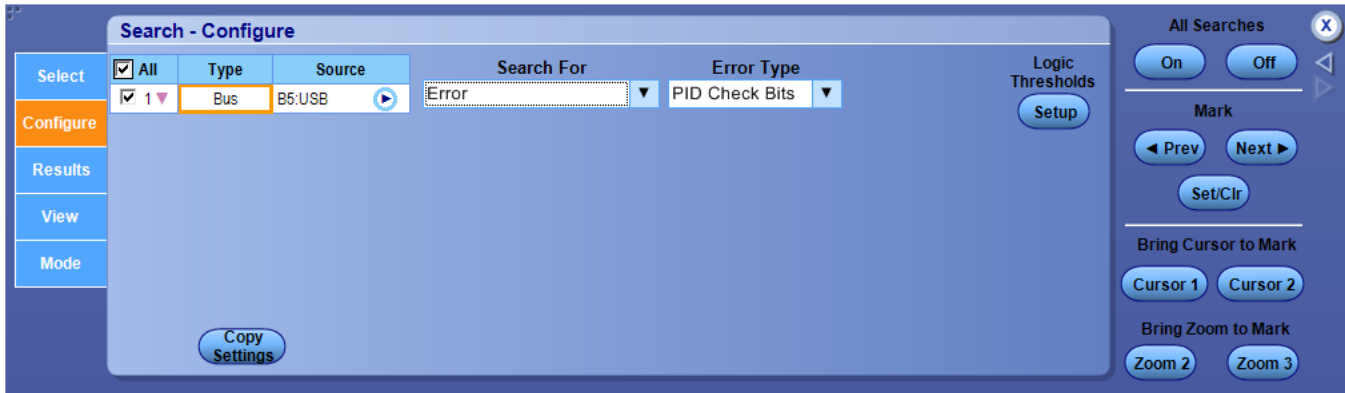

Click the Search For selections Sync, Reset, Suspend, Resume, End of Packet, Token (Address) Packet, Data Packet, Handshake Packet, Special Packet, or Error to view their parameters.

What do you want to do next?

[Learn about bus setups.](#)

Search for sync

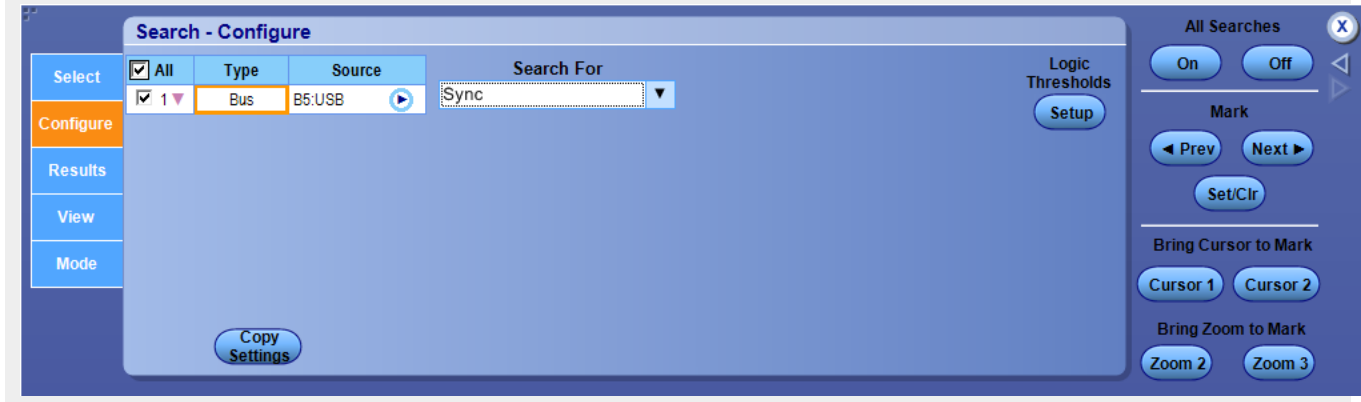

Search for reset

The screenshot shows the 'Search - Configure' dialog box. On the left is a vertical menu with 'Configure' selected. The dialog has a table with columns 'All', 'Type', and 'Source'. The 'All' column has a checked box and a dropdown showing '1'. The 'Type' column has 'Bus' selected. The 'Source' column has 'B5:USB' selected. To the right of the table is a 'Search For' dropdown menu with 'Reset' selected. Below the table is a 'Copy Settings' button. On the right side of the dialog, there is a 'Logic Thresholds' section with a 'Setup' button. Further right is a control panel with 'All Searches' (On/Off), 'Mark' (Prev/Next/Set/Clr), 'Bring Cursor to Mark' (Cursor 1/Cursor 2), and 'Bring Zoom to Mark' (Zoom 2/Zoom 3) buttons.

Search for suspend

The screenshot shows the 'Search - Configure' dialog box. The 'Search For' dropdown menu is now set to 'Suspend'. All other elements, including the table, 'Copy Settings' button, and right-side control panel, remain the same as in the previous screenshot.

Search for resume

The screenshot shows the 'Search - Configure' dialog box. The 'Search For' dropdown menu is now set to 'Resume'. All other elements, including the table, 'Copy Settings' button, and right-side control panel, remain the same as in the previous screenshots.

Search for end of packet

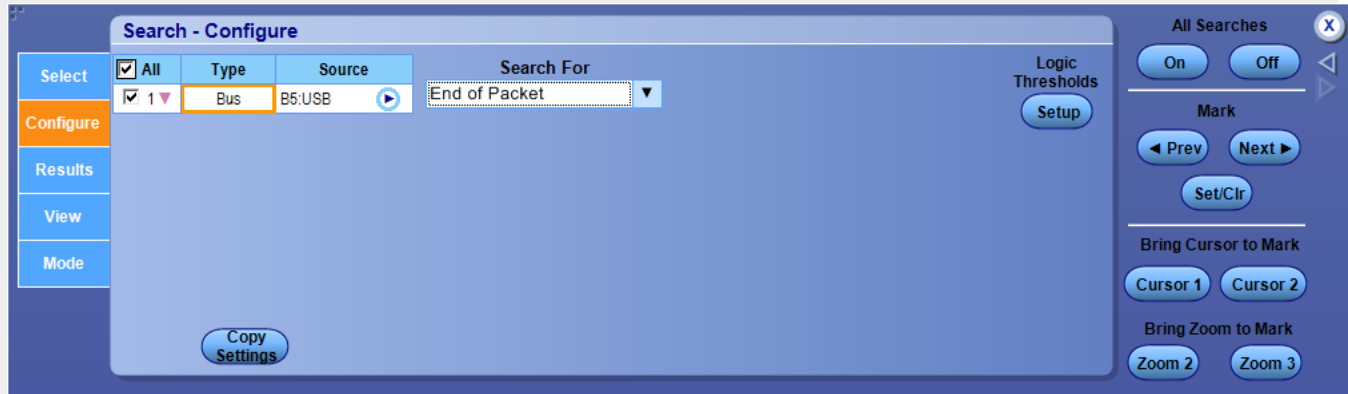

Search for token (address) packet

The token address packet mode options available in Search For Token (Address) Packet are Token Type, Address Format, Address, Endpoint Format, and Endpoint.

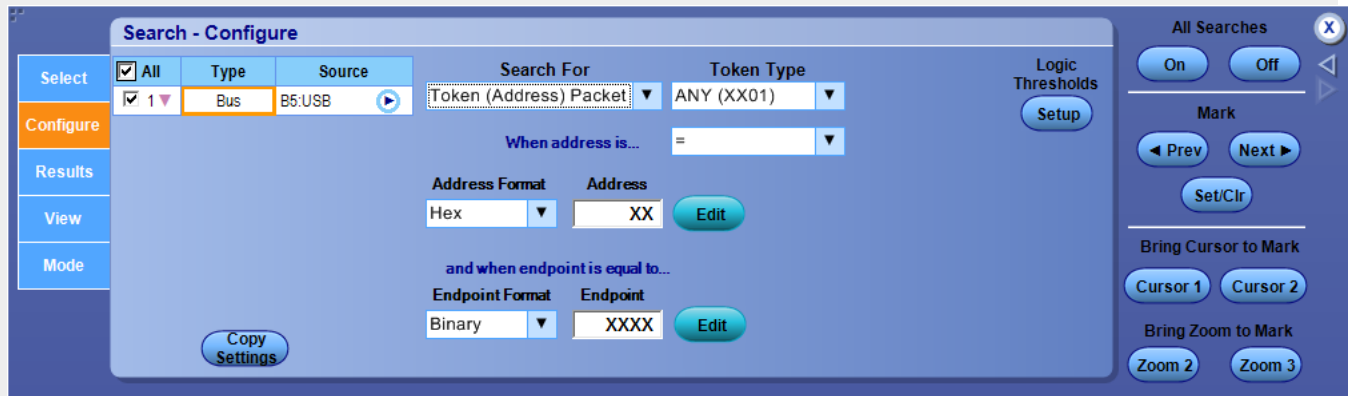

Select the Token Type, Address Format, When address is, and Endpoint Format from the drop-down lists. Click Edit to enter the address and endpoint values. Click Setup to adjust the logic thresholds.

Search for data packet

The data packet options available in Search For Data Packet are Data Packet Type, When data packet is. Number of Bytes, Data Format, Offset, and Data Value.

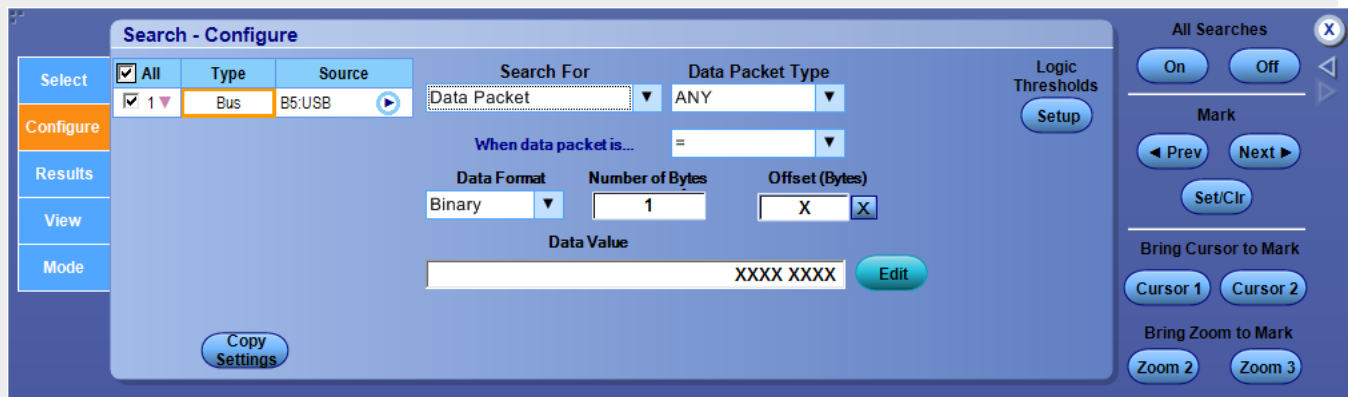

Select the Data Packet Type, When data packet is, Data Format, and Offset from the drop-down lists. Click Edit to enter the data value. Click Setup to adjust the logic thresholds.

Search for handshake packet

The handshake packet option available in Search For Handshake Packet is Handshake Type.

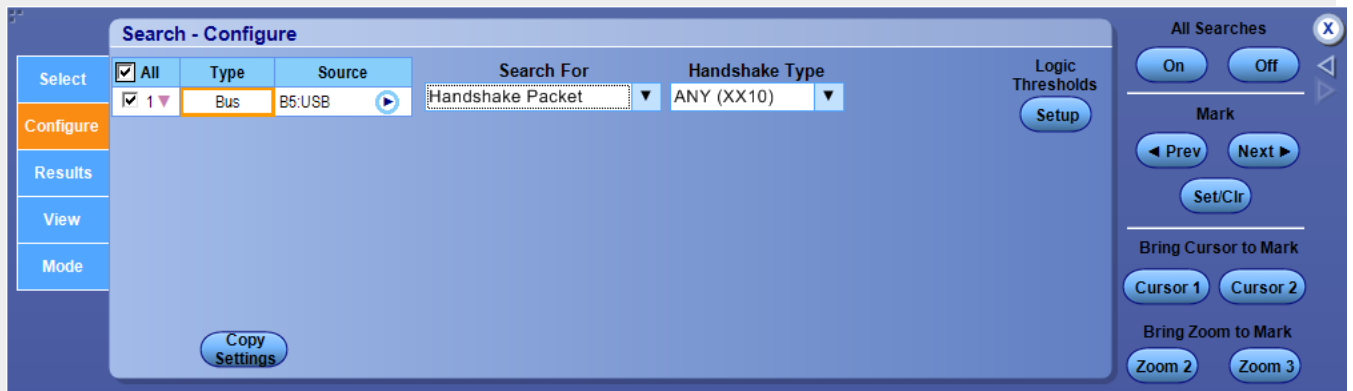

Select the Handshake Type from the drop-down list. Click Setup to adjust the logic thresholds.

Search for special packet

The special packet option available in Search For Special Packet is Special Type.

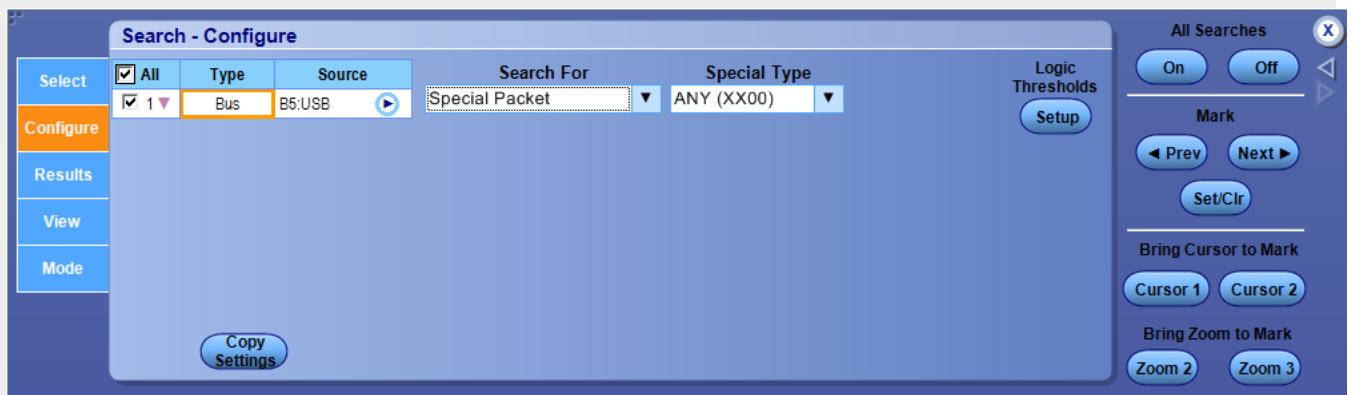

Select the Special Type from the drop-down list. Click Setup to adjust the logic thresholds.

Search for error

The Error option available in Search For Error is Error Type.

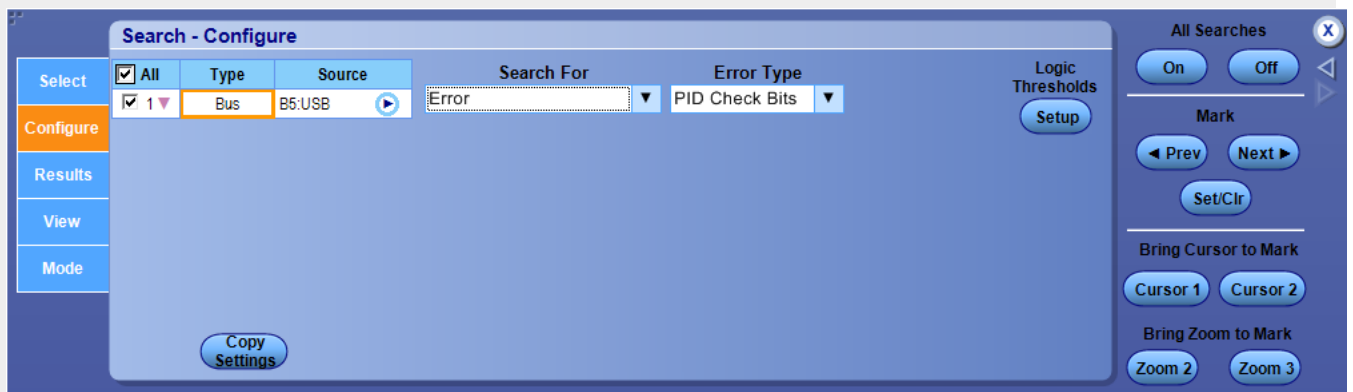

Select the Error Type from the drop-down list. Click Setup to adjust the logic thresholds.

Search for pattern

The options available in Search For Pattern are Character, Symbols RD+, Symbols RD-, and Disparity.

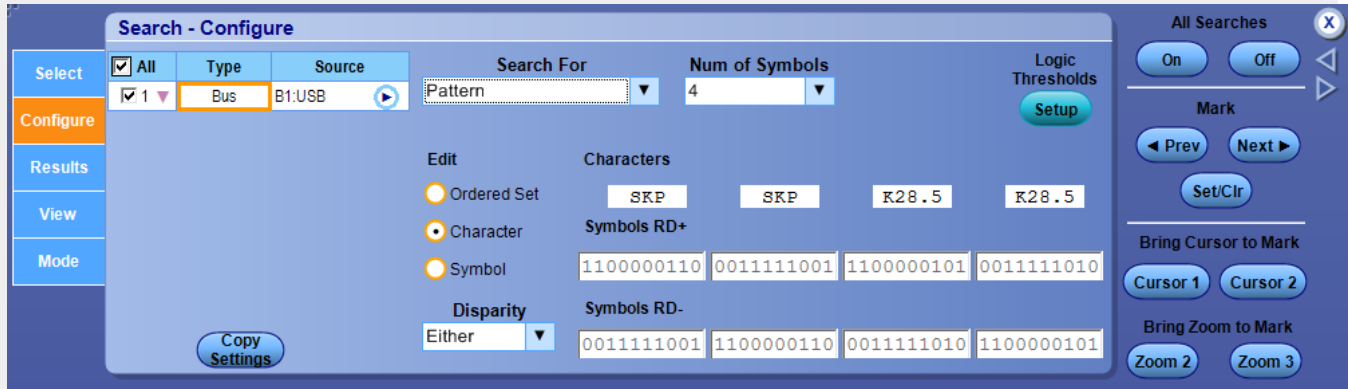

Select the Character, Symbols RD+, Symbols RD-, and Disparity

Search for character/symbol

The options available in Search For Character/Symbol are Character, Symbol RD+, Symbol RD-, and Disparity..

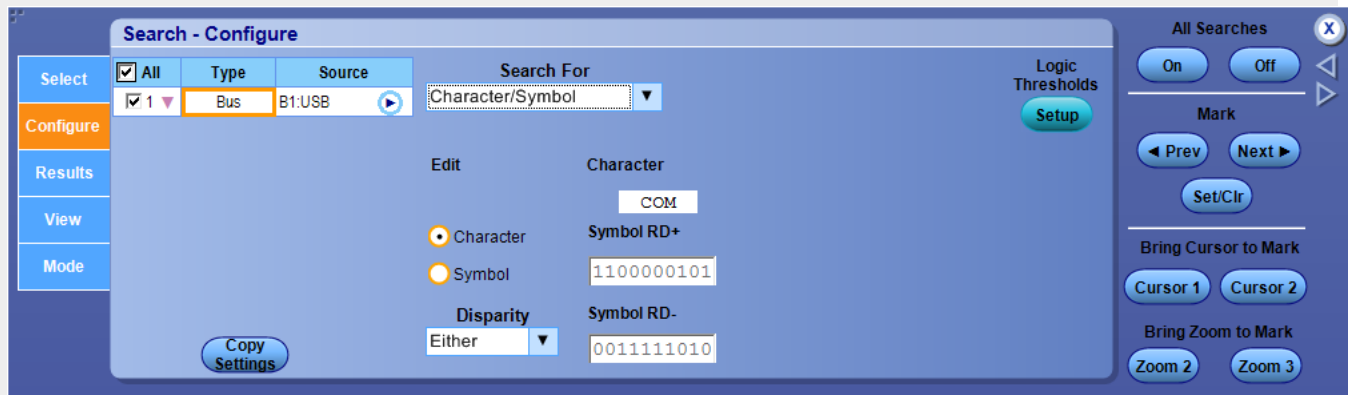

Select the Character, Symbol RD+, Symbol RD-, and Disparity.

Search for long ordered set

The options available in Search For Long Ordered Set are types of ordered sets.

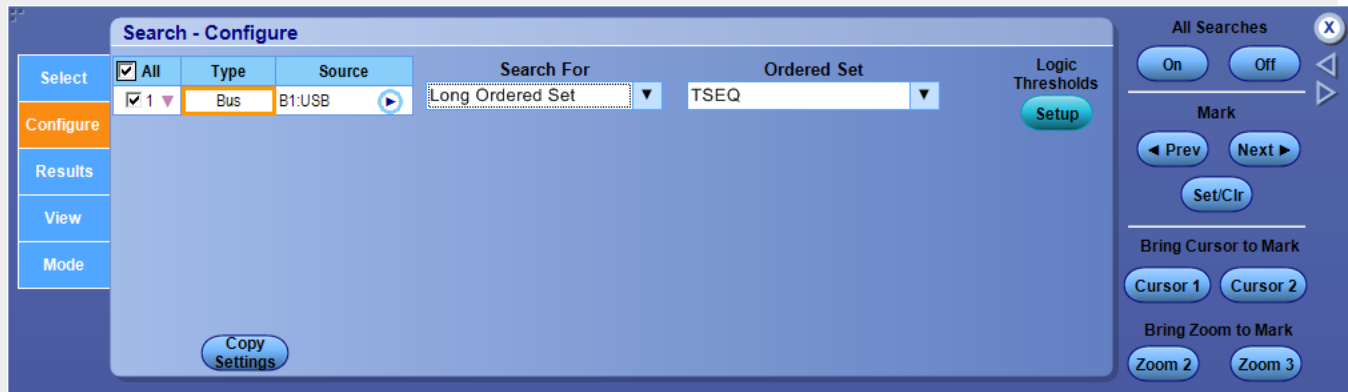

Select the ordered set.

Search for packets

The data packet options available in Search For Packets are types of Packets.

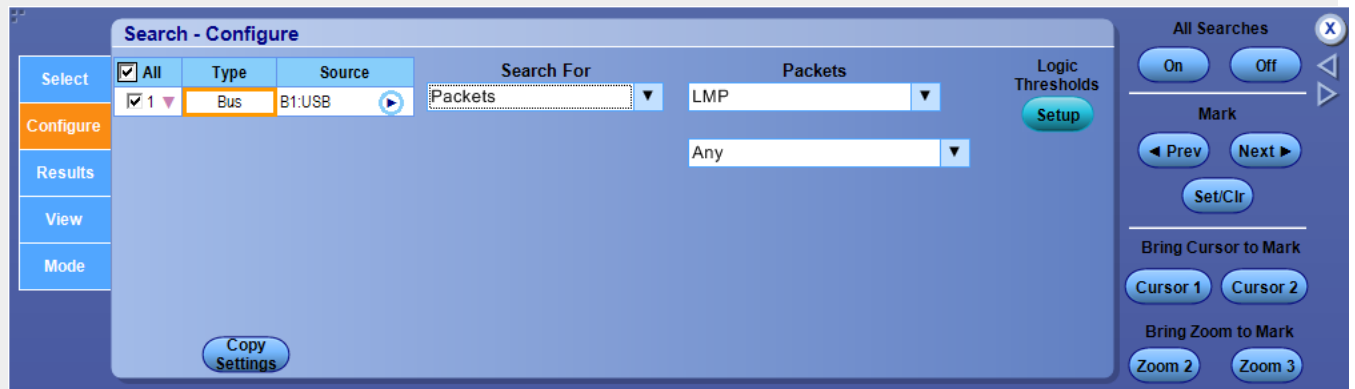

Select the packet types.

Search for LFPS

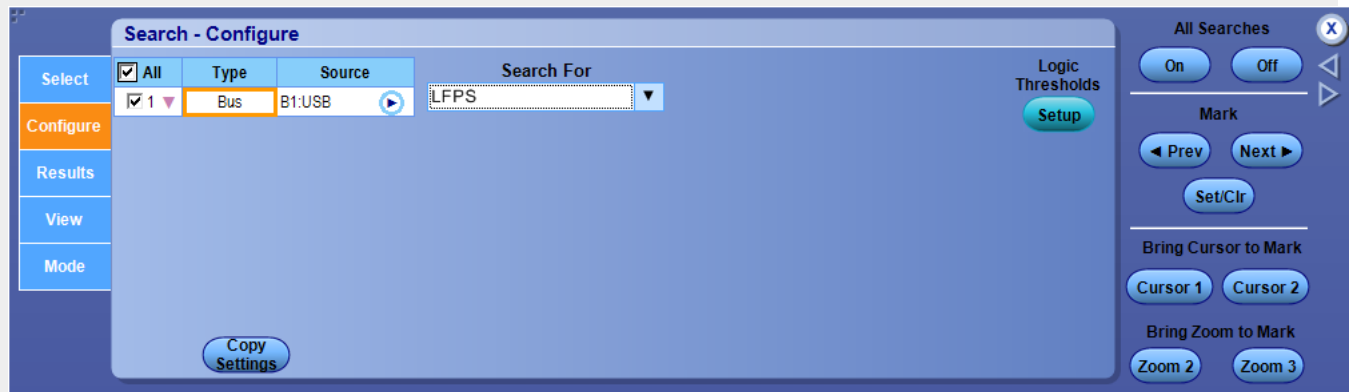

Search for any control character

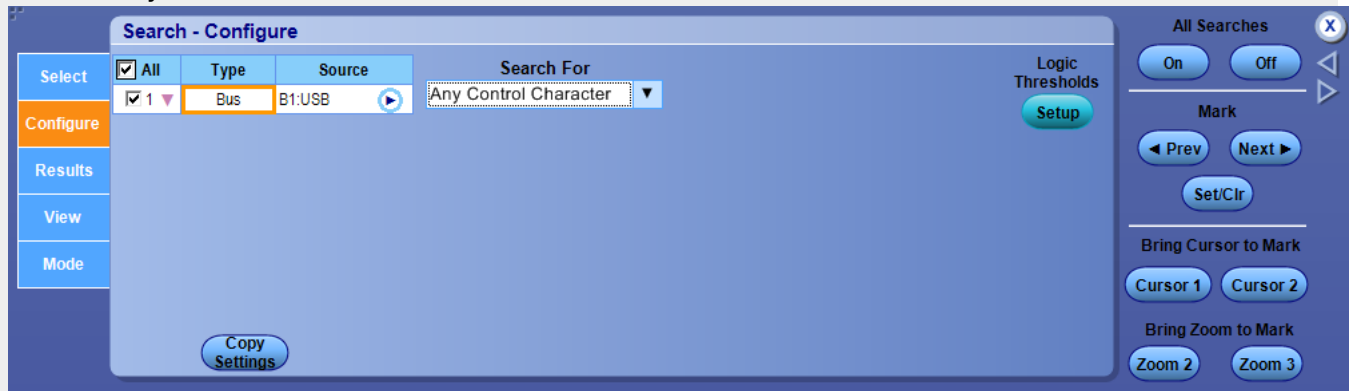

Set up MIPI search parameters

After setting up a MIPI bus, go to the Analyze menu, select Search, and then select the Bus trigger type; then open the Configure tab.

Overview

Use the controls to set up the MIPI Bus parameters.

To use

For information on the controls, click the buttons.

- [Type](#)
- [Source](#)
- [Copy Settings](#)
- [Search Parameters](#)
- [Search / Mark Controls](#)

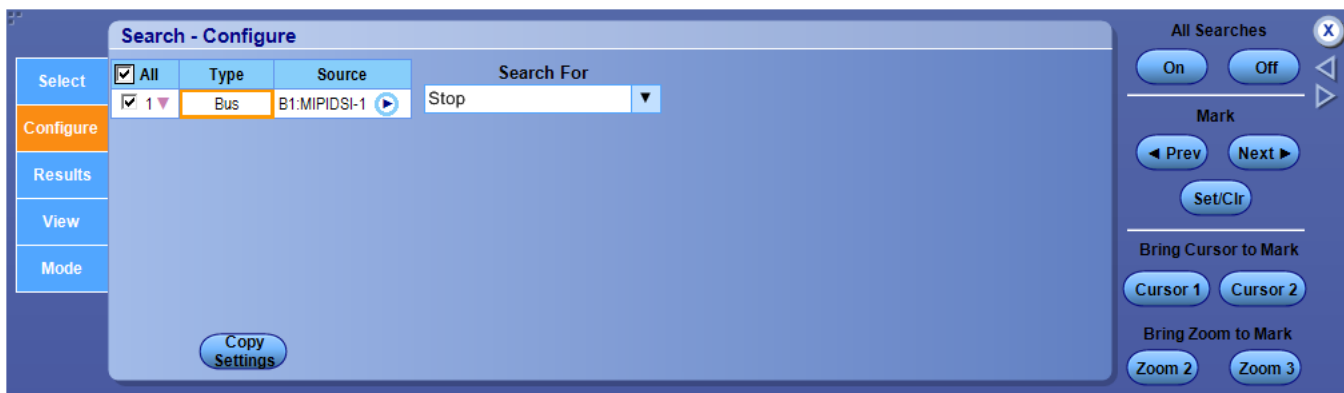

Behavior

Clicking an entry in the Type column activates the individual search controls, similar to the one shown above. These controls vary depending on the search Type. Setting the search conditions is similar to setting the parameters for an [Event Trigger](#).

NOTE. No information will be displayed in this window until you specify at least one search Type in the [Search Select Control Window](#).

To use

- Click the Source box and select the bus number or name from the drop-down list.
- Select the type of bus cycle or activity to search for from the Search For drop-down list.

- For some Search For selections, you must set additional fields to define other parameters such as for a Long Packet.

In this example, you need to set a Data Type Value, Virtual Channel, Direction, Word Count, Number of Bytes, Payload Format, Payload Value, and Byte Offset (click the [Edit](#) button). Optionally, you can also set the component threshold levels through the Logic Thresholds Setup button.

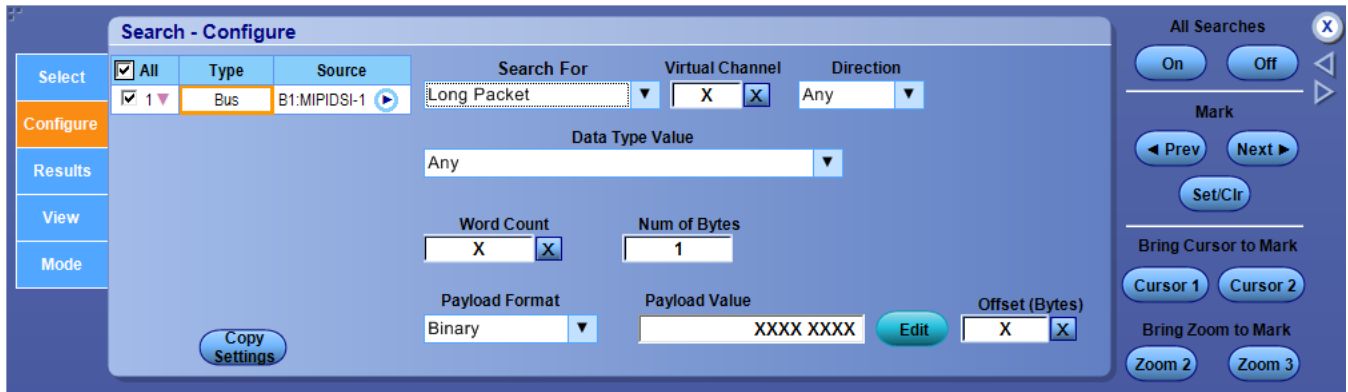

Click the Search For selections Stop, Start of Transmission, End of Transmission, Bus Turn Around, Escape Mode, Warning, Error, Short Packet, or Long Packet to view their parameters.

What do you want to do next?

[Learn about bus setups.](#)

Search for stop

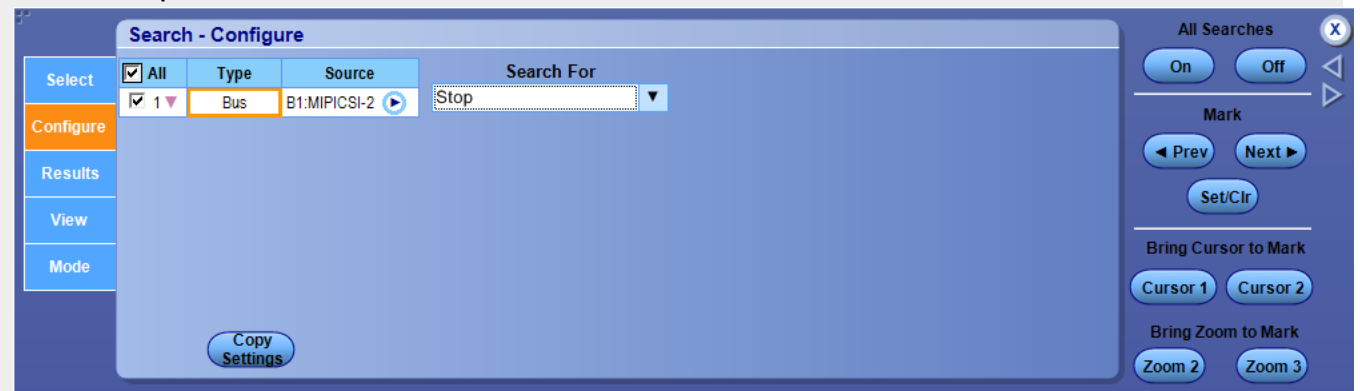

Search for start of transmission

The screenshot shows the 'Search - Configure' dialog box. On the left, there is a vertical menu with 'Configure' selected. The main area contains a table with columns 'All', 'Type', and 'Source'. The 'All' column has a checked checkbox and a dropdown showing '1'. The 'Type' column has 'Bus' selected. The 'Source' column has 'B1:MIPICSI-2' selected. To the right of the table is a 'Search For' dropdown menu set to 'Start of Transmission'. Below the table is a 'Copy Settings' button. On the right side of the dialog, there is a control panel with 'All Searches' (On/Off), 'Mark' (Prev/Next/Set/Clr), 'Bring Cursor to Mark' (Cursor 1/Cursor 2), and 'Bring Zoom to Mark' (Zoom 2/Zoom 3) buttons.

Search for end of transmission

The screenshot shows the 'Search - Configure' dialog box. The 'Search For' dropdown menu is set to 'End of Transmission'. All other settings, including the table and control panel, are identical to the previous screenshot.

Search for bus turn around

The screenshot shows the 'Search - Configure' dialog box. The 'All' column has a checked checkbox and a dropdown showing '2'. The 'Source' column has 'B2:MIPIDSI-1' selected. The 'Search For' dropdown menu is set to 'Bus Turn Around'. All other settings, including the table and control panel, are identical to the previous screenshots.

Search for escape mode

The escape mode command options available in Search For Escape Mode are as follows:

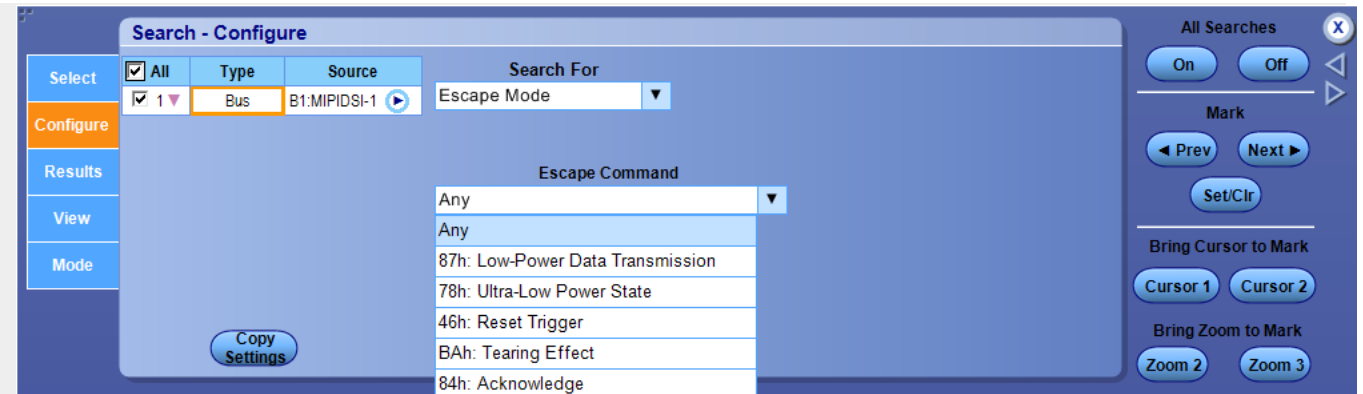

Search for warning

The warning type options available in Search For Warning are as follows:

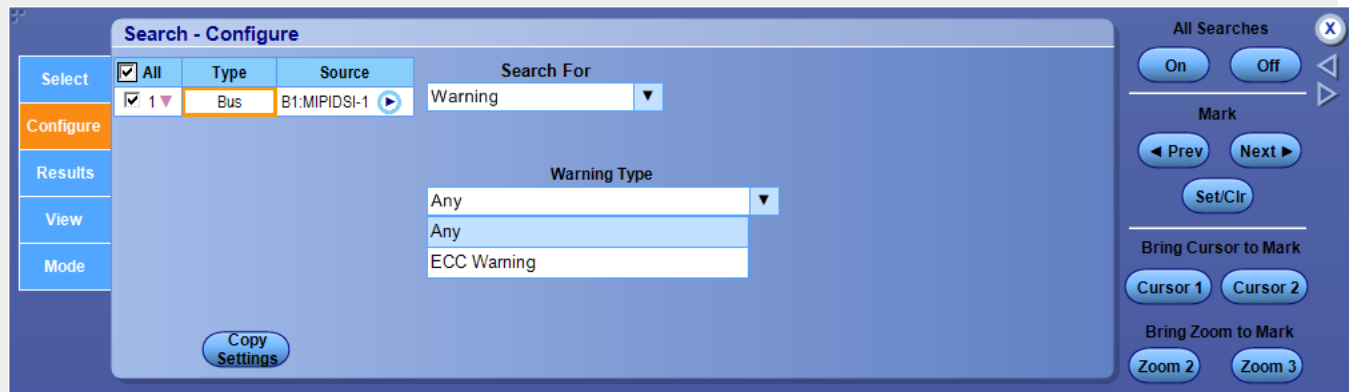

Search for error

The error type options available in Search For Error Type are as follows:

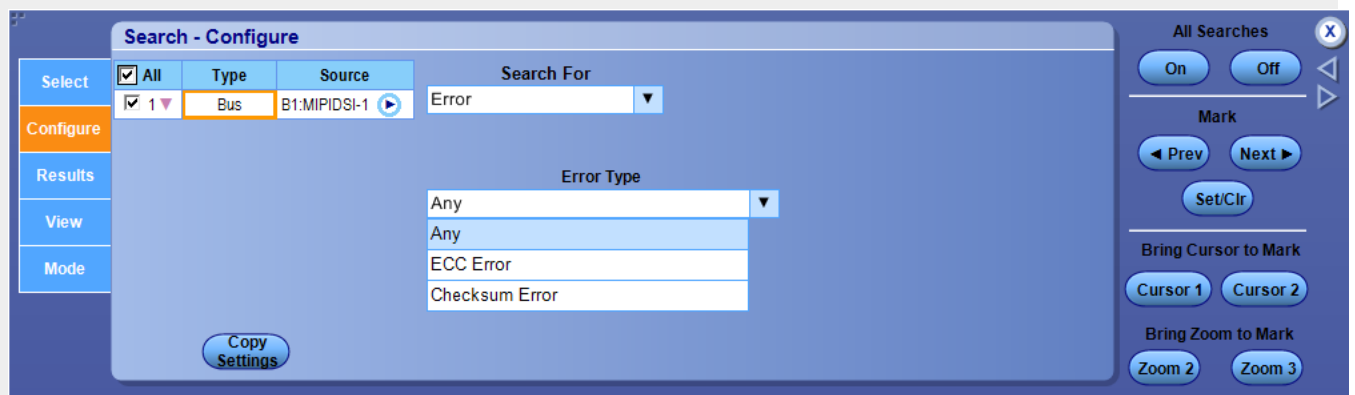

Search for short packet

The data type options available in Search On Short Packet are as follows:

| |
|-----------------------------|
| Any |
| 00h: Frame Start |
| 01h: Frame End |
| 02h: Line Start |
| 03h: Line End |
| 08h: Generic Short Packet 1 |
| 09h: Generic Short Packet 2 |
| 0Ah: Generic Short Packet 3 |
| 0Bh: Generic Short Packet 4 |
| 0Ch: Generic Short Packet 5 |
| 0Dh: Generic Short Packet 6 |
| 0Eh: Generic Short Packet 7 |
| 0Fh: Generic Short Packet 8 |
| Any |

The Search For Short Packet window allows you set the Virtual Channel, Direction, Packet Data Format, and the [Packet Data Value](#) .

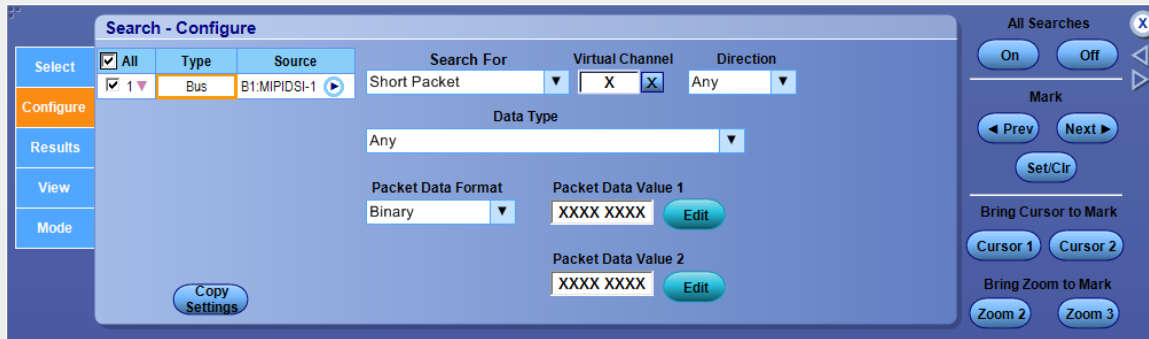

Search for long packet

The data type value options available in Search For Long Packet are as follows:

| MIPI CSI-2 | MIPI DSI-1 |
|--|--|
| Any | Any |
| 10h: Null | 09h: Null |
| 11h: Blanking | 19h: Blanking |
| 12h: Embedded | 29h: Generic Long Write |
| 18h: YUV420 8-bit | 39h: DCS Long Write |
| 19h: YUV420 10-bit | 0Eh: Packed Pixel Stream 16-bit RGB, 5-6-5 |
| 1Ah: YUV420 8-bit (Legacy) | 1Eh: Packed Pixel Stream 18-bit RGB, 6-6-6 |
| 1Ch: YUV420 8-bit (Chroma Shifted Pixel Sampling) | 2Eh: Loosely Packed Pixel Stream 18-bit RGB, 6-6-6 |
| 1Dh: YUV420 10-bit (Chroma Shifted Pixel Sampling) | 3Eh: Packed Pixel Stream 24-bit RGB, 8-8-8 |
| 1Eh: YUV422 8-bit | 0Dh: Packed Pixel Stream 30-bit RGB, 10-10-10 |
| 1Fh: YUV422 10-bit | 1Dh: Packed Pixel Stream 36-bit RGB, 12-12-12 |
| 20h: RGB444 | 0Ch: Loosely Packed Pixel Stream 20-bit YCbCr, 4:2:2 |
| 21h: RGB555 | 1Ch: Packed Pixel Stream 24-bit YCbCr, 4:2:2 |
| 22h: RGB565 | 2Ch: Packed Pixel Stream 16-bit YCbCr, 4:2:2 |
| 23h: RGB666 | 3Dh: Packed Pixel Stream 12-bit YCbCr, 4:2:0 |
| 24h: RGB888 | 1Ah: Generic Long Read Response |
| 28h: RAW6 | 1Ch: DCS Long Read Response |
| 29h: RAW7 | Any |
| 2Ah: RAW8 | |
| 2Bh: RAW10 | |
| 2Ch: RAW12 | |
| 2Dh: RAW14 | |
| 30h: User 8-bit 1 | |
| 31h: User 8-bit 2 | |
| 32h: User 8-bit 3 | |
| 33h: User 8-bit 4 | |
| 34h: User 8-bit 5 | |
| 35h: User 8-bit 6 | |
| 36h: User 8-bit 7 | |
| 37h: User 8-bit 8 | |

The Search For Long Packet window allows you to set the Virtual Channel, Direction, Data Type Value, Word Count, Number of Bytes, Payload Format, Offset in bytes, and *Payload Value*.

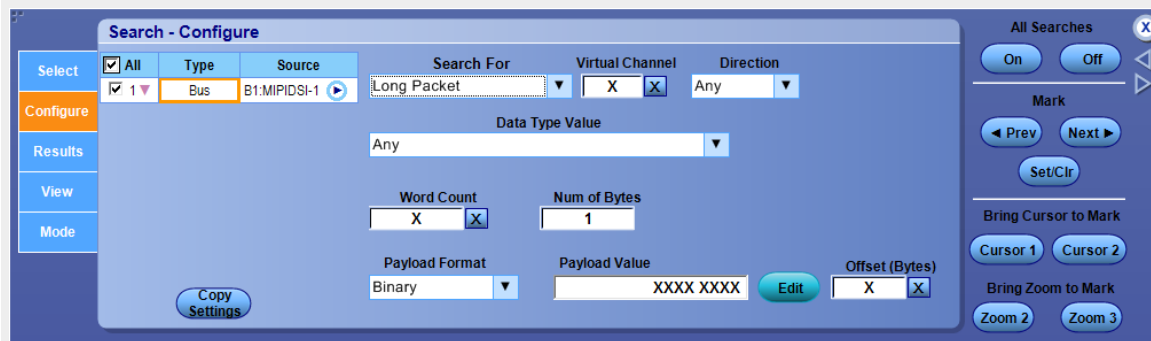

Set up PCIe search parameters

After setting up a PCIe bus, go to the Analyze menu, select Search, and then select the Bus trigger type; then open the Configure tab.

Overview

Use the controls to set up the PCIe Bus parameters.

To use

For information on the controls, click the buttons.

- [Type](#)
- [Source](#)
- [Copy Settings](#)
- [Search Parameters](#)
- [Search / Mark Controls](#)

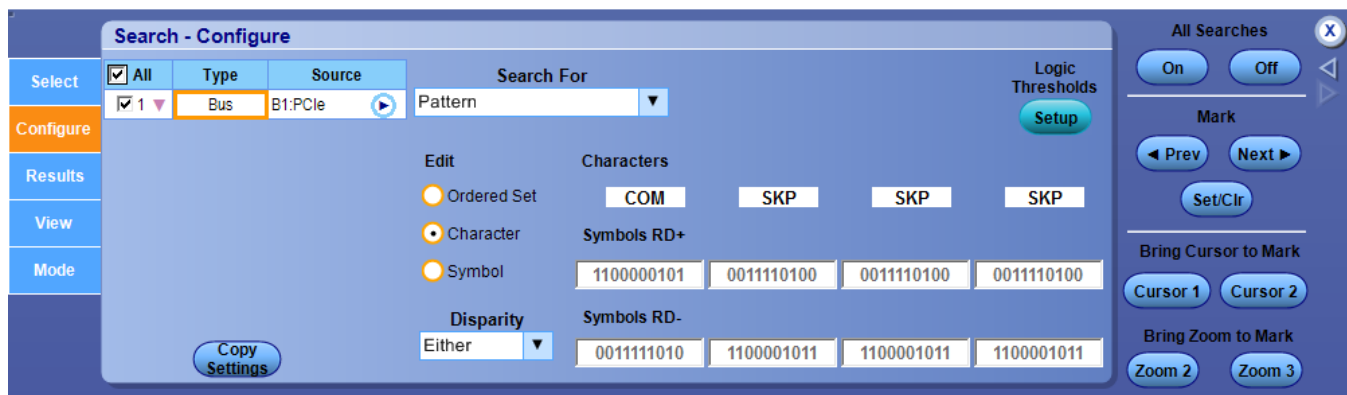

Behavior

Clicking an entry in the Type column activates the individual search controls, similar to the one shown above. These controls vary depending on the search Type. Setting the search conditions is similar to setting the parameters for an [Event Trigger](#).

NOTE. No information will be displayed in this window until you specify at least one search Type in the [Search Select Control Window](#).

To use

- Click the Source box and select the bus number or name from the window. [Bus Search Selection List](#)
- Select the type of bus cycle or activity to search for from the Search For drop-down list.

- For some Search For selections, you must set additional fields to define other parameters such as for Character/Symbol. In this example, you need to set a Character, Symbol, and Disparity.

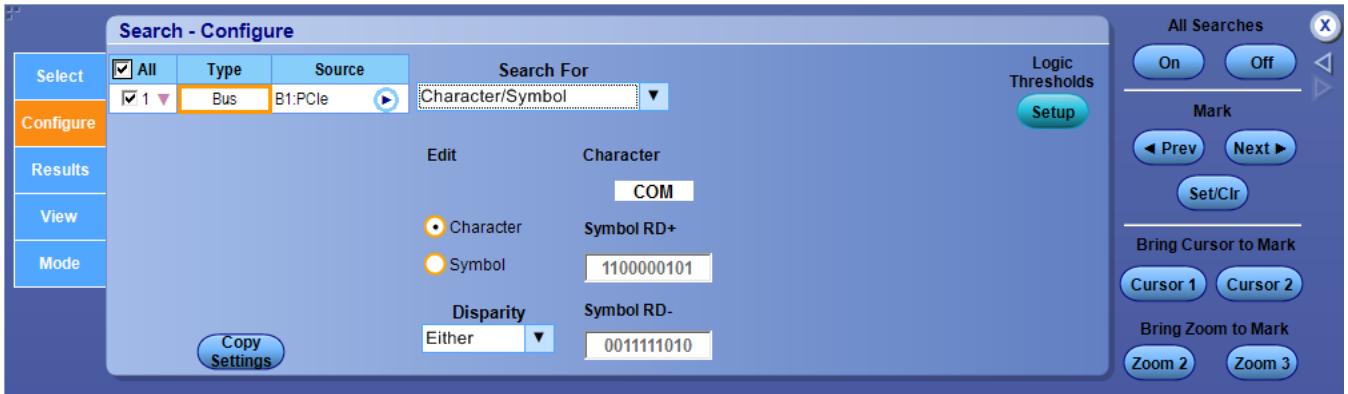

Click the Search For selections Long Ordered Set, Any Control Character, , or Error, to view their parameters.

What do you want to do next?

[Bus setup control window \(Config tab\) on page 107](#)

Search for long ordered set

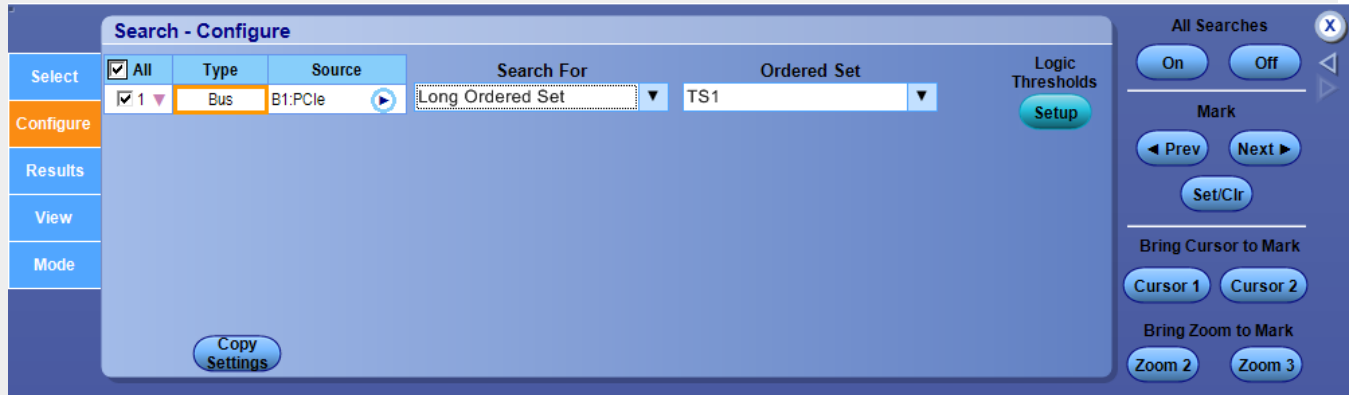

Search for any control character

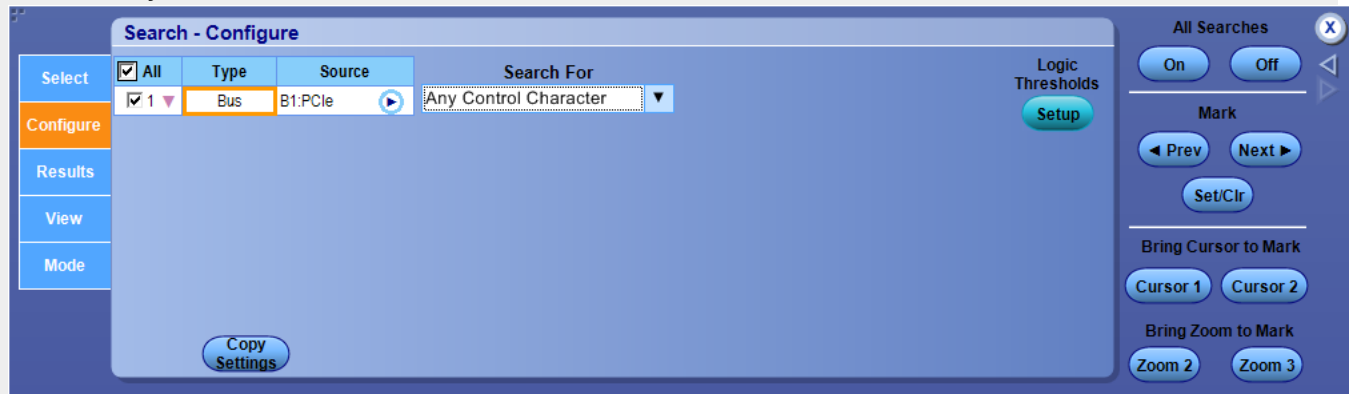

Select the Ordered Set from the drop-down list.

Search for sync header

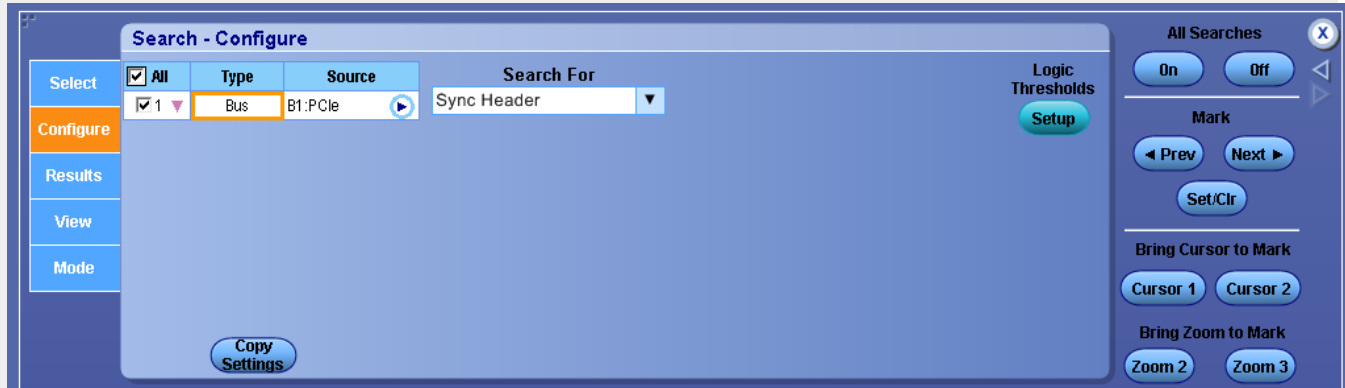

Select the Sync Header from the drop-down list.

Search for error

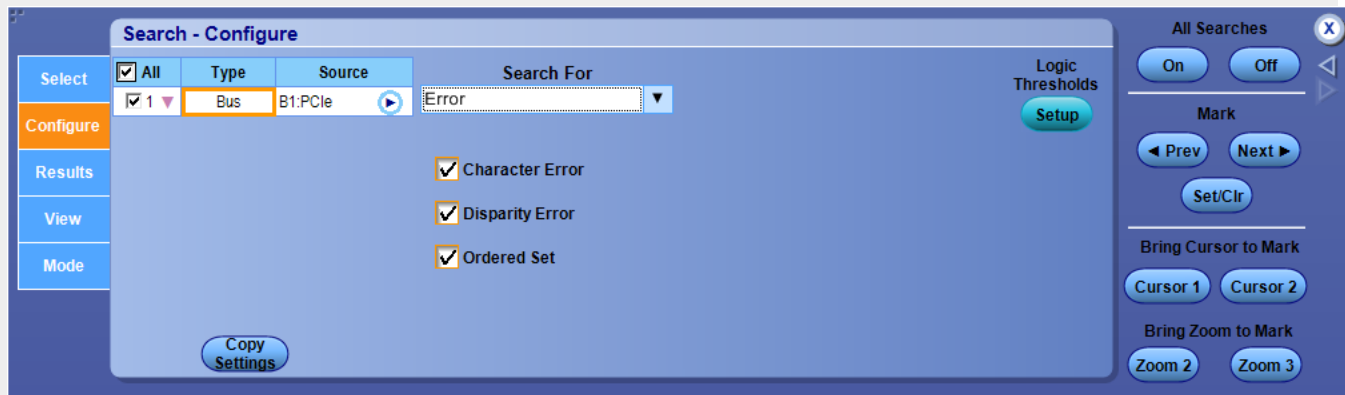

The following searches are applicable for PCIe Gen3 (data rate 8 Gb/s) and Gen4 (data rate 16 Gb/s): Sync Header, Long Ordered Sets, and Error.

Set up CAN search parameters

After setting up a CAN bus, go to the Analyze menu, select Search, and then select the Bus trigger type; then open the Configure tab.

Overview

Use the controls to set up the CAN Bus parameters.

To use

For information on the controls, click the buttons.

- [Type](#)
- [Source](#)
- [Copy Settings](#)
- [Search Parameters](#)
- [Search / Mark Controls](#)

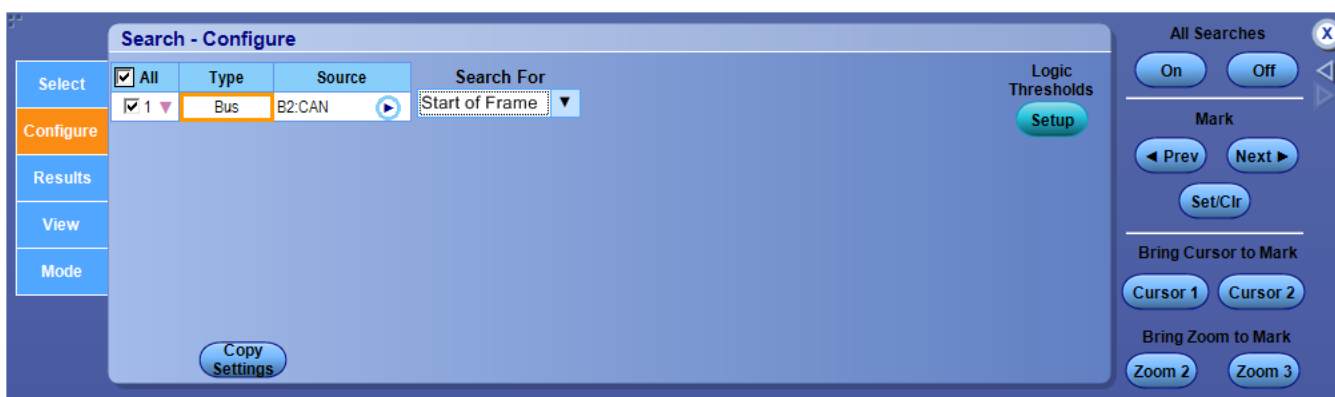

Behavior

Clicking an entry in the Type column activates the individual search controls, similar to the one shown above. These controls vary depending on the search Type. Setting the search conditions is similar to setting the parameters for an [Event Trigger](#).

NOTE. No information will be displayed in this window until you specify at least one search Type in the [Search Select Control Window](#).

To use

- Click the Source box and select the bus number or name from the window. [Bus Search Selection List](#)
- Select the type of bus cycle or activity to search for from the Search For drop-down list.

- For some Search For selections, you must set additional fields to define other parameters such as for Ident & Data. In this example, you need to set an Identifier, Direction, Data is, and Data value (click the *Edit* button). Optionally, you can also set the component threshold levels through the Logic Thresholds Setup button.

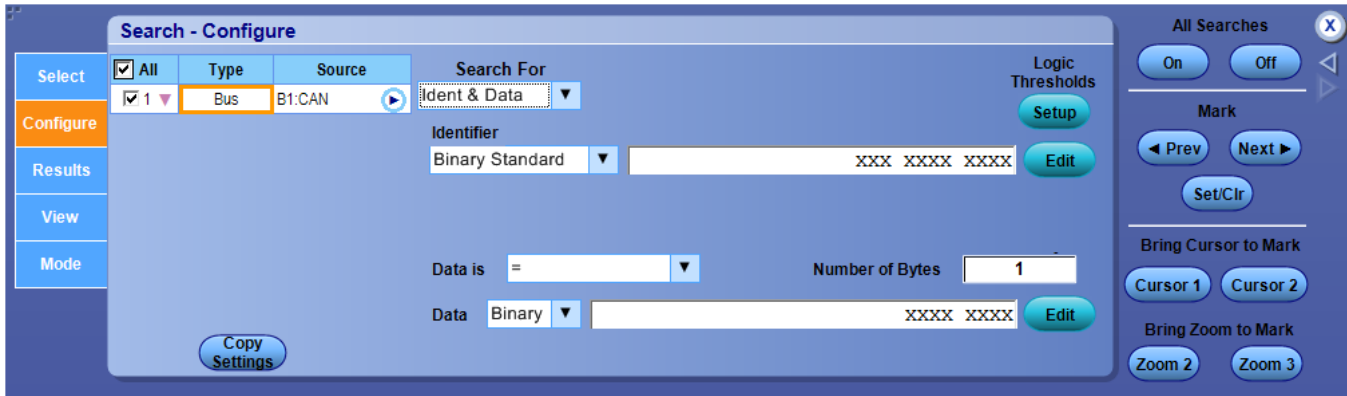

Click the Search For selections Frame, Identifier, Data, End of Frame, Missing ack, or Bit Stuff Error, to view their parameters. What do you want to do next?

[Learn about bus setups.](#)

Search for frame

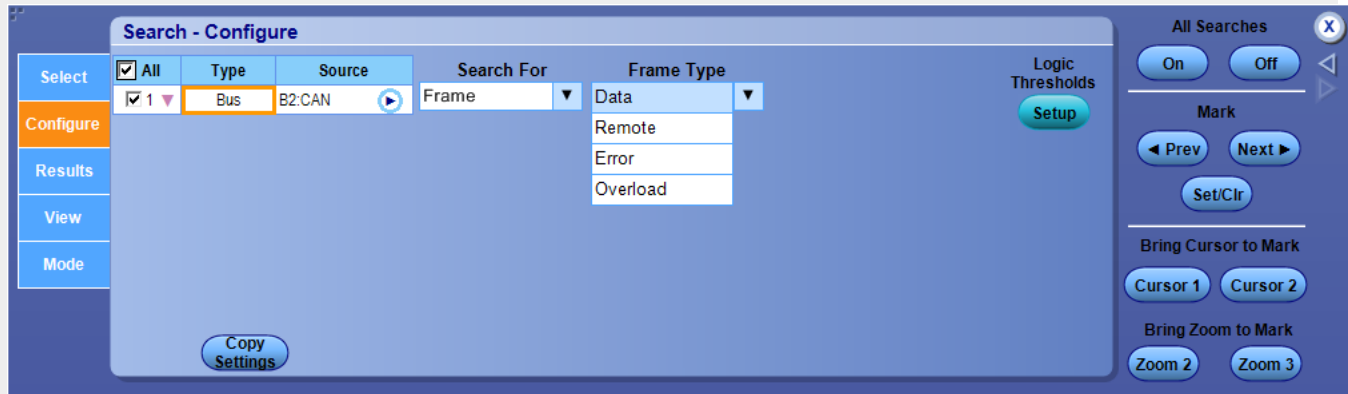

Search for identifier

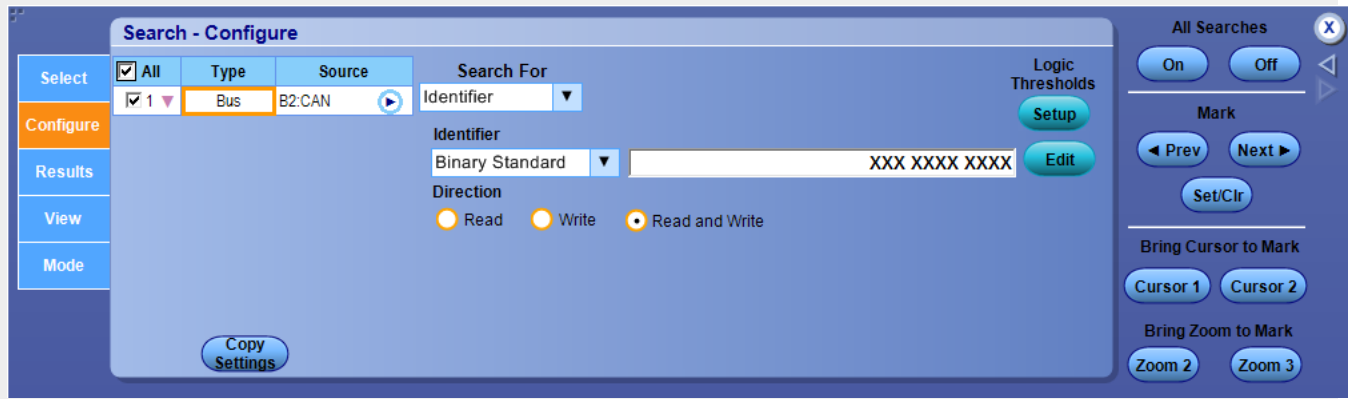

Search for data

The data type options available in Search For Data are Number of Bytes, Data, and Data is.

The screenshot shows the 'Search - Configure' dialog box. On the left is a vertical menu with 'Configure' selected. The main area has a table with columns 'All', 'Type', and 'Source'. The 'All' column has a checked box and a dropdown with '1'. The 'Type' column has 'Bus' selected. The 'Source' column has 'B2:CAN' and a play button. To the right is a 'Search For' dropdown set to 'Data'. Below this are fields for 'Data is' (set to '=') and 'Number of Bytes' (set to '1'). A 'Data' field contains 'Binary' and 'XXXX XXXX' with an 'Edit' button. A 'Copy Settings' button is at the bottom left. On the right side, there are controls for 'All Searches' (On/Off), 'Mark' (Prev/Next/Set/Clr), 'Bring Cursor to Mark' (Cursor 1/Cursor 2), and 'Bring Zoom to Mark' (Zoom 2/Zoom 3).

Search for end of frame

The screenshot shows the 'Search - Configure' dialog box. The 'Search For' dropdown is set to 'End Of Frame'. The 'Data' field is empty. All other elements, including the table, 'Data is' field, 'Number of Bytes' field, and right-side navigation controls, are identical to the previous screenshot.

Search for missing ack

The screenshot shows the 'Search - Configure' dialog box. The 'Search For' dropdown is set to 'Missing ack'. The 'Data' field is empty. All other elements, including the table, 'Data is' field, 'Number of Bytes' field, and right-side navigation controls, are identical to the previous screenshots.

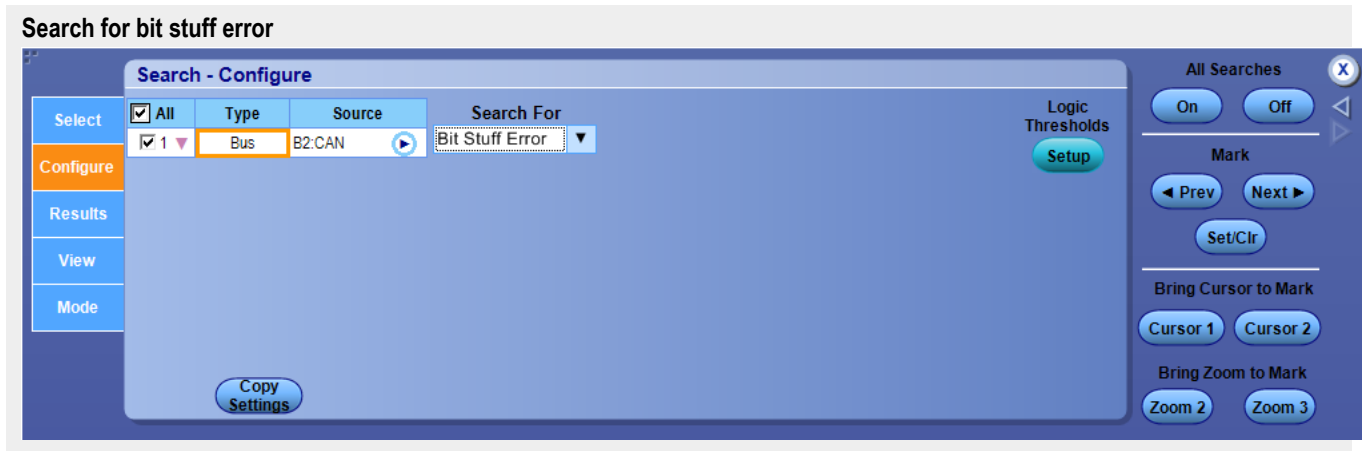

Set up LIN search parameters

After setting up an LIN bus, go to the Analyze menu, select Search, and then select the Bus trigger type; then open the Configure tab.

Overview

Use the controls to set up the LIN Bus parameters.

To use

For information on the controls, click the buttons.

- [Type](#)
- [Source](#)
- [Copy Settings](#)
- [Search Parameters](#)
- [Search / Mark Controls](#)

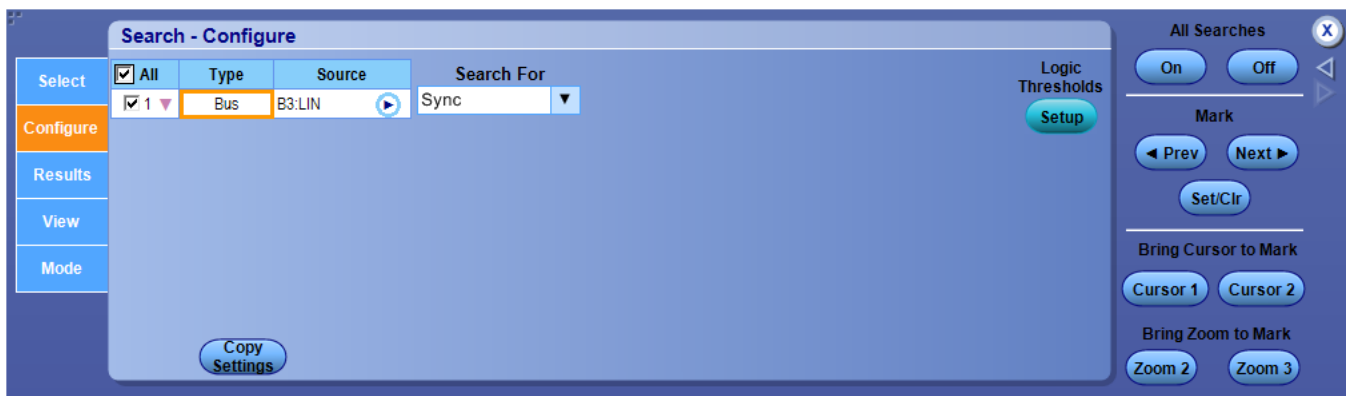

Behavior

Clicking an entry in the Type column activates the individual search controls, similar to the one shown above. These controls vary depending on the search Type. Setting the search conditions is similar to setting the parameters for an [Event Trigger](#).

NOTE. No information will be displayed in this window until you specify at least one search Type in the [Search Select Control Window](#).

To use

- Click the Source box and select the bus number or name from the window. [Bus Search Selection List](#)
- Select the type of bus cycle or activity to search for from the Search For drop-down list.
- For some Search For selections, you must set additional fields to define other parameters such as for Data.

In this example, you need to set a Data is, Number of Bytes, and Data value (click the [Edit](#) button). Optionally, you can also set the component threshold levels through the Logic Thresholds Setup button.

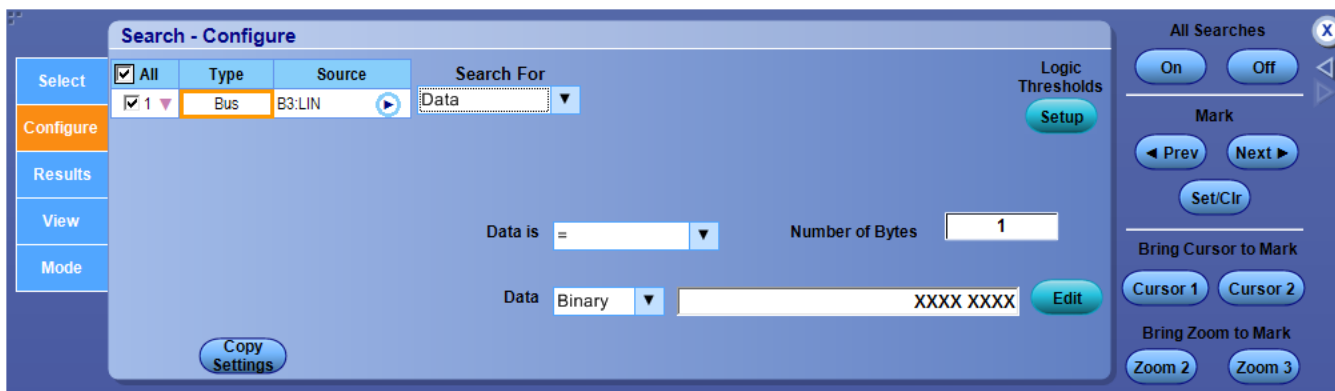

Click the Search For selections Identifier or Ident & Data, Wakeup Frame, Sleep Frame, or Error to view their parameters.
What do you want to do next?

[Learn about bus setups.](#)

Search for identifier

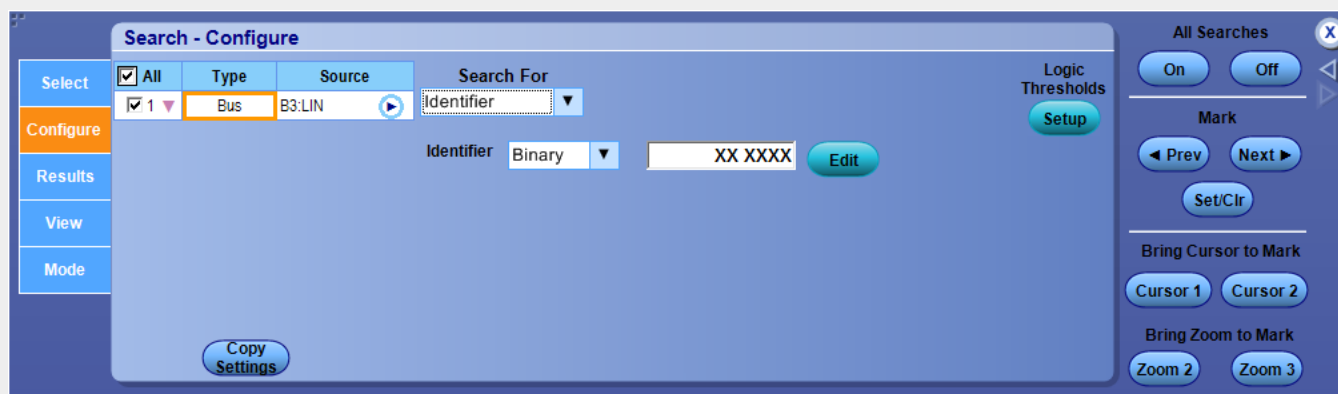

Select the Identifier from the drop-down list. Click Edit to enter the data value.

Search for ident & data

The data type options available in Search For Ident & Data are Number of Bytes, Identifier, Data is, and Data value.

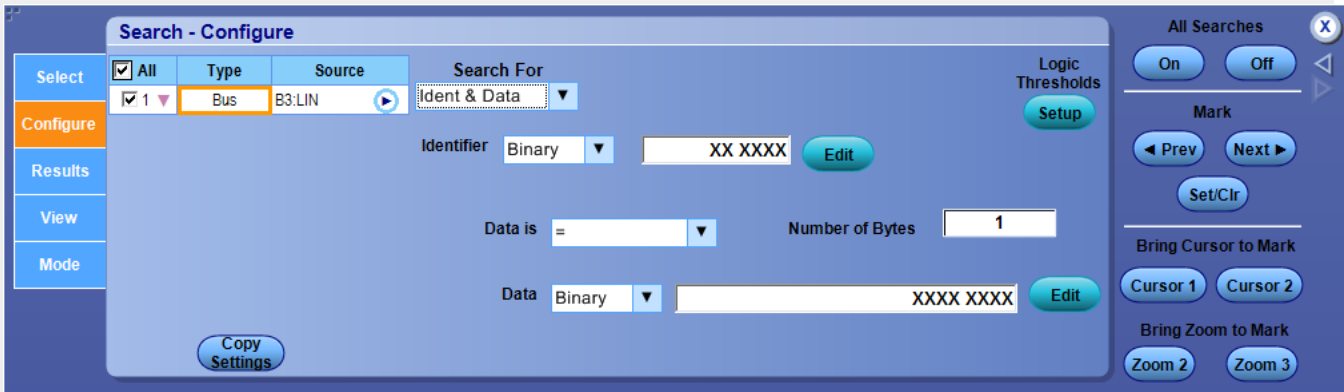

Select the Data from the drop-down list. Click Edit to enter the data value.

Search for wakeup frame



Search for sleep frame



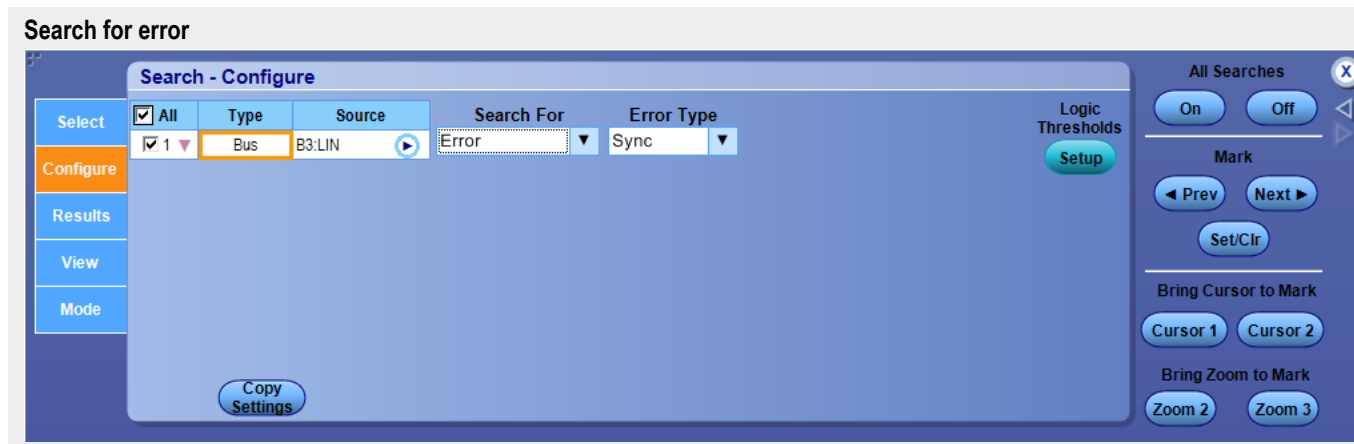

Set up FLEXRAY search parameters

After setting up an FLEXRAY bus, go to the Analyze menu, select Search, and then select the Bus trigger type; then open the Configure tab.

Overview

Use the controls to set up the FLEXRAY Bus parameters.

To use

For information on the controls, click the buttons.

- [Type](#)
- [Source](#)
- [Copy Settings](#)
- [Search Parameters](#)
- [Search / Mark Controls](#)

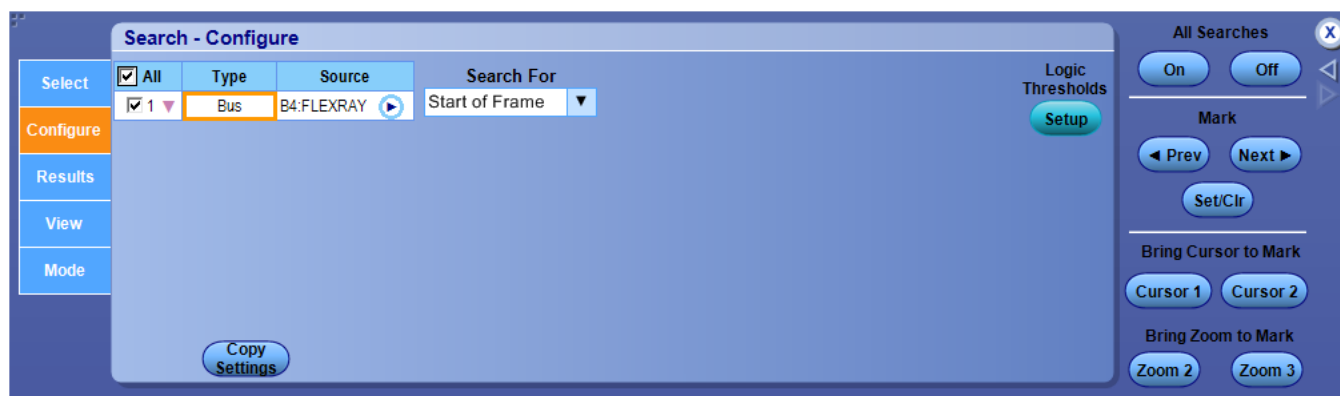

Behavior

Clicking an entry in the Type column activates the individual search controls, similar to the one shown above. These controls vary depending on the search Type. Setting the search conditions is similar to setting the parameters for an [Event Trigger](#).

NOTE. No information will be displayed in this window until you specify at least one search Type in the [Search Select Control Window](#).

To use

- Click the Source box and select the bus number or name from the window. [Bus Search Selection List](#)
- Select the type of bus cycle or activity to search for from the Search For drop-down list.
- For some Search For selections, you must set additional fields to define other parameters such as for Data.

In this example, you need to set a Qualifier, Number of Bytes, Offset, and Data value (click the [Edit](#) button). Optionally, you can also set the component threshold levels through the Logic Thresholds Setup button.

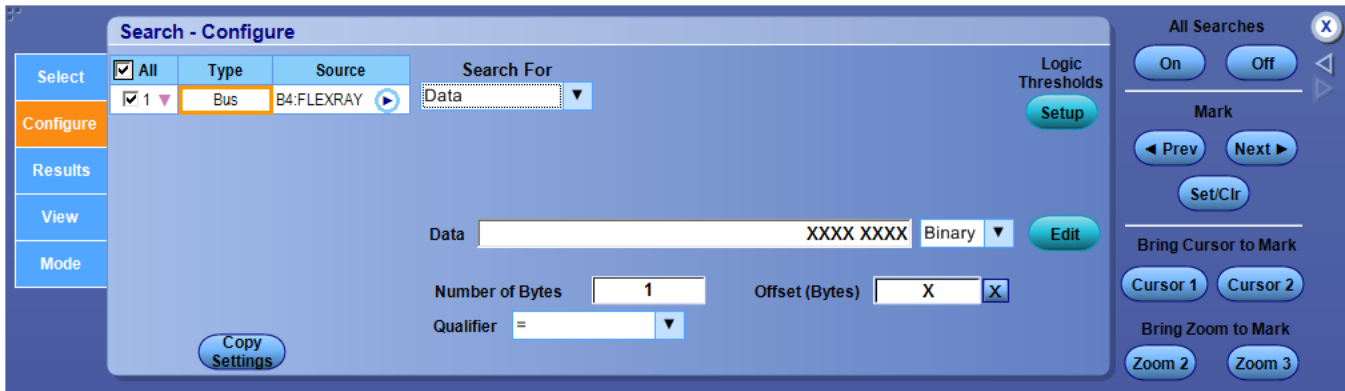

Click the Search For selections Indicator Bits, Identifier, Cycle Count, Header Fields, Ident & Data, End of Frame, or Error, to view their parameters.

What do you want to do next?

[Learn about bus setups.](#)

Search for indicator bits

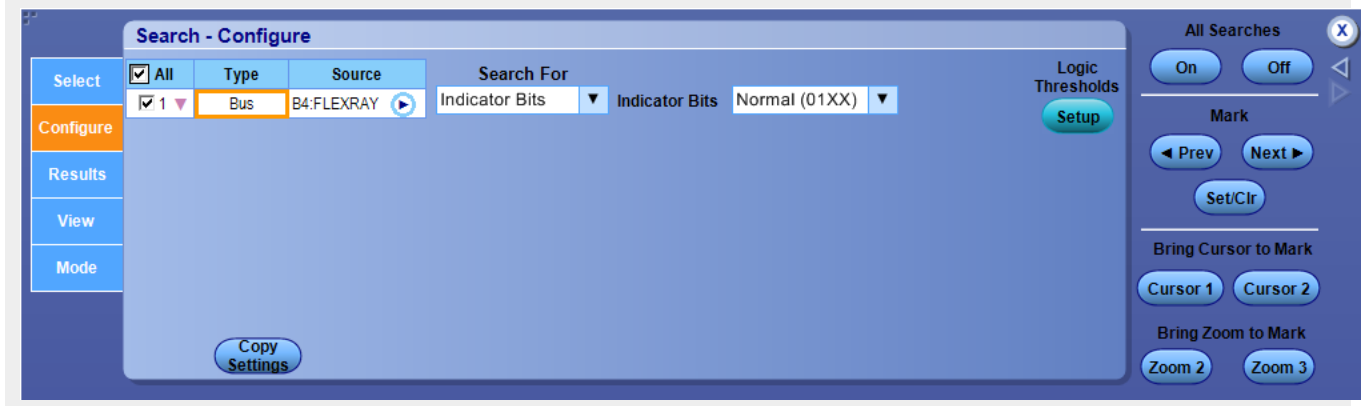

Search for identifier

The data type options available in Search For Identifier are Identifier and Qualifier.

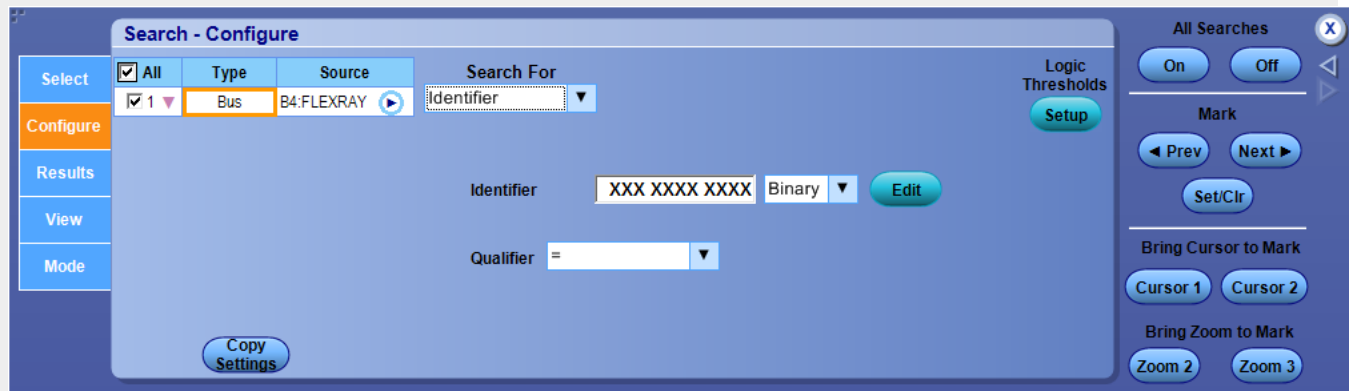

Select the Identifier from the drop-down list. Click Edit to enter the value. Click Logic Thresholds to adjust the logic thresholds.

Search for cycle count

The data type options available in Search For Cycle Count are Cycle Count and Qualifier.

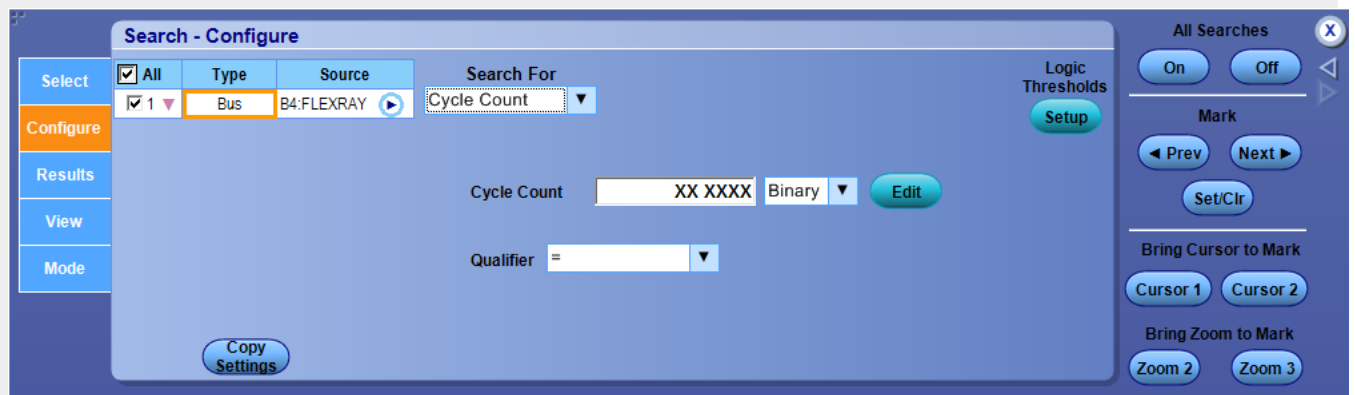

Select the Qualifier from the drop-down list. Click Edit to enter the Cycle Count value. Click Logic Thresholds to adjust the logic thresholds.

Search for header fields

The data type options available in Search For Header Fields are Indicator Bits, Identifier, Payload Length, Header CRC, and Cycle Count.

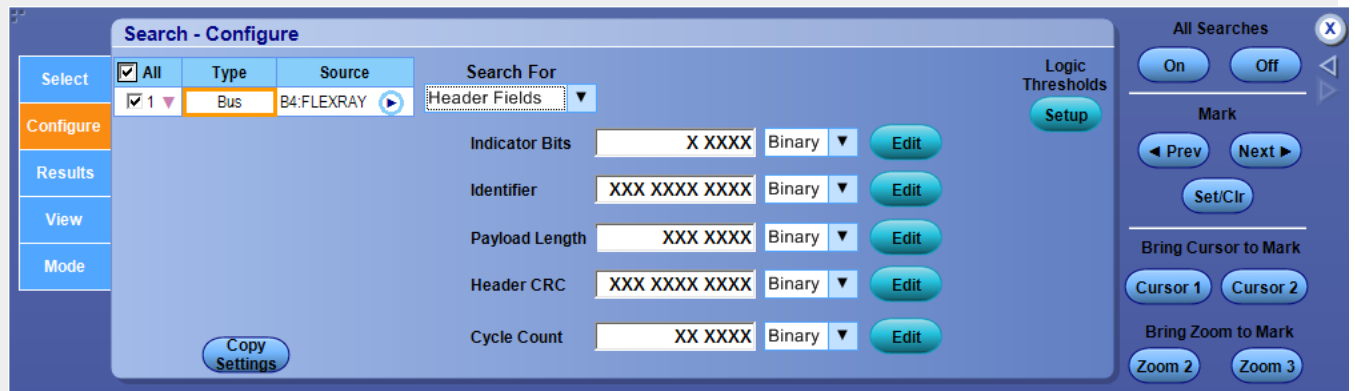

Click Edit to enter the data value. Click Logic Thresholds to adjust the logic thresholds.

Search for ident & data

The data type options available in Search For Ident & Data are Identifier, Number of Bytes, Qualifier, Offset, and Data.

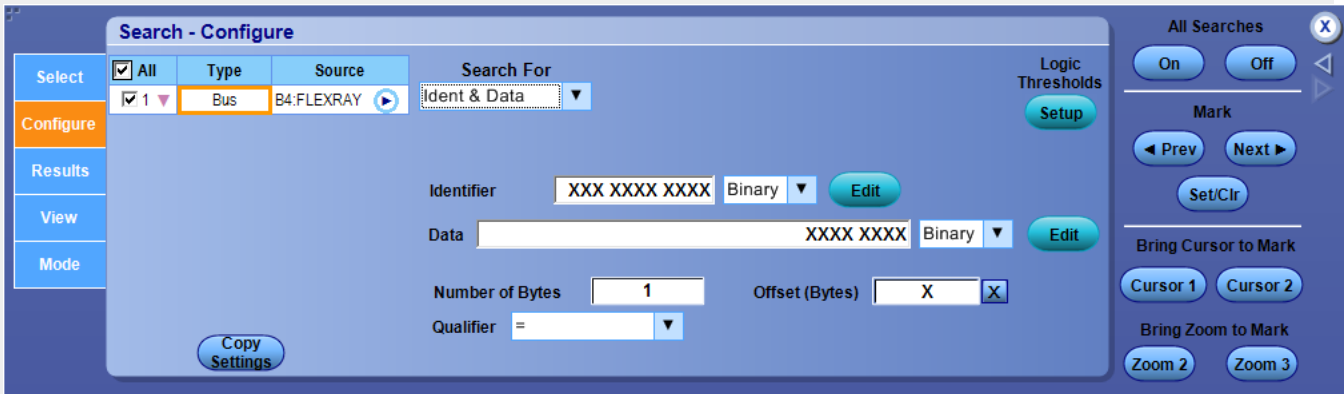

Select the Identifier from the drop-down list. Click Edit to enter the data values. Click Logic Thresholds to adjust the logic thresholds.

Search for end of frame

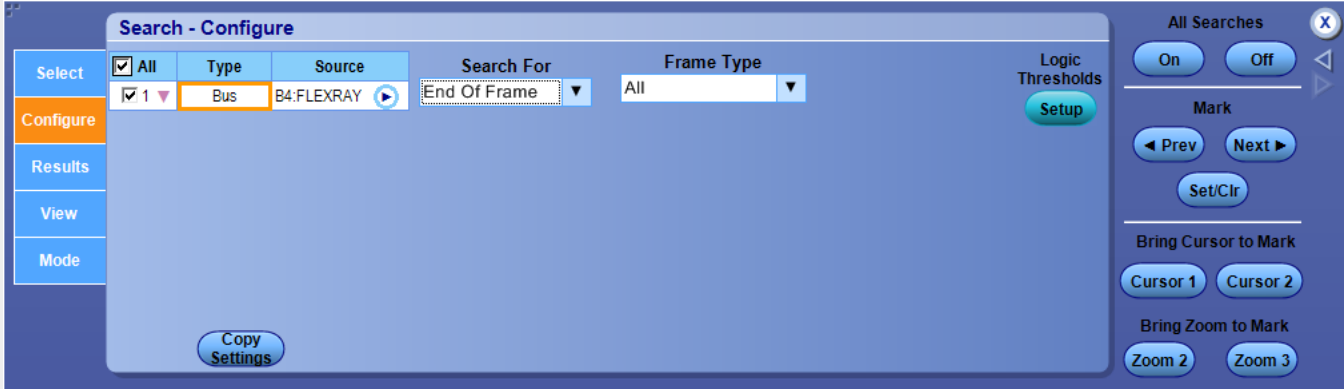

Search for error

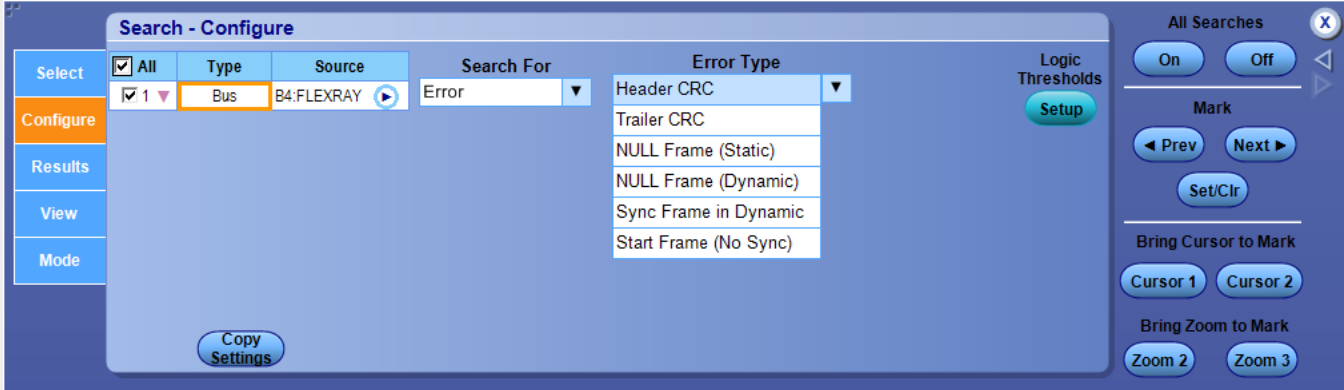

Set up MIL-1553 search parameters

After setting up a MIL-1553 bus, go to the Analyze menu, select Search, and then select the Bus trigger type; then open the Configure tab.

Overview

Use the controls to set up the MIL-1553 Bus parameters.

To use

For information on the controls, click the buttons.

- [Type](#)
- [Source](#)
- [Copy Settings](#)
- [Search Parameters](#)
- [Search / Mark Controls](#)

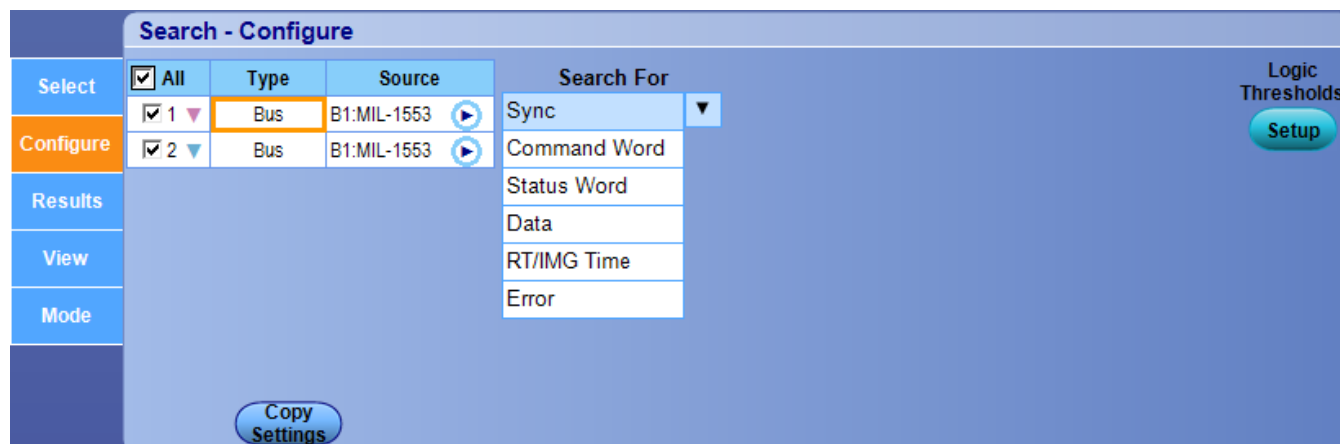

Behavior

Clicking an entry in the Type column activates the individual search controls, similar to the one shown above. These controls vary depending on the search Type. Setting the search conditions is similar to setting the parameters for an [Event Trigger](#).

NOTE. No information will be displayed in this window until you specify at least one search Type in the [Search Select Control Window](#).

To use

- Click the Source box and select the bus number or name from the window. [Bus Search Selection List](#)
- Select the type of bus cycle or activity to search for from the Search For drop-down list.
- For some Search For selections, you must set additional fields to define other parameters such as for Command Word.

In this example, you need to set an Search when RT Address is, Parity, T/R bit, RT Address, Subaddress Mode, and Word Count/Mode Code (click the [Edit](#) button). Optionally, you can also set the component threshold levels through the Logic Thresholds Setup button.

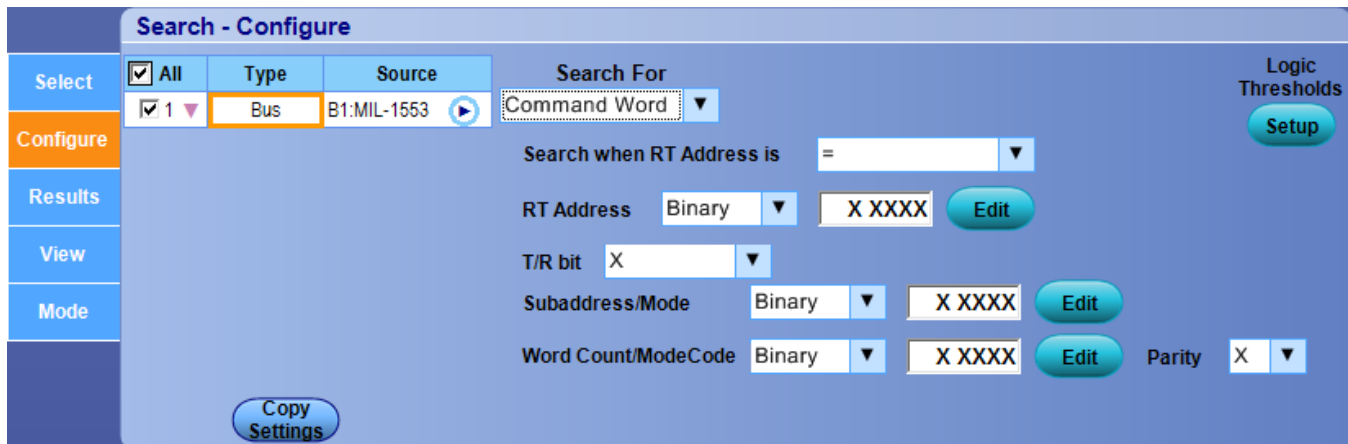

Click the Search For selections Command Word, Status Word, Data, RT/IMG Time, or Error, to view their parameters.

What do you want to do next?

[Learn about bus setups.](#)

Search for command word

The data type options available in Search For Command Word are Search when RT Address is, RT Address, T/R bit, Subaddress/Mode, Word Count/Mode Code, and Parity.

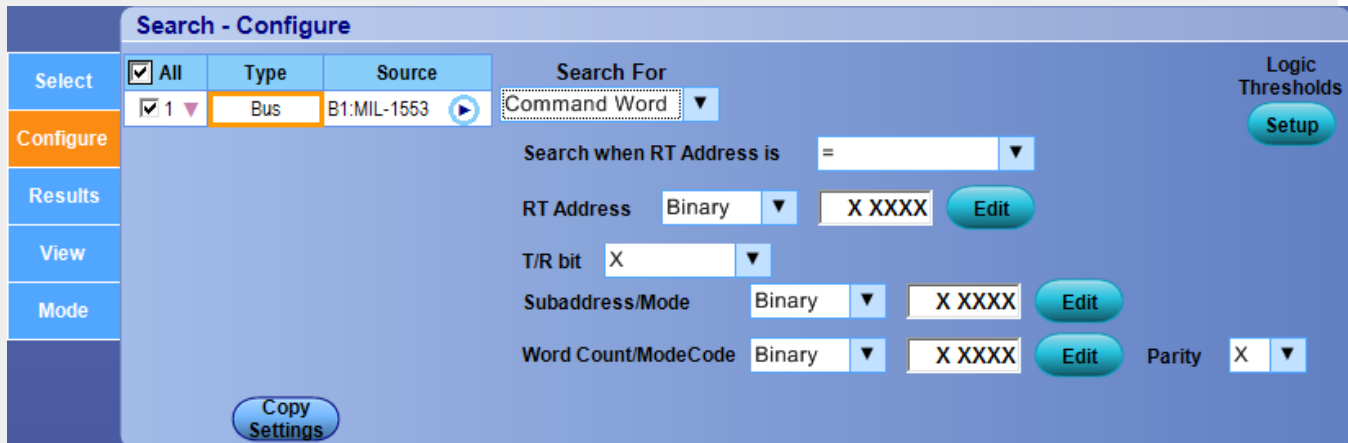

Search for status word

The data type options available in Search For Status Word are Message Error, Instrumentation, Service Request, BCR, Busy, Subsystem, DBCA, Terminal Flag, Parity Search when Remote Terminal Address is, and RT Address (click the [Edit](#) button).

Search - Configure

Select: All | Type: Bus | Source: B1:MIL-1553

Search For: Status Word

Search when Remote Terminal Address is: =

RT Address: Binary | X XXXX

Message Error (bit 9): | Instrumentation (bit 10): | Service Request (bit 11):

BCR (bit 15): | Busy (bit 16): | Subsystem (bit 17):

DBCA (bit 18): | Terminal Flag (bit 19): | Parity:

Buttons: Copy Settings, Setup, Edit

Search for data

The data type options available in Search For Data are Data, and Parity.

Search - Configure

Select: All | Type: Bus | Source: B1:MIL-1553

Search For: Data

Search when data is:

Data: Binary | XXXX XXXX XXXX XXXX

Parity:

Buttons: Copy Settings, Setup, Edit

Search for RT/IMG Time

The data type options available in Search For RT/IMG Time are Search when data is, Maximum Time and Minimum Time.

Search - Configure

Select: All | Type: Bus | Source: B1:MIL-1553

Search For: RT/IMG Time

Search when data is: Inside Range

Maximum Time: 12.0 μ S

Minimum Time: 4.0 μ S

Buttons: Copy Settings, Setup

Search for error

The data type option available in Search For Error is Error Type.

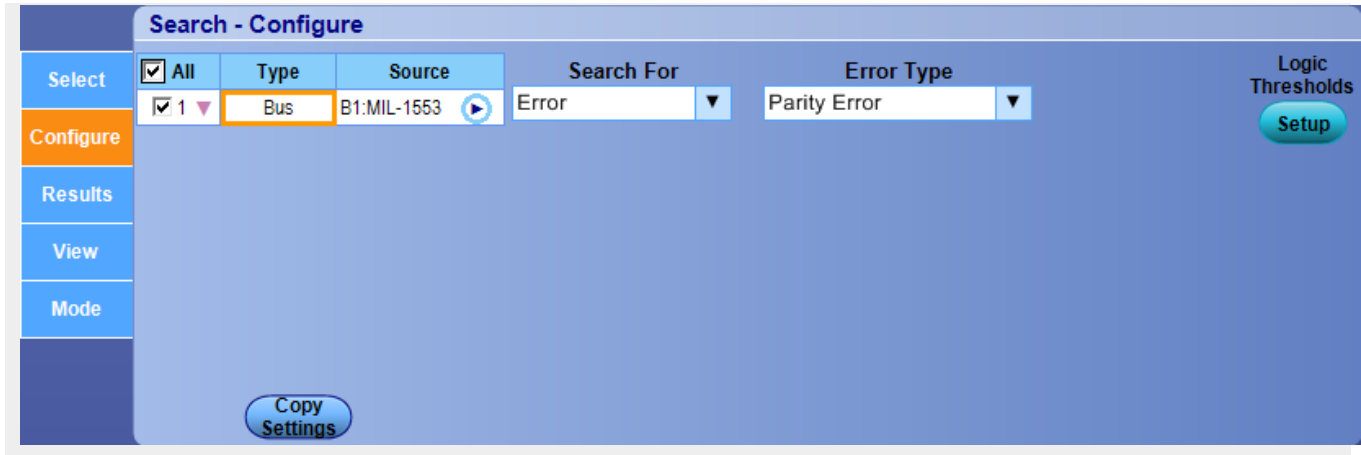

Set up ethernet search parameters

After setting up an Ethernet bus, go to the Analyze menu, select Search, and then select the Bus trigger type; then open the Configure tab.

Overview

Use the controls to set up the Ethernet Bus parameters.

To use

For information on the controls, click the buttons.

- [Type](#)
- [Source](#)
- [Copy Settings](#)
- [Search Parameters](#)
- [Search / Mark Controls](#)

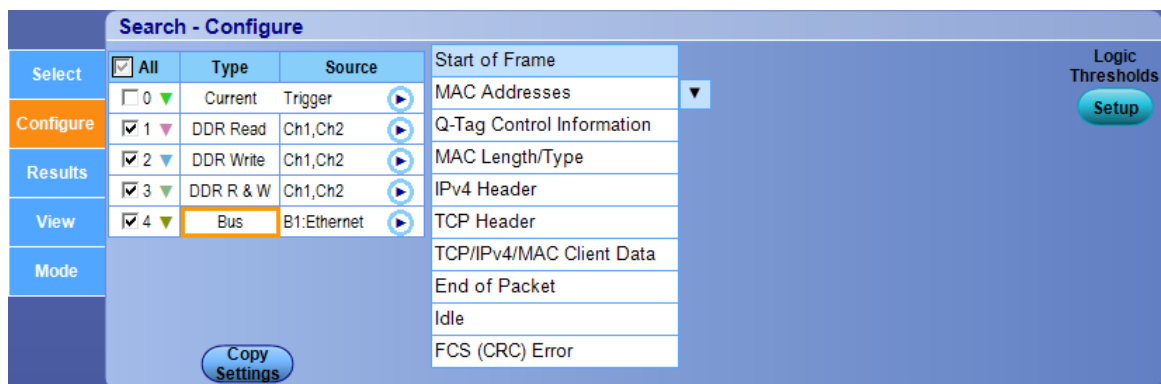

Behavior

Clicking an entry in the Type column activates the individual search controls, similar to the one shown above. These controls vary depending on the search Type. Setting the search conditions is similar to setting the parameters for an [Event Trigger](#).

NOTE. No information will be displayed in this window until you specify at least one search Type in the [Search Select Control Window](#).

To use

- Click the Source box and select the bus number or name from the window. [Bus Search Selection List](#)
- Select the type of bus cycle or activity to search for from the Search For drop-down list.
- For some Search For selections, you must set additional fields to define other parameters such as for Command Word.

In this example, you need to enter a Source Port, Destination Port, Seq Number, and Acq Number (click the [Edit](#) button). Optionally, you can also set the component threshold levels through the Logic Thresholds Setup button.

The screenshot shows the 'Search - Configure' window. On the left is a vertical navigation menu with buttons for 'Select', 'Configure', 'Results', 'View', and 'Mode'. The main area is divided into sections: 'Select' (with a checked 'All' checkbox and a '1' dropdown), 'Type' (set to 'Bus'), 'Source' (set to 'B1:Ethernet'), and 'Search For' (set to 'TCP Header'). Below these are four input fields: 'Source Port' (XXXX), 'Destination Port' (XXXX), 'Seq Number' (XXXX XXXX), and 'Acq Number' (XXXX XXXX). Each field has a 'Hex' dropdown and an 'Edit' button. A 'Copy Settings' button is at the bottom left, and a 'Logic Thresholds Setup' button is at the top right.

Click the Search For selections Start of Frame, MAC Addresses, Q-Tag Control Information, MAC Length/Type, IPv4 Header, TCP Header, MAC Data, TCP/IPv4 Client Data, End of Packet, Idle, or FCS (CRC) Error, to view their parameters.

What do you want to do next?

[Learn about bus setups.](#)

Start of frame

Select Start of Frame to search for the Ethernet Start of Frame.

| Select | Type | Source |
|---|-----------|-------------|
| <input checked="" type="checkbox"/> All | | |
| <input type="checkbox"/> 0 | Current | Trigger |
| <input checked="" type="checkbox"/> 1 | DDR Read | Ch1,Ch2 |
| <input checked="" type="checkbox"/> 2 | DDR Write | Ch1,Ch2 |
| <input checked="" type="checkbox"/> 3 | DDR R & W | Ch1,Ch2 |
| <input checked="" type="checkbox"/> 4 | Bus | B1:Ethernet |

Search For: Start of Frame

Buttons: Copy Settings, Logic Thresholds Setup

MAC addresses

The data type options available in Search For MAC Address are Source MAC, and Destination MAC. To search for an Ethernet MAC address, enter the Source MAC and Destination MAC addresses.

Search For: MAC Addresses

Source MAC: XX:XX:XX:XX:XX:XX Hex Edit

Destination MAC: XX:XX:XX:XX:XX:XX Hex Edit

Buttons: Copy Settings, Logic Thresholds Setup

Q-Tag control information

The data type option available in Search For Q-Tag Control Information is Q-Tag Value.

Search For: Q-Tag Control Information

Q-tag Value: 8100 xxxx Hex Edit

Buttons: Copy Settings, Logic Thresholds Setup

MAC length/type

The data type option available in Search For MAC Length/Type is MAC Length/Type.

Search - Configure

| Select | All | Type | Source | Search For | Logic Thresholds |
|-----------|-------------------------------------|------|-------------|----------------------------|--------------------------------------|
| | <input checked="" type="checkbox"/> | Bus | B1:Ethernet | MAC Length/Type | <input type="button" value="Setup"/> |
| Configure | <input checked="" type="checkbox"/> | 1 | | MAC Length/Type = XXXX Hex | <input type="button" value="Edit"/> |
| Results | | | | | |
| View | | | | | |
| Mode | | | | | |

IPv4 header

The data type options available in Search For IPv4 Header are IP Protocol, Source Address, and Destination Address.

Search - Configure

| Select | All | Type | Source | Search For | Logic Thresholds |
|-----------|-------------------------------------|------|-------------|-------------------------------------|--------------------------------------|
| | <input checked="" type="checkbox"/> | Bus | B1:Ethernet | IPv4 Header | <input type="button" value="Setup"/> |
| Configure | <input checked="" type="checkbox"/> | 1 | | IP Protocol XX Hex | <input type="button" value="Edit"/> |
| Results | | | | Source Address XX.XX.XX.XX Hex | <input type="button" value="Edit"/> |
| View | | | | Destination Address XX.XX.XX.XX Hex | <input type="button" value="Edit"/> |
| Mode | | | | | |

TCP header

The data type options available in Search For TCP Header are Source Port, Destination Port, Seq Number, and Acq Number.

Search - Configure

| Select | All | Type | Source | Search For | Logic Thresholds |
|-----------|-------------------------------------|------|-------------|---------------------------|--------------------------------------|
| | <input checked="" type="checkbox"/> | Bus | B1:Ethernet | TCP Header | <input type="button" value="Setup"/> |
| Configure | <input checked="" type="checkbox"/> | 1 | | Source Port XXXX Hex | <input type="button" value="Edit"/> |
| Results | | | | Destination Port XXXX Hex | <input type="button" value="Edit"/> |
| View | | | | Seq Number XXXX XXXX Hex | <input type="button" value="Edit"/> |
| Mode | | | | Acq Number XXXX XXXX Hex | <input type="button" value="Edit"/> |

MAC data

The data type options available in Search For MAC Data are Data, Number of Bytes, Offset, and Qualifier.

The screenshot shows the 'Search - Configure' window. On the left is a vertical menu with 'Configure' highlighted. The main area has a table with columns 'Select', 'Type', and 'Source'. The 'Select' column has a checked 'All' box and a '1' with a dropdown arrow. The 'Type' column has 'Bus' selected. The 'Source' column has 'B1:Ethernet' and a play button. To the right is a 'Search For' dropdown menu with 'MAC Data' selected. Below this are fields for 'Data' (containing 'XXXX XX01'), 'Binary' (dropdown), 'Number of Bytes' (input '1'), 'Offset (Bytes)' (input 'X'), and 'Qualifier' (input '='). Buttons for 'Setup', 'Edit', and 'Copy Settings' are visible.

TCP/IPv4 client data

The data type options available in Search For TCP/IPv4 Client Data are Data, Number of Bytes, Offset, and Qualifier.

This screenshot is identical to the previous one, but the 'Search For' dropdown menu is set to 'TCP/IPv4 Client Data'.

End of packet

Select End of Packet to search for the Ethernet End of Packet.

This screenshot is identical to the previous ones, but the 'Search For' dropdown menu is set to 'End of Packet'.

Idle

Select Idle to search for an Ethernet Idle character.

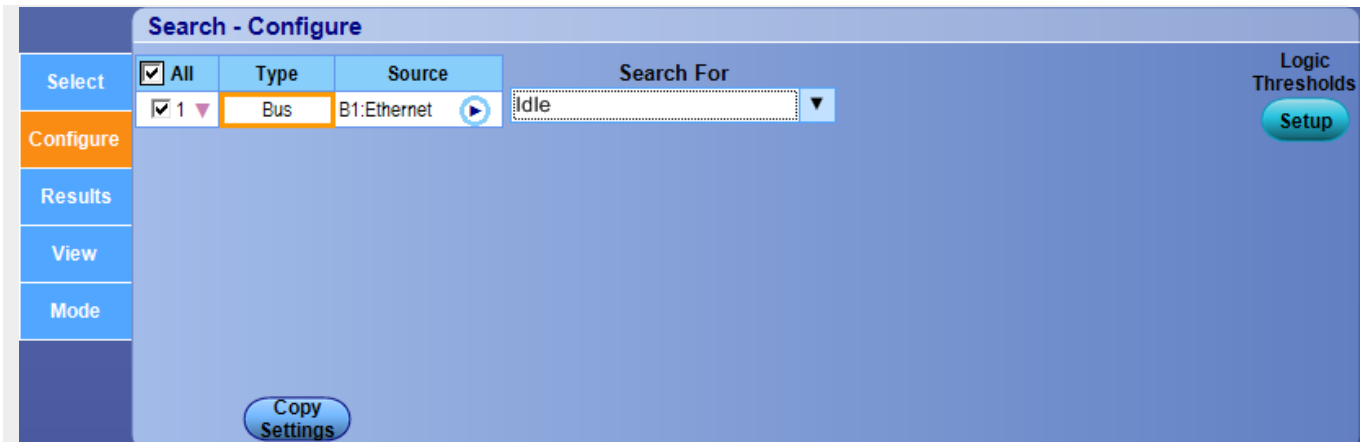

FCS (CRC) error

Select FCS (CRC) Error to search for an Ethernet FCS error.

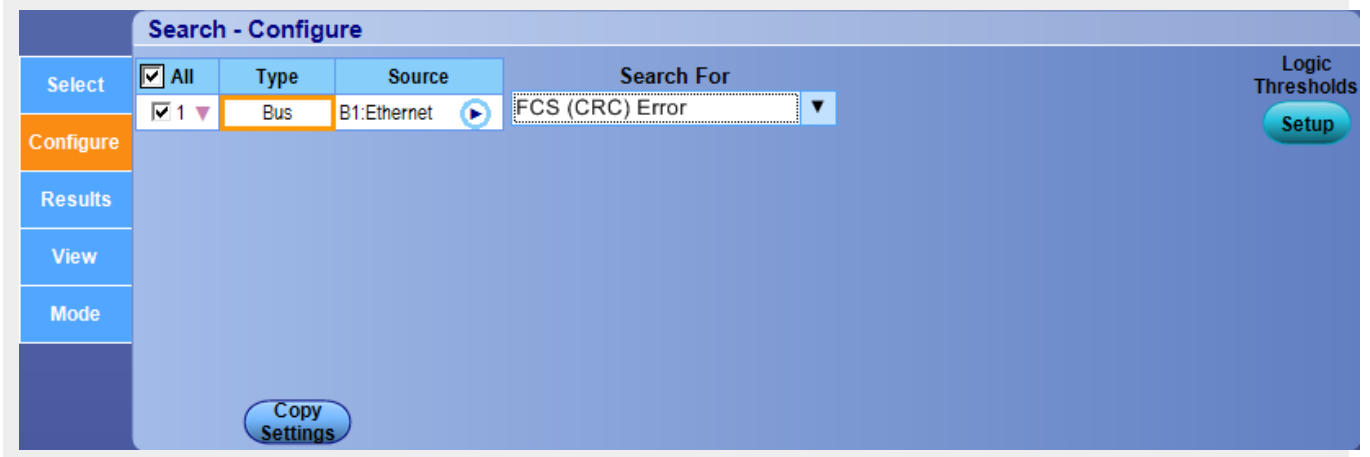

Set up DDR search parameters

After setting up a DDR bus, go to the Analyze menu, select Search, and then select the bus trigger type; then open the Configure tab.

Overview

Use the controls to set up DDR, DDR2, DDR3, DDR4, DDR3L, LPDDR, LPDDR2, LPDDR3, GDDR3, GDDR5 bus parameters.

To Use

For information on the controls, click the buttons.

- [Type](#)
- [Source](#)
- [Copy Settings](#)
- [Search Parameters](#)
- [Search / Mark Controls](#)

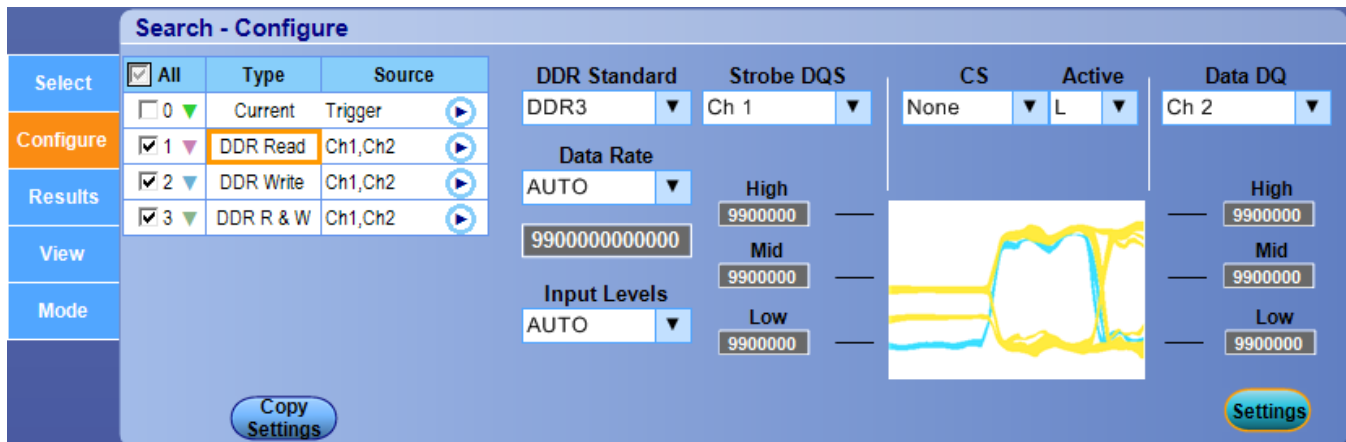

Behavior

Clicking an entry in the Type column activates the individual search controls, similar to the one shown above. These controls vary depending on the search Type. Setting the search conditions is similar to setting the parameters for an [Event Trigger](#).

NOTE. No information will be displayed in this window until you specify at least one search Type in the [Search Select Control Window](#).

To use

- Click the Source box and select the channels from the window. [Select the search source](#)
- Select the DDR standard to search for from the DDR Standard drop-down list.
- Select the source of the DQS Strobe from the Strobe DQS drop-down list.
- Select the data rate from the Data Rate drop-down list.
- Select the input levels from the Input Levels drop-down list.
- If you selected the Custom input level, enter the High, Mid, Nd Low levels using the keypad or attached keyboard.
- Select the source of the Data DQ from the Data DQ drop-down list.
- Select the source of the chip select and its active state from the CS and Active drop-down lists.

For some DDR searches, you may need advanced control over the chip select level and edge detection.

- Select the chip select level mode from the Mode drop-down list.

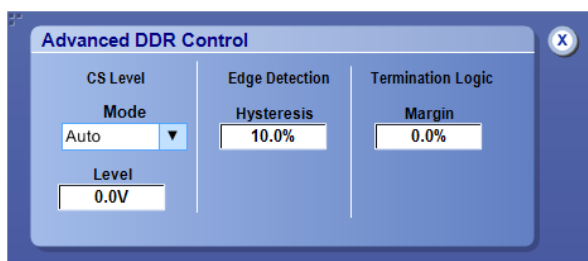

- If you select Manual mode, enter the level using the keypad or keyboard.
- Enter the Edge Detection Hysteresis using the keypad or keyboard.
- Enter the Termination Logic Margin using the keypad or keyboard.

What do you want to do next?

[Learn about bus setups.](#)

[Learn about Custom Serial Bus Setup.](#)

[Learn about advanced DDR search settings.](#)

Set up custom search parameters

After setting up a custom bus, go to the Analyze menu, select Search, and then select the Bus trigger type; then open the Configure tab.

Overview

Use the controls to set up the Custom Bus parameters.

To use

For information on the controls, click the buttons.

- [Type](#)
- [Source](#)
- [Copy Settings](#)
- [Search Parameters](#)
- [Search / Mark Controls](#)

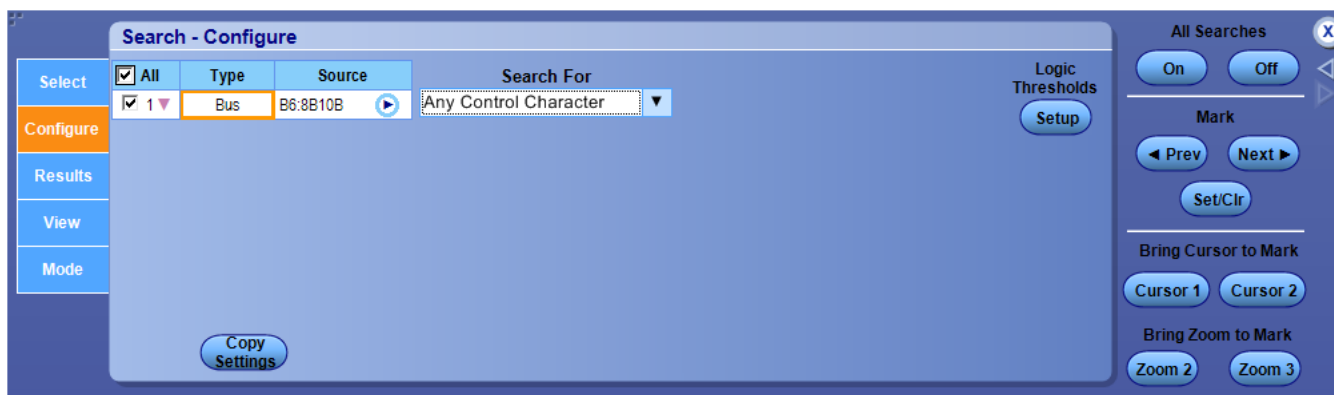

Behavior

Clicking an entry in the Type column activates the individual search controls, similar to the one shown above. These controls vary depending on the search Type. Setting the search conditions is similar to setting the parameters for an [Event Trigger](#).

NOTE. No information will be displayed in this window until you specify at least one search Type in the [Search Select Control Window](#).

To use

- Click the Source box and select the bus number or name from the window. [Bus Search Selection List](#)
- Select the type of bus cycle or activity to search for from the Search For drop-down list.
- For some Search For selections, you must set additional fields to define other parameters.

What do you want to do next?

[Learn about bus setups.](#)

[Learn about Custom Serial Bus Setup](#)

Set up parallel search parameters

After setting up a parallel bus, go to the Analyze menu, select Search, and then select the Bus trigger type; then open the Configure tab.

Overview

Use the controls to set up the Parallel Bus parameters.

To use

For information on the controls, click the buttons.

- [Type](#)
- [Source](#)
- [Copy Settings](#)
- [Search Parameters](#)
- [Search / Mark Controls](#)

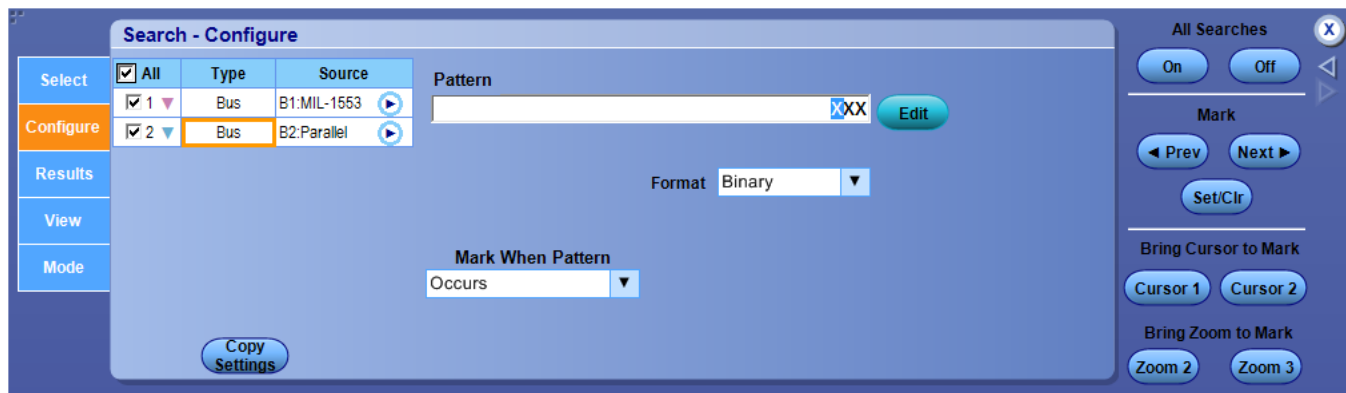

Behavior

Clicking an entry in the Type column activates the individual search controls, similar to the one shown above. These controls vary depending on the search Type. Setting the search conditions is similar to setting the parameters for an [Event Trigger](#).

NOTE. No information will be displayed in this window until you specify at least one search Type in the [Search Select Control Window](#).

To use

- Click the Source box and select the bus number or name from the window. [Bus Search Selection List](#)
- Select the pattern to search for using the Pattern Editor.
- Select when to place a mark using the Mark When Pattern drop-down list.

What do you want to do next?

[Learn about bus setups.](#)

[Learn about Custom Serial Bus Setup](#)

View the results table

From the Bus Setup window, select the Display tab, and click Results Table, or in the Analyze menu, select Results Table.

Overview

Use this dialog box to view the decoded contents of a bus.

| Index | Start Time | Type | PHY | Command | DPP | Error/Warning |
|-------|------------|---------|--------------|---------|----------|---------------|
| 0 | -2.00u | Unknown | Unknown | | | |
| 1 | -1.82u | Skip | Skip | | | |
| 2 | -1.81u | Idle | Logical Idle | | | |
| 3 | -1.11u | Skip | Skip | | | |
| 4 | -1.10u | Idle | Logical Idle | | | |
| 5 | -394.04n | Skip | Skip | | | |
| 6 | -390.06n | Idle | Logical Idle | | | |
| 7 | -114.03n | LCSTART | | LGOOD_3 | | |
| 8 | -98.03n | Idle | Logical Idle | | | |
| 9 | -82.02n | LCSTART | | LCRD_D | | |
| 10 | -66.02n | Idle | Logical Idle | | | |
| 11 | -48.03n | HPSTART | | | | |
| 12 | -8.02n | DPP | | | 13 bytes | |
| 13 | 42.00n | Idle | Logical Idle | | | |
| 14 | 317.94n | Skip | Skip | | | |
| 15 | 321.95n | Idle | Logical Idle | | | |
| 16 | 1.03u | Skip | Skip | | | |
| 17 | 1.03u | Idle | Logical Idle | | | |
| 18 | 1.10u | LCSTART | | LGOOD_4 | | |
| 19 | 1.12u | Idle | Logical Idle | | | |
| 20 | 1.13u | LCSTART | | LCRD_A | | |
| 21 | 1.15u | Idle | Logical Idle | | | |
| 22 | 1.74u | Skip | Skip | | | |
| 23 | 1.75u | Idle | Logical Idle | | | |

To use

- To view the decoded contents of a bus, select the tab for the bus, bus layer view, or marks. There is one tab for each defined bus or bus layer.

Behavior

This dialog box opens when you click Results Table from the Bus Setup Display tab, or in the Analyze menu, when you select Results Table.

Symbol substitution, annotation and radix behavior is controlled by the Bus Setup control window. There is one row per bus packet. There is one column per visible property or nondetail field in the bus. You can change the column width and column order. Some rows or columns can be expanded to show additional details of the hierarchical bus structure.

Two types of icons are displayed in the Index column.

An Error/Warning icon is displayed if the packet contains an error (red X) or warning (yellow triangle).



If the packet row or bus column contains collapsed detail, the Expand icon (+) is displayed. Click on the icon to expand the detail. If the detail is expanded, the Collapse icon (-) is displayed. Click on the icon to close the expanded detail.



Results Table data and Waveform Zoom 1 are correlated with each other. Results Table highlights rows that intersect with the current Waveform Zoom 1, if enabled. Waveform Zoom 1 moves zoom to center around the selected row in the event table.

Dock or undock the results table

To dock or undock the results table to the graticule, press the **Dock** button.

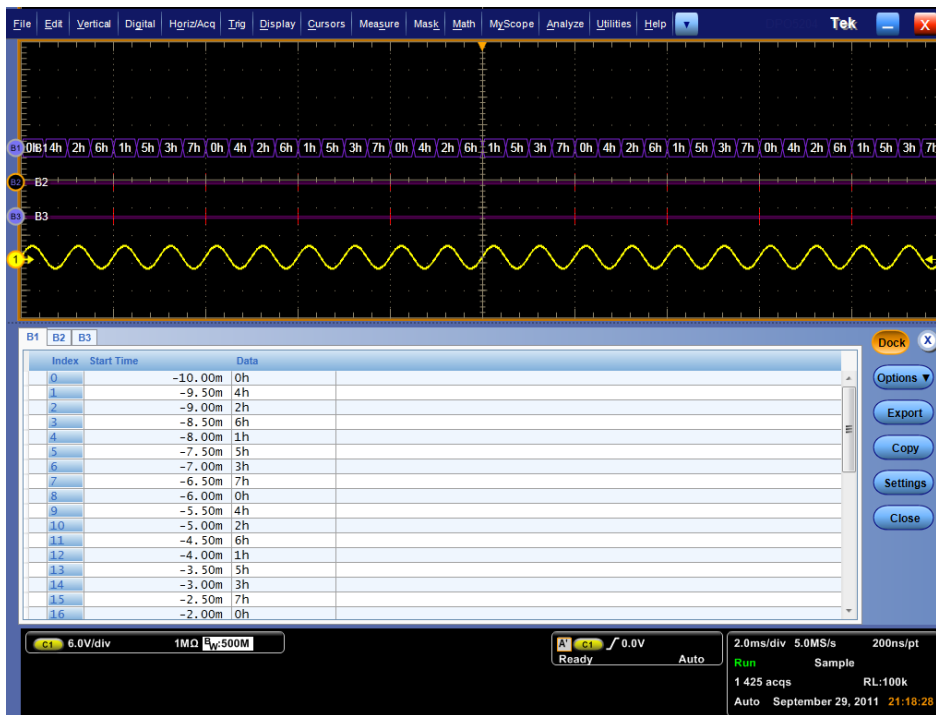

Resize the docked results table

To resize the docked table, click the splitter above the docked window and drag it to the size you want the table.

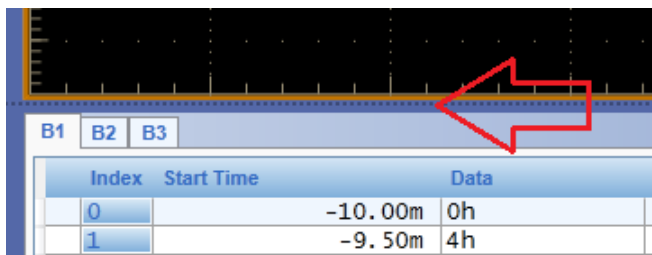

Change the results table column layout

Press the Options button to save a table layout, recall a table layout, or customize columns.

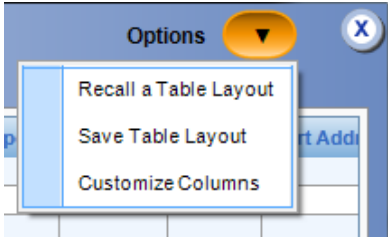

In the Customize Columns Layout window, you can move columns, select the columns you want displayed, or restore the defaults.

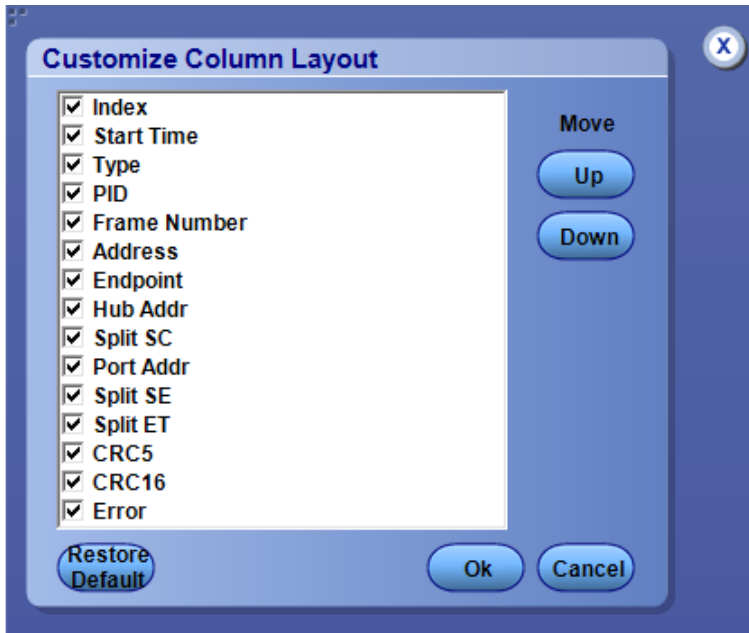

You can also drag columns to new locations and resize them using a mouse. Right clicking on a column heading in the table, also lets you select the columns you want displayed.

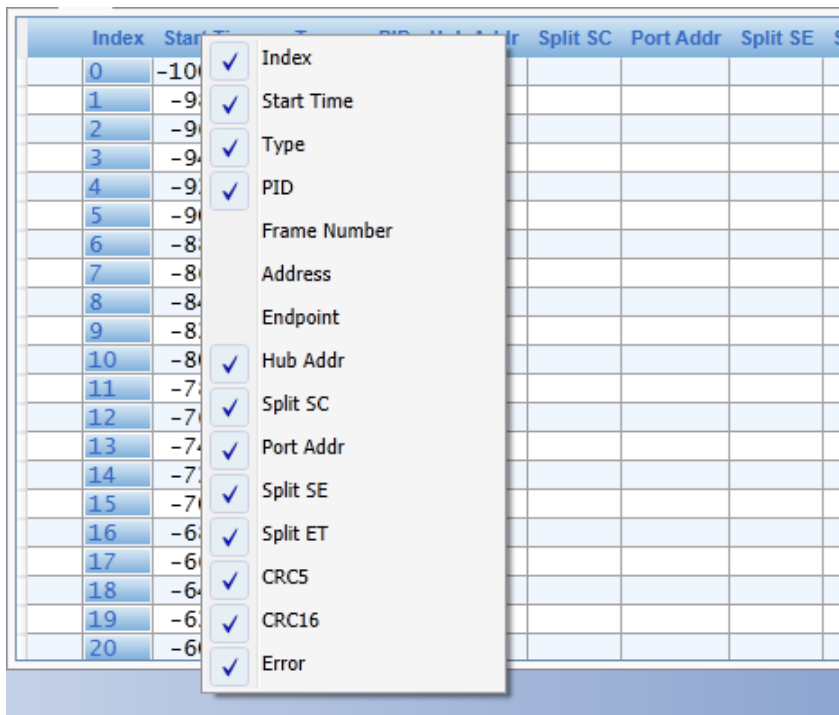

What do you want to do next?

[Learn about copying a results table.](#)

[Learn about selecting the columns to Copy/Export.](#)

[Learn about saving a results table.](#)

Copy the results table

From the Analyze menu, select Results Table. Click the Copy button to open the Select the columns to Copy/Export dialog box. From the dialog box, click the Copy button.

To use

- To save to a file, enter a Name or use the default file name. The file extension specified in the Save as type list will automatically be appended to the file name.

Behavior

Clicking the Copy button in the Select the columns to Copy/Export dialog box, copies the content of the results table to the Windows clipboard with the data formatted with comma separated values (.csv).

After the copy you can paste the data Word, Notepad, Excel, or other programs.

What do you want to do next?

[Learn about selecting the columns to Copy/Export.](#)

Select columns to copy or export

From the Analyze menu, select Results Table. Click the Settings button to open the Select the columns to Copy/Export dialog box. From the dialog box, click the Copy button.

Overview

Use this dialog box to select the columns of the results table to copy or export.

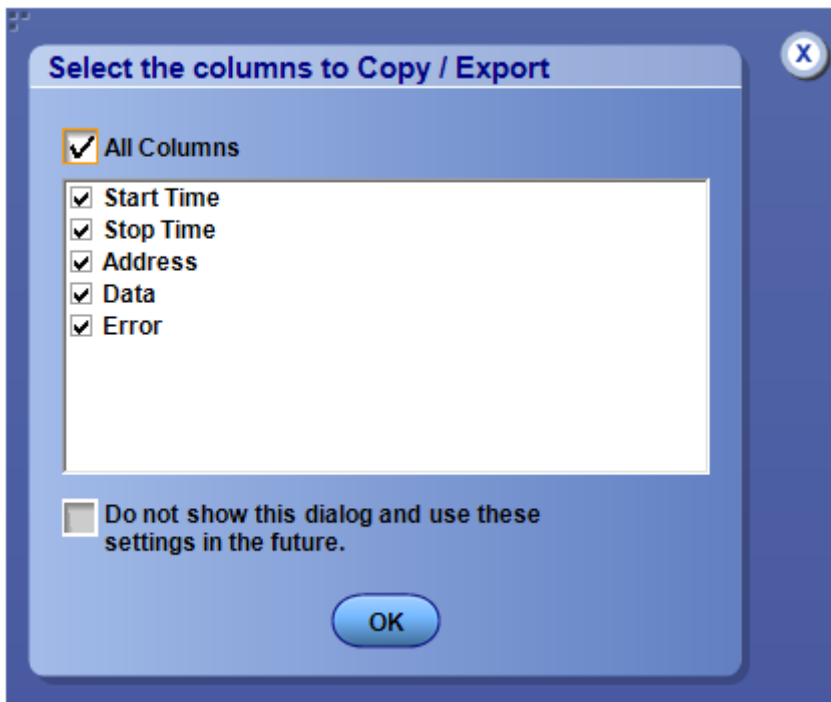

To use

- To select a column to copy or export, place a check mark next to the column name.

Behavior

Clicking the OK button in the Select the columns to Copy/Export dialog box, selects the checked columns for use by the copy and export

What do you want to do next?

[Learn about the Results Table.](#)

Save the results table

From the Analyze menu, select Results Table. Click the Export button to open the Select the columns to Copy/Export dialog box. From the dialog box, click the Export button.

Overview

Use this dialog box to export (save) the contents of the results table to a specified file in comma separated values (CSV) format.

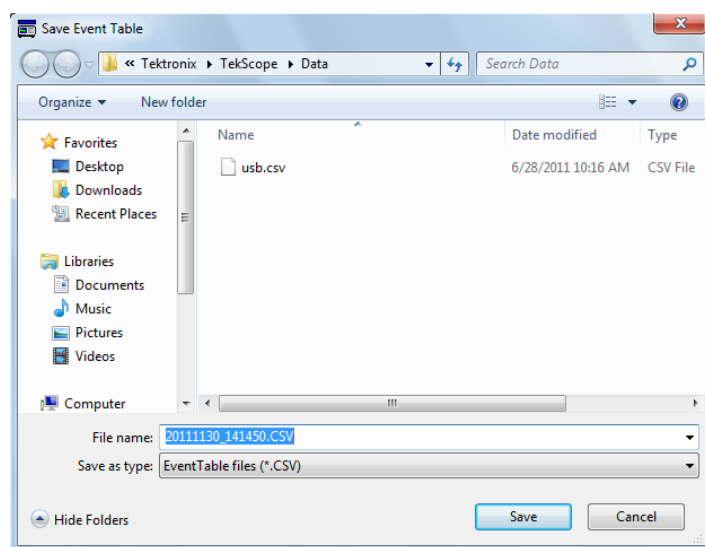

To use

- To save to a file, enter a Name or use the default file name. The file extension specified in the Save as type list will automatically be appended to the file name.

Behavior

This dialog box opens when you click Export from the Select the columns to Copy/Export dialog box. The default file type is a file with comma separated values (.csv).

The default folder is C:\Users\[Username]\Tektronix\TekScope\data.

NOTE. Any characters that you enter in the file name box become part of the file name. The instrument does not use any user-defined file extensions.

What do you want to do next?

[Learn about selecting the columns to Copy/Export.](#)

MyScope setups

Set up a MyScope control window

From the MyScope menu, select New Control Window.

Overview

MyScope allows you to create custom control windows that include only the controls you use regularly. Instead of switching between several control windows, put the controls you use into a custom control window.

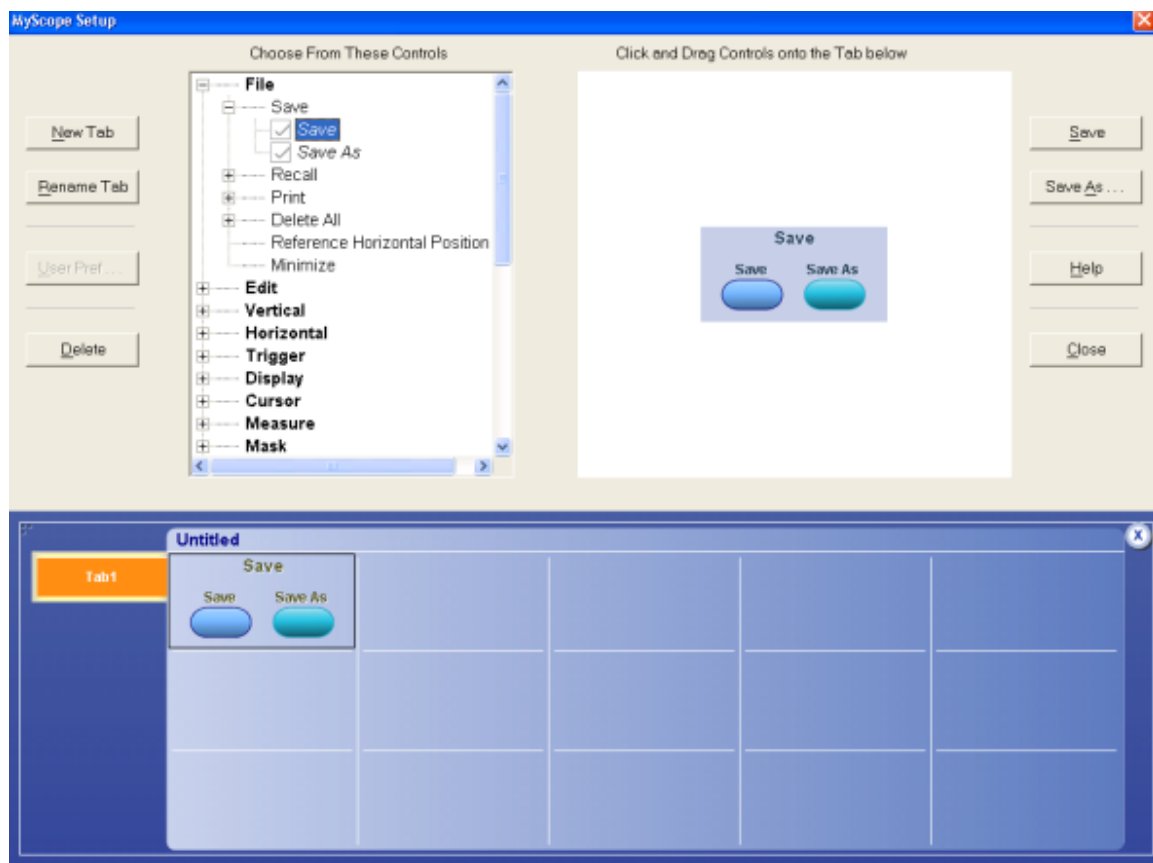

To use

- Click **+** to expand a control category.
- Click a control to preview it in the pane at the right.
- Click the **+** additionally to expand the control list. (If there is no **+**, then the control cannot be customized further.)
- Clear check boxes in the expanded control list to remove any components you do not want.
- Click and drag the controls to your MyScope control window. You can also change the placement of the control in your MyScope control window by clicking and dragging again.
- Click the New Tab button to add a tab to your MyScope control window. You can have up to six tabs in your MyScope control window. To rename a tab, click the Rename Tab button or double-click the tab.
- Click a control already added to the MyScope window, and then click the Delete button to remove it.
- Click User Pref to specify the user preferences you want to load:
 - *Prompts*
 - *Keypad Defaults*
 - *Readouts*
 - *Measurement Annotation*
 - *Units*
- Click *Save or Save As* to save your MyScope control window.
- Click Close to close the control window without saving it.

NOTE. Some MyScope controls operate differently than the identical control in the user interface.

Behavior

Clicking on a control in the list allows you to preview the control in the pane at the right. Selecting or clearing the check boxes for the controls in the list adds or removes controls. When you click and drag a control to assemble your custom control window, it will snap to the nearest grid location when you release the mouse.



TIP. To change a control you have already placed into a MyScope control window, drag it back to the preview pane and the appropriate control category will open for quick modifications.

Use a MyScope control window

Some MyScope controls operate differently than the identical controls in the user interface.

Horizontal controls

The Delay Mode control contains only an On/Off button and Position control.

Trigger controls

Trigger Type and Trigger Sequence controls have a setup button that is automatically included with the controls. Use this setup control window to set the parameters for the selected trigger type.

The Trigger Sequence controls represent the right half of the Trigger Setup control window under the A -> B Event tab. Use this setup window to set the parameters for the trigger sequence.

Cursor controls

The Cursor Multipurpose Knob (MPK) and style controls are available but what displays in your MyScope control window will depend on what type of cursor you select. For example if you select Screen cursors, then Cursor MPKs controls and Cursor Style controls display as shown in the following graphic.

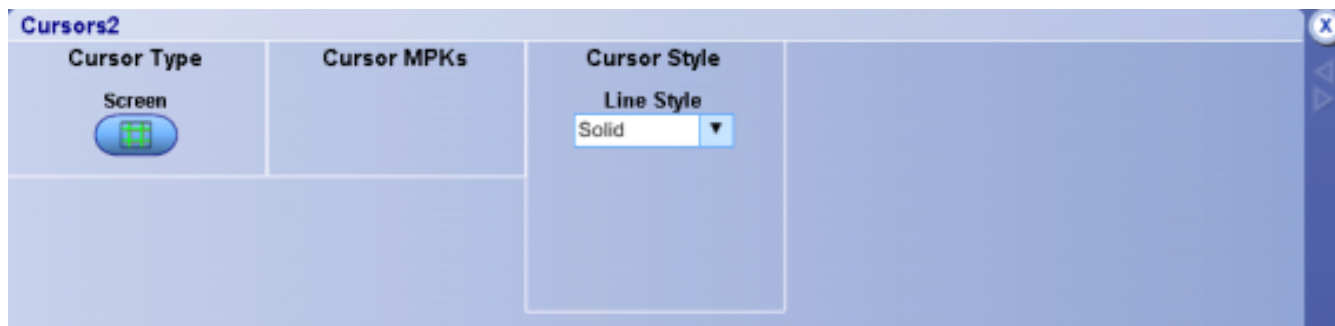

However if you select V Bars, then Cursor MPKs controls are not available and the Cursor Style controls change as shown below.



Measure controls

Measurement controls always include a Next and Clear button. The Clear button clears all measurements on all channels. The Next button advances the Source to the next active channel and assigns the same measurements to the next channel as were assigned to the previous channel. This is a quick way to assign the same measurements to multiple channels.

Each page of the measurement controls can hold up to twelve measurements.

Mask controls

The Mask Test controls act as shortcuts to the Mask Test setup control windows.

Utilities controls

The Set Time and Date, Instrument Diagnostics, E-mail on Event, and User Preferences Utilities controls act as shortcuts to the setup control window for these controls. Clicking the Setup button in any one of these controls will activate the setup control window for that command.

What do you want to do next?

[Learn about saving MyScope control windows.](#)

[Learn about editing MyScope control windows.](#)

Save a MyScope file as a dialog box

In the MyScope Control Window, click the Save button.

To use

Use this dialog box to save a MyScope control window to a specified location:

- Enter a Name in the Name text box, use the default file name, or click [Auto-increment file name](#) if you want to save a series of files without typing in a new name each time. The file extension specified in the Save as type list will automatically be appended to the file name.
- To save to a different directory, select a location in the Save in drop-down list.
- Click Save.

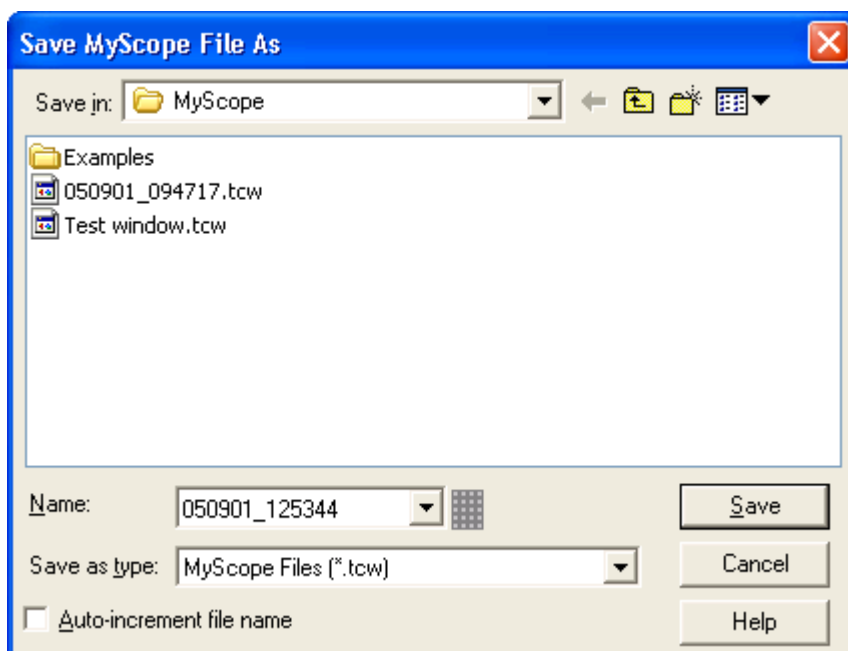

Behavior

This dialog box opens in the default directory `C:\Users\[Username]\Tektronix\TekScope\MyScope`. If you want to save MyScope control windows in another directory, click the Save in drop-down list to go to that directory. The only available file type is .tcw.

When you open the saved MyScope control window, the File name is displayed in the upper left corner of the control window.

What do you want to do next?

[Learn about the MyScope Setup and Edit control window.](#)

[Learn about opening a MyScope Control window.](#)

Open or edit a MyScope dialog box

From the MyScope menu, select Open Control Window.

To use

1. In the Look in drop-down list, navigate to the file location or select a control window file from the dialog box.
2. Click Open.

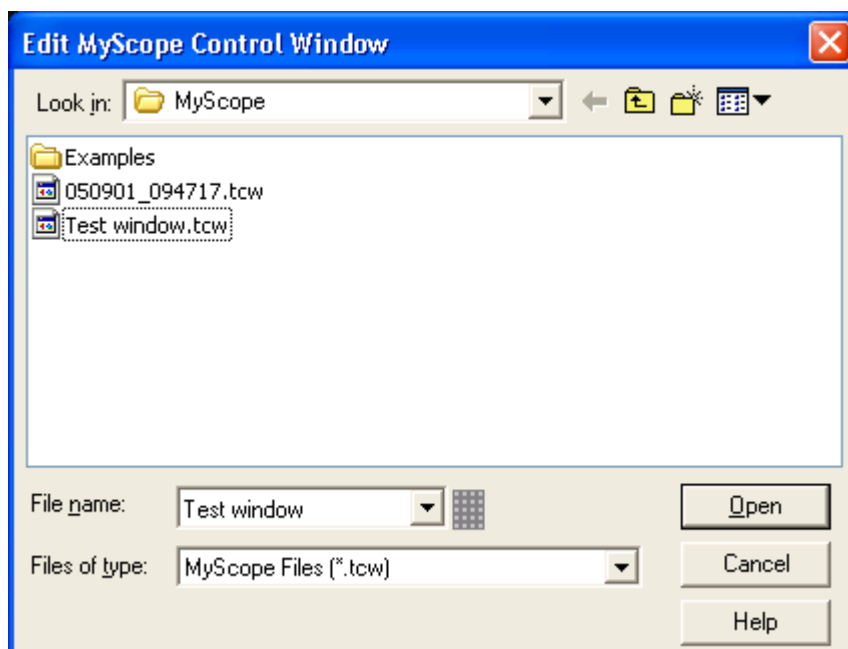

Behavior

This dialog box opens to the default directory `C:\Users\[Username]\Tektronix\TekScope\MyScope`. If you saved MyScope control window files in another directory, click the Look in drop-down list to go to that directory.

Clicking Open will open the selected MyScope control window, allowing you to add or delete controls.

NOTE. The only available file type is `.tcw`.

What do you want to do next?

[Learn about the MyScope Setup and Edit control window.](#)

[Learn about the Save MyScope File As dialog box.](#)

Trigger setups

Set up trigger controls (A event tab)

From the Trig menu, select A Event (Main) Trigger Setup.

NOTE. This online help documents features and options available for several instrument models. Your instrument may not have every feature discussed in this online help, depending on its configuration.

To use

Use the Trigger Setup control window to set up the instrument to trigger on live waveforms.

For information on the controls, click the buttons.

- [Trigger Summary](#)
- [A -> B \(Delay\)](#)
- [A->B \(No Delay\)](#)
- [B Event](#)
- [Options](#)

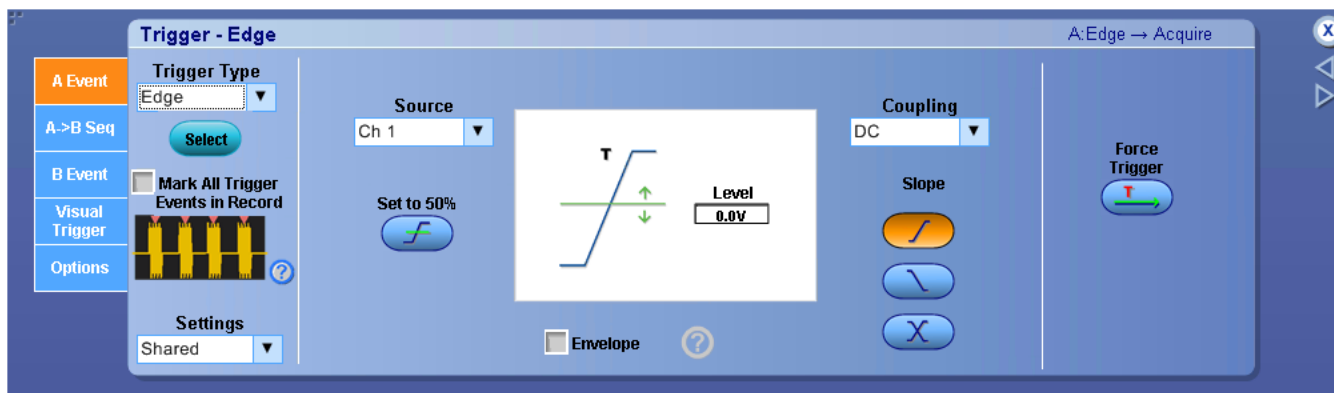

Behavior

This control window sets up the main trigger type, also known as the A Event trigger. When you click on the controls, the trigger graphic displays a visual indicator of the trigger criteria. Depending on the trigger type, the instrument will update the graphic as you define the trigger parameters.

The trigger expression near the top right side of the Trigger window provides a one-line summary of the conditions that must be fulfilled before the instrument will trigger.

The trigger event establishes the time-zero point in the waveform record. All points in the record are located in time with respect to the time-zero point. The instrument continuously acquires and retains sample points to fill the pretrigger portion of the waveform record. When a trigger event occurs, the instrument starts acquiring samples to build the posttrigger portion of the waveform record. Once a trigger is recognized, the instrument will not accept another trigger until the acquisition is complete and the holdoff time has passed.

What do you want to do next?

[Learn about the main trigger types.](#)

[Learn about sequential triggering.](#)

[Learn about B Event triggers.](#)

[Learn about Trigger Mode and Holdoff.](#)

Pretrigger data

The data points of the waveform acquired and displayed before the trigger event. You can set the amount of pretrigger data with the Horizontal Position control.

Posttrigger data

The data acquired and displayed after the trigger event. You can set the amount of posttrigger data with the Horizontal Position control.

Select the trigger type

From the Trig menu, select A Event Trigger Setup or B Event Trigger Setup.

To use

In the Trigger Type drop-down list box, select a trigger type.

| A Trigger type | B Trigger type |
|----------------|----------------|
| Edge | Edge |
| Glitch | Glitch |
| Width | Width |
| Runt | Runt |
| Window | Timeout |
| Freq/Per | Pattern |
| Timeout | State |
| Transition | Transition |
| Setup/Hold | Setup/Hold |
| Pattern | Window |
| State | |
| Comm | |
| Serial Pattern | |
| Video | |
| SPI | |
| I2C | |
| RS232 | |
| Can | |
| Bus | |

NOTE. This online help documents features and options available for several instrument models. Your instrument model may not have every trigger type listed here, depending on its configuration.

Behavior

The instrument provides the following trigger type categories.

- **Edge triggers.** This is the most commonly used trigger type. You can use [Edge triggers](#) with analog and digital signals. Edge triggers are available on both the Main and Delayed triggers.
- **Pulse triggers.** These are special-purpose triggers that are primarily used with digital signals. The following classes of pulse triggers are available: [Glitch](#), [Runt](#), [Window](#), [Width](#), [Transition](#), and [Timeout](#). Pulse triggers are only available on the main trigger.

NOTE. *Pulse trigger on B Events is not available on MSO/DPO5000B Series instruments.*

- **Logic triggers.** These are special-purpose triggers that are primarily used with digital logic signals. Two of the classes, [Pattern](#) and [State](#) (State triggers are not available on DPO7000SX ATI instruments), trigger the instrument based on the Boolean operator you select for the trigger sources. A third class, [Setup and Hold](#), triggers when data on one trigger source changes state within the setup and hold times that you specify relative to a clock on another trigger source. Logic triggers are only available on the main trigger.

NOTE. *Logic trigger on B Events is not available on MSO/DPO5000B Series instruments.*

- **Window.** Use the [Window trigger](#) to trigger the instrument when the input signal rises above an upper threshold or falls below a lower threshold level.

NOTE. *Window trigger on B Events is not available on MSO/DPO5000B Series instruments.*

NOTE. *Bus trigger on B Events is not available on MSO/DPO5000B Series instruments.*

Bus. Use to trigger on parallel or serial bus signals.

NOTE. *Some Bus triggers may not be available unless your instrument has a specific option installed.*

- **CAN Bus.** Use to trigger on CAN Bus signals.
- **SPI.** Use to trigger on Serial Peripheral Interface signals.
- **I2C.** Use to trigger on Inter-IC signals: start, stop, repeated start, missing acknowledge, address, data, and address and data.
- **RS-232.** Use to trigger on RS-232 signals.
- **Envelope.** Use to trigger on the envelope of an AM carrier.
- **Period.** Use to detect a period as two sequential crossings of same polarity.
- **Frequency.** Use to trigger on a frequency.
- **Comm.** The [Communication triggers](#) are designed to work with communication masks and standards.

NOTE. *Comm trigger on B Events is not available on MSO/DPO5000B Series instruments. Comm triggers are not available on DPO7000SX instruments.*

- **Serial.** Serial is a special trigger type used on signals with serial data patterns.

NOTE. *Serial trigger on B Events is not available on MSO/DPO5000B Series instruments.*

- **Video.** Use [Video triggers](#) to trigger the instrument on specified fields or lines of a video signal. You can use one of several preset video signal formats or set a custom format.

NOTE. Video trigger on B Events is not available on MSO/DPO5000B Series instruments.



TIP. Use the Trig menu Quick Select submenu to directly access the Event triggers.

What do you want to do next?

[Learn about sequential triggering.](#)

[Learn about B Event triggers.](#)

[Learn about Trigger Mode and Holdoff.](#)

[Return to the Trigger Setup control window.](#)

Set the trigger mode controls

From the Trig menu, select Mode.

Overview

Use the Trigger control window to set the trigger mode, to force a trigger, or to set the trigger level to 50%.

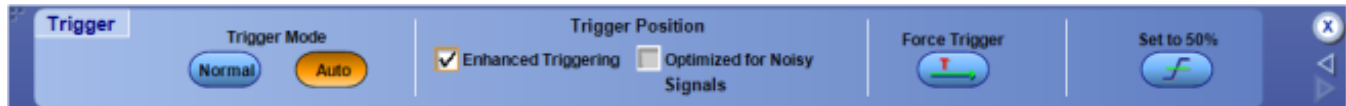

To use

- Click Normal or Auto to set the Trigger Mode.
- Click Enhanced Triggering to more accurately place the trigger on the display.
- Click Optimized for Noisy Signals to more accurately place the trigger on a noisy signal (available only if Enhanced Triggering is enabled.)
- Click Force Trigger once to acquire a waveform record without a trigger event. Forcing a trigger is useful when the input signal does not contain a valid trigger. The instrument recognizes and acts upon the forced trigger even when you click the button before the end of the pretrigger holdoff. The button has no effect when acquisitions are stopped.
- Click Set 50% to set the trigger threshold level of the selected trigger channel to 50% of the amplitude of the channel.

Behavior

These controls operate identically to the controls on the front panel. For more information on the individual controls, click the related control in the adjacent graphic.

What do you want to do next?

[Read information about Trigger Holdoff.](#)

[Return to the Trigger Setup control window.](#)

[Read information on the Run/Stop controls.](#)

Normal trigger mode

Normal trigger mode causes the instrument to wait for a valid trigger event before displaying waveform data. Normal trigger mode is most useful during single-shot acquisitions.

Auto trigger mode

Auto trigger mode causes the instrument to trigger if a valid trigger event does not occur within a set amount of time.

Auto trigger mode is useful when probing DC signal levels such as power supplies or logic levels that are stuck high or low. It is also useful when looking for activities on signal nodes such as oscillations when you first set up the instrument. The length of time it waits for a trigger event depends on the time base setting.

Force Trigger

Click this button to force the instrument to trigger and complete the current acquisition, regardless of whether any other trigger event occurs.

NOTE. This command has no effect if the acquisition system is not running.

Push the front-panel Level knob. This control is also available in some trigger setup windows.

To use

Click this button to have the instrument automatically search for and set the trigger level to a value halfway between the peaks of the trigger source signal.

NOTE. Some trigger types support multiple trigger levels, whereas other trigger types are unsupported, and the front-panel control is inoperative. This control also works differently for certain Comm triggers.

Set up the trigger holdoff

From the Trig menu, select Holdoff.

Overview

Use the Trigger Holdoff control Window to set the trigger holdoff.



To use

- Click Auto to set the holdoff to the default amount of time.
- Click the Time button; then click in the Trig Holdoff entry box and use a multipurpose knob to specify a holdoff time.
- Click Random to delay the trigger a random amount of time between triggers.

Behavior

When Holdoff is set to Auto, the holdoff time is based on the time equal to five times the current horizontal scale setting. You may want to manually set the holdoff time to help stabilize the display of complex waveforms, such as digital pulse trains that may have several possible trigger points.

The Level control can be either the main trigger level when there is no B Trigger event, or the A Event trigger level when a B Event trigger is defined. To change the B Event trigger level, change the B Trig Level control under the B Event tab of the Trigger Setup control window.

What do you want to do next?

[Return to the Trigger Setup control window.](#)

[Read information on Trigger modes.](#)

Trigger holdoff

After a trigger event, the instrument will not accept another trigger event until after the holdoff value is exceeded. Holdoff is usually specified in units of time, but other units may be used.

Set to 50

Push the front-panel Level knob (DPO7AFP required on DPO70000SX instruments). This control is also available in some trigger setup windows.

To use

Click this button to have the instrument automatically search for and set the trigger level to a value halfway between the peaks of the trigger source signal.

NOTE. Some trigger types support multiple trigger levels, whereas other trigger types are unsupported, and the front-panel control is inoperative. This control also works differently for certain Comm triggers.

A event triggers

Set up a parallel bus trigger

From the Trigger menu, select the Bus setup.

Overview. Use the controls to define the trigger for a Parallel bus.

To use. For information on the controls, click the buttons.

- [Trigger Type](#)
- [Mark All Trigger Events](#)
- [Pattern Condition](#)
- [Time](#)
- [Pattern](#)
- [Edit Button \(MSO70000C/DX Series\)](#)
- [Edit Button \(MSO/DPO5000B Series\)](#)
- [Pattern Format](#)
- [Logic Thresholds](#)

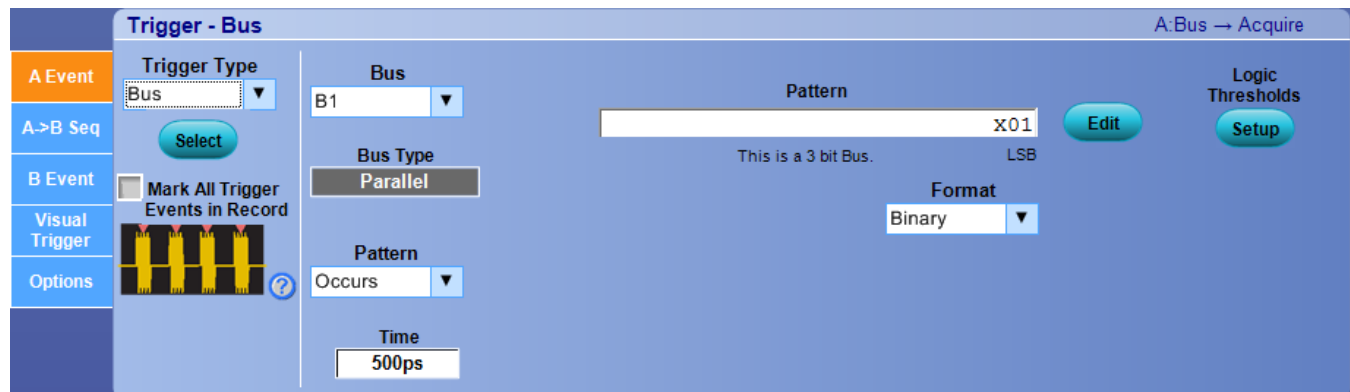

To use.

- Click the Trigger Type box and select Bus from the drop-down list.
- Click the Bus box and select the bus number or name from the drop-down list. The Bus Type shows Parallel.
- Click the Logic Thresholds Setup button to set the voltage threshold levels for the channels in the bus.
- Click the Pattern box and select the condition.
- Double-click the Time entry box and use the keypad or the multipurpose knob to enter a time.
- When All is selected in the Bus box, click the Trigger if Logic State Goes True box and select True or False.
- Click the Edit button to define a numeric or symbolic value of the Pattern.
- Click the Format box and select a Binary, ASCII, Decimal, Hex, or Symbolic display format.

What do you want to do next?

[Learn how to define a pattern for a bus.](#)

[Learn how to set the voltage threshold reference level for logic waveforms and to define a pattern.](#)

[Learn about bus setups.](#)

[Learn about bus configuration.](#)

[Learn about digital setups.](#)

Set up an 8B10B bus trigger

NOTE. The Bus Trigger Control Window for 8B10B Serial option is available only on instruments with option SR-810B.

From the Trigger menu, select Bus setup.

Overview. Use the controls to set up the 8B10B Bus parameters.

To use. For information on the controls, click the buttons.

- [Trigger Type](#)
- [Mark All Trigger Events](#)
- [Bus](#)
- [Logic Thresholds](#)

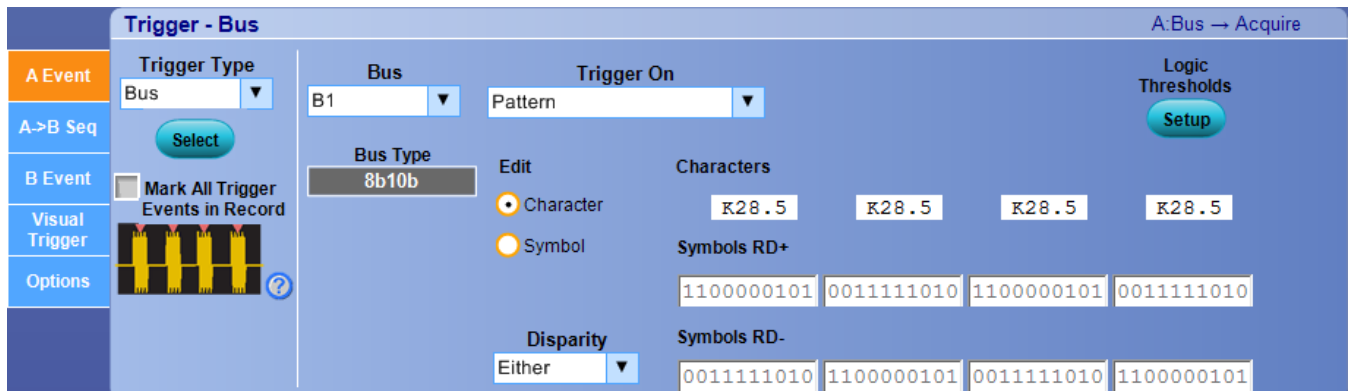

To use.

- Click the Trigger Type box and select Bus from the drop-down list.
- Click the Bus box and select the bus number or name from the drop-down list.

NOTE. You have the option to add a user-defined label for bus sources.

- Click the Logic Thresholds Setup button to set the voltage threshold levels for the channels in the bus.
- Select the type of bus cycle or activity to use as the trigger from the Trigger On drop-down list.
- For some Trigger On selections, you must set additional fields to define other parameters such as for a Pattern.

In this example, you need to set the Character or Symbol values and select the Disparity. You can also set the component threshold levels through the Logic Thresholds Setup button.

Click the Trigger On selections Character/Symbol or Error to view their parameters.

What do you want to do next?

[Learn about bus setups.](#)

Trigger on Character/Symbol
Trigger on Error

The error type options available in Trigger on Error are as follows:

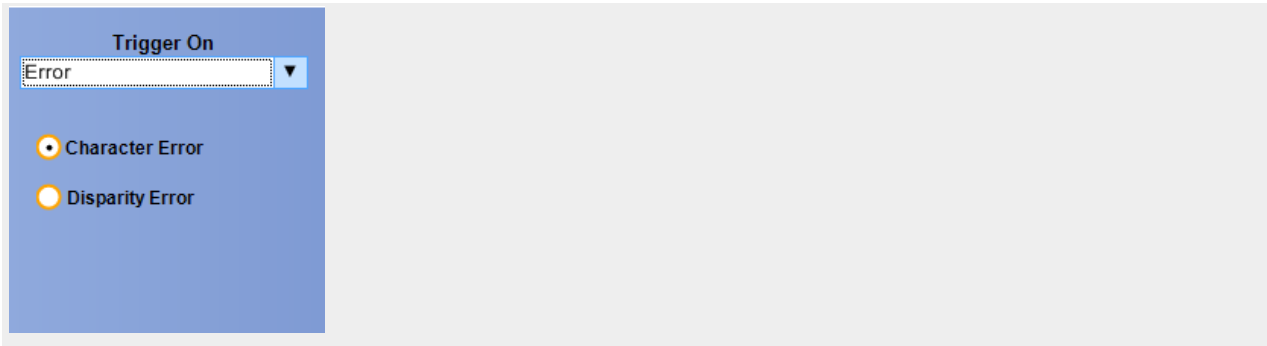

Set up an I2C bus trigger

NOTE. The Bus Trigger Control Window for I2C Serial option is available only on instruments with option SR-EMBD.

From the Trigger menu, select the Bus setup.

Overview. Use the controls to set up the I2C Bus parameters.

To use. For information on the controls, click the buttons.

- [Trigger Type](#)
- [Mark All Trigger Events](#)
- [Bus](#)
- [Logic Thresholds](#)

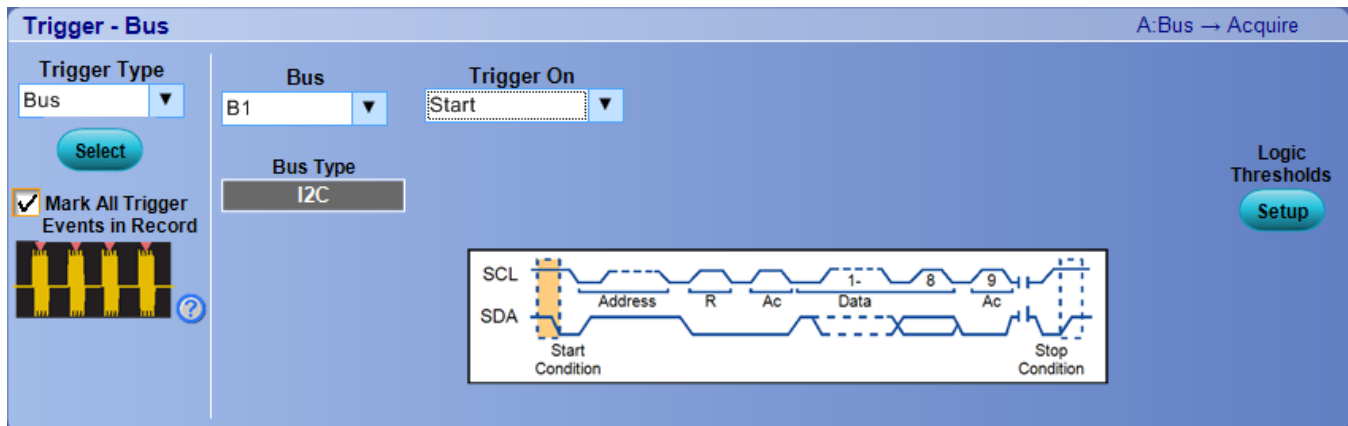

To use.

- Click the Trigger Type box and select Bus from the drop-down list.
- Click the Bus box and select the bus number or name from the drop-down list.

NOTE. You have the option to add a user-defined label for bus sources.

- Click the Logic Thresholds Setup button to set the voltage threshold levels for the channels in the bus.
- Select the type of bus cycle or activity to use as the trigger from the Trigger On drop-down list.
- For some Trigger On selections, you need to set additional fields to define other parameters such as for an Address.

In the following example, you need to set an Address Format, Address Value (click the [Edit](#) button), Data Direction, and Addressing Mode. Optionally, you can also set the component threshold levels through the Logic Thresholds Setup button.

The screenshot shows the 'Trigger - Bus' configuration window. On the left, there is a 'Trigger Type' dropdown set to 'Bus' and a 'Select' button. Below it is a checkbox 'Mark All Trigger Events in Record' which is checked, and a waveform icon. The main configuration area includes:

- Bus:** B1
- Trigger On:** Address
- Address Format:** Binary
- Address Value:** XXX XX01 (with an 'Edit' button)
- Bus Type:** I2C
- Addressing Mode:** 7 Bit
- Special Address:** None
- Direction:** Don't Care (X)
- Logic Thresholds:** A 'Setup' button is visible.

 The window title is 'Trigger - Bus' and the top right corner says 'A:Bus → Acquire'.

In the following example on MSO/DPO5000B Series instruments, you need to set an Address Format, Address Value (click the [Edit](#) button), Addressing Mode, Special Address, Direction, Number of Bytes, Data Format, Data Value ([Edit](#)) for the Addr+Data Trigger On type. Optionally, you can also set the component threshold levels through the Logic Thresholds Setup button.

The screenshot shows the 'Trigger - Bus' configuration window for an 'Addr + Data' trigger. The configuration is as follows:

- Trigger Type:** Bus
- Bus:** B1
- Trigger On:** Addr + Data
- Address Format:** Binary
- Address Value:** XXX XX01 (with an 'Edit' button)
- Bus Type:** I2C
- Addressing Mode:** 7 Bit
- Special Address:** None
- Direction:** Don't Care (X)
- Number of Bytes:** 1
- Data Format:** Binary
- Data Value:** XXXX XX01 (with an 'Edit' button)
- Logic Thresholds:** A 'Setup' button is visible.

 The window title is 'Trigger - Bus' and the top right corner says 'A:Bus → Acquire'.

In DPO7000C and MSO7000C/DX Series instruments, when you trigger on an Address for I2C serial bus, there are some predefined patterns termed as Special Addresses. Use this information to debug your serial bus. The following table lists the predefined patterns along with their names.

| Name | Address |
|--------------|------------|
| General Call | 0000 000 0 |
| START Byte | 0000 000 1 |
| HS-mode | 0000 1XX X |
| EEPROM | 1010 XXX X |
| CBUS | 0000 001 X |

Not recommended for use with iCapture inputs.

What do you want to do next?

[Learn about bus setups.](#)

Set up an SPI bus trigger

NOTE. The Bus Trigger Control Window for SPI Serial option is available only on instruments with option SR-EMBD.

From the Trigger menu, select the Bus setup.

Overview. Use the controls to set up the SPI Bus parameters.

To use. For information on the controls, click the buttons.

- [Trigger Type](#)
- [Mark All Trigger Events](#)
- [Bus](#)
- [Logic Thresholds](#)

To use.

- Click the Trigger Type box and select Bus from the drop-down list.
- Click the Bus box and select the bus number or name from the drop-down list.

NOTE. You have the option to add a user-defined label for bus sources.

- Click the Logic Thresholds Setup button to set the voltage threshold levels for the channels in the bus.
- Select the type of cycle to use as the trigger from the Trigger On drop-down list.
- For the MISO + MOSI Trigger On selection, push the Edit button to set additional fields for the Data Value, and then set the Format to match. Optionally, you can also set the component threshold levels through the Logic Thresholds Setup button.

For some Trigger On selections, you need to set additional fields to define other parameters such as for a Data.

In the following example, you need to set the Number of Words, Format, and Data Value (click the *Edit* button). Optionally, you can also set the component threshold levels through the Logic Thresholds Setup button.

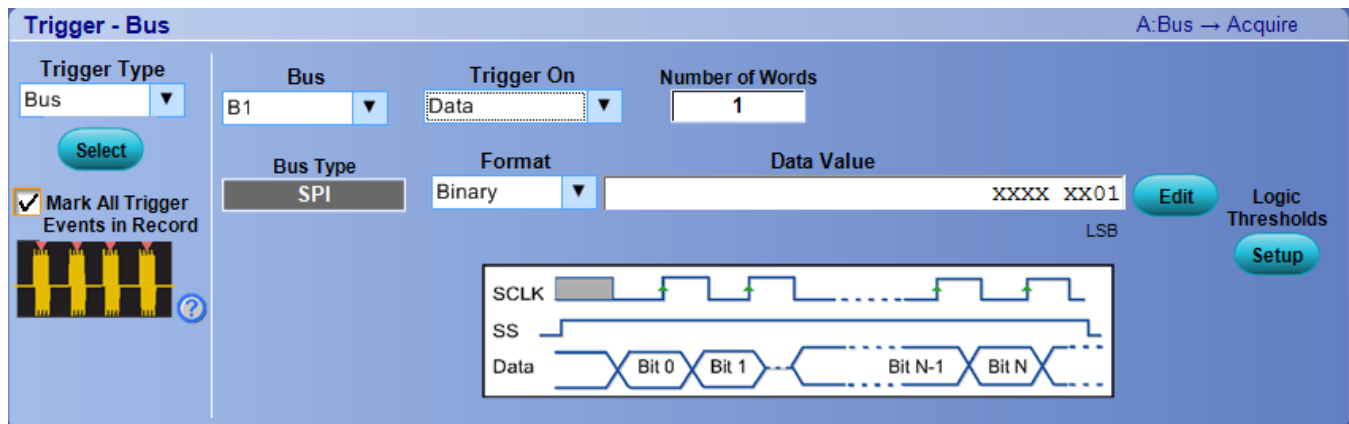

Not recommended for use with iCapture inputs.

What do you want to do next?

[Learn about bus setups.](#)

Set up an RS-232 bus trigger

NOTE. The Bus Trigger Control Window for RS-232 Serial option is available on instruments with option SR-COMP.

From the Trigger menu, select Bus setup.

Overview. Use the controls to set up the RS-232 Bus parameters.

To use. For information on the controls, click the buttons.

- [Trigger Type](#)
- [Mark All Trigger Events](#)
- [Bus](#)
- [Logic Thresholds](#)

Trigger - Bus A:Bus → Acquire

Trigger Type: Bus

Bus: B1

Bus Type: RS-232

Mark All Trigger Events in Record

The diagram shows a clock signal at the bottom. Above it, a data signal is shown with a Start Bit (1), a Data Word (LSB to MSB: 1, 0, 1, 0, 0, 1, 1), a Parity Bit (1), and a Stop Bit (1). The data signal is labeled 'Data' and the clock is labeled 'Clock'.

To use.

- Click the Trigger Type box and select Bus from the drop-down list.
- Click the Bus box and select the bus number or name from the drop-down list.

NOTE. You have the option to add a user-defined label for bus sources.

- Click the Logic Thresholds Setup button to set the voltage threshold levels for the channels in the bus.
- Select the type of bus cycle or activity to use as the trigger from the Trigger On drop-down list.
- For some Trigger On selections, you must set additional fields to define other parameters such as for a Data.

In this example, you need to set the Data Format (click the drop-down list), Number of Bytes, and Data Value (click the [Edit](#) button).

Not recommended for use with iCapture inputs.

What do you want to do next?

[Learn about bus setups.](#)

Set up a USB bus trigger

NOTE. The Bus Trigger Control Window for USB Serial option is available only on instruments with option SR-USB.

From the Trigger menu, select Bus setup.

Overview. Use the controls to set up the USB Bus parameters.

To use. For information on the controls, click the buttons.

- [Trigger Type](#)
- [Mark All Trigger Events](#)
- [Bus](#)
- [Logic Thresholds](#)

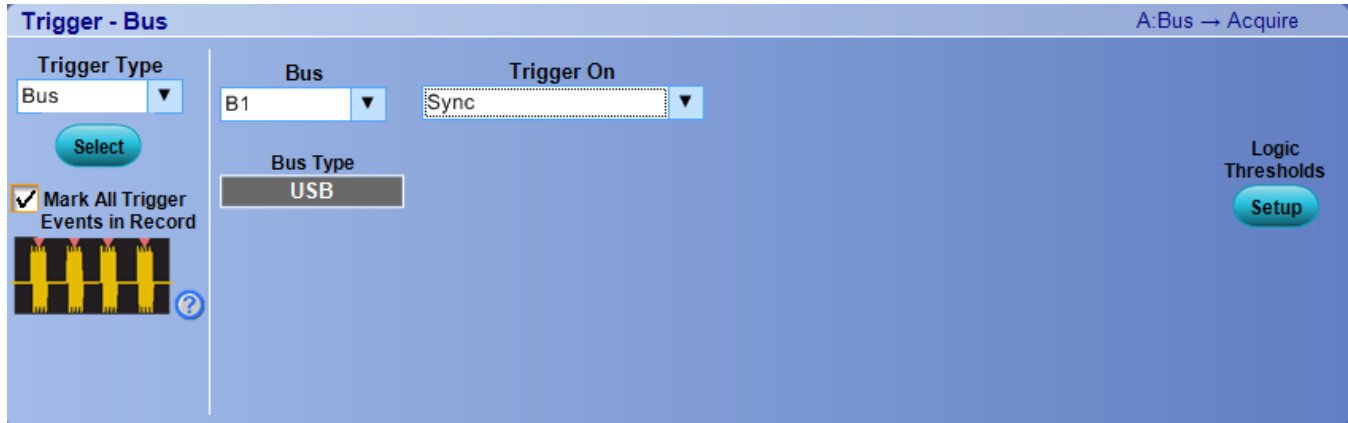

To use.

- Click the Trigger Type box and select Bus from the drop-down list.
- Click the Bus box and select the bus number or name from the drop-down list.

NOTE. You have the option to add a user-defined label for bus sources.

- Click the Logic Thresholds Setup button to set the voltage threshold levels for the channels in the bus.
- Select the type of bus cycle or activity to use as the trigger from the Trigger On drop-down list.
- For some Trigger On selections, you must set additional fields to define other parameters such as for a Data Packet.

In this example, you need to set a Data Packet Type, Trigger when data packet is, Data Format, Number of Bytes, Byte Offset, and Data Value (click the *Edit* button). Optionally, you can also set the component threshold levels through the Logic Thresholds Setup button.

Click the Trigger On selections Token (Address) Packet, Handshake Packet, Special Packet, or Error to view their parameters. What do you want to do next?

[Learn about bus setups.](#)

Trigger on Token (Address) Packet

Trigger on Handshake Packet

The handshake type options available in Trigger on Handshake Packet are as follows:

| Trigger On | Handshake Type |
|------------------|----------------|
| Handshake Packet | ANY (XX10) |
| | ACK (0010) |
| | NAK (1010) |
| | STALL (1110) |

Trigger on Special Packet

The special type options available in Trigger on Special Packet are as follows:

| Trigger On | Special Type |
|----------------|-----------------|
| Special Packet | ANY (XX00) |
| | ERR (1100) |
| | SPLIT (1000) |
| | PING (0100) |
| | Reserved (0000) |

In the USB bus setup window, set the Speed to High (480 Mbps).

In the Trigger setup window, set the Trigger On condition to Special Packet. Here you have the option to trigger on ANY, specifically on ERR (high only), SPLIT (high only), PING (high only) or Reserved special types.

The Trigger on SPLIT token field allows you set the Hub Format and Address, Port Format and Address, Start/Complete, Start and End bits, and Endpoint Type.

Trigger on Error

The error type options available in Trigger on Error are as follows:

| Trigger On | Error Type |
|------------|------------------|
| Error ▼ | PID Check Bits ▼ |
| | Token CRC5 |
| | Data CRC16 |
| | Bit Stuffing |

NOTE. The Bit Stuffing error type option is not available on high speed bus.

Start/Complete

The options available in Start/Complete are as follows:

| Start/Complete |
|-----------------------|
| Don't Care (X) ▼ |
| Don't Care (X) |
| Start (SSPLIT) (0) |
| Complete (CSPLIT) (1) |

Start and end bits

The options available in Start and End bits are as follows:

| |
|---|
| Don't Care (X) |
| Control/Bulk/Interrupt Full Speed Device (0X) |
| Control/Bulk/Interrupt Low Speed Device (1X) |
| Isochronous Data is Middle (00) |
| Isochronous Data is End (01) |
| Isochronous Data is Start (10) |
| Isochronous Data is All (11) |
| Don't Care (X) ▼ |

Endpoint type

The options available in Endpoint Type are as follows:

| |
|------------------|
| Don't Care (X) |
| Control (00) |
| Isochronous (01) |
| Bulk (10) |
| Interrupt (11) |
| Don't Care (X) ▼ |

Set up a PCIe bus trigger

NOTE. The Bus Trigger Control Window for PCIe Serial option is available only on instruments with option SR-PCIE.

From the Trigger menu, select Bus setup.

Overview. Use the controls to set up the PCIe Bus parameters.

To use. For information on the controls, click the buttons.

- [Trigger Type](#)
- [Mark All Trigger Events](#)
- [Bus](#)
- [Logic Thresholds](#)

Trigger - Bus A:Bus → Acquire

Trigger Type
 Bus ▼
 Select

Mark All Trigger Events in Record

Bus
 B1 ▼

Bus Type
 PCIe

Trigger On
 Pattern ▼

Edit

- Ordered Set
- Character
- Symbol

Disparity
 Either ▼

Characters
 COM SKP SKP SKP

Symbols RD+
 1100000101 0011110100 0011110100 0011110100

Symbols RD-
 0011111010 1100001011 1100001011 1100001011

Logic Thresholds
 Setup

To use.

- Click the Trigger Type box and select Bus from the drop-down list.
- Click the Bus box and select the bus number or name from the drop-down list.

NOTE. You have the option to add a user-defined label for bus sources.

- Click the Logic Thresholds Setup button to set the voltage threshold levels for the channels in the bus.
- Select the type of bus cycle or activity to use as the trigger from the Trigger On drop-down list.
- For some Trigger On selections, you must set additional fields to define other parameters such as for a Pattern.

In this example, you need to set the Character or Symbol values and select the Disparity. You can also set the component threshold levels through the Logic Thresholds Setup button.

Click the Trigger On selections Character/Symbol or Error to view their parameters.

What do you want to do next?

[Learn about bus setups.](#)

Trigger on Character/Symbol
Trigger on Error

The error type options available in Trigger on Error are as follows:

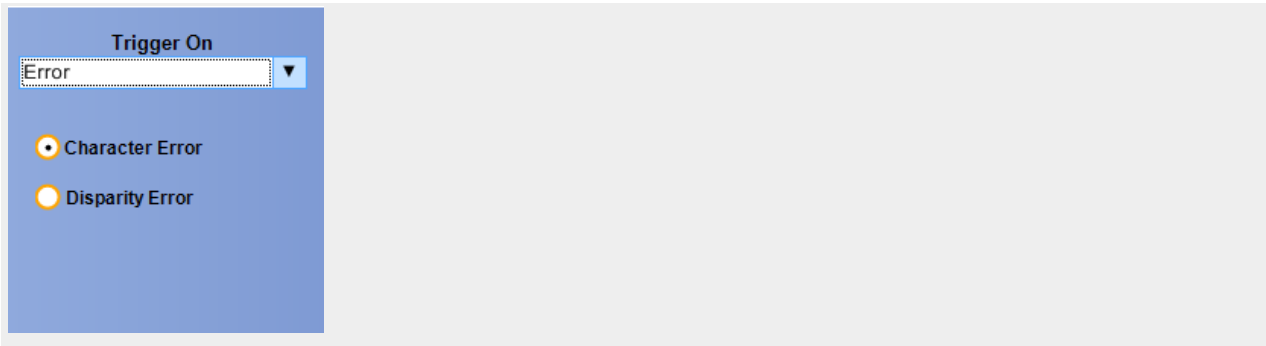

NOTE. Trigger is only supported for a PCIe bus with a data rate selection of 5 Gb/s and below.

Set up a CAN bus trigger

NOTE. The Bus Trigger Control Window for CAN Serial option is available only on instruments with option SR-AUTO.

From the Trigger menu, select Bus setup.

Overview. Use the controls to set up the CAN Bus parameters.

To use. For information on the controls, click the buttons.

- [Trigger Type](#)
- [Mark All Trigger Events](#)
- [Bus](#)
- [Logic Thresholds](#)

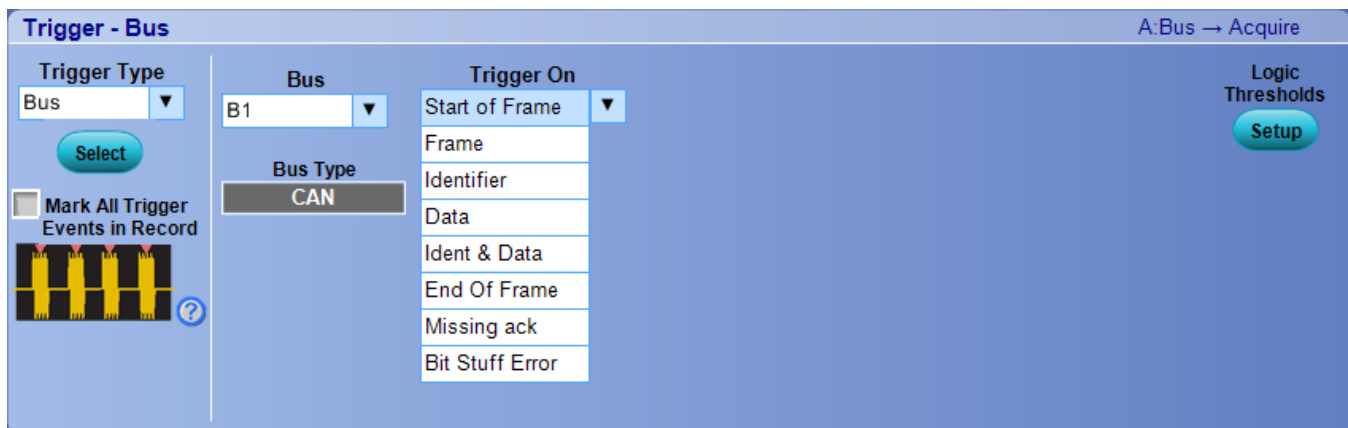

To use.

- Click the Trigger Type box and select Bus from the drop-down list.
- Click the Bus box and select the bus number or name from the drop-down list.

NOTE. You have the option to add a user-defined label for bus sources.

- Click the Logic Thresholds Setup button to set the voltage threshold levels for the channels in the bus.
- Select the type of bus cycle or activity to use as the trigger from the Trigger On drop-down list.
- For some Trigger On selections, you must set additional fields to define other parameters such as for a Ident & Data.

In this example, you need to set the Trigger When Identifier, When Direction values, and select the And when data is values. You can also set the component threshold levels through the Logic Thresholds Setup button.

Select the Trigger On selections to view their parameters.

What do you want to do next?

[Learn about bus setups.](#)

Set up a CAN bus trigger

NOTE. The CAN Bus Trigger type is only available on DPO7000C Series instruments.

From the Trig menu, select CAN Setup.

NOTE. You must install Low Speed Serial Analysis (CAN/LIN trigger) before you can access the CAN triggers.

Overview. Use the controls in this window to set up the parameters to trigger on a CAN bus.

To use. For information on the controls, click the buttons.

- [Trigger Type](#)
- [Settings](#)
- [Signal Type](#)
- [Data Source](#)
- [Data Threshold](#)
- [Bit Rate](#)
- [Trigger On](#)
- [CAN Format](#)

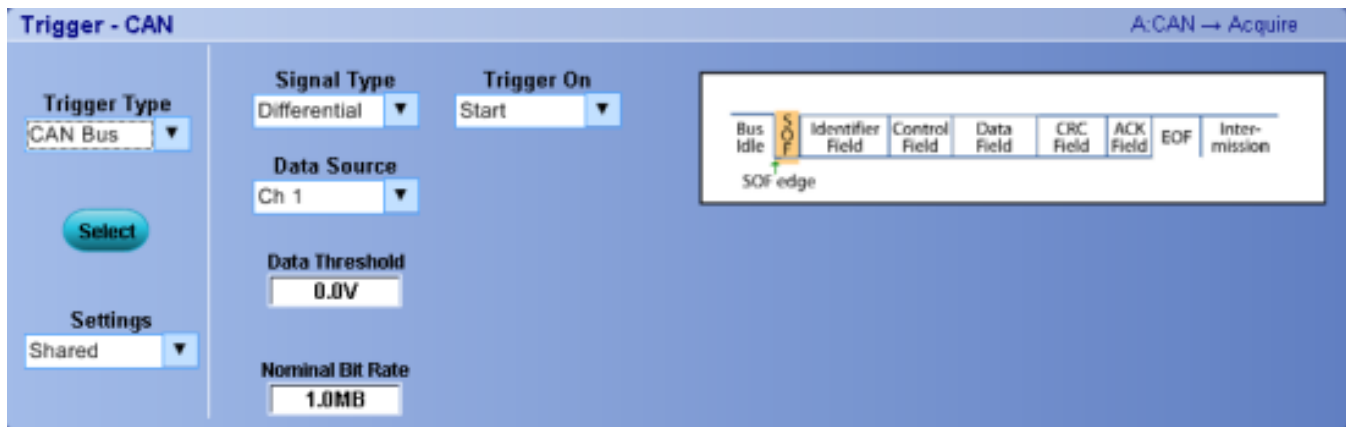

Behavior. Use this trigger to analyze CAN_H or CAN_L bus data frames with single-ended probes, or use a differential probe to read both signals simultaneously.

NOTE. For low-speed Serial triggering on data streams, the instrument implicitly pads the MSB side of the entered value, up to the next byte, with "don't care" values (X). To trigger on a two-byte message, you must enter don't care values explicitly up to the desired size.

For example, a binary entered value of 01 is equivalent to XXXX XX01, whereas a two-byte message would be entered as XXXX XXXX XX01.

Not recommended for use with iCapture inputs.

Set up a LIN bus trigger

NOTE. The Bus Trigger Control Window for LIN Serial option is available only on instruments with option SR-AUTO.

From the Trigger menu, select Bus setup.

Overview. Use the controls to set up the LIN Bus parameters.

To use. For information on the controls, click the buttons.

- [Trigger Type](#)
- [Mark All Trigger Events](#)
- [Bus](#)
- [Logic Thresholds](#)

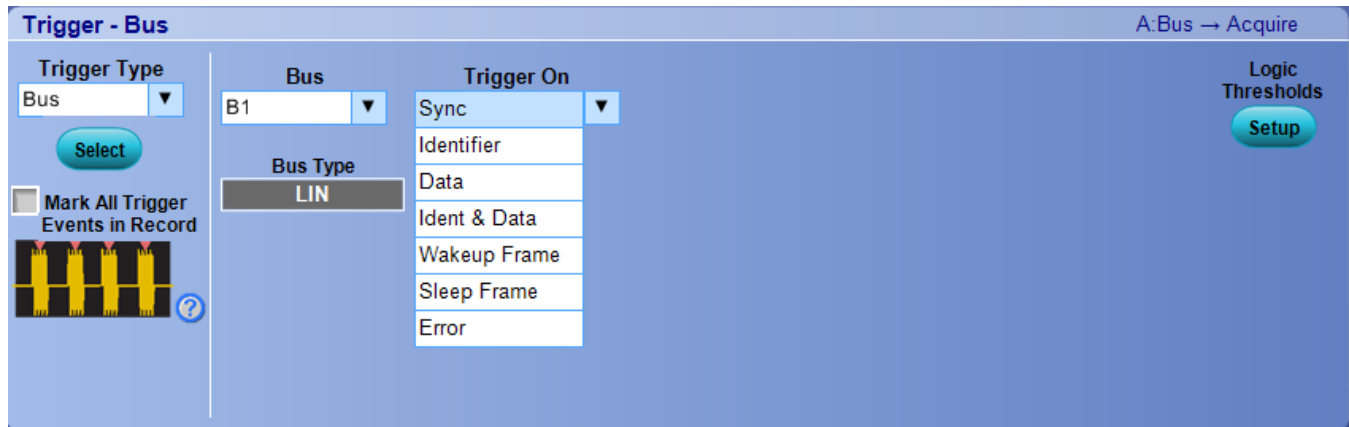

To use.

- Click the Trigger Type box and select Bus from the drop-down list.
- Click the Bus box and select the bus number or name from the drop-down list.

NOTE. You have the option to add a user-defined label for bus sources.

- Click the Logic Thresholds Setup button to set the voltage threshold levels for the channels in the bus.
- Select the type of bus cycle or activity to use as the trigger from the Trigger On drop-down list.
- For some Trigger On selections, you must set additional fields to define other parameters such as for a Ident & Data.

In this example, you need to set the Trigger when Identifier and the And When Data is values. You can also set the component threshold levels through the Logic Thresholds Setup button.

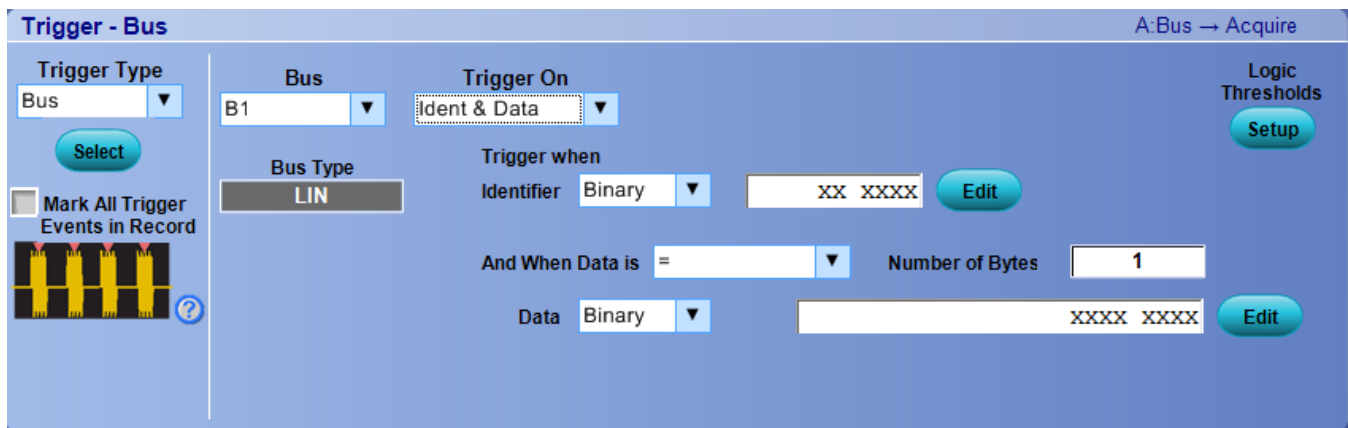

Click the Trigger On selections to view their parameters.

What do you want to do next?

[Learn about bus setups.](#)

Set up a FLEXRAY bus trigger

NOTE. The Bus Trigger Control Window for FLEXRAY Serial option is available only on instruments with option SR-AUTO.

From the Trigger menu, select Bus setup.

Overview. Use the controls to set up the FLEXRAY Bus parameters.

To use. For information on the controls, click the buttons.

- [Trigger Type](#)
- [Mark All Trigger Events](#)
- [Bus](#)
- [Logic Thresholds](#)



To use.

- Click the Trigger Type box and select Bus from the drop-down list.
- Click the Bus box and select the bus number or name from the drop-down list.

NOTE. You have the option to add a user-defined label for bus sources.

- Click the Logic Thresholds Setup button to set the voltage threshold levels for the channels in the bus.
- Select the type of bus cycle or activity to use as the trigger from the Trigger On drop-down list.
- For some Trigger On selections, you must set additional fields to define other parameters such as for a Ident & Data.

In this example, you need to set the Identifier, Data, Number of Bytes, Offset, and Qualifier values. You can also set the component threshold levels through the Logic Thresholds Setup button.

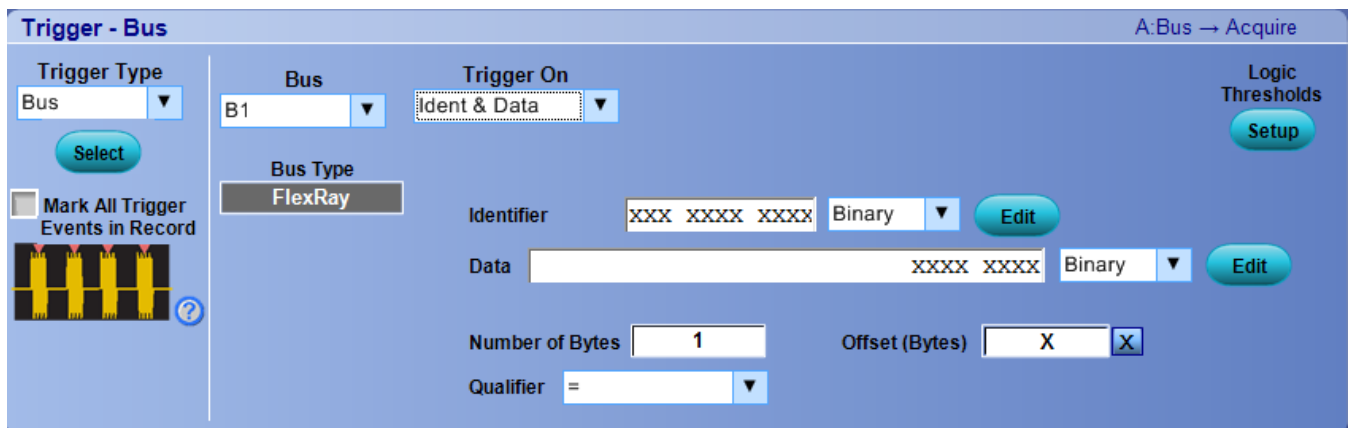

Click the Trigger On selections Header Fields or Cycle Count to view their parameters.

What do you want to do next?

[Learn about bus setups.](#)

Trigger on Header Fields

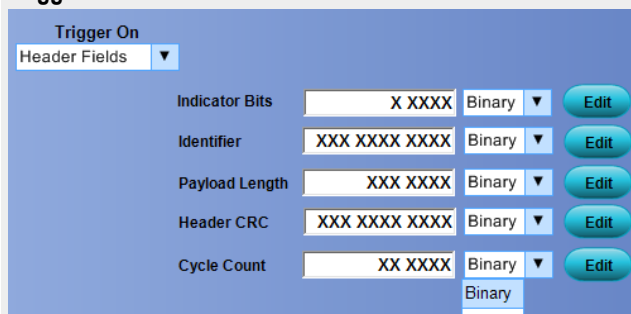

Trigger on Cycle Count

The options available in Trigger on Cycle Count are as follows:

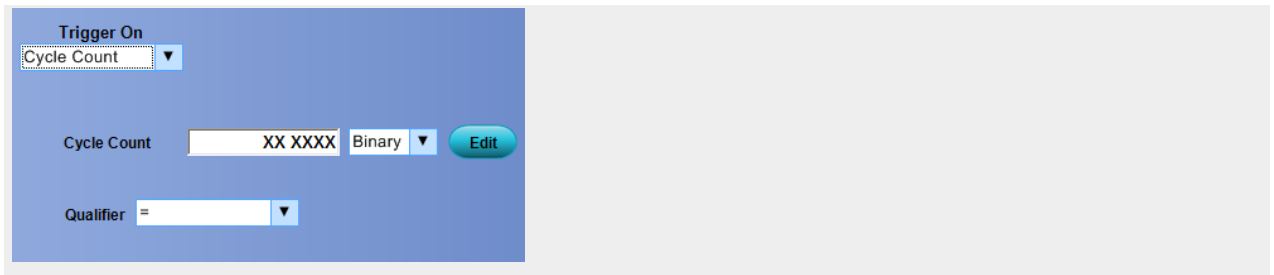

Set up a MIL-1553 bus trigger

NOTE. The Bus Trigger Control Window for MIL-STD-1553 Serial option is available only on instruments with option SR-AERO.

From the Trigger menu, select Bus setup.

Overview. Use the controls to set up the MIL-STD-1553 Bus parameters.

To use. For information on the controls, click the buttons.

- [Trigger Type](#)
- [Mark All Trigger Events](#)
- [Bus](#)
- [Logic Thresholds](#)

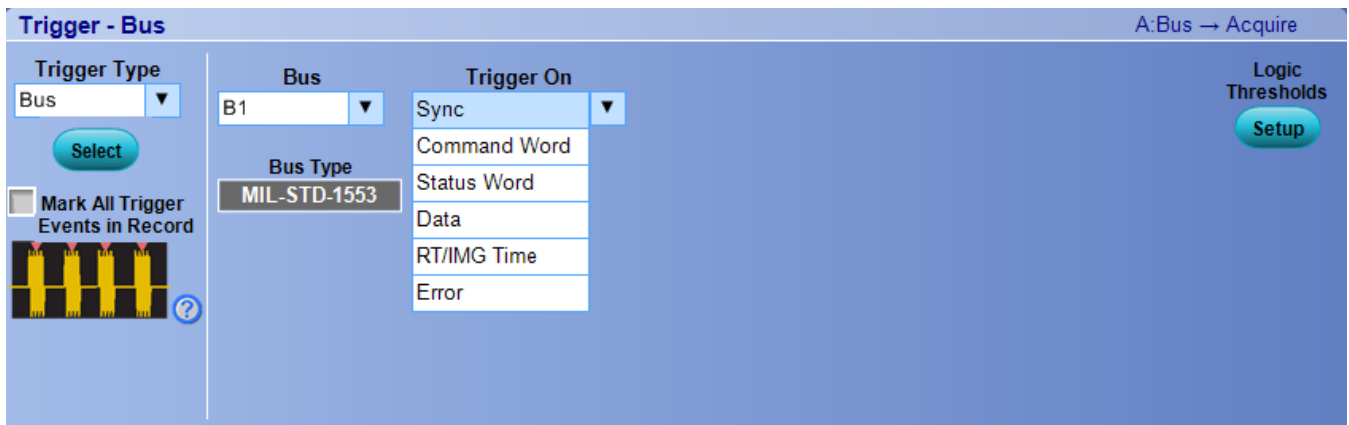

To use.

- Click the Trigger Type box and select Bus from the drop-down list.
- Click the Bus box and select the bus number or name from the drop-down list.
- Click the Logic Thresholds Setup button to set the voltage threshold levels for the channels in the bus.
- Select the type of bus cycle or activity to use as the trigger from the Trigger On drop-down list.
- For some Trigger On selections, you must set additional fields to define other parameters such as for a Ident & Data.

In this example, you need to set the Trigger When Address is, RT Address type and values, the T/R bit, Subaddress/Mode type and value, and select the Word Count/ModeCode type and value. You can also set the Parity.

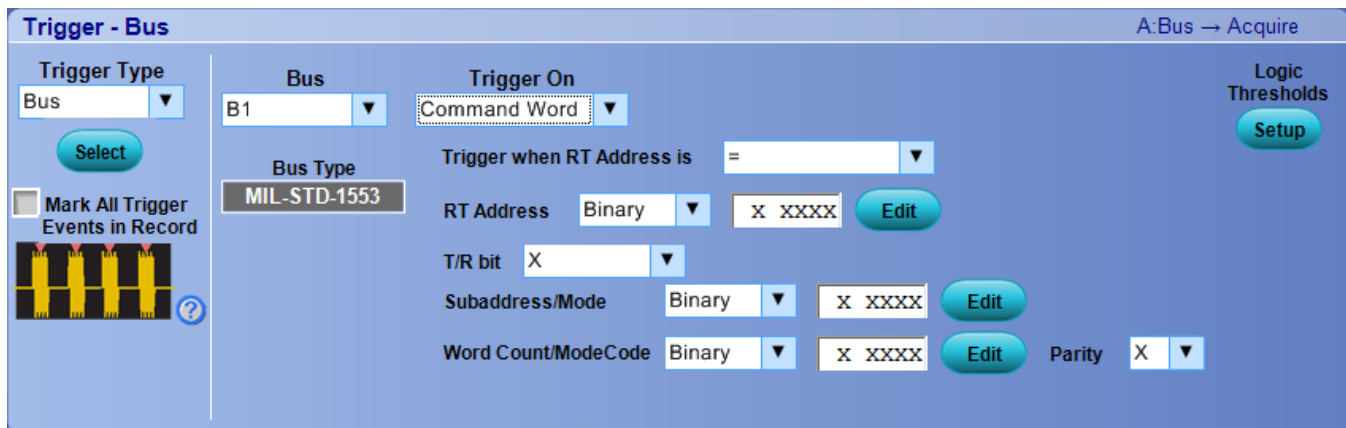

Click the Trigger On selections Status Word, Data, Sync, RT/IMG Time, or Error to view their parameters.

What do you want to do next?

[Learn about bus setups.](#)

Trigger on Status Word

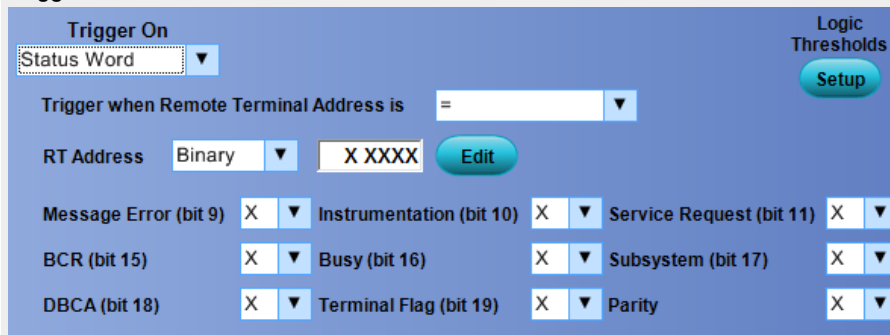

Trigger on Data

The error type options available in Trigger on Data are as follows:

Trigger On

Data ▼

Trigger when data is

Data Binary ▼

Parity X ▼

Trigger on Sync

Trigger On

Sync ▼

Trigger on RT/IMG Time

The error type options available in Trigger on RT/IMG Time are as follows:

Trigger On

RT/IMG Time ▼

Trigger when data is ▼

Maximum Time

Minimum Time

Trigger on Error

The error type options available in Trigger on Error are as follows:

| Trigger On | Error Type |
|--|--|
| Error <input type="text" value="Error"/> ▼ | Parity Error <input type="text" value="Parity Error"/> ▼ |
| | Sync Error |
| | Manchester Error |
| | Non-Contiguous Data |

Set up an ethernet bus trigger

NOTE. The Bus Trigger Control Window for Ethernet Serial option is available only on DPO/MSO5000B Series instruments with option SR-ENET.

From the Trigger menu, select Bus setup.

Overview. Use the controls to set up the Ethernet Bus parameters.

To use. For information on the controls, click the buttons.

- [Trigger Type](#)
- [Mark All Trigger Events](#)
- [Bus](#)
- [Logic Thresholds](#)

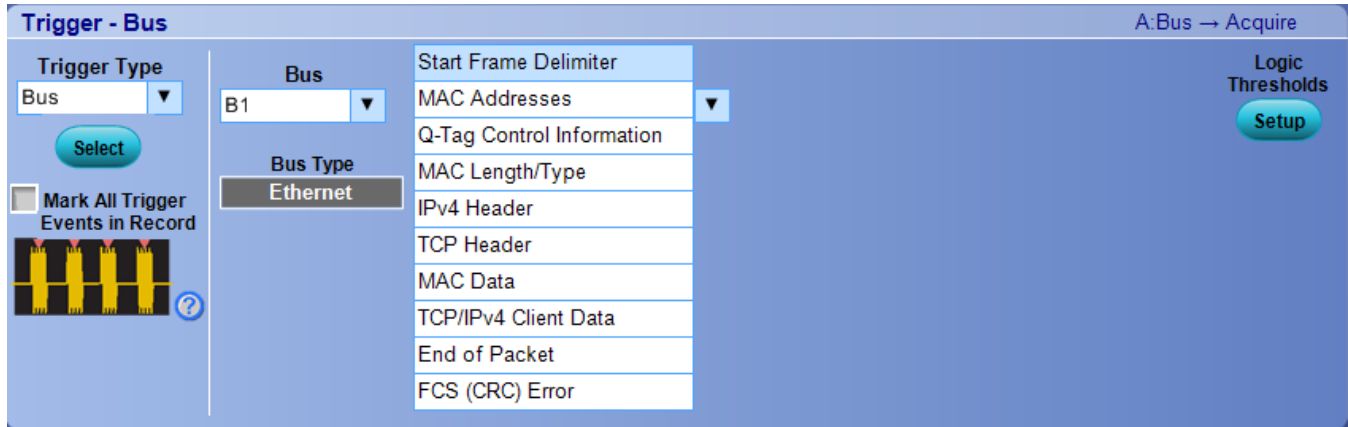

To use.

- Click the Trigger Type box and select Bus from the drop-down list.
- Click the Bus box and select the bus number or name from the drop-down list.
- Click the Logic Thresholds Setup button to set the voltage threshold levels for the channels in the bus.
- Select the type of bus cycle or activity to use as the trigger from the Trigger On drop-down list.
- For some Trigger On selections, you must set additional fields to define other parameters such as for a TCP Header. In this example, you need to set the Source Port, Destination Port, Seq Number, and set the Acq Number.

Click the Trigger On selections Start Frame Delimiter, MAC Addresses, Q-Tag Control Information, MAC Length/Type, IPv4 Header, TCP/IPv4 Client Data, MAC Data, End of Packet, Idle, or FCS (CRC) Error to view their parameters.

What do you want to do next?

[Learn about bus setups.](#)

Trigger on Start Frame Delimiter

Select Start Frame Delimiter to trigger on an Ethernet Start Frame Delimiter.

Trigger on MAC Addresses

For Trigger On MAC Addresses you need to set the Source MAC and the Destination MAC.

The screenshot shows the 'Trigger On' configuration window for 'MAC Addresses'. The 'Bus' is set to 'B1' and the 'Bus Type' is 'Ethernet'. The 'Trigger On' dropdown is set to 'MAC Addresses'. There are two input fields: 'Source MAC' and 'Destination MAC', both containing 'XX:XX:XX:XX:XX:XX' and set to 'Hex' format. Each field has an 'Edit' button. A 'Logic Thresholds Setup' button is also present.

Trigger on Q-Tag Control Information

For Trigger on Q-Tag Control Information you need to specify the Q-tag Value.

The screenshot shows the 'Trigger On' configuration window for 'Q-Tag Control Information'. The 'Bus' is 'B1' and the 'Bus Type' is 'Ethernet'. The 'Trigger On' dropdown is set to 'Q-Tag Control Information'. There is one input field for 'Q-tag Value' containing '8100 XXXX' and set to 'Hex' format, with an 'Edit' button. A 'Logic Thresholds Setup' button is also present.

Trigger on MAC Length/Type

For Trigger on MAC Length/Type you need to specify the MAC length and type.

The screenshot shows the 'Trigger On' configuration window for 'MAC Length/Type'. The 'Bus' is 'B1' and the 'Bus Type' is 'Ethernet'. The 'Trigger On' dropdown is set to 'MAC Length/Type'. There is one input field for 'MAC Length/Type' containing '=', followed by a dropdown set to 'XXXX' and set to 'Hex' format, with an 'Edit' button. A 'Logic Thresholds Setup' button is also present.

Trigger on IPv4 Header

For Trigger on IPv4 Header you need to enter the IP Protocol, Source Address, and the Destination Address.

The screenshot shows the 'Trigger On' configuration window for 'IPv4 Header'. The 'Bus' is 'B1' and the 'Bus Type' is 'Ethernet'. The 'Trigger On' dropdown is set to 'IPv4 Header'. There are three input fields: 'IP Protocol' (containing 'XX'), 'Source Address' (containing 'XX.XX.XX.XX'), and 'Destination Address' (containing 'XX.XX.XX.XX'), all set to 'Hex' format. Each field has an 'Edit' button. A 'Logic Thresholds Setup' button is also present.

Trigger on TCP/IPv4 Client Data

For Trigger On TCP/IPv4 Client Data you need to specify the Data, Number of Bytes, Offset, and the Qualifier.

The screenshot shows the configuration window for triggering on TCP/IPv4 Client Data. The interface is titled "A:Bus → Acquire". It features a "Bus" dropdown menu set to "B1" and a "Trigger On" dropdown menu set to "TCP/IPv4 Client Data". There is a "Logic Thresholds Setup" button in the top right. Under "Bus Type", "Ethernet" is selected. The "Data" field contains "XXXX XXXX" with a "Binary" dropdown and an "Edit" button. The "Number of Bytes" is set to "1" and the "Offset (Bytes)" is set to "X". The "Qualifier" is set to "=". There is also a "Logic Thresholds Setup" button in the top right.

Trigger on MAC Data

For Trigger On MAC Data you need to specify the Data, Number of Bytes, Offset, and the Qualifier.

The screenshot shows the configuration window for triggering on MAC Data. The interface is titled "A:Bus → Acquire". It features a "Bus" dropdown menu set to "B1" and a "Trigger On" dropdown menu set to "MAC Data". There is a "Logic Thresholds Setup" button in the top right. Under "Bus Type", "Ethernet" is selected. The "Data" field contains "XXXX XXXX" with a "Binary" dropdown and an "Edit" button. The "Number of Bytes" is set to "1" and the "Offset (Bytes)" is set to "X". The "Qualifier" is set to "=". There is also a "Logic Thresholds Setup" button in the top right.

Trigger on End of Packet

Select End of Packet to trigger on an Ethernet End of Packet.

The screenshot shows the configuration window for triggering on End of Packet. The interface is titled "A:Bus → Acquire". It features a "Bus" dropdown menu set to "B1" and a "Trigger On" dropdown menu set to "End of Packet". There is a "Logic Thresholds Setup" button in the top right. Under "Bus Type", "Ethernet" is selected. The "Data" field is empty. The "Number of Bytes" is set to "1" and the "Offset (Bytes)" is set to "X". The "Qualifier" is set to "=". There is also a "Logic Thresholds Setup" button in the top right.

Trigger on Idle

Select Idle to trigger on an Ethernet idle character.

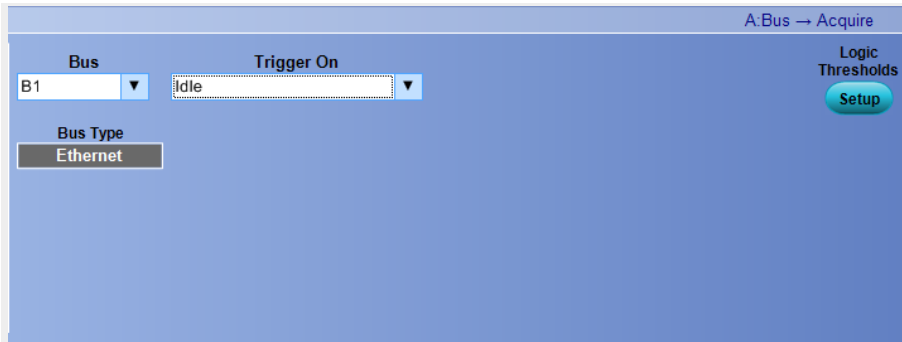

Trigger on FCS (CRC) Error

Select FCS (CRC) Error to trigger on an Ethernet FCS error.

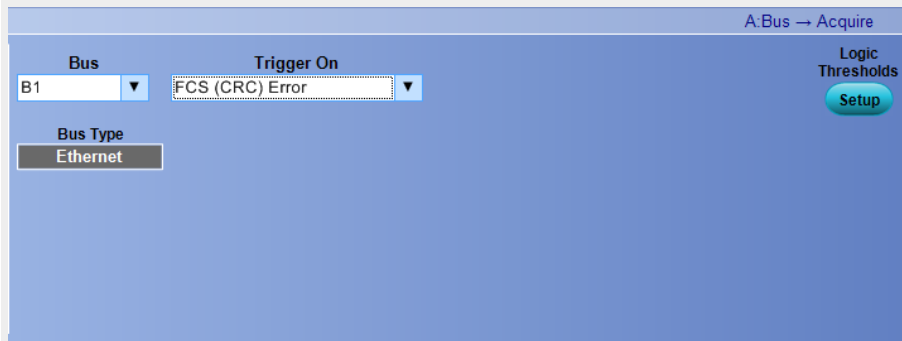

Set up a comm trigger

From the Trig menu, select Comm Setup.

NOTE. The Comm Trigger is designed to work with communications mask and standard testing. Mask testing automatically uses Communication triggers. You must install the [Serial Communications Mask Testing Option](#) on some instruments before you can access the Comm triggers.

Overview. Use the controls in this window to select the trigger source, coding format, and standard for communications testing.

NOTE. The Comm trigger is only available on analog channels.

To use. For information on the controls, click the buttons.

- [Trigger Type](#)
- [Settings](#)
- [Source / Type / Polarity](#)
- [Coding / Standard / Bit Rate](#)
- [Level](#)
- [Pulse Form](#)

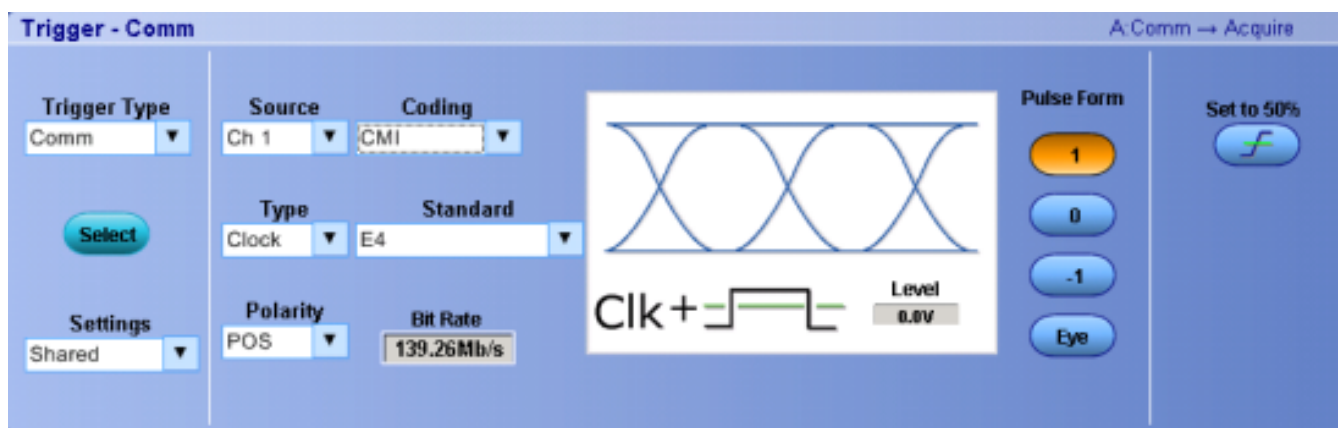

Depending on which coding format you use, you can also change the Upper, Lower, and Clock level thresholds and the pulse form using the multipurpose knobs.

Behavior. Use the Comm Trigger control window to trigger the instrument in conjunction with mask testing on communications codes and standards. The controls work together to define the parameters for the trigger event. The standards that appear in the Standard drop-down list depend on the coding format that you selected. The coding format also determines whether upper, lower, single, or clock threshold levels or pulse forms are used. The standard determines the bit rate. When you click on the trigger window controls, the trigger graphic shows the trigger sequence.

What do you want to do next?

[Learn more about other trigger types.](#)

[Return to the Trigger Setup control window.](#)

[Learn about Set to 50% with Comm triggers.](#)

Trigger graphic

The trigger graphic displays a visual indicator of the trigger criteria. Depending on the trigger type, the instrument will update the graphic as you define the trigger parameters.

Set up an edge trigger

From the Trig menu, select Edge Setup.

Overview. Use the controls in this window to set up Edge trigger parameters for general-purpose testing.

To use. For information on the controls, click the buttons.

- [Trigger Type](#)
- [Mark All Trigger Events](#)
- [Settings](#)
- [Source](#)
- [Set to 50%](#)
- [Level](#)
- [Coupling](#)
- [Slope](#)
- [Force Trigger](#)
- [Envelope](#)

The following Trigger Edge screen appears on MSO70000C/DX Series instruments:

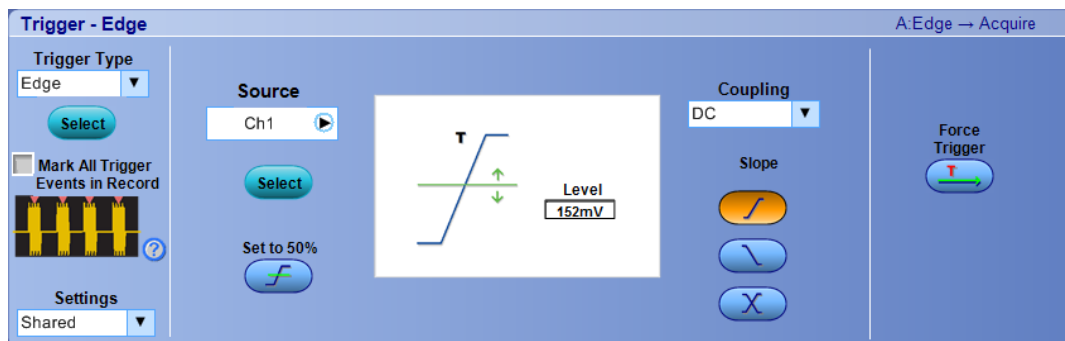

The following Trigger Edge screen appears on DPO70000SX Series instruments:

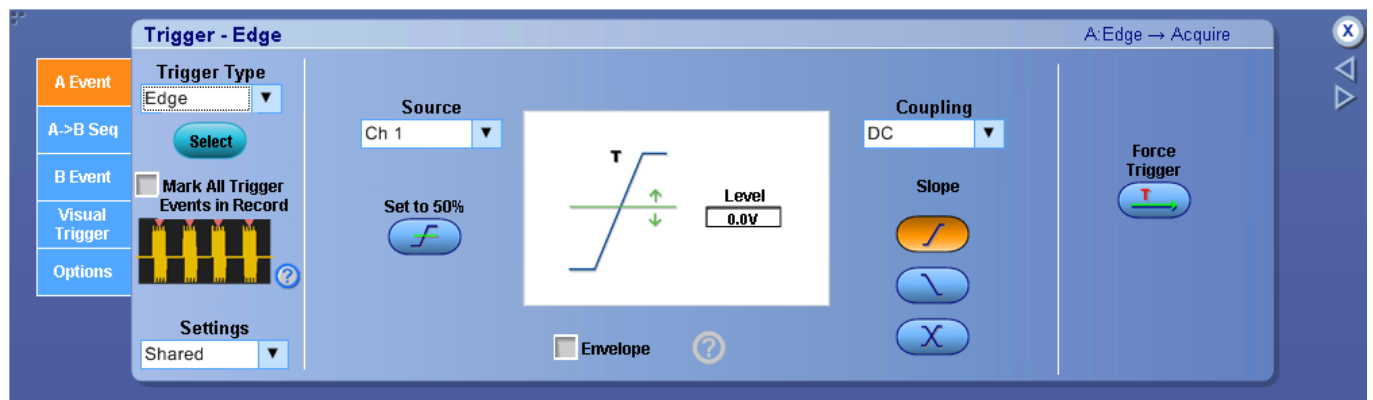

Behavior. Edge triggering is the most common way to trigger an instrument. The trigger occurs when the trigger source passes through a specific level on the specified slope (rising or falling).

What do you want to do next?

[Learn more about other trigger types.](#)

[Return to the Trigger Setup control window.](#)

Trigger slope

The trigger slope determines whether the instrument finds the trigger point on the rising edge, falling edge, or both edges of the signal.

Set up a Freq/Period trigger

From the Trig menu, select Freq/Per Setup.

Overview. Use the controls in this window to set up the frequency or period trigger parameters.

Behavior. For information on the controls, click the buttons.

- [Trigger Type](#)
- [Mark All Trigger Events](#)
- [Settings](#)
- [Source](#)
- [Set to 50%](#)
- [Level](#)
- [Pulse Period Limits](#)
- [Polarity](#)
- [Trigger If Period](#)
- [Logic pattern](#)

NOTE. In some instruments, the source selection is a drop-down list and the Trigger if Period Qualification option has Occurs and Logic. In other instruments the source selection includes a combo list and a Select button. The Trigger if Period Qualification option has Occurs, Logic, and Occurs And.

The following Trigger Freq/Per screen appears on DPO70000SX Series instruments:

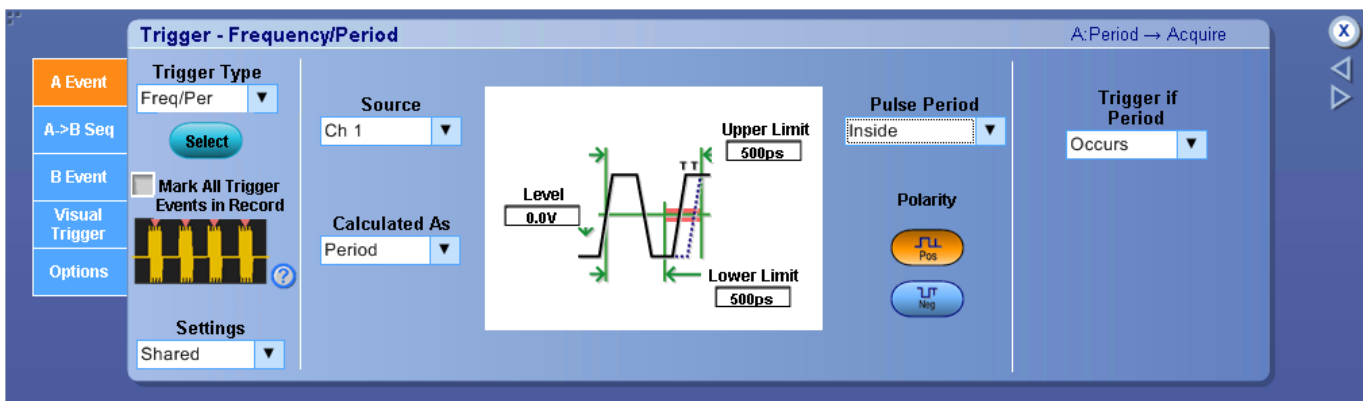

NOTE. This online help file supports many oscilloscope models from Tektronix. This feature is only available on some models.

Behavior. Use the Freq/Per trigger to trigger the instrument on a frequency or period that is either within or outside the specified range. The range is defined by the Upper Limit and Lower Limit controls. You can specify frequencies or periods for either positive or negative pulses. The frequency and period are measured at the voltage level specified by the Level control. The trigger can also be qualified by the logical state of other channels. When you click on the trigger window controls, the trigger graphic shows the trigger sequence.

NOTE. You have the option to add user-defined labels for analog, reference, bus, and digital sources.

What do you want to do next?

[Learn more about other trigger types.](#)

[Return to the Trigger Setup control window.](#)

Trigger graphic

The trigger graphic displays a visual indicator of the trigger criteria. Depending on the trigger type, the instrument will update the graphic as you define the trigger parameters.

Set up a glitch trigger

From the Trig menu, select Glitch Setup.

Overview. Use the controls in this window to set up the Glitch trigger parameters.

To use. For information on the controls, click the buttons.

- [Trigger Type](#)
- [Mark All Trigger Events](#)
- [Settings](#)
- [Source](#)
- [Set to 50%](#)
- [Level](#)
- [Glitch Width](#)
- [Polarity](#)
- [Qualification](#)
- [Pattern](#)
- [Edit Button](#)
- [HF Filtering](#)
- [Envelope](#)

NOTE. The Trigger Glitch screen on a DPO Series instrument is the same as that on an MSO/DPO5000B and MSO/DPO70000C/DX/SX Series instrument except for the source selection and Trigger if Glitch Qualification options. In MSO70000C/DX Series the source selection includes a combo list and a Select button. The Trigger if Glitch Qualification option has Occurs, Logic, and Occurs And.

The following Trigger Glitch screen appears on MSO/DPO70000C/DX Series instruments:

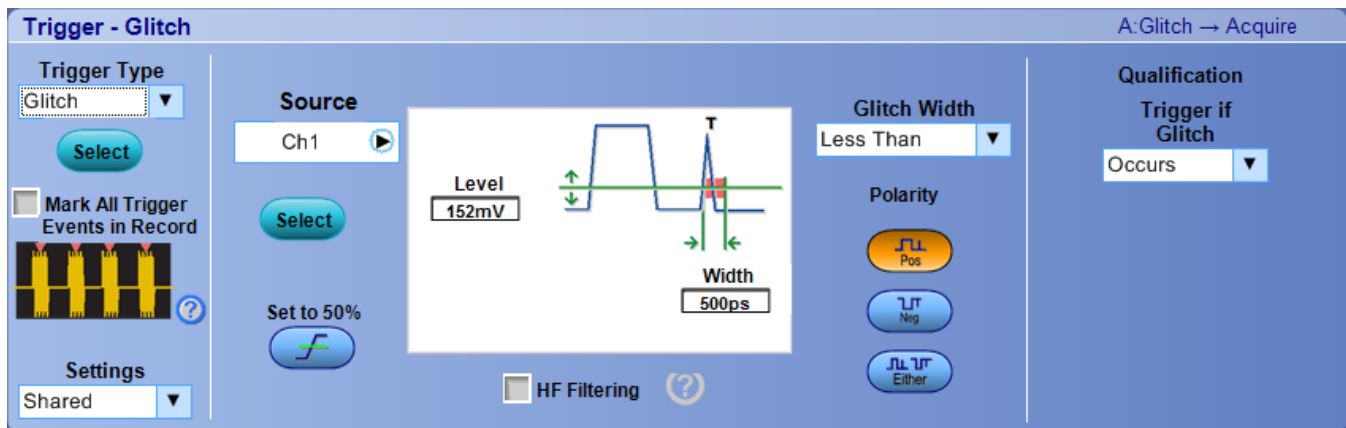

The following Trigger Glitch screen appears on DPO70000SX Series instruments:

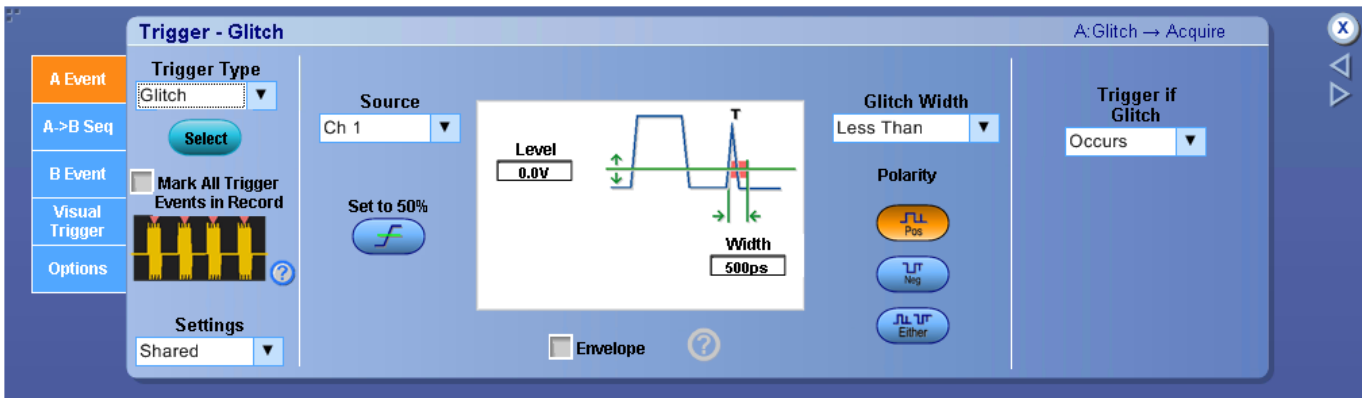

The following Trigger Glitch screen appears on MSO/DPO5000B Series instruments:

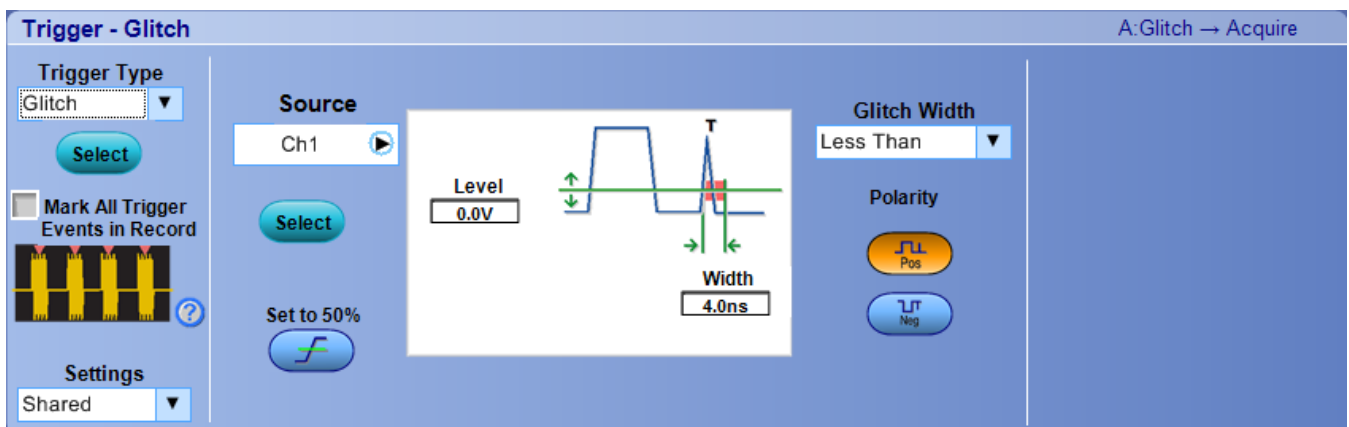

Behavior. Use the Glitch trigger to detect and trigger on a glitch or to ignore a glitch. Glitches are defined as pulses that are narrower than a specified time. The trigger occurs when the instrument detects a pulse outside (either less than or greater than) the parameters that you specify.

The trigger can also be qualified by the logical state of other channels or by a bus pattern (MSO70000C/DX Series only). When you click on the trigger window controls, the trigger graphic shows the trigger sequence.

What do you want to do next?

[Learn more about other trigger types.](#)

[Return to the Trigger Setup control window.](#)

Trigger graphic

The trigger graphic displays a visual indicator of the trigger criteria. Depending on the trigger type, the instrument will update the graphic as you define the trigger parameters.

Set up a logic pattern trigger

NOTE. This online help file supports many oscilloscope models from Tektronix. This feature is only available on some models.

From the Trig menu, select Logic Pattern. It includes the D15-D0 digital channels in the trigger setup on MSO models. DPO models include only the Ch1 - Ch4 analog channels.

Overview. Use the controls in this window to set up the Logic Pattern trigger parameters.

To use. For information on the controls, click the buttons.

- [Trigger Type](#)
- [Mark All Trigger Events](#)
- [Settings](#)
- [Pattern Type](#)
- [Pattern](#)
- [Edit Button](#)
- [Pattern Format](#)
- [Logic Thresholds](#)
- [Trigger if Logic State](#)

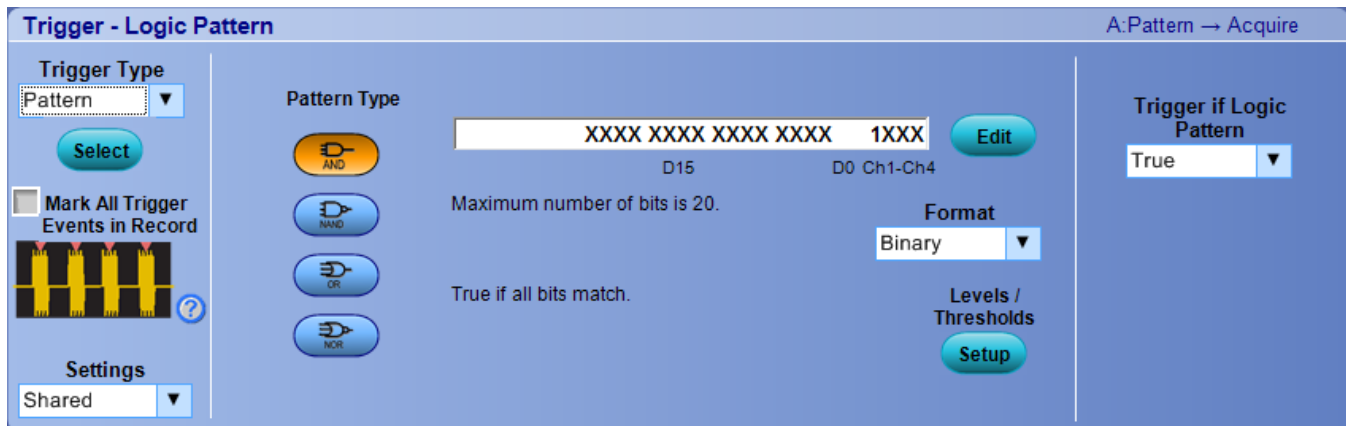

Behavior. Use the Logic Pattern trigger to trigger the instrument when the logic inputs cause the selected function to become True or False. You can also time qualify the trigger to specify that the logic conditions must be satisfied for a specific amount of time before the instrument triggers.

The Pattern Type buttons set the Boolean logic function for the trigger.

Not recommended for use with iCapture inputs.

What do you want to do next?

[Learn more about other trigger types.](#)

[Return to the Trigger Setup control window.](#)

Set up a logic pattern trigger

From the Trig menu, select Logic Pattern.

Overview. Use the controls in this window to set up the Logic Pattern trigger parameters.

To use. For information on the controls, click the buttons.

- [Trigger Type](#)
- [Mark All Trigger Events](#)
- [Settings](#)
- [Pattern Type](#)
- [Input Threshold](#)
- [Pattern](#)

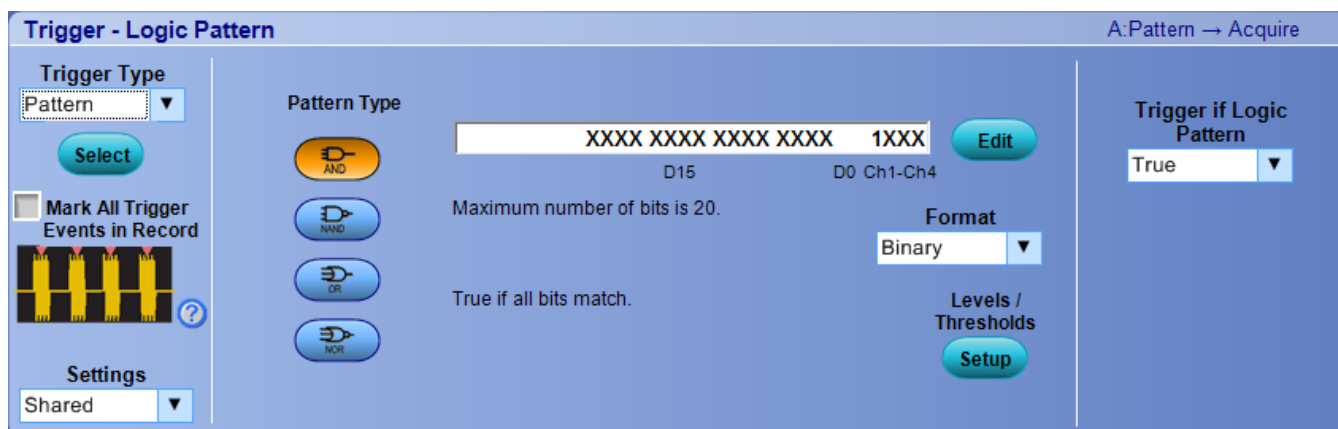

Behavior. Use the Pattern trigger to trigger the instrument when the logic inputs cause the selected function to become True or False. You can also time qualify the trigger to specify that the logic conditions must be satisfied for a specific amount of time before the instrument triggers.

The instrument input channels represent the data inputs. You can set each channel to be logic high, logic low, or "don't care". Use the multipurpose knobs to change the threshold voltages for logic levels other than TTL.

The Pattern Type buttons set the Boolean logic function for the trigger.

What do you want to do next?

[Learn more about other trigger types.](#)

[Return to the Trigger Setup control window.](#)

Set up a runt trigger

From the Trig menu, select Runt Setup.

Overview. Use the controls in this window to set up the Runt trigger parameters.

To use. For information on the controls, click the buttons.

- [Trigger Type](#)
- [Mark All Trigger Events](#)
- [Settings](#)
- [Source](#)
- [Levels](#)
- [Polarity](#)
- [Runt / Trigger if Runt](#)
- [Qualification](#)
- [Pattern](#)
- [Edit Button](#)

NOTE. The Trigger Runt screen on DPO and MSO Series instruments is the same except for the source selection and Trigger if Runt Qualification options. In some instruments, the source selection is a drop-down list and the Trigger if Runt Qualification option has Occurs and Logic. In other instruments the source selection includes a combo list and a Select button. The Trigger if Runt Qualification option has Occurs, Logic, and Occurs And.

The following Trigger Runt screen appears on MSO7000C/DX and DPO7000C Series instruments:

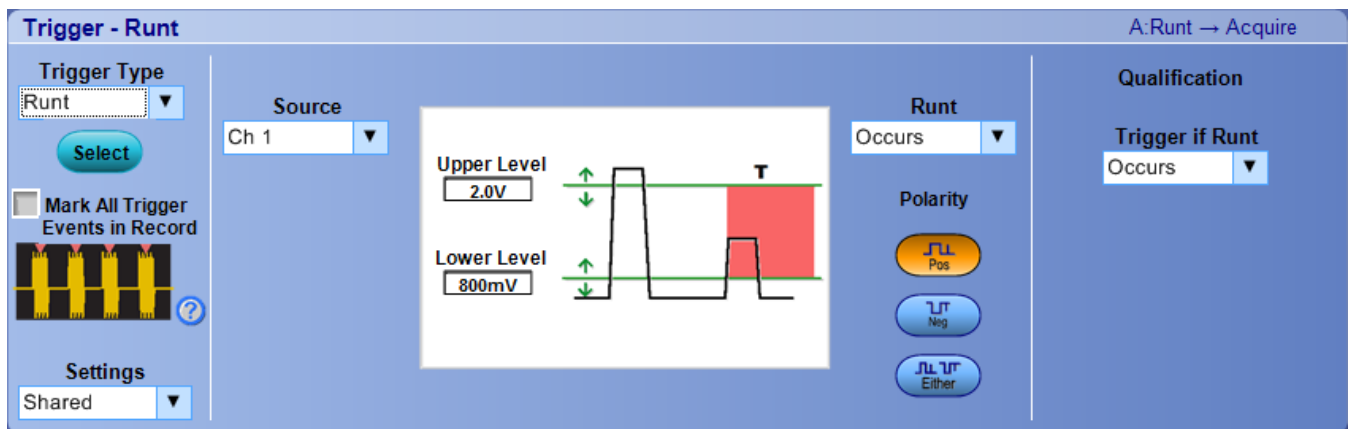

The following Trigger Runt screen appears on MSO/DPO5000B Series instruments:

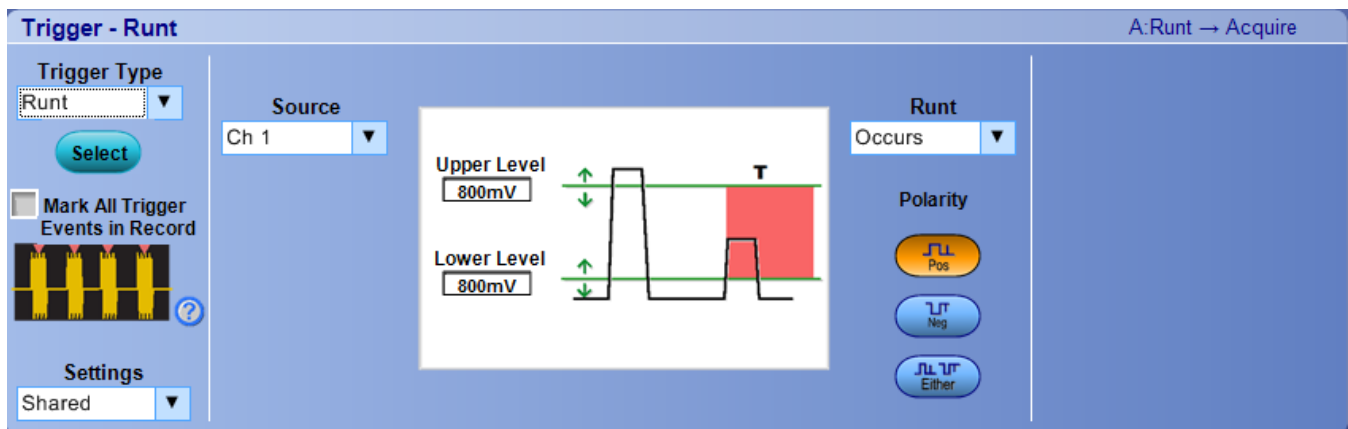

NOTE. Logic qualification option is not available on DPO5000B and MSO5000B Series instruments.

Behavior. Use the Upper Level and Lower Level threshold controls to set the voltage ranges that define a valid pulse.

Runt pulses are short pulses that cross one threshold but fail to cross a second threshold before crossing the first threshold again. The pulse widths are measured at the voltage level specified by the level controls. These pulses can also be qualified by time, by the logical state of other channels, or by a bus pattern (MSO70000C/DX Series only). When you click on the trigger window controls, the trigger graphic shows the trigger sequence.

What do you want to do next?

[Learn more about other trigger types.](#)

[Return to the Trigger Setup control window.](#)

Trigger graphic

The trigger graphic displays a visual indicator of the trigger criteria. Depending on the trigger type, the instrument will update the graphic as you define the trigger parameters.

Set up a serial pattern trigger

NOTE. The Serial Pattern Trigger type is not available on DPO70000SX, DPO5000B, and MSO5000B Series instruments.

From the Trig menu, select Serial Pattern Setup.

NOTE. You must install Protocol Trigger and Decode Option (Opt PTH) on some instruments before you can access the Serial Pattern triggers.

Overview. Use the controls in this window to set up the Serial Pattern trigger parameters. The coding you select will determine what standards are available. The clock source determines whether clock level and clock polarity are available to set.

To use. For information on the controls, click the buttons.

- [Trigger Type](#)
- [Settings](#)
- [Clock Source](#)
- [Data Source](#)
- [Coding](#)
- [Standard](#)
- [Bit Rate](#)
- [Format](#)
- [Data / Clock Levels](#)
- [Edit](#)
- [Trigger On](#)

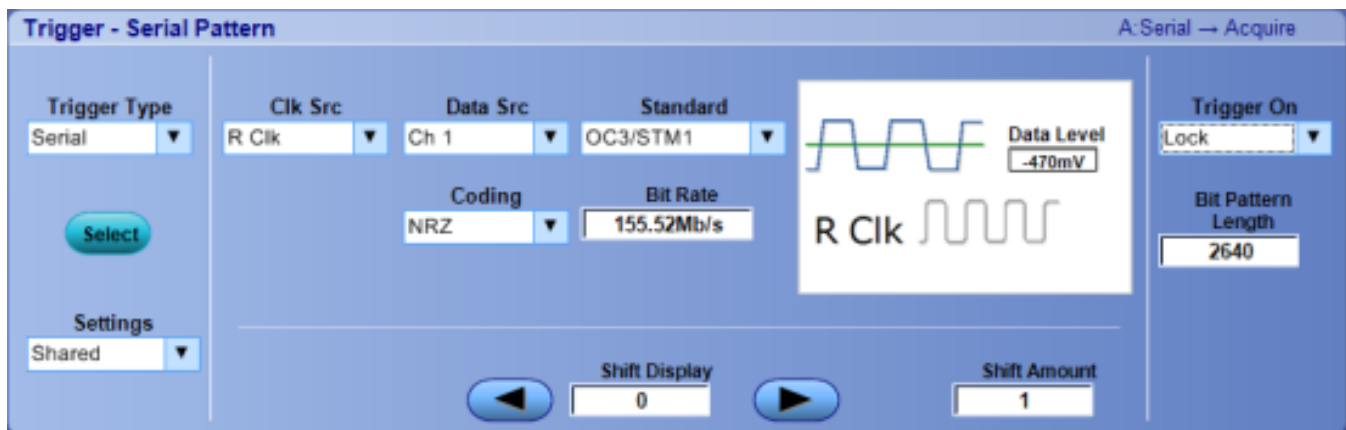

Behavior. You can use this trigger to analyze NRZ patterns found in serial bit streams. Functionality includes triggering on up to 64 bits and recovery on clock data up to 3.125 GB/s, for MSO/DPO70000C/D and DPO7000C models.

If you select the same clock and data source, or if the clock source is R Clk, only one level is available for the data source.

When you click on the trigger window controls, the trigger graphic shows the trigger sequence.

Trigger graphic

The trigger graphic displays a visual indicator of the trigger criteria. Depending on the trigger type, the instrument will update the graphic as you define the trigger parameters.

Set up a setup and hold trigger

From the Trig menu, select Setup/Hold Setup.

Overview. Use the controls in this window to set up the Setup and Hold violation trigger parameters.

To use. For information on the controls, click the buttons.

- [Trigger Type](#)
- [Mark All Trigger Events](#)
- [Settings](#)
- [Source](#)
- [Data Level](#)
- [Clock Source](#)
- [Clock Level](#)
- [Setup / Hold Time](#)
- [Clock Edge](#)
- [Qualification](#)
- [Pattern](#)
- [Edit Button](#)

NOTE. The Trigger Setup/Hold screen on DPO and MSO instruments is the same except for the source selection and Trigger if Setup/Hold Qualification options. In some instruments, the source selection is a drop-down list and the Trigger if Setup/Hold Qualification option has Occurs and Logic. In other instruments the source selection includes a combo list and a Select button. The Trigger if Setup/Hold Qualification option has Occurs, Logic, and Occurs And.

The following Trigger Setup/Hold screen appears on MSO7000C/DX and DPO7000C Series instruments:

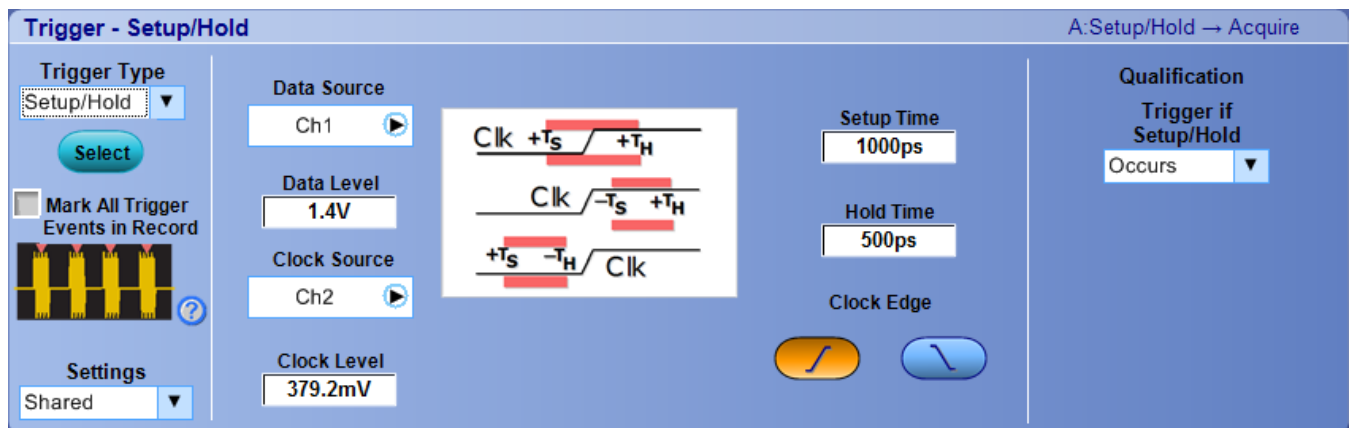

The following Trigger Setup/Hold screen appears on MSO/DPO5000B Series instruments:

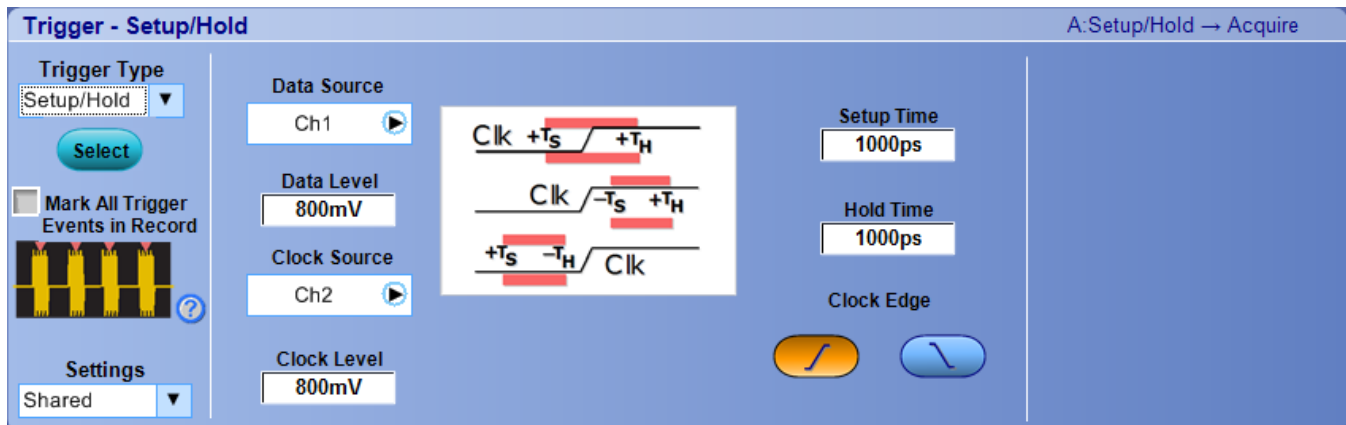

NOTE. The Logic qualification option is not available on DPO5000B and MSO5000B Series instruments.

Behavior. Use the Setup and Hold violation trigger to trigger on setup and hold time violations. When you click on the trigger window controls, the trigger graphic shows the trigger sequence.

The setup and hold times define a violation region relative to a clock. Data is considered to be invalid in the violation region. The instrument monitors the data and clock sources. When a clock edge occurs, the instrument checks the data channel for transitions within the violation region. If any violations occur, the instrument triggers with the trigger point located at the clock edge. The setup and hold values can be positive or negative. The trigger can also be qualified by the logical state of other channels or by a bus pattern (MSO7000C/DX Series only).

The minimum setup and hold time is 2 ns. Negative setup and hold times skew the violation region to locate it before or after the clock edge. The instrument can detect and trigger on violations of time ranges that are before or after the clock.

Use one of the channel inputs as the clock signal and a second channel input as the data input. The clocking and data levels are used to determine if a clock or data transition has occurred.

Not recommended for use with iCapture inputs.

NOTE. You have the option to add user-defined labels for analog, reference, bus, and digital sources.

What do you want to do next?

[Learn more about other trigger types.](#)

[Return to the Trigger Setup control window.](#)

Trigger graphic

The trigger graphic displays a visual indicator of the trigger criteria. Depending on the trigger type, the instrument will update the graphic as you define the trigger parameters.

Set up an SPI bus trigger

NOTE. The SPI Bus Trigger type is available on instruments with option SR-EMBD.

From the Trig menu, select SPI Setup.

NOTE. This online help documents features and options available for several instrument models. Your instrument may not have every feature discussed in this online help, depending on its configuration.

Overview. Use the controls in this window to set up the SPI trigger parameters.

To use. For information on the controls, click the buttons.

- [Trigger Type](#)
- [Settings](#)
- [SS Source](#)
- [SCLK Source](#)
- [SS / SCLK Data.. Active](#)
- [Thresholds](#)
- [Trigger On](#)
- [MISO / MOSI.. Source](#)

The screenshot shows the 'Trigger - SPI' configuration window. The window is titled 'Trigger - SPI' and has a subtitle 'A: SPI → Acquire'. It contains several sections:

- Trigger Type:** A dropdown menu set to 'SPI' and a 'Select' button.
- SS Source:** A dropdown menu set to 'Ch 3' and 'SS Active' set to 'L'.
- SCLK Source:** A dropdown menu set to 'Ch 2' and 'SCLK Active' set to 'Rising'.
- SS Threshold:** A text box set to '0.0V' with a yellow 'a' icon.
- SCLK Threshold:** A text box set to '0.0V' with a yellow 'b' icon.
- Trigger On:** A dropdown menu set to 'MOSI', 'MOSI Source' set to 'Ch 1', and 'Data Active' set to 'H'.
- Value:** A text box set to '01'.
- Threshold:** A text box set to '0.0V'.
- Start Pos:** A text box set to '0'.
- Edit:** A button.
- Settings:** A dropdown menu set to 'Shared'.

At the bottom, there is a timing diagram showing SS, SCLK, and Data signals. The SS signal is a high pulse. The SCLK signal is a square wave. The Data signal shows bits Bit 0, Bit 1, ..., Bit N-1, Bit N.

Behavior. Use this trigger to analyze Serial Peripheral Interface Bus data.

You must supply the following inputs to analyze standard configuration SPI frames:

- Slave Select (SS) Source control line
- Serial Clock (SCLK) Source
- Serial Data In (MISO) Source or Serial Data Out (MOSI) Source

The SS, SCLK, and Data Active controls allow compensation for inverted signals or synchronization on the falling edge of the clock, if applicable.

NOTE. For low-speed serial triggering on data streams, the instrument implicitly pads the MSB side of the entered value, up to the next byte, with "don't care" values (X). To trigger on a two-byte message, you must enter don't care values explicitly up to the desired size.

For example, a binary entered value of 01 is equivalent to XXXX XX01, whereas a two-byte message would be entered as XXXX XXXX XX01.

When you click on the trigger window controls, the trigger graphic shows the trigger sequence.

Trigger graphic

The trigger graphic displays a visual indicator of the trigger criteria. Depending on the trigger type, the instrument will update the graphic as you define the trigger parameters.

Set up a logic state trigger

NOTE. The Logic State Trigger Control Window option is available only on MSO5000B and MSO70000C/DX Series instruments and on DPO5000B Series instruments with option MSOE installed, and DPO70000DX instruments with option MSOU installed.

From the Trig menu, select Logic State Setup.

Overview. The trigger setup includes the D15-D0 digital channels on MSO instruments. DPO models show only Ch1 - Ch4 analog channels. Use the controls in this window to set up the Logic State trigger parameters.

To use. For information on the controls, click the buttons.

- [Trigger Type](#)
- [Mark All Trigger Events](#)
- [Settings](#)
- [Pattern Type](#)
- [Clock Input](#)
- [Pattern](#)
- [Edit Button](#)
- [Pattern Format](#)
- [Logic Thresholds](#)
- [Trigger if.. State](#)

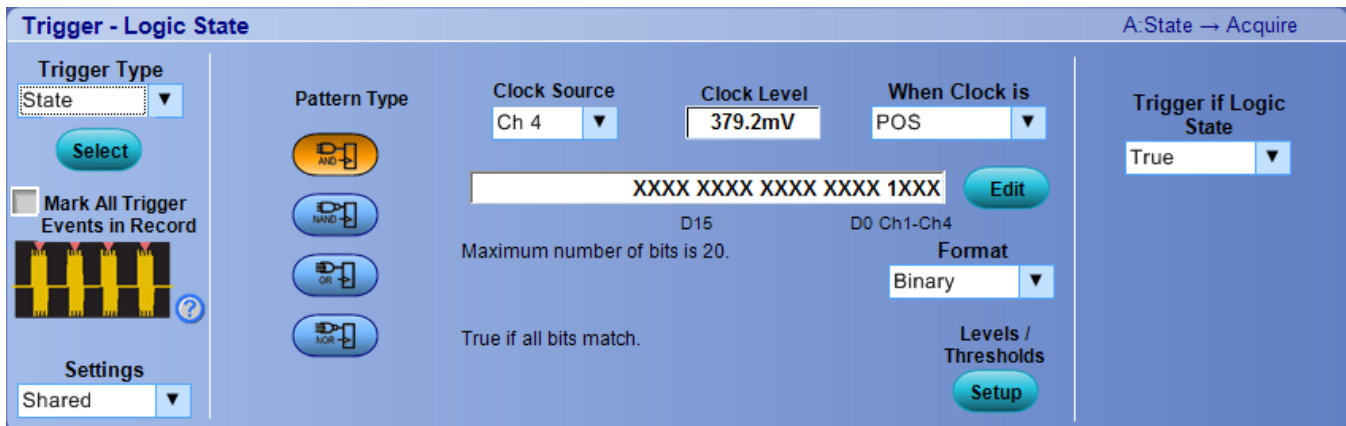

Behavior. Use the Logic State trigger to trigger the instrument when all of the logic inputs to the selected logic function cause the function to be True or False when the clock input changes state.

The Pattern Type buttons set the Boolean logic function for the trigger.

Not recommended for use with iCapture inputs.

What do you want to do next?

[Learn more about other trigger types.](#)

[Return to the Trigger Setup control window.](#)

Set up a logic state trigger

From the Trig menu, select Logic State Setup.

Overview. Use the controls in this window to set up the Logic State trigger parameters.

To use. For information on the controls, click the buttons.

- [Trigger Type](#)
- [Mark All Trigger Events](#)
- [Settings](#)
- [Pattern Type](#)
- [Input Threshold](#)
- [Trigger if.. State](#)

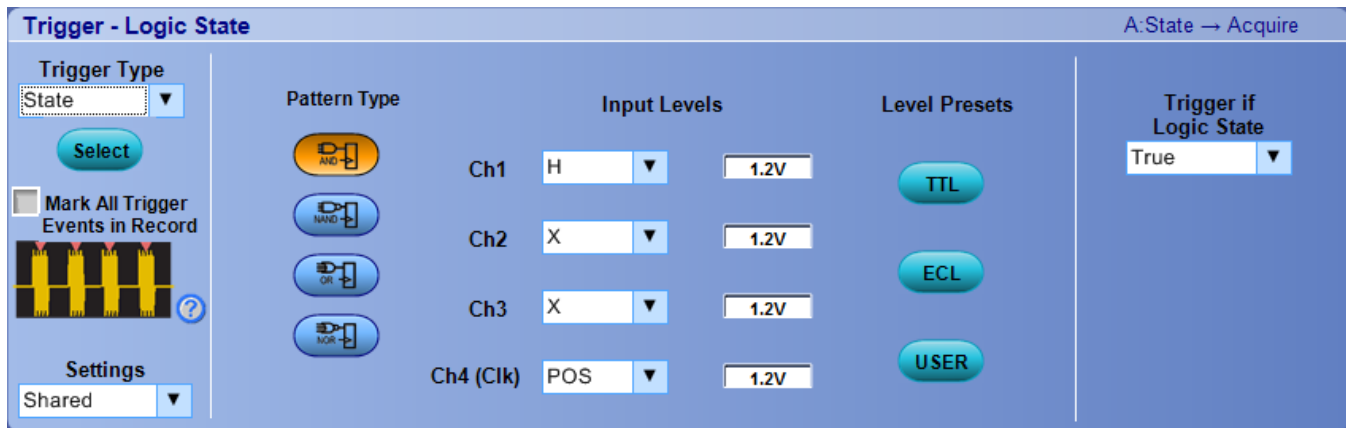

Behavior. Use the Logic State trigger to trigger the instrument when all of the logic inputs to the selected logic function cause the function to be True or False when the clock input changes state.

Channels 1, 2, and 3 represent the data inputs, and channel 4 represents the clock input. (The clock input is channel 2 on 2-channel models.) You can set each data channel to be logic high, logic low, or a "don't care" value. You can set the channel 4 input to a rising or falling clock edge (or channel 2 on 2-channel models). Use the multipurpose knobs to change the threshold voltages for logic levels other than TTL.

The Pattern Type buttons set the Boolean logic function for the trigger.

What do you want to do next?

[Learn more about other trigger types.](#)

[Return to the Trigger Setup control window.](#)

Set up a timeout trigger

From the Trig menu, select Timeout Setup.

Overview. Use the controls in this window to set up the Timeout trigger parameters.

To use. For information on the controls, click the buttons.

- [Trigger Type](#)
- [Mark All Trigger Events](#)
- [Settings](#)
- [Source](#)
- [Set to 50%](#)
- [Level](#)
- [Timer](#)
- [Trigger When](#)
- [Qualification](#)
- [Pattern](#)
- [Edit Button](#)
- [HF Filtering](#)
- [Envelope](#)

NOTE. The Trigger Timeout screen on DPO and MSO instruments is the same except for the source selection (MSO instruments include digital channels) and Trigger if Timeout Qualification options. In some instruments, the source selection is a drop-down list and the Trigger if Timeout Qualification option has Occurs and Logic. In other instruments the source selection includes a combo list and a Select button. The Trigger if Timeout Qualification option has Occurs, Logic, and Occurs And.

The following Trigger Timeout screen appears on MSO70000C/DX and DPO7000C Series instruments:

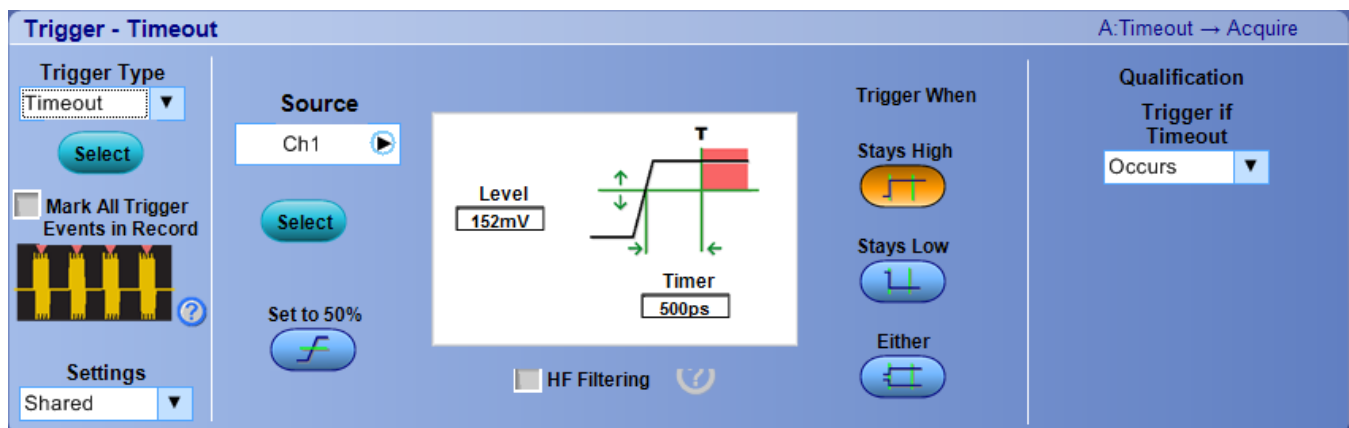

The following Trigger Timeout screen appears on DPO70000SX Series instruments:

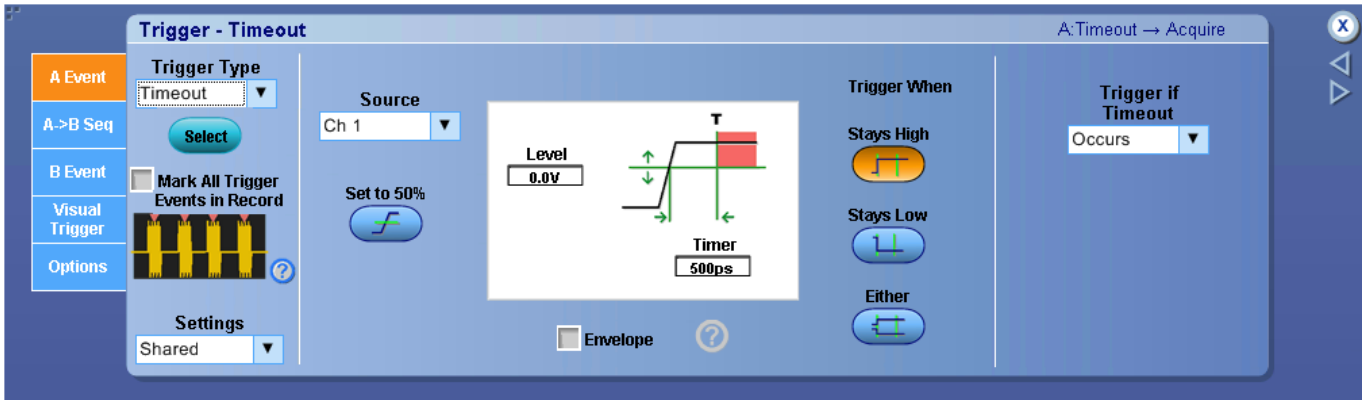

The following Trigger Timeout screen appears on MSO/DPO5000B Series instruments:

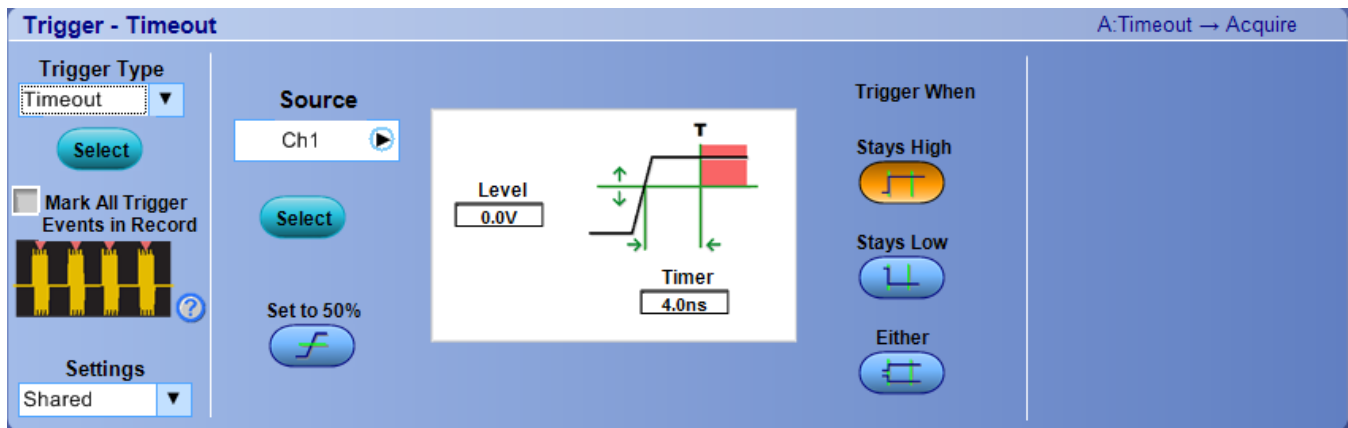

NOTE. The Logic qualification is not available on DPO5000B and .MSO5000B Series instruments.

Behavior. Use the Timeout trigger to trigger the instrument on pulses longer than the specified time. The instrument will trigger at the end of the time-out period. The instrument can trigger on high, low, or both high and low pulses. The trigger can also be qualified by the logical state of other channels or by a bus pattern (MSO7000C/DX Series only). When you click on the trigger window controls, the trigger graphic shows the trigger sequence.



Use the Timer control to specify the time-out limit; any pulses wider than the limit will trigger the instrument. The time-out limit is measured at the voltage level specified by the Level control.

NOTE. You have the option to add user-defined labels for analog, reference, bus, and digital sources.

What do you want to do next?

[Learn more about other trigger types.](#)

[Return to the Trigger Setup control window.](#)

Trigger graphic

The trigger graphic displays a visual indicator of the trigger criteria. Depending on the trigger type, the instrument will update the graphic as you define the trigger parameters.

Set up a transition time trigger

From the Trig menu, select Transition Setup.

Overview. Use the controls in this window to set up the Transition time trigger parameters.

To use. For information on the controls, click the buttons.

- [Trigger Type](#)
- [Mark All Trigger Events](#)
- [Settings](#)
- [Source](#)
- [Levels](#)
- [Transition](#)
- [Slope](#)
- [Qualification](#)
- [Pattern](#)
- [Edit Button](#)

NOTE. The Trigger Transition screen on DPO and MSO instruments is the same except for the source selection and Trigger if Transition Qualification options. In some instruments, the source selection is a drop-down list and the Trigger if Transition Qualification option has Occurs and Logic. In other instruments the source selection includes a combo list and a Select button. The Trigger if Transition Qualification option has Occurs, Logic, and Occurs And.

The following Trigger Transition screen appears on MSO7000C/DX and DPO7000C Series instruments:

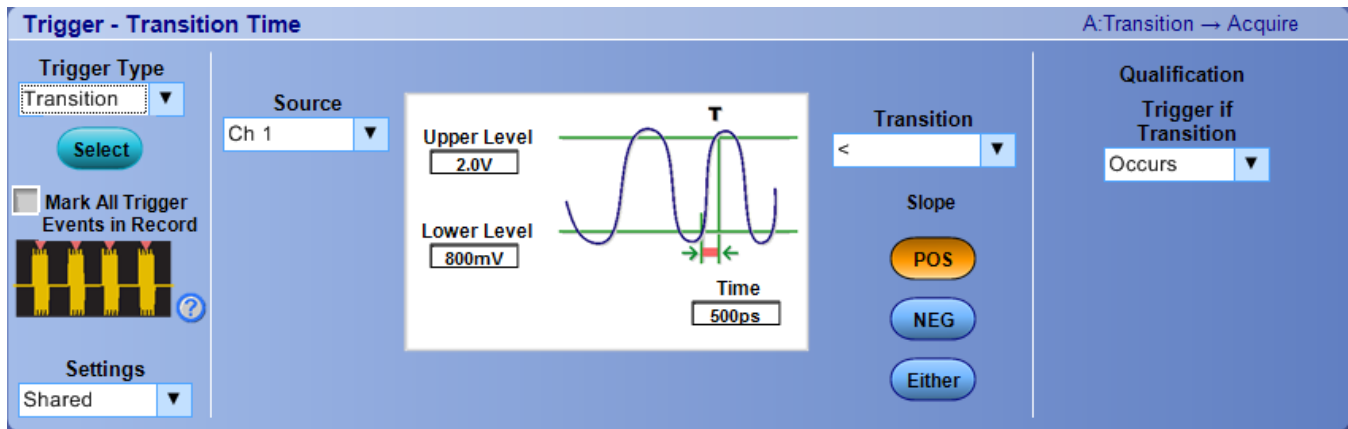

The following Trigger Transition screen appears on MSO/DPO5000B Series instruments:

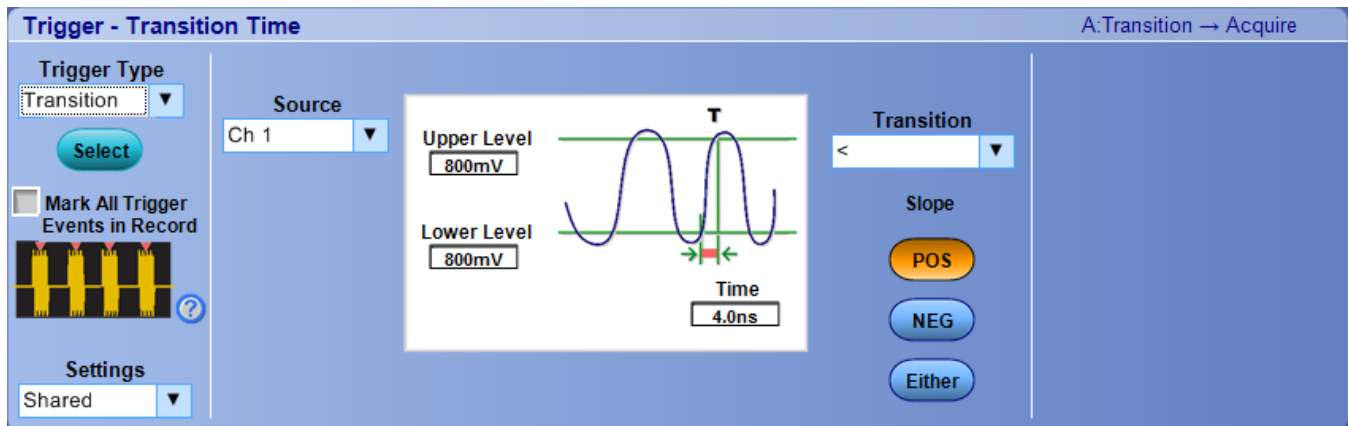

Behavior. Use the Transition trigger to trigger the instrument on pulse edges that traverse between two thresholds at faster or slower rates than the specified time. You can set up the instrument to trigger on positive or negative edges. The trigger can also be qualified by the logical state of other channels or by a bus pattern (MSO7000C/DX Series only). When you click on the trigger window controls, the trigger graphic shows the trigger sequence.



Use the Upper Level and Lower Level controls to define the voltage ranges of interest. The Time control specifies the target transition time.

What do you want to do next?

[Learn more about other trigger types.](#)

[Return to the Trigger Setup control window.](#)

Trigger graphic

The trigger graphic displays a visual indicator of the trigger criteria. Depending on the trigger type, the instrument will update the graphic as you define the trigger parameters.

Set up a video trigger

NOTE. The video trigger type is available only on DPO7000C, MSO5000B, and DPO5000B Series instruments.

From the Trig menu, select Video Setup.

Overview. Use the controls in this window to set up the Video trigger parameters.

NOTE. The Video trigger is only available on analog channels.

To use. For information on the controls, click the buttons.

- [Trigger Type](#)
- [Settings](#)
- [Source](#)
- [Format](#)
- [Polarity](#)
- [Graticule](#)
- [Trigger On](#)
- [Holdoff](#)
- [Autoset](#)

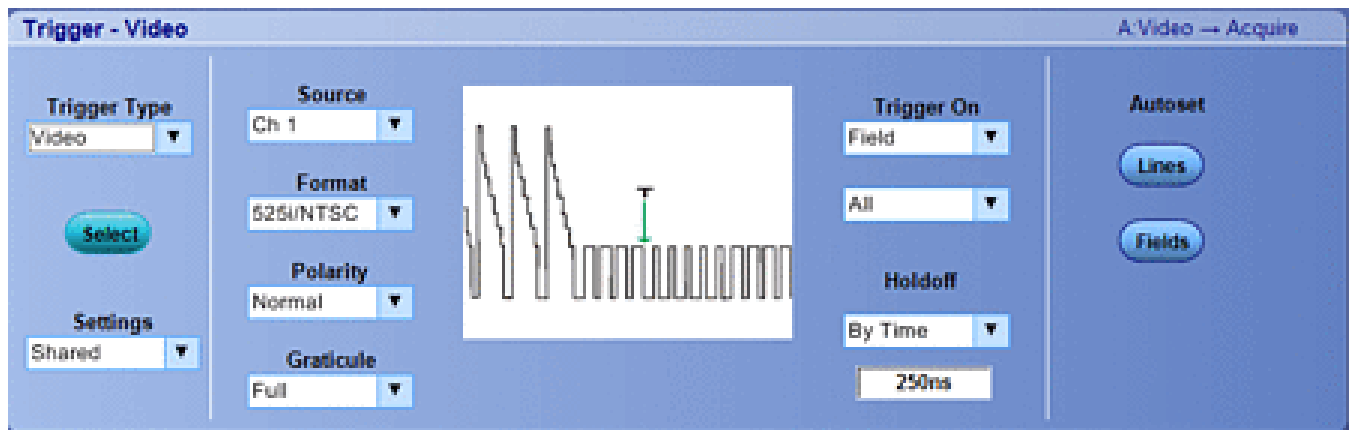

Behavior. Use the Video trigger to trigger the instrument on specified fields or lines of a composite video signal.

NOTE. Only composite signal formats are supported. Graphic display formats such as RGB and VGA are not supported.

Select from several preset video signal formats. If using a preset format, the Lines and Fields Autoset buttons will optimize the instrument for viewing the fields or lines for your chosen format. You can also select a graticule and set the polarity of the scan. When you click on the trigger window controls, the trigger graphic shows the trigger sequence.

You must also set the Scan Type and Scan Rate and you can specify a value for the Holdoff control in units of time only.

What do you want to do next?

[Learn more about other trigger types.](#)

[Return to the Trigger Setup control window.](#)

Scan controls

These controls are available for the Bilevel and Trilevel video format types. Interlaced and Progressive are the only available Scan Types.

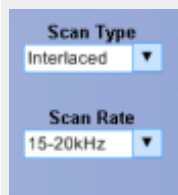

The Scan Rate enables you to trigger on nonbroadcast video signals that have unique scan rates. Select the scan rate range that includes your signal: 15-20 kHz, 20-25 kHz, 25-35 kHz, 35-50 kHz, or 50-65 kHz.

Trigger graphic

The trigger graphic displays a visual indicator of the trigger criteria. Depending on the trigger type, the instrument will update the graphic as you define the trigger parameters.

Trigger holdoff

After a trigger event, the instrument will not accept another trigger event until after the holdoff value is exceeded. Holdoff is usually specified in units of time, but other units may be used.

Set up a width trigger

From the Trig menu, select Width Setup.

Overview. Use the controls in this window to set up the Width trigger parameters.

Behavior. For information on the controls, click the buttons.

- [Trigger Type](#)
- [Mark All Trigger Events](#)
- [Settings](#)
- [Source](#)
- [Set to 50%](#)
- [Level](#)
- [Pulse Width Limits](#)
- [Polarity](#)
- [Qualification](#)
- [Logic pattern](#)
- [Edit Button](#)
- [HF Filtering](#)
- [Envelope](#)

NOTE. The Trigger Width screen on DPO and MSO instruments is the same except for the source selection (MSO instruments include digital channels) and Trigger if Width Qualification options. In some instruments, the source selection is a drop-down list and the Trigger if Width Qualification option has Occurs and Logic. In other instruments the source selection includes a combo list and a Select button. The Trigger if Width Qualification option has Occurs, Logic, and Occurs And.

The following Trigger Width screen appears on MSO70000C/DX and DPO7000C Series instruments:

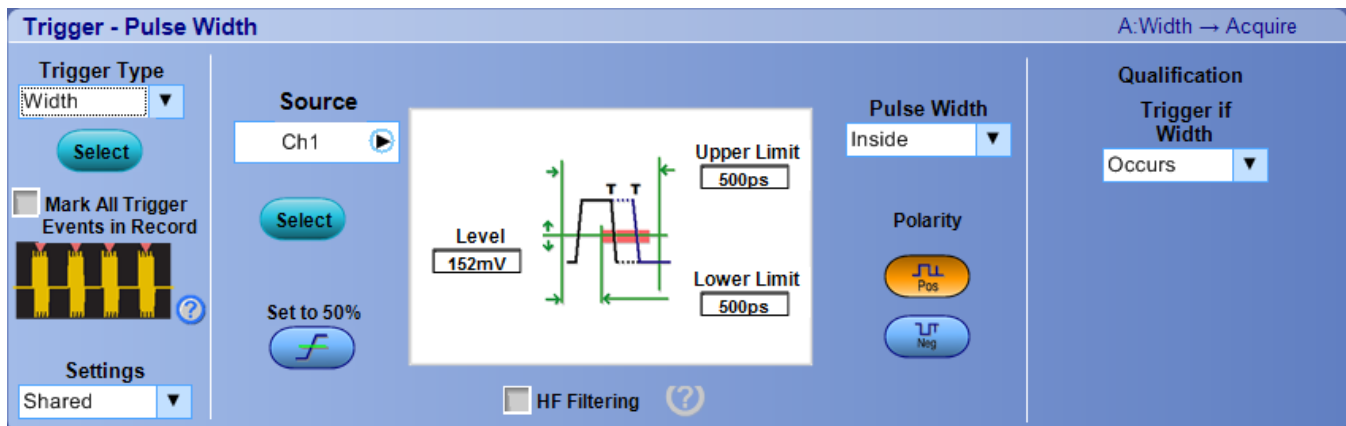

The following Trigger Width screen appears on DPO70000SX Series instruments:

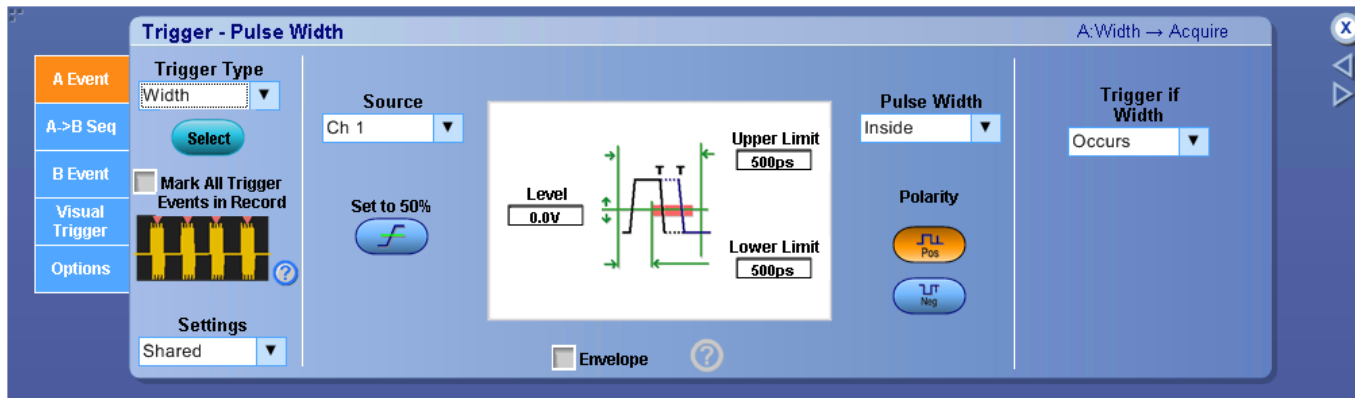

The following Trigger Width screen appears on MSO/DPO5000B Series instruments:

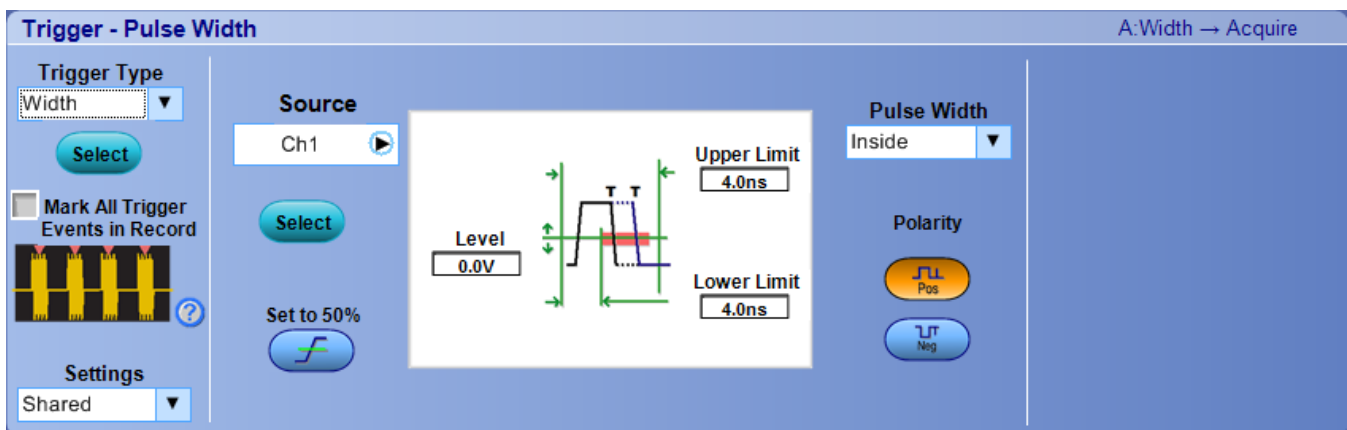

NOTE. This online help file supports many oscilloscope models from Tektronix. This feature is only available on some models.

Behavior. Use the Width trigger to trigger the instrument on a pulse that is either within or outside the specified range. The range is defined by the Upper Limit and Lower Limit controls. You can specify widths for either positive or negative pulses. The pulse widths are measured at the voltage level specified by the Level control. The trigger can also be qualified by the logical state of other channels or by a bus pattern (MSO70000C/DX Series only). When you click on the trigger window controls, the trigger graphic shows the trigger sequence.

NOTE. You have the option to add user-defined labels for analog, reference, bus, and digital sources.

What do you want to do next?

[Learn more about other trigger types.](#)

[Return to the Trigger Setup control window.](#)

Trigger graphic

The trigger graphic displays a visual indicator of the trigger criteria. Depending on the trigger type, the instrument will update the graphic as you define the trigger parameters.

Set up a window trigger

NOTE. Window trigger is not available on MSO/DPO5000B Series instruments.

From the Trig menu, select Window Setup.

Overview. Use the controls in this window to set up the Window trigger parameters.

To use. For information on the controls, click the buttons.

- [Trigger Type](#)
- [Mark All Trigger Events](#)
- [Settings](#)
- [Source](#)
- [Levels](#)
- [Window Event](#)
- [Qualification](#)
- [Pattern](#)
- [Edit Button](#)

NOTE. The Trigger Window screen on DPO and MSO instruments is the same except for the source selection and Trigger if Window Qualification options. In a DPO Series instrument, the source selection is a drop-down list and the Trigger if Window Qualification option has Occurs and Logic. In MSO70000C/DX Series the source selection is a drop-down list. The Trigger if Window Qualification option has Occurs, Logic, and Occurs And.

The following Trigger Window screen appears on MSO70000C/DX Series instruments:

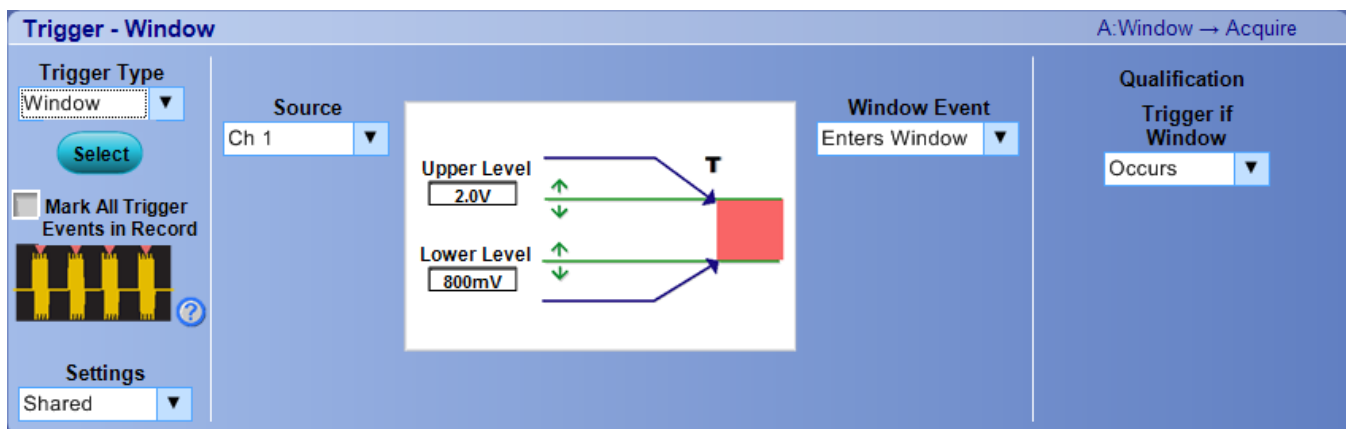

Behavior. Use the Window trigger to trigger the instrument when the input signal rises above an upper threshold level or falls below a lower threshold level. After setting these levels, you can specify whether you want to trigger the instrument as the signal is entering or leaving the threshold window. The trigger can also be qualified by the logical state of other channels or by a bus pattern (MSO7000C/DX Series only). When you click on the trigger window controls, the trigger graphic shows the trigger sequence.

You can further qualify the trigger event in terms of time by using the Inside > t or Outside > t selections, or by the logical state of other channels using the Trigger When Logic option.

The Trigger When controls change as you select different combinations of options.

What do you want to do next?

[Learn more about other trigger types.](#)

[Return to the Trigger Setup control window.](#)

Trigger graphic

The trigger graphic displays a visual indicator of the trigger criteria. Depending on the trigger type, the instrument will update the graphic as you define the trigger parameters.

Sequence triggering

Set up sequential triggering (Horizontal delay off)

From the Trig menu, select A - B Trigger Sequence; then open the A->B Seq tab.

To use. Select the A->B Seq tab to use the A Event (main) trigger with the B Event trigger to capture complex data.

For information on the controls, click the buttons.

- [Trigger Summary](#)
- [A Only](#)
- [A -> B Trig after Time](#)
- [A -> B Trig on nth Event](#)
- [Horizontal Delay Mode](#)
- [A -> B Seq \(Delay\)](#)
- [Counter Measurements](#)

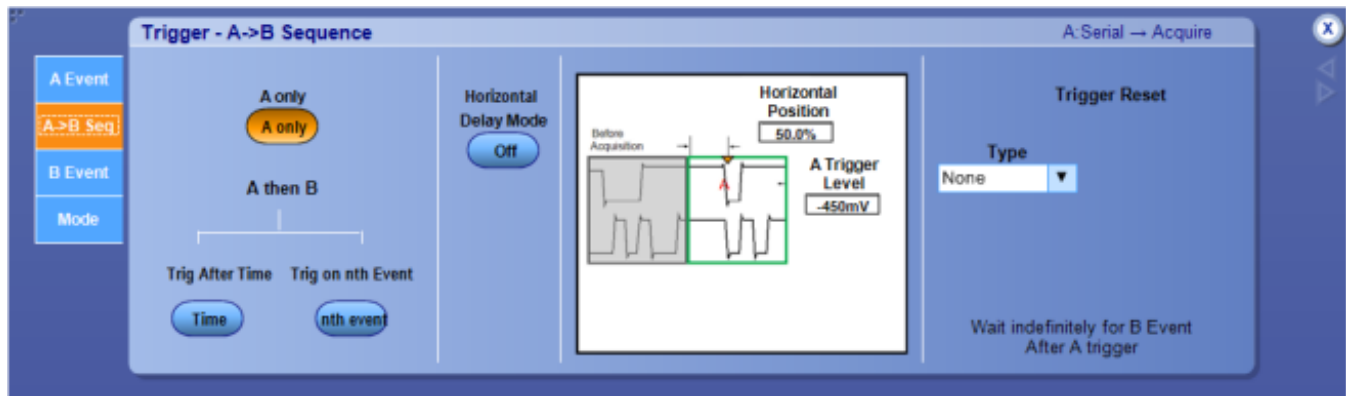

The following screen appears on DPO70000SX Series instruments:

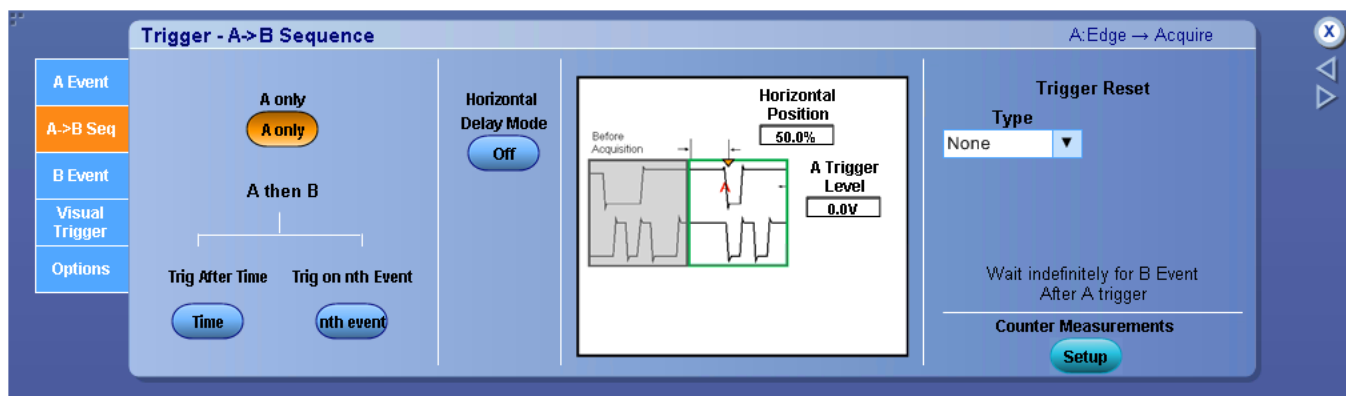

The following screen appears on MSO/DPO5000B Series instruments:

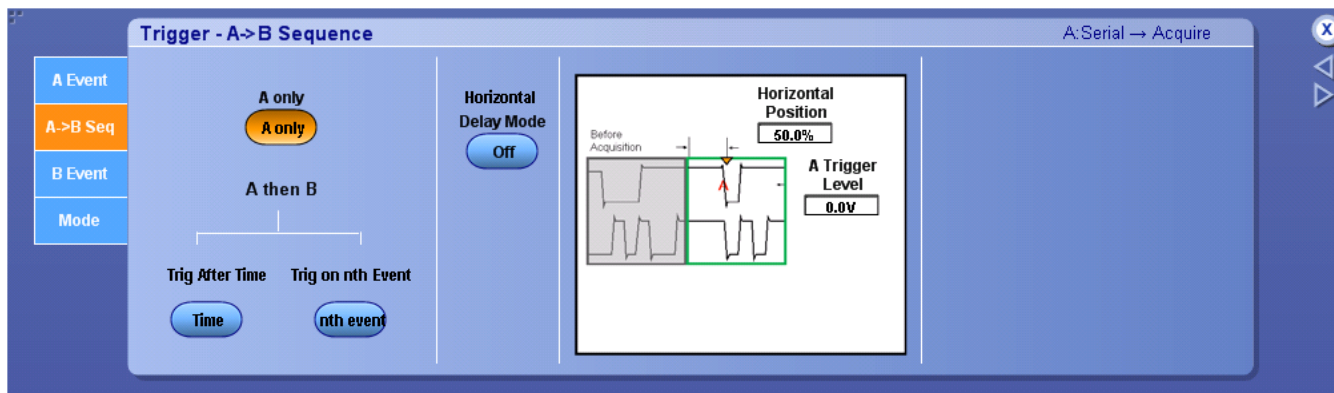

Behavior. The A Event trigger arms the trigger system; the instrument will trigger on the B Event trigger defined by events or time. You can also set up the instrument to delay the B Event Trigger by a specified time period by turning Horizontal Delay Mode on.

When you click on the trigger window controls, the trigger graphic shows the trigger sequence.

What do you want to do next?

[Learn about the A Event trigger types.](#)

[Learn about B Event triggers.](#)

[Learn about Trigger Mode and Holdoff.](#)

[Return to the Trigger Setup control window.](#)

Trigger graphic

The trigger graphic displays a visual indicator of the trigger criteria. Depending on the trigger type, the instrument will update the graphic as you define the trigger parameters.

A only trigger

Trigger on A only (Horizontal delay on). From the Trig menu, select A - B Trigger Sequence.

Overview. Use the controls in this window to define the parameters for the A ->B Sequence trigger with Horizontal Delay on.

For information on the controls, click the buttons.

- [Horizontal Delay Mode](#)
- [Horizontal Position](#)
- [A Trigger Level](#)
- [Acquisition Delay](#)
- [Trigger Reset](#)
- [Counter Measurements](#)

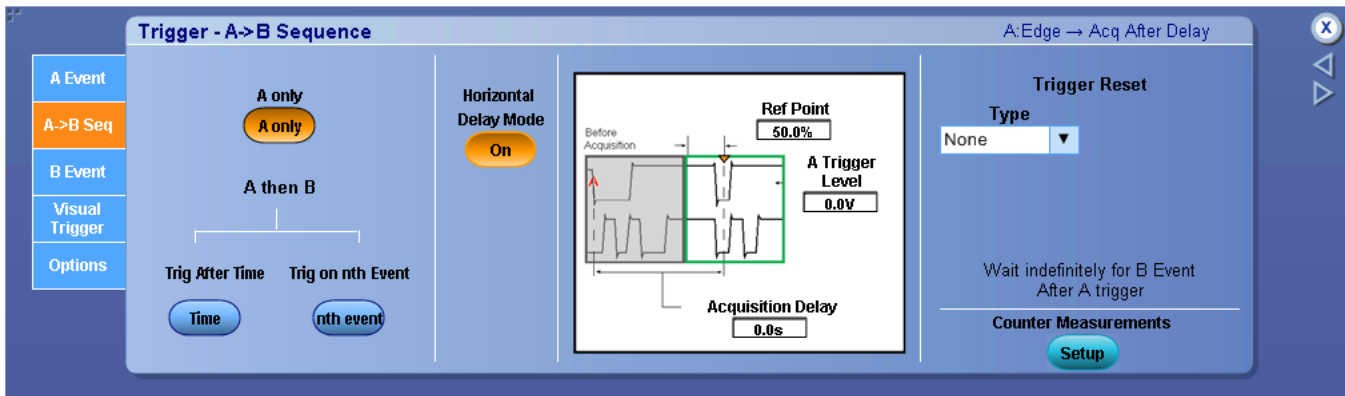

The following screen appears on MSO/DPO5000B Series instruments:

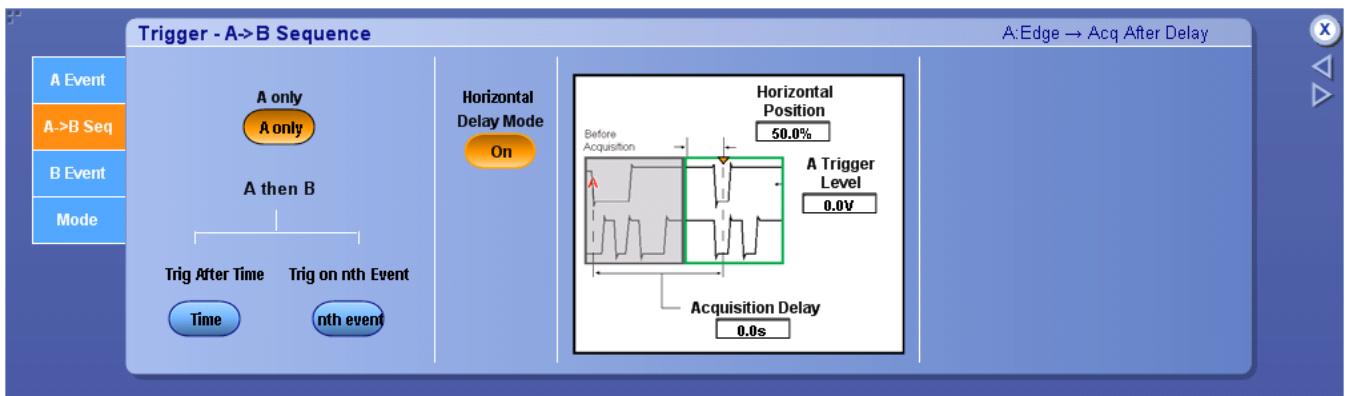

To use.

1. From the A Event tab, select the Trigger Type.
2. Configure the controls for the A Event in the trigger setup window.
3. Select the A->B Seq tab; then click A Only.
4. Click to set the Horizontal Delay Mode button to On.

5. Use the Horiz Delay and Reference Point entry boxes to delay the acquisition relative to the A Event trigger.

Behavior. When you select A Only with Delay Mode on, the instrument first looks for the trigger conditions specified by the A Event. The instrument then delays the acquisition for the time specified by the Horiz Delay control before acquiring the data.

When you click on the trigger window controls, the trigger graphic shows the trigger sequence.

What do you want to do next?

[Learn more about horizontal delay.](#)

[Learn more about other trigger types.](#)

[Return to the Trigger Setup control window.](#)

Trigger graphic

The trigger graphic displays a visual indicator of the trigger criteria. Depending on the trigger type, the instrument will update the graphic as you define the trigger parameters.

Trigger on A only (Horizontal delay off). From the Trig menu, select A - B Trigger Sequence.

Overview. Use the controls in this window to define the parameters for the A ->B Sequence trigger with Horizontal Delay off.

For information on the controls, click the buttons.

- [Horizontal Delay Mode](#)
- [Horizontal Position](#)
- [A Trigger Level](#)
- [Trigger Reset](#)
- [Counter Measurements](#)

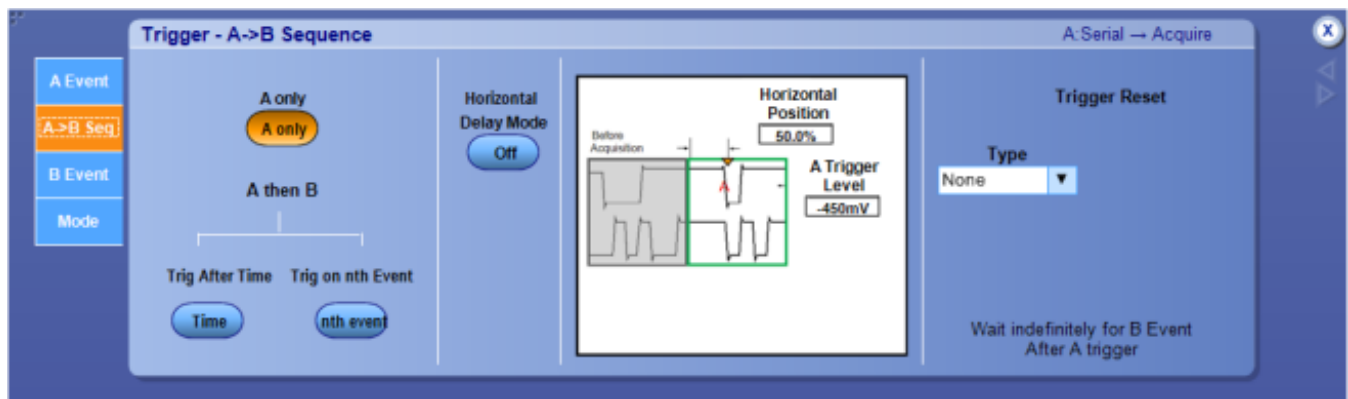

The following screen appears on DPO70000SX Series instruments:

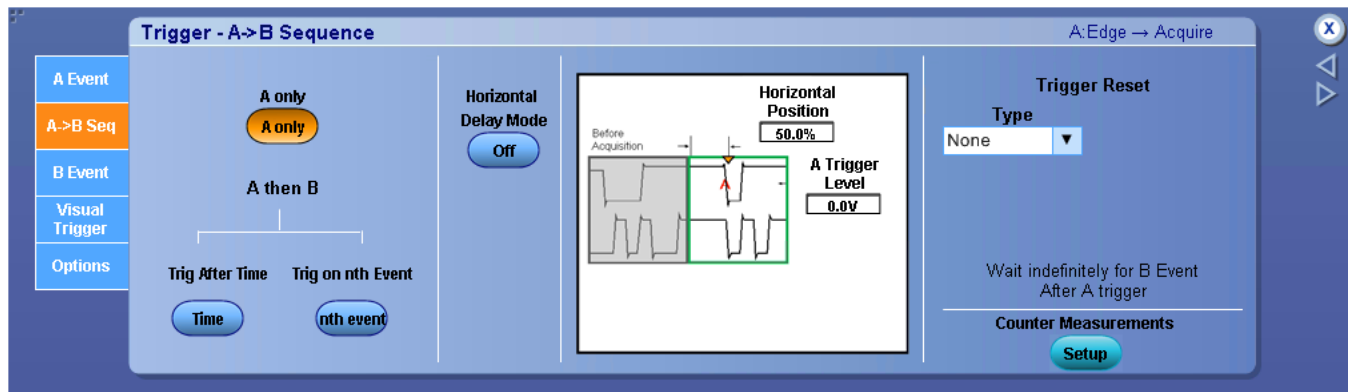

The following screen appears on MSO/DPO5000B Series instruments:

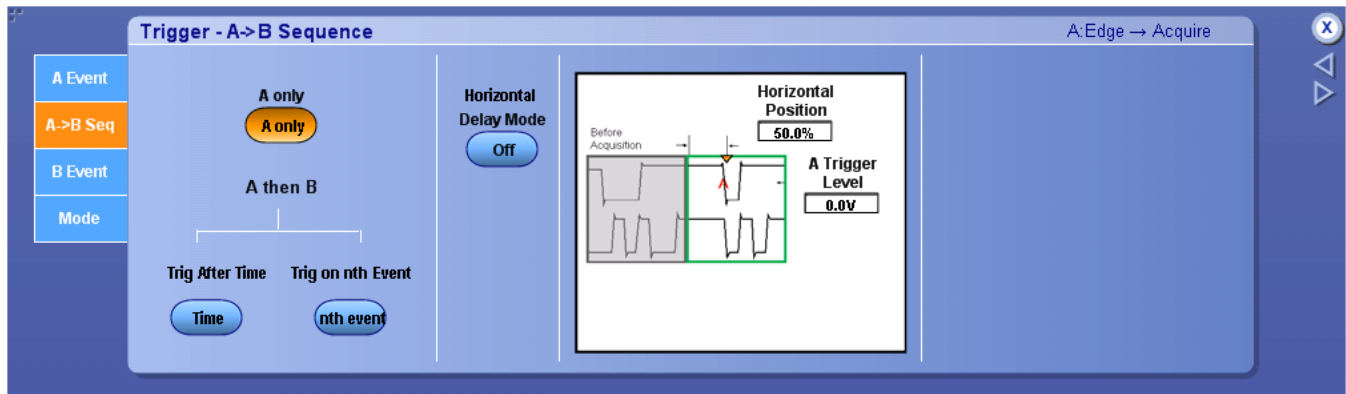
**To use.**

1. From the A Event tab, select the Trigger Type.
2. Configure the controls for the A Event in the trigger setup window.
3. Select the A->B Seq tab; then click A Only.
4. Click to set the Horizontal Delay Mode button to Off.
5. Use the front panel Horizontal Position control (or click in the Horizontal Position entry box and use a multipurpose knob) to define the amount of pretrigger data.
6. Use the front panel Trigger Level control (or click in the A Trigger Level entry box and use a multipurpose knob) to set the A trigger level.

Behavior. When you select A Only with Delay Mode off, the instrument looks for the trigger conditions specified by the A event. When the instrument recognizes the A event, it acquires the posttrigger data.



TIP. Use the front-panel Horizontal Position knob to set the amount of pretrigger data.

What do you want to do next?

[Learn more about other trigger types.](#)

[Return to the Trigger Setup control window.](#)

Pretrigger data

The data points of the waveform acquired and displayed before the trigger event. You can set the amount of pretrigger data with the Horizontal Position control.

Posttrigger data

The data acquired and displayed after the trigger event. You can set the amount of pretrigger data with the Horizontal Position control.

Trigger after time

Trigger after time (Horizontal delay on). From the Trig menu, select A - B Trigger Sequence.

Overview. Use the controls in this window to define the parameters for the A ->B Sequence trigger with Horizontal Delay on.

NOTE. The A->B Sequence trigger is not available with MultiScope Triggers.

For information on the controls, click the buttons.

- [Trigger Level](#)
- [Trigger Delay](#)
- [Horizontal Delay](#)
- [Reference Point](#)
- [Trigger Reset](#)
- [Counter Measurements](#)

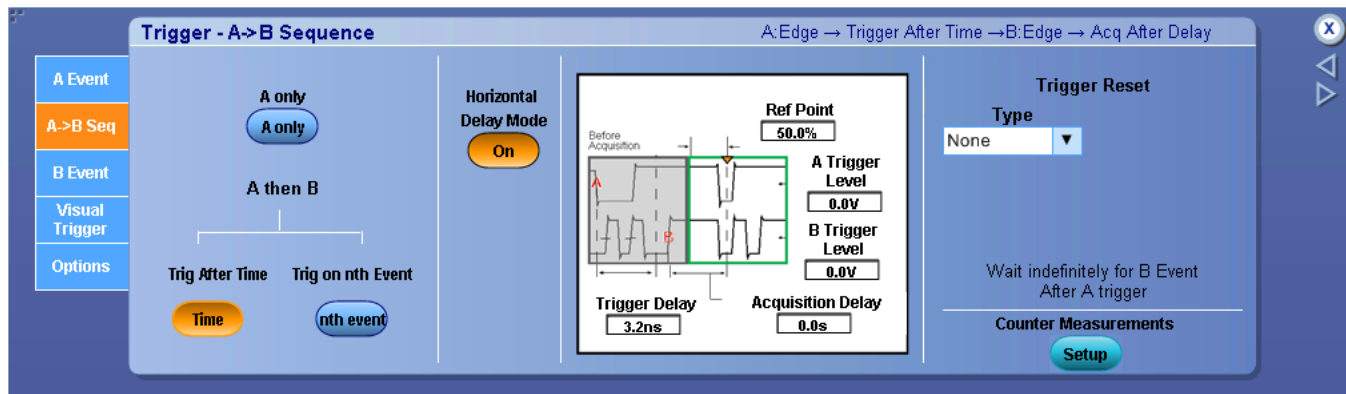

The following screen appears on MSO/DPO5000B Series instruments:

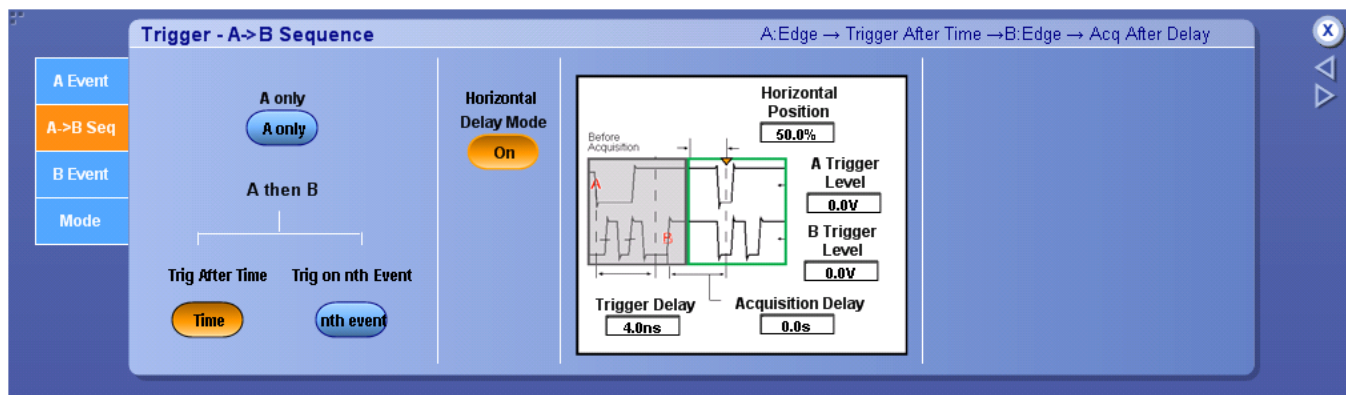

To use.

1. Set up the A Event and B Events from their individual tabs.
2. Select the A->B Seq tab; then click Trig After Time.

3. Click to set the Horizontal Delay Mode button to On.
4. Select the trigger delay time with the Trig Delay control.
5. Use the Horiz Delay control to delay the acquisition relative to the B event.
6. Adjust the Ref Point and B Trig Level controls as necessary.

Behavior. Use this trigger sequence to trigger the instrument on the B trigger event after the A event.

When you select Trig After Time, the instrument looks for the trigger conditions specified by the A event. After the A event arms the trigger system, the instrument delays the trigger for the period of time specified by the Trig Delay control. After the trigger delay time has expired, the instrument looks for the B trigger event. When the instrument detects the B event, it delays the acquisition for the period of time specified by the Horiz Delay.

What do you want to do next?

[Learn more about Horizontal Delay.](#)

[Learn more about other trigger types.](#)

[Return to the Trigger Setup control window.](#)

Trigger after time (Horizontal delay off). From the Trig menu, select A - B Trigger Sequence.

Overview. Use the controls in this window to define the parameters for the A ->B Sequence trigger with Horizontal Delay off.

NOTE. The A->B Sequence trigger is not available with MultiScope Triggers.

For information on the controls, click the buttons.

- [Trigger Level](#)
- [Trigger Delay](#)
- [Horizontal Position](#)
- [Trigger Reset](#)
- [Counter Measurements](#)

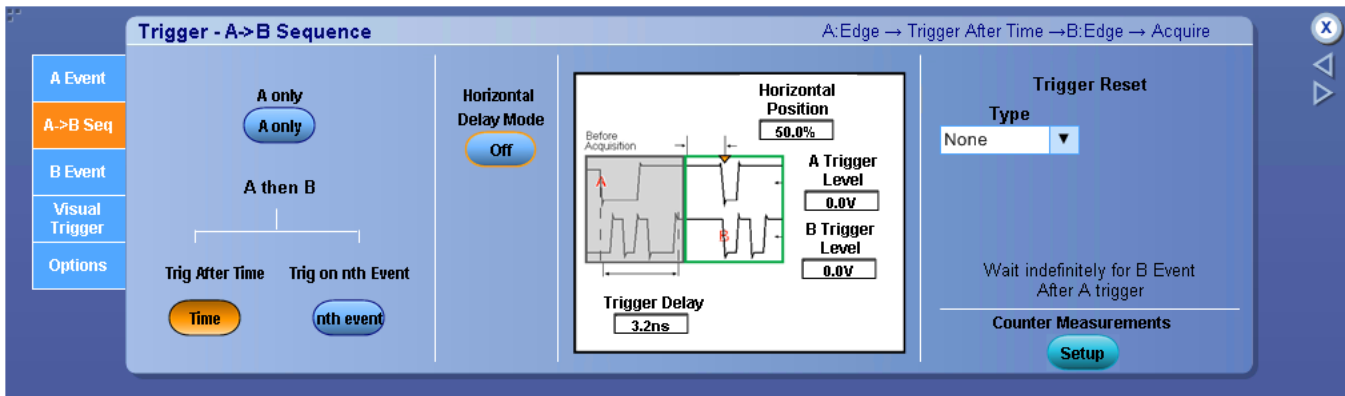

The following screen appears on MSO/DPO5000B Series instruments:

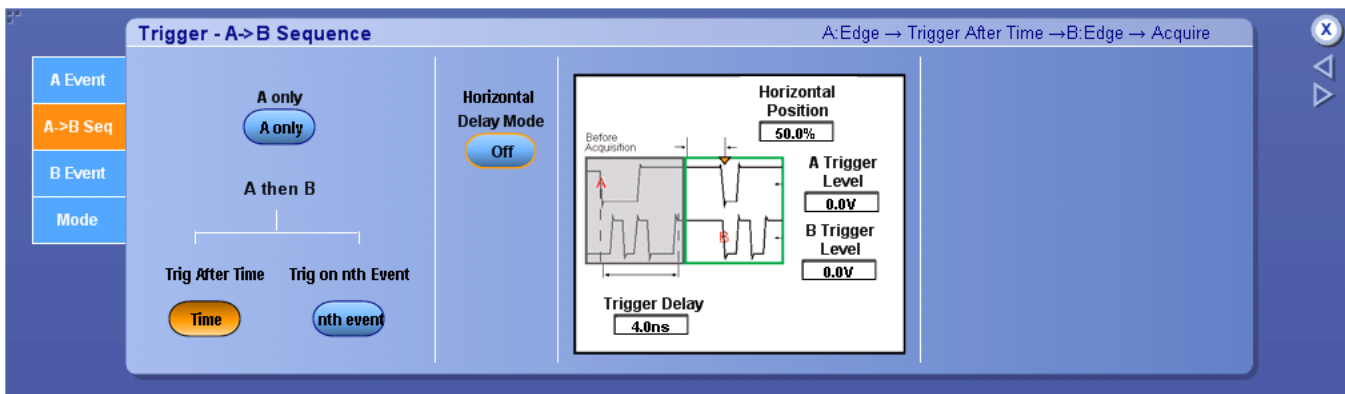

To use.

1. Set up the A Event and B Events from their individual tabs.
2. Select the A->B Seq tab; then click Trig After Time.
3. Click to set the Horizontal Delay Mode button to Off.

4. Select the trigger delay time with the Trig Delay control.
5. Adjust the Horiz Position and B Trig Level controls as necessary.

Behavior. When you select Trig After Time, the instrument looks for the trigger conditions specified by the A event. After the A event arms the trigger system, the instrument triggers on the next B event that occurs after the time specified by the Trig Delay control.

What do you want to do next?

[Learn more about other trigger types.](#)

[Return to the Trigger Setup control window.](#)

Trigger after events

Trigger on nth event (Horizontal delay on). From the Trig menu, select A - B Trigger Sequence.

Overview. Use the controls in this window to define the parameters for the A ->B Sequence trigger with Horizontal Delay on.

For information on the controls, click the buttons.

- [Trigger Level](#)
- [Trigger Events](#)
- [Horizontal Delay](#)
- [Reference Point](#)
- [Trigger Reset](#)
- [Counter Measurements](#)

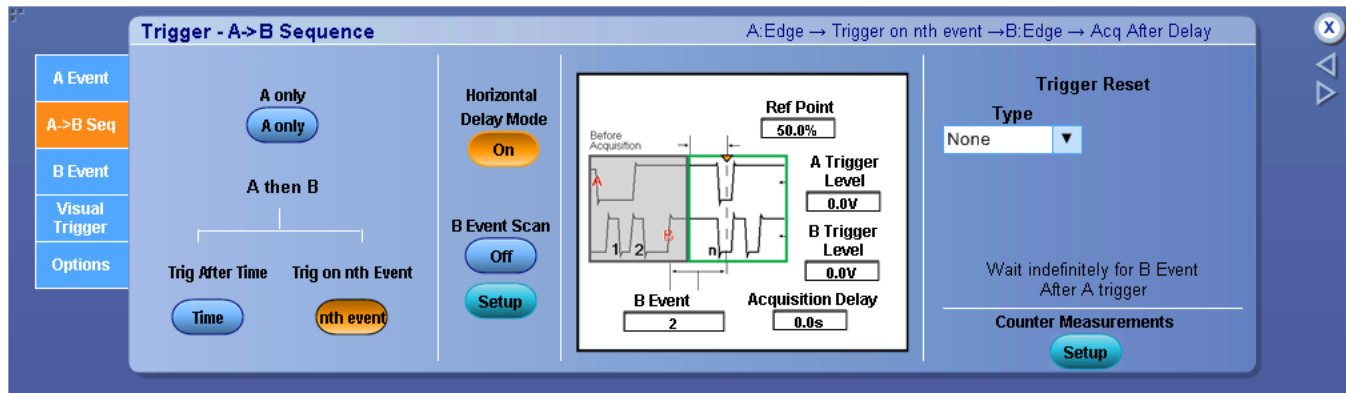

The following screen appears on MSO/DPO5000B Series instruments:

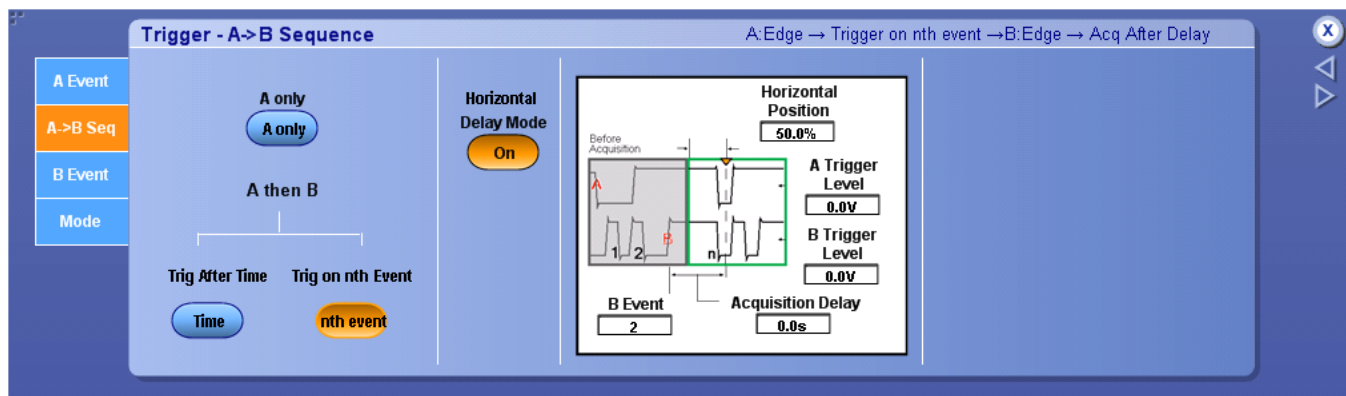

To use.

1. Set up the A Event and B Events from their individual tabs.

NOTE. On MSO/DPO5000B Series instruments, trigger on B events is available only for Edge trigger.

2. Select the A->B Seq tab; then click Trig on nth Event.

3. Set the Horizontal Delay Mode button to On.
4. Select the number of B events with the Trig Event control.
5. Use the Horiz Delay control to delay the acquisition relative to the B event.
6. Adjust the Ref Point and B Trig Level controls as necessary.

Behavior. When you select Trig on nth Event, the instrument looks for the trigger conditions specified by the A event. After the A event arms the trigger system, the instrument looks for a specific number of B events before triggering. The instrument then delays the acquisition for the amount of time specified by the Horiz Delay control. After the delay time has expired, the instrument displays the data.

What do you want to do next?

[Learn more about Horizontal Delay.](#)

[Learn more about other trigger types.](#)

[Return to the Trigger Setup control window.](#)

[Trigger on nth Event \(Horizontal Delay Off\).](#)

[Trigger on nth Event \(B-Event Scan\).](#)

[Trigger on nth Event \(B-Event Scan and Horizontal Delay On\).](#)

Trigger on nth event (Horizontal delay off). From the Trig menu, select A - B Trigger Sequence.

Overview. Use the controls in this window to define the parameters for the A ->B Sequence trigger with Horizontal Delay off.

For information on the controls, click the buttons.

- [Trigger Level](#)
- [Trigger Events](#)
- [Horizontal Position](#)
- [Trigger Reset](#)
- [Counter Measurements](#)

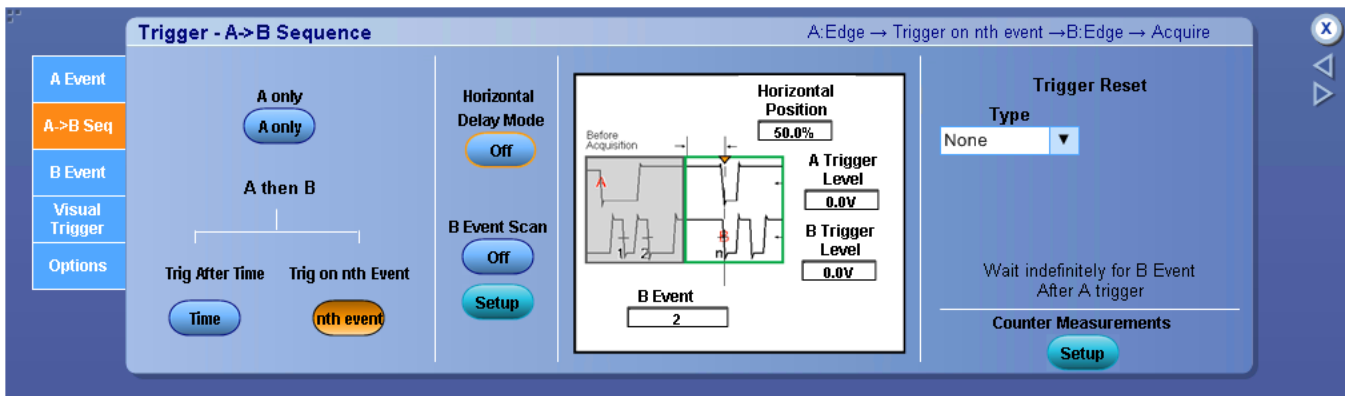

The following screen appears on MSO/DPO5000B Series instruments:

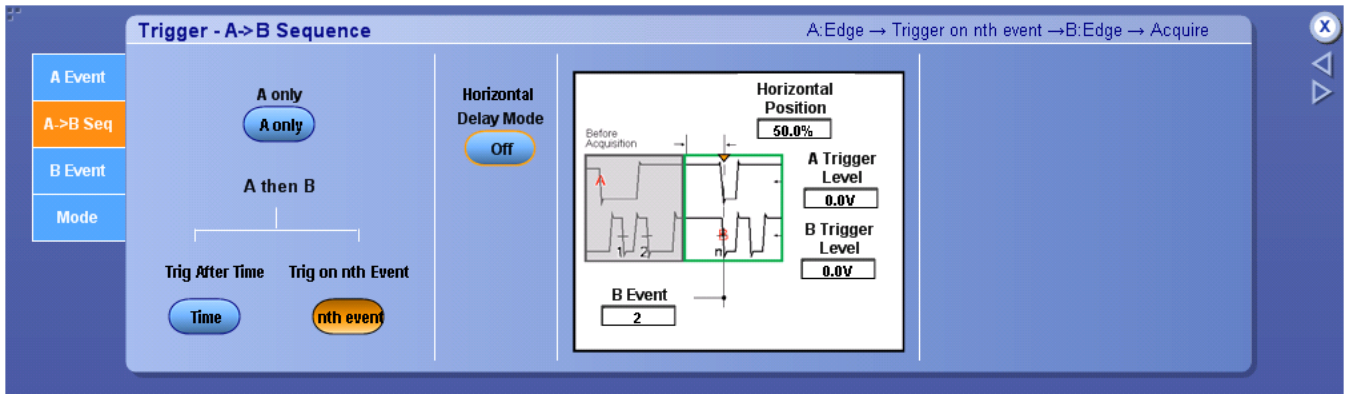

To use.

1. Set up the A Event and B Events from their individual tabs.

NOTE. On MSO/DPO5000B Series instruments, trigger on B events is available only for Edge trigger.

2. Select the A->B Seq tab; then click Trig on nth Event.
3. Set the Horizontal Delay Mode button to Off.

4. Select the number of B events with the Trig Event control.
5. Adjust the Horiz Position and B Trig Level controls as necessary.

Behavior. Use this sequence to trigger the instrument on the nth occurrence of the B event after the A event.

When you select Trig on nth Event, the instrument looks for the trigger conditions specified by the A event. After the A event arms the trigger system, the instrument looks for a specific number of B events before triggering and displaying the data.

What do you want to do next?

[Learn more about other trigger types.](#)

[Return to the Trigger Setup control window.](#)

[Trigger on nth Event \(Horizontal Delay On\).](#)

[Trigger on nth Event \(B-Event Scan\).](#)

[Trigger on nth Event \(B-Event Scan and Horizontal Delay On\).](#)

Posttrigger data

The data acquired and displayed after the trigger event. You can set the amount of pretrigger data with the Horizontal Position control.

Trigger on nth event (B-Event scan). B-Event Scan is not available on MSO/DPO5000B Series instruments.

From the Trig menu, select A - B Trigger Sequence.

Overview. Use the controls in this window to define the parameters for the A ->B Sequence trigger with B-Event Scan on.

For information on the controls, click the buttons.

- [Trigger Level](#)
- [Trigger Events](#)
- [B-Event Scan](#)
- [Horizontal Position](#)
- [Trigger Reset](#)
- [Counter Measurements](#)

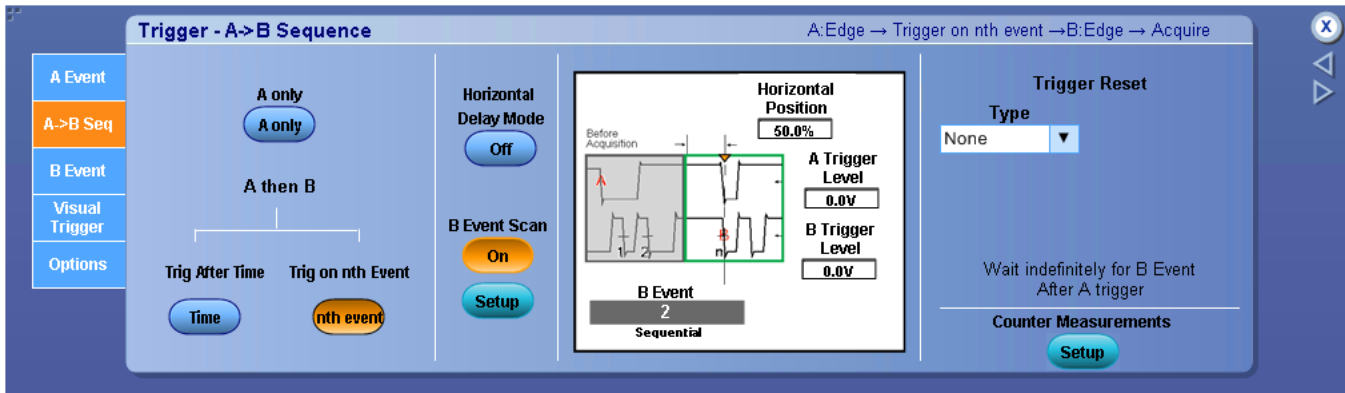

To use.

1. Set up the A Event and B Events from their individual tabs.
2. Select the A->B Seq tab; then click Trig on nth Event.
3. Set the Horizontal Delay Mode button to Off.
4. Set the B Event Scan button to On.
5. Click Setup button to set the values for B Event Advance mode, Start Event, End Event, and Advance After.

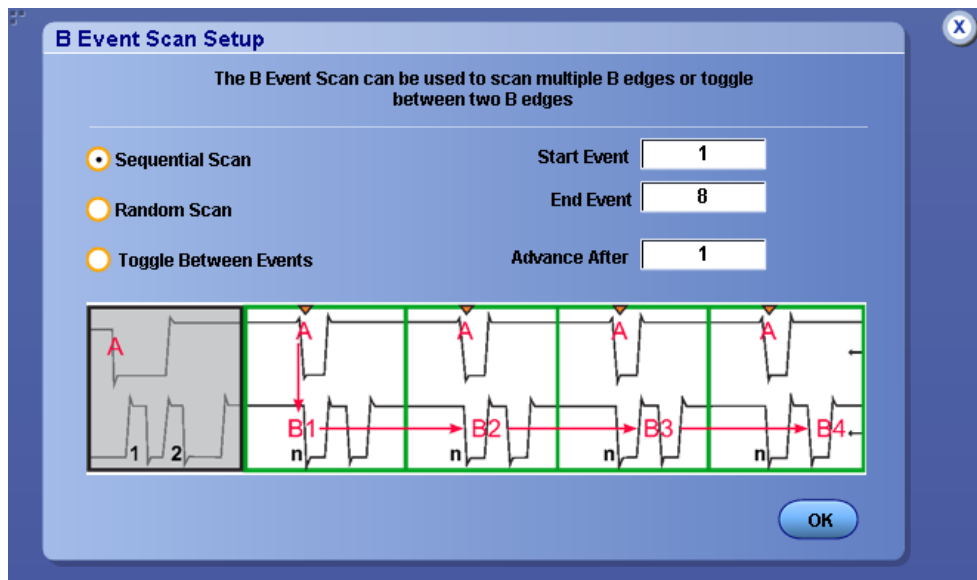

Behavior. Use this sequence to trigger the instrument on the n th occurrence of the B event after the A event.

When you enable the B-Event Scan, the instrument automatically advances the B-Event value to capture a different portion of the signal. The B-Event value is initialized to the Start Event value and is advanced to the End Event value by one of three Advance Methods: Sequential, Random, and Toggle.

What do you want to do next?

[Learn more about B-Event scan setup.](#)

[Learn more about other trigger types.](#)

[Return to the Trigger Setup control window.](#)

[Trigger on \$n\$ th Event \(Horizontal Delay Off\).](#)

[Trigger on \$n\$ th Event \(Horizontal Delay On\).](#)

[Trigger on \$n\$ th Event \(B-Event Scan and Horizontal Delay On\).](#)

Trigger on nth event (B-Event scan and horizontal delay on). The B-Event Scan is not available on MSO/DPO5000B Series instruments.

From the Trig menu, select A - B Trigger Sequence.

Overview. Use the controls in this window to define the parameters for the A ->B Sequence trigger with B-Event Scan and Horizontal Delay on.

For information on the controls, click the buttons.

- [Trigger Level](#)
- [Trigger Events](#)
- [B-Event Scan](#)
- [Horizontal Position](#)
- [Trigger Reset](#)
- [Counter Measurements](#)

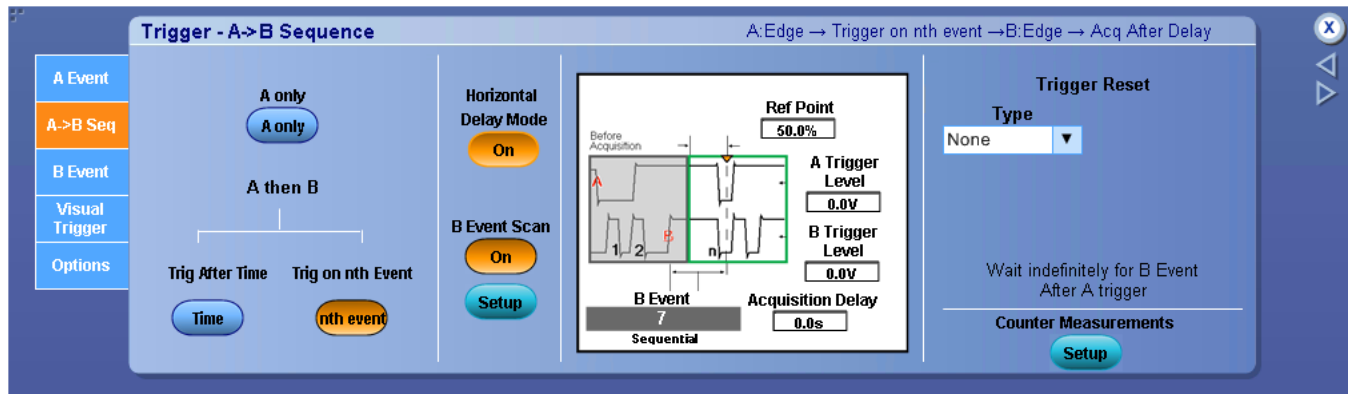

To use.

1. Set up the A Event and B Events from their individual tabs.
2. Select the A->B Seq tab; then click Trig on nth Event.
3. Set the Horizontal Delay Mode button to On. Select the number of B events with the Trig Event control, use the Acquisition Delay control to delay the acquisition relative to the B event, and adjust the Ref Point and B Trig Level controls as necessary.
4. Set the B Event Scan button to On. Click Setup button to set the values for B Event Advance mode, Start Event, End Event, and Advance After.

Behavior. Use this sequence to trigger the instrument on the nth occurrence of the B event after the A event. The instrument then delays the acquisition for the amount of time specified by the Acquisition Delay control. After the delay time has expired, the instrument displays the data.

When you enable the B-Event Scan, the instrument automatically advances the B-Event value to capture a different portion of the signal. The B-Event value is initialized to the Start Event value and is advanced to the End Event value by one of three Advance Methods namely Sequential, Random, and Toggle.

What do you want to do next?

[Learn more about B-Event scan setup.](#)

[Learn more about other trigger types.](#)

[Return to the Trigger Setup control window.](#)

[Trigger on nth Event \(Horizontal Delay Off\).](#)

[Trigger on nth Event \(Horizontal Delay On\).](#)

[Trigger on nth Event \(B-Event Scan\).](#)

B event trigger

Set up trigger controls (B event tab)

From the Trig menu, select B Event (Delayed) Trigger Setup.

To use. Use the controls in this window to define the parameters for the B Event trigger.

For information on the controls, click the buttons.

NOTE. On MSO/DPO5000B Series instruments, trigger on B events is available only for Edge trigger.

- [Trigger Summary](#)
- [Trigger Type](#)
- [Settings](#)
- [Source](#)
- [Set to 50%](#)
- [Level](#)
- [Coupling](#)
- [Slope](#)
- [Force Trigger](#)

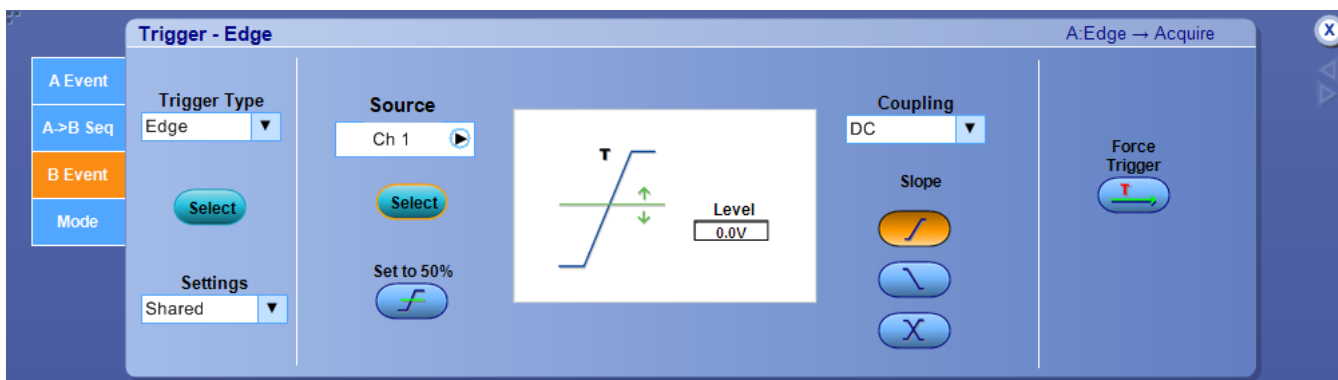

Behavior. These controls work together to define the parameters for the trigger event. Use the B Event trigger with the A Event trigger to capture more complex events. The B Event trigger controls are independent from the A Event trigger. When you click on the trigger window controls, the trigger graphic shows the trigger sequence.

What do you want to do next?

[Learn about sequential triggering.](#)

[Learn about the A Event trigger types.](#)

[Learn about Trigger Mode and Holdoff.](#)

[Return to the Trigger Setup control window.](#)

Trigger graphic

The trigger graphic displays a visual indicator of the trigger criteria. Depending on the trigger type, the instrument will update the graphic as you define the trigger parameters.

Trigger slope

The trigger slope determines whether the instrument finds the trigger point on the rising edge, falling edge, or both edges of the signal.

Visual triggering

Visual trigger

From the Trig menu, select Visual Trigger Setup. Visual triggers are optional.

Overview. Use the Visual Trigger control window to control which triggered waveforms are displayed. For example, the following screen capture shows a waveform acquired using edge trigger.

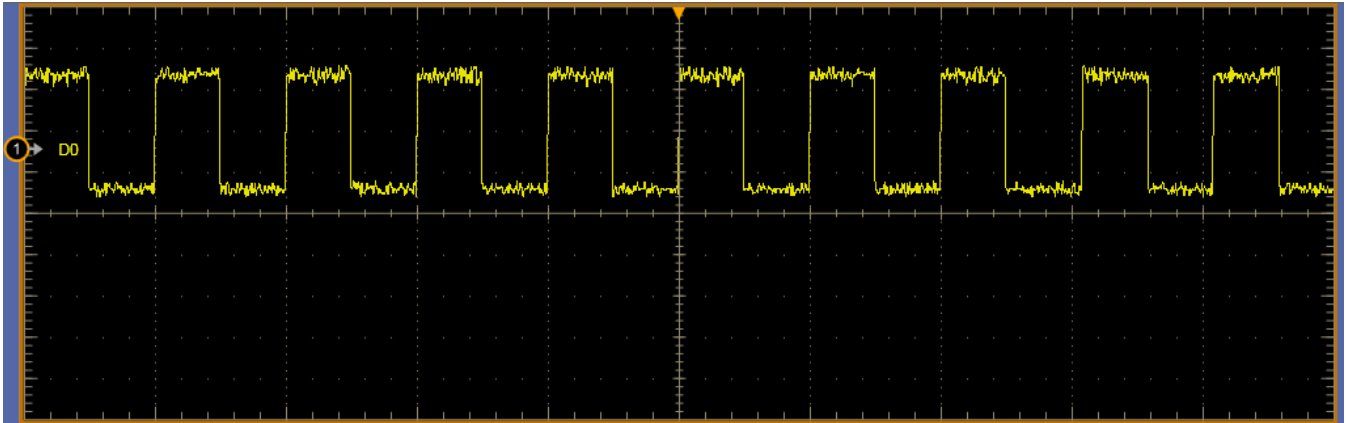

The following screen capture shows the same waveform acquired using edge trigger and visual trigger with two visual trigger areas controlling which triggered waveforms are displayed.

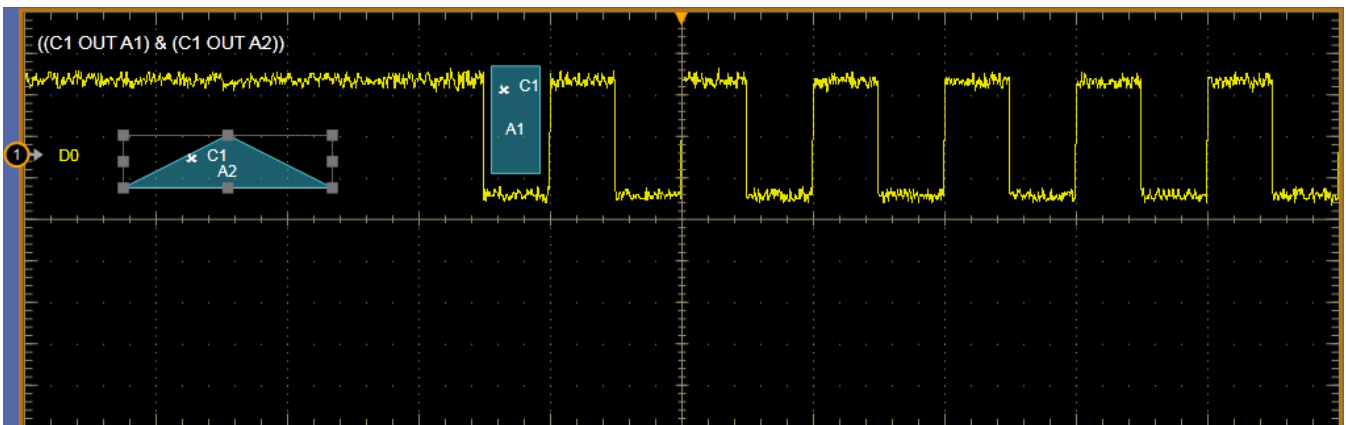

Use the Visual Trigger control window to control which triggered waveforms are displayed.

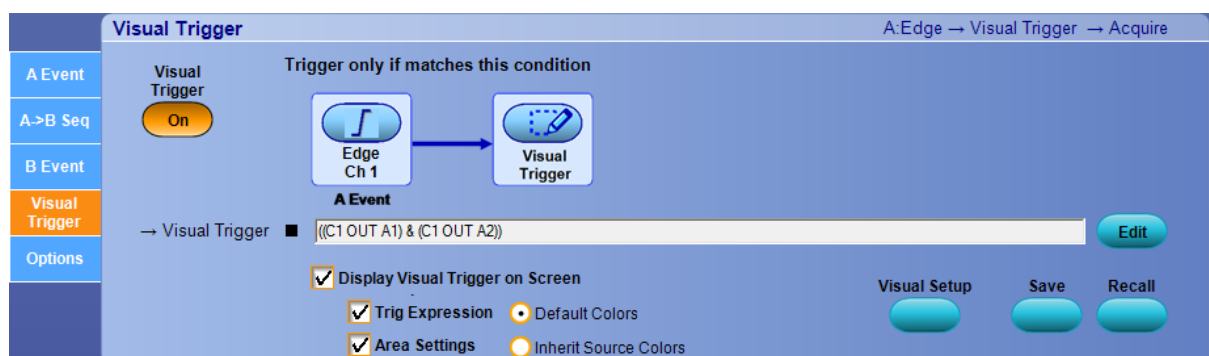

Behavior. The control window provides the following visual trigger controls.

- Pressing the **Visual Trigger** button toggles visual triggering on and off.

NOTE. When Visual Trigger is turned on, the trigger mode is set to Normal. You can change the mode to Auto by pressing the front panel Trigger button.

- Double clicking in the expression area, displays the Qualification Expression Editor window.
- Press the **Save** button to display the Save Visual Setup window. Save Visual Setup only saves the Visual Trigger settings.
- Press the **Recall** button to display the file Open window.
- The **Trigger only if matches this condition** graphic displays the triggering conditions required to display triggered waveforms on the instrument.
- Check the **Display Visual Trigger on Screen** check box to toggle display of the visual trigger areas on and off.
- Check the **Trig Expression** check box to toggle display of the trigger expression on and off.
- Check the **Area Settings** check box to toggle display of the visual trigger area settings on and off.
- Click **Default Colors** to make the visual trigger areas use the default visual trigger colors.
- Click **Inherit Source Colors** to make the visual trigger areas inherit the vertical channel colors.
- Click the **Visual Setup** button to display the Visual Qualification Setup window.

What do you want to do next?

[Learn about creating a visual trigger area.](#)

[Learn about controlling visual triggering.](#)

[Learn about saving a visual trigger setup.](#)

[Learn about recalling a visual trigger setup.](#)

[Learn about visual trigger qualification expressions.](#)

[Learn about defining a visual trigger area.](#)

[Learn about editing a visual trigger area.](#)

Create a visual trigger area

In the graticule area, left click, drag the cursor, and then release.

Create an area. Create a visual trigger area by clicking and dragging a box on the display. Then select **Visual Trigger > Add Visual Trig Area**.

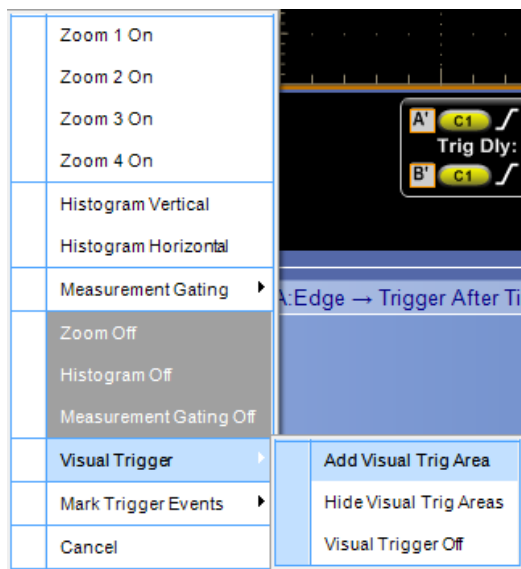

In the same menu you can hide or show all visual trigger areas and toggle visual triggering on and off.

Behavior. Once a visual trigger area is created, you can control the size and position of the area;

- Click the area to enable its handles. Click again to display the vertices.

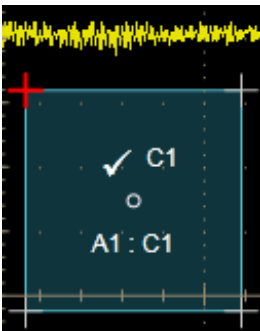
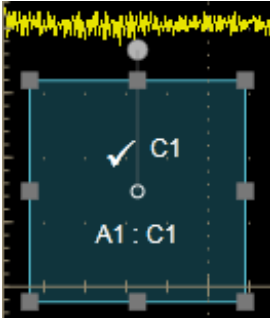

- Click and drag the area to move it to a new location.
- Click and drag one of the area handles to resize the area vertically, horizontally, or both.
- Click and drag the circle handle to rotate the area.
- Click and drag one of the vertices to change the shape of the area by moving the vertex. Right click the area to add or delete a vertex.

Visual trigger areas show the area number, area handles, the channel included or excluded from the area, and a check mark or x indicating whether the channel is included or excluded in the area.

Creating a visual trigger area adds the area to the visual trigger expression. Clicking a waveform handle before creating a visual trigger area changes the channel included in the area and equation. Right clicking an area and selecting **Must be inside** or **Must be outside** changes the expression to either include or exclude the channel in the area. [Controlling Visual Triggering](#) shows a waveform excluded from a visual trigger area.

What do you want to do next?

[Learn about visual trigger setup.](#)

[Learn about controlling visual triggering.](#)

[Learn about saving a visual trigger setup.](#)

[Learn about recalling a visual trigger setup.](#)

[Learn about visual trigger qualification expressions.](#)

Control visual triggering

In the display, right click a visual trigger area and select Visual Trigger Area from the menu.

Overview. Use the right-click menu to control visual trigger areas, qualification expressions, and visual triggering.

To use. Right click a visual trigger area and select Visual Trigger Area.

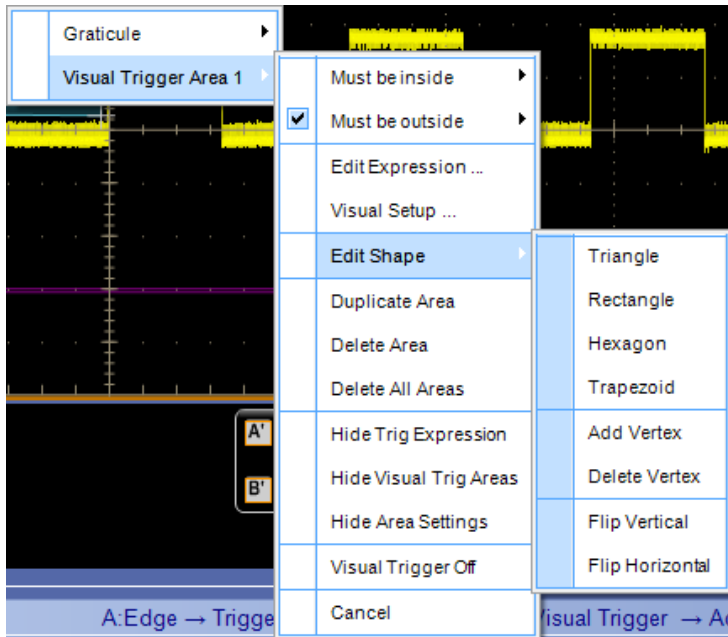

Select Edit Shape to change the shape and orientation of the visual trigger area. Selections include the following:

- Triangle
- Rectangle
- Hexagon
- Trapezoid
- Add Vertex. After adding a vertex, if vertices are not enabled, double click the visual trigger area. Then select each vertex and drag it to its desired location.
- Delete Vertex
- Flip Vertical
- Flip Horizontal
- Select **Must be inside**, **Must be outside**, or **Edit Equation** to create the qualification expression:
 - **Must be inside** specifies which channel the area must be inside.
 - **Must be outside** specifies which channel the area must be outside.
 - **Edit Equation** opens the Qualification Expression Editor, allowing you complete control over the qualification expression.

Select what is displayed:

- **Hide Trig Expression** toggles display of the trigger expression on and off.
- **Hide Visual Trig Areas** toggles display of all visual trigger areas on and off.
- **Hide Area Settings** toggles display of the area settings on and off.
- **Visual Trigger Off** toggles visual triggering on and off.

What do you want to do next?

[Learn about visual trigger setup.](#)

[Learn about creating a visual trigger area.](#)

[Learn about saving a visual trigger setup.](#)

[Learn about recalling a visual trigger setup.](#)

[Learn about visual trigger qualification expressions.](#)

Define an area

In the Visual Trigger window, click Visual Setup.

Overview. Use these control to change the settings of each visual qualification area.

To use.

Change the settings of a visual qualification area.

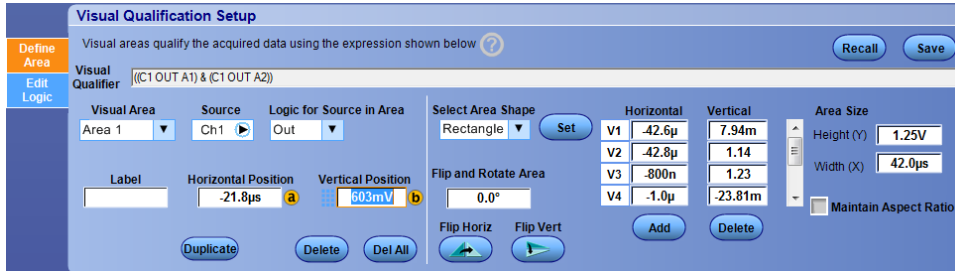

- Select the **Visual Area** to set up
- Select the **Source** that will either be included in or out of the visual trigger area
- Select the **Logic for Source in Area**, either In or Out
- Enter a **Label** for the visual trigger area using either a keyboard or the virtual keyboard
- Set the position of the area by entering a Horizontal and Vertical Position
- Create a new visual trigger area by pressing the **Add** or **Duplicate** buttons
- To delete an area or all visual trigger areas, press the **Delete** or **Del All** buttons.
- If you want to change the default shape of your visual trigger area, select a shape from the **Select Area Shape** drop down list
- To apply settings you have made, press the **Set** button
- To specify the number of degrees to flip or rotate the area, enter the number of degrees in the **Flip and Rotate Area** text box.
- To flip the area 180°, press the **Flip Horiz** or **Flip Vert** buttons
- To move the active vertex, enter a Horizontal or Vertical position using a keyboard or the virtual keyboard
- To add or delete a vertex, press the **Add** or **Delete** buttons
- To change the vertical or horizontal size of the visual trigger area, enter a new size in the Area Size **Height (Y)** or **Width (X)** text boxes. To maintain the aspect ratio of the area while you change the width or height, click the **Maintain Aspect Ratio** check box

What do you want to do next?

- [Learn about Visual Trigger Qualification](#)
- [Learn about visual trigger setup.](#)
- [Learn about creating a visual trigger area.](#)
- [Learn about controlling visual triggering.](#)
- [Learn about saving a visual trigger setup.](#)
- [Learn about recalling a visual trigger setup.](#)
- [Learn about editing a visual trigger area.](#)

Edit expression logic

In the Visual Qualification Setup window, select the Edit Logic tab.

Overview. Use these controls to change the source channels and visual qualifier areas that are part of the visual qualifier expression.

To use. Click in the logic expression box to edit the contents of the expression. Pressing a button adds the item to the expression. If you select an item in the expression, then pressing a button replaces the selected portion of the expression.

- Change the source channels, visual qualifier, and the visual qualifier areas that are included in the expression. When your finished making changes to the expression, press the Apply button.

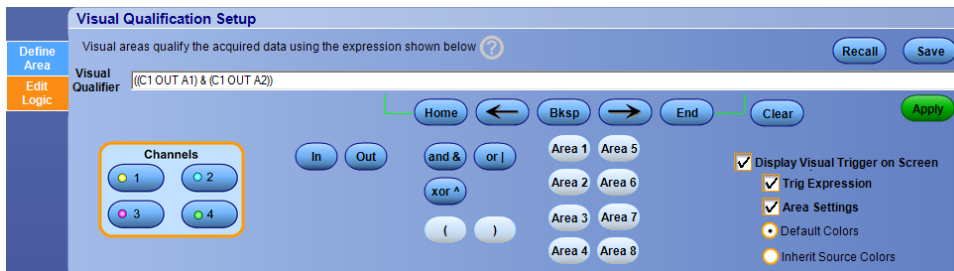

- Press Save to save a visual trigger expression for later recall. See [Save a Visual Setup](#)
- Press Recall to recall a visual trigger expression. See [Recall a Visual Setup](#)
- The **Trigger only if matches this condition** graphic displays the triggering conditions required to display triggered waveforms on the instrument.
- Check the **Display Visual Trigger on Screen** check box to toggle display of the visual trigger areas on and off.
- Check the **Trig Expression** check box to toggle display of the trigger expression on and off.
- Check the **Area Settings** check box to toggle display of the visual trigger area settings on and off.
- Click **Default Colors** to make the visual trigger areas use the default visual trigger colors.
- Click **Inherit Source Colors** to make the visual trigger areas inherit the vertical channel colors.

What do you want to do next?

[Learn about Visual Trigger Qualification](#)

[Learn about visual trigger setup.](#)

[Learn about creating a visual trigger area.](#)

[Learn about controlling visual triggering.](#)

[Learn about saving a visual trigger setup.](#)

[Learn about recalling a visual trigger setup.](#)

[Learn about defining a visual trigger area.](#)

Set up visual trigger expression

From the Trig menu, select Visual Trigger Setup; then double click the Visual Trigger equation.

Overview. Use the Qualification Expression Editor control window to define or edit visual trigger expressions. The readout shows the qualification expression as you construct it. New operands are added at the cursor location each time you click one of the operand buttons.

To use. For information on the controls, click the buttons.

- [Enable](#)
- [Home < - > End](#)
- [Channels](#)
- [Operands](#)

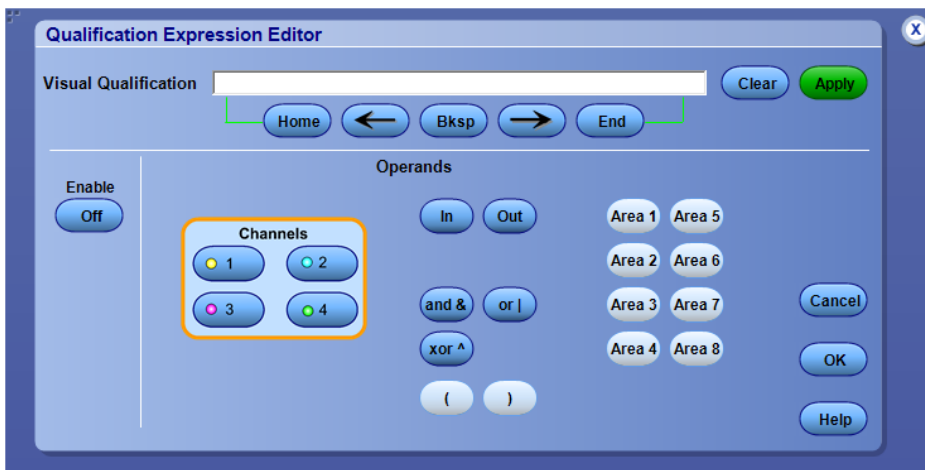

Behavior. You can create a qualification expression using one or more of the following approaches:

- Select one of the channels as an operand by clicking one of the channels in the Channels selector. Use the edit controls to add additional numbers and operators to complete the math expression.
- Connect an external keyboard and use it to enter the expression.
- Create an expression using an external text editor or another application. Copy the text to the Windows clipboard. Right-click with the mouse to paste the text into the expression.

If you create an expression that is longer than the physical space in the control window readout, you can scroll through the expression using the [Text Edit controls](#).

Click Apply to apply the visual qualification expression to visual triggering.

What do you want to do next?

[Learn about visual trigger setup.](#)

[Learn about creating a visual trigger area.](#)

[Learn about controlling visual triggering.](#)

[Learn about saving a visual trigger setup.](#)

[Learn about recalling a visual trigger setup.](#)

Select a channel

Specify the Ch <1 - 4> for oscilloscope operations.

- Specify a channel to dedicate the controls for use with an input on the front panel.
- Shaded buttons Indicate unused or undefined waveforms.



Enable the visual trigger expression editor

From the Visual Trigger menu, double click the Visual Trigger expression.

To use.

- Click Enable to toggle display of the visual trigger waveform on and off.

Behavior. This control only affects the visual triggering.

What do you want to do next?

[Learn about visual trigger setup.](#)

[Learn about creating a visual trigger area.](#)

[Learn about controlling visual triggering.](#)

[Learn about saving a visual trigger setup.](#)

[Learn about recalling a visual trigger setup.](#)

[Learn about visual trigger qualification.](#)

Edit the visual trigger expression

From the Visual Trigger menu, double click the Visual Trigger expression.

To use.

- Click in the readout field to enter the visual trigger expression.
- Click a button to enter its character or operator into the expression.
- Use the [Text Edit Controls](#) to move the insertion point (cursor) within the expression.

Behavior. The characters are entered into the expression one at a time.

What do you want to do next?

[Learn about visual trigger setup.](#)

[Learn about creating a visual trigger area.](#)

[Learn about controlling visual triggering.](#)

[Learn about saving a visual trigger setup.](#)

[Learn about recalling a visual trigger setup.](#)

[Learn about visual trigger qualification.](#)

Use the expression editor operands

From the Visual Trigger menu, double click the Visual Trigger expression.

To use. Click an individual button to enter a character or operator into the visual qualification expression.

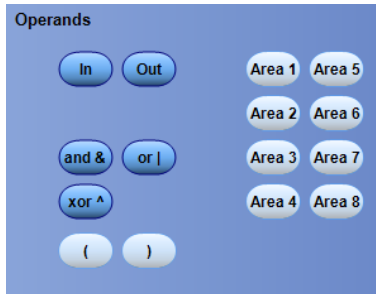

Behavior. The characters are entered into the expression one at a time.

What do you want to do next?

[Learn about visual trigger setup.](#)

[Learn about creating a visual trigger area.](#)

[Learn about controlling visual triggering.](#)







[Learn about saving a visual trigger setup.](#)

[Learn about recalling a visual trigger setup.](#)

[Learn about visual trigger qualification.](#)

Text edit controls

Use the following controls to edit the expression.

| Control | Description |
|---|--|
|  | Moves the text insertion point to the left of the first character in the expression. |
|  | Moves the text insertion point one character to the left. |
|  | Moves the text insertion point one character to the right. |
|  | Deletes the character to the left of the insertion point. |
|  | Moves the text insertion point to the right of the last character in the expression. |
|  | Clears the entire math expression. |

Save a visual setup

From the Trig menu, select Visual Trigger Setup; then press Save from the control window.

Overview. Use this dialog box to save Visual Trigger setups to a file for later use. The setup is stored in human-readable text in GPIB command format.

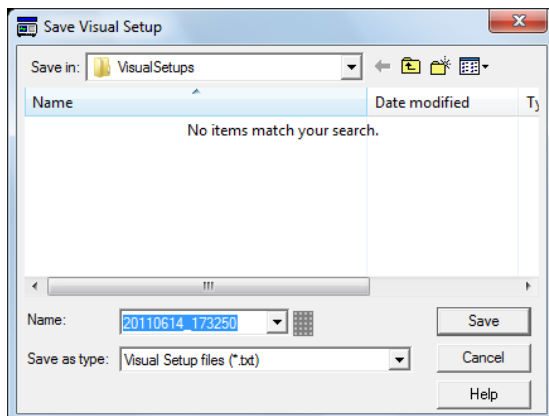

To use.

1. In the Save As dialog box, assign your own file name, and then save the file to a specified folder.
2. Click Save to save the visual trigger setup or cancel to close the dialog box without saving.

What do you want to do next?

[Learn about visual trigger setup.](#)

[Learn about creating a visual trigger area.](#)

[Learn about controlling visual triggering.](#)

[Learn about recalling a visual trigger setup.](#)

[Learn about visual trigger qualification.](#)

[Learn about saving a waveform.](#)

Recall a visual setup

From the Trig menu, select Visual Trigger Setup; then press Recall from the control window.

Overview. Use this dialog box to recall a Visual Trigger setup.

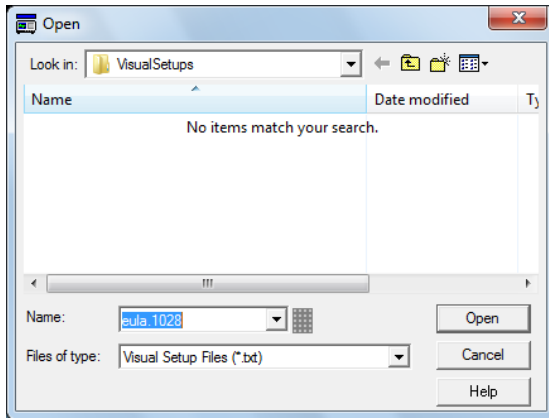

To use. Visual trigger setups are recalled from an internal file on your hard drive that you have named.

To recall a visual trigger setup from a file, select the location of the setup from the Look in list. Select the setup you want to recall, and then click Open.

Behavior. The setups are restored from an internal file on your hard drive as soon as you click the Open button.

What do you want to do next?

[Learn about visual trigger setup.](#)

[Learn about creating a visual trigger area.](#)

[Learn about controlling visual triggering.](#)

[Learn about saving a visual trigger setup.](#)

[Learn about visual trigger qualification.](#)

Mode and holdoff

Set up trigger controls (Options tab)

From the Trig menu, select the A Event or B Event Trigger Setup; then open the Options tab.

Overview. Use the controls in this window to set up the trigger mode.

For information on the controls, click the buttons.

- [Trigger Summary](#)
- [Normal Trigger](#)
- [Auto Trigger](#)
- [Trigger Position](#)
- [Auto Holdoff](#)
- [Timed Holdoff](#)
- [Random Holdoff](#)
- Trig Holdoff
- [Level](#)
- [Save on Trigger](#)
- [E-mail on Trigger](#)
- [E-mail Setup](#)
- [Counter Measurements](#)

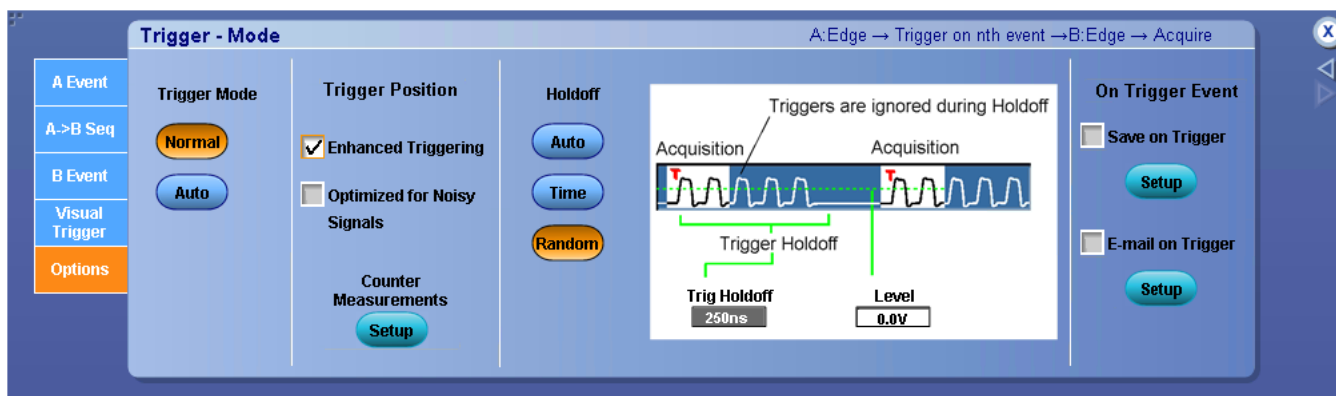

To use.

- To set the Trigger Mode, click either Auto or Normal.
- To [enhance trigger positioning](#), click in the option boxes.
- To set the Trigger Holdoff time manually, click Time, and then use the multipurpose knob to set the holdoff time. The Holdoff range is 250 ns (minimum holdoff available) to 100 s (maximum holdoff available).
- To enable Save on Trigger, click the check box.
- To enable E-mail on Trigger, click check box.
- To set up the e-mail on event parameters, click Setup. Set the A Event trigger level using the A Trig Level control and the multipurpose knob.

Behavior. Use the trigger holdoff time to delay the trigger system for a specified amount of time between triggers, or click Auto to let the instrument calculate the time for you. You can also set the holdoff to a Level that synchronizes the instrument with an incoming signal to generate a stable display and avoid triggering on undesired events. When you click on the trigger window controls, the trigger graphic shows the trigger sequence.

If E-mail on Event has already been set up, clicking E-mail on Trigger enables you to send e-mail on a trigger. If E-mail on Event has not been set up, you must first click Setup, and then configure E-mail on Event in the setup control window.

What do you want to do next?

[Return to the Trigger Setup control window.](#)

[Learn about setting up E-mail on Event.](#)

Trigger holdoff

After a trigger event, the instrument will not accept another trigger event until after the holdoff value is exceeded. Holdoff is usually specified in units of time, but other units may be used.

Trigger graphic

The trigger graphic displays a visual indicator of the trigger criteria. Depending on the trigger type, the instrument will update the graphic as you define the trigger parameters.

Enable trigger position correction

From the Trig menu, select A Event (Main) Trigger setup; then open the Mode tab.

Overview. Trigger Position corrects for internal differences in the data and trigger paths to more accurately place triggers on displayed waveforms. This feature can also use averaging to improve trigger placement on noisy signals.

Trigger Position Correction works for all pinpoint trigger types, except Pattern trigger: Edge, Glitch, Width, Timeout, Runt, State, Setup and Hold, Transition, Window.

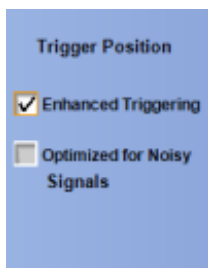

To use. To more accurately place triggers:

- Click Enhanced Triggering to more accurately place a trigger on the display.
- Click Optimized for Noisy Signals to more accurately place the trigger on a noisy signal (available only if Enhanced Triggering is enabled.)

Behavior. The Trigger Type indicator(s) in the status area change when you apply Trigger Position Correction. In the example below, the Trigger A indicator changed from A to A' when trigger correction was applied.



NOTE. You can use Trigger Position Correction in any combination for A Event, B Event, or Sequence triggers, including Trigger After Time and Trigger on nth Event. It is fully compatible with all acquisition and logic qualification sampling modes, Bandwidth Enhancement, and FastFrame, but not Fast Acquisition.

Vertical setups

Set up vertical controls

From the Vertical menu, select Vertical Setup.

Overview

Use the Vertical Setup control windows to set vertical parameters for live (channel) waveforms. The example windows below do not show controls for attached probes.

Click for DPO7000C and MSO/DPO5000B Series instruments

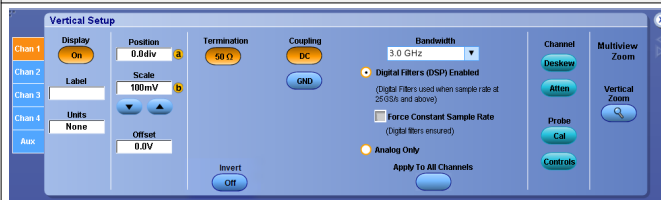

Click for MSO/DPO70000C/DX/SX Series instruments

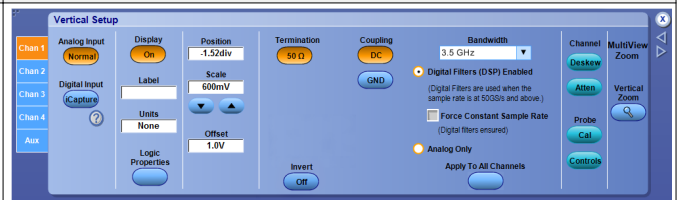

The following screen appears on DPO7000C Series instruments:

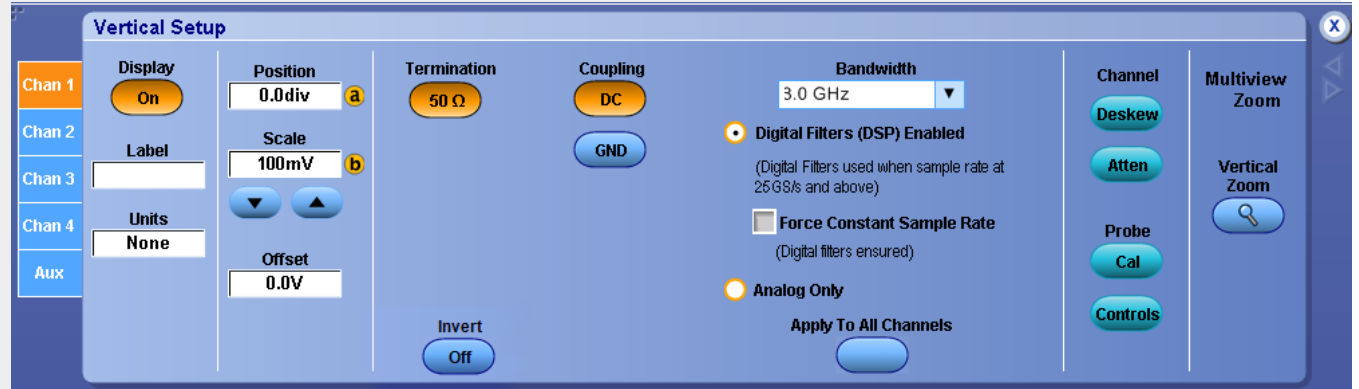

The following screen appears on MSO/DPO5000B Series instruments:

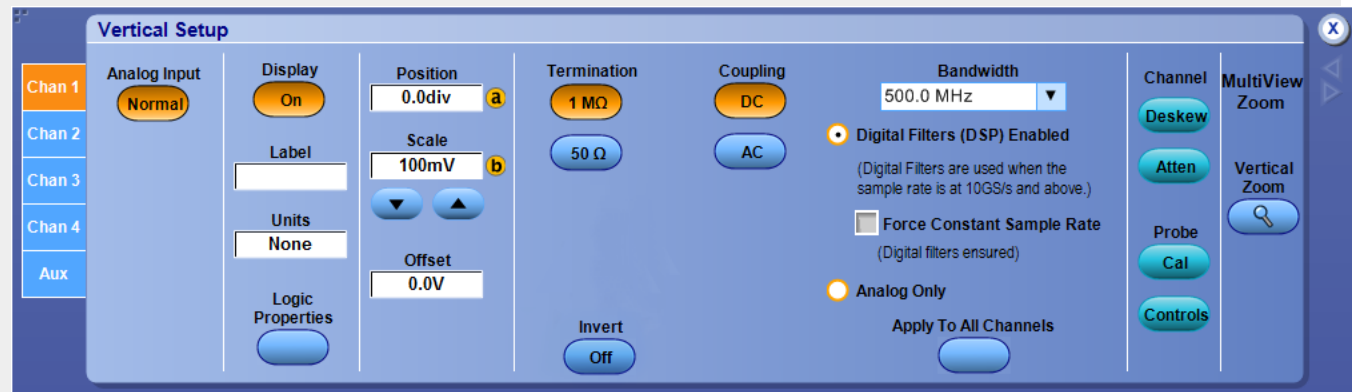

The following screen shows the Termination Voltage control that appears on MSO/DPO70000C Series instruments:

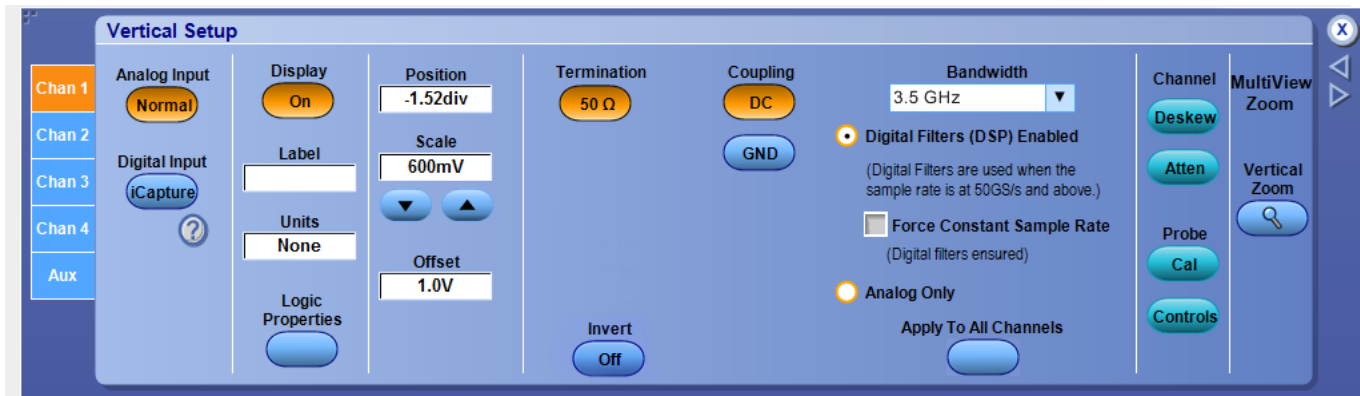

The following screen shows the Termination Voltage control that appears on MSO/DPO70000DX/SX Series instruments:

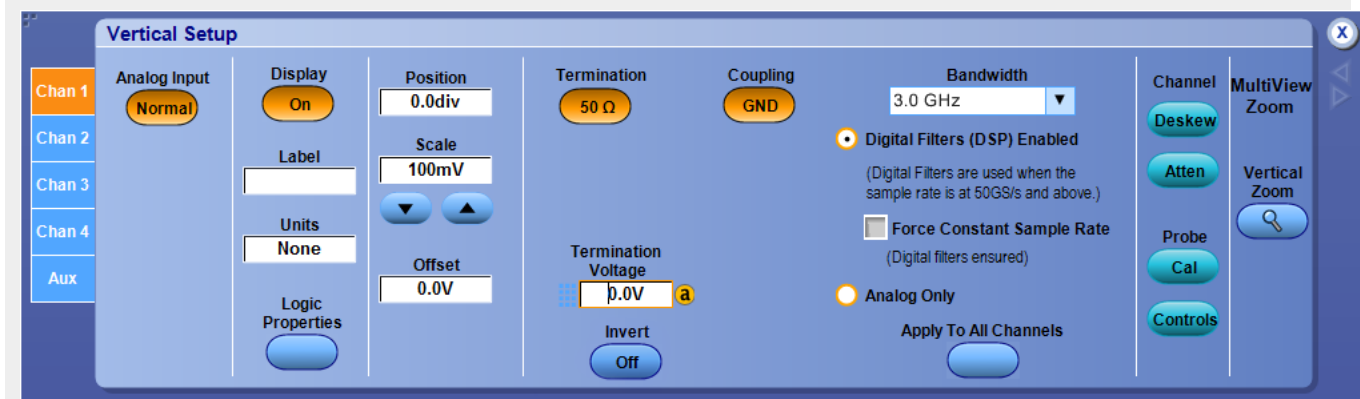

For information on the Vertical Setup controls, click the links.

NOTE. *iCapture* is available only on MSO70000C/DX Series instruments and DPO70000DX instruments with option MSOU installed. Termination Voltage is available only on MSO/DPO70000DX/SX Series instruments.

- [Input Setup](#)
- [iCapture Setup](#)
- [Viewing the Analog Characteristics of a Digital Signal](#)
- [Logic Properties](#)
- [Display & Label](#)
- [Position & Scale](#)
- [Offset](#)
- [Termination](#)
- [Termination Voltage](#)
- [Coupling](#)
- [Bandwidth](#)
- [Probes](#)
- [Vert Zoom](#)
- [Aux Tab](#)

NOTE. The bandwidth readout displays in reverse video if the bandwidth is not what you selected. If you want the bandwidth to be what you selected, make sure that the sample rate is high enough to enable Digital Filters (DSP). One way to enable DSP is to select Force Constant Sample Rate.

NOTE. The features and options that are documented in this online help are available for several instrument models. Your instrument may not have every feature discussed in this online help.

To use

Use the tabs on the side of the control window to select the channel you want to change. The controls for each channel are independent.

What do you want to do next?

[Continue to learn about the Vertical Setup controls.](#)

Set up input channels

NOTE. *iCapture* is available only on MSO70000C/DX Series instruments and DPO70000DX instruments with option MSOU installed.

From the Vertical menu, select Vertical Setup.

To use

- Click the Analog Input Normal button when you want to select the analog input of the channel for the selected tab. Each channel has a tab.

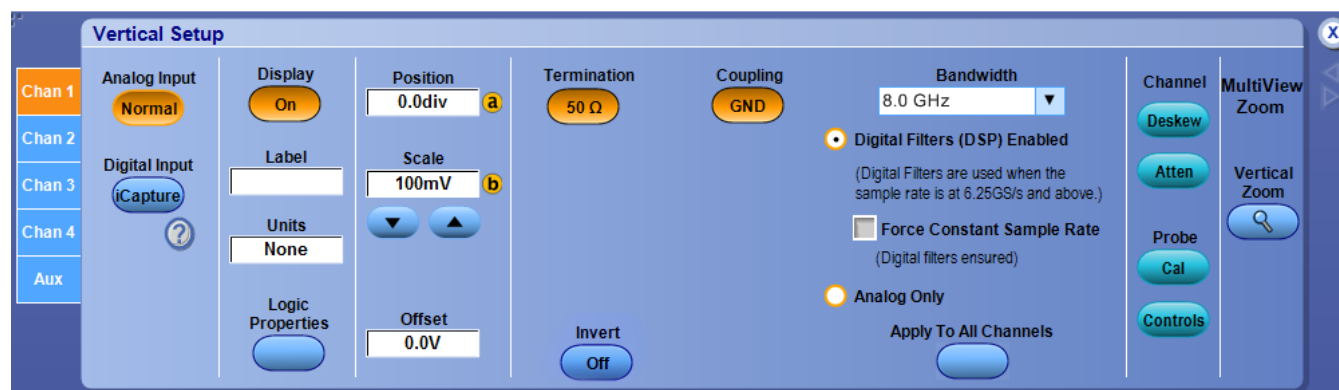

- Click the *Digital Input iCapture* button when you want the instrument to display analog characteristics of a digital channel. Use the Digital Source drop-down list to select a digital channel to display on the selected tab.

The following screen is captured on MSO70000C/DX Series instruments:

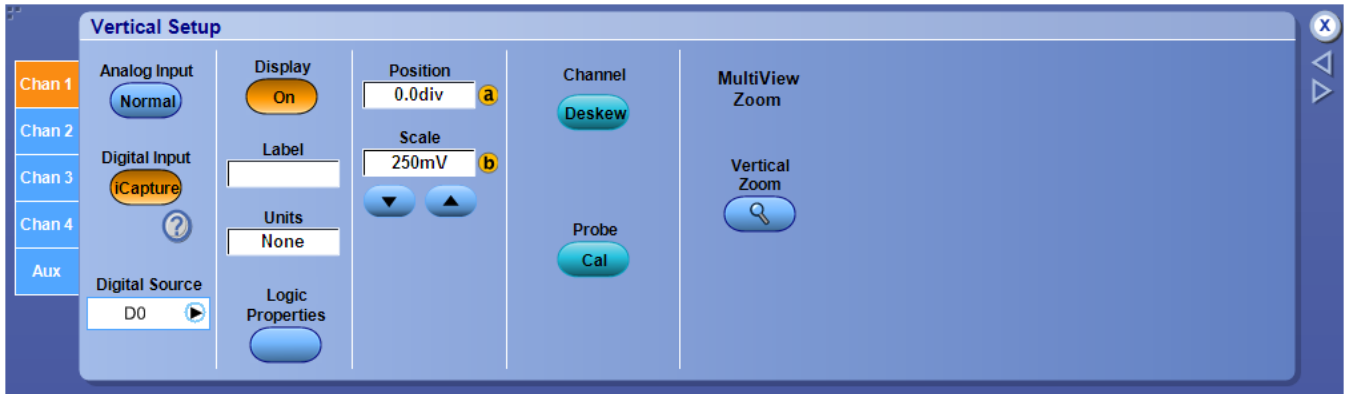

NOTE. Right-click on the digital source readout in the waveform window to reroute from one analog channel to any of the other three analog channels. For example, right-click on D0 captured on Ch1 and select iCapture on Ch2 to reroute source D0 to Ch2.

The following screen is captured on MSO/DPO5000B Series instruments:

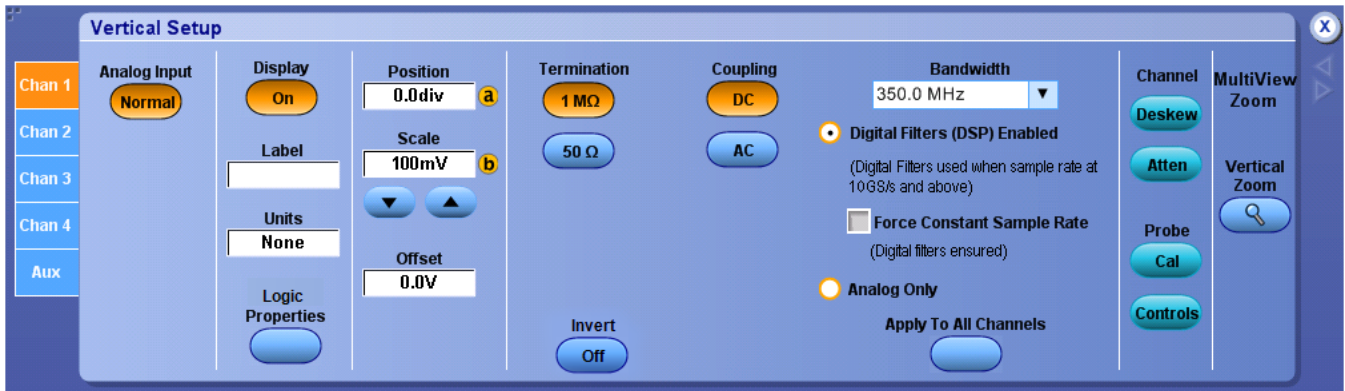

TIP. You have the option to add user-defined labels for the analog, reference, bus, and digital sources.

Behavior

When the Analog Input Normal button is selected, the remaining display, probe, and zoom parameters are the same as on all other models.

What do you want to do next?

[Continue to learn about the Vertical Setup controls.](#)

[Learn about the Digital Input iCapture feature.](#)

[Learn about the Digital Properties button.](#)

Zoom control window

From the Vertical or Horiz /Acq menus, select Zoom Controls, or push the front-panel MultiView Zoom button (DPO7AFP required on DPO7000SX instruments).

Overview

Use the Zoom control window to select the Zoom Area and Source, assign, and to lock and scroll the zoomed areas.



The following screen appears on MSO7000C/DX Series instruments:

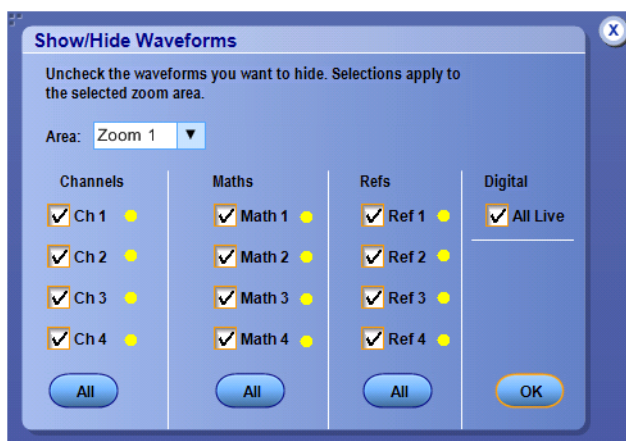
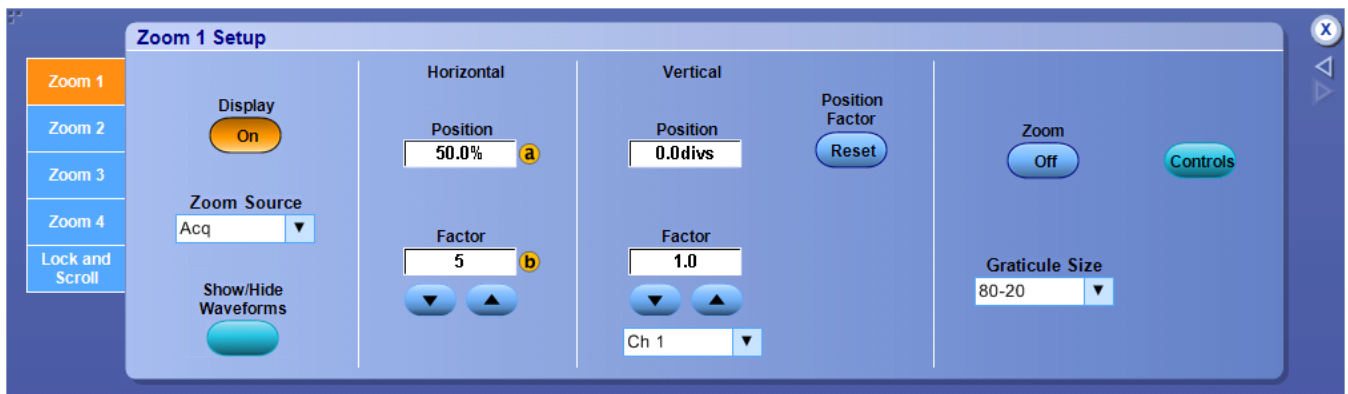

To use

1. Click a Horiz or Vert button to assign the Horizontal or Vertical zoom controls to the multipurpose knobs.
2. Select the zoom area from the Area drop-down list. The changes you make in this control window apply only to the zoom area selected.
3. Use the Zoom Source drop-down list to select the waveform or area you want to zoom in on.
4. Click the Waveforms Hide button to open the Show/Hide Waveforms dialog box; here you can identify waveforms you do not want to display in the selected zoom area.

Click Setup to display the [Zoom Setup control window](#) where you can access additional Zoom controls.

Behavior.

You can also access the controls for both the Acquisition and Zoom windows from the front panel. Selecting Zoom (1–4) as the Zoom Source allows you to zoom on zoom.



TIP. You can easily zoom in on a waveform by clicking and dragging a box around the area of interest. Then select Zoom (1–4) On from the shortcut.

What do you want to do next?

[Learn about the Zoom Setup controls.](#)

[Return to the Vertical Setup control window overview.](#)

[Return to the Horizontal Setup control window.](#)

[Learn about the AutoScroll control window.](#)

Waveform display control window

From the Vertical or Math menus, select Display On/Off.

Overview

Use the Position/Offset control window to turn the selected waveform on or off.

**To use**

1. Click the [Channels selector](#) to select a valid channel, math, or reference waveform.
2. Click Display to turn the selected waveform on or off.

Behavior

The Display button applies only to the selected waveform. Each waveform (channel, math, or reference) has its own Display button.

Any displayed channel, math, or reference waveform can be turned off without impacting any math functions, measurements, or histograms done on that waveform. You may want to turn some waveform displays off to make the remaining waveforms easier to view and analyze.



TIP. Use the dedicated front-panel buttons to turn the channel waveforms on or off.

What do you want to do next?

[Learn more about the Waveform controls.](#)

Set the Position-Offset

From the Vertical or Math menus, select Position/Scale.

To use

Use the Position/Offset control window to set the vertical position and offset of the selected waveform.

1. Use the [Channels Selector](#) to select a waveform.
2. Use the [Scale](#) and [Position](#) controls to set the vertical position and scale of the selected waveform.
3. Use the Offset control to set the [vertical offset](#) of the selected waveform.

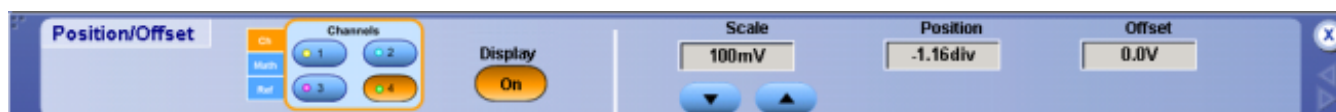

What do you want to do next?

[Learn more about the Vertical Position control.](#)

[Learn more about the Vertical Scale control.](#)

[Learn more about the Waveform controls.](#)

[Learn more about the Vertical controls.](#)

Waveform label control window

From the Vertical or Math menus, select Label.

Overview

Use the Label control window to attach a label to the waveform.



To use

1. Use the [Channels Selector](#) to select a valid channel, math, or reference waveform.
2. Click in the Label entry box, and then use the pop-up keyboard to create a label for the selected waveform.
3. Click in the X Position and Y Position entry boxes to activate them.
4. Use the multipurpose knobs to position the label on the graticule. You can also position the label anywhere on the screen by clicking and dragging it to the desired location.

Behavior

The label applies only to the selected waveform. Each waveform (channel, math, or reference) can have its own label. If you do not enter a label for the selected waveform, the label will be left blank. A label only appears when its associated waveform is turned on.

The X Pos control values are relative to the left side of the display. The YPos control values are relative to the waveform handle. The values are expressed in divisions.

What do you want to do next?

[Learn more about the Vertical controls.](#)

[Learn more about the Math controls.](#)

[Learn more about the Reference Waveform controls.](#)

Vertical offset control window

From the Vertical menu, select Offset.

Overview

Use the Position/Offset control window to set the offset value of the selected waveform to shift the vertical *acquisition window* to match the waveform data you want to acquire.

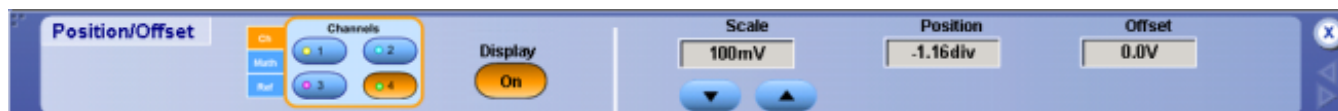

To use

1. Use the *Channels Selector* to select a valid channel, math, or reference waveform.
2. Click a Channel button to select the vertical input channel.
3. Click in the Offset entry box, and use a multipurpose knob to set the offset value.

Behavior

The main purpose of the Offset control is to avoid *clipping the waveform*. The Offset control adjusts the DC bias level that is subtracted from the input signal of a channel and establishes the level at the vertical center of the acquisition window for that channel. Channel reference indicators always point to the offset level of the channels. Offset affects only channel waveforms, whereas the Position control affects all waveforms, including math and reference waveforms.

NOTE. The range of vertical offset available depends on the type of probe used.

What do you want to do next?

[Learn more about the Vertical controls.](#)

Using offset to avoid clipping signals

| Using Offset to Avoid Clipping Signals | |
|--|--|
| | <p>Clipping The circled portion of the incoming waveform is clipped, and therefore, is not acquired. The clipped portion cannot be processed or displayed. Offset can move the acquisition window vertically relative to the incoming waveform.</p> |
| | <p>Offset removes clipping By setting an offset to vertically shift the acquisition positive relative to the waveform, the clipped portion can be acquired.</p> |

Termination controls

From the Vertical menu, select Termination.

Overview

Use the Termination control window to select the channel input resistance.

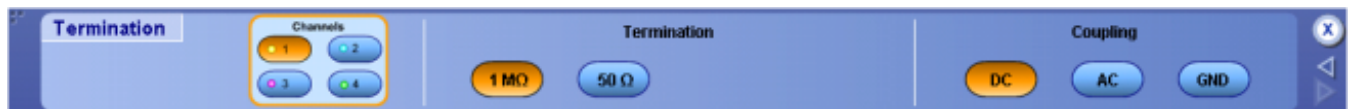

For MSO/DPO70000C/DX model oscilloscopes, Termination is fixed at 50 Ω.



The following screen appears on MSO/DPO5000B Series instruments:

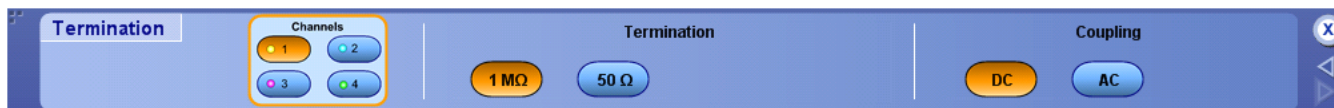

To use

- Click a Channels button to select the vertical input channel.
- Click one of the Termination buttons to set the termination for your probe; termination can also be set during probe compensation.

NOTE. If you are using a probe with a TekProbe/TekVPI interface, the termination is set automatically.

Behavior

The correct termination is set automatically when you attach a probe with a TekProbe interface to the instrument.

You may need to set the termination manually if you use a probe without the TekProbe Interface. In general:

- Select 1 M Ω to use high impedance passive probes.
- Select 50 Ω to use most active probes and *low impedance (Zo) probes*.

NOTE. On instruments with GND coupling, the 50 Ω termination becomes an open circuit if you set the channel input coupling to GND.

Consider the following when using 50 Ω termination with any channel:

- The instrument does not accurately display frequencies under 200 kHz with AC coupling, if set to 50 Ω termination.
- The instrument reduces the maximum vertical scale setting for the channel to 1 V from 10 V (to 10 V from 100 V with a 10X probe attached), since the amplitudes appropriate for the higher settings would overload the 50 Ω input.
- The instrument switches to 50 Ω and disables AC coupling (and switches coupling to DC if AC is selected) if you connect an active probe. The active probes also reduce the maximum vertical scale setting as described above. This behavior results in 50 Ω , non-AC coupling, which is appropriate for active probes.

What do you want to do next?

[Learn more about the Vertical controls.](#)

[Learn more about the Bandwidth controls.](#)

TekProbe/TekVPI Interface

This interface enables the instrument to sense information about the probe such as the serial number and other unique identification information. It also allows the instrument to provide power directly to the probe.

With this information, the instrument can automatically set up its requirements to match the characteristics of the probe, such as termination and attenuation.

High Impedance Probes

Most general-purpose probes have high input impedance.

The high input resistance of passive probes (typically 10 MΩ) provides negligible DC loading and provides accurate DC amplitude measurements.

Most passive probes require the instrument input impedance to be 1 MΩ. However, their 8 pF to 12 pF (over 60 pF for 1X) capacitive loading can distort timing and phase measurements.

Use high resistance passive probes for measurements involving the following:

- Device characterization (above 15 V, thermal drift applications)
- Maximum amplitude sensitivity using 1X probe
- Large voltage range (between 15 V and 500 V)
- Qualitative or go/no-go measurements

Active Probes

Active voltage probes often contain preamplifiers that provide high resistance and low capacitance at the probe tip. Some active voltage probes contain differential amplifiers that provide high Common Mode Rejection Ratio (CMRR).

Active current probes often contain Hall-effect sensors that extend the probe bandwidth down to DC.

Many active probes, especially high frequency probes, can drive a 50 Ω instrument input.

Coupling controls

From the Vertical menu, select Coupling.

Overview

Use the Termination control window to select the input coupling.

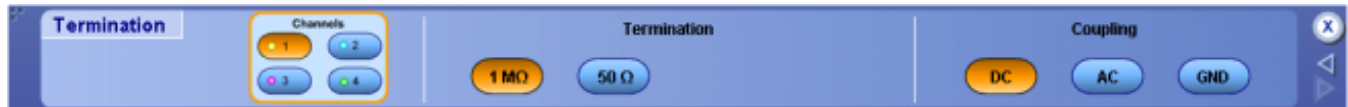

For MSO/DPO7000C/DX model oscilloscopes, DC coupling is the only selection.



The following screen appears on MSO/DPO5000B Series instruments:



To use

1. Click a Channels button to select the vertical input channel.
2. Click one of the Coupling buttons to couple the signal from the probe to the instrument.

Behavior

- Select DC coupling to display a waveform with AC and DC components.
- Select AC coupling to display a waveform with its DC component removed.
- Select GND to display a zero-volt waveform. Use this selection to establish the ground reference point on the display.

What do you want to do next?

[Learn more about the Vertical controls.](#)

[Learn more about the Bandwidth controls.](#)

Deskew-Attenuation control window

From the Vertical menu, select Deskew or Attenuation.

Overview

Use the Deskew/Attenuation control window to compensate for propagation delays of different length probes and to set the input/output ratio of any external attenuation or gain between the signal and input channels.

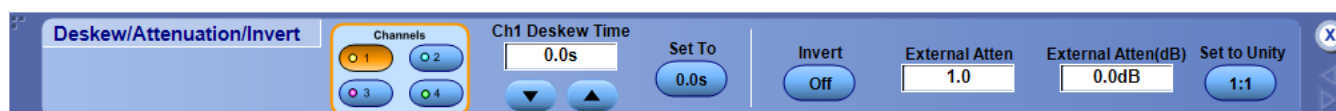

To use

Use the Deskew/Attenuation/Invert controls to change the settings after you set up the [Vertical Setup Control Window](#).

Deskew (DPO7000SX series)

1. To deskew TekConnect channels, connect the channel inputs, through the cables you will use to take measurements, to the Differential Fast Edge outputs.
2. To deskew ATI channels, connect the channel inputs, through a connector saver and the cables you will use to take measurements, to the Differential Fast Edge outputs by way of a 1.85 mm to 2.92 mm adapter and the standard accessory deskew attenuator and deskew cable.



CAUTION. To prevent damage to the instrument, if connecting the Differential Fast Edge outputs to an ATI channel, use a connector saver and an attenuator.

3. Use the horizontal and vertical controls to center the fastest signal on the screen, do not use Autoset.
4. Select the slower channel.
5. Double click in the Deskew Time entry box, and use a keyboard to adjust the deskew time so the rising and falling edges align.
6. To clear the deskew value, click the Set To 0.0s button.

Each input channel has its own deskew settings. Deskew compensates individual channels for probes or cables of different lengths. The instrument applies the delay values after each completed acquisition. The deskew values are saved as part of the instrument setup. The deskew values for the selected channel will be retained until you change the probe, you restore a saved setup, or you recall the factory setup.

Deskew (non DPO7000SX series)

1. Connect the probes to a signal source.
2. Use the horizontal and vertical controls to center the fastest signal on the screen.
3. Click a Ch <1–4> button to select the slower channel.
4. Click in the Deskew Time entry box, and use a multipurpose knob to adjust the deskew time so the two signals align.

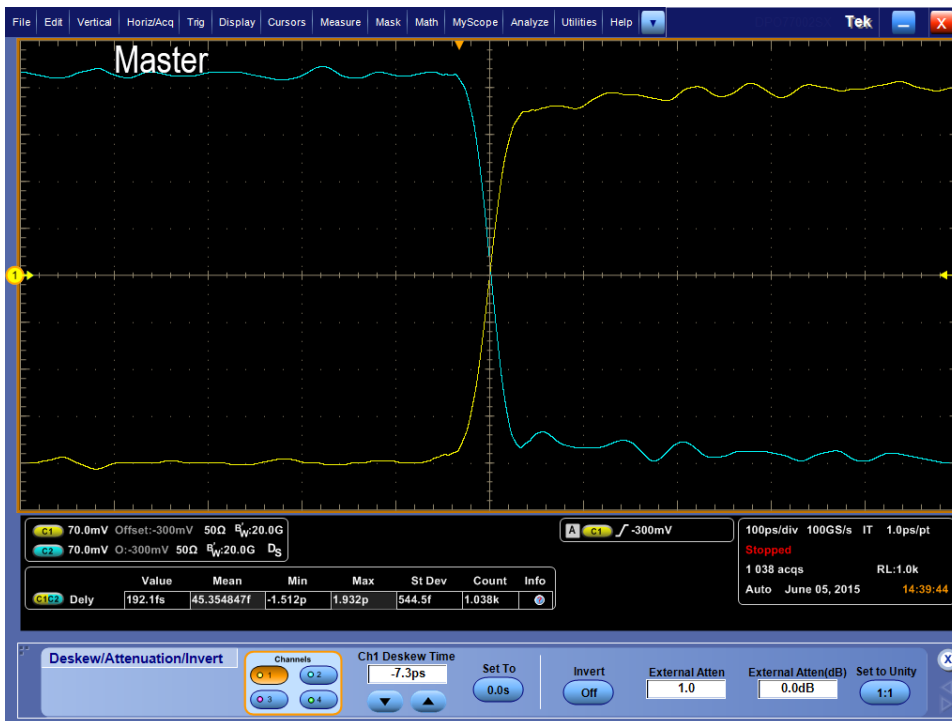

5. To clear the deskew value, click the Set To 0.0s button.

Each input channel has its own deskew settings. Deskew compensates individual channels for probes or cables of different lengths. The instrument applies the delay values after each completed acquisition. The deskew values are saved as part of the instrument setup. The deskew values for the selected channel will be retained until you change the probe, you restore a saved setup, or you recall the factory setup.

Attenuation.

1. Click a Ch <1–4> button to select the vertical input channel for the attached probe.
2. To set the external attenuation as a multiplier or ratio, click in the External Atten entry box and use a multipurpose knob to enter a value.
3. To set the external attenuation as dB values, click in the External Atten (dB) entry box and use a multipurpose knob to enter a value.
4. To set the external attenuation to the default value, click Set to Unity.

Each input channel has its own external attenuation settings. The attenuation control is automatically set to the correct value when you attach a probe with a TekProbe/TekVPI interface to the instrument. You can change the external attenuation by entering a multiplier or ratio with one control, or by entering a dB value with the other control.

Invert.

1. Click a Ch <1–4> button to select the vertical input channel.
2. To invert the selected channel, click in the Invert button.

Bandwidth control window

From the Vertical menu, select Bandwidth Limit.

Overview

Use the Bandwidth control window to filter unwanted high-frequency noise from the waveform and to decrease the noise bandwidth.

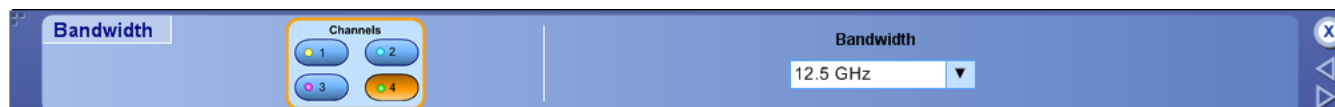

To use

1. Click a Channels button to select the vertical input channel.
2. Use the drop-down list box to select the range of frequencies to acquire.

Behavior

Bandwidth refers to the range of frequencies that the instrument can acquire and display accurately with less than 3 dB attenuation.

Each input channel has its own bandwidth selection. Bandwidth selections with (HW) indicate a hardware/analog-only filter. See the [Vertical Setup Control Window](#) for more information on controls that affect the [bandwidth selections](#).

To take accurate measurements, the input frequency should be much less than the rated bandwidth of the instrument. A good rule to follow is to ensure the bandwidth of the instrument system is three to five times the bandwidth of the signal that you want to measure.

What do you want to do next?

[Learn more about the Vertical controls.](#)

Enhanced bandwidth

From the Vertical menu, select Bandwidth Enhanced.

Overview

The Bandwidth Enhancement controls (similar to those shown below) allow you to use DSP processing to achieve more accurate rise time measurements, to extend the bandwidth, and to flatten the passband at the full sample rate.

Enhanced Bandwidth also provides a matched response across enabled channels for channel-to-channel comparisons and differential measurements. The available bandwidth enhancement selections will vary depending on the instrument you purchased. Enhanced bandwidth is extended to the probe tip for some high performance probes and tips.

To use

To enable Bandwidth Enhancement for a vertical input channel:

1. Select a Channel tab in the Vertical Setup window.
2. Click Digital Filters (DSP) Enabled to activate the Bandwidth Enhancement filters. This is the only option available for the ATI input on DPO70000SX instruments.
3. Click Apply to All Channels to On to apply Bandwidth Enhancement to all channels simultaneously.
4. Click Analog Only to disable Bandwidth Enhancement and return to Analog operation. The Bandwidth drop-down list adds (HW) to the selection indicating a hardware/analog-only filter.

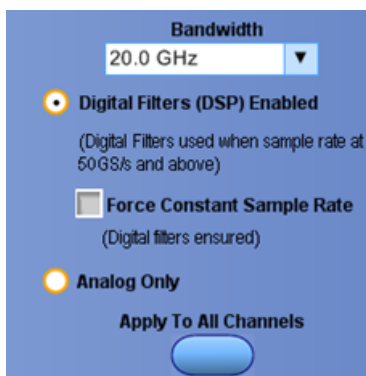

The following screen appears on MSO/DPO5000B Series instruments:

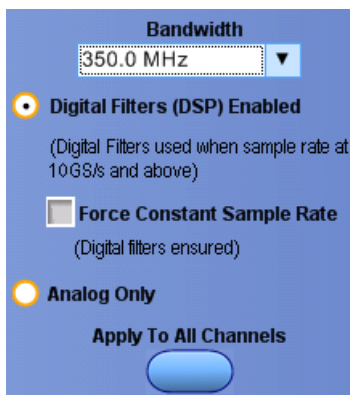

NOTE. For ≥ 3.5 GHz instrument models, the DSP filter on each channel provides magnitude and phase compensation of the analog bandwidth to provide more accurate signal fidelity for high-speed measurements. Digital Filtering (DSP) Enabled provides low-pass bandwidth filtering only to reduce noise. Refer to your oscilloscope Specifications for a list of bandwidth enhancements available for each vertical scale setting on your instrument.

The bandwidth enhance filter does not operate in FastAcq mode.

Behavior

Enhanced bandwidth, when enabled, applies independent DSP filtering to four channels.

The following settings are available:

- **Digital Filters (DSP) Enabled.** Enables the selected channel to automatically use the Digital Signal Process (DSP) filter. The BW indicator appears in the readouts when Enhanced Bandwidth is active. The BW indicator will appear in reverse video if the user requested bandwidth cannot be achieved.
- **Force Constant Sample Rate.** The instrument takes the constant sample rate that you set in the Horizontal control window, and applies a sample rate supported by DSP. It then enables DSP and selects the appropriate bandwidth.
- **Analog Only.** Disables the DSP filter for the selected input channel.
- **Apply to All Channels.** Applies the DSP settings of the active channel to all channels simultaneously.



TIP. To enable or disable DSP filtering for all channels at once, click the Apply to All Channels button after turning the Enhanced Bandwidth feature on or off.

NOTE. You may want to turn the DSP filter off to take advantage of the full analog bandwidth for analyzing and debugging multiple-lane serial devices. DSP Enabled is the Default setting.

What do you want to do next?

[Learn more about bandwidth enhancement.](#)

Enhanced Bandwidth Indicator



Reverse Video Bandwidth Indicator



Vertical setup control window (Aux tab)

From the Vertical menu, select Vertical Setup; then open the Aux tab.

Overview

The Vertical Setup Aux Tab, similar to the window shown below, reports the status of the Auxiliary trigger input. This input is located on the [instrument front panel](#).

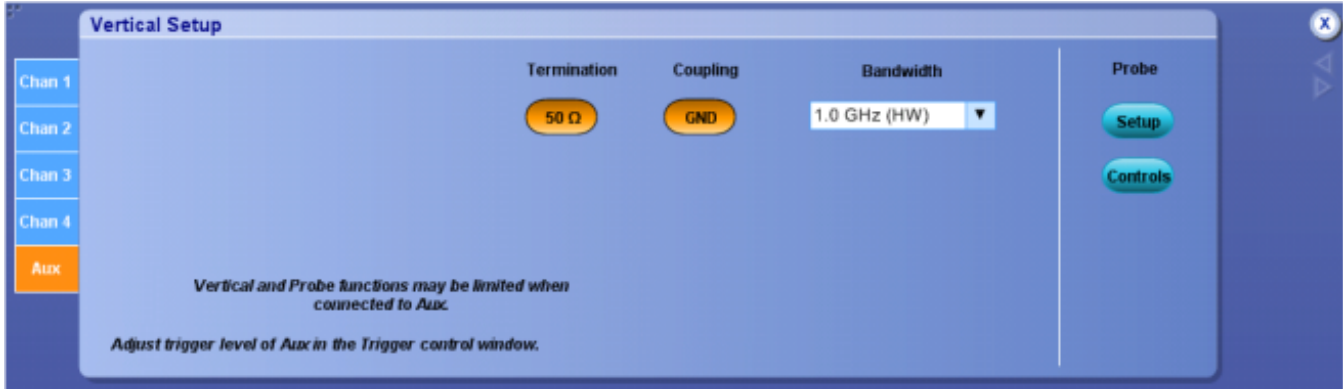

The following screen appears on MSO/DPO5000B Series instruments:

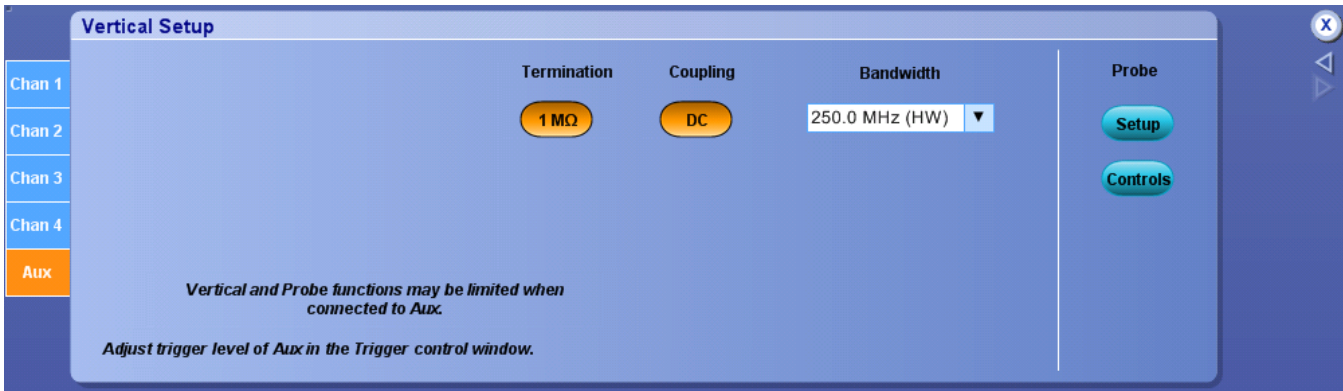

NOTE. Some instruments include a Bandwidth control. For these instruments, you can set the Auxiliary Input bandwidth in the drop-down list box.

To use

To access the controls for this window, connect a compatible probe.

What do you want to do next?

[Continue to learn about the Vertical Setup controls.](#)

Probe setup control window

From the Vertical menu, select Probe Cal.

Overview

Use the Probe Setup control window to compensate and check probe status and to compensate the entire signal path. This will improve the probe gain and offset accuracy. Probe compensation is one of several features you can use to optimize measurement accuracy.

NOTE. The example windows below do not show the controls for the attached probes.

Click for DPO7000C and MSO/DPO5000B instruments:

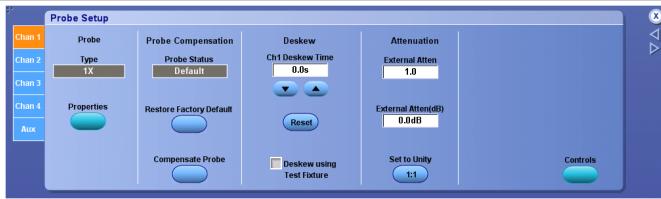

Click for MSO/DPO7000C/DX/SX instruments:

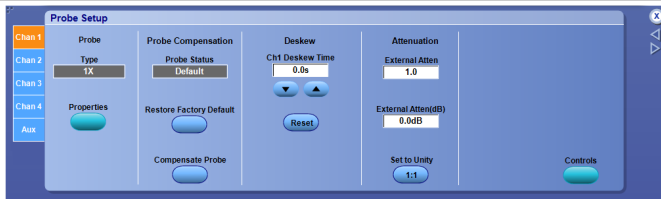

Probe Setup

| Chan 1 | Probe | Probe Compensation | Deskew | Attenuation | |
|--------|------------|-------------------------|--|-----------------------------|----------|
| Chan 2 | Type 1X | Probe Status Default | Ch1 Deskew Time 0.0s | External Atten 1.0 | |
| Chan 3 | | | ▼ ▲ | | |
| Chan 4 | Properties | Restore Factory Default | Reset | External Atten(dB) 0.0dB | |
| Aux | | Compensate Probe | <input type="checkbox"/> Deskew using Test Fixture | Set to Unity 1:1 | Controls |

The following screen appears on MSO/DPO5000B Series instruments:

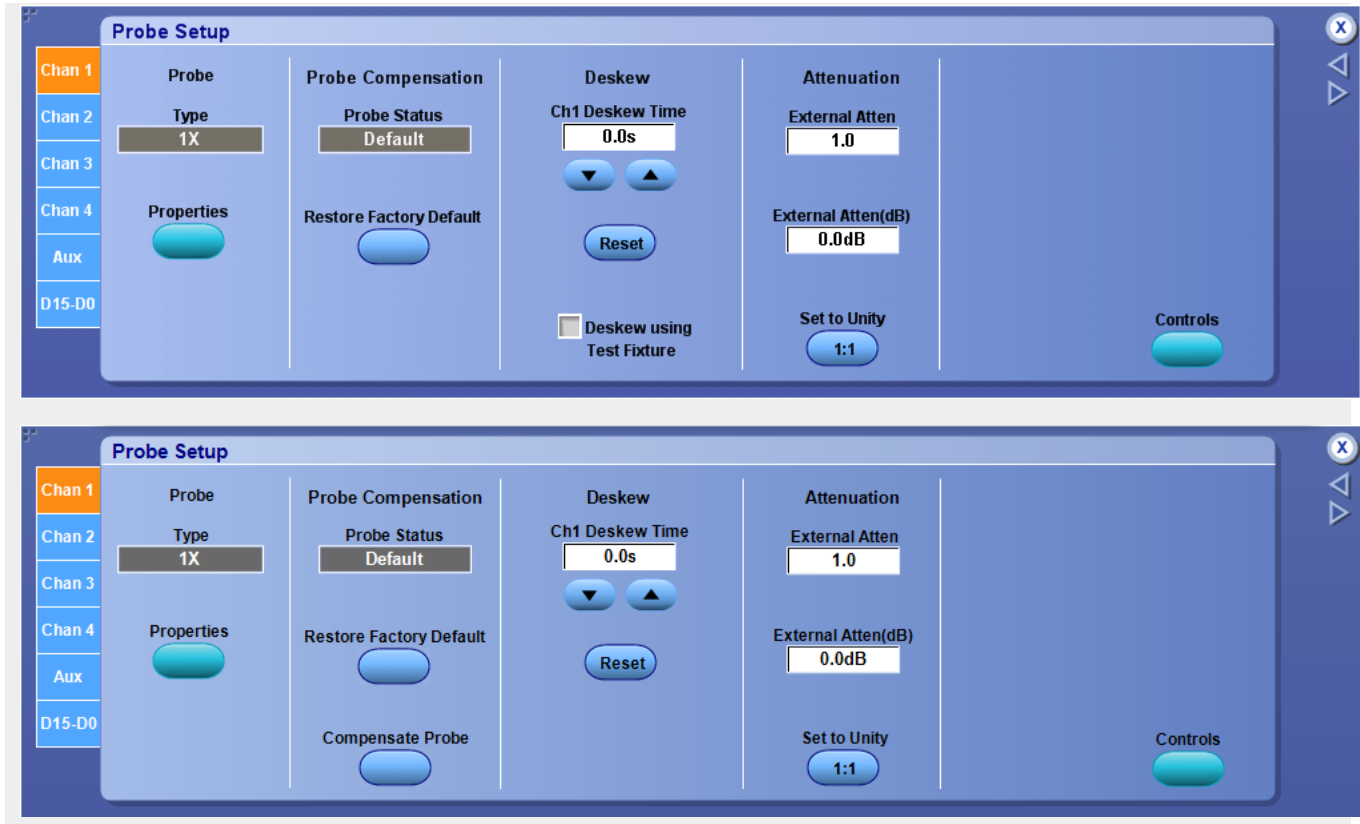

For information on the Probe Setup controls, click the buttons.

- [Compensation](#)
- [Status](#)
- [Deskew](#)
- [Attenuation](#)
- [Type](#)

NOTE. The Probe Status control indicates the status of probe compensation for the selected channel. If the probe status does not indicate Pass, the instrument may not take accurate measurements. You may want to perform the probe compensation procedure before taking any measurements with the selected probe.

In addition to the probe setup above, it is recommended that you do the following to assure measurement quality:

- Use the correct probe tip for your probe. This will ensure that the correct bandwidth filter is applied and performance is extended to the probe tip.
- Use the [Probe Compensation](#) procedure to compensate passive probes. This will ensure maximum distortion-free inputs to the instrument and avoid high frequency amplitude errors.
- Use the [Signal Path Compensation](#) procedure to compensate the internal signal path used to acquire waveforms based on the ambient temperature.

Tips for Reducing Measurement Noise

- Use the least amount of attenuation. Probe noise is a function of probe attenuation, for example, using a 25X probe, versus a 5X probe, results in significantly greater noise.
- Select the lowest attenuation that displays the input voltage swing of your signal; then use the vertical scale setting to adjust the waveform display on screen, as needed.
- Use a lower bandwidth probe to reduce noise.
- Reduce the vertical bandwidth of your oscilloscope. In general, a bandwidth 3 to 5 times the fundamental frequency of the waveform is a good compromise, allowing capture of harmonic content while minimizing noise.

What do you want to do next?

[Learn more about the Probe Status indicator.](#)

[Learn more about the Probe Compensation controls.](#)

[Go to a step-by-step procedure to calibrate active probes.](#)

[Go to a step-by-step procedure to calibrate passive probes.](#)

[Learn more about the Vertical controls.](#)

Probe Compensation Adjustment

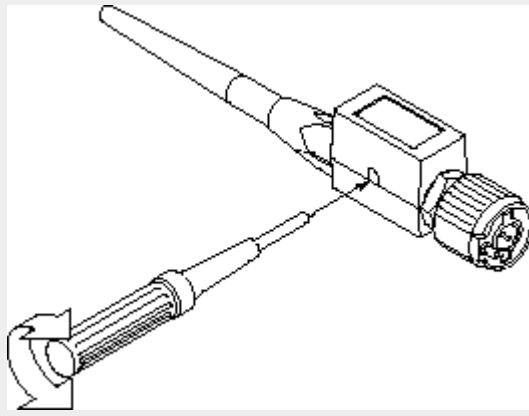

Probe setup control window (Setup type)

From the Vertical menu, select Probe Controls, and then click the Setup button.

NOTE. You must attach an appropriate probe to the logic probe port or to the Ch1-Ch4 vertical input to activate this setup window.

Overview

Use the Probe Setup control window to configure a probe that you connect to the vertical input.

Click for DPO7000C and MSO/DPO5000B instruments:

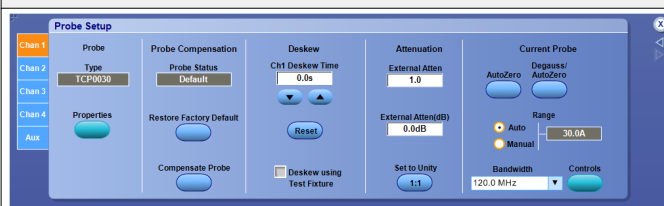

Click for MSO/DPO70000C/DX/SX and DPO7000C instruments:

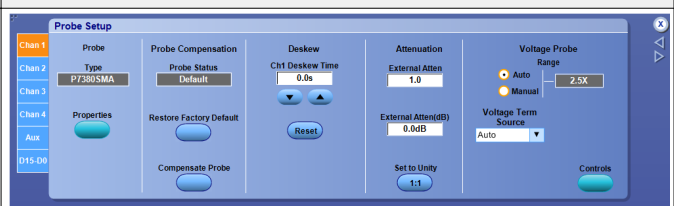

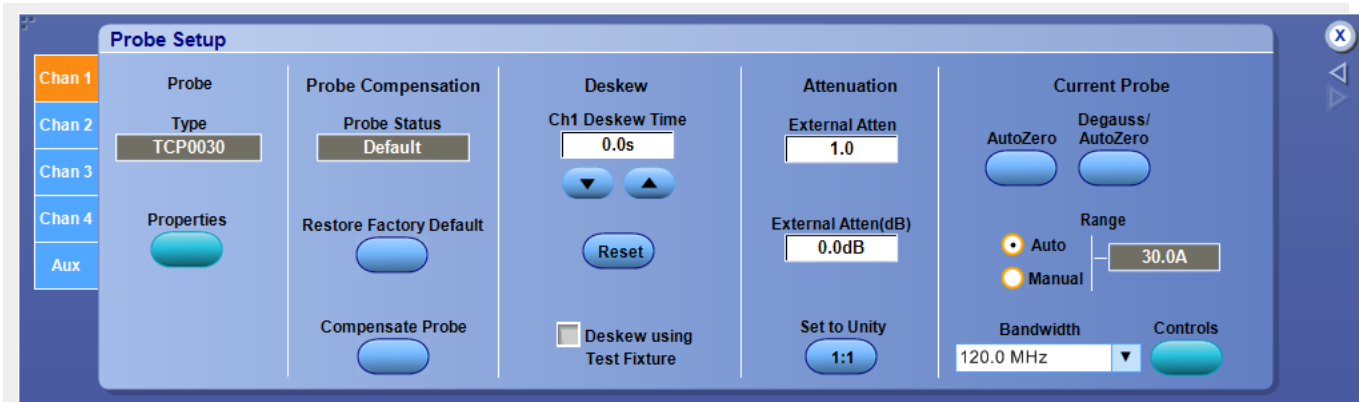

The following screen appears on MSO/DPO5000B Series instruments:

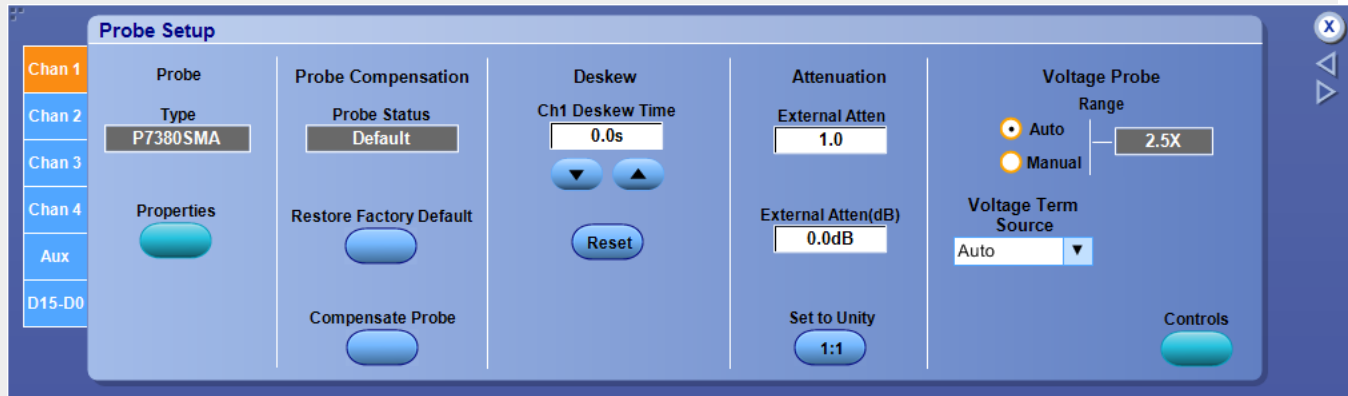
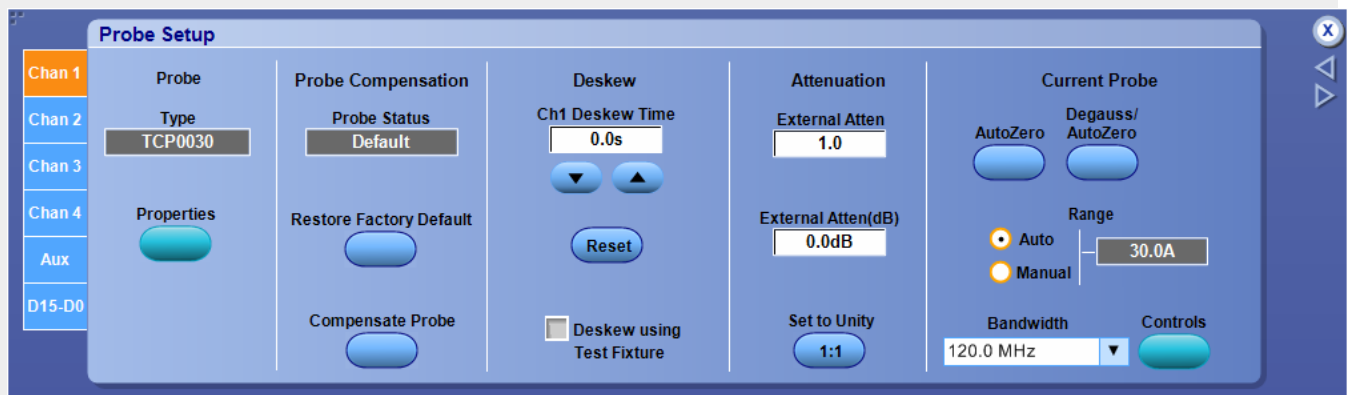

For information on the Probe Setup controls, click the button.

- [Controls](#)

To use

1. Connect a probe to a vertical input.
2. Press a front panel Ch <1–4> button to activate the channel.
3. In the Probe Setup window, click a Chan <1–4> tab to activate the controls for the input source.
4. Configure the controls for the probe type you attached.

What do you want to do next?

[Learn more about the Vertical controls.](#)

Probe setup control window (D15-D0 tab)

NOTE. The Probe Setup Control Window: D15-D0 Tab is available only on MSO5000B and MSO70000C/DX Series instruments and on DPO5000B Series instruments with option MSOE installed, and DPO70000DX instruments with option MSOU installed.

From the Vertical menu, select Probe Controls, click the Setup button, and then open the D15-D0 tab.

NOTE. You must attach a logic probe to the logic probe port on the front panel to activate this setup window.

Overview

Use the Probe Setup control window to align the instrument trigger path to optimize measurement accuracy. The logic probe input for channels D15-D0 is located on the [instrument front panel](#).

The instrument requires the Logic Probe Deskew Fixture (Tektronix part number 067-2083-XX) to deskew the logic probe trigger path.

To use

For information on the controls, click the buttons.

- [Properties](#)
- [Align Trigger Path](#)

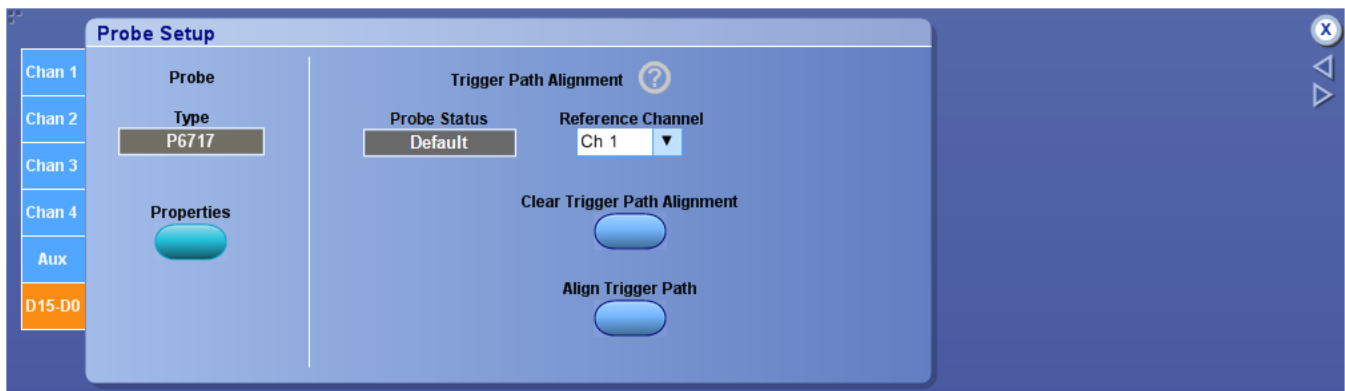

1. Connect a logic probe to the logic probe port on the front panel.
2. From the Digital menu, select Digital Setup.

3. Click the D7-D0 or the D15-D8 tab, and then the desired digital channel buttons to activate the controls for the logic source.
4. From the Vertical menu, select Probe Controls, and then click the Setup button.
5. Click the Properties button to display information on the logic probe and the status of the trigger path alignment.

What do you want to do next?

[Learn about setting up the digital channels.](#)

[Learn about digital setups.](#)

[Learn about setting up a bus.](#)

Probe setup control window (Probe compensation)

From the Vertical menu, select Probe Cal.

Overview

Use the Probe Setup control window to compensate a probe; this will improve the gain and offset accuracy. Probe compensation is specific to the channel to which it is connected.

NOTE. To compensate/calibrate a P7520A or P7600 series probe, use the procedure in the probe manual. Use the manual that came with your probe, the manual in the documentation browser that is accessible from the instrument desktop, or download the manual from the Tektronix Web site.

Click for DPO7000C and MSO/DPO5000B instruments:

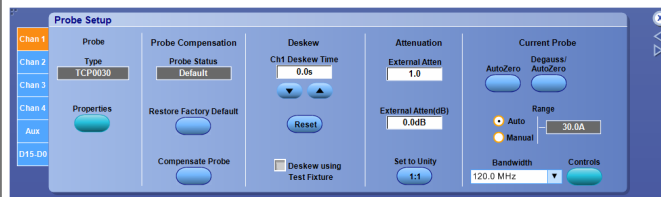

Click for MSO/DPO70000C/DX/SX instruments:

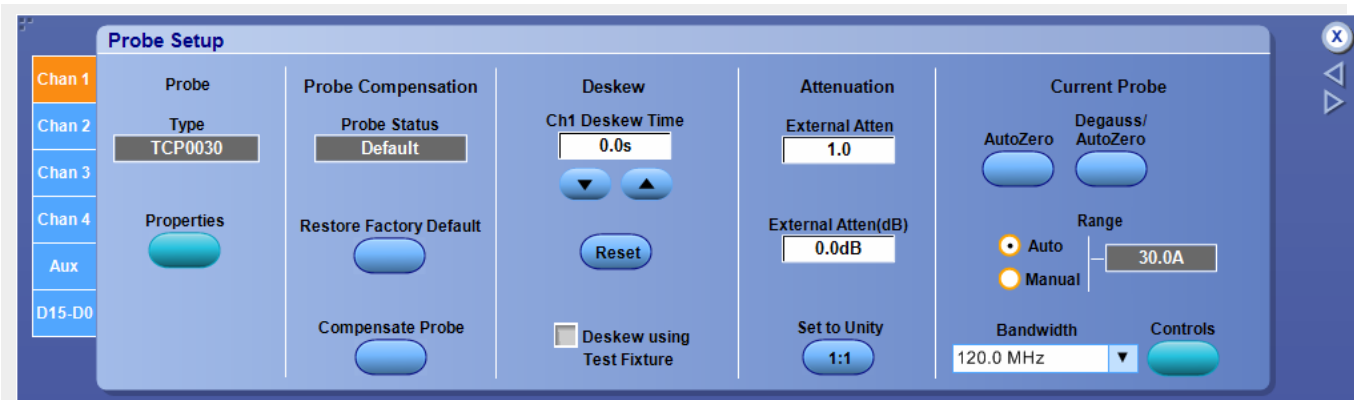
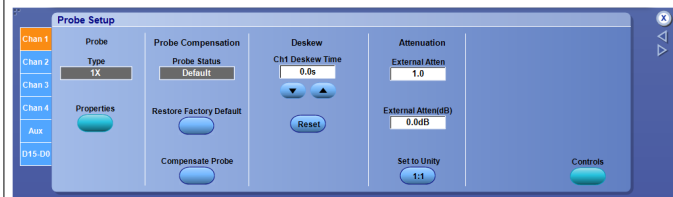

The following screen appears on MSO/DPO5000B Series instruments:

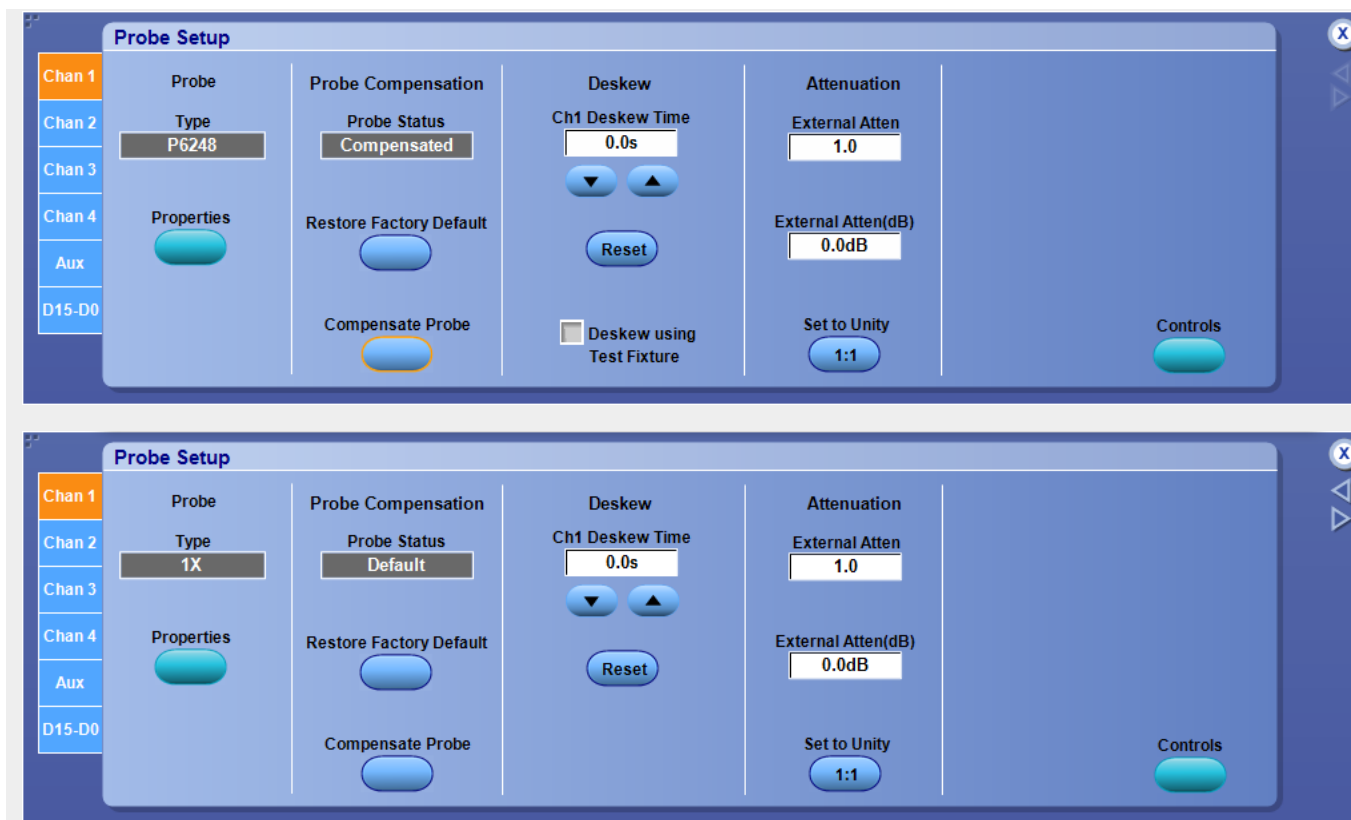

To use

1. Connect a probe to a vertical input.
2. Press a front panel Ch <1–4> button to activate the channel.
3. In the Probe Setup window, click a Chan <1–4> tab to activate the controls for the input source.
4. Select the probe Type for the appropriate signal and ground connections of the probe compensation terminals.
For some probes, click the *Probe Tip Select button* and select the tip that matches the one you are using.
5. Click Restore Factory Default to clear the old values.
6. Click Compensate Probe to begin the procedure.

Behavior

When you perform a probe compensation on the selected channel, you optimize the instrument to make accurate measurements for that channel and probe. The probe compensation makes significant performance improvements when performed with active probes or older passive probes.

You can perform a probe compensation at any time to ensure measurements are taken with the highest possible accuracy. Perform a probe compensation if you have changed probes since the last time a probe compensation was performed.



TIP. If you are compensating a passive probe, you must first compensate the low-frequency response of the probe. Refer to the Probe Compensation Procedure for more information.

Some types of probes can be gain compensated, some can be offset compensated, and some can be compensated for both. If the probe has a *TekProbe/TekVPI interface*, the instrument can determine the type of compensation needed and will display the appropriate instructions when you perform the probe compensation procedure. Some probes cannot be compensated; for information on these probes, refer to probe compensation restrictions.

Some probes cannot be compensated. This might be because the probes have an attenuation factor greater than 20X. You will get an error message if you try to compensate such a probe.

The instrument cannot compensate for probes that may have gain and/or offset errors that are too great (>2% or >50 mV offset). If these errors are within the specified limits of your probe, you may want to use another probe. If the errors are outside the limits, have your probe checked by service personnel.

Probe compensation is not recommended for the P5050 passive probe. This probe typically has little gain and offset error, and therefore, the performance improvement after a probe compensation is not worth the time needed to do the probe compensation.

What do you want to do next?

[Go to a step-by-step procedure to compensate active probes.](#)

[Go to a step-by-step procedure to compensate passive probes.](#)

[Learn more about the Vertical controls.](#)

Probe setup control window (Probe tip selection)

From the Vertical menu, select Probe Cal, and then click the Probe Tip Select button.

NOTE. Some probes have more than one type of probe tip available. The type of probe tips in the selection window change according to the probe connected to the instrument. Refer to the probe instructions manual for more information on the tips available for your probe.

To use

1. Select the type of probe tip to match the one you are using.
2. Click OK.

Here is an example of Probe Tip for Tektronix P73XX probe.

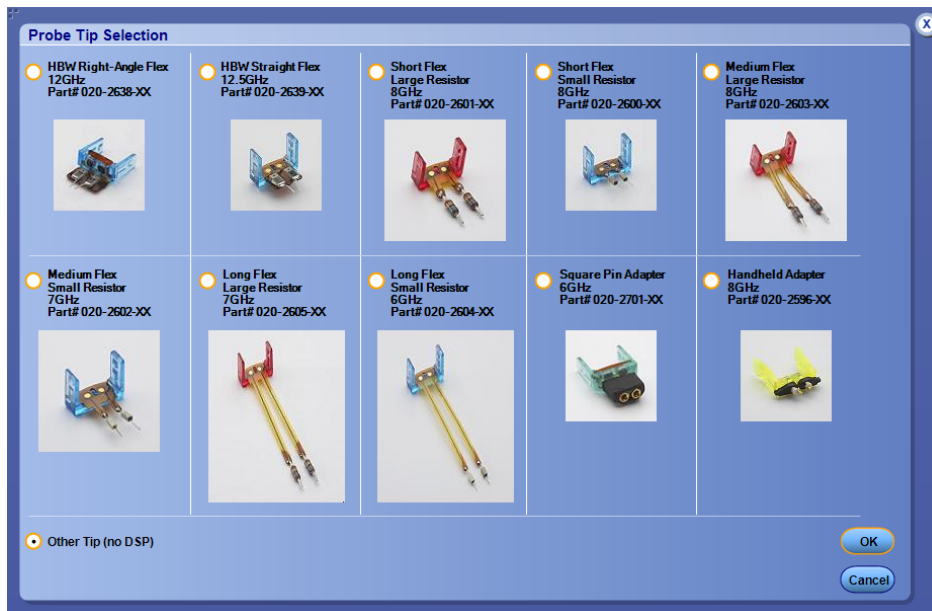

Here is an example of Probe Tip for Tektronix Trimode probe.

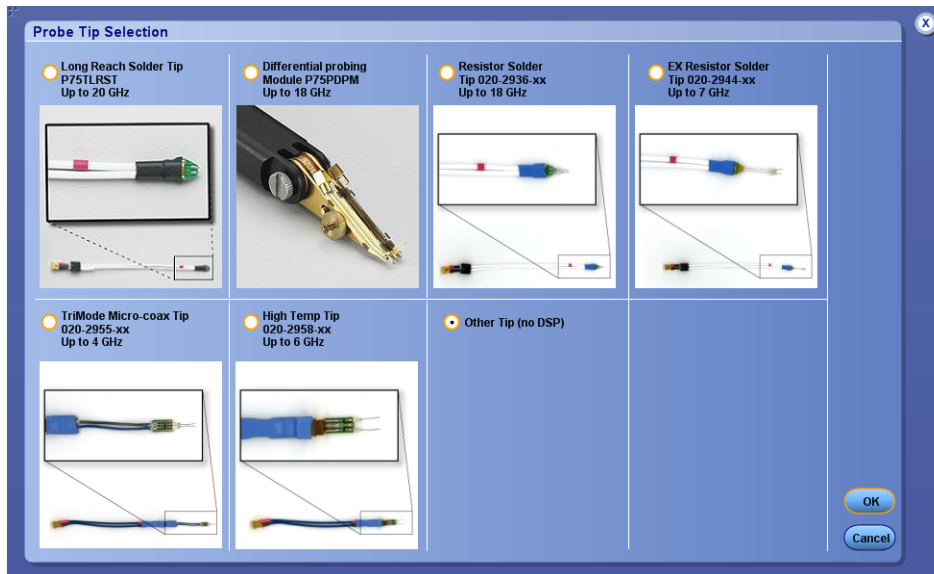

Probe setup control window (Probe deskew)

From the Vertical menu, select Deskew.

Overview

Use the Probe Setup control window to compensate for propagation delays of different length probes connected to the vertical input channels.

Click for DPO7000C and MSO/DPO5000B instruments:

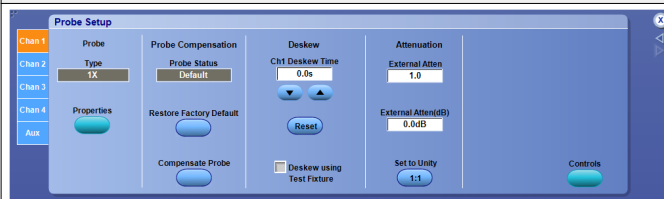

Click for MSO/DPO7000C/DX/SX instruments:

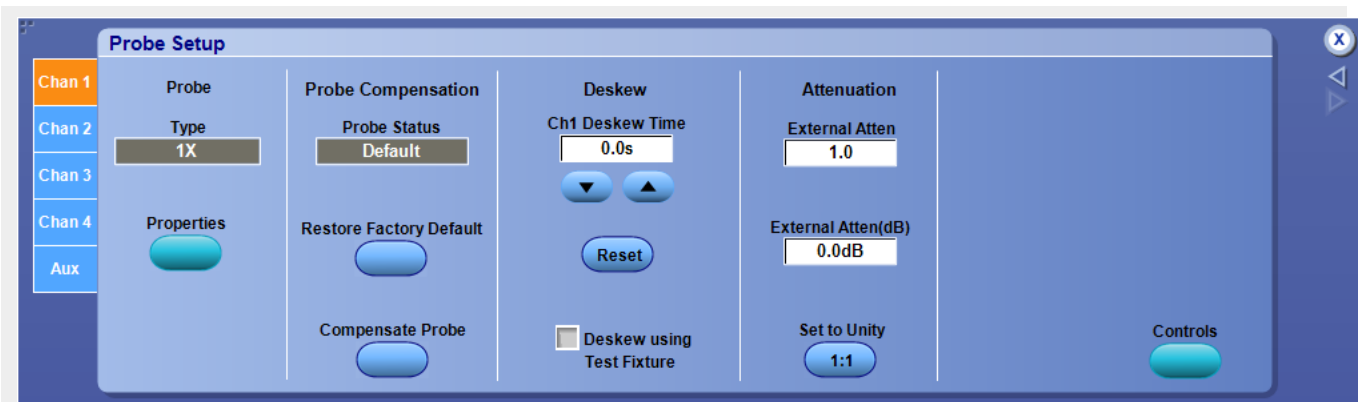
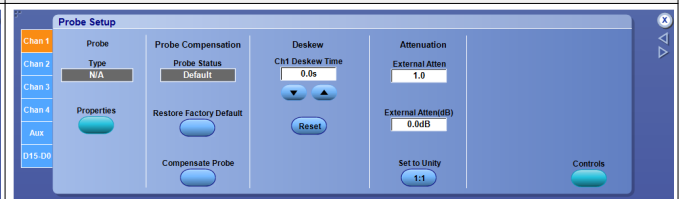

The following screen appears on MSO/DPO5000B Series instruments:

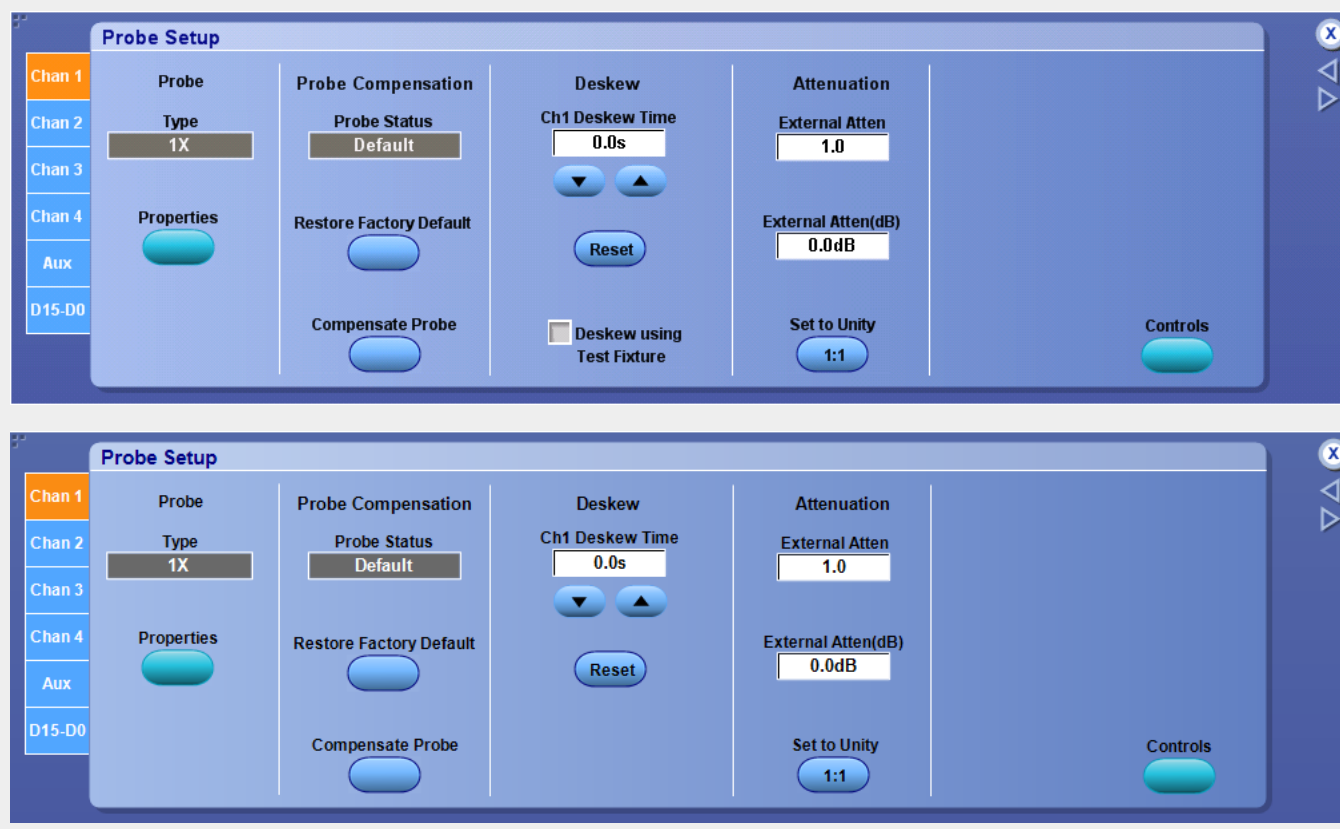

NOTE. To compensate for timing differences between voltage and current probes, order the following Probe Calibration and Deskew Fixtures: Tektronix part number 067-0405-XX (for DPO7000C and MSO/DPO5000B oscilloscopes). Tektronix part number 067-1586-XX (for MSO/DPO7000C/DX oscilloscopes). Tektronix part number 067-2083-XX (for MSO Series instruments) to deskew the logic probe trigger path.

The fixtures may require a user-supplied pulse generator.

To use

1. Connect the probes to a signal source.
2. Use the horizontal and vertical controls to center the fastest signal on the screen.
3. Click a Chan <1–4> tab to select the slower channel.
4. Click in the Deskew Time entry box, and use a multipurpose knob to adjust the deskew time so that the two signals align.
5. To clear the deskew value, click the Set To 0.0 s button.

Behavior

Each input channel has its own deskew settings. Deskew compensates individual channels for probes or cables of different lengths. The instrument applies the delay values after each completed acquisition. The deskew values, which have a range of ± 75 ns, do not affect triggering. Deskew is available for Sample and Average acquisition modes only.

The deskew values are saved as part of the instrument setup. The deskew values for the selected channel will be retained until you change the probe, you restore a saved setup, or you recall the factory setup.

What do you want to do next?

[Go to a step-by-step procedure to deskew the probes.](#)

[Learn more about the Vertical controls.](#)

Probe setup control window (Probe attenuation)

From the Vertical menu, select Attenuation.

Overview

Use the Probe Setup control window to describe the input/output ratio of any external attenuation or gain between the signal and input channels.

Click for DPO7000C and MSO/DPO5000B instruments:

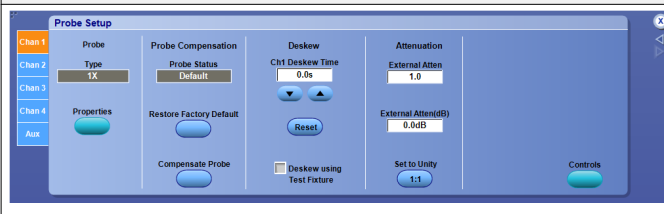

Click for MSO/DPO70000C/DX/SX instruments:

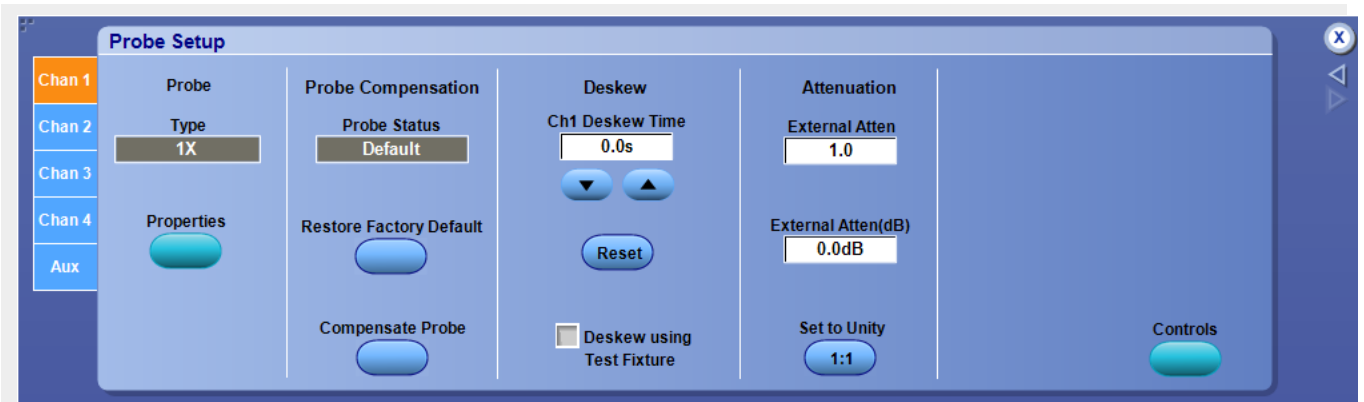
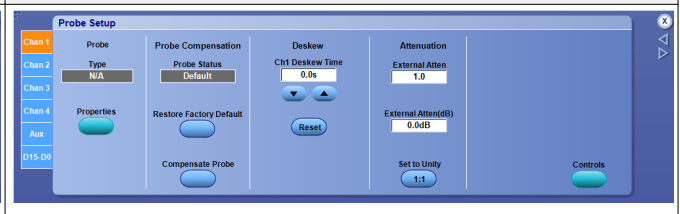

The following screen appears on MSO/DPO5000B Series instruments:

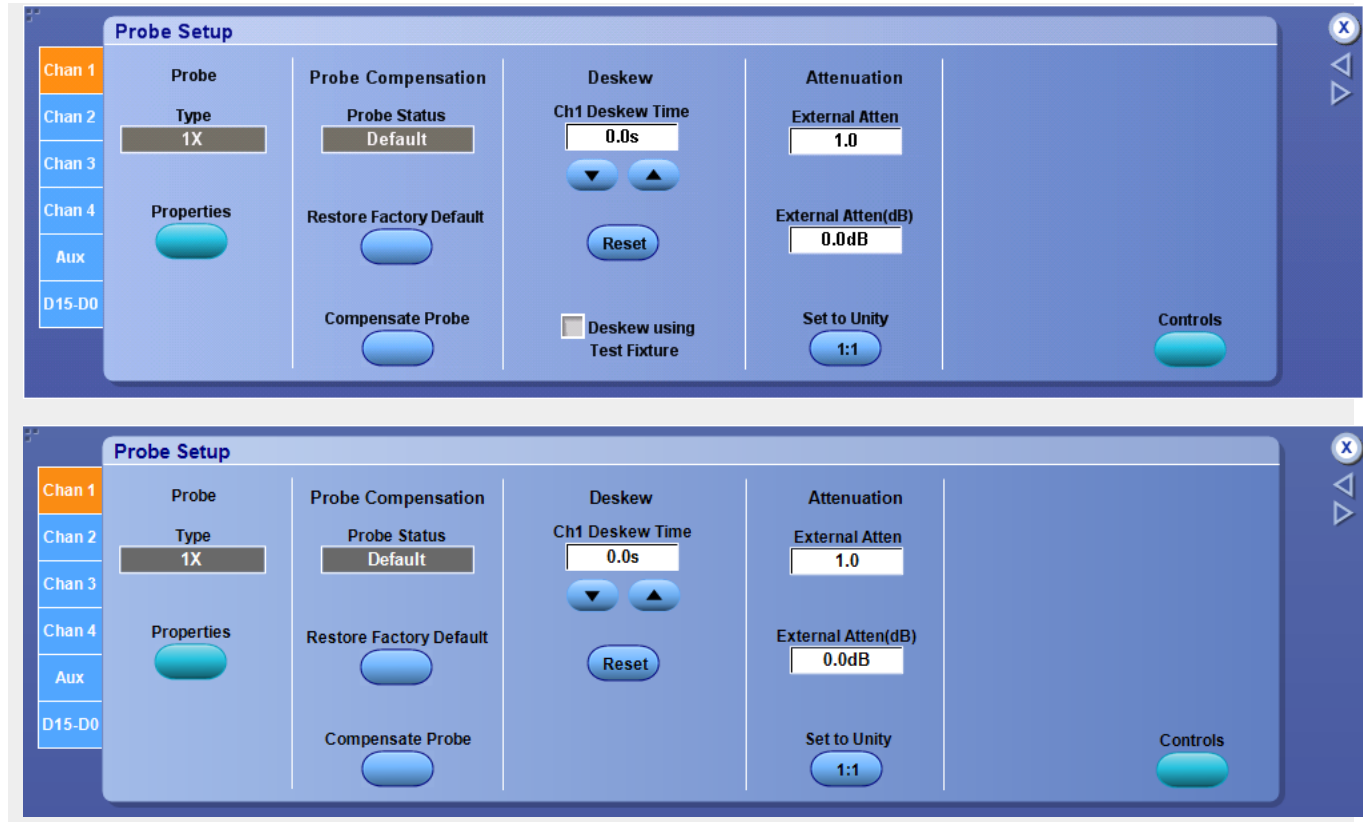

To use

1. Click a Chan <1–4> tab to select the vertical input channel for the attached probe.
2. To set the external attenuation as a multiplier or ratio, click in the External Atten entry box and use a multipurpose knob to enter a value.
3. To set the external attenuation as dB values, click in the External Atten (dB) entry box and use a multipurpose knob to enter a value.
4. To set the external attenuation to the default value, click Set to Unity.

Behavior

Each input channel has its own external attenuation settings. The attenuation control is automatically set to the correct value when you attach a probe with a TekProbe/TekVPI interface to the instrument. You can change the external attenuation by entering a multiplier or ratio in the top control, or by entering a dB value in the lower control.

When you return the attenuation to the default value, the multiplier returns to 1, and the dB value returns to zero.

What do you want to do next?

[Return to the Vertical Setup control window overview.](#)

TekProbe/TekVPI Interface

This interface enables the instrument to sense information about the probe such as the serial number and other unique identification information. It also allows the instrument to provide power directly to the probe.

With this information, the instrument can automatically set up its requirements to match the characteristics of the probe, such as termination and attenuation.

Probe controls window

From the Vertical menu, select Probe Controls.

Overview

Use the controls in these windows to operate a probe while taking measurements.

The type of probe you connect determines the available controls. For example, the window below contains controls for a Tektronix current probe.



The following window contains controls for Tektronix TAP1500/TAP2500 type probes.

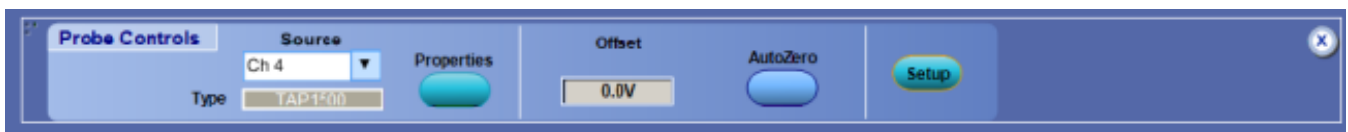

This window contains controls for Tektronix TriMode probes.

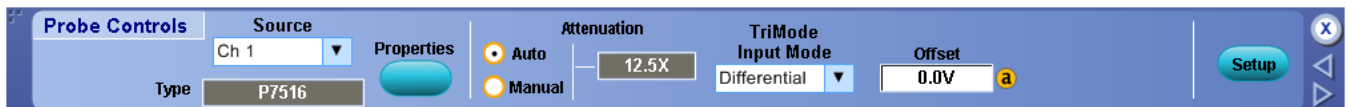

This window contains controls for Tektronix logic probes.



This window contains controls for Tektronix generic probes.

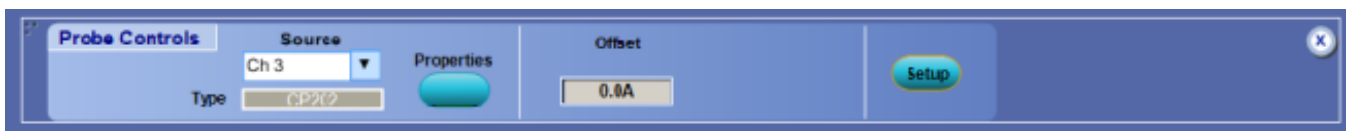

Probe properties

From the Vertical menu, select Probe Controls, click the Setup button, and then click the Properties button.

To use

The Probe Properties dialog displays information on the probe attached to the analog or to the digital channels. To view the probe information, select the channel of interest from the drop-down list of channels under Probe.

The dialog includes the following information for analog probes:

- Type of probe connected to the selected channel
- Serial number of the attached probe (for probes with serial numbers)
- Status information, such as the time you connected the probe, the probe type, the serial number, and compensation results
- Full text of probe error messages is displayed for compatible probes. Errors may include the following types:
 - Tip fault (Line open, Self-test failure of tip, and Tip broken)
 - Tip temperature change
 - Tip overheating
 - Tip thermal shutdown

NOTE. When the probe is compensated, the instrument polls the probe and displays the serial number. An N/A indicates that the probe has not been compensated.

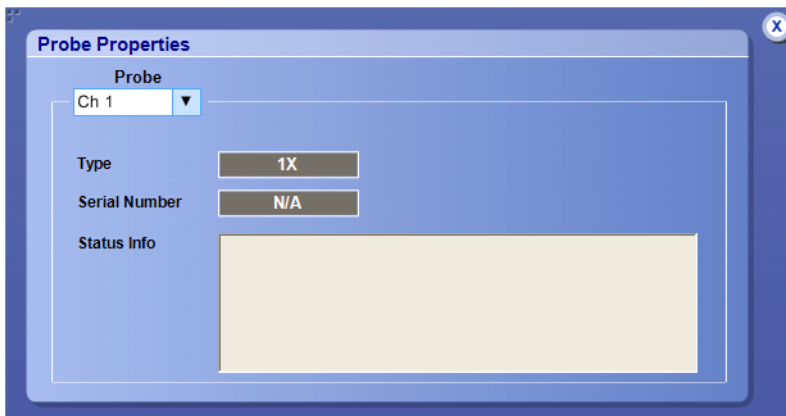

The Probe Properties dialog includes the following information for logic probes:

- Type of logic probe connected
- Serial number of the logic probe
- Analog channel selected as the Reference Channel
- Type of probe connected to the Reference Channel
- Status of the Analog to Digital Trigger Path Alignment routine

NOTE. The instrument requires the Logic Probe Deskew Fixture (Tektronix part number 067-2083-XX) to run the Analog to Digital Trigger Path Alignment routine.

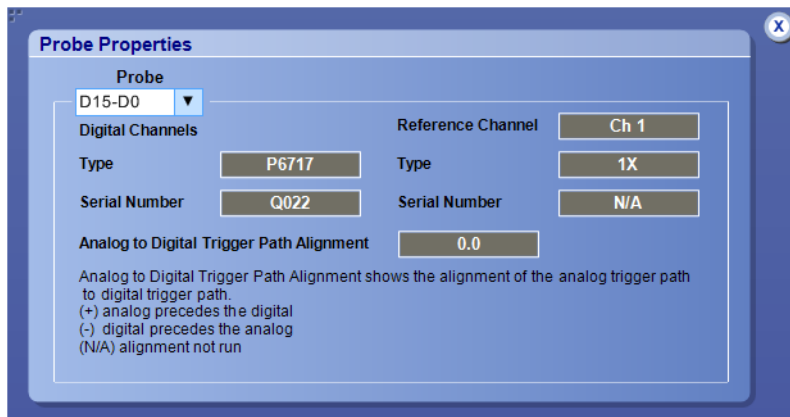

The instrument displays the following information in the Analog to Digital Trigger Path Alignment field:

- N/A means that the trigger path alignment routine has not been run
- Numeric value for the amount of time the instrument needs to skew the channel to align the logic trigger path to the reference channel
- (+) indicates that the analog trigger path occurs before the logic path
- (-) indicates that the logic trigger path occurs before the analog path

Probe setup control window (Probe status)

From the Vertical menu, select Probe Cal.

To use

The Probe Status readout provides information on the status of the probe connected to the vertical input channel.

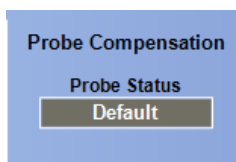

Behavior

The instrument automatically detects the type of probe that you have installed and displays the probe status information.

- **Default.** The instrument has no compensation data on file for this probe, on this channel, and is applying factory-nominal corrections for probe operation only. This message may appear if you connect a probe and have not performed the probe compensation. Perform a probe compensation before you using this probe. This message also appears when you disconnect a probe from the vertical input.
- **Compensated.** Compensation data for the probe connected to this channel is available from the most recent probe compensation or the compensation data has been retrieved from nonvolatile memory.

- **Fail.** The instrument was unable to complete the probe compensation procedure; the probe may be faulty. Have the probe checked by Tektronix service personnel.

NOTE. The instrument must pass a [Signal path compensation](#) on page 515 procedure before it will perform a probe compensation procedure.

What do you want to do next?

[Learn more about the Probe Compensation controls.](#)

[Go to a step-by-step procedure to compensate active probes.](#)

[Go to a step-by-step procedure to compensate passive probes.](#)

[Learn more about the Vertical controls.](#)

Signal path compensation

Perform the Signal Path Compensation (SPC) regularly to ensure that your measurements have the highest level of accuracy. Tektronix considers it a best practice to run SPC when using the instrument to measure signals with higher sensitivity (10 mV/div and lower) settings regardless of temperature shift or time since it was last run. Failure to perform SPC may result in the instrument not meeting warranted performance levels.

SPC corrects for DC inaccuracies caused by temperature variation or by long-term drift. SPC optimizes the acquisition system, corrects DC offset, and interleave calibration. SPC is adversely affected by input signals with AC components.

Use this procedure to optimize the acquisition system:

- If the temperature has changed more than 5 °C (9 °F) since the last signal path compensation (SPC)
- If using the instrument to measure signals with higher sensitivity (10 mV/div and lower) run SPC at least once a week
- If the front panel SPC status icon is not green
- If you replace or insert drive media
- If you change the configuration of your multi-instrument system, such as changing which instrument is the master or an extension.

1. Prerequisites:

- Instrument must be powered on until Utility > Instrument Calibration > Temperature Status is Ready.
- All channel input signals must be removed.
- If the timebase external reference mode is selected, leave the external reference signal connected and active.

2. Select Instrument Calibration.

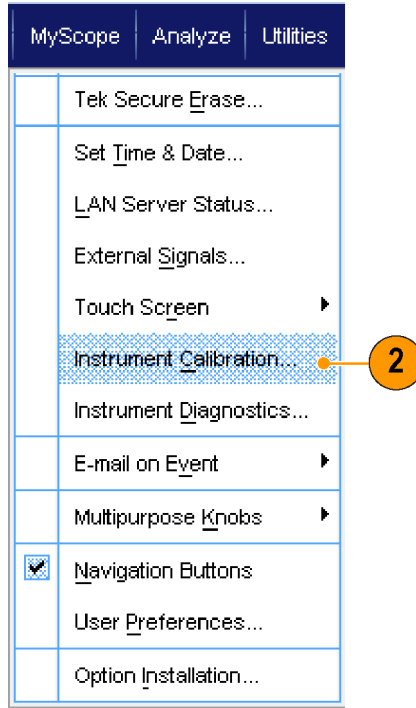

Utility menu on DPO70000SX

instruments

3. When the Temperature Status changes to Ready, click Run SPC to start the calibration. Calibration may take 10 to 15 minutes.

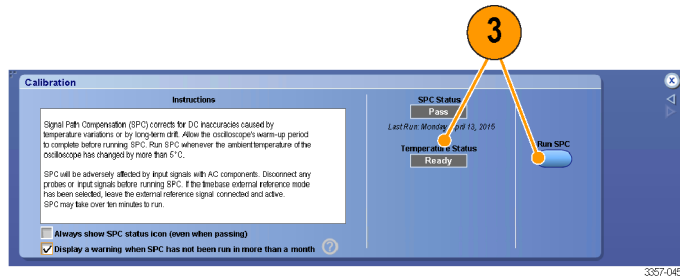

Calibration menu on DPO70000SX instruments

NOTE. Before running the SPC calibration, remove all channel input signals.

NOTE. If you use a drive that has not had SPC run while in the current instrument, you will see a no prior SPC warning message. If you see this warning, run SPC.

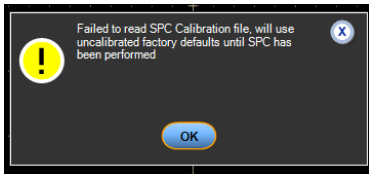

4. If the instrument does not pass, recalibrate the instrument, or have the instrument serviced by qualified service personnel.

NOTE. To always show the SPC status icon or display a warning when SPC has not been run in more than a month, click the corresponding check box.

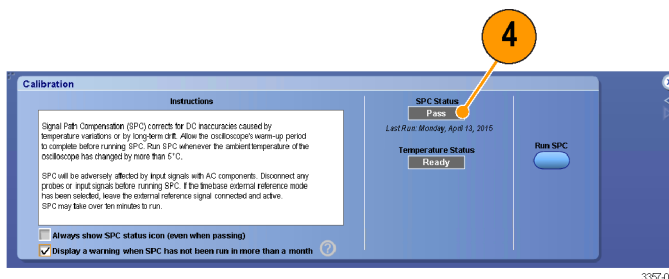

Calibration menu on DPO70000SX instruments

5. If the SPC needed icon is red, perform a signal path compensation.

Check the color of the SPC Status icon:

- Green indicates that SPC successfully passed and the temperature is stable.
- Yellow indicates that the instrument is in the warm up state or that it has been over 30 days since SPC was last run.
- Red indicates that SPC needs to be run (the temperature has varied more than 5 °C, SPC failed, or SPC has not been run).

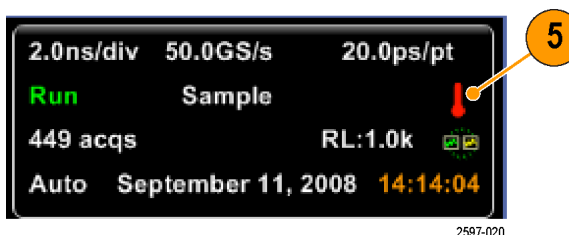

2597-020

Signal path compensation status

The following table lists the possible status messages for signal path compensation and the recommended action.

| Status | Meaning and recommended action |
|-------------|---|
| Compensated | The instrument had warmed up, there were no failures during the signal path compensation procedure, and the current operating temperature is within 5 °C of the operating temperature when the previous signal path compensation was run. |
| Fail | One or more failures occurred during the signal path compensation procedure. Contact your local Tektronix service representative for further action. |
| Temp | The operating temperature is not within 5 °C of the previous signal path compensation. |
| Warming up | The instrument has not warmed up. Wait for the instrument to complete its warm up period before running the signal path compensation procedure. |

Copying and printing

Copy setup

Copy setup (Images)

From the Edit menu, select Copy Setup; then open the Images tab.

Overview. Use this control window to copy images to the clipboard for use with other applications.

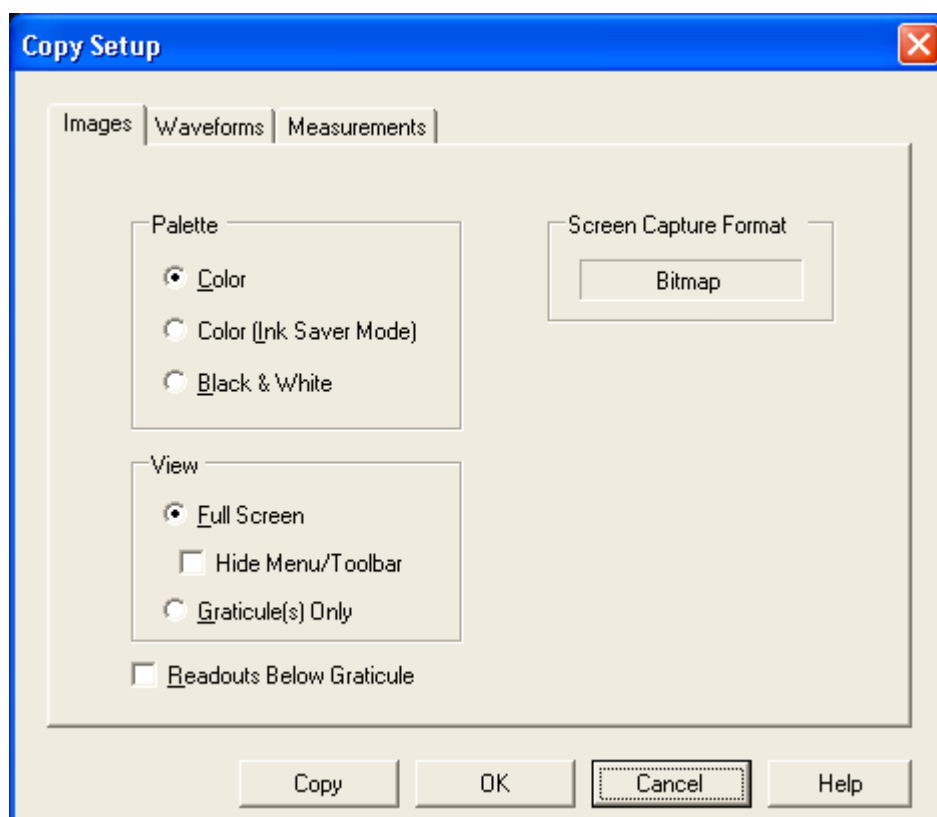

To use.

1. Select the Palette for the image:
 - Color
 - Color (Ink Saver Mode)
 - Black & White
2. Select the type of View:
 - Full Screen. Copies an image of the entire screen.
 - Graticule(s) Only. Copies an image of the selected graticule.
3. Click the Hide Menu/Toolbar check box to save the image without including the Menu bar or Toolbar.
4. Click OK.

Behavior. The Palette, View, and Image selections are identical to those in the Page Setup dialog box and in the Screen Capture Save Options dialog box.

The copy operation takes place after you click Copy. Clicking OK saves the changes and closes the dialog box but does not copy the image.

NOTE. *Bitmap (.bmp) is the only available Data Format.*

What do you want to do next?

[Learn about copying waveforms.](#)

[Learn about copying measurements.](#)

[Learn about saving images to a file.](#)

Copy setup (Waveforms)

From the Edit menu, select Copy Setup; then open the Waveforms tab.

Overview. Use this control window to copy waveforms to the clipboard for use with other applications.

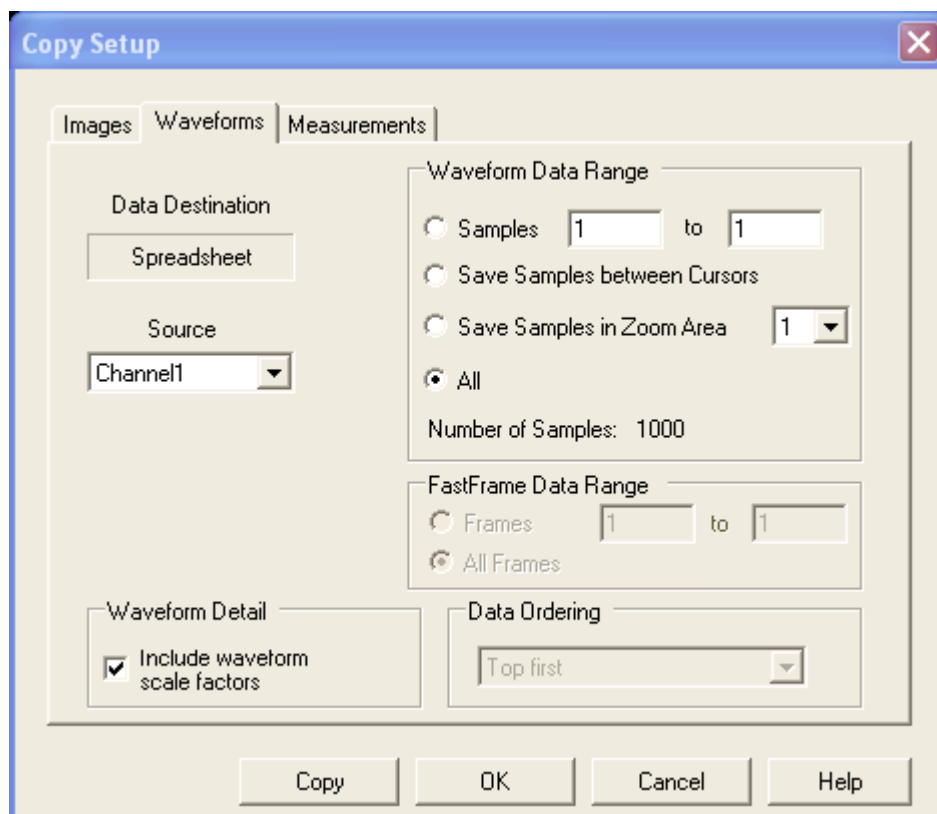

To use.

- The Data Destination (data format) is Spreadsheet only.
- Select a valid waveform from the Source list.
- Select the number of samples you want to copy. Select All samples, a range of samples, or only the samples between the cursors. If you select Save Samples between Cursors, you can use the multipurpose knobs to adjust the positions if the cursors are already active. If they are not, the cursors will be turned on at the positions they were in the last time they were used.
- Select the Include waveform scale factors check box if you want to include waveform details, such as header information (record length, sample interval, trigger point information, and so on). If you only want to include the waveform voltage values, clear the selection.
- Specify the FastFrame Data Range if you are copying FastFrame data.

If you are copying Fast Acquisition data, select the data ordering from the list.

Behavior.

- The Waveform curve data range can be anywhere from one sample to the record length of the selected waveform.
- The copy operation takes place after you click Copy.
- If you select Data between cursors, another set of cursors may temporarily appear on your screen while the copy is in progress.

What do you want to do next?

[Learn about copying images.](#)

[Learn about copying measurements.](#)

[Learn about saving waveforms to a file.](#)

Copy setup (Measurements)

From the Edit menu, select Copy Setup; then open the Measurements tab.

Overview. Use this control window to copy measurements to the clipboard for use with other applications.

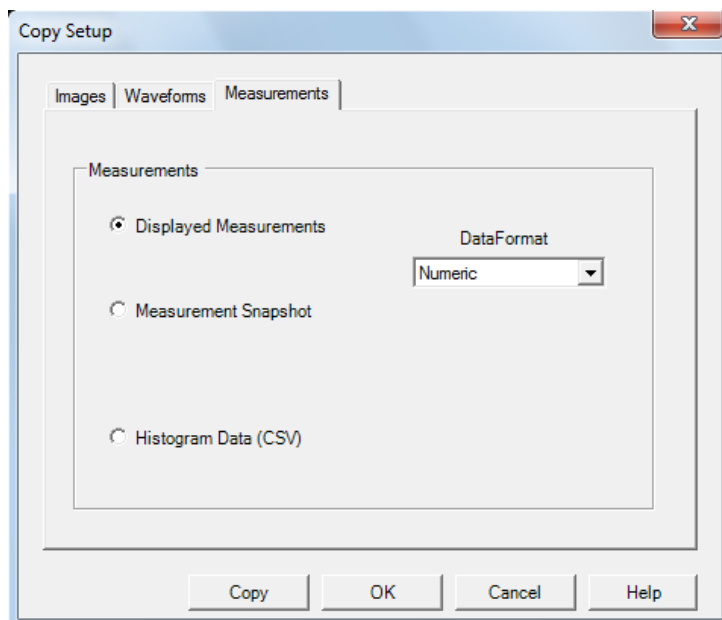

To use.

1. Click the type of Measurements you want to copy.
2. For Displayed Measurements, select the Data Format.
3. Click OK.

Behavior. When you select Displayed Measurements, all displayed measurements will be copied to the clipboard.

NOTE. For Histogram Data, the data format is always CSV.

The copy operation takes place after you click Copy. Clicking the OK button accepts the changes and closes the dialog box but does not copy the measurements.

What do you want to do next?

[Learn about copying images.](#)

[Learn about copying waveforms.](#)

[Learn about saving measurements to a file.](#)

[Learn more about CSV text format.](#)

Copying procedures

Copy waveform data

1. Identify the waveform, image, or measurement to be copied. The source must be a channel, an active math waveform, or an active reference.
2. From the Edit menu, highlight Select for Copy.
3. In the submenu, select the format for export:
 - Select Full Screen to export a bitmap of all screen contents.
 - Select Graticule to export a bitmap of only the graticule area.
 - Select Waveform to export waveform data.
 - Select Measurements to export measurement data.
4. From the Edit menu, select Copy Setup.
5. Open the Images tab.
6. Set the Image Options:
 - a. Select a color Palette for your copied images.
 - b. Select the image View: to copy an image of the entire screen, select Full-screen; to copy an image of the selected graticule, select Graticule(s) only.
 - c. The Screen Capture Format is BMP only.
7. Set the Waveform Options:
 - a. Open the Waveforms tab.
 - b. Select the data format (Data Destination) for the waveform you want to copy.
 - c. Select a valid waveform from the Source list.
 - d. Select the Include waveform scale factors check box if you want to include waveform details like header information (record length, sample interval, trigger point information, and so on). If you only want to include the waveform voltage values, clear the selection.

- e. Select the number of samples that you want to copy from the Waveform curve data range. Select all samples, a range of samples, or only the samples between the cursors. If you select Save Samples between Cursors, you can use the multipurpose knobs to adjust the positions if the cursors are already active. If they are not, the cursors are activated in their most recent positions.
 - f. If you are copying Fast Acquisitions data, select the data ordering from the list.
8. Set the Measurement Options:
- a. Open the Measurements tab.
 - b. Select either Displayed Measurements (make sure that measurements are displayed in the graticule via the Measurement Control window) or Histogram Data.
 - c. If you clicked the Displayed Measurements option, select the Data Format, either Numeric or Text.
9. Click Copy to save your setup information to the Windows clipboard.

Copying the screen for use in other applications

Use the following steps to copy the contents of the screen for use in other applications, such as WordPad, Microsoft Word, or Paint.

1. From the Edit menu, click Copy Setup.
2. Open the Images tab.
3. Select the Palette, View, and Image as needed for your application.
4. Click Copy to paste the image to the clipboard. You can now paste the bitmap image into other applications.
5. If you want to copy another image to the clipboard, click Copy on the Edit menu or press Ctrl+C on the attached keyboard.

NOTE. If you try saving a copy of the screen to the clipboard by pressing the *PrtScn* button on the attached keyboard, the bitmap image will not contain any waveforms. Use the procedure above to save a copy of the entire screen (or the graticule) to the clipboard.



TIP. If your setup information does not change, you do not need to open the Copy Setup dialog box each time you want to copy a screen. Use the Edit menu Select for Copy option if you need to change the type of items, for example, to copy waveforms instead of images.

Copying measurements for use in other applications

Use the following steps to copy the measurements for use in other applications such as WordPad or Microsoft Word.

1. From the Edit menu click Copy Setup.
2. Open the Measurements tab.
3. Select either Displayed Measurements (make sure that measurements are displayed in the graticule via the Measurement Control window) or Histogram Data.
4. If you clicked the Displayed Measurements option, select the Data Format, either Numeric or Text.
5. Click Copy to paste the measurements to the clipboard. You can now paste the measurements into your other applications.

Printing

Page setup dialog box

From the File menu, select Page Setup.

Overview. Use the Page Setup dialog box to define the page before sending it to a printer.

To use. The controls in this window are similar to the Page Setup dialog boxes used in most Windows applications (see example

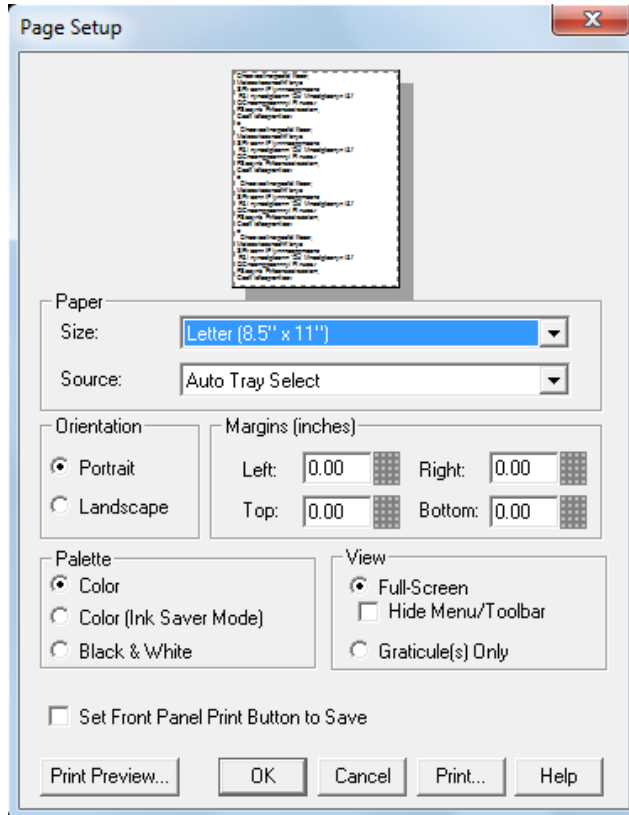

below).

The Paper settings are dependent on the type of printer connected to the instrument. A reduced preview image appears at the top of the window. To view a larger image, click Print Preview at the bottom of the window.

Click the Print button when you have selected all of your desired settings.

Behavior. The Type of printing should be Screen-copy for all screen shots.

Print preview dialog box

From the File menu, select Print Preview.

Overview. Use the Print Preview dialog box to preview an image before sending the data to a printer.

To use.

- Use the Magnify control at the top of the window to zoom in and out to view the details of the image.
- To return to the Page Setup dialog box, click the down arrow.
- Click the Printer button to open the Print dialog box.

Print dialog box

From the File menu, select Print.

Overview. Use the Print dialog box to send data to a printer.

To use. The controls in this window are similar to the Print dialog boxes used in most Windows applications. The settings are dependent on the type of printer connected to the instrument.





Printing the screen to a printer



The easiest way to print the contents of the screen is to press the front panel Print button. The instrument will print the screen contents according to the settings in the Page Setup dialog.

1. Use the File menu Page Setup dialog to select the Type of printing, Palette, View, and Image before printing. The Type should be Screen-copy, the default.
2. Use the Print Preview feature to test the appearance of the screen before printing. For example, you may want to experiment with the different palettes before sending the data to the printer.
3. Click Print in either the Print Preview dialog box or in the Page Setup dialog box to open the Print dialog box.
4. Click OK to begin printing.

General Purpose Controls

Use the following front-panel controls (DPO7AFP required on DPO70000SX instruments) to perform general-purpose tasks such as Autoselect the instrument, send items to the printer, or enable cursors.

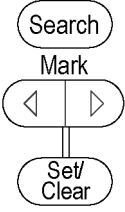
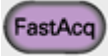
| Control | Description |
|---|---|
|  | Push the Autoset button to automatically set up the instrument to obtain and display a stable waveform of usable size. For information on the Autoset default settings click Autoset . |
|  | Push the Default Setup button to reset the instrument to the factory default settings. |
|  | Push the Print button to make a hard copy of the screen. The printed image is sent directly to the selected (internal or attached) printer. To change the print settings, click the File menu Print command, and change the settings in the Print dialog box. |
|  | <p>Push the Cursors button to enable cursors on the screen. The Cursor Type control window opens so that you can specify the cursor parameters.</p> <p>NOTE. If cursors are on but the readouts are not attached to the cursor controls, press the Cursors button to attach the readouts to the cursor controls. Press the Cursors button again to turn the cursors off.</p> |

| Control | Description |
|--|--|
|  The image shows a vertical stack of controls. At the top is an oval button labeled "Search". Below it is a button labeled "Mark" with a left-pointing arrow on the left and a right-pointing arrow on the right. Below the "Mark" button is another oval button labeled "Set/Clear". | Push the Search and Mark buttons to find and place a mark on a waveform at a point of interest, or to edit marks. You can return to a mark and analyze the waveform at a later time. |
|  The image shows a purple, rounded rectangular button with the text "FastAcq" in white. | Push the FastAcq DPX button to turn Fast Acquisition On or Off. The FastAcq button is lighted when Fast Acquisition is turned on. |
|  The image shows a circular knob with a radial pattern of eight segments, used for adjusting intensity. | Use the Intensity knob to adjust the brightness of the waveform. High intensity settings show less frequently acquired points more clearly. |

File menu

Reference waveform setups

Reference waveform controls

From the File menu, select Reference Waveform Controls.

Overview. Use the Reference control window to display and control reference waveforms. Reference waveforms are shown with the horizontal settings in effect at the time they are saved.

NOTE. Reference waveforms are only available for analog channels.

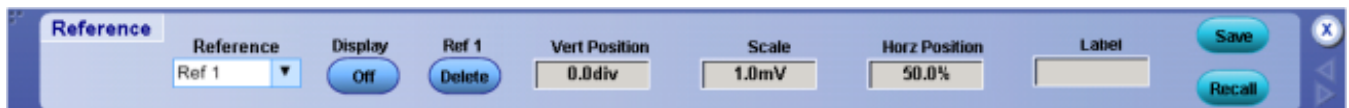

To use.

1. Select the Ref <1–4> waveform from the drop-down list.
2. Click the On button to display the waveform.
3. Click in the Vert Position or Scale entry boxes, and then use the multipurpose knobs to make adjustments.
4. Click in the Label entry box, and then use the pop-up keypad to create a label for the waveform.
5. Click the Save button to access the Save As dialog box and save the waveform as a Reference waveform or save it to a file.
6. Click the Recall button to access the Recall dialog box and recall a waveform from memory.

Behavior. Clicking Save or Recall buttons activates the respective dialog boxes. Typing a name in the Label text box places the label on the graticule. You can move the label on the graticule by clicking and dragging it. The label is saved with the Reference waveform.



TIP. To easily change the vertical position of a reference waveform, click the waveform handle on the left side of the screen, and drag the waveform to the new position. To easily change the vertical scale of a reference waveform, click the waveform handle, and then use the multipurpose knobs to change the waveform scale. You can also use the multipurpose knobs to change the waveform position.

What do you want to do next?

[Learn how to create a reference waveform.](#)

[Learn about instrument setups.](#)

[Learn about saving reference waveforms to a file.](#)

[Learn about restoring waveforms from a file.](#)

[Learn about deleting waveform files.](#)

Save as dialog box (Waveform)

From the File menu, highlight Save As; then select Waveform from the submenu. From the [Reference Waveform controls](#), click the Save button.

Overview. Use this dialog box to save a waveform to a reference location or to a specified folder.



To use.

- To save to a reference location, select the Source, and then click the reference location in Oscilloscope Memory.
- To save to a file, enter a Name, use the default file name, or click [Auto-increment file name](#) if you want to save a series of files without typing in a new name each time. The file extension specified in the Save as type list will automatically be appended to the file name.

Behavior. This dialog box opens when you select Save As from the File menu or click Save from the Reference Waveform controls. The default file type is a Tektronix waveform file (.wfm).

If you select a different file type from the Save as Type list, you can also define the *options* for saving the waveform.

The default folder for reference waveforms is C:\Users\[Username]\Tektronix\TekScope\waveforms.

The following file formats are available:

- **.wfm** used for internal instrument formats
- **.csv** used for spreadsheets, such as Microsoft Excel
- **.txt** used for standard text file format
- **.dat** used for Mathcad and MATLAB

NOTE. Any characters that you enter in the file name box become part of the file name. The instrument does not use any user-defined file extensions.

What do you want to do next?

[Learn about recalling a saved waveform.](#)

[Learn about deleting waveform files.](#)

[Learn more about CSV text format.](#)

Recall dialog box (Waveform)

From the File menu, select Recall, or from the *Reference Waveform controls*, click the Recall button.

Overview. Use this dialog box to recall a saved waveform file to a reference location.

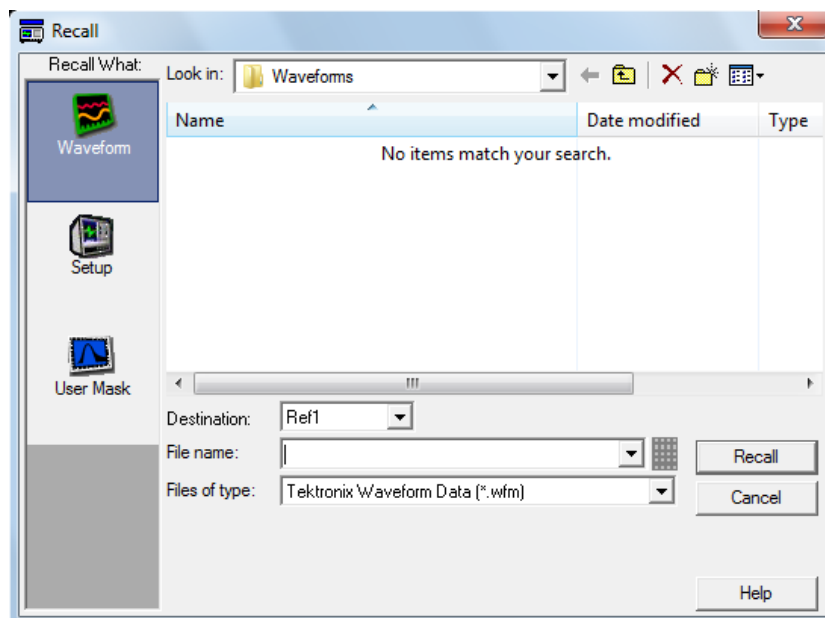

To use.

- Under Recall What, click Waveform.
- From the Destination drop-down list, select the Ref <1– 4> location that you want to recall the waveform to. The default folder for reference waveforms is C:\Users\[Username]\Tektronix\TekScope\waveforms.
- Use the pop-up keyboard to enter a File name, or click the file name to select it.



TIP. If you do not see the file that you want to recall, verify that the Files of type list shows the correct file format. You may also need to check other folders if the file was stored in a location other than the C:\Users\[Username]\Tektronix\TekScope\Waveforms folder.

Behavior. This dialog box opens when you click Recall from the File menu or when you click the Recall button from the Reference waveform controls. Waveforms are stored in WFM file format, which is an internal format of the instrument. When you click Recall, the Ref 1-4 waveform is displayed in the graticule.

NOTE. When you recall a reference waveform, a temporary file containing the waveform data is written to C:\Users\[Username]\Tektronix\TekScope\Waveforms. The file is named TDS_REF n.WFM, where n is the reference waveform number. This file is deleted when the reference waveform is deleted.

What do you want to do next?

[Learn about saving a waveform to a file.](#)

[Learn about deleting waveform files.](#)

Delete setups and reference waveforms

From the File menu highlight Delete; then select an entry in the submenu.

Overview. Use this dialog box to delete a saved reference waveform or setup file.

To use.

- Select the setup or reference waveform you want to delete.
- To delete all Setups at the same time, select All Setups
- To delete All Reference Waveforms at one time, select All Refs.

Behavior. Setups or waveforms stored in Windows directories can be deleted by clicking the  in the Save or Recall dialog boxes.

NOTE. You can only delete setups and reference waveforms stored in oscilloscope memory using this command.

What do you want to do next?

[Learn about saving instrument setups.](#)

[Learn about restoring instrument setups.](#)

[Learn about saving a waveform to a file.](#)

Instrument setups

Save as dialog box (Instrument setup)

From the File menu, highlight Save As; then select Setup from the submenu.

Overview. Use the Save As dialog box to save instrument setups for later use.

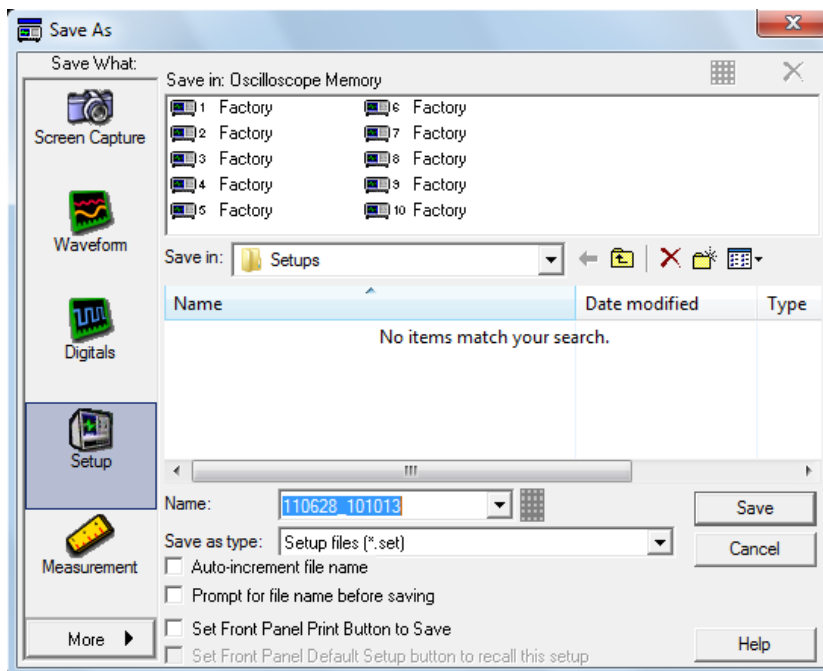

To use. To save in Oscilloscope memory:

1. Click on one of the setup location icons under Save in: Oscilloscope Memory.
2. Enter a Name for the setup by clicking on it once more and modifying the existing text.
3. Click the Save button.

To save the setup in a different location:

1. Select the location from the Save in drop-down list.
2. Enter a name in the Name text box.
3. Click the Save button.

Behavior. You can display up to ten saved instrument setups in this dialog box. Additional setups can be saved to the hard drive. When you save a setup, the label adjacent to the setup icon changes from its previous value to User. You can save setups to any location labeled Factory without overwriting a saved setup.

The data in reference waveforms is not saved with the instrument setup. However, the setup information does include which reference waveforms are turned on and which reference waveforms are used with math waveforms and automatic measurements. If you want to [save the reference waveform data](#), save the reference waveform separate from the instrument setup.

The instrument preference settings are not saved with the setup. They are saved when the instrument is powered off.

NOTE. Before saving an instrument setup, make sure the location does not contain a setup that you have previously saved. The previously saved setup will be overwritten.

What do you want to do next?

[Learn about recalling instrument setups.](#)

[Learn about deleting instrument setups.](#)

Recall dialog box (Instrument setups)

From File menu, select Recall, or from the [Reference Waveform controls](#), click the Recall button.

Overview. Use the Recall dialog box to recall an instrument setup.

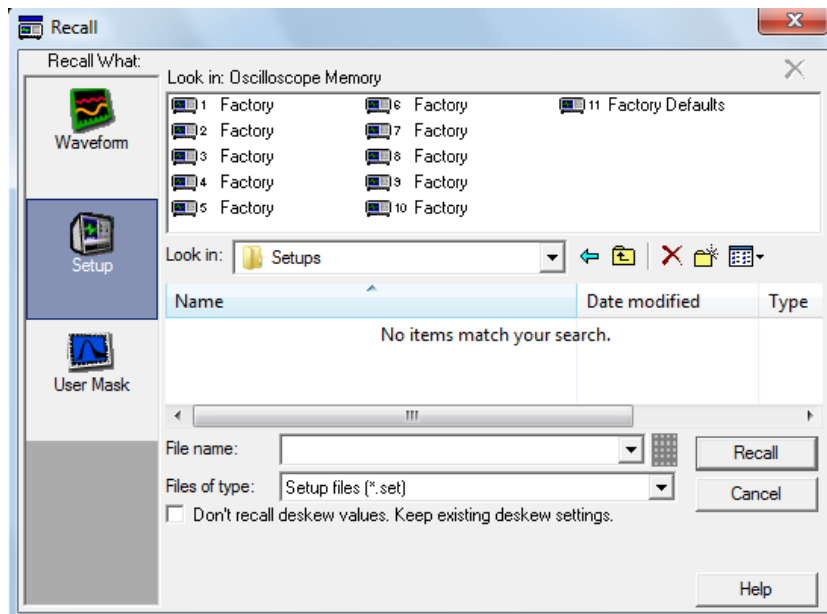

To use. Setups are recalled from an internal file on your hard drive or from a setup file that you have named.

- Under Recall What, click Setup.
- Click one of the icons under Look in: Oscilloscope Memory, and then click the Recall button to restore the setup.
- Click the Factory Defaults icon to recall the default factory setup for the instrument.



TIP. Select the File menu Recall Default Setup command to instantly restore the default setup.

To recall an instrument setup from a file, select the location of the setup from the Look in list. Select the setup you want to recall, and then click Recall.

Behavior. The setups are restored from an internal file on your hard drive as soon as you click the Recall button. The labels adjacent to the icons were created when the setups were first saved. Any of the setups with the label "Factory" will restore the default factory setups.

The data in reference waveforms is not saved with the instrument setup. However, the setup information does include which reference waveforms are turned on and which reference waveforms are used with math waveforms and automatic measurements. If you want to [save the reference waveform data](#), save the reference waveform separate from the instrument setup. You can then recall the saved waveform to the setup from the [Reference Waveform Controls](#).

NOTE. If a restored setup attempts to use an undefined reference waveform (or to use it in a math waveform or with an automatic measurement), then an undefined reference waveform is created. This reference waveform becomes a 500-point waveform filled with null data. Any math waveforms or any measurements done on this waveform will contain invalid or unusable data. However, you can recall a valid saved waveform to the new reference waveform so that the math waveforms and the automatic measurements will become valid.

What do you want to do next?

[Learn about saving instrument setups.](#)

[Learn about deleting instrument setups.](#)

Delete setups and reference waveforms

From the File menu highlight Delete; then select an entry in the submenu.

Overview. Use this dialog box to delete a saved reference waveform or setup file.

To use.

- Select the setup or reference waveform you want to delete.
- To delete all Setups at the same time, select All Setups
- To delete All Reference Waveforms at one time, select All Refs.

Behavior. Setups or waveforms stored in Windows directories can be deleted by clicking the  in the Save or Recall dialog boxes.

NOTE. You can only delete setups and reference waveforms stored in oscilloscope memory using this command.

What do you want to do next?

[Learn about saving instrument setups.](#)

[Learn about restoring instrument setups.](#)

[Learn about saving a waveform to a file.](#)

Action on event

Set up action on event

From the File menu, select Action On Event.

Overview. Use this control window to set up the action (save or e-mail) to perform when an event (trigger, limit test failure, or mask test failure) occurs.

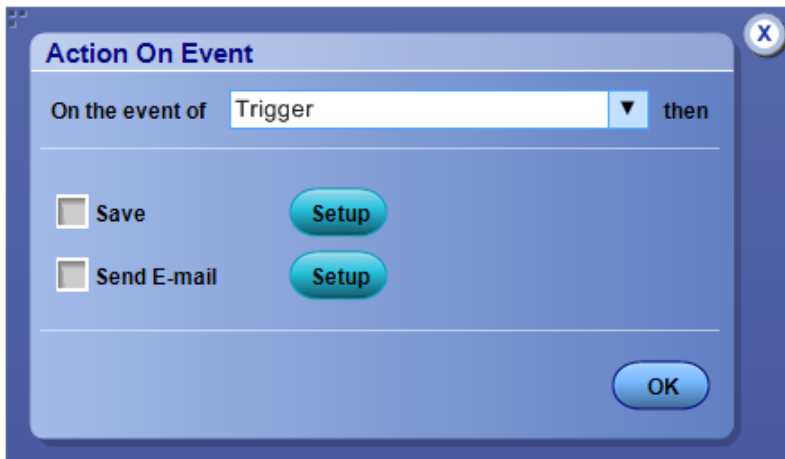

To use.

1. From the On the event of drop down list, select the event that will cause the action.
2. Click the Save check box to save a file when the event occurs.
3. Click the Send E-mail check box to send an e-mail when the event occurs.
4. To change the setup of either action, click its Setup button.

What do you want to do next?

[Learn about Email on Event setup](#)

[Learn about Save On Event Setup](#)

Set up save on event

From the File menu select Action On Event, and then click Save Setup.

Overview. Use this control window to set up the conditions under which the instrument will save a file, the types of files to save, and the event limits.

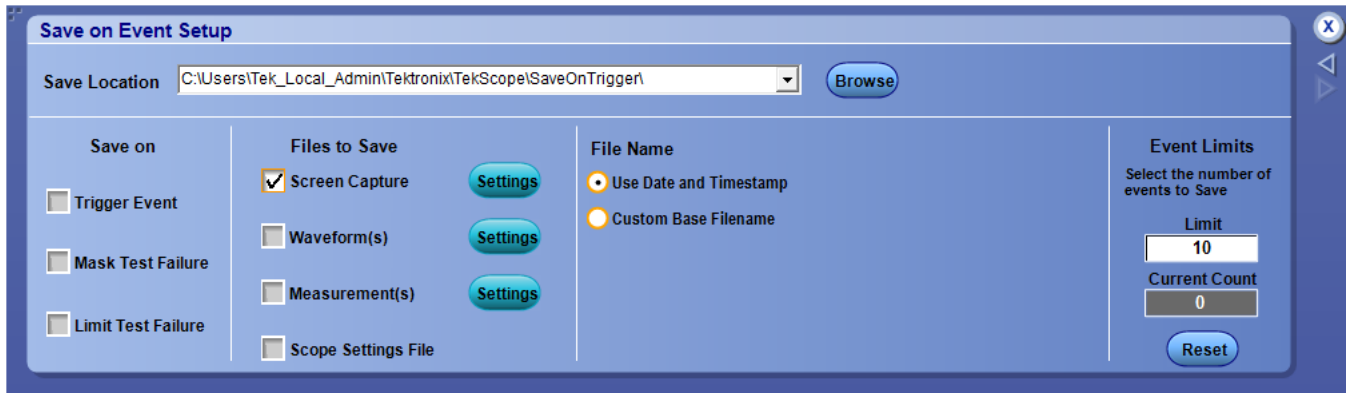

To use.

1. In the Save Location entry box, type in the location where you want to save the files.
2. In the Save on check boxes, select the events on which you want to save a file.
3. Use the Files to Save check boxes to select the type of files to save.
4. Click the Settings buttons to open a Save Options dialog box and set the parameters for the file.
5. In the File Name radio buttons, select whether to a Use Date and Timestamp or Custom Base Filename.
6. In the Event Limits box, enter the number of events that will save files, up to a maximum of 32,767.
7. Press the Reset button to reset the Current Count of files saved.

Behavior. When the maximum number of files is saved, file saving stops. To continue saving files, you must press Reset or enter a larger limit. Clicking Reset changes the current count back to 0.

What do you want to do next?

[Learn about Mask Testing.](#)

[Learn about Limit Testing.](#)

[Learn about Screen Capture Save Options](#)

[Learn about Waveform Save Options](#)

[Learn about Measurement Save Options](#)

Print setups

Print setups

For information on the Print Setups, click [here](#).

Saving

Save as dialog box (Histogram)

From the File menu, highlight Save As; then select Histogram Data from the submenu.

Overview. Use this dialog box to save histograms to a file for use with other applications.

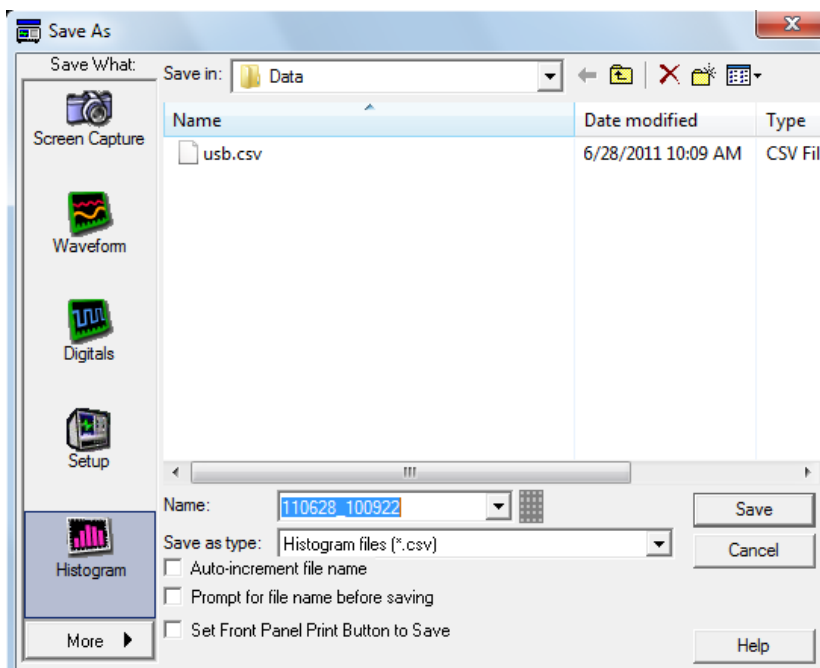

To use.

- To save histogram data with the default file name, click the Save button.
- To enter a different file name, click the keyboard icon and use the pop-up keyboard.
- Select [Auto-increment file name](#) if you want to save a series of files without typing in a new name each time.
- Select a file extension from the Save as type drop-down list. The file type will be automatically appended to the file name.

Behavior. Histogram data is saved in `c:\Users\[Username]\Tektronix\TekScope\data` unless you select a different location. To access the Histogram Save As dialog box, you may need to select it from the More submenu.

What do you want to do next?

[Learn about saving waveforms.](#)

[Learn about saving screen captures.](#)

[Learn about saving measurements.](#)

Save as dialog box (Instrument setup)

From the File menu, highlight Save As; then select Setup from the submenu.

Overview. Use the Save As dialog box to save instrument setups for later use.

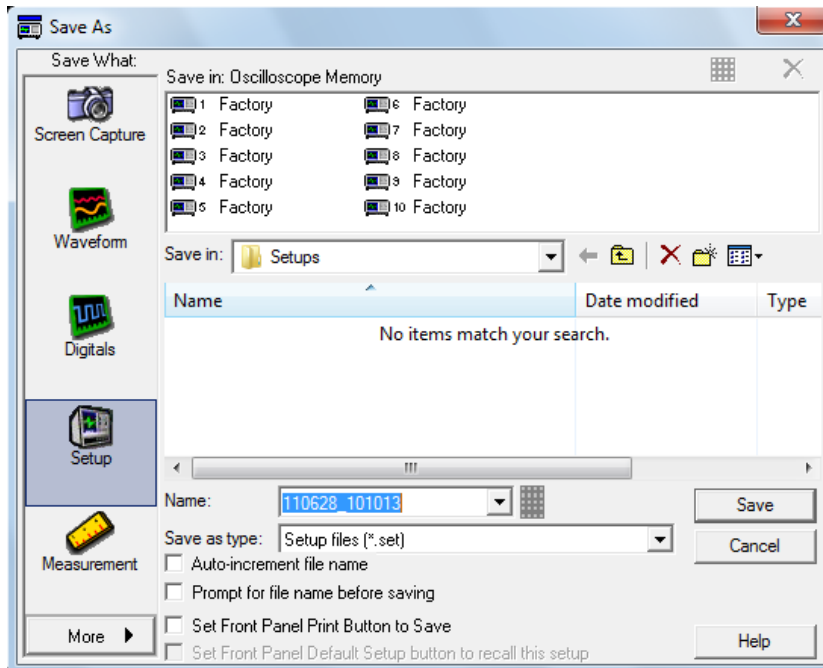

To use. To save in Oscilloscope memory:

1. Click on one of the setup location icons under Save in: Oscilloscope Memory.
2. Enter a Name for the setup by clicking on it once more and modifying the existing text.
3. Click the Save button.

To save the setup in a different location:

1. Select the location from the Save in drop-down list.
2. Enter a name in the Name text box.
3. Click the Save button.

Behavior. You can display up to ten saved instrument setups in this dialog box. Additional setups can be saved to the hard drive. When you save a setup, the label adjacent to the setup icon changes from its previous value to User. You can save setups to any location labeled Factory without overwriting a saved setup.

The data in reference waveforms is not saved with the instrument setup. However, the setup information does include which reference waveforms are turned on and which reference waveforms are used with math waveforms and automatic measurements. If you want to [save the reference waveform data](#), save the reference waveform separate from the instrument setup.

The instrument preference settings are not saved with the setup. They are saved when the instrument is powered off.

NOTE. Before saving an instrument setup, make sure the location does not contain a setup that you have previously saved. The previously saved setup will be overwritten.

What do you want to do next?

[Learn about recalling instrument setups.](#)

[Learn about deleting instrument setups.](#)

Save as dialog box (Measurement)

From the File menu, highlight Save As; then select Measurement from the submenu.

Overview. Use this dialog box to save a measurement to a file for use with other applications.



To use.

1. Under Save What, click Measurement.
2. Set the parameters for the measurement you want to save.
3. Click the Measurement Options button
4. In the Measurement Save Options dialog box, select a Measurement Format from the drop-down list box.

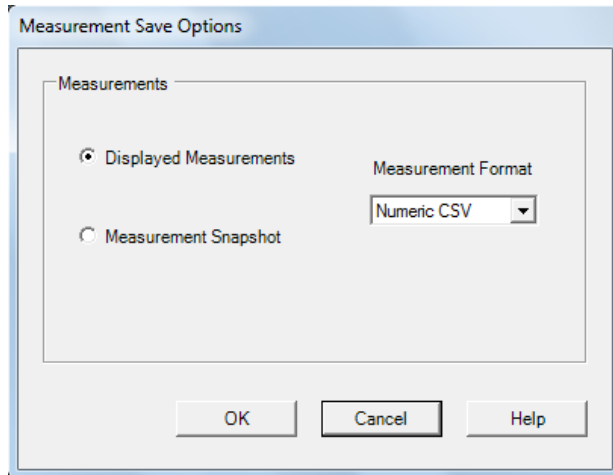

5. After making the above selection, click OK to return to the Save As dialog box.
6. Use the default name or enter a unique in the Name text box.
7. Select the type of file (either .txt or .csv) to save from the Save as type list. By default, the file will be saved to the C : \Users\[Username]\Tektronix\TekScope\Data folder.
8. Click the Save button to accept any changes and close the dialog box.

Behavior. When you select Displayed Measurements, all displayed measurements are saved.

What do you want to do next?

[Learn about saving waveforms.](#)

[Learn about saving screen captures.](#)

[Learn more about CSV text format.](#)

Save as dialog box (Screen capture)

From the File menu, highlight Save As; then select Screen Capture from the submenu.

Overview. Use this dialog box to save screen captures to a file for use with other applications.



To use.

1. Under Save What click Screen Capture; then click Options.

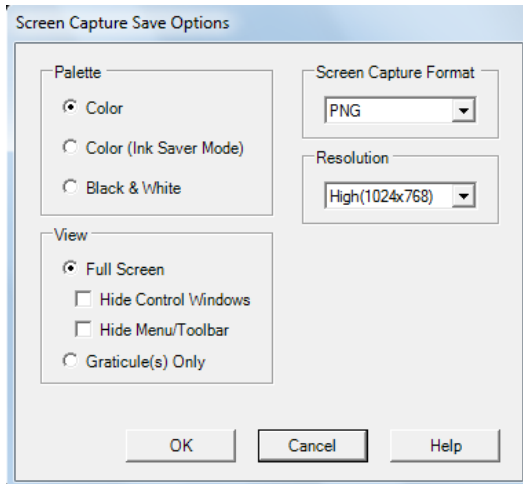

2. Select the Palette for the image: Color or Black & White.
3. Under View, select the image style:
 - To save an image of the entire screen, select Full Screen. Optionally, select to Hide Control Window and Hide Menu/Toolbar.
 - To select an image of the selected graticule, select Graticule(s) only.
4. Select a resolution from the Resolution drop-down list.
5. Select a file type from the Screen Capture Format drop-down list.
6. Click OK.
7. In the Save As dialog box, assign your own file name, and then save the file to a specified folder. By default, the image will be saved to C:\Users\[Username]\Tektronix\TekScope\ScreenCaptures.
8. Click Save to save the screen capture or cancel to close the dialog box without saving.

Behavior. The Palette, View, and Image selections are identical to those in the Page Setup dialog box.

The following file types are available:

- .bmp
- .jpg
- .png
- .tif

What do you want to do next?

[Learn about saving a waveform.](#)

Save as dialog box (User mask)

From the File menu, highlight Save As; then select User Mask from the submenu.

Overview. Use this dialog box to save user masks. Masks are saved in `C:\Users\[Username]\Tektronix\TekScope\Masks` unless you choose another folder.

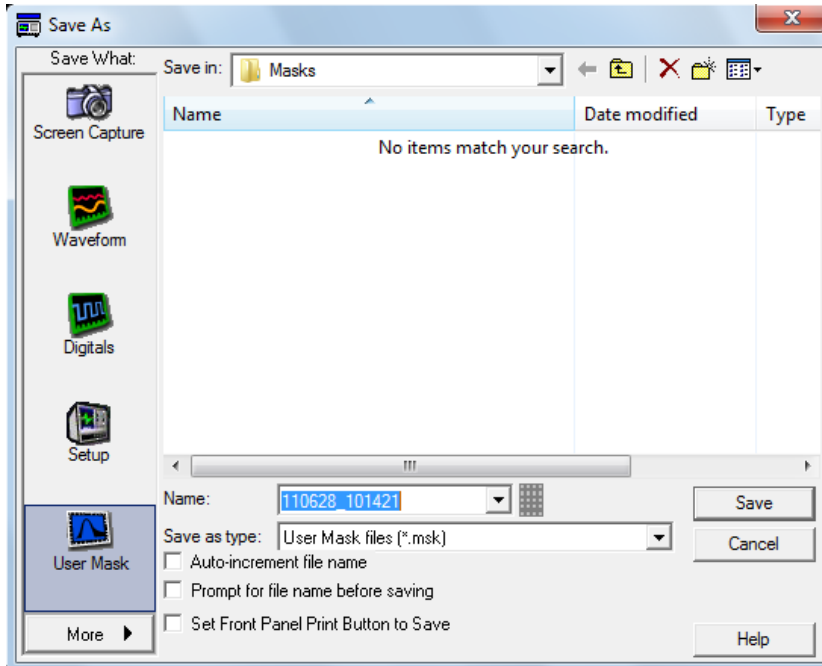

To use.

- To save the mask with the default file name, click the Save button.
- To enter a different file name, click the keyboard icon and use the pop-up keyboard to enter a unique file name. The extension specified in the Save as type list will automatically be appended to the file name.

Behavior. The Save As dialog box displays when you click Save in the Edit Mask control window. The mask is saved in the format specified in the Save as type list.

What do you want to do next?

[Learn about recalling saved masks.](#)

[Learn more about mask types.](#)

[Learn more about mask setups.](#)

Save as dialog box (Waveform)

From the File menu, highlight Save As; then select Waveform from the submenu. From the [Reference Waveform controls](#), click the Save button.

Overview. Use this dialog box to save a waveform to a reference location or to a specified folder.

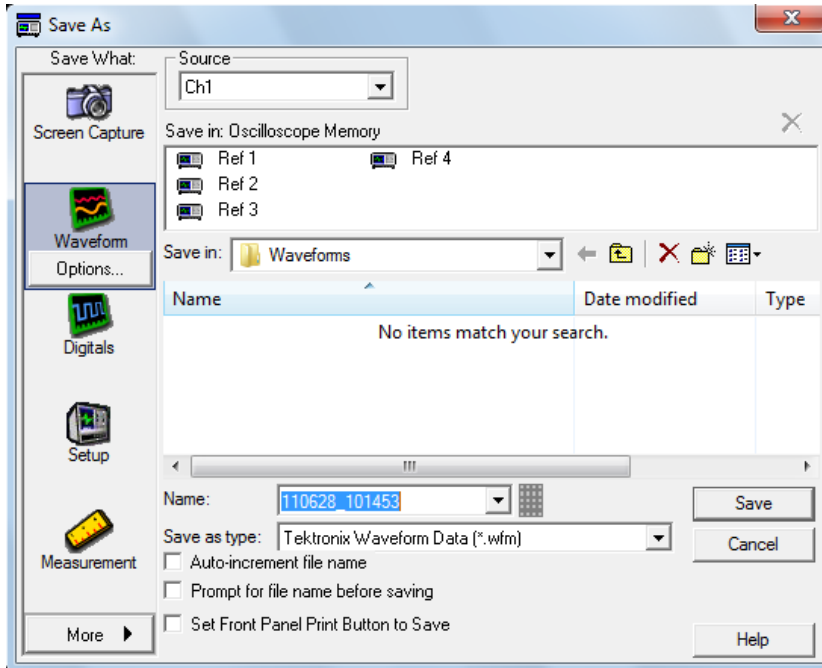

To use.

- To save to a reference location, select the Source, and then click the reference location in Oscilloscope Memory.
- To save to a file, enter a Name, use the default file name, or click [Auto-increment file name](#) if you want to save a series of files without typing in a new name each time. The file extension specified in the Save as type list will automatically be appended to the file name.

Behavior. This dialog box opens when you select Save As from the File menu or click Save from the Reference Waveform controls. The default file type is a Tektronix waveform file (.wfm).

If you select a different file type from the Save as Type list, you can also define the *options* for saving the waveform.

The default folder for reference waveforms is C:\Users\[Username]\Tektronix\TekScope\waveforms.

The following file formats are available:

- **.wfm** used for internal instrument formats
- **.csv** used for spreadsheets, such as Microsoft Excel
- **.txt** used for standard text file format
- **.dat** used for Mathcad and MATLAB

NOTE. Any characters that you enter in the file name box become part of the file name. The instrument does not use any user-defined file extensions.

What do you want to do next?

[Learn about recalling a saved waveform.](#)

[Learn about deleting waveform files.](#)

[Learn more about CSV text format.](#)

Auto-increment the file name

1. Select the Auto-increment file name to save numerous similar files without retyping the entire file name each time.
2. Enter a Base file name.
3. Click Save.

For the initial save the default count is 000, but you can overwrite this number if you choose. Your first file is saved as **[Base filename][count].ext**, where **ext** is the file extension. On subsequent saves, the instrument searches for the highest numbered file name and increases the number by one, as in **Base filename001.ext**.

For example, if you are saving a series of rise time data files, you can use "Risetime" as the base file name. Your first file is saved as **Risetime000.ext**, where **ext** is the file type extension. The next file will be **Risetime001.ext**, and so on.



TIP. If Count reaches 999, it is suggested that you change the base file name to Base filename1 (for example, Risetime1) on the next save. Your next file will then be saved as **Risetime1000.ext**. You will receive a warning message if you are going to overwrite any files with the same name.

Save as dialog box (Digitals)

From the File menu, highlight Save As; then select Digitals from the submenu (Digitals is only available on MSO instruments).

Overview. Use this dialog box to save the values of logic waveforms to a .csv file.



To use.

1. Under Save What, click Digitals.
2. Name the file and set the Save as type parameters for the digital data you want to save.
3. Click the Save button to accept any changes and close the dialog box.

Behavior. Digital data is saved in C:\Users\[Username]\Tektronix\TekScope\data unless you select a different location.

Save as dialog box (Timestamp)

From the File menu, highlight Save As; then select Timestamp Table from the submenu.

Overview. Use this dialog box to save a time stamp to a file.

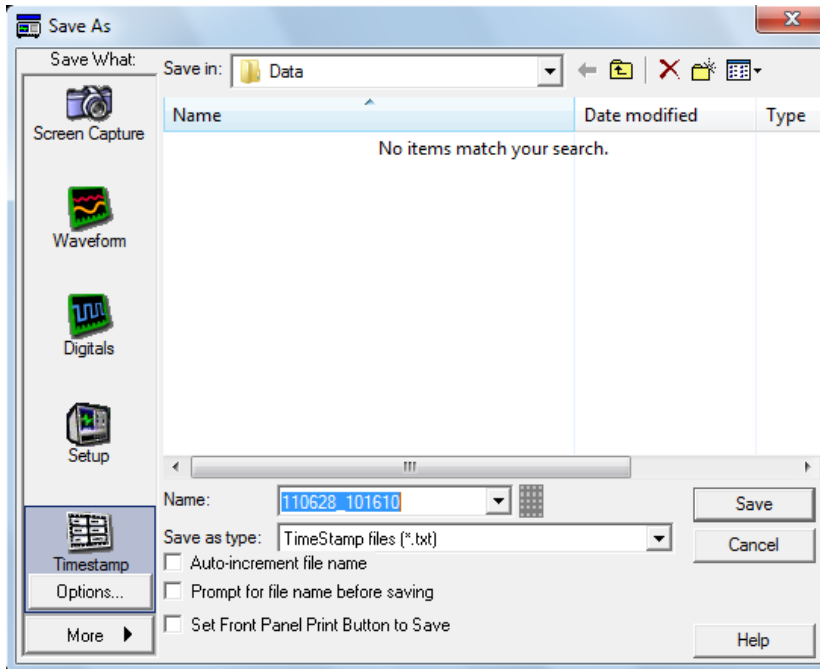

To use.

1. Under Save What, click Timestamp.
2. Click the Timestamp Options button to set the Source and FastFrame Data Range for the time stamp.
3. Name the file and set the Save as type parameters for the timestamp you want to save.
4. Click the Save button to accept any changes and close the dialog box.

Behavior. Timestamp data is saved in C:\Users\[Username]\Tektronix\TekScope\data unless you select a different location.



TIP. You can conveniently save time stamps from the FastFrame Control Window by using the Acquisition > FastFrame > Analyze tab > Save button.

What do you want to do next?

[Learn about saving waveforms.](#)

[Learn about saving screen captures.](#)

[Learn about saving measurements.](#)

Utilities

Tek secure erase

From the Utilities menu, select Tek Secure Erase.

Overview

Use TekSecure to erase, for the current user, all waveforms and instrument setups.

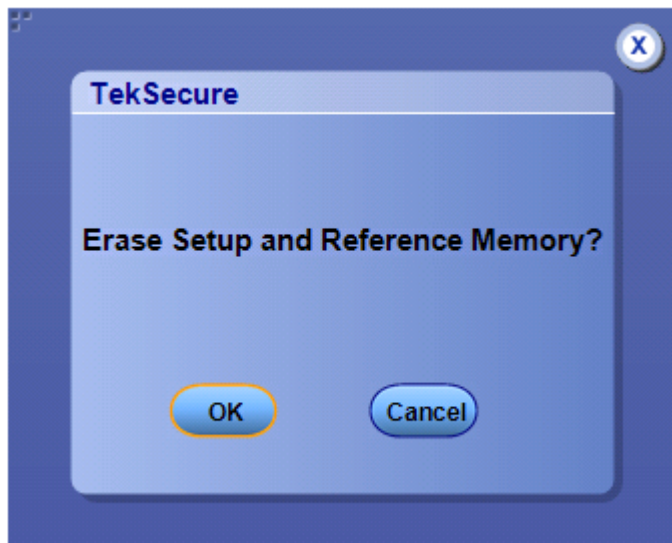

To use

- Click OK to erase.
- Click Cancel to exit the dialog box.

Behavior

Tek Secure Erase removes, for the current user, all reference waveform and instrument setup memory locations. Erased setups are replaced with the default factory setups.

Set time and date

From the Utilities menu, select Set Time & Date.

Overview

Use the Set Time and Date control window to set the time and date on the instrument.

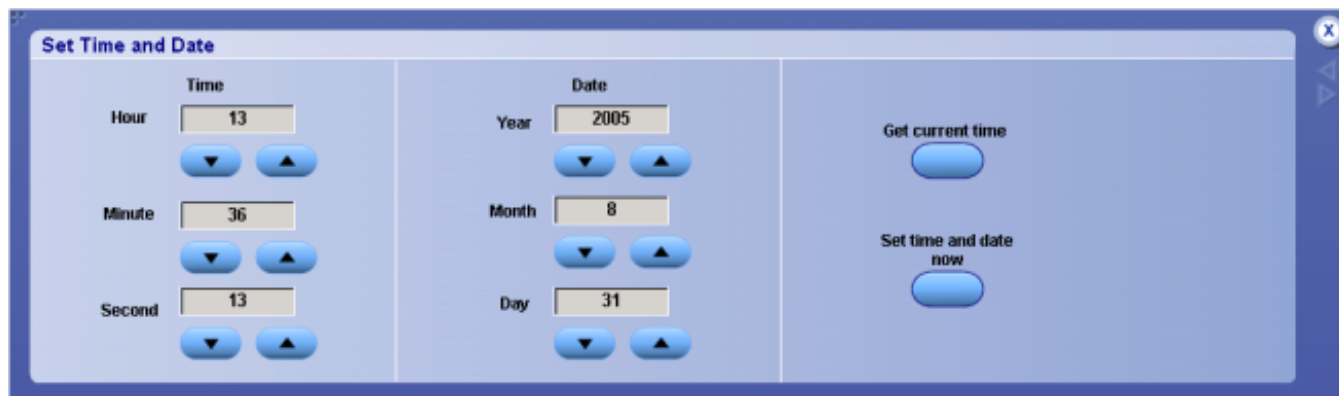

To use

- Click in the entry boxes to map them to the multipurpose knobs, and then use the knobs to set the time and date.
- Click the Set time and date now button to save your changes.
- You can also click Get current time to set the time using the system clock. This is useful if the instrument clock is out of sync.

Behavior

The controls in this window operate the same as the standard Windows Date/Time Properties dialog box. After you click Set time and date now, the system date and time are set to the specified values. These controls are provided as a convenience so you can change the date and time without having to go to the Windows Control Panel > Date and Time properties dialog box.



TIP. The instrument clock is suspended when this window is open. Click Get current time to resynchronize the clock with the PC clock.

GPIB configuration control window

From the Utilities menu, select GPIB Configuration (GPIB is not available on DPO7000SX instruments).

Overview

Use the GPIB Configuration control window to configure the instrument for GPIB (General Purpose Interface Bus) applications.

GPIB applications enable you to remotely control your instrument, for example, taking measurements, setting controls, or performing calculations.



The following screen appears on MSO/DPO5000B Series instruments:



To use

- Click the Talk/Listen button to enable the GPIB.
- Click in the Address entry box to map it to a multipurpose knob and use the knob to set the GPIB address for the instrument.
- Click the Controller button to use your instrument to control other instruments.
- Click the Off Bus button to make the GPIB port unavailable.

NOTE. The Address controls are only available when you are in Talk/Listen mode.

Behavior

The instrument is defined as a GPIB talker/listener when you click Talk/Listen. This is the device-based operation.

The instrument is defined as a controller when you click Controller. This is the controller-based operation. You cannot use GPIB commands to control your instrument when it is in Controller mode. When in Controller mode, clicking Off Bus has no effect. The Off Bus control only makes the GPIB port unavailable if you are in Talk/Listen mode.

What do you want to do next?

[Learn about External Signals control window.](#)

[Learn about LAN Server Status control window.](#)

LAN server status control window

From the Utilities menu, select LAN Server Status.

Overview

This control window allows you to enable the VXI-11 LAN server to accept GPIB commands.



For more information, see the *Getting Started with OpenChoice Solutions* manual that shipped with your instrument.

To use

- Click the Start button to enable the VXI LAN server to accept GPIB commands.
- Click the Stop button to disable the ability of the VXI-11 LAN server to accept GPIB commands.

What do you want to do next?

[Return to the Utilities Menu.](#)

[Learn about oscilloscope analysis and connectivity.](#)

[Learn about GPIB Configuration Control Window.](#)

External signals control window

From the Utilities menu, select External Signals, or click the Ext Ref button on the Acquisition tab of the [Horizontal/Acquisition control window](#).

Overview

Use the External Signals control window to select the signal to send to the Aux Out BNC connector, or to toggle the instrument clock reference source.

NOTE. The following illustrations show C model instruments. On MSO/DPO7000DX model instruments the External Reference In maximum input voltage is 4 V and the impedance is 50 Ω . On DPO7000SX model instruments the External Reference In maximum input voltage is 2.8 V_{p-p} and the impedance is 50 Ω .

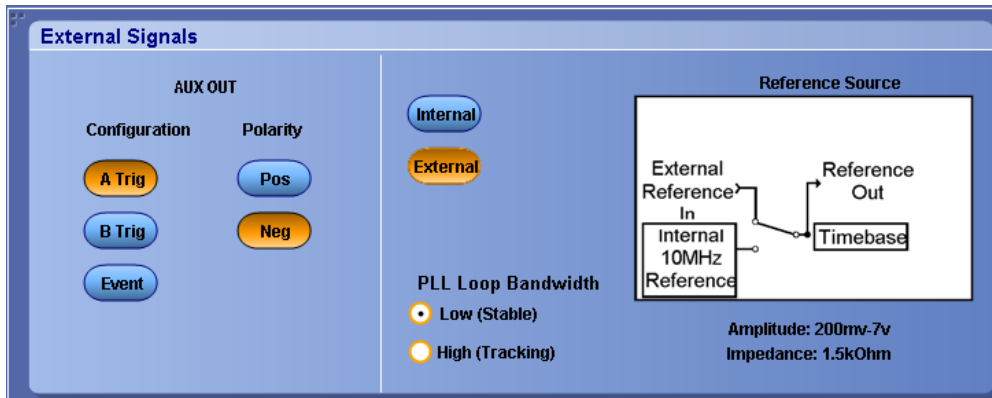

Figure 16: Utilities menu on C model instruments.

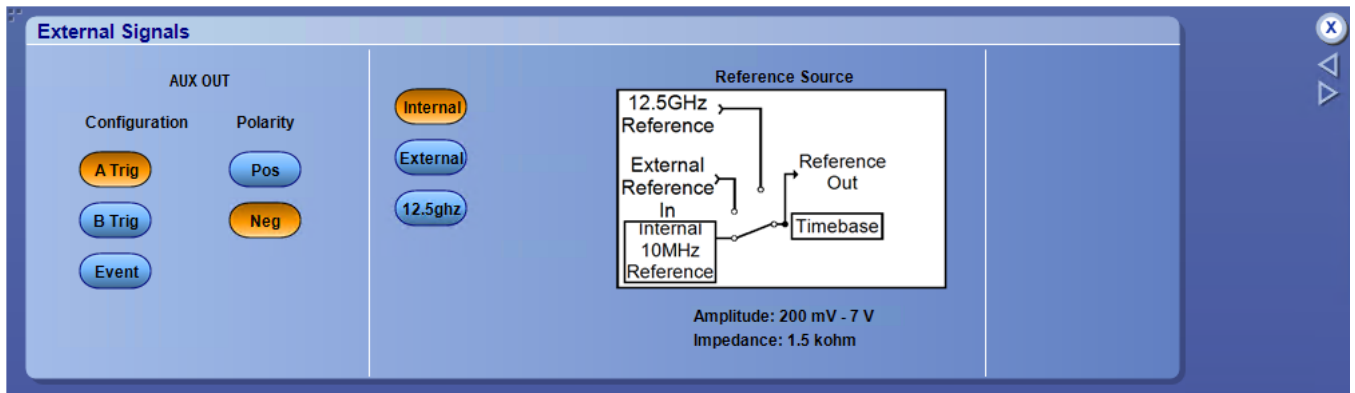

Figure 17: Utilities menu on SX model instruments

To use

To send a signal from the Aux Out BNC connector when the instrument triggers:

- Click on the desired configuration button: A Trig, B Trig, Event, or Ref Out.
 - A Trig to send a signal when the A Trigger generates a trigger
 - B Trig to send a signal when the B Trigger generates a trigger
 - Event to send a signal out the connector when certain events occur, such as a mask test failure or completion
 - Ref Out to send a copy of the internal reference clock out the connector

NOTE. Ref Out is not available on MSO/DPO70000C/DX Series instruments.

- Click Pos or Neg to set the polarity.

To select the oscilloscope clock reference source:

- Click the Internal or External source button.

To minimize jitter when using an external reference clock input (available on MSO/DPO70000C/DX instruments only):

- Select the Low (Stable) option when using a stable low-jitter clock source.
- Select the High (Tracking) option when the oscilloscope needs to track the external clock to minimize jitter.

On SX model instruments you can select the 12.5 GHz multi-instrument clock.

Behavior

For Auxiliary Output, the selected signal is routed to the Aux Out BNC connector so that you can trigger another instrument, such as a logic analyzer. The output voltage is TTL-compatible.

For External Reference Sources, the clock reference is routed to the Ext Ref BNC connector when you select External.

NOTE. You must perform a signal path compensation whenever you change the reference. When not using the external reference, disconnect signals from the EXT REF IN BNC connector.

Touch screen

From the Utilities menu, highlight Touch Screen; then select Calibrate.

Overview

Use the Touch Screen submenu to calibrate the touch screen.

To use

1. Select Calibrate.
2. Follow the on-screen instructions.

Behavior

The Calibrate command starts the Touch Screen calibration program.

Instrument calibration control window

From the Utilities menu, select Instrument Calibration.

Overview

Use the Instrument Calibration control window to run the Signal Path Compensation (SPC).

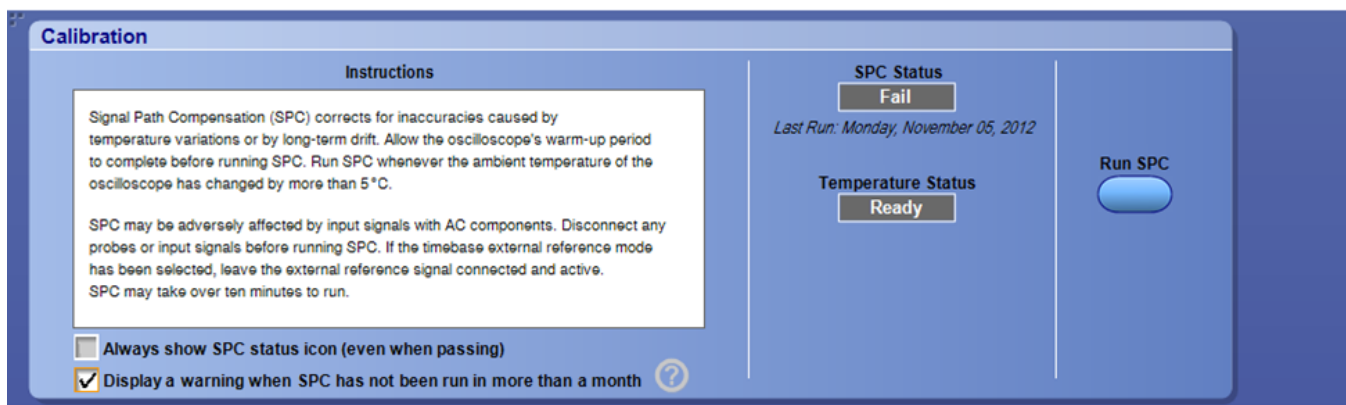

The following screen appears on DPO7000SX instruments in a multi-instrument configuration:

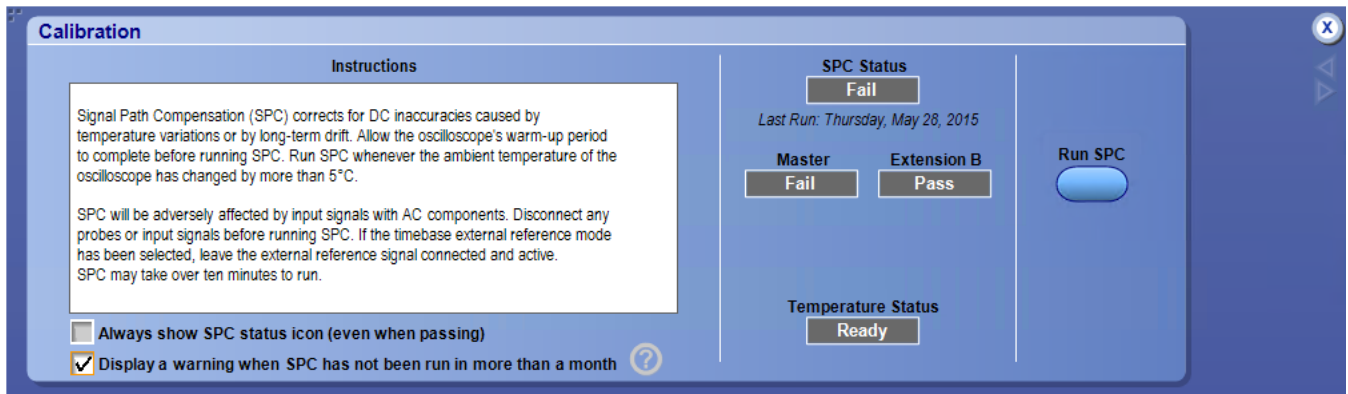

To use

Click “Always show SPC status icon (even when passing)” to always display the SPC icon in the status readout. The icon resembles a thermometer.



NOTE. The SPC icon changes color to indicate when you need to run the SPC routine because the temperature of the oscilloscope has changed by more than 5 °C since the last time the SPC routine was run.

Click “Display a warning when SPC has not been run in more than a month” so the oscilloscope displays a message when the SPC routine is due to be run again.

1. Follow the set up instructions.
2. Click the Run SPC button to begin the procedure.

Behavior

The only user-accessible calibration is the signal path compensation (SPC). All other calibration is accessible to qualified service personnel only. For all calibrations, the SPC Status control should indicate Pass or Compensated. If it does not, contact your local Tektronix service personnel.

The oscilloscope displays the date of the last time the SPC routine was run beneath the SPC Status control.

What do you want to do next?

[Follow a step-by-step signal path compensation procedure.](#)

Instrument diagnostics control window

From the Utilities menu, select Instrument Diagnostics.

Overview

Use this control window to run the instrument diagnostics.

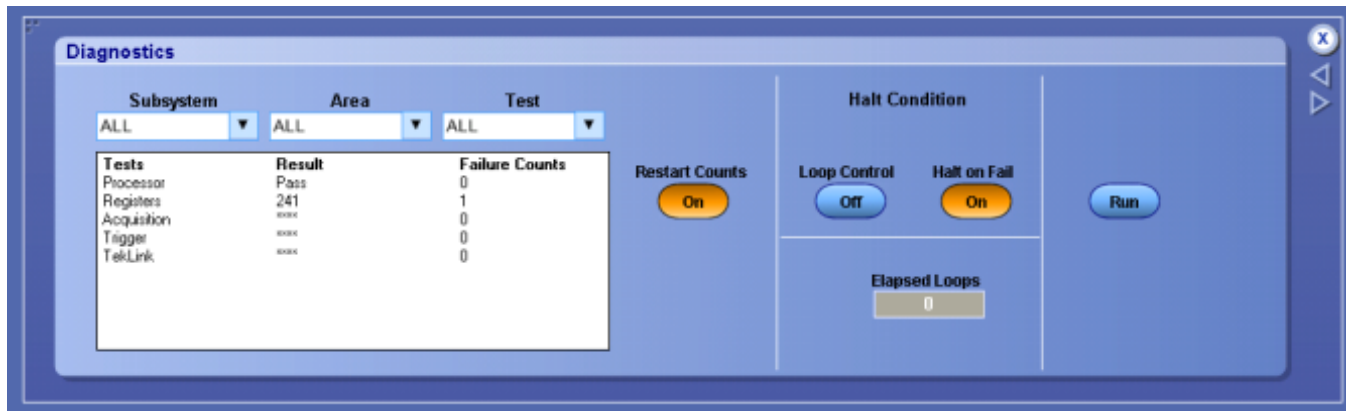

The following screen appears on MSO/DPO5000B Series instruments:

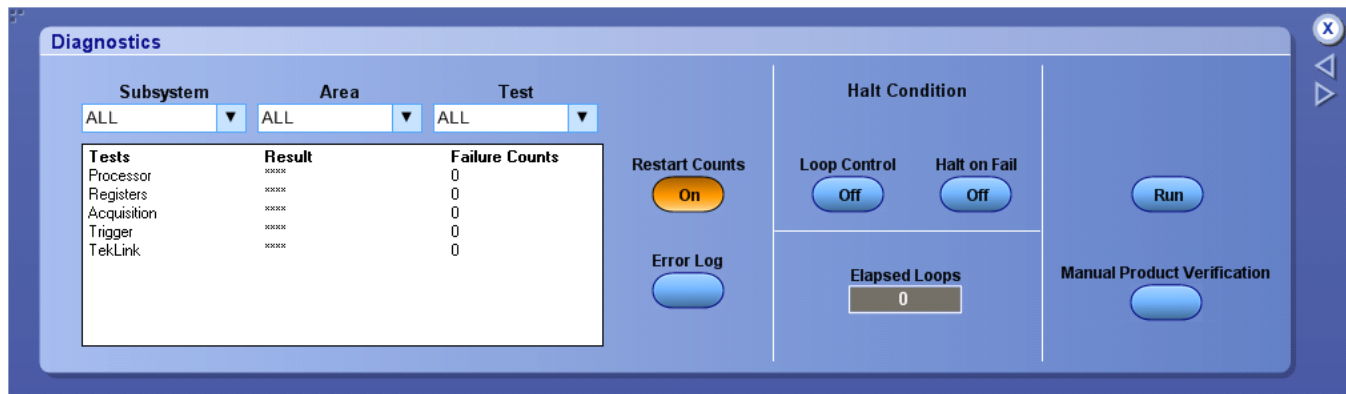

To use

1. Use the drop-down list boxes to identify the Subsystem, Area, and Test you want to run.
2. Use the Halt Condition controls to enable looping on the selected test(s) or to halt looping as soon as a failure occurs.
3. Click the Run button to initiate the tests.

The Error Log button displays the number of entries in the error log if the number is greater than 0, else nothing is displayed. The Diagnostics error Log window is available only when the power up diagnostic setting is set to Factory.

NOTE. The Manual Product Verification option to know how to use special PV modes is available only on MSO/DPO5000B Series instruments.

Product Verification Modes

Refer to the DPO/MSO product verification (PV) procedures for how to use special PV modes.

Verify TPPxxxx host terminations

Note these modes are for manual PV only.
Clear them (or cycle power) for normal operation.

You can run all tests or specific tests using the options on the Subsystem, Area, and Text drop-down lists. The Diagnostic Status table lists each diagnostic, the results of the test, and the number of failures that occurred.

Behavior

This window is mainly intended for service personnel. The diagnostic information can be used as part of an incoming inspection or to diagnose potential problems with the instrument.

NOTE. Remove the input signals before running any diagnostics.

If any diagnostic failures occur, record the failure information, and then contact your local Tektronix service personnel for more information.

E-mail on event control window

From the Utilities menu, highlight E-mail on Event; then select Setup.

Overview

Use this control window to set up the conditions under which the instrument will send an e-mail, the types of attachments to include, and the message limits.

E-mail on Event Setup

Recipient e-mail address(es): (Separate addresses with a comma)

| Send E-mail on | E-mail Attachments | Messages | Max E-mail Size (MB) | Test E-mail |
|---|--|---|----------------------------------|------------------------|
| <input type="checkbox"/> Trigger Event | <input type="checkbox"/> Screen Capture Settings | Limit <input type="text" value="1"/> | <input type="text" value="1MB"/> | Send |
| <input type="checkbox"/> Mask Test Failure | <input type="checkbox"/> Waveform(s) Settings | Current Count <input type="text" value="0"/> | | |
| <input type="checkbox"/> Limit Test Failure | <input type="checkbox"/> Measurement(s) Settings | Reset | | Config |

To use

1. In the Recipient e-mail address(es) entry box, type in the addresses where you want to send e-mail. Use a comma to separate multiple addresses.
2. In the Send E-mail on check boxes, select the events on which you want to send e-mail.
3. Use the E-mail Attachments check boxes to select the type of attachment to include with the e-mail.
4. Click the Settings button to open the Save Options dialog box and set the parameters for the attachment.
5. In the Limit text box, enter the number of e-mail messages to send, up to a maximum of 32767.
6. In the Max E-mail Size entry box, enter the maximum message size, up to 2 GB, for each e-mail message.
7. Click the Send button to send a test e-mail.
8. Click the Config button to open the E-mail Configuration dialog box.

Behavior

The maximum number of characters in the Recipient e-mail address(es) box is 252, so you can enter any number of e-mail addresses up to a total of 252 characters. You can select one or all of the events to send e-mail on. If you do not have a SMTP server address or e-mail address set up, you cannot select an event to send e-mail on.

The screen capture, waveform, and measurement types for the e-mail attachments are determined by the type that you select in the Save Options dialog box when you click Settings.

When the maximum number of messages is reached, the Send E-mail on check boxes are cleared and the Current Count is reset to 0. You must select the event again to continue sending e-mail. Clicking Reset changes the current count back to 0.

Attachments that exceed the Max E-mail Size are saved to the hard drive on the instrument.



TIP. To save your attachments on the instrument hard drive and still send an e-mail, set the Max E-mail Size limit to 0.

What do you want to do next?

[Learn about the E-mail Configuration dialog box.](#)

[Learn about Mask Testing.](#)

[Learn about Limit Testing.](#)

[Learn about Measurement Save Options.](#)

Measurement save options

From the Utilities menu, highlight E-mail on Event; then select Setup. From the E-mail on Event Setup dialog box, select Measurement(s) and then click Settings.

Overview. Use this control window to set up the conditions under which the instrument will send an e-mail and with the types of attachments to include for the measurements.

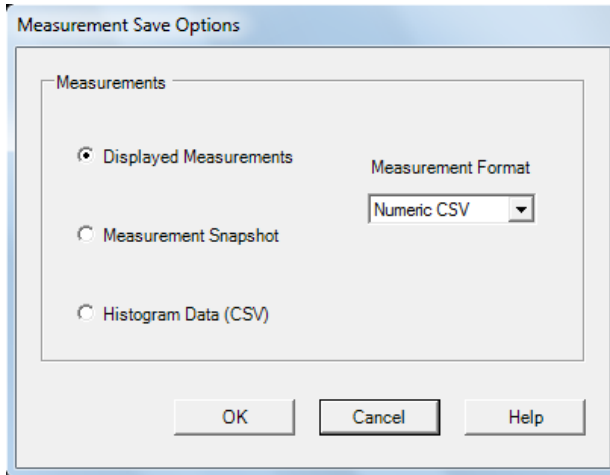

To use.

1. Click the Settings button to open the Measurement Save Options dialog box.
2. Select the measurement option and the file format. Click OK.

Selecting the Displayed Measurements option includes the measurements that are displayed on the screen; the Measurement Snapshot option includes the information on measurements snapshot, and the Histogram Data (CSV) option includes the histogram data in CSV format for the e-mail.

The following measurement file formats are available:

Numeric CSV. This creates (.csv) files in a numeric format usable by spreadsheets.

Numeric TXT. This creates (.txt) files in a numeric format usable by text and word processors.

Text CSV. This creates (.csv) files in a text format usable by spreadsheets.

Text TXT. This creates (.txt) files in a text format usable by text and word processors.

Multipurpose knobs

The multipurpose knobs can be used to set screen interface parameters (Using the knobs on DPO70000SX instruments requires the DPO7AFP accessory). To use, click a control on the screen to map it to the multipurpose knob(s).

| Control | Description |
|--|--|
|  <p>For MSO/DPO5000B Series instruments:</p> | <p>You can undo any mapping by right-clicking the multipurpose knob(s) and selecting Deassign Multipurpose Knobs, or from the Utilities menu, select the Deassign Multipurpose Knobs command. The mapping is deassigned until you perform that function again.</p> <p>Turn the knob(s) or scroll with the mouse wheel until the desired selection appears in the readout mapped to the knob. Push the FINE button, or click the mouse wheel to use the knob to make small changes, for example, to add another decimal place for greater accuracy.</p> <p>When no control windows are open and cursors are turned on, the multipurpose knobs control the cursor positions.</p> |

NOTE. These knobs are automatically mapped when certain functions are performed, for example, when the MultiView Zoom button is pushed.

User preferences control window

User preferences (Prompt before action)

From the Utilities menu, select User Preferences; then open the Prompts tab.

Overview. Use the Prompts tab to indicate whether or not you want the instrument to display prompts (confirmation messages) before carrying out certain tasks, like deleting files or waveforms.

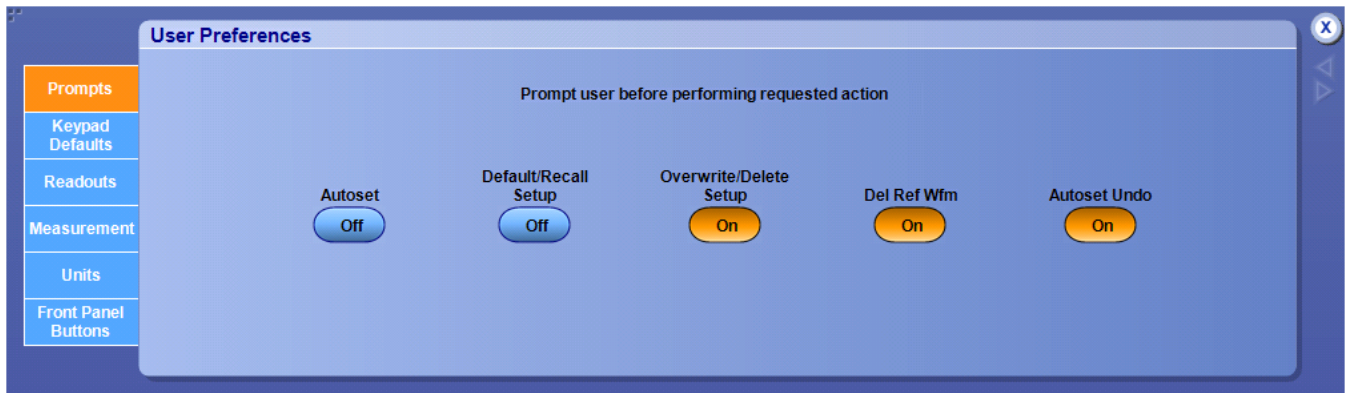

To use. Click a button to enable or disable the control setting.

Behavior. The confirmation messages give users the chance to change their minds before taking action. The messages generally explain the implications of the action.

All preference settings are saved when you power off the instrument.

What do you want to do next?

[Learn about setting user preferences for trigger level presets.](#)

User preferences (Keypad defaults)

From the Utilities menu, select User Preferences; then open the Keypad Defaults tab.

Overview. Use the Keypad Defaults tab to define the preset trigger levels.

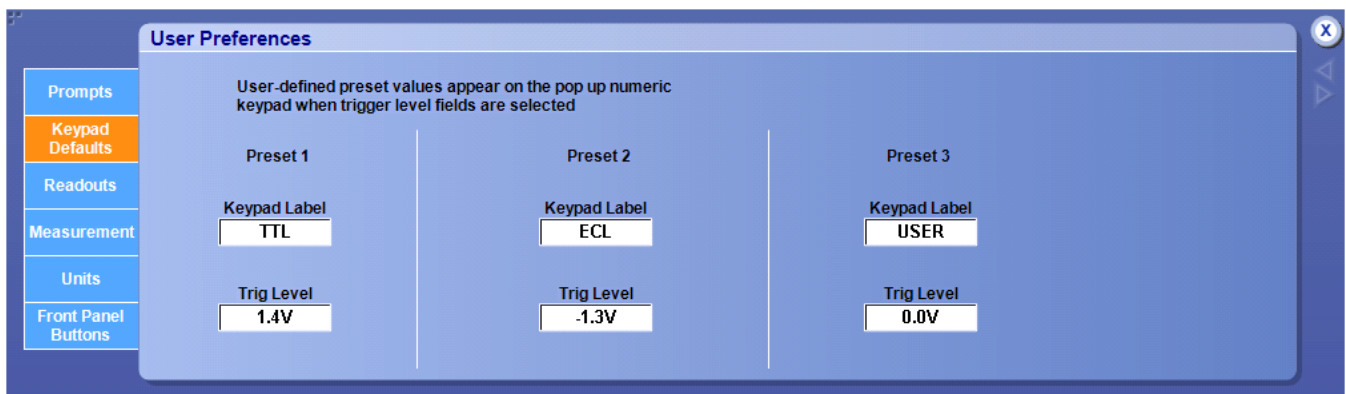

To use.

- To change the label for the selected preset control, click in the Keypad Label text entry boxes and enter a name.
- Click in the Trig Label Level entry boxes to map them to the multipurpose knobs. Use the knobs to set the trigger level values.

Behavior. Use this control window to change the trigger level preset values. This can be useful when you want to trigger the instrument on nonstandard trigger levels.

By default:

- TTL fixes the trigger level at +1.4 V.
- ECL fixes the trigger level at -1.3 V.

When you set the volts/div less than 200 mV, the instrument reduces the TTL or ECL trigger levels below their standards. This is because the trigger level range is fixed at ± 12 divisions from the center. For example, at 100 mV, the trigger range is ± 1.2 V, smaller than the standard TTL and ECL levels.

All preference settings are saved when you turn the instrument power off.

What do you want to do next?

[Learn about setting up prompts for certain controls.](#)

User preferences (Readouts)

From the Utilities menu, select User Preferences; then open the Readouts tab.

Overview. Use the Readouts tab to select readout visibility and turn Highlight readouts on and off.

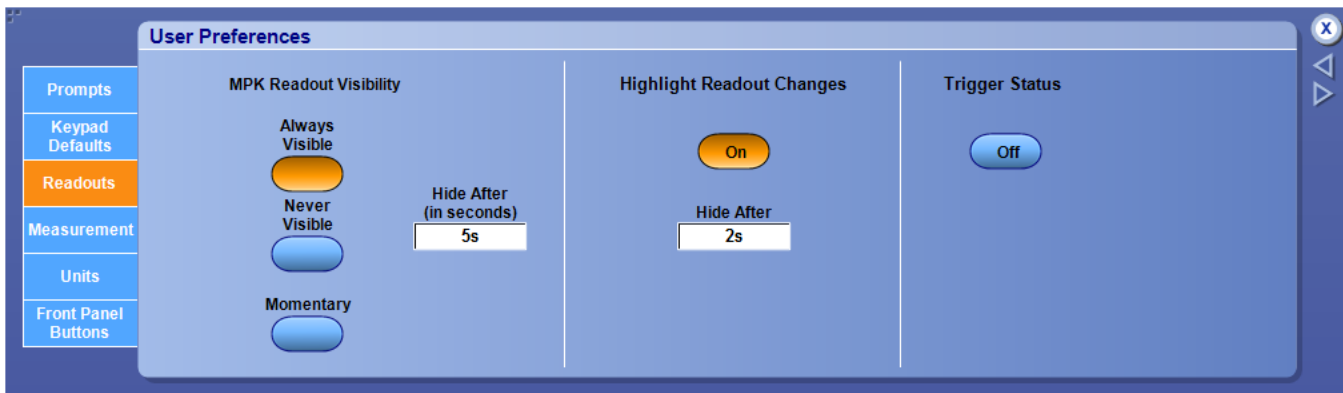
**To use.**

- Select an option for MPK Readout Visibility.
- Click the Highlight Control Changes button On or Off to highlight readouts when you make changes.
- Enter a time to leave the readout highlighted in the Hide After entry boxes.
Click the Trigger Status button to toggle it on or off.

Behavior. The maximum length of time you can leave the readouts highlighted is 5 seconds.

The following readouts are highlighted:

- Vertical Scale
- Horizontal Delay
- Trigger Level
- Trigger Source
- Trigger Slope
- Source Termination

What do you want to do next?

[Learn about setting up prompts for certain controls.](#)

[Learn about setting user preferences for trigger level presets.](#)

User preferences (Measurement annotation)

From the Utilities menu, select User Preferences; then open the Measurement tab.

Overview. Use the Measurement tab to set the user preference for measurement annotation. Annotations show the exact segment of the waveform from which the measurement is derived.

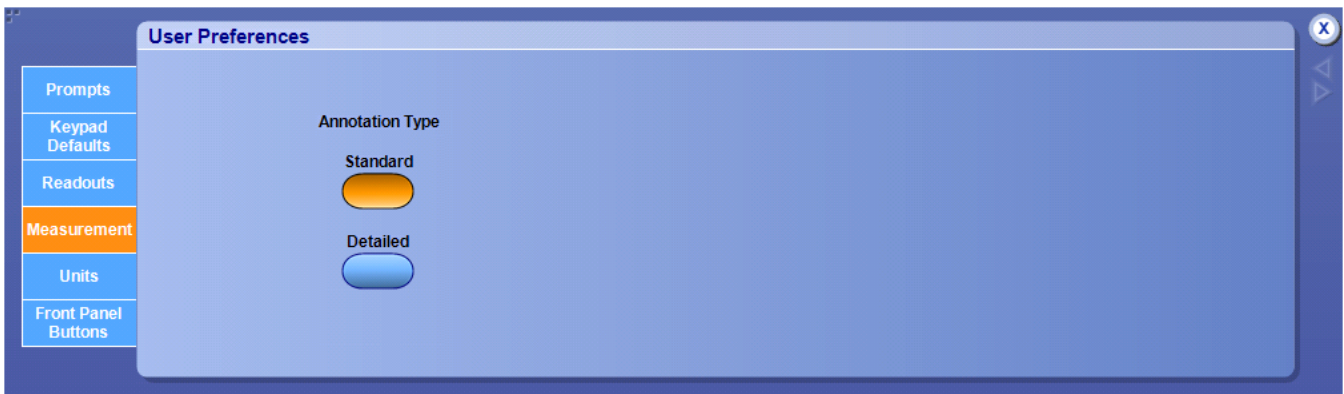

To use. Click a button to select the annotation type, Standard or Detailed.

Behavior. The annotation types consist of horizontal bars, vertical bars, horizontal arrows, or vertical arrows.



TIP. You can access this feature, or turn the feature off, from the Measure menu. Select Measure > Annotation; then select Standard, Detailed, or Off.

User preferences (Units)

From the Utilities menu, select User Preferences; then open the Units tab.

Overview. Use the Units tab to set the detents for the vertical scale controls.

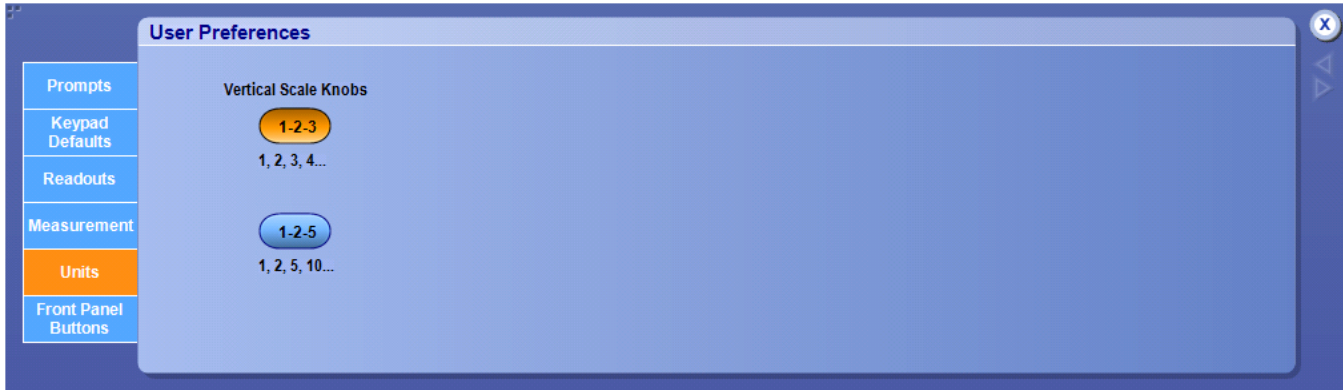

To use. Click one of the buttons to set the vertical scale detents:

- Click 1–2–3 to set the vertical detent increments to 1, 2, 3, 4...
- Click 1–2–5 to set the vertical detent increments to 1, 2, 5, 10...

Behavior. If the user preference is set to 1–2–3, the vertical knobs will increase or decrease the scale in a 1–2–3... 10–20–30... 100–200–300... sequence.

If the user preference is set to 1–2–5, the vertical knobs will increase or decrease the scale in a 1–2–5... 10–20–50... 100–200–500... sequence.

User preferences (Front panel buttons)

From the Utilities menu, select User Preferences; then open the Front Panel Buttons tab.

Overview. Use the Front Panel Buttons tab to set the function of the Print and the Default Setup buttons.

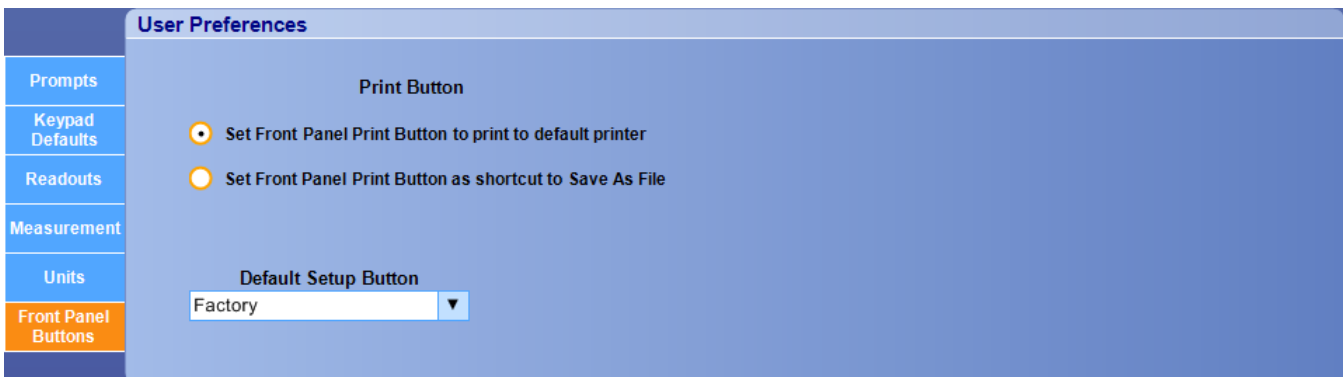

To use. Click the Set Front Panel Print Button to change the function of the front panel Print button to save a file each time you push the button.

To select a saved setup for the oscilloscope to recall when you push the Default Setup front panel button:

- Select Factory from the list to recall the Factory setup.
- Select a saved setup (from Setup 1 through Setup 10) to recall a specific setup.

Behavior. When the Set Front Panel Print Button is not selected, the function of the front panel Print button is to print. When you select the alternate save function for the Print button, the oscilloscope updates the File Save As menu (under the File menu) for the selected file type.

Name: 090603_142550

Save as type: Setup files (*.set)

Auto-increment file name

Prompt for file name before saving

Set Front Panel Print Button to Save

Set Front Panel Default Setup button to recall this setup

Buttons: Save, Cancel, Help

Option installation

Install an option

From the Utilities menu, select Option Installation.

Overview. Use Option Installation to enable upgrades that you have purchased for your instrument from Tektronix. For the most current list of upgrades, go to www.tektronix.com or contact your local Tektronix representative.

To use.

1. Click the Continue button in the initial dialog box.

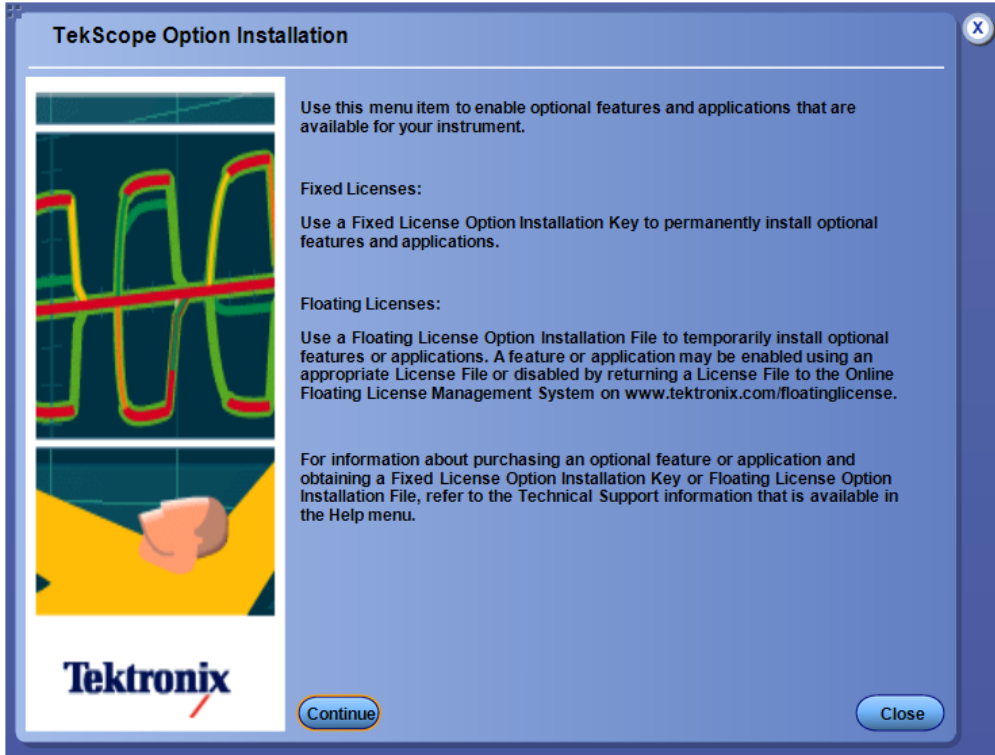

2. Use either floating license or fixed license and follow the on-screen instructions to install the options.

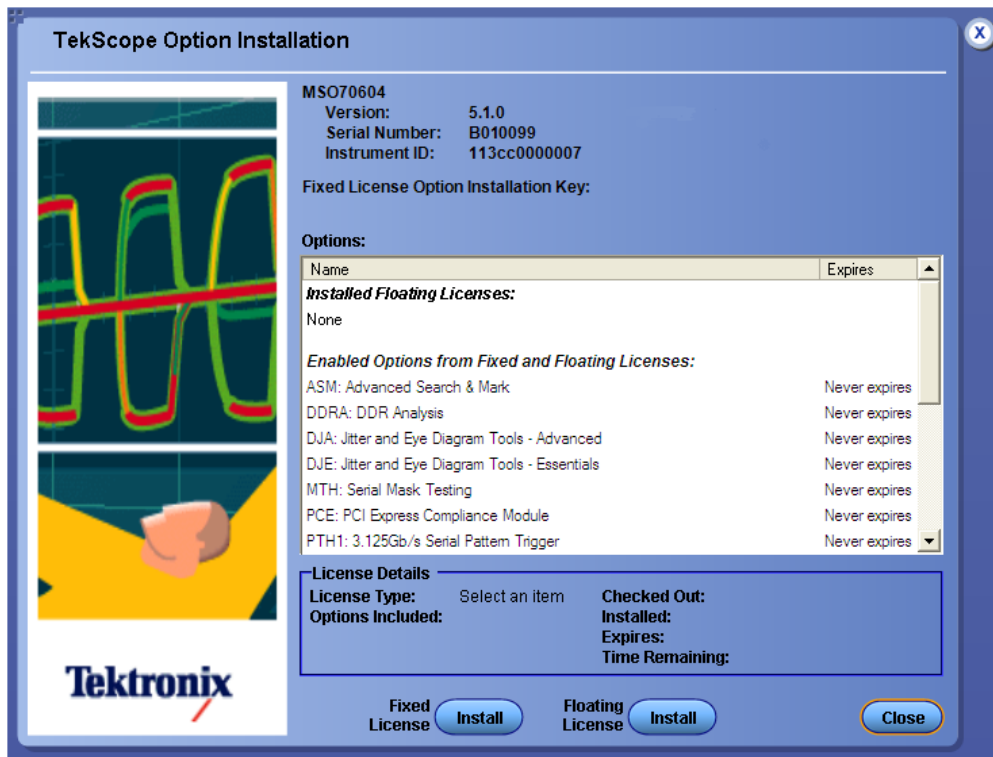

NOTE. Use the [fixed license option installation](#) to permanently install the optional features and applications. Use the [floating license option installation](#) to temporarily install the optional features and applications.

Behavior. The installation dialog box lists information about the installed options and applications. The installation is acknowledged when complete.

To run external applications following installation:

1. In the Menu bar, click Analyze.
2. Select the application name from the submenu.

NOTE. New versions of software for your instrument are available at our Web site. To find application software releases that may not be on your instrument or to find the latest versions of instrument software and application software that is on your instrument, visit www.tek.com/support.

What do you want to do next?

[Install the Floating license.](#)

[Install the Fixed license.](#)

[Return the Floating License for the Installed Option\(s\).](#)

Install the floating license

From the Utilities menu, select Option Installation.

Overview. Use Option Installation to enable upgrades that you have purchased for your instrument from Tektronix. For the most current list of upgrades, go to www.tektronix.com or contact your local Tektronix representative.

To use.

1. Click the Install button next to Floating License.

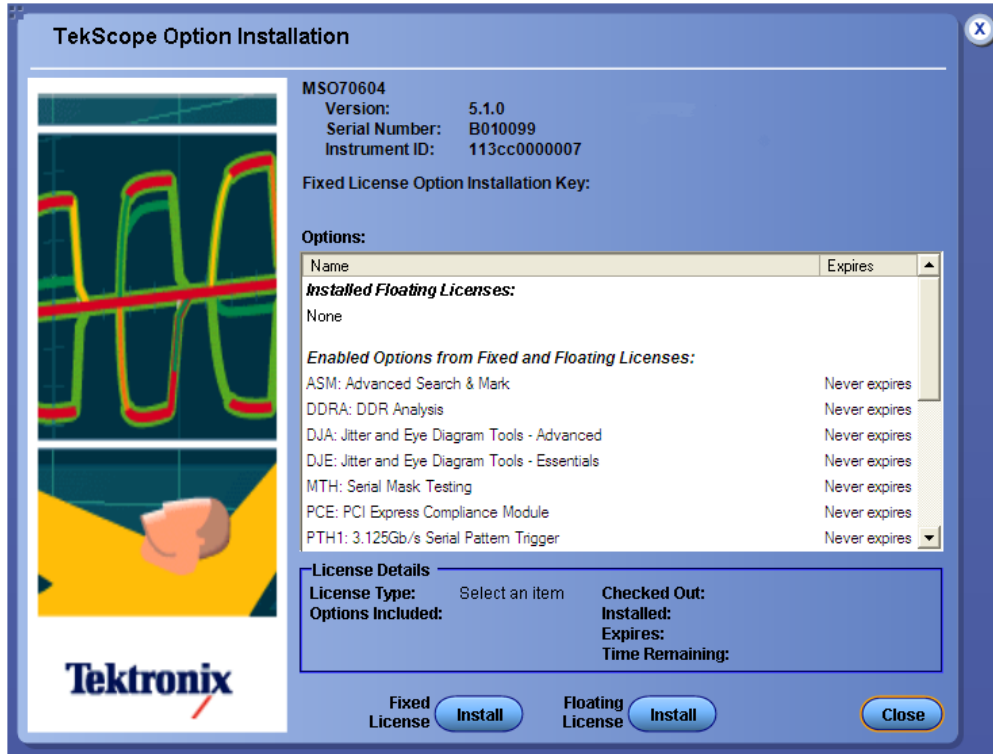

2. Browse to the path where the floating license key file (.lic) is located, select the file, and click Open.

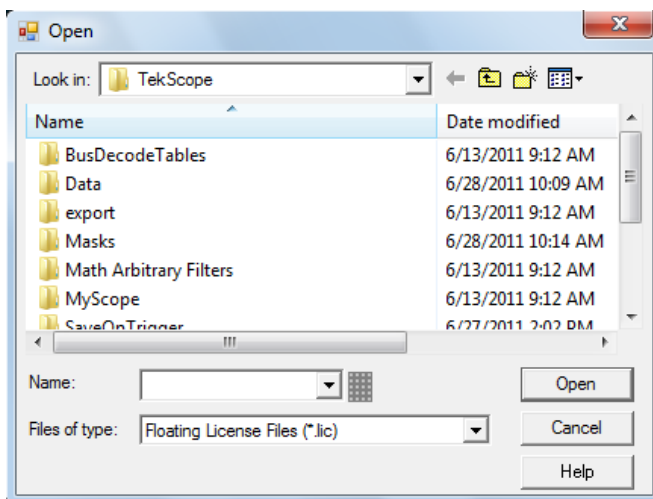

3. On successful installation, a dialog box appears indicating that the Option is enabled. Reboot the instrument for the changes to take effect.

For example, after installing DPOFL-PTD (TDSPTD), the Tekscope Option Installation dialog box appears as follows:

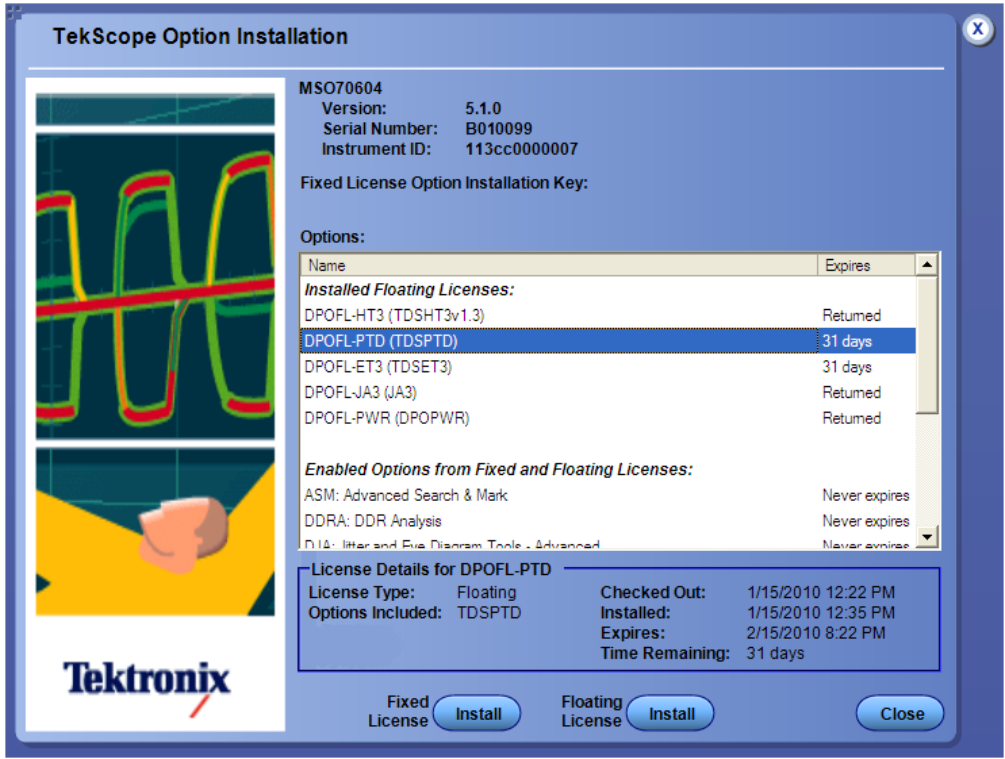

NOTE. Ensure that you select an authorized option installation key file to avoid any errors during installation. For any information on the purchase of an Option Installation key file, refer to the Technical Support information at <http://www.tektronix.com/floatinglicense>. You must minimize the oscilloscope application to see the WEB page.

Install the fixed license

From the Utilities menu, select Option Installation.

Overview. Use Option Installation to enable upgrades that you have purchased for your instrument from Tektronix. For the most current list of upgrades, go to www.tektronix.com or contact your local Tektronix representative.

To use. Fixed License

1. Click the Install button next to Fixed License.

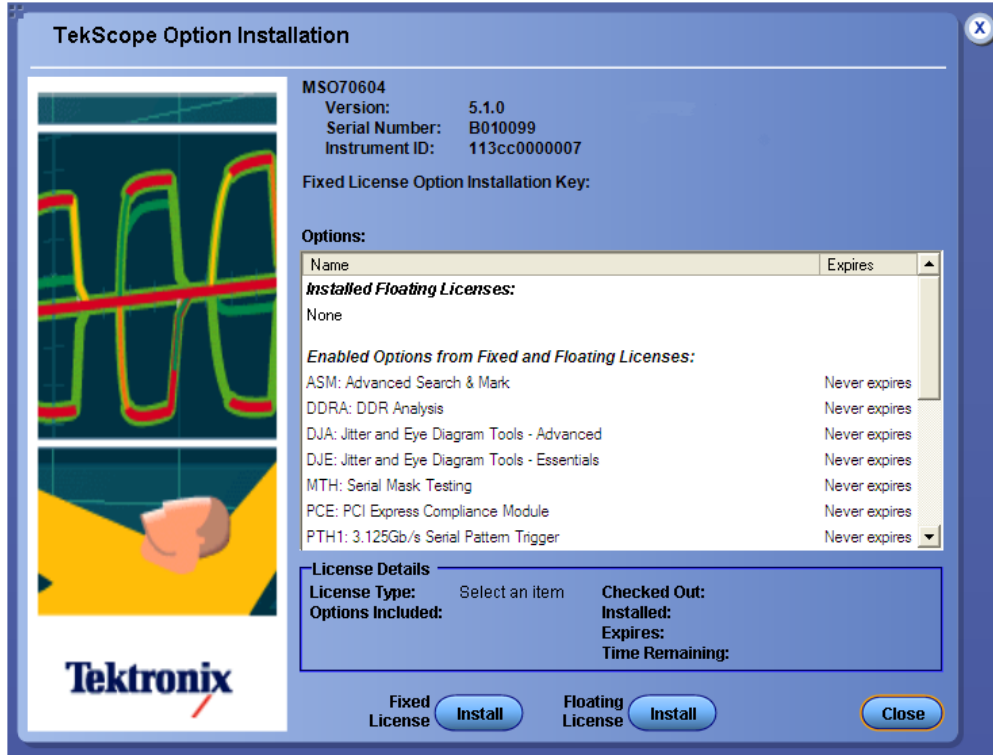

2. Enter the option installation key (provided by Tektronix) in the Options dialog box.

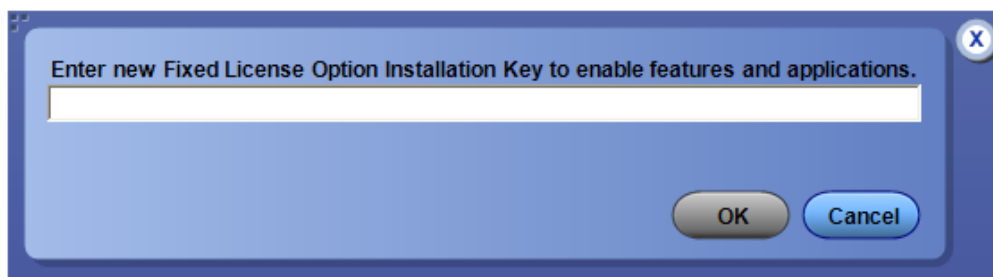

3. Click OK. On successful installation a dialog box appears. Reboot the instrument for the changes to take effect.

Return the floating license for the installed option(s)

From the Utilities menu, select Option Installation.

Overview. Use the Option Installation to return the floating license for the installed Option(s) that you purchased for your instrument from Tektronix.

To use.

1. From the Utilities menu, select Option Installation.
2. Click Continue. The following dialog box appears.

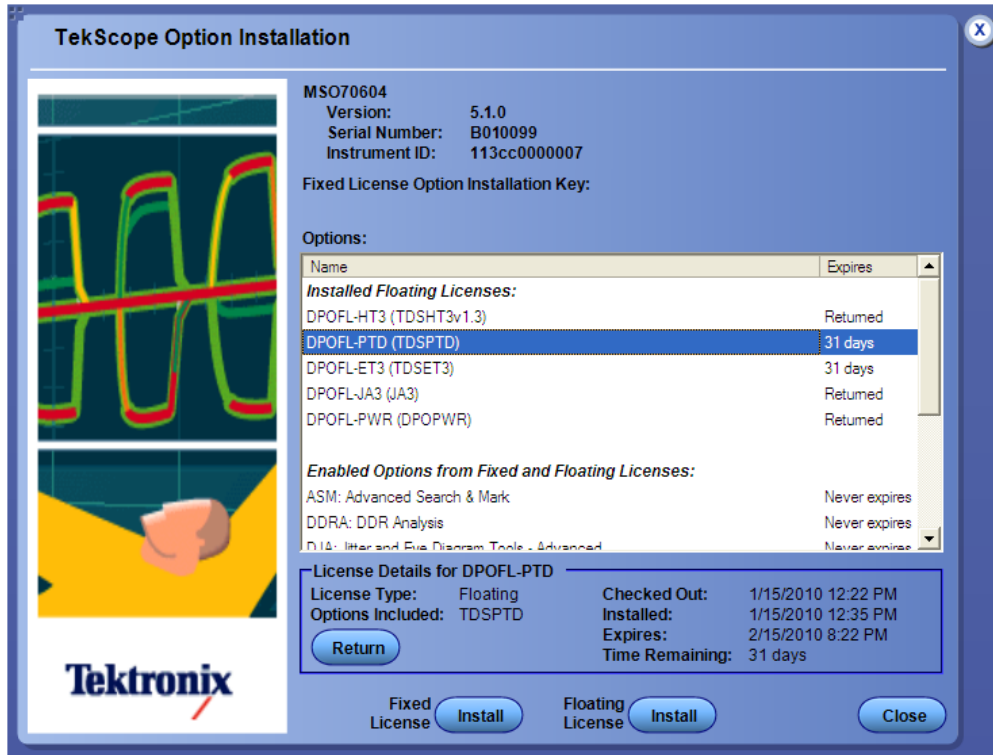

3. Select the Option (for example DPOFL-PTD (TDSPTD)) in the Tekscope Option Installation dialog box and click the Return button (when the license is still valid) or click Exit Key button (when the license has expired).
 A dialog box appears. Click OK.
4. Browse to the path where you want to save the Exit Key file.

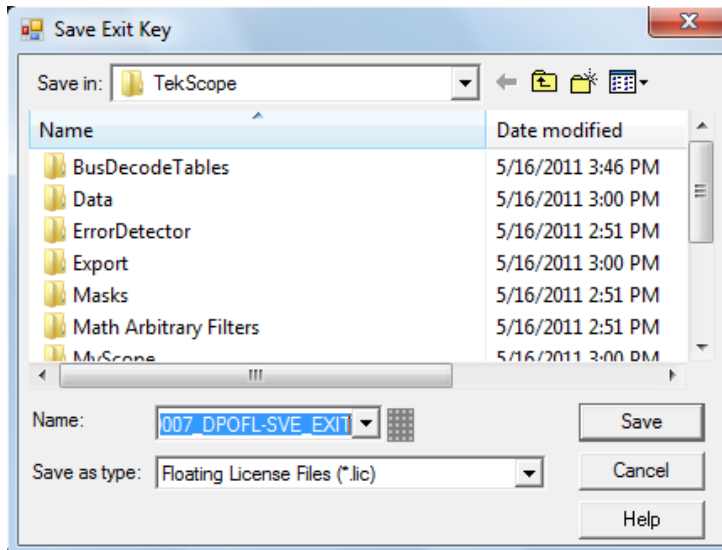

NOTE. Ensure that the Exit Key file is uploaded to the Online Floating License Management System on <http://www.tektronix.com/floatinglicense> to access the floating license again.

- The following dialog box appears on completing the return of a floating license. Click Close.

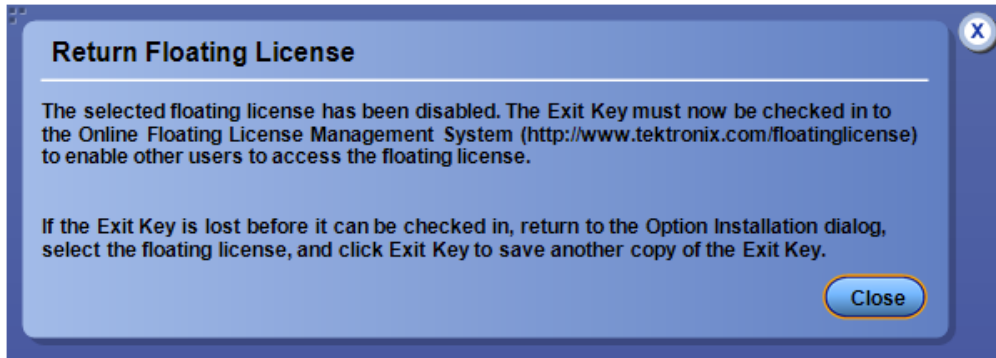

- A dialog box appears indicating that the selected Option is disabled. Reboot the instrument for the changes to take effect. For example, after returning the floating license for DPOFL-PTD (TDSTPTD), the Tekscope Option Installation dialog box appears as follows:

TekScope Option Installation

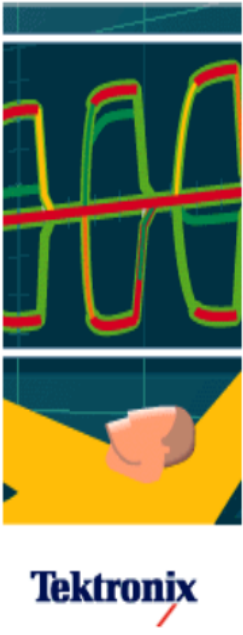

MSO70604
 Version: 5.1.0
 Serial Number: B010099
 Instrument ID: 113cc000007

Fixed License Option Installation Key:

Options:

| Name | Expires |
|--|-----------------|
| Installed Floating Licenses: | |
| DPOFL-HT3 (TDSHT3v1.3) | Returned |
| DPOFL-PTD (TDSPTD) | Returned |
| DPOFL-ET3 (TDSET3) | 31 days |
| DPOFL-JA3 (JA3) | Returned |
| DPOFL-PWR (DPOPWR) | Returned |
| Enabled Options from Fixed and Floating Licenses: | |
| ASM: Advanced Search & Mark | Never expires |
| DDRA: DDR Analysis | Never expires |
| D14: Literal and File Diagram Tools - Advanced | Never expires |

License Details for DPOFL-PTD

| | | | |
|-------------------|----------|-----------------|--------------------|
| License Type: | Floating | Checked Out: | 1/15/2010 12:22 PM |
| Options Included: | TDSPTD | Installed: | 1/15/2010 12:35 PM |
| | | Expired: | 1/15/2010 1:51 PM |
| | | Time Remaining: | Returned |

[Exit Key](#)

Fixed License

Floating License

How to ?

Calibrating and using probes

Compensate the signal path

Use the following procedure to compensate the internal signal acquisition path. Perform this procedure if the ambient temperature has changed more than 5 °C (9 °F) since you performed the last signal path compensation. Perform the signal path compensation once a week. Failure to do so may result in the instrument not meeting warranted performance levels.

1. Power on and wait for the instrument to complete its warm up period before continuing with this procedure.
2. Disconnect any probes you have connected to the input channels.
3. Set the instrument to Menu mode.
4. Select Instrument Calibration from the Utilities menu.
5. Note any instructions that appear in the resulting control window.
6. Click Run SPC to begin the procedure. The procedure may take several minutes to complete.
7. Verify that the Status changes to Compensated after the procedure is complete. If the Calibration Status field indicates anything other than Compensated, see [Signal Path Compensation Status](#) for information on the readout and recommended action.

NOTE. When making measurements at vertical scale settings less than or equal to 5 mV, you should perform the signal path compensation at least once a week. Failure to do so may result in the instrument not meeting warranted performance levels at those volts/div settings.

Compensate active probes

NOTE. This online help file supports many oscilloscope models from Tektronix. This feature is only available on some models.

Use this procedure to optimize gain and offset accuracy at the probe tip for each active probe. Allow the instrument and probe to warm up before performing this procedure. Then complete the following steps:

1. If you have not already done so, connect the probe to one of the vertical inputs on the instrument.
2. For DPO7000C and MSO/DPO5000B instruments only, connect the probe tip to the probe compensation (Fast Edge on some models) outputs. Connect only one probe at a time.
3. For MSO/DPO7000C/DX instruments, connect the probe to the DC PROBE CAL output through the deskew fixture as shown in the *Z-Active Probe Deskew Fixture Instructions*. These instructions are available from the Documentation Browser on your instrument desktop; click the Documentation icon.
4. Select Probe Cal from the Vertical menu to open the Probe Setup control window.
5. Select the channel to which the probe is attached.
6. Click Compensate Probe to begin the procedure. The Probe Status indicator changes to Pass when the procedure is complete. If the procedure does not pass, contact your local Tektronix service personnel.
7. Remove the connections from the terminals.

Compensate passive probes

Use this procedure to optimize gain and offset accuracy at the probe tip. Allow the instrument to warm up before performing this procedure.

Perform the [low frequency probe compensation](#) for passive probes.

NOTE. The probe compensation procedure is not recommended for the P5050 passive probes. These probes have little gain or offset errors. However, you should perform this procedure for other passive probes.

Complete the following steps:

1. If you have not already done so, connect the probe to the instrument.
2. Connect the probe to probe compensation (Fast Edge on some models) terminals as shown. Connect only one probe at a time.
3. Select Probe Cal from the Vertical menu to open the Probe Compensation control window.
4. Select the channel to which the probe is attached.
5. Click Compensate Probe to begin the procedure. The Probe Status indicator changes to Pass when the procedure is complete. If the procedure does not pass, contact your local Tektronix service personnel.
6. Remove the connections from the terminals.

Low frequency compensate a probe

Use this procedure to compensate passive probes to ensure maximum distortion-free inputs to the instrument.

1. Connect the probe to Ch 1 on the instrument.
2. Attach the probe tip and reference lead to the probe compensation terminals .
3. Press the Autoset button on the instrument.
4. Adjust the probe until you see a square wave with a perfectly flat top on the display.

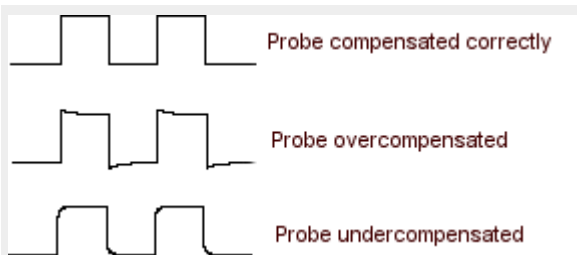

5. See your probe manual for adjustment instructions.

Deskew

Use the following procedure to compensate for timing differences between voltage probes:

1. Set up the instrument to display all of the channels that you want to deskew.
2. Push the instrument Autoset button.
3. Adjust the vertical Scale and Position controls for each channel so that the signals overlap and are centered on the display.
4. Adjust the horizontal Position so that a rising edge is triggered at the center of the display.
5. Adjust the horizontal Scale so that the differences in the channel delays are clearly visible.
6. Adjust the horizontal Position again so that the first rising edge is exactly at the center of the display. The fastest probe is connected to this channel (the fastest probe is usually the one with the shortest cable or with the highest bandwidth).
7. Select Deskew from the Vertical menu to open the Deskew control window.

8. Select one of the slower channels.
9. Adjust the deskew time for the slower channel so that its signal aligns with that of the fastest channel. The deskew adjustment range is ± 75 ns.
10. Repeat steps 8 and 9 for each additional channel you want to deskew.
11. Remove the connections from the probe compensation terminals.

For information on how to deskew probes when using the Probe Setup Control Window, click [here](#).

NOTE. To compensate for timing differences between voltage probes and between voltage and current probes, order the following Probe Calibration and Deskew Fixtures. These fixtures may require a user-supplied pulse generator.

For DPO7000C and MSO/DPO5000B Series oscilloscopes, order Tektronix part number 067-0405-XX.

For DPO70000C and DPO7000C Series oscilloscopes, order Tektronix part number 067-1586-XX.

For MSO70000C/DX Series instruments: Tektronix part number 067-2083-XX to deskew the logic probe trigger path. This fixture is a standard accessory.

Acquiring analog signals

Setting up analog channels

Use the following procedure to set the scale and position parameters for analog signal acquisition.

1. Set the acquisition system to Run continuously.
2. Connect the probe to the input signal source using proper probing/connecting techniques.
3. Click [here](#) for details on setting up the Vertical input controls.

NOTE. Some probes automatically set their termination and other values.

4. Push a front panel channel button (Ch <1– 4>) to select the input signal channel. A channel button lights when its channel is on.
5. Open the Vertical Setup control window by clicking Vert on the toolbar or selecting the Vertical Setup command from the Vertical menu. To change the input coupling, select the appropriate Termination button.
 - Select DC to couple both the AC and DC components of an input signal.
 - Select AC to couple only the AC components of an input signal.
 - Select GND to disconnect the input signal from the acquisition system.
6. Use the Vertical knobs to scale and position the waveform on the screen. Dragging the waveform handle also positions the waveform.
7. Use the Vertical Setup controls to change the offset. Click in the Offset entry box, and then use the multipurpose knob to adjust the offset.
8. Use the Horizontal knobs to scale and position the waveform on the screen and to set the record length. Dragging the reference icon also positions the waveform.
9. Use the Resolution knob to set the record length and sample interval.
10. If you need to stabilize the display, push the trigger Level control to set the trigger level to 50%.

Setting acquisition modes

Use this procedure to set the data acquisition mode and specify acquisition start/stop methods.

1. Power on the instrument.
2. Set up the *horizontal*, *vertical*, and *triggering* controls.
3. From the Horiz/Acq menu, open the Acquisition control window.
4. Click an Acquisition Mode button. For Average and Envelope modes only, select the number of acquisitions to average or envelope. For WfmDB acquisition mode, select the number of samples.
5. Push the Run/Stop front-panel button to toggle between starting and stopping acquisitions, or push the Single button to acquire enough waveforms to satisfy the acquisition mode.
6. To select the sampling mode, click the Horiz toolbar button, or select the Horizontal/Acquisition Setup command from the Horiz/Acq menu to open the Horizontal/Acquisition Setup control window.
7. Open the Acquisition tab and select one of the following Sampling Modes:
 - Real Time. This sampling mode acquires all points in a waveform record after one trigger event. RT mode will switch to ET or IT mode, depending on the time-per-division setting and the number of channels acquiring data.
 - Interpolated. This mode interpolates between the samples the instrument acquires when it cannot acquire all the real samples it needs to fill up its waveform record.
 - Equivalent. This mode starts when the time base setting (horizontal scale) is too fast to let the instrument get enough samples with which to create a waveform record using real-time sampling. Equivalent time mode is intended for repetitive signals only.

Use fast acquisitions

To operate the instrument in Fast Acquisitions mode, set up the horizontal, vertical, and triggering controls, and then follow the procedure below.

1. Enable Fast Acquisitions mode:
 - a. In the Horiz/Acq menu, select Horizontal/Acquisition Setup.
 - b. Open the Acquisition tab.
 - c. Toggle the Fast Acq button to On, or push the front-panel FastAcq button.
 - d. Click an option button to optimize the capture of data to suite your measurement.
2. Set up the Display Appearance:
 - a. In the Display menu, select Display Setup.
 - b. Open the Appearance tab.
 - c. Click one of the Style buttons: Vectors, Dots, or Inten Samp. Vectors is the default.
 - d. For the display Persistence, click either Infinite, Variable, or Off. Off is the default, and erases the screen each time a new waveform array is displayed. For an explanation of Variable persistence, click [here](#).
 - e. If you specified Variable, click Time, and adjust the persistence time (decay rate) with the multipurpose knob.
3. Set the Display Readout Options:
 - a. Open the Display control window Objects tab.
 - b. Click the Display Date/Time button to toggle the date/time display On or Off.

4. Adjust the Intensity:
 - a. Open the Display control window Appearance tab.
 - b. Rotate the front-panel Intensity knob to adjust the intensity of displayed waveforms, or click in the Intensity FastAcq/WfmDB entry box and enter the intensity value with the keypad or multipurpose knob.
5. Select the Color Palette:
 - a. Open the Display control window Colors tab.
 - b. Click a color palette button in the Fast/Acq WfmDB Palette. In Fast Acquisitions mode, Temp and Spectral show more detail than the other color palettes.
 - c. For a definition of each color palette, click [here](#).

Display persistence

From the Display menu, select Display Setup; then open the Appearance tab.

To use

Click one of the buttons to select the display persistence.

- Click Infinite (persistence) to continuously accumulate record points on the waveform until you change one of the acquisition display settings.
- Click Variable; then click in the Time entry box and use the multipurpose knobs to set the persistence time.
- Click Reset to clear the persistence.
- Click Controls to activate the Persistence Control window.

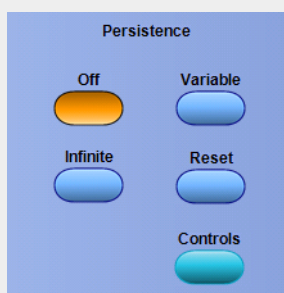

Behavior

- Use infinite persistence for displaying record points that may occur outside the normal acquisition envelope.
- Use Variable to accumulate record points on the waveform for a specified time interval. Each record point decays independently according to the time interval.
- If you click Off, the waveform record points appear for the current acquisition only.



TIP. Use the Display menu Display Persistence submenu or right-click in the graticule and select Display Persistence from the shortcut menu to directly access the persistence options.

View the analog characteristics of a digital signal

NOTE. iCapture is available only on MSO70000C/DX Series instruments and DPO70000DX Series instruments with option MSOU installed.

The iCapture function allows you to view the analog characteristics of signals connected to a digital channel. Additional measurement capabilities are available while viewing the analog characteristics of a signal. You can route up to four of the 16 digital inputs (D15-D0) and Clock/qualifier inputs to the analog channels through a logic probe using iCapture. When a logic channel is routed to an analog channel, the normal signal (analog input) is no longer visible.

To use iCapture, follow these steps:

1. From the Vertical menu, select Vertical Setup.
2. Press the Digital Input iCapture button.
3. Click the Digital Source box and select a signal connected to a digital channel to send through the analog input.
4. To set the voltage reference level thresholds of the channel for the instrument to use when converting an analog waveform to digital format to include in a bus, click the Digital Properties button.
5. To choose whether to share threshold settings or to have independent threshold settings, click in the Channel Settings box, and select Shared or Independent from the list.
6. For each threshold you want to change, click the channel threshold entry box, and use the keypad or multipurpose knobs to set the threshold level.
7. Click OK.

What do you want to do next?

[Learn about digital setups.](#)

[Learn about bus setups.](#)

[Learn about bus configuration.](#)

Acquiring digital signals

Set up digital channels

NOTE. *Acquiring digital signals is available only on MSO5000B and MSO7000C/DX Series instruments and DPO5000B Series instruments with option MSOE installed, and DPO7000DX instruments with option MSOU installed.*

You can set the voltage reference level threshold, position, and display size parameters for digital signal acquisition. To do so, follow these steps:

1. Connect the logic probe to the input signal source using proper probing and connecting techniques.
2. Click [here](#) for details on setting up the Digital input controls.
3. Use the multipurpose knob to change the vertical position of the waveform on the screen. Dragging the waveform handle also positions the waveform.
4. Use the Horizontal knobs to scale and position the waveform on the screen and to set the record length. Dragging the reference icon also positions the waveform.
5. Use the Resolution knob to set the record length and sample interval.

Displaying waveforms as a bus

Set up a bus

NOTE. Use of serial buses may require an option on your instrument.

You can set up parallel or serial buses. For both types of buses, follow these steps:

1. From the Digital or the Vertical menu, select Bus Setup.
2. Select the Select tab, scroll through the Bus list, and select the Bus <B1-B16> to configure.
3. To toggle the display of the bus on or off, click the Bus <B1-B16> button.
4. To change the default label of the bus, click the Label box, and use the keyboard to enter a new label.
5. To change the position of the bus in the display, click the Bus Position box, and use the keyboard or multipurpose knob to adjust the bus position.
6. Continue to set up specific parameters:

for a parallel bus

for an SPI Serial Bus

for an I2C bus

for a USB bus

for an RS-232 bus

for a MIPI CSI2 Serial Bus

for a MIPI DSI1 Serial Bus

for an 8B10B Serial Bus

Set up a parallel bus

First, *follow the common steps to set up any bus*. To continue to set up a parallel bus, follow these steps:

1. To define the bus type in the Bus Setup window, click Parallel as the Bus Type.
2. To add sources to the parallel bus, click the Add Sources Select button. The Bus Source Selection dialog appears.
3. In the Bus Source Selection dialog, click the button for each channel you want in the bus.
4. Click OK.
5. To move a channel within the parallel bus, scroll to and select the channel you want to move, and then click the up or down arrow buttons.
6. To remove a channel from the bus, scroll to and select the channel you want to remove, and then click the Remove button.
7. To set the voltage reference level thresholds, click the Thresholds Setup button.
8. Click the Channel Settings box, and select Shared or Independent. To set the thresholds to the same level for all the analog channels (Ch), select Shared.
9. Double-click a channel Threshold entry box, and use the keypad or multipurpose knobs to enter a threshold level.
10. To set the thresholds to the same level for all the analog, math and digital channels, click the Global Threshold entry box, and use the keypad or multipurpose knobs to enter the threshold level. Click Apply.
11. Click OK.
12. Click the Display tab, and *configure the bus display*.

Set up an SPI serial bus

First, [follow the common steps to set up any bus](#). To continue to set up an SPI serial bus, follow these steps:

1. To define the bus type in the Bus Setup window, click Serial as the Bus Type, and select SPI from the drop-down list.
2. To select the input for the displayed components of the bus, click on a component Input and select a channel from the cascading list.
3. To set an input voltage reference threshold level, double-click the Threshold entry box and use the keypad to enter the level.
4. To set the input polarity, click the Polarity entry box, and select Rising or Falling or Active Low or Active High from the drop-down lists.
5. To set the input word size, double-click the Word Size entry box, and use the keypad or multipurpose knobs to enter the size.
6. To set the input direction, click the Bit Order entry box, and select MS First or LS First from the drop-down list.
7. Click the Display tab, and [configure the bus display](#).

Set up an I2C serial bus

First, [follow the common steps to set up any bus](#). To continue to set up an I2C serial bus, follow these steps:

1. To define the bus type in the Bus Setup window, click Serial as the Bus Type, and select I2C from the drop-down list.
2. To select the input for the displayed components of the bus, click on the component Input and select a channel from the cascading list.
3. To set an input voltage reference threshold level, double-click the Threshold entry box and use the keypad to enter the level.
4. Click the Display tab, and [configure the bus display](#).

Set up an RS-232 serial bus

NOTE. This online help file supports many oscilloscope models from Tektronix. This feature is only available on some models.

First, [follow the common steps to set up any bus](#). To continue to set up an RS-232 serial bus, follow these steps:

1. To define the bus type in the Bus Setup window, click Serial as the Bus Type, and select RS-232 from the drop-down list.
2. To select the input for the displayed components of the bus, click on a component Input and select a channel from the cascading list.
3. To set an input voltage reference threshold level, double-click the Threshold entry box and use the keypad to enter the level.
4. To set the input polarity, click the Polarity entry box, and select Normal or Inverted from the drop-down lists.
5. To set the input data bits, double-click the Data Bits drop-down list, and select use the keypad or multipurpose knobs to enter the size.
6. To set the parity, click Parity entry box, and select None, Odd, or Even from the drop-down list.
7. To set the bit rate, click Bit Rate entry box, and select Custom, 50, 300, 1200, 2400, 9600, 19200, 38400, 115200, 921600, or 10000000 from the drop-down list.
8. Click the Display tab, and [configure the bus display](#).

Set up a USB serial bus

First, [follow the common steps to set up any bus](#). To continue to set up an USB serial bus, follow these steps:

1. To define the bus type in the Bus Setup window, click Serial as the Bus Type, and select USB from the drop-down list.
2. To select the input for the displayed components of the bus, click on a component Input and select a channel from the cascading list.

3. To set an input voltage reference threshold high level, double-click the Threshold (H) entry box and use the keypad to enter the level.
4. To set an input voltage reference threshold low level, double-click the Threshold (L) entry box and use the keypad to enter the level.
5. To set the speed, click the Speed entry box, and select Low (1.5 Mbps) or Full (12 Mbps) from the drop-down lists.
6. To set the signal type, click the Signal Type entry box, and select Differential or Single Ended from the drop-down list.
7. Click the Display tab, and [configure the bus display](#).

Set up a MIPI DSI-1 serial bus

First, [follow the common steps to set up any bus](#). To continue to set up a MIPI DSI-1 serial bus, follow these steps:

1. To define the bus type in the Bus Setup window, click Serial as the Bus Type, and select MIPI DSI-1 from the drop-down list.
2. To set the channel type, click the Channel Type entry box, and select Analog or Digital from the drop-down lists.
3. To select the input for the displayed components of the bus, click on a component Input and select a channel from the cascading list.
4. To set an input voltage reference threshold level, double-click the Threshold entry box and use the keypad to enter the level. Set the threshold on the low power portion of the waveform.
5. Click the Display tab, and [configure the bus display](#).

Set up a MIPI CSI-2 serial bus

First, [follow the common steps to set up any bus](#). To continue to set up a MIPI CSI-2 serial bus, follow these steps:

1. To define the bus type in the Bus Setup window, click Serial as the Bus Type, and select MIPI CSI-2 from the drop-down list.
2. To set the channel type, click the Channel Type entry box, and select Analog or Digital from the drop-down lists.
3. To select the input for the displayed components of the bus, click on a component Input and select a channel from the cascading list.
4. To set an input voltage reference threshold level, double-click the Threshold entry box and use the keypad to enter the level.
Set the thresholds for the low power data so no high speed data gets mistakenly decoded as low power. This typically means the threshold should be above the high speed levels. The high speed is a differential signal, so the decoder handles the subtraction of the two inputs and automatically applies a threshold of zero to the result.
5. Click the Display tab, and [configure the bus display](#).

Set up an 8B10B serial bus

First, [follow the common steps to set up any bus](#). To continue to set up an 8B10B serial bus, follow these steps:

1. To define the bus type in the Bus Setup window, click Serial as the Bus Type, and select 8B10B from the drop-down list.
2. To set the data rate, click the Data Rate entry box, and select the rate from the drop-down list.
3. To select the input for the displayed components of the bus, click the Input entry box, and select a channel from the cascading list.
4. To set an input voltage reference threshold level, double-click the Threshold entry box and use the keypad to enter the level.
5. To set an input hysteresis level, double-click the Hysteresis entry box and use the keypad to enter the level.
6. Click the Display tab, and [configure the bus display](#).

Set up a custom serial bus

First, [follow the common steps to set up any bus](#). To continue to set up a custom serial bus, follow these steps:

1. To define the bus type in the Bus Setup window, click Serial as the Bus Type, and select Custom from the drop-down list.
2. To select the custom decoder, click the Custom Decoder arrow, and select the custom decoder from the drop-down list.
3. To select the input for the displayed components of the bus, click on the component Input and select a channel from the cascading list.
4. To set an input voltage reference threshold level, double-click the Threshold entry box and use the keypad to enter the level.
5. Click the Display tab, and [configure the bus display](#).

Set up a PCIe serial bus

First, [follow the common steps to set up any bus](#). To continue to set up a PCIe serial bus, follow these steps:

1. To define the bus type in the Bus Setup window, click Serial as the Bus Type, and select PCIe from the drop-down list.
2. To select the data rate, click the Data Rate arrow, and select the rate from the drop-down list.
3. To select the input for the displayed components of the bus, click on the component Input and select a channel from the cascading list.
4. To set an input voltage reference threshold level, double-click the Threshold entry box and use the keypad to enter the level.
5. To set lane, double-click the Lane entry box and use the keypad to enter the lane.
6. Click the Display tab, and [configure the bus display](#).

Set up a CAN serial bus

First, [follow the common steps to set up any bus](#). To continue to set up a CAN serial bus, follow these steps:

1. To define the bus type in the Bus Setup window, click Serial as the Bus Type, and select CAN from the drop-down list.
2. To select the components, click Components and select a component from the drop-down list.
3. To select the input for the displayed components of the bus, click on the component Input and select a channel from the cascading list.
4. To set an input voltage reference threshold level, double-click the Threshold entry box and use the keypad to enter the level.
5. To select the bit rate, click the Bit Rate arrow, and select the rate from the drop-down list.
6. Click the Display tab, and [configure the bus display](#).

Set up a LIN serial bus

First, [follow the common steps to set up any bus](#). To continue to set up a LIN serial bus, follow these steps:

1. To define the bus type in the Bus Setup window, click Serial as the Bus Type, and select LIN from the drop-down list.
2. To select the input for the displayed components of the bus, click on the component Input and select a channel from the cascading list.
3. To set an input voltage reference threshold level, double-click the Threshold entry box and use the keypad to enter the level.
4. To select the polarity, click the Polarity arrow, and select the polarity from the drop-down list.
5. To select the LIN standard, click the LIN Standard arrow, and select the standard from the drop-down list.
6. To select the bit rate, click the Bit Rate arrow, and select the rate from the drop-down list.
7. Click the Display tab, and [configure the bus display](#).

Set up a FLEXRAY serial bus

First, [follow the common steps to set up any bus](#). To continue to set up an FLEXRAY serial bus, follow these steps:

1. To define the bus type in the Bus Setup window, click Serial as the Bus Type, and select FLEXRAY from the drop-down list.
2. To select the signal type, click the Signal Type arrow, and select the type from the drop-down list.
3. To select the input for the displayed components of the bus, click on the component Input and select a channel from the cascading list.
4. To set an input voltage reference threshold levels, double-click a Threshold entry box and use the keypad to enter the level.
5. To select the channel type, click the Channel Type arrow, and select the type from the drop-down list.
6. To select the bit rate, click the Bit Rate arrow, and select the rate from the drop-down list.
7. Click the Display tab, and [configure the bus display](#).

Set up a MIL-1553 serial bus

First, [follow the common steps to set up any bus](#). To continue to set up an MIL-1553 serial bus, follow these steps:

1. To define the bus type in the Bus Setup window, click Serial as the Bus Type, and select MIL-1553 from the drop-down list.
2. To select the input for the displayed components of the bus, click on the component Input and select a channel from the cascading list.
3. To set a threshold, double-click the Threshold entry boxes and use the keypad to enter the level.
4. To set a Response Time, double-click the Response Time entry boxes and use the keypad to enter the time.
5. To select the polarity, click Polarity, and select the rate from the drop-down list.
6. Click the Display tab, and [configure the bus display](#).

Set up an ethernet serial bus

First, [follow the common steps to set up any bus](#). To continue to set up an Ethernet serial bus, follow these steps:

1. To define the bus type in the Bus Setup window, click Serial as the Bus Type, and select Ethernet from the drop-down list.
2. To select the standard, click Standard, and select the standard from the drop-down list.
3. To set a Signal Type, click Signal Type and select the signal type from the drop-down list.
4. To select the input for the displayed components of the bus, click on the component Input and select a channel from the cascading list.
5. To set a threshold, double-click the Threshold entry boxes and use the keypad to enter the level.
6. Click the Display tab, and [configure the bus display](#).

Configuring the bus display

You can configure the bus components, and decoding of parallel and serial buses. To do so, follow these steps:

1. From the Bus Setup menu, click the Display tab, scroll through the Bus list, and select the bus to configure its display.
2. Click the desired display component for the bus: Waveform, Busform, or Both.
3. Click the desired display style for the decoding method: Hex or Binary.

NOTE. *Mixed, Decimal, and ASCII decoding methods are available for the USB serial bus type. ASCII and Packet View decoding methods are available for the RS-232 serial bus type. Mixed decoding methods like symbol for DT (Data Type MIPI element), decimal for VC (Virtual Channel MIPI element) and WC (Word Count MIPI element), and hexadecimal for all other fields are available for the MIPI DSI-1 serial bus type.*

4. If you also want the instrument to use a symbol table file for decoding, click the Use Symbol File check box, double-click the entry box, and click the Browse button to locate the file.

NOTE. This online help file supports many oscilloscope models from Tektronix. This feature is only available on some models.

NOTE. The symbol file must [follow a specific format](#), and reside in the C:\Users\[Username]\Tektronix\TekScope\BusDecodeTables directory for the instrument to locate the file, decode the bus, and display the symbols.

5. For some serial buses, such as for an I2C bus, you can choose to include an R or W in the displayed address.

Analyzing buses

Tracking down I2C serial bus anomalies

NOTE. This online help file supports many oscilloscope models from Tektronix. This feature is only available on some models.

You can use your oscilloscope, with its bus triggering and long-record length management features, to track down a problem in the physical layer and the protocol layer of a bus. To track down I²C bus anomalies, follow these steps:

1. Connect a probe between a Ch <1–4> input of the instrument and the SCLK signal of the I²C serial bus in your system under test.
2. Connect a second probe between one of the other Ch inputs of the instrument and the SDA data signal of the bus.
3. Push the Autoset front-panel button.
4. From the Digital menu, select Bus Setup.
5. Click Serial as the Bus Type and select I2C.
6. Click the Input box of the SCLK component and select the channel connected to the SCLK signal in step 1.
7. Double-click the Threshold entry box, and use the keypad or the multipurpose knobs to change the voltage reference threshold level.
8. Click the Input box of the SDA component and select the channel connected to the SDA signal in step 2.
9. Double-click the Threshold entry box, and use the keypad or the multipurpose knobs to change the level.
10. Click the Display tab and set the bus display parameters. The instrument acquires, decodes and displays data from the bus customized for you to more readily interpret and analyze activity on the bus.
11. From the Trig menu, select Bus Setup.
12. Click the Bus box and select the appropriate Bus setup <B1-B16> to acquire data from the I²C bus.
13. Click the Trigger On box , and select the bus cycle or activity for the instrument to use as the trigger.

For some Trigger On selections, you need to set additional fields to define other parameters such as for an Address. In this example, you need to set an Address Format, Address Value (click the Edit button), Data Direction, and Addressing Mode. Optionally, you can also set the component threshold levels through the Logic Thresholds Setup button.

14. Acquire data and analyze the physical layer. If an analog channel is displayed, you can use Cursors to take manual measurements or you can take automatic measurements.
15. Push the MultiView Zoom button and scroll to see all the events. Do you have all the packets that you expected to have? If not, at least you have narrowed your search down to the last packet sent.
16. Analyze the decoded packets in the protocol layer. Did your program send the data bytes in the correct order? Did you use the correct address?

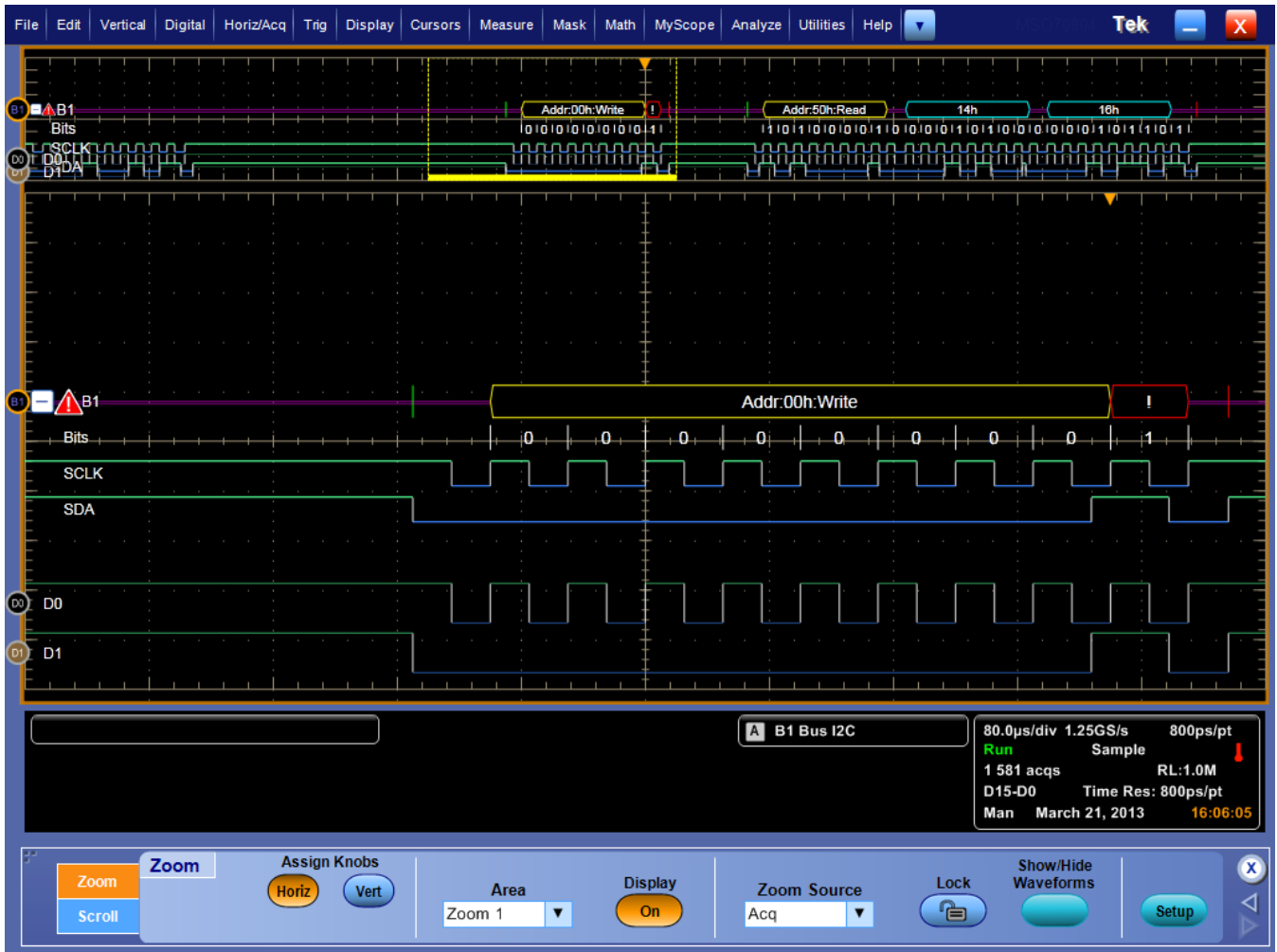

What do you want to do next?

[Learn about digital setups.](#)

[Learn about bus setups.](#)

[Learn about bus configuration.](#)

Troubleshooting circuits using a parallel bus

NOTE. This online help file supports many oscilloscope models from Tektronix. This feature is only available on some models.

You can use digital, analog, or math waveforms to create, monitor, and analyze a parallel bus with your instrument. The supported instruments let you see the on-off status of the signals and decodes the parallel bus signals for you.

1. Connect a logic probe to the logic probe port on the front panel.
2. Connect the logic probe tips for data to test points for signals of interest in your system under test. For parallel buses that include a clock signal, connect the Clock probe tip to a clock signal in your system under test.
3. From the File menu, select Recall Default Setup. Push the Ch1 1 button to remove the waveform from the display.
4. From the Digital menu, select Digital Setup.

5. Click the digital channel buttons for the channels you plan to use in your parallel bus. For a wider bus, click the other tab and select more digital channels. To remove a channel, click the channel button again.
6. From the Digital menu, select Bus Setup.
7. Click Parallel as the Bus Type.
8. Click the Add Sources Select button.
9. In the Bus Source Selection dialog, click the channels to use in the parallel bus. Click OK.
10. Arrange the channels in the desired bit order in the Bus Contains list of channels. To change the bit order of a channel in the bus, select the channel, and click the up or down arrows to move the channel to a more or a less significant bit position.
11. Click the Thresholds Setup button, double-click the Threshold entry box for each channel used, and use the keypad or the multipurpose knobs to change the voltage reference threshold level. You can also set all the thresholds to the same level with the Global Thresholds entry box. Click OK.
12. To include a clock signal, click the Clocked check box. Then, click the Clock Source box, select the appropriate channel from the drop-down list, and also select which edge to use in the Clock Polarity box: Rising, Falling, or Either.
13. Click the Display tab and set the bus display parameters. The instrument acquires, decodes and displays data from the bus customized for you to readily interpret and analyze activity on the bus.
14. To decode the parallel bus with a symbol table file, click the Use Symbol check box, and enter the full path to the file in the entry box or use the Browse button to locate the file. The file must reside on the instrument in the C:\Users\[Username] \Tektronix\TekScope\busDecodeTables directory.

Here is the symbol table file used in this troubleshooting example.

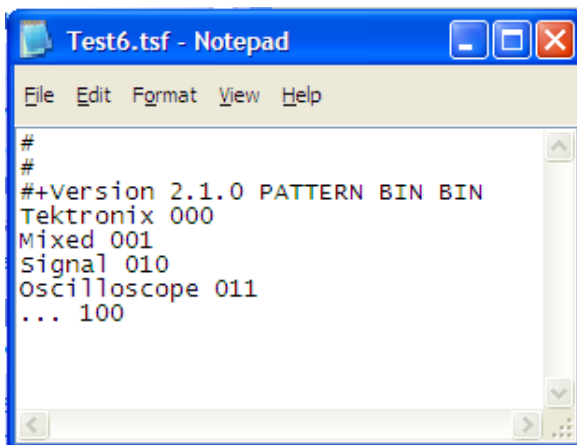

```

#
#
#+Version 2.1.0 PATTERN BIN BIN
Tektronix 000
Mixed 001
Signal 010
Oscilloscope 011
... 100

```

15. Acquire data and analyze the physical layer. If an analog channel is displayed, you can use Cursors to take manual measurements or you can take automatic measurements.
16. Turn the Horizontal Scale knob to adjust the time base.
As you increase the time per division, you will see more data appear in the Bus display.
17. From the Trig menu, select the Bus trigger type.
18. Click the Bus box and select the appropriate bus setup <B1-B16> to acquire data from the parallel bus.
19. Click the Trigger If Logic State Goes box , and select True or False.
20. Click the Edit button, select the Format as Binary, Hex, or Symbolic, and enter a bus pattern for the instrument to use as the trigger event. Click OK.

21. Acquire data from the parallel bus.
22. Push the MultiView Zoom front panel button, and scroll to the areas of interest to analyze the results.



What do you want to do next?

[Learn about digital setups.](#)

[Learn about bus setups.](#)

[Learn about bus configuration.](#)

[Learn about symbol tables for parallel buses.](#)

Troubleshooting an SPI serial bus

NOTE. This online help file supports many oscilloscope models from Tektronix. This feature is only available on some models.

There are various situations where you need to look at analog characteristics of a digital signal in a digital circuit. For example, you may want to analyze the signal integrity of a signal in a system under test, such as for an SPI serial bus.

You can use the supported instrument, with its 4 analog channels and 16 digital channels (plus a clock/qualifier) to track down the problem. It will even decode your SPI signals into ASCII characters.

To analyze the signal integrity of an SPI signal, you need to acquire and display the signal. Then, you will look at both the analog and digital representations of the signal. Finally, you will search through each SPI byte with the search and mark functions.

1. Connect a logic probe to the probe port on the front panel.
2. Connect the probe tip for D3 to a test point for the Data signal in your SPI system under test. It's convenient to use D3 because it matches the default channel assignment for the SPI bus setup.

NOTE. You can connect any digital channel to the SPI signals, as long as you also set the signals to map to the appropriate digital channel in the Bus Setup menu.

3. Connect D4 to a test point for the SCLK signal.
4. Connect D2 to a test point for the SS signal.
5. From the File menu, select Recall Default Setup.
6. Push the Ch 1 front-panel button to turn off the channel.
7. From the Digital menu, select Bus Setup.
8. Click an unused Bus from the list <B1-B16>.
9. Click the Bus On button.

NOTE. You can double-click the Label box and use the keypad to enter a name for the bus, and adjust the position of the bus on the screen. You can also click the bus handle and drag it to reposition the bus on screen.

10. Click Serial as the Bus Type.
11. Click the arrow and select SPI from the list of bus standards.
The default channel assignments are for the Data component to be acquired on D3, the SCLK component on D4, and the SS component on D2.
12. Click the Display tab and set the bus display parameters, such as to display a busform. The instrument acquires, decodes and displays data from the bus customized for you to readily interpret and analyze activity on the bus.
13. To decode the bus as ASCII characters, you can create a symbol file with ASCII and click the Use Symbol check box.
The file *must follow a specific format*, and reside in a specific directory where the instrument can locate and use the file. You can use the entry box to enter the path or browse to the file.
14. Turn the Horizontal Scale button to adjust the time base.
As you increase the time per division, you will see more data appear in the Bus display.
15. From the Trig menu, select Bus Setup.
16. Click the Bus box and select the appropriate bus <B1-B16> from which to acquire, decode, and display data.
17. Click the Trigger On box, and select an SPI trigger: SS Active or Data.
18. For Data, click the Edit button, select the Format as Binary, or Hex to use. Enter a bus pattern for the instrument to use as the trigger event. Click OK.

19. Acquire data from the serial bus.
20. Push the MultiView Zoom front panel button, and scroll to the areas of interest to analyze the results.

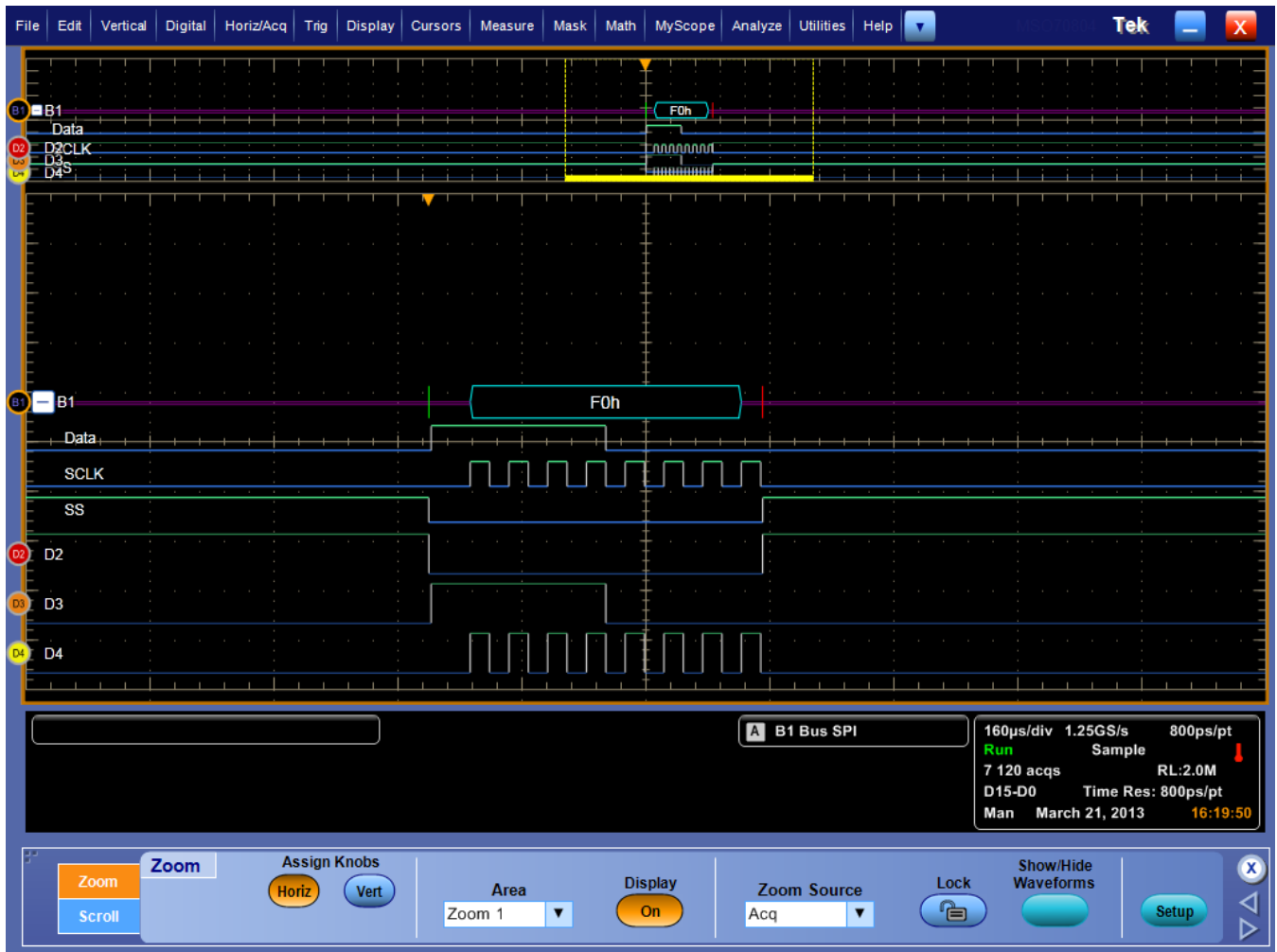

What do you want to do next?

[Learn about digital setups.](#)

[Learn about bus setups.](#)

[Learn about bus configuration.](#)

Creating and using MyScope control windows

Creating MyScope control windows

Use this procedure to create your own control windows:

1. From the MyScope menu, select New Control Window.
2. Click on the (+) to expand a control group and see the available controls within that group.
3. Click on a selection to see the control in the preview window.
4. Clear the check boxes for any controls that you do not want to appear. Most controls show all check boxes selected by default.
5. Drag the customized control to your MyScope control window. You can also move a control after it has been placed in the new control window by dragging it.
6. To remove the control from the custom control window select it, and then click the Delete button.
7. Click New Tab to add up to eight tabs.
8. Click the Rename Tab to create a unique name for each tab in your control window.
9. Click the User Pre button, and then select the user preferences you want to apply to this control window.
10. By default, the preferences are the same as what is currently set on your instrument. The preferences you set from the MyScope Setup window only apply to your MyScope control window. The preferences will take effect when the MyScope control window is activated.
11. Click Save or Save As to save your MyScope control window.
12. Enter a unique name for your MyScope control window and click Save. (This name will display in the upper-right corner of the control window when you open it.) The default location to save MyScope files is `C:\Users\[Username]\Tektronix\TekScope\MyScope`.
13. From the MyScope menu, click Open Control Window....
14. Select the MyScope control window that you want from the Open MyScope Control Window dialog box, then and click Open.

Editing MyScope control windows

Use the following procedure to edit previously defined MyScope control windows.

1. From the MyScope menu, select Edit Control Window.
2. Select the MyScope control window that you want to edit from the Edit MyScope Control Window dialog box. The control window you selected opens in the MyScope Setup control window.
3. Edit the control window using the same procedures as you did to create the control window.
4. Click Save to save your changes to this control window.
5. Click Save As to save your changes as a different control window. Enter a unique name for your MyScope control window, and click Save. The default location to save MyScope files is `C:\Users\[Username]\Tektronix\TekScope\MyScope`.

Creating MyScope control windows

Use this procedure to create your own control windows:

1. From the MyScope menu, select New Control Window.
2. Click on the (+) to expand a control group and see the available controls within that group.

3. Click on a selection to see the control in the preview window.
4. Clear the check boxes for any controls that you do not want to appear. Most controls show all check boxes selected by default.
5. Drag the customized control to your MyScope control window. You can also move a control after it has been placed in the new control window by dragging it.
6. To remove the control from the custom control window select it, and then click the Delete button.
7. Click New Tab to add up to eight tabs.
8. Click the Rename Tab to create a unique name for each tab in your control window.
9. Click the User Pre button, and then select the user preferences you want to apply to this control window.
10. By default, the preferences are the same as what is currently set on your instrument. The preferences you set from the MyScope Setup window only apply to your MyScope control window. The preferences will take effect when the MyScope control window is activated.
11. Click Save or Save As to save your MyScope control window.
12. Enter a unique name for your MyScope control window and click Save. (This name will display in the upper right corner of the control window when you open it.) The default location to save MyScope files is `C:\Users\[Username]\Tektronix\TekScope\MyScope`.
13. From the MyScope menu, click Open Control Window.
14. Select the MyScope control window that you want from the Open MyScope Control Window dialog box, and then click Open.

Taking measurements

Select cursor sources

Use the following procedure to set up cursors on a source waveform.

1. Display the waveform(s) to be measured on the screen.
2. Push the CURSORS front-panel button, or click Cursors on the toolbar to open the Cursor Controls window.
3. In the Cursor Controls window, click the Setup button.
4. Click a Cursor Type button. See Cursor Types for an explanation of the cursor types.
5. Select a Cursor Source from the Source drop-down list.

NOTE. *If you are using H Bars or V Bars there is only one source for both Cursor 1 and 2. If you are using Waveform or Screen cursors, select a source for both Cursor 1 and 2. If a waveform is not available, it appears shaded in the drop-down list.*



6. To change the position of a cursor, use the multipurpose knobs, enter a numeric value in the X and or Y Position entry boxes, or click and drag the cursors to a new position.
7. Select a cursor Track Mode:
 - Indep. Makes each cursor moveable without regard to the position of the other cursor.
 - Tracking. Makes both cursors move in unison and maintain a fixed horizontal or vertical distance between each other.

8. To turn the display of the cursors on or off, push the front-panel Cursor button.
9. For waveform or screen cursors, set the cursor style by selecting one of the following from the list:
 - Lines. Displays the intersection of horizontal and vertical lines. Lines are the default style for Screen cursors.
 - Line & X. Displays the horizontal position as a vertical line; the Y-axis is displayed as an X.
 - X. Displays the horizontal and vertical position as a single X.

Cursor Types

Because cursor measurements give immediate feedback on the amplitude or time values they measure, they are usually quick to take and are more accurate than graticule measurements. Also, since you can position cursors wherever you want them on the waveform, they are easier to localize to a waveform segment or feature than automatic measurements.

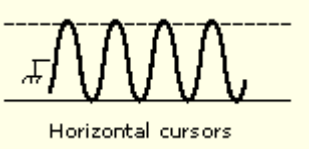
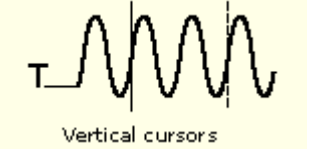
The following table defines the cursor types.

| Cursor function | Measurements |
|--|---|
|  <p style="text-align: center;">Horizontal cursors</p> | <p>Horizontal cursors measure vertical parameters (amplitude) in volts, watts, or IRE. The cursor readouts are defined as: $V1 = \text{Level @ Cursor 1 with respect to its source ground level.}$ $V2 = \text{Level @ Cursor 2 with respect to its source ground level.}$ $\Delta V = \text{Level @ Cursor 2 - Level @ Cursor 1.}$ Level is cursor displacement from the source ground multiplied by the source in volts/div. The two cursors may have different sources and therefore can have different volts/div settings.</p> |
|  <p style="text-align: center;">Vertical cursors</p> | <p>Vertical cursors measure horizontal parameters. Typically the horizontal parameters are in time or frequency, but depend on the units you select. The cursor readouts are defined as: $T1 = \text{Time @ Cursor 1 with respect to the trigger point}$ $T2 = \text{Time @ Cursor 2 with respect to the trigger point}$ $\Delta T = \text{Time @ Cursor 2 - Time @ Cursor 1}$ Time is divisions of displacement of the cursor from its source trigger point multiplied by the source in time/div.</p> |
|  <p style="text-align: center;">Waveform and Screen</p> | <p>Waveform cursors measure vertical parameters (typically volts) and horizontal parameters (typically time or frequency) simultaneously. Each cursor is, in effect, both a vertical and horizontal cursor. These paired cursors cannot be moved off of the waveform. The two cursors can have a different source. Use screen cursors to indicate an arbitrary X and Y position in the waveform display area represented by the intersection of a vertical and horizontal cursor line. Screen cursors measure both vertical parameters (typically volts) and horizontal parameters (typically time or frequency).</p> |

Taking cursor measurements

Use the following procedure to take measurements with cursors:

1. To open the Cursor Controls window, press the Cursors button on the front panel, click Cursors on the toolbar, or select Cursor Setup from the Cursors menu.

NOTE. If cursors are on but the readouts are not attached to the cursor controls, press the Cursors button to attach the readouts to the cursor controls. Press the Cursors button again to turn the cursors off.

2. Select the waveform you want to measure and a *Cursor Type* from the control window.
3. Position the cursors with the multipurpose knobs.
4. Read the cursor information from the on-screen Position controls.



TIP. Select the cursor mode (*Tracking or Independent*) in the Cursor Setup control window.

NOTE. Cursor measurements are not available on digital channels.

Taking automatic measurements

Use the following procedures to quickly take a measurement based on the default settings for High and Low reference levels. The instrument must be installed and operating, with a signal connected to an input channel, and the horizontal and vertical controls and triggering set up.

1. Obtain a stable display of the waveform to be measured.
2. From the toolbar, click Measure to open the Measurement Setup control window.
3. Click the appropriate waveform button for the Channels <1– 4> and Ch, Math, or Ref Source tab.
4. Select the tab on the Measurement Setup control window that contains the measurement you want to take:
 - Ampl
 - Time
 - More
 - Histog
 - Comm
5. Click a button for the Measurements type.

The readout for the measurement and associated statistics is automatically displayed, and the measurement is added to the Measurements list in the control window.

NOTE. In roll mode, measurements are not available until after you stop acquisitions.

NOTE. Automatic measurements are not available on digital channels.

Remove a measurement.

1. To remove the measurement, click Clear Selected.
 - The last measurement on the list is removed.
 - To remove any measurement, click the name on the Measurements list to highlight the measurement, and then click Clear.
 - You can click and drag to select and clear several measurements.
 - Toggle the display of measurements on the graticule by clicking the Display button On and Off.

Display measurement statistics.

1. From any tab on the Measurement Setup control window, click Statistics to open the Measurement Statistics control window.
2. From the Measurement Statistics control window you can select from the following options:
 - Off. Turns off the display of measurement statistics.
 - Mean. Displays the mean of measurements.
 - All. Displays the Mean, Min, Max, Standard Deviation, and Population measurements.
3. To set the number of measurements included in the measurement statistics, click Weight n=, and use the multipurpose knobs or pop-up keypad to set the weighting.

Set measurement reference levels.

1. From the toolbar, click Measure to open the Measurement Setup control window.
2. From any tab on the Measurement Setup control window, click Ref Levs to open the Reference Levels Setup control window.
3. To set how the instrument determines the base and top of the waveform, click Determine Base Top From:
 - Min-Max. Uses the highest and lowest values of the waveform record. (See [Automatic Measurements High/Low Method](#) for more information.)
 - Histogram. Select the most common values above or below the midpoint. (See [Automatic Measurements High/Low Method](#) for more information.)
4. To select the reference level units, click Units:
 - Absolute. Sets the units to absolute values in user units.
 - Percentage. Sets the units as a percentage of the High/Low range.
5. To set the reference levels, click on these controls and use the multipurpose knob or pop-up keypad to set:
 - High Ref. Defines the high reference level. The default level is 90%.
 - Mid Ref. Defines the middle reference level. The default level is 50%.
 - Low Ref. Defines the low reference level. The default level is 10%.
 - Mid2 Ref. Defines the middle reference used on the second waveform specified in delay or phase measurements; the default level is 50%.

Take automatic measurements

Use the following procedures to take automatic measurements.

NOTE. This procedure assumes you are using the default reference levels.

1. Open the Measurement Setup control window by clicking Measure on the toolbar or by clicking Measurement Setup on the Measure menu.
2. Select the source waveform using the [Channels Selector](#), or press one of the front-panel buttons.
3. Select the desired measurements from the measurement tabs. Each measurement is automatically added to the measurement list.

The measurement is added to the display in the same color as the selected channel waveform.

NOTE. If the waveform is clipped by the edge of the graticule, the measurement readout will display question marks.



TIP. You can select an automatic measurement from the menu bar Measure menu by selecting the measurement type (for example, Amplitude) and clicking the measurement. The measurement is taken on the currently selected waveform.

Localize a measurement

Use the following procedure to take a measurement over a segment of the waveform:

1. The instrument must be installed and operating, with a signal connected to an input channel, and horizontal and vertical controls and triggering set up.
2. Obtain a stable display of the waveform to be measured.
3. From the toolbar, click Measure to open the Measurement Setup control window.
4. Under Setups, click Gating from any tab. The Measurement Gating control window opens.
5. To select how to define the gated area, click one of the following:
 - Cursor. Sets the gated area to the area between the cursors. Use the multipurpose knobs to adjust the cursors on screen.
 - Zoom (1–4). Sets the gated area to the waveform area contained in the Zoom (1–4) area.
 - Off. Turns off measurement gating. You can also turn gating off from the Zoom shortcut menu.
6. If you selected Cursor, you must also select the Track Mode:
 - Indep. This mode lets you move one cursor at a time using the multipurpose knobs.
 - Tracking. This mode allows you to move both cursors at the same time. The cursors track one another; moving one cursor moves the other cursor in tandem.

Save measurements

Use this procedure to save measurements to a spreadsheet or text format:

1. Measurements that you want to save must be selected.
2. From the File menu select Save or Save As. Under Save What, click Measurement.
3. Click the Options button to open the Measurement Save Options dialog box.
4. Select the Measurement Format from the drop-down list.
5. Click OK to save the measurement options, or click Cancel to close the dialog box without saving the changes.
6. To save the measurements to a file, select the location to save from the Save in drop-down list. The default location is c : \Users\[Username]\Tektronix\TekScope\data.

7. Use the default name for your file, type a unique name into the Name text box, or select an existing name from the Name list (data in the existing file will be overwritten). You can also select the Auto-increment file name check box to save a series of files without typing in a new name each time.
8. Select the file type from the Save as type drop-down list; this is the same as the Measurement format that you selected in the Options dialog box.
 - Use .cvs for spreadsheets.
 - Use .txt for text.

NOTE. Changing the file type here will also change the selected format in the Option dialog.

9. Click Save.

Creating and using math waveforms

Using math waveforms

Use the same techniques to work with math waveforms that you use with channel waveforms. This procedure demonstrates some common operations that you can perform on math waveforms:

NOTE. Math calculations are not available on digital channels.

NOTE. Each math waveform you create derives its horizontal scale and position from the sources you include in its math expression. You can adjust these controls for the source waveforms, and your adjustments are reflected in the math waveform.

You can also magnify math waveforms using MultiZoom, and use the mouse for positioning.

Prerequisites. A math waveform must be defined and displayed.

Create a math waveform

Use the following procedure to create a math waveform. Ensure that the sources, waveforms, and measurement scalars you will use are present. The sources do not have to be displayed.

1. From the toolbar, click the Math button to open the Math Setup control window.
2. Select the Math tab for the math waveform you want to create; then click Display Off/On to toggle it on.



TIP. If the waveform that you select already exists, its math expression appears in the window. You can still use the waveform by clicking Clear, which discards the previous math expression. You may also want to select another waveform.

3. Click one of the Predefined Functions buttons to use a predefined math expression, or click Editor to access the Math Equation Editor.
4. Use the Math Equation Editor control window to define a math expression. See Creating Math Waveforms for examples, and use the following guidelines:
 - Math definitions are not implemented if the sources are not valid.
 - Use the Bksp (backspace) button to remove the last entry; click Clear to remove the entire expression and start over.
 - Use parentheses to group terms in the expression to control execution order, for example, 5(Ch1 + Ch2).
5. Select the Time, Spectral, Var, Meas, or Filter tabs to display the available functions.
6. Click a Primitive button to enter the function in the math expression. Click an operand button (+, -, *, /) to insert an operand.
7. Use the Home and arrow buttons to move within the math expression. Use the Bksp (backspace) button to delete portions of the expression.
8. Click Apply to apply your new math expression to the math waveform.
9. Click Avgs to open the Math Averaging control window. The controls in the window apply to the math waveform defined by the expression.
10. Click in one of the Math <1-4> n = entry boxes, and then set the number of averages using the multipurpose knobs or pop-up keypad. This number of averages affect math waveforms if the Avg() function is used.
11. Once you have defined the math expression, click Apply in the Math Setup or Math Equation Editor windows.

Creating math waveforms

You create math waveforms when you create a math expression. You do so by applying numerical constants, math operators and functions to operands. You can display and manipulate these derived math waveforms much like you can the channel and reference waveforms (see [Using Math Waveforms](#)).

Some examples of typical math waveforms follow:

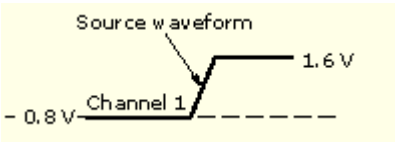
| Math waveform operations | |
|-----------------------------|--|
| To normalize this waveform: |  |
| Enter this math expression: | (Ch1- Meas1)/ Meas2, where Ch1 is the waveform shown at left Meas1 = Low of Ch1 Meas2 = amplitude of Ch1 |

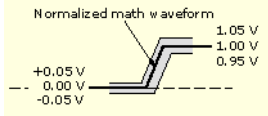
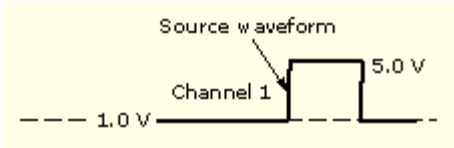
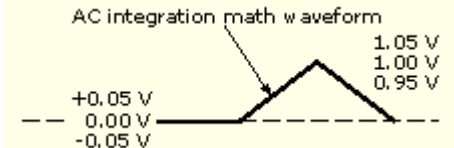
| Math waveform operations | |
|---|---|
| And get this math waveform: |  <p>Normalized math waveform</p> <p>1.05 V 1.00 V 0.95 V 0.00 V -0.05 V</p> |
| To simulate AC coupling on this waveform: |  <p>Source waveform</p> <p>Channel 1</p> <p>5.0 V 1.0 V</p> |
| Enter this expression: | Intg(Ch1-Avg(Ch1)), where Ch1 is the waveform shown at left Avg is the average function |
| And get this math waveform: |  <p>AC integration math waveform</p> <p>1.05 V 1.00 V 0.95 V 0.00 V -0.05 V</p> |

Offset, position, and scale

The settings that you make for offset, scale, and position affect the math waveform you obtain. Here are some tips for obtaining a good display:

- Scale and position the source waveform so that it is contained on the screen. (Off-screen waveforms may be clipped, resulting in errors in the derivative waveform.)
- Use vertical position and vertical offset to position your source waveform. The vertical position and offset will not affect your derivative waveform unless you position the source waveform off screen so that it is clipped.

Select and display a waveform.

1. Click the Math toolbar button to open the Math Setup control window.
2. Select the tab for the math waveform that you want to work with.
 - If the waveform you select is not defined, use the Create a Math Waveform procedure to define the math waveform.
 - If the waveform is not displayed, click Display.

Set scale and position.

1. Click in the Position and Scale entry boxes and use the multipurpose knobs or pop-up keypad to size and position the waveform on the screen.

Keep in mind the following:

- The position is in divisions, so changing the scale can make the math waveform disappear until position is also changed (the same effect happens with channel waveforms).
- You can click and drag a waveform handle to change the waveform vertical position.
- You can change the waveform vertical position and scale by clicking on the waveform handle and using the multipurpose knobs to adjust.
- You cannot adjust the offset of a math waveform.
- You cannot adjust horizontal scale, position, and sample density (resolution) of math waveforms; different length source waveforms result in a math waveform of the shortest source record length. If you adjust these settings for sources of a math waveform, the adjustments are reflected in the math waveform.

Take an automatic measurement.

1. Click the Measure toolbar button to open the Measurement Setup control window.
2. Select the Channels Math tab, and click a channel button to choose a math waveform.
3. Select a Measurements type (for more information, see [Taking Automatic Measurements](#)).
4. To display the measurement, click Display to toggle it to on.

NOTE. Automatic measurements are not available on digital channels.

Take a cursor measurement.

1. Click the Cursor toolbar button to display the cursors and open the Cursor Controls window.
2. Select the cursor type by clicking either H Bars, V Bars, Screen, or Waveform (for more information, see [Taking Cursor Measurements](#)).
3. Use the multipurpose knobs to position each cursor on the math waveform to measure the feature that interests you.
4. Read the results in the cursor readout. The cursor readout is displayed under the multipurpose readouts or in the upper right corner of the graticule area.

NOTE. Cursor measurements are not available on digital channels.

NOTE. The amplitude measurements on a derivative waveform are in volts-per-second, and volt-seconds for an integral waveform measurement.

Create a math waveform using predefined expressions

Use the following steps to create math waveforms using predefined expressions:

1. Open the Math Control window by clicking Math on the toolbar or by clicking Math Setup in the Math window.
2. Select a Math waveform by clicking one of the tabs in the control window.

- Click one of the Predefined Expression buttons in the control window. The predefined expression is added to the math expression at the top of the control window and the math waveform appears on the screen.



TIP. You can select Predefined Expressions directly from the Math menu.

Create a math waveform with the equation editor

Use the following steps to create math waveforms using the Equation Editor:

- Open the Math Setup control window by clicking Math on the toolbar, or by selecting Math Setup in the Math menu.
- In the Math Setup control window, click the Editor button to open the Math Equation Editor.
- Select a Math waveform from the drop-down list.
- Select a math function by clicking a button under the tabs on the left side of the Equation Editor (for example, click Derivative).
- Select a valid waveform to use as an operand from the [Channels Selector](#).
- Use other buttons in the Equation Editor as necessary to create the math expression for the math waveform.
- Click OK to create and display the math waveform.

Create a math waveform

Use the following procedure to create a math waveform. Ensure that the sources, waveforms, and measurement scalars you will use are present. The sources do not have to be displayed.

- From the toolbar, click the Math button to open the Math Setup control window.
- Select the Math tab for the math waveform you want to create; then click Display Off/On to toggle it on.



TIP. If the waveform that you select already exists, its math expression appears in the window. You can still use the waveform by clicking Clear, which discards the previous math expression. You may also want to select another waveform.

- Click one of the Predefined Functions buttons to use a predefined math expression, or click Editor to access the Math Equation Editor.
- Use the Math Equation Editor control window to define a math expression. See [Creating Math Waveforms](#) for examples, and use the following guidelines:
 - Math definitions are not implemented if the sources are not valid.
 - Use the Bksp (backspace) button to remove the last entry; click Clear to remove the entire expression and start over.
 - Use parentheses to group terms in the expression to control execution order, for example, 5(Ch1 + Ch2).
- Select the Time, Spectral, Var, Meas, or Filter tabs to display the available functions.
- Click a Primitive button to enter the function in the math expression. Click an operand button (+, -, *, /) to insert an operand.
- Use the Home and arrow buttons to move within the math expression. Use the Bksp (backspace) button to delete portions of the expression.
- Click Apply to apply your new math expression to the math waveform.
- Click Avgs to open the Math Averaging control window. The controls in the window apply to the math waveform defined by the expression.

10. Click in one of the Math $\langle 1-4 \rangle n =$ entry boxes, and then set the number of averages using the multipurpose knobs or pop-up keypad. This number of averages affect math waveforms if the Avg() function is used.
11. Once you have defined the math expression, click Apply in the Math Setup or Math Equation Editor windows.

Using mask and limit testing

Set up mask testing

Use the following procedure to set up the instrument to perform mask testing.

1. Connect the instrument to the source signal or save the source signal to a math or reference waveform memory location.
2. Access the mask setup window:
 - a. From the toolbar, click Masks to display the Mask Testing control window.
 - b. From the Source/Tolerance tab select the channel, math, or reference tab, and then select the waveform to use as the mask test source. You can only mask test one waveform at a time.
3. Specify the mask Type:
 - a. Open the Masks tab.
 - b. Click the appropriate button in the Type field.
 - c. Click the More button to display further selections.

NOTE. This window lists the mask types and standards available on your instrument. Industry standard masks are available. You must install the [Serial Communications Mask Testing Option](#) on some instruments before you can access the Comm triggers.



TIP. Selecting a mask type and standard adjusts the instrument horizontal, vertical, and trigger settings to those appropriate for displaying a waveform of the specified type. If the signal is not found within the mask, do the following:

- Click the Autoset button to center the waveform in the mask.
 - If Autoset did not align the signal within the mask, adjust the instrument vertical and horizontal controls.
 - If you clicked the Autoset button and the Autoset Undo preference is On, the instrument will display an Autoset Undo window. Click the Undo button to return to the previous settings, or click the X icon to remove the window.
4. Select a standard from the drop-down list to specify the mask standard.
 5. Specify the display parameters:
 - a. In the Masks tab, click the Display button to toggle mask display on or off. The mask must be turned on to do mask testing.
 - b. Click the Hit Count button to turn on or off hit counting. The hit count is shown in the Pass/Fail Results tab.
 - c. Click the Display Config button to set mask hit highlighting and to lock the mask to the waveform. Lock Mask to Wfm (Waveform) resizes the mask to reflect changes in the horizontal or vertical settings of the instrument.
 6. Autoset the signal:

- a. In the Masks tab, click the Autoset button to have the instrument automatically adjust instrument settings to align the waveform to the mask based on the characteristics of the input signal. Autoset is performed on the first waveform acquired after clicking the Autoset button.

NOTE. If the Autoset Undo preference is On, the instrument will display an Autoset Undo window allowing you to :

- Click the Undo button to return to the previous settings.
- Click the X icon to remove the window.

NOTE. Selecting the AutosetConfig button opens the Mask Configuration - Autoset window that lets you do :

- Set the vertical, horizontal, and trigger autoset parameters.
- Activate autofit or autoset.
- Select the autoset mode.
- Return to the default autoset configuration.
- Return to the Mask Setup control window.

7. Enable and set the waveform autofit parameters:

- a. In the Masks tab, click the Autofit button to enable the waveform autofit function.

Autofit checks each waveform for any mask hits. If there are hits, autofit repositions the waveform to minimize hits. The number of hits reported is the number after autofit has minimized hits.

The autofit Config button lets you do the following:

- Set the autofit maximum waveform repositioning parameters (as a percentage of the horizontal and vertical divisions).
- Return to default settings.
- Return to the Mask Setup control window.
- Change the vertical or horizontal autofit parameters.

8. Click the Masks button to return to the Mask Testing control window.

9. Set the mask test tolerance margins:

- a. From the Source/Tolerance tab, you can set the percentage of margin used in the mask test. Click in the Margins entry box and use the multipurpose knob, pop-up keypad, or the up/down arrow buttons to enter the mask margin tolerance percentage. The range of values is -50% to 50%

NOTE. Margin tolerance settings greater than 0% expand the size of the segments, making the mask test harder to pass; margin tolerance settings less than 0% (negative percent) reduces the size of the segments, making the mask test easier to pass.

10. Set the Mask test pass and fail parameters:
 - a. Open the Pass/Fail Setup tab of the Masks Testing control window.
 - b. Use the control knob, keypad, or pop-up keypad to enter the number of waveforms to test (number of samples in some modes), the failure threshold (the number of waveforms that must fail to fail the test), and the delay time (the time from when mask test starts to when the instrument begins sampling).
 - c. Click the Test Fail Notification buttons to set up what the instrument does when a mask test fails:
 - Initiate an instrument beep (BEEP).
 - Send an e-mail (E-mail).
 - Save Wfm. This saves the waveform data of the first waveform that causes the test to fail to a .wfm file.
 - Log Date. This saves the time, date, and basic test information of the first waveform that causes the test to fail to an ASCII text (.txt) file.
 - Stop the signal acquisition immediately (Stop Acq).
 - Send the instrument screen image to a printer (Print).
 - Send an SRQ on the GPIB bus (SRQ).

NOTE. Files are saved to the location specified by the Path button. The file name format is YYMMDD-HHMMSS, where YY is year, MM is month, DD is day, HH is hour, MM is minutes, and SS is seconds. You may also need to select a sound source to enable the BEEP. See [Select the sound source for more information](#).

11. Use the Test Pass Notification buttons to set what the instrument does at the successful completion of a mask test.
12. Use the Polarity buttons to set mask and waveform polarity. Positive tests the positive waveform pulses. Negative inverts the mask and tests the negative waveform pulses. Both test the first half of the waveforms in positive polarity mode, and then test the remaining waveforms in negative polarity mode.
13. Toggle the Repeat button to On to set the instrument to repeat (continue) mask testing on the completion of each test.

Create a new user mask

Use following procedure to create a new user mask that is not based on an existing mask:

1. Use the communications trigger features to trigger the instrument on a signal. The instrument saves these settings with the mask information.
2. From the toolbar, click Masks.
3. In the Mask Testing control window, open the Masks tab.
4. Click the User Mask button.
5. In the User-Defined Mask drop-down list, select None.
6. Click the Copy Current Mask To user Mask button. If you are asked if you want to overwrite the current user mask, click the Yes button.
7. Click the Edit User Mask button to display the user Mask Edit functions.
8. Click in the Segment entry box and use the up/down arrows, multipurpose knob, or keypad to enter or select segment 1.
9. Click the Vertex Add button. The instrument draws the default new segment shape, a triangle.
10. Use the instructions on Editing a User Mask, starting at step 5 to edit a segment.
11. Repeat steps 9 through 11, selecting an unused and sequential segment number, to create and edit more segments.
12. See Saving a User Mask to Disk procedure.

NOTE. You do not need to save an edited user mask to disk; the instrument retains the current user mask in nonvolatile memory.

If you plan to create a number of user masks, store your user masks on disk or the hard drive. The instrument can only load one user mask at a time.

Edit a user defined mask

1. From the toolbar, click Masks.
2. In the Mask Testing control window, open the Masks tab.
3. Click the User Mask button.
4. Click the Edit User Mask button. The instrument displays the Mask Edit control window.
5. Click the Controls button to open the Mask Edit control window.
6. Click in the Segment entry box and use the up/down arrows, multipurpose knob, or keypad to select a segment to edit. The selected (active) segment is highlighted in red. Each mask can have up to 16 segments.
7. Click in the Vertex entry box, and use the up/down arrows, multipurpose knob, or keypad to select the vertex to edit. The active vertex is indicated with an X on the template segment. Each segment can have up to 50 vertices.
8. Click in the Horizontal entry box, and then use the multipurpose knob or keypad to change the selected vertex horizontal position.
9. Click in the Vertical entry box, and then use the multipurpose knob or keypad to change the selected vertex vertical position.
10. To add a vertex, select the closest vertex that is clockwise from where you want to place a new vertex. Click Add to add a vertex midway between the selected vertex and the next counterclockwise vertex.
11. To delete a vertex, enter or select the vertex number; then click Del. The remaining vertices located counterclockwise from the deleted vertex are renumbered.
12. See Saving a User Mask to Disk procedure.

NOTE. You do not need to save an edited user mask to disk; the instrument retains the current user mask in nonvolatile memory.

If you plan to create a number of user masks, store your user masks on disk or the hard drive. The instrument can only load one user mask at a time.

Save a user mask to disk

1. From Mask menu, select Mask Edit Setup.
2. In the Mask Edit control window, click the Save button to open the Save As dialog box.
3. Specify the save location in the Save in drop-down list box.
4. In the Name field, enter the mask name; (*.msk) is the default save type for User Mask Files.
5. Click Save to save the mask to specified location on disk.

Create a user mask from a defined mask

NOTE. Refer to [Mask key points](#) before creating or editing a mask.

Use the following procedure to create a user mask from a defined mask:

1. From the toolbar, click Masks.
2. In the Mask Testing control window, open the Masks tab.

3. Click the appropriate button in the Type field to select a mask type.
4. Click the More button to display further selections.

NOTE. Industry standard masks are available with the Mask Testing feature. The Comm Trigger is designed to work with communications mask and standard testing. Mask testing automatically uses Communication triggers. You must install the Serial Communications Mask Testing Option on some instruments before you can access the Comm triggers.

5. Select a standard from the drop-down list. The control window lists mask types and standards that are available on your instrument.
6. Click the User Mask button.
7. Click the Copy Current Mask To user Mask button. The instrument copies the current mask to the user mask memory.
8. See the [Editing User Mask procedure](#).
9. See [Saving a User Mask to Disk](#) procedure.

NOTE. You do not need to save an edited user mask to disk; the instrument retains the current user mask in nonvolatile memory.

If you plan to create a number of user masks, store your user masks on disk or the hard drive. The instrument can only load one user mask at a time.

Edit a user defined mask

1. From the toolbar, click Masks.
2. In the Mask Testing control window, open the Masks tab.
3. Click the User Mask button.
4. Click the Edit User Mask button. The instrument displays the Mask Edit control window.
5. Click the Controls button to open the Mask Edit control window.
6. Click in the Segment entry box and use the up/down arrows, multipurpose knob, or keypad to select a segment to edit. The selected (active) segment is highlighted in red. Each mask can have up to 16 segments.
7. Click in the Vertex entry box, and use the up/down arrows, multipurpose knob, or keypad to select the vertex to edit. The active vertex is indicated with an X on the template segment. Each segment can have up to 50 vertices.
8. Click in the Horizontal entry box, and then use the multipurpose knob or keypad to change the selected vertex horizontal position.
9. Click in the Vertical entry box, and then use the multipurpose knob or keypad to change the selected vertex vertical position.
10. To add a vertex, select the closest vertex that is clockwise from where you want to place a new vertex. Click Add to add a vertex midway between the selected vertex and the next counterclockwise vertex.
11. To delete a vertex, enter or select the vertex number; then click Del. The remaining vertices located counterclockwise from the deleted vertex are renumbered.
12. See [Saving a User Mask to Disk](#) procedure.

NOTE. You do not need to save an edited user mask to disk; the instrument retains the current user mask in nonvolatile memory.

If you plan to create a number of user masks, store your user masks on disk or the hard drive. The instrument can only load one user mask at a time.

Save a user mask to disk

1. From Mask menu, select Mask Edit Setup.
2. In the Mask Edit control window, click the Save button to open the Save As dialog box.
3. Specify the save location in the Save in drop-down list box.
4. In the Name field, enter the mask name; (*.msk) is the default save type for User Mask Files.
5. Click Save to save the mask to specified location on disk.

Recall a user mask from disk

1. From the toolbar, click Masks; then open the Masks tab.
2. Click the User Mask button.
3. Click the Edit User Mask button. The instrument displays the Mask Edit control window.
4. Click the Mask Recall button.
5. The instrument opens the Recall dialog box. The default recall location is the TekScope/Masks folder. If the mask files are in another folder, use the navigation controls to access the appropriate folder.
6. Select the mask name.
7. Click Recall to load the user mask into user mask memory on the instrument.

Alternatively, the mask can be recalled by selecting Recall from the File Menu. This opens the Recall dialog box where you can navigate to and select the mask that you want to recall.

Create a user mask with mask testing

Use the Edit control to change a standard mask and create your own mask.

NOTE. Industry standard masks are available with the Mask Testing feature. The Comm Trigger is designed to work with communications mask and standard testing. Mask testing automatically uses Communication triggers. You must install the [Serial Communications Mask Testing Option](#) on some instruments before you can access the Comm triggers.

1. From the Masks menu, select Mask Setup, or click the Masks button in the toolbar.
2. In the Mask Testing control window, open the Masks tab.
3. From the Masks tab, select the type of mask and standard that you want to use as a basis for your mask.
4. Click User Mask, and then click Copy Current Mask To user Mask.
5. Click Yes. The mask that you selected is now a user mask.
6. To alter the mask, click Edit User Mask.
7. Under Mask Elements, use the up/down arrows to select the segment and vertex that you want to edit. The selected segment appears in red and a white X indicates the selected vertex.
8. Under Mask Value, click in the Horizontal or Vertical entry boxes. and then use the multipurpose knobs to change the horizontal or vertical values of the mask.
9. Click Save to save your changes as the User Mask.

Use mask testing

Follow these steps to perform mask testing:

1. From the Mask menu, select Mask Setup, or click the Mask toolbar button.
2. In the Mask Testing control window, open the Masks tab.

3. Select the Type of mask you want to use.
4. Select the mask standard from the drop-down list.

NOTE. *The standard you select will determine whether you also need to set the polarity for the test.*

5. Make any necessary changes to the Display or Alignment configurations.
6. Click the Hit Count button to turn it off or on.
7. Open the Source/Tolerance tab.
8. Click the input channel you want to test.
9. From the Source/Tolerance tab, make adjustments to the mask margins tolerance.
10. Open the Pass/Fail Setup tab and set the rest of the test parameters.
11. From the Pass/Fail Setup tab or the Pass/Fail Results tab, click the Pass/Fail Test button to run the test.

Using e-mail on event

Send an e-mail on events

You can set up the instrument to send e-mail following an event.

Set up E-mail on Event.

1. From the Utilities menu, select E-mail on Event Setup.
2. Enter the recipients' e-mail addresses in the entry box.
3. Click the Config button, and then enter your SMTP server address; then click OK.
4. Select the events on which to send e-mail.
5. Select which types of e-mail attachments you want to include.
6. Set the maximum message limit. (The maximum allowed by the system is 50.)
7. Set the maximum message size.

NOTE. *The default is 1 MB and the maximum is 2 GB. Setting the maximum message size to 0 causes attachments to be saved to the default location on the instrument hard drive.*

8. Click Send to send a test e-mail.

Send an E-mail on Mask Test Failure.

1. See [Setting up the Mask Test](#), and follow the procedure for setting up a mask test.
2. From the Pass/Fail Setup tab, under Test Fail Notification, click E-mail to On.
3. Click the Pass/Fail Test button On to start the mask test or click the Repeat button for continuous mask testing.

Send an E-mail on Trigger.

1. Select the trigger type.
2. Select the trigger source.
3. Set the appropriate parameters for the trigger.
4. From the Mode tab, click E-mail on Trigger to On.
5. Press the Run/Stop button to begin acquiring data to trigger.

Creating spectral waveforms

Create a spectral waveform

Use these steps to display a spectral (FFT magnitude) waveform.

1. Set the source signal Vertical Scale so that the signal peaks do not go off screen. Off-screen signal peaks can result in FFT waveform errors.
2. Set the Horizontal Scale control to show five or more cycles of the source signal. Showing more cycles means the FFT waveform can show more frequency components, provide better frequency resolution, and reduce aliasing.
3. If the signal is a single-shot (transient) signal, make sure that the entire signal (transient event and ringing or noise) is displayed and centered on the screen.
4. Click Math on the toolbar, or click Math Setup from the Math menu to open the Math Setup control window.
5. Click the Basic button.
6. Click the Magnitude button to insert the magnitude function into the math expression.
7. Click the channel that is related to the time-domain signal that you want to view as an FFT waveform. The respective channel is inserted into the math expression.
8. Select the appropriate FFT window type.
9. Set the Vertical Scale and Reference as appropriate.

Aliasing

Problems occur when the instrument acquires a signal containing frequency components that are higher in frequency than the Nyquist frequency. The Nyquist frequency is the highest frequency that any digital oscilloscope can measure without errors, and is one-half of the sample rate or frequency.

The frequency components that are above the Nyquist frequency are under sampled and appear to "fold back" around the Nyquist frequency, showing as lower frequency components. These incorrect components are called aliases.

To quickly check for aliasing, slowly decrease the horizontal time scale. If the shape of the displayed waveform changes drastically or becomes stable, your waveform is probably aliased. You can also check for aliasing by turning on peak detect acquisition mode. To remove aliasing, modify the record length.

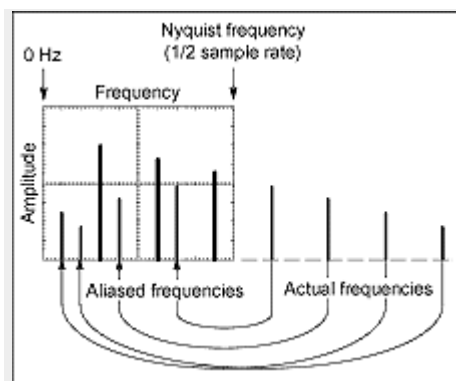

Define a spectral math waveform

Use the following procedure to define a spectral math waveform. Before you begin, ensure that the sources you will use are either acquiring or have acquired data. These sources do not have to be displayed to be used.

1. All sources that you will use in your math waveform must be available.
2. From the toolbar, click the Math button to open the Math Setup control window.
3. Click a Math <1–4> tab to select the math waveform you want to create.
4. Under Spectral Analysis, click Advanced to open the Spectral Analysis - Advanced control window.
5. Open the Create/Edit tab.
6. Click Magnitude to create a magnitude spectral waveform or Phase to create a phase spectral waveform. If you want an averaged spectral waveform, click Avgs to set the number of averages. See the step Apply Averaging [Creating a Math Waveform](#) for details.)
7. Under Source, select the tab and channel number for the source waveform.



TIP. If you want to redefine your waveform, click the Clear button, and repeat the above steps.

8. To display your spectral waveform, click Apply.
9. Set the magnitude scale:
 - a. Click the Magnitude button.
 - b. Open the Vert Axis tab.
 - c. Under Scale, click to select the vertical scale factor.
 - Linear. Displays magnitude using units equal to the source units.
 - dBm. Sets the reference level offset to predefined values for dBm; see next step.
 - dB. Displays magnitude using the log scale, expressed in dB relative to the reference level offset.



TIP. You can also adjust the scale and position by clicking the waveform handle and using the multipurpose knobs.

- a. To set the reference level, click in the Level entry box, and use the multipurpose knobs or pop-up keypad to set the reference level.



TIP. Reference level is the value at the top of the display screen. It only applies to magnitude waveforms. Adjusting the reference level positions the waveform with respect to the top of the display, but does not change the position of the waveform with respect to its ground reference.

- b. To set the reference level offset, click in the Level Offset entry box, and use the multipurpose knobs or pop-up keypad to set the offset.



TIP. Offset determines where zero dB is in the output waveform. Changing offset moves the waveform with respect to its ground reference. When the input is equal to the offset, it will display as zero dB in the output.

10. Set the phase scale:

- a. Open the Crate/Edit tab.
- b. Click the Phase button.
- c. Open the Vert Axis tab.
- d. Use the Scale controls to set the vertical scale factors.
 - Deg (Degree). Sets the phase units to degrees. Phase is displayed using degrees as the scale, where degrees wrap from -180° to $+180^\circ$.
 - Rad (Radian). Sets the phase units to radians. Phase is displayed using radians as the scale, where radians wrap from $-P$ to $+P$.
 - GroupDelay. Unwraps the phase spectrum and displays its derivative.

[Using the Phase Controls](#) provides in-depth information on setup for phase displays.

- Click Unwrap to specify whether to unwrap phase in a spectral analysis phase waveform.
- To set the level in dB that a magnitude in the spectrum must exceed to have its phase computed (to reduce the effect of noise in your phase waveform), click in the Suppression Threshold entry box, and use the multipurpose knobs or pop-up keypad to set the threshold level. If the magnitude is less than the threshold, then its phase is set to zero. See [Using the Phase Controls](#), for additional information on suppression threshold.

11. Set the time and frequency domain control tracking:

To enable changing time and frequency domain controls for one math waveform to change the same controls for another math waveform,

- a. Open the Tracking Tab
- b. Toggle the Track Time/Frequency Domain Controls buttons on or off.

12. To select the window type:

- a. Open the Create/Edit tab.
- b. Select the Window Type from drop-down list. For more information on window types see [Using Spectral Analyzer Windows](#).

13. Set the frequency domain controls:

- a. Open the Create/Edit tab.
- b. To set the frequency range over which the spectral analysis is performed, click in the Frequency Span entry box and use the multipurpose knobs or pop-up keypad to set the frequency range. Higher sample rates allow you to set greater frequency spans. To set the frequency span to the maximum allowed by the current sample rate, click Full.

- c. To set the center frequency of the spectral analysis, click in the Center Frequency and use the multipurpose knobs or pop-up keypad to set the center frequency.
 - d. Resolution bandwidth determines how small of a frequency difference can be resolved in the frequency domain output data. It basically defines the bandwidth of the filters used to do the frequency domain analysis. To set the resolution bandwidth, click in the Resolution BW entry box and use the multipurpose knobs or keypad to set the resolution bandwidth.
14. Set the time domain controls:
- a. Open the Create/Edit tab.
 - b. The Time domain controls determine the sample rate and record length of the acquisition. These controls allow you to change the duration on the acquisition without changing the sample rate. Click in the Resolution entry box and use the multipurpose knobs to adjust the time interval between data samples of the input waveform.

NOTE. Resolution is the inverse of Sample rate. Adjust resolution to adjust sample rate. Resolution may also cause a change in record length such that the duration is kept constant at the value selected by the Duration control.

- c. To adjust the number of seconds over the duration of the acquired waveform (record length), click in the Duration entry box and use the multipurpose knobs or pop-up keypad to adjust the duration.

NOTE. Changing duration also changes the record length.

- d. Gate position is the position of the phase reference point in the gate with respect to the trigger in seconds. The gate position and gate duration must be within the acquisition. To set the gate position, click in the Gate Position entry box and use the multipurpose knobs or pop-up keypad to adjust the gate position.
 - e. Gate duration and resolution bandwidth are the same. Gate duration is displayed in seconds and resolution bandwidth in hertz. To set the gate duration, click in the Gate Duration entry box and use the multipurpose knobs or pop-up keypad to adjust the gate duration.
15. Take cursor measurements:
- a. From the toolbar, click the Cursors button to display the cursors and open the Cursor Controls window.
 - b. Click the Setup button to open the Cursor Setup window.
 - c. Use the Source drop-down lists to select the channels for the spectral waveform you want to measure.
 - d. Select the cursor type. For more information, see Taking Cursor Measurements.
 - e. Click in the X and Y Position entry boxes and use the multipurpose knobs to position each cursor on the waveform to measure the feature(s) that interests you.
 - f. Read the results in the cursor readout.

NOTE. The cursor readout is displayed under the multipurpose readouts or in the upper right corner of the graticule area. The cursor units will be in dB or volts for magnitude waveforms and in degrees or radians for those measuring phase.

- g. Select V Bars, and use the multipurpose knobs to align the two vertical cursors to points of interest along the horizontal axis of the waveform.
- h. Read the frequency difference between the cursors from the Δ : readout. Read the frequency of each cursor relative to the zero frequency point from the cursors readout.

Take a cursor measurement

Use the following procedure to take measurements with cursors:

1. To open the Cursor Controls window, press the Cursors button on the front panel, click Cursors on the toolbar, or select Cursor Setup from the Cursors menu.
2. Select the waveform you want to measure and a *Cursor Type* from the control window.
3. Position the cursors with the multipurpose knobs.
4. Read the cursor information from the on-screen Position controls.



TIP. Select the cursor mode (Tracking or Independent) in the Cursor Setup control window.

Use a predefined spectral math waveform

The following procedure is an example of setting up the instrument to perform spectral analysis of a signal. This example uses the probe compensation signal available on the front panel of the instrument.

1. Connect the probe compensation signal to Ch 1 through a suitable probe.
2. Press Default Setup.
3. Press Autoset.
4. From the toolbar, click Vertical, and select the Chan 1 tab.
5. Click in the Offset entry box, and then use the multipurpose knobs or keypad to set the offset to 900 mV.
6. Click in the Scale entry box, and use the multipurpose knobs or keypad to set the Channel 1 Scale to 200 mV.
7. From the toolbar, click Math, and select the Math 1 tab.
8. Click the Spectral Mag button.

The instrument sets up a predefined magnitude spectral analysis waveform. Your waveform should be similar to the one below.

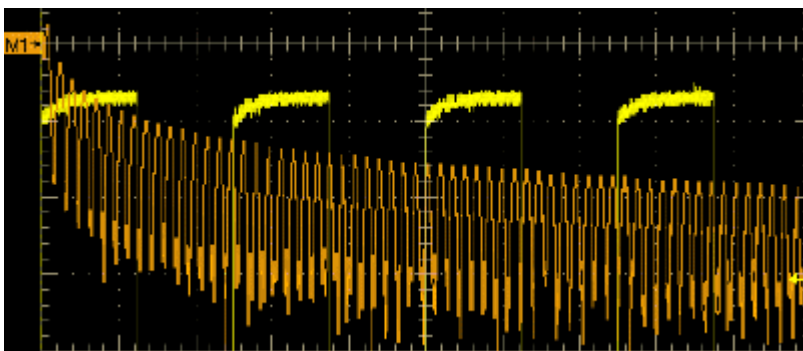

9. Click the Spectral Analysis Basic button.
10. Use the multipurpose knobs or keypad to set the frequency span to 125 kHz and the center frequency to 62.5 kHz (if necessary, reduce the sample rate).
11. From the toolbar, click Cursors.
12. To assign the cursors to the spectral analysis math waveform, select Math 1 from the Source list for Cursor 1.
13. Click Setup to open the Cursor Setup control window.

14. Use the multipurpose knobs or keypad to set the Curs1 Pos to 0.0 Hz and the Curs2 Pos to 125 kHz. The cursor readout should now indicate the frequency span set in step 10.
15. Use the multipurpose knobs or keypad to set the Curs2 Pos to 62.5 kHz. The cursor readout should now indicate the center frequency set in step 10.
16. Use the multipurpose knobs or keypad to set the Curs1 Pos to 3.0 kHz and the Curs2 Pos to 11.0 kHz.
In this example, the cursors are now on the third and eleventh harmonic of the probe compensation signal. Read the frequencies from the cursor readouts.
17. Click the Cursor Type Waveform button; then click in the Cursor 2 and the Math 1 entry boxes.

In addition to the frequency at the cursor locations, the cursor readout displays the amplitude at the cursor locations. The readout also displays the difference in frequency and amplitude between the cursor locations as shown below.

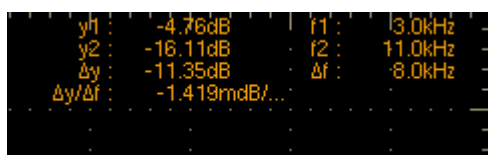

Using reference waveforms

Create a reference waveform

Use this procedure to create reference waveforms from active or math waveforms.

1. Click Save on the toolbar or click Save As from File menu.
2. Select Waveform to open the Save As dialog box.
3. From the Source list, select the waveform you want to save as a reference.
4. Under Save in: Oscilloscope Memory, click Ref <1–4> to save the waveform to nonvolatile memory. You can also select a location from the Save in drop-down list to save the waveform to a file.
5. Use the pop-up keyboard to enter a meaningful name for the waveform in the Name text box.
6. Click Save.

NOTE. When you save a waveform as a reference waveform, a file containing the waveform data is created in C:\Users\[Username]\Tektronix\TekScope\Waveforms. The file is named TDS_REFn.WFM, where n is the reference waveform number. Do not manually delete this file because the data will no longer be available.

Save reference waveforms using Auto-Increment file name

Use this procedure to repetitively save waveforms without typing in a large number of unique file names.

1. Click Save on the toolbar or click Save As from File menu.
2. Select Waveform.
3. From the Source list, select the waveform that you want to save as a reference.
4. Click Auto-increment file name near the bottom of the dialog box.
5. Enter a descriptive name in the Base file name text box. For example, if you are saving a series of rise time data files, you can use " Risetime " as the base file name.
6. The Count text box defaults to "000." Change this if you want to start saving your series of files with another 3-digit number.

7. Change the file Save as type if necessary.
8. Click Save.

Your first file is saved as `Risetime000.ext`, where `ext` is the file type extension. The next file will be `Risetime001.ext`, and so on.

If Count reaches 999, Tektronix suggests that you change the base file name, for example, `Risetime1` on the next save. Your next file will then be saved as `Risetime1000.ext`. You will receive a warning message if you are going to overwrite any existing files with the same name.



TIP. Use the auto-increment file name feature to save a series of setups, exported images, waveforms, and measurements.

Recall a reference waveform

Use this procedure to recall a reference waveform from a file:

1. Click Recall on the toolbar, or select Recall from the File menu.
2. Under Recall What, select Waveform.
3. Select the waveform you want to recall; then select the Destination Ref <1– 4>.
4. Click Recall to load the waveform into memory.

You can use reference waveforms for measurements, math functions, or other uses. Simply select the reference waveform from the [Channels Selector](#) on the individual control windows.

NOTE. When you recall a reference waveform from a file, a new file containing waveform data is created in `C:\Users\[Username]\Tektronix\TekScope\Waveforms`. The file is named `TDS_REFn.WFM`, where `n` is the reference waveform number. This file is deleted when the reference waveform is deleted.

Using waveforms

Save a waveform

Use the following procedure to save a waveform or waveforms to a reference location, the instrument hard drive or DVD drive, or a third-party storage device.

1. Make sure the waveform to be saved exists. The source must be a channel, an active math waveform, or an active reference waveform. Display the waveform along with the setup before you save it.
2. From the File menu select Save As; then click Waveform.
3. From the Source drop-down list, select the waveform that you want to save. Only available waveforms are displayed in the list.
4. Under Save in: Oscilloscope Memory, select the location Ref <1–4>; then click Save to save your waveform to that reference location. Any data in the existing reference will be overwritten.
5. To save the waveform to a file, select the location to save from the Save in drop-down list. The default location is `C:\Users\[Username]\Tektronix\TekScope\waveforms`.

6. Name your waveform file by typing a name in the Name text box, or select an existing name from the file list (data in the existing file will be overwritten). You can also select the Auto-increment file name check box to save a series of files without typing in a new name each time. For more information, see [Saving Reference Waveforms Using Auto-Increment File Name](#).



TIP. If you did not attach a keyboard, click the keyboard icon to display the virtual keyboard.

7. The file extension specified in the Save as type drop-down list will automatically be appended to the file name. You can also select from the following file formats:
 - .wfm is an internal instrument format. When waveform is selected, save waveform options like waveform data range, FastFrame data range, waveform detail and data ordering are disabled.
 - .csv is usable by spreadsheets such as Microsoft Excel.
 - .txt is the standard text file format.
 - .dat is usable by Mathcad and MATLAB.
 - HDF5 (*.h5) is Hierarchical Data Format version 5. HDF5 saves the entire waveform. When HDF5 is selected, save waveform options like waveform data range, FastFrame data range, waveform detail and data ordering are disabled.
8. If your file type is other than .wfm, click the Options button to set up the Waveform Save Options.
9. Select the data format (Data destination) for the waveform you want to export.
10. Select a valid waveform from the Source list.

NOTE. Options that are grayed out are not available with the currently selected data destination.

11. Under Waveform Detail, select the Include waveform scale factors check box if you want to include waveform details like header information (record length, sample interval, trigger point information, and so on). If you only want to include the waveform voltage values, clear the selection.
12. Under Waveform Data Range, select the samples that you want to save. You can select a range of samples, only the samples between the cursors, samples in a Zoom Area, or All samples. If you select Samples between cursors, you can use the multipurpose knobs to adjust the positions if the cursors are active. If they are not, the cursors are activated in their most recent positions.
13. If you are exporting Fast Acquisitions data, select the data ordering from the list.
14. Click OK, and then click Save to save the waveform file. To cancel without saving, click Cancel.

Copy waveform data

1. Identify the waveform, image, or measurement to be copied. The source must be a channel, an active math waveform, or an active reference.
2. From the Edit menu, highlight Select for Copy.
3. In the submenu, select the format for export:
 - Select Full Screen to export a bitmap of all screen contents.
 - Select Graticule to export a bitmap of only the graticule area.
 - Select Waveform to export waveform data.
 - Select Measurements to export measurement data.
4. From the Edit menu, select Copy Setup.
5. Open the Images tab.
6. Set the Image Options:

- a. Select a color Palette for your copied images.
 - b. Select the image View: to copy an image of the entire screen, select Full-screen; to copy an image of the selected graticule, select Graticule(s) only.
 - c. The Screen Capture Format is BMP only.
7. Set the Waveform Options:
- a. Open the Waveforms tab.
 - b. Select the data format (Data Destination) for the waveform you want to copy.
 - c. Select a valid waveform from the Source list.
 - d. Select the Include waveform scale factors check box if you want to include waveform details like header information (record length, sample interval, trigger point information, and so on). If you only want to include the waveform voltage values, clear the selection.
 - e. Select the number of samples that you want to copy from the Waveform curve data range. Select all samples, a range of samples, or only the samples between the cursors. If you select Save Samples between Cursors, you can use the multipurpose knobs to adjust the positions if the cursors are already active. If they are not, the cursors are activated in their most recent positions.
 - f. If you are copying Fast Acquisitions data, select the data ordering from the list.
8. Set the Measurement Options:
- a. Open the Measurements tab.
 - b. Select either Displayed Measurements (make sure that measurements are displayed in the graticule via the Measurement Control window) or Histogram Data.
 - c. If you clicked the Displayed Measurements option, select the Data Format, either Numeric or Text.
9. Click Copy to save your setup information to the Windows clipboard.

Save a screen capture

Use this procedure to save screen captures to the instrument memory, a CD, or third-party storage device. The images you want to save must be displayed within the graticule.

1. From the File menu, select Save As; then select Screen Capture.
2. Click the Options button to open the Screen Capture Save Options dialog box.
3. Select a color Palette for your screen capture.
4. Under View, select from the following:
 - Full Screen. Saves an image of the entire screen.
 - Hide Menu/Toolbar. Click this check box if you do not want the menu and toolbar included.
 - Graticule(s) Only. Selects an image of the selected graticule.
5. Select a data format from the Screen Capture Format list.
6. Click OK to save the screen capture options, or click Cancel to close the dialog box without saving the changes.
7. In the Save As dialog box, select the location to save from the Save in drop-down list. The default location is C:\Users\[Username]\Tektronix\TekScope\Screen Captures.

8. Name your screen capture by typing a name in the Name text box, or select an existing name from the file list (data in the existing file will be overwritten). You can also select the Auto-increment file name check box to save a series of files without typing in a new name each time.
9. Click Save.

Using horizontal delay

Set the horizontal delay

Use the following steps to set up the horizontal delay mode of the instrument.

1. Open the Horizontal/Acquisition Setup control window.
2. Open the Horizontal tab.
3. Turn on the Horizontal Delay mode by clicking Delay Mode on or pressing the front panel Delay button.
4. Click in the Horiz Delay entry box and use the multipurpose knobs to set the delay time and reference point (Ref Point). To view data before the trigger event, enter a negative value; to view data after the trigger event, enter a positive value.



TIP. You can also use the horizontal delay with complex trigger events in the Trigger Setup control window by clicking the A->B Seq tab and configuring the horizontal delay.

Compare data using horizontal delay

After setting up the instrument to use the horizontal delay, press the front panel Delay button to toggle the horizontal delay on and off. This allows you to quickly compare two segments of a signal that are separated from each other by a fixed amount of time.

Using roll mode

Set up roll mode

Use the following procedure to set up roll mode acquisitions.

1. Power on the instrument and set up the [horizontal](#) and [vertical](#) controls and [triggering](#).
2. Click the Horiz/Acq toolbar button to open the horizontal/acquisition setup control window.
3. Open the Acquisition tab.
4. Click the Roll Mode Auto button to enable roll mode. The resolution, record length, horizontal scale, and number of active channels are dependent variables. Therefore, the fastest horizontal scale setting when Roll mode starts is 40 ms/div, the record length is 1000, the acquisition mode is either Sample or Peak Detect, and 1 or 2 channels must be on. As the record length or the number of on channels grows, the time per division required to enter Roll mode is slower.

NOTE. Envelope and Average acquisition modes inhibit roll mode. Hi Res roll mode starts when the resolution is 4 ms or greater.

5. Push the Single button on the instrument front panel to start and acquire enough points to satisfy the acquisition mode (when the waveform makes it to the left edge of the screen). The acquisition mode must be either Sample or Peak Detect.
6. To stop acquisitions in roll mode:
 - If you are not in Single Sequence, push Run/Stop to stop roll mode.
 - If you are in Single Sequence, roll mode acquisitions stop automatically when a complete record is acquired.

7. Click the Horiz toolbar button to open the horizontal/acquisition setup control window.
8. Open the Acquisition tab.
9. Click Roll Mode Off to disable roll mode. Roll mode is also disabled when you set the horizontal scale to 200 ms per division or faster. At record lengths greater than 500 points, the time per division to turn off roll mode becomes slower.

NOTE. *Switching to Envelope or Average acquisition mode will also turn off roll mode.*

Using roll mode

Use Roll mode to view data at very slow sweep speeds. This is useful for observing data samples on the screen as they occur.

NOTE. *Roll mode turns on automatically at slower sweep speeds. You may want to turn Roll mode off to avoid conflicts with other instrument settings.*

To [turn Roll mode off](#), deselect Roll Mode Auto in the acquisition setup control window.

Triggering

Checking trigger status

To assess the state and setup of the triggering circuit, check the trigger status lights, readouts, and display.

Trigger status lights. To quickly determine the trigger status, check the Arm, Ready, and Trig'd indicators on the instrument front panel.

- If Trig'd is on, the oscilloscope has recognized a valid trigger and is filling the posttrigger portion of the waveform.
- If Ready is on, the oscilloscope can accept, and is waiting for, a valid trigger.
- If Arm is on, the trigger circuitry is filling the pretrigger portion of the waveform record.
- If both Trig'd and Ready are on, a valid A event trigger has been recognized and the instrument is waiting for a delayed trigger. When a delayed trigger is recognized, the posttrigger portion of the delayed waveform will fill.
- If Arm, Trig'd, and Ready are off, the acquisitions have stopped.

Acquisition readouts. To determine the settings of some key trigger parameters, check the Trigger readout at the bottom of the display. The readouts differ for edge and the advanced triggers.

Trigger level marker. To determine the trigger level on the waveform display, turn on a trigger level indicator (marker). See [Trigger Level Marker](#) for instructions on setting the indicator.

The trigger level indicator remains on the screen as long as the channel providing the trigger source is displayed.

You can choose between two types of trigger level indicators:

- Short. Consists of an arrow at the right side of the graticule.
- Long. Consists of a horizontal bar within the waveform display area.

Set up triggering from the front panel

The front panel provides quick access to the most frequently used trigger controls. The trigger readout shows you the state of the trigger system. On DPO7000SX instruments use the DPO7AFP accessory.

The Slope, Coupling, and Source controls only apply to edge triggering. To access the advanced trigger controls, open the Trigger Setup control window by pushing the Advanced button. (See Advanced Triggering for more information.)

Use the following procedure to set up triggers using the front-panel controls:

1. Set the acquisition system to Run (the Run/Stop control is lighted), and set the vertical and horizontal controls appropriately for the signal you want to acquire.
2. Push the Edge button to select edge triggering. Pushing Advanced opens the Trigger control window to set up other trigger types.
3. Push the Slope button to toggle between Positive and Negative:
 - Pos. Triggers on a rising edge (positive-going) signal.
 - Neg. Triggers on a falling edge (negative-going) signal.
 - Pos + Neg. Triggers on both edges of the signal.

You can also set the Polarity in the Trigger control window.
4. To manually change the trigger level for edge triggers (or certain threshold levels for logic or pulse triggers), turn the front-panel Level knob. You can also set the Level in the Trigger control window.
5. To quickly set the edge trigger level to 50% of the waveform voltage range, push the Level knob. The instrument sets the trigger level to the halfway point between the peaks of the trigger signal. This function has no effect for the other trigger types.

You can also click Set 50% in the Trigger control window.
6. Push the Trigger left and right arrow button to select a Source:
 - Ch 1 through Ch 4. These are the input channels. The channel you select as a trigger source will function whether it is displayed or not.
 - Ext. This is a fifth, nondisplayable auxiliary (external) trigger source. To use the auxiliary trigger, connect the source to the front-panel Auxiliary In connector. This trigger is not available on multi-instrument configurations.
 - Line. This is the AC line voltage. The oscilloscope is used to generate the trigger and you do not have to input a signal. The trigger level is fixed at zero volts. This trigger is not available on multi-instrument configurations.
7. From the Trig menu select Edge Setup to set the Coupling for an A or B Event main trigger:
 - DC. Passes both AC and DC components of the input signal.
 - AC. Passes only the AC components of an input signal.
 - HF Reject. Attenuates signals above 30 kHz.
 - LF Reject. attenuates signals below 80 kHz.
 - Noise Rej. Provides lower sensitivity, reducing the chance of falsely triggering on noise.
 - RF. Increases sensitivity and bandwidth at the highest operating frequencies (SX models only).
8. Push the front-panel Mode button to toggle between normal and automatic trigger modes:
 - Norm (Normal). Requires a valid trigger event to acquire a waveform.
 - Auto (Automatic). Acquires a waveform even if no valid trigger event occurs.

NOTE. Be aware that in Auto mode, the acquired waveforms may not be triggered.

Advanced triggering

You can check the advanced trigger status in the readout. The readout indicates the trigger type and then shows sources, levels, or any other parameters that are important for the particular trigger type.

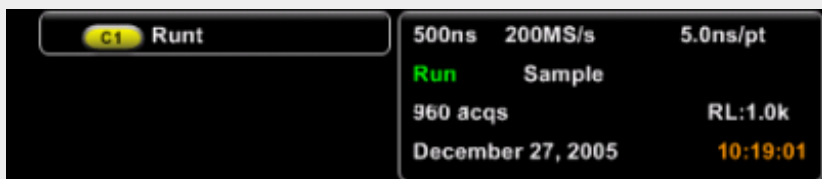

Set up triggering from the trigger setup window

The following trigger parameters are accessible only through the Trigger control windows:

- Holdoff
- Trigger level presets
- Force trigger

Use the procedures below to set up these trigger parameters.

Set the trigger holdoff. Changing the holdoff time helps to stabilize triggering.

1. Push the front-panel Advanced button.
2. In the Trigger control window, select the Mode tab.
3. **Click Default or Time:**
 - Auto. Uses the instrument default holdoff time, which is five times the current horizontal scale setting. Default maintains a good value for general-purpose triggering.
 - Time. Enables you to enter a holdoff that may allow more stable triggering. This time is used at all horizontal scale settings
4. If using Time, click in the Trig Holdoff entry box and use the multipurpose knob to enter a time value. The holdoff range is 250 ns to 100 s.

Select a preset trigger.

1. Push the front-panel Advanced button.
2. In the Trigger control window, select the A Event tab.
3. Click a Trigger Type button to select a trigger, such as Edge, that uses a level adjustment. A trigger uses a level adjustment if the Level control appears within the trigger graphic, along with the other trigger type setup controls.
4. Click Level, and then click the keypad icon to open the keypad. Click on either TTL, ECL, or USER:
 - TTL. Sets the trigger level to +1.4 V.
 - ECL. Sets the trigger level to -1.3 V.
 - USER. You can set the trigger level to a preset voltage.

When you set the volts/div less than 200 mV, the instrument reduces the TTL or ECL trigger levels below standard TTL and ECL levels. This reduction occurs because the trigger level range is fixed at +12 divisions from the center. At 100 mV (the next lower setting after 200 mV) the trigger range is +1.2 V, which is less than the typical TTL (+1.4 V) or ECL (-1.3 V) level.

Trigger graphic

The trigger graphic displays a visual indicator of the trigger criteria. Depending on the trigger type, the instrument will update the graphic as you define the trigger parameters.

Define preset levels.

1. From the Utilities menu, select user Preferences.
2. In the User Preferences control window, open the Keypad Defaults tab.
3. Click in the appropriate Trig Level entry box; then use the pop-up keypad or multipurpose knob to adjust the preset.
4. If desired, click a Keypad Label and change the label of the preset using the pop-up keypad.

Force a trigger. When using Normal trigger mode, forcing a trigger is useful if the input signal is not supplying a valid trigger.

1. Push the front-panel Advanced button.
2. In the Trigger control window, open the A Event or B Event tab
3. In the Trigger Type drop-down list, select Edge.
4. To force the instrument to immediately acquire one waveform record, even without a trigger event, click the Force Trigger button.



TIP. Click Force Trigger to quickly confirm there is a signal present for the instrument to acquire. Then determine how to trigger on the signal. For example, push LEVEL to set 50%, check the trigger source setting, and so on.

NOTE. The instrument acts on a Force Trigger even if it is selected before the end of pretrigger holdoff. However, the button has no effect if the acquisition system is stopped.

Trigger on a sequence

Use the following procedure to set up the instrument to trigger on a sequence:

1. Connect a signal to an input channel.
2. Set the acquisition system to Run; then set the vertical and horizontal controls appropriately for the signal you want to acquire.
3. To trigger on A Event (main) only:
 - a. Click Trigger on the toolbar; then open the A->B Seq tab of the Trigger control window.
 - b. Click the A Only button to turn off sequential triggering.
4. To trigger on a B event after time:
 - a. To set the time base to run after an A trigger, a trigger delay, and a B trigger, click Trigger on the toolbar; then open the A->B Seq tab of the Trigger Setup window.
 - b. Click Trig After Time.
 - c. To set the trigger delay, click in the Trig Delay entry box; then use the multipurpose knob or pop-up keypad to set the time.
 - d. To set the B trigger level, click in the B Trig Level entry box; then use the multipurpose knob or pop-up keypad to set the level.
5. To trigger on B events:
 - a. To set the time base to trigger after an A trigger and a specified number of B trigger events, click Trigger on the toolbar; then open the A->B Seq tab of the Trigger Setup window.
 - b. Click Trig on nth Event.

- c. To set the number of B trigger events, click in the Trig Event entry box; then use the multipurpose knob or pop-up keyboard to set the number of events.
 - d. To set the B trigger level, click in the B Trig Level entry box; then use the multipurpose knob or pop-up keypad to set the level.
6. To set up B Event triggering:
- a. To set the B Event trigger, click Trigger on the toolbar; then open the B Event tab of the Trigger control window.
 - b. To specify which channel becomes the B trigger source, click Source; then select the source from the drop-down list.
 - c. Click Coupling, then select the trigger coupling to match your trigger signal.
 - d. To specify the direction of the edge, click a Slope button, positive or negative.
 - e. To set the B trigger level, click in the Level entry box; then use the multipurpose knob or pop-up keypad to set the level.

NOTE. You can click Set 50% to set the B trigger level to the midpoint between the positive and negative peak of the B trigger signal.

Trigger on A event only

Use the following trigger sequence to trigger the instrument after the A event has occurred:

1. Set the A Event Trigger Type and Source from the A Event tab in the Trigger control window.
2. Open the A->B Seq tab; then click the A Only button.

Trigger on an event after a specified delay

Use the following trigger sequence to trigger the instrument on the B event after a specified amount of time after the A event:

1. Set the A Trigger Type and Source from the A Event tab in the Trigger control window.
2. Set the B Trigger Type and Source from the B Event tab.

NOTE. This online help file supports many oscilloscope models from Tektronix. This feature is only available on some models.

3. Open the A->B Seq tab; then click Trig After Time.
4. Click in the Trig Delay entry box; then enter the trigger delay time between the A and B events.

Trigger on a B event

Use the following trigger sequence to trigger the instrument after a specified number of B events:

1. Set the A Trigger Type and Source from the A Event tab in the Trigger control window.
2. Set the B Trigger Type and Source from the B Event tab.

NOTE. For MSO70000C/DX Series instruments, when you select a Pattern or a State trigger as the B Event, digital channels are not available.

3. Open the A->B Seq tab; then click Trig on nth Event.
4. Click in the Trig Event entry box; then enter the number of B events that should occur before starting the acquisition after the A event.

Trigger on a glitch

Use the following procedure to detect and trigger on a glitch, or to ignore a glitch:

1. Push the front-panel Advanced button.
2. In the Trigger control window, open the A Event tab.
3. Select Glitch from the Trigger Type drop-down list.
4. Specify the trigger source. Click Source; then select a channel from the drop-down list.
5. Click a Polarity button to specify the glitch polarity:
 - Pos. Looks at positive-going pulses.
 - Neg. Looks at negative-going pulses.
 - Either. Looks at both positive and negative pulses.
6. To specify the width of the glitch, click in the Width entry box; then set the glitch width using the multipurpose knob or keypad.
7. Select from the Glitch Width drop-down list to specify whether to trigger on glitches narrower or greater than the width you specify:
 - Less Than. Trigger only on narrower pulses.
 - Greater Than. Trigger only on wider pulses.
8. Click in the Level entry box; then use the multipurpose knob, keypad, or front-panel Trigger Level knob to set the level that the glitch must cross to be recognized by the instrument. You can also set the level to a value appropriate to either the TTL or ECL logic families by selecting Logic in the Trigger if Glitch drop-down list.
9. You can also Trigger on a logic-qualified pulse using the Trigger if Glitch "Logic" selection. When the instrument detects that a glitch condition has occurred, it checks the logical state of two other available channels and triggers only if their conditions are met. Each channel can have a value of high (H), low (L), or "don't care" (X). A value is considered high if the channel input voltage is greater than the specified threshold voltage; a value is considered low if the channel input voltage is less than the specified threshold voltage. Use the "don't care" selection for any channels that will not be used as part of the pattern.
10. You can set the mode and holdoff for all standard trigger types. Refer to [trigger mode](#) and set [holdoff](#) to learn more about trigger mode and holdoff.

Trigger on a runt pulse

Use the following procedure to detect and trigger on a runt pulse. The instrument can look for positive or negative runt pulses. These pulses can also be qualified by time or by the logical state of other channels.

1. Push the front-panel Advanced button.
2. In the Trigger control window, open the A Event tab.
3. Select Runt from the Trigger Type drop-down list.
4. Specify the trigger source. Click Source; then select a channel from the drop-down list.

5. Select a Polarity value to specify the direction of the runt pulse. Triggering occurs at the point the pulse returns over the first threshold without crossing the second threshold level. The polarity selected determines the order that the threshold must be crossed for a runt trigger to occur:
 - Pos. Looks at positive-going pulses. The lower threshold must be first crossed going positive, then recrossed going negative without the upper threshold being crossed at all.
 - Neg. Looks at negative-going pulses. The upper threshold must be first crossed going negative, then recrossed going positive without the lower threshold being crossed at all.
 - Either. Looks at both positive and negative pulses. Either one of the thresholds must be first crossed going in either direction, then recrossed going in the opposite direction without the other threshold being crossed at all.

For all three polarity settings, triggering occurs at the point the runt pulse recrosses its first threshold.
6. To qualify the runt pulse trigger, click Runt; then select from the drop-down list:
 - Occurs. Triggers on all runt pulses.
 - Wider. Triggers only on runt pulses that exceed the minimum width that you set. Enter the Width using the multipurpose knob or pop-up keypad.
7. To set the threshold levels, click in the Upper Limit or Lower Limit entry boxes; then use the multipurpose knobs or pop-up keypad to set the values.
8. You can also Trigger on a logic-qualified runt pulse using the Trigger if Runt "Logic" selection. When the instrument detects that a runt condition has occurred, it checks the logical state of two other available channels and triggers only if their conditions are met. Each channel can have a value of high (H), low (L), or "don't care" (X). A value is considered high if the channel input voltage is greater than the specified threshold voltage; a value is considered low if the channel input voltage is less than the specified threshold voltage. Use the "don't care" selection for any channels that will not be used as part of the pattern.



TIP. To use the trigger level marker to help in setting the threshold levels, open the Display control window Objects tab; then click Long to activate the marker.

9. You can set the mode and holdoff for all standard trigger types. Refer to [trigger mode](#) and set [holdoff](#) to learn more about trigger mode and holdoff.

Trigger on a pulse width

Use the following procedure to detect and trigger on a pulse that is either wider or narrower than the specified range:

1. Push the front-panel Advanced button.
2. In the Trigger control window, open the A Event tab.
3. Select Width from the Trigger Type drop-down list.
4. Specify the trigger source. Click Source; then select a channel from the drop-down list.
5. To specify the Polarity of the pulse, click Pos (for positive-going pulses) or Neg (for negative-going pulses).
6. To set the range of pulse widths in units of time, click in the Upper Limit and Lower Limit entry boxes; then enter values with the multipurpose knobs or pop-up keypad:
 - Upper Limit. This is the maximum valid pulse width the trigger source will look for.
 - Lower Limit. This is the minimum valid pulse width. The instrument will always force the Lower Limit to be less than or equal to the Upper Limit.

7. In the Pulse Width drop-down list:
 - Select Inside to trigger on pulses that fall within the specified range.
 - Select Outside to trigger on pulses that are outside the range.
8. You can also Trigger on a logic-qualified pulse using the Trigger if Width "Logic" selection. When the instrument detects that a width trigger condition has occurred, it checks the logical state of two other available channels and triggers only if their conditions are met. Each channel can have a value of high (H), low (L), or "don't care" (X). A value is considered high if the channel input voltage is greater than the specified threshold voltage; a value is considered low if the channel input voltage is less than the specified threshold voltage. Use the "don't care" selection for any channels that will not be used as part of the pattern.
9. Click in the Level entry box; then use the multipurpose knob, pop-up keypad, or front-panel Level control to set the trigger level.
10. You can set the mode and holdoff for all standard trigger types. Refer to [trigger mode](#) and set [holdoff](#) to learn more about trigger mode and holdoff.

Trigger on a pulse timeout

Use the following procedure to detect and trigger on pulses longer than a specified time. The instrument will trigger at the end of the timeout period.

1. Push the front-panel Advanced button.
2. In the Trigger control window, Open the A Event tab.
3. Select Timeout from the Trigger Type drop-down list.
4. Specify the trigger source. Click Source; then select a channel from the drop-down list.
5. To set the trigger timeout level, click in the Level entry box; then use the multipurpose knob or pop-up keypad to enter the voltage level.

NOTE. You can set the level to a value appropriate to either the TTL or ECL logic families by clicking TTL or ECL on the Level pop-up keypad.

6. To set the timeout timer, click Timer, and then use the multipurpose knob or pop-up keypad to set the time.
7. To set the pulse threshold, click one of the following:
 - Stay High. Triggers if the signal stays higher than the trigger level for longer than the timeout (Timer) value.
 - Stay Low. Triggers if the signal stays lower than the trigger level for longer than the timeout (Timer) value.
 - Either. Triggers if the signal stays lower or stays higher than the trigger level for longer than the timeout (Timer) value.
8. You can also Trigger on a logic-qualified pulse using the Trigger if Timeout "Logic" selection. When the instrument detects that a timeout condition has occurred, it checks the logical state of two other available channels and triggers only if their conditions are met. Each channel can have a value of high (H), low (L), or "don't care" (X). A value is considered high if the channel input voltage is greater than the specified threshold voltage; a value is considered low if the channel input voltage is less than the specified threshold voltage. Use the "don't care" selection for any channels that will not be used as part of the pattern.
9. You can set the mode and holdoff for all standard trigger types. Refer to [trigger mode](#) and set [holdoff](#) to learn more about trigger mode and holdoff.

Trigger on a pattern

Use the following procedure to trigger the instrument when the logic inputs cause the selected function to become True or False. You can also specify that the logic conditions must be satisfied for a specific amount of time before the instrument triggers.

1. Push the front-panel Advanced button.
2. In the Trigger control window, Open the A Event tab.
3. Select Pattern from the Trigger Type drop-down list.
4. Select a value from the Input Threshold drop-down list for each channel. The channel inputs combine to form a logic pattern. Each channel can have a value of high (H), low (L), or "don't care" (X). A value is considered high if the channel input voltage is greater than the specified threshold voltage. A value is considered low if the channel input voltage is less than the specified threshold voltage. Use the "don't care" selection for any channels that will not be used as part of the pattern.
5. To set the Input Threshold voltages, click one of the Threshold Presets buttons to define the level type. If you selected USER, click in the Ch <1–4> entry boxes, and then use the multipurpose knobs or pop-up keypad to set each threshold.
6. Select the Pattern Type Boolean logic function for the combination of input channels. The instrument will trigger on a clock edge when the input waveforms match the specified logic pattern.

NOTE. See *Pattern Triggers* for definitions of the logic functions for pattern triggers.

7. From the Pattern drop-down list, select True to trigger the instrument when the logic patterns are true. Select False to trigger the instrument when the logic patterns are false.
8. You can time qualify a pattern logic trigger, that is, you can specify the amount of time the Boolean logic function must be True:

NOTE. On MSO/DPO5000B Series instruments, < or > are used instead of Less than or More Than from the Pattern drop-down list.

- a. Select Less than or More Than from the Pattern drop-down list.
- b. Under Pattern, click in the Time entry box, and then use the multipurpose knob or keypad to set the time.

NOTE. When you select Less Than and specify a time, the input conditions must drive the logic function true for less than the specified time. Conversely, the true for More Than item requires the Boolean function to be true for longer than the time you specify.

The instrument determines the trigger point in the following manner:









- It waits for the logic condition to become True.
 - It starts timing and waits for the logic function to become False.
 - It compares the times and, if the time True is longer (More Than Time) or shorter (Less Than Time), then it triggers a waveform display at the point the logic condition became False. This time can be, and usually is, different from the time set.
9. You can set the mode and holdoff for all standard trigger types. Refer to [trigger mode](#) and set [holdoff](#) to learn more about trigger mode and holdoff.

Pattern triggers

A pattern trigger occurs when the inputs to the selected logic function cause the function to become True or False. When you use a pattern trigger, you define:

- The precondition for each logic input: logic high, low, or "don't care"; the logic inputs are the instrument channels
- The Boolean logic function: AND, NAND, OR, or NOR
- The condition for triggering: the Boolean function becomes True (logic high) or False (logic low), and whether the True condition is time qualified

Pattern trigger logic choices are summarized in the following table.

| Pattern | State | Definition ^{1, 2} |
|--|--|--|
| AND  | Clocked AND  | If all the preconditions selected for the logic inputs ³ are TRUE, then the instrument triggers. |
| NAND  | Clocked NAND  | If not all of the preconditions selected for the logic inputs ⁴ are TRUE, then the instrument triggers. |
| OR  | Clocked OR  | If any of the preconditions selected for the logic inputs ⁵ are TRUE, then the instrument triggers. |
| NOR  | Clocked NOR  | If none of the preconditions selected for the logic inputs ⁶ are TRUE, then the instrument triggers. |

Pattern triggers

A pattern trigger occurs when the inputs to the selected logic function cause the function to become True or False. When you use a pattern trigger, you define:

- The precondition for each logic input: logic high, low, or "don't care"; the logic inputs are the instrument channels
- The Boolean logic function: AND, NAND, OR, or NOR
- The condition for triggering: the Boolean function becomes True (logic high) or False (logic low), and whether the True condition is time qualified

Pattern trigger logic choices are summarized in the following table.

¹ For state triggers, the definition must be met at the time the clock input changes state









² The definitions given here are correct for the Goes TRUE setting in the Trigger When menu. If that menu is set to Goes False, swap the definition for AND with that for NAND and for OR with NOR for both pattern and state types.

³ The logic inputs are channels 1, 2, 3, and 4 when using Pattern triggers. For State triggers, channel 4 becomes the clock input, leaving the remaining channels as logic inputs.

⁴ The logic inputs are channels 1, 2, 3, and 4 when using Pattern triggers. For State triggers, channel 4 becomes the clock input, leaving the remaining channels as logic inputs.

⁵ The logic inputs are channels 1, 2, 3, and 4 when using Pattern triggers. For State triggers, channel 4 becomes the clock input, leaving the remaining channels as logic inputs.

⁶ The logic inputs are channels 1, 2, 3, and 4 when using Pattern triggers. For State triggers, channel 4 becomes the clock input, leaving the remaining channels as logic inputs.

| Pattern | State | Definition ^{7, 8} |
|--|--|---|
| AND  | Clocked AND  | If all the preconditions selected for the logic inputs ⁹ are TRUE, then the instrument triggers. |
| NAND  | Clocked NAND  | If not all of the preconditions selected for the logic inputs ¹⁰ are TRUE, then the instrument triggers. |
| OR  | Clocked OR  | If any of the preconditions selected for the logic inputs ¹¹ are TRUE, then the instrument triggers. |
| NOR  | Clocked NOR  | If none of the preconditions selected for the logic inputs ¹² are TRUE, then the instrument triggers. |

Trigger on a logic state

Use the following procedure to trigger the instrument when all of the logic inputs to the selected logic function cause the function to be True or False when the clock (channel 4) input changes state.

1. Push the front-panel Advanced button.
2. In the Trigger control window, Open the A Event tab.
3. Select State from the Trigger Type drop-down list.
4. Select a value from the Input Threshold drop-down list for each data channel. The channel inputs combine to form a logic pattern. Each channel can have a value of high (H), low (L), or "don't care" (X). A value is considered high if the channel input voltage is greater than the specified threshold voltage. A value is considered low if the channel input voltage is less than the specified threshold voltage. Use the "don't care" selection for any channels that will not be used as part of the pattern.

NOTE. Channels 1, 2, and 3 represent the data inputs. Channel 4 should be connected to the clock signal.

5. Select either the POS (rising) or NEG (falling) edge for the Clock Channel (Channel 4).
6. To set the Input Threshold voltages, click one of the Threshold Presets buttons to define the level type. If you selected USER, click in the Ch <1–4> entry boxes, and then use the multipurpose knobs or pop-up keypad to set each threshold.
7. Select the Pattern Type Boolean logic function for the combination of input channels. The instrument will trigger on a clock edge when the input waveforms match the specified logic pattern.

NOTE. See [Pattern Triggers](#) for definitions of the logic functions for pattern triggers.

⁷ For state triggers, the definition must be met at the time the clock input changes state

⁸ The definitions given here are correct for the Goes TRUE setting in the Trigger When menu. If that menu is set to Goes False, swap the definition for AND with that for NAND and for OR with NOR for both pattern and state types.

⁹ The logic inputs are channels 1, 2, 3, and 4 when using Pattern triggers. For State triggers, channel 4 becomes the clock input, leaving the remaining channels as logic inputs.

¹⁰ The logic inputs are channels 1, 2, 3, and 4 when using Pattern triggers. For State triggers, channel 4 becomes the clock input, leaving the remaining channels as logic inputs.

¹¹ The logic inputs are channels 1, 2, 3, and 4 when using Pattern triggers. For State triggers, channel 4 becomes the clock input, leaving the remaining channels as logic inputs.

¹² The logic inputs are channels 1, 2, 3, and 4 when using Pattern triggers. For State triggers, channel 4 becomes the clock input, leaving the remaining channels as logic inputs.

8. In the Trigger if Logic State drop-down list, select True to trigger the instrument when the logic patterns are true. Select False to trigger the instrument when the logic patterns are false.



TIP. For simplest operation, leave this control set to True. Setting the control to False complements the output of the chosen pattern function (for example, from AND to NAND or NOR to OR).

9. You can set the mode and holdoff for all standard trigger types. Refer to [trigger mode](#) and set [holdoff](#) to learn more about trigger mode and holdoff.

Trigger on the transition time

Use the following procedure to detect and trigger on pulse edges that traverse between two thresholds at faster or slower rates than the specified time. You can set up the instrument to trigger on positive or negative edges.

1. Push the front-panel Advanced button.
2. In the Trigger control window, Open the A Event tab.
3. Select Transition from the Trigger Type drop-down list.
4. Specify the trigger source. Click Source; then select a channel from the drop-down list.
5. Click a Polarity button to specify the direction of the pulse edge:
 - Pos. Monitors the transition time (slew rate) of the positive-going edges of pulses. The edge must first cross the lower threshold and then cross the upper threshold.
 - Neg. Monitors the transition time (slew rate) of the negative-going edges of pulses. The edge must first cross the upper threshold and then cross the lower threshold.
 - Either. Monitors positive- and negative-going edges of pulses. The edge may first cross either threshold and then cross the other.
6. The threshold levels and the delta time setting determine the transition time (slew rate) setting. The level settings determine the voltage component of slew rate (Volts/Second). Click in the Upper Level or Lower Level entry boxes; then use the multipurpose knobs or pop-up keypad to set the values for the upper and lower levels.

NOTE. You can set the level(s) to a value appropriate to either the TTL or ECL logic families by clicking TTL or ECL on the Level pop-up keypad.



TIP. To use the trigger level marker to help in setting threshold levels, open the Display control window Objects tab; then click Long to activate the marker.

7. To finish specifying the slew rate (transition time), set the time component by clicking in Time entry box; then use the multipurpose knob or keypad to set the delta time value.

8. In the Transition drop-down list:

NOTE. On MSO/DPO5000B Series instruments, < or > options are available instead of Less Than or Greater Than.

- Click Less Than to trigger when the transition time is less than the time you set above.
- Click Greater Than to trigger when the transition time is greater than the time you set above.

NOTE. If you select Transition Greater Than, and the instrument does not trigger, the pulse edge may be too fast. To check the pulse edge speed, switch to edge triggering. Trigger on the pulse edge and determine the time the edge takes to travel between the upper and lower levels that you set for this trigger. The instrument cannot transition trigger on pulse edges that traverse between threshold levels in 600 ps or less. Also, to reliably trigger on transition time, a pulse must have a width of 7.5 ns or more. A pulse of less width may trigger on the wrong slope or not trigger at all. Switch to edge triggering, and check the pulse width if you cannot trigger on transition time as expected.

9. You can also Trigger on a logic-qualified pulse using the Trigger if Violation "Logic" selection. When the instrument detects that a transition violation has occurred, it checks the logical state of two other available channels and triggers only if their conditions are met. Each channel can have a value of high (H), low (L), or "don't care" (X). A value is considered high if the channel input voltage is greater than the specified threshold voltage; a value is considered low if the channel input voltage is less than the specified threshold voltage. Use the "don't care" selection for any channels that will not be used as part of the pattern.
10. You can set the mode and holdoff for all standard trigger types. Refer to [trigger mode](#) and set [holdoff](#) to learn more about trigger mode and holdoff.

Trigger on setup-hold time violations

Use the following procedure to detect and trigger on setup and hold time violations. The setup and hold times define a violation region relative to a clock. Data is considered to be invalid in the violation region.

1. Push the front-panel Advanced button.
2. In the Trigger control window, open the A Event tab.
3. Select Setup/Hold from the Trigger Type drop-down list.
4. Specify the channel that is connected to the data signal. Click Source; then select a channel from the drop-down list.
5. Specify the channel that is connected to the clock signal. Click Clock Source; then select a channel from the drop-down list.

NOTE. Do not select the same channel for both the data and clock sources.

6. The Clock Edge determines whether the instrument finds the trigger point on the rising edge or the falling edge of the clock signal. Click a Clock Edge button.
7. To set the data transition level, click in the Data Level entry box, and then use the multipurpose knobs or pop-up keypad to set the value.
8. The instrument uses the clock level to determine when a clock edge occurs; the point that the clock crosses the clock level is the reference point from which it measures setup and hold time settings. To set the clock threshold level, click in the Clock Level entry box, and then use the multipurpose knobs or pop-up keypad to enter a value.

NOTE. Both Clock and Data Levels can be set to a value appropriate to either the TTL or ECL logic families by clicking TTL or ECL on the Data Level or Clock Level pop-up keypads.

9. To set the setup time relative to the clock, click in the Setup Time entry box, and then use the multipurpose knob or pop-up keypad to enter a value.

10. To set the hold time relative to the clock, click in the Hold Time entry box, and then use the multipurpose knob or pop-up keypad to enter a value.

NOTE. Positive setup time always leads the clock edge; positive hold time always follows the clock edge. Setup time always leads the hold time by at least 2 ns ($T_S + T_H \geq 2$ ns). Attempting to set either time to reduce the 2 ns limit adjusts the other time to maintain the limit. In most cases, you will enter positive values for both setup and hold time. Positive values set the instrument to trigger if the data source is still settling inside the setup time before the clock or if it switches inside the hold time after the clock. You can skew this setup/hold violation zone by entering negative values as shown below.

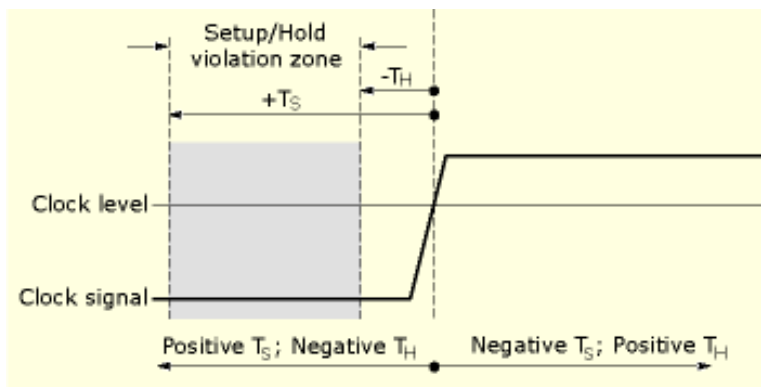
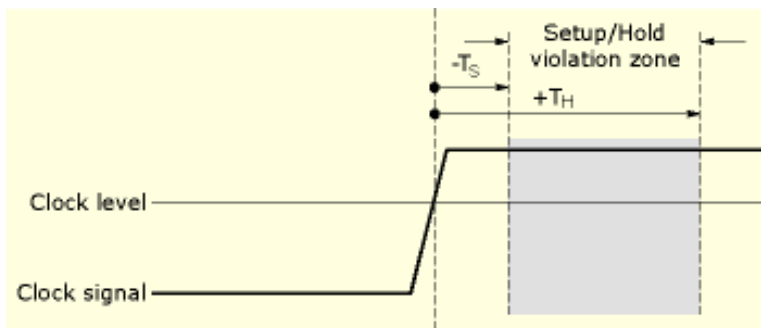
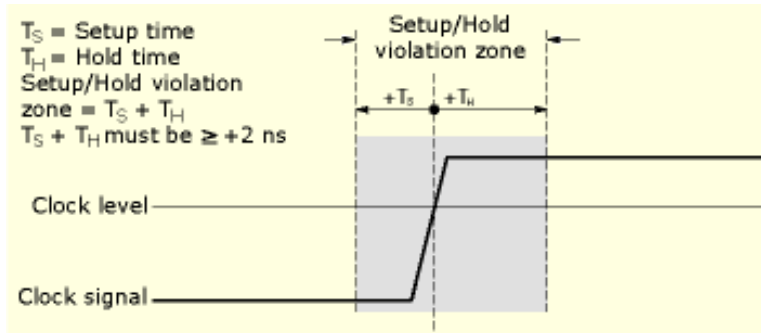

11. You can set the mode and holdoff for all standard trigger types. Refer to [trigger mode](#) and set [holdoff](#) to learn more about trigger mode and holdoff.

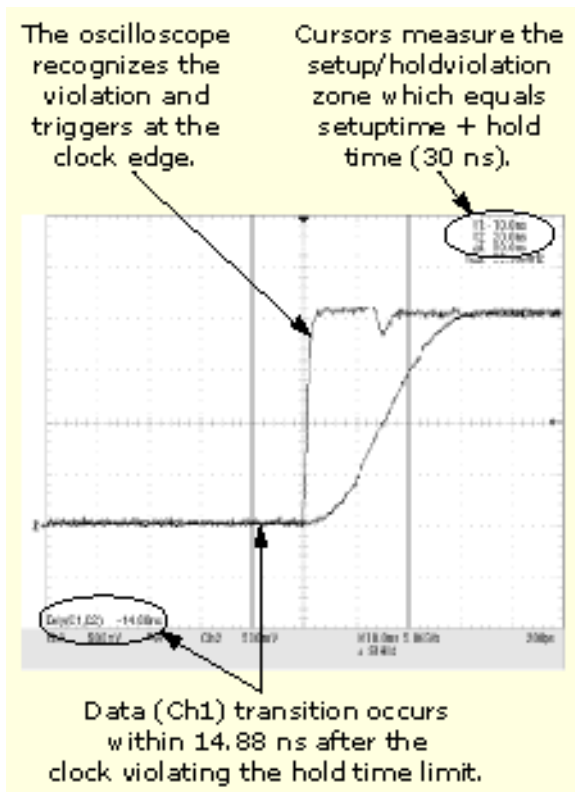

Set up and hold violation trigger

Trigger on window threshold violations

Use the following procedure to trigger the instrument when the input signal rises above an upper threshold level or falls below a lower threshold level.

1. Push the front-panel Advanced button.
2. In the Trigger control window, Open the A Event tab.
3. Select Window from the Trigger Type drop-down list.
4. To specify which channel becomes the trigger source, click Source; then select a channel from the drop-down list.
5. The upper and lower threshold levels define the voltage limits of the window. To set the threshold levels, click in the Upper Level or Lower Level entry boxes, and then use the multipurpose knobs or pop-up keypad to enter the values
6. To qualify the window trigger, select from the Window Event drop-down list combinations. The Window Event controls change as you select different combinations of options:
 - Enter Window and Occurs or Exits Window and Occurs. Triggers the instrument when the signal enters (or leaves) the window defined by the threshold levels.
 - Inside > t and Occurs or Outside > t and Occurs. Triggers the instrument when the signal enters (or leaves) the window defined by the threshold levels for the time specified by Width.
 - Inside > t and Logic or Outside > t and Logic. When the instrument detects a signal entering or leaving the window defined by the threshold levels, it checks the logic state of up to two other available channels and triggers only if their conditions are met. Each channel can have a value of high (H), low (L), or "don't care" (X).

A value is considered high if the channel input voltage is greater than the specified threshold voltage; a value is considered low if the channel input voltage is less than the specified threshold voltage. Use the "don't care" selection for any channels that will not be used as part of the pattern.

1. You can set the mode and holdoff for all standard trigger types. Refer to [trigger mode](#) and set [holdoff](#) to learn more about trigger mode and holdoff.

Trigger on a video signal

Use the following procedure to detect and trigger on a video signal. This feature is only available on some instruments. Only composite signal formats are supported. Graphic display formats such as RGB and VGA are not supported.

1. Push the front-panel Advanced button.
2. In the Trigger control window, Open the A Event tab.
3. Select Video from the Trigger Type drop-down list.
4. To specify which channel becomes the trigger source, click Source; then select a channel from the drop-down list.
5. Select a signal format from the Format drop-down list:
 - If using a preset format, click the Lines and Fields Autoselect buttons to optimize the instrument for viewing the fields or lines for your chosen format
 - If you select the Custom signal format, no Autoselect options are available. You must set the Scan Type (Interlaced or Progressive) and Scan Rate.
 - Custom scan rates enable you to trigger on nonbroadcast video signals that have unique scan rates. Select the scan rate that includes your signal.
6. Select a value from the Trigger On drop-down list to specify where the trigger will occur on the video signal:
 - Field. Use the drop-down list to select either Odd, Even, or All.
 - All Lines. The trigger will occur on any and all lines.
 - Line #. Use the multipurpose knob or pop-up keypad to set the line number. Line numbers wrap when their limits are reached. The range of line numbers depends on the format.
7. Specify the Holdoff from the drop-down list, By Time or By Fields, then use the multipurpose knob to change the value. If setting a Custom format, only the By Time control is available.
8. Select the Polarity:
 - Normal. Generally triggers on negative polarity, since the sync pulse leading edge is negative for most standard formats.
 - Inverted. Use when probing circuitry that inverts the video signal.
9. You can set the mode and holdoff for all standard trigger types. Refer to [trigger mode](#) and set [holdoff](#) to learn more about trigger mode and holdoff.

Trigger on a communication signal

Use the following procedure to set up the instrument to trigger on a communication signal:

NOTE. The Comm Trigger is designed to work with communications mask and standard testing. Mask testing automatically uses Communication triggers. You must install the [Serial Communications Mask Testing Option](#) on some instruments before you can access the Comm triggers. Comm triggers are not available on DPO7000SX instruments.

1. Push the front-panel Advanced button.
2. In the Trigger control window, Open the A Event tab.

3. Select Comm from the Trigger Type drop-down list.
4. To specify the trigger source, click Source; then select a channel from the drop-down list.
5. Select Clock or Data from the Type drop-down list. If you select Clock, you will also need to select the polarity.
6. Select the Coding format for triggering on a communication signal and the Standard to use with the coding format. The coding format determines which standards are available as well as other parameters, such as trigger threshold and pulse form. The standard sets the bit rate. Changing the bit rate will change the Standard to Custom.
7. Depending on the coding format, you may also need to set the Pulse Form and Threshold Level.
8. Follow the [Setting up Mask Testing](#) procedure to select the communications mask you want to use.

Trigger on a bus

NOTE. Triggering on a serial bus may require an option on your instrument.

Use the following procedure to set up the instrument to trigger on a parallel or on a serial bus:

1. Push the front-panel Advanced button.
2. In the Trigger control window, open the A Event tab.
3. Select Bus from the Trigger Type drop-down list.
4. Select if the Settings are to be Shared or Independent.
5. Select the Bus to trigger on from the drop-down list.

The type of bus displays below the bus selection.

6. Select the condition in the Trigger On field.

Depending on the Trigger On and Bus selections, make the other selections and settings required by your bus, such as disparity, symbols, data and address format, payload length, and trigger when.

Mark all trigger events

Use the following procedure to set up the instrument to mark all trigger events:

1. From the Trigger menu, select A-Event (Main) Trigger Setup.
2. In the Trigger control window, open the A Event tab.
3. Select a trigger type such as Edge from the Trigger Type drop-down list.
4. Set up your trigger as desired.
5. Click Mark All Trigger Events in Record.

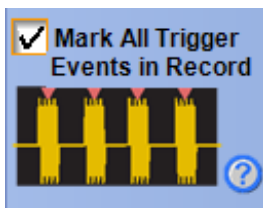

- The instrument searches for and marks all similar events that meet the trigger requirements. The results of the search are shown as marked events on screen, and they can also be viewed in the Results tab of the Mark Table.

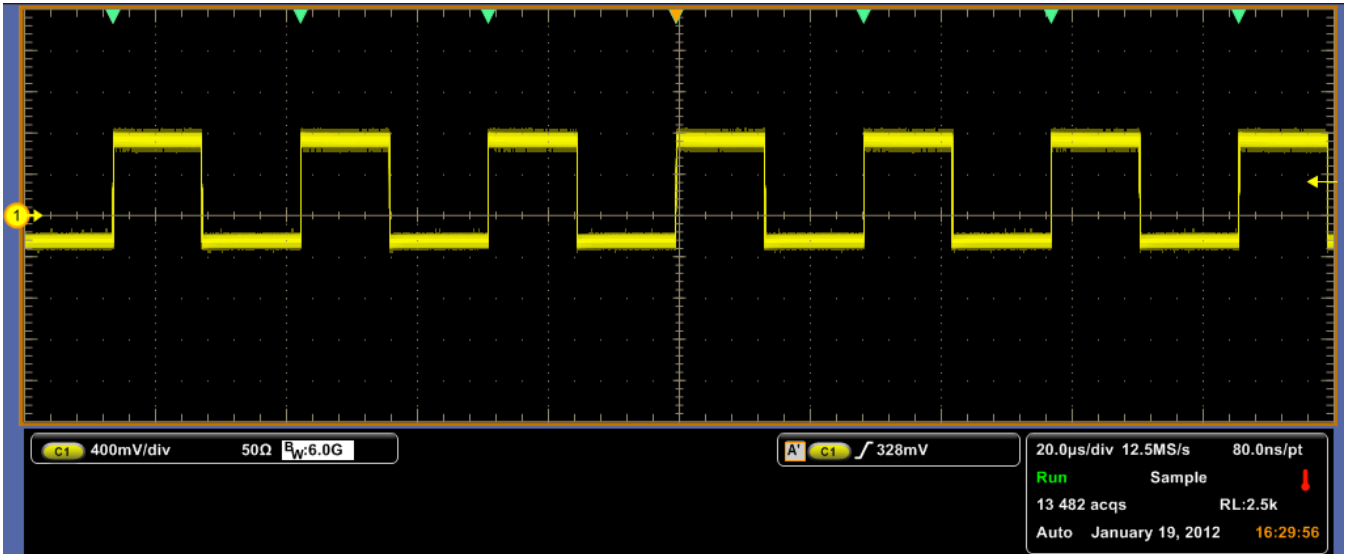

- From the Analyze menu select Search, and then select the Results tab. The results of the search are displayed and will include the visual trigger area.

Results: Mark Table

| Select | Index | Type | Source | Location | Time Delta | | | | | Description |
|-----------|----------------|--------------|--------|-----------|------------|-----|-----|-----|-----|--------------------|
| | | | | | sec | ms | us | ns | ps | |
| Configure | 1 | Current Trig | C1 | -85.989us | | | | | | +Edge: level=328mV |
| | 2 | Current Trig | C1 | -57.345us | 000 | 000 | 028 | 644 | 199 | +Edge: level=328mV |
| | 3 | Current Trig | C1 | -28.682us | 000 | 000 | 028 | 662 | 607 | +Edge: level=328mV |
| Results | 4 | Current Trig | C1 | 1.952ns | 000 | 000 | 028 | 684 | 430 | +Edge: level=328mV |
| | 5 | Current Trig | C1 | 28.653us | 000 | 000 | 028 | 650 | 723 | +Edge: level=328mV |
| | 6 | Current Trig | C1 | 57.293us | 000 | 000 | 028 | 640 | 282 | +Edge: level=328mV |
| View | Total Marks: 7 | | | | ?Z1,Z2 | | | | | |
| | | | | | ?Z2,Z3 | | | | | |
| Mode | | | | | ?Z1,Z3 | | | | | |

Search Marks: Save Save All Clear Digits >> <<Digits All Marks: Export Clear View Count

- You can also add a visual trigger area. See [Visual Trigger Setup](#)

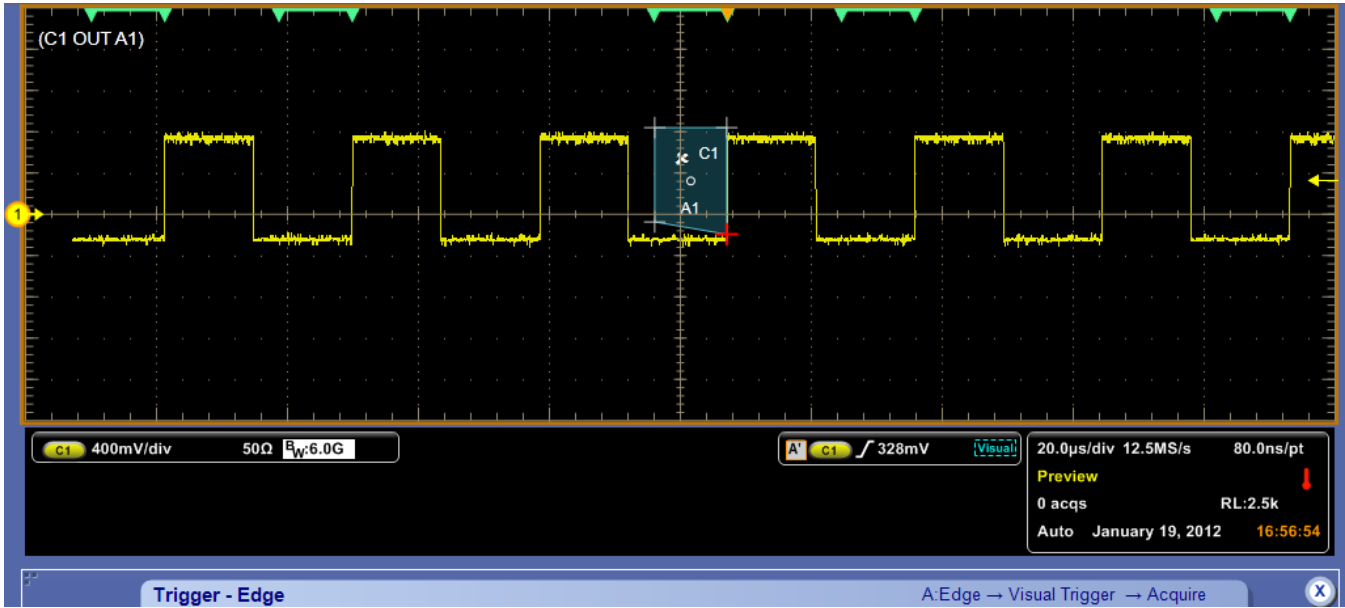

- The results of the edge trigger and the visual trigger are also displayed in the search results.

Results: Mark Table

| Select | Index | Type | Source | Location | Time Delta | | | | | Description |
|----------------|-------|--------------|--------|-----------|------------|-----|-----|-----|-----|--------------------|
| | | | | | sec | ms | us | ns | ps | |
| Configure | 1 | Current Trig | A1 | -85.931us | | | | | | +Edge: level=328mV |
| Results | 2 | Current Trig | A1 | -57.286us | 000 | 000 | 028 | 644 | 675 | +Edge: level=328mV |
| View | 3 | Current Trig | A1 | -469.362p | 000 | 000 | 057 | 285 | 557 | +Edge: level=328mV |
| Mode | 4 | Current Trig | A1 | 28.635us | 000 | 000 | 028 | 635 | 587 | +Edge: level=328mV |
| | 5 | Current Trig | A1 | 85.915us | 000 | 000 | 057 | 280 | 000 | +Edge: level=328mV |
| Total Marks: 5 | | | | ?Z1.Z2 | | | | | | |
| | | | | ?Z2.Z3 | | | | | | |
| | | | | ?Z1.Z3 | | | | | | |

Search Marks: Save Save All Clear Digits >> << Digits All Marks: Export Clear View Count

NOTE. Mark All Trigger Events in Record is not available with some trigger types.

Using histograms

Set up a histogram

Use the following steps to set up a histogram:

1. From the Measure menu, click Waveform Histograms to open the Waveform Histogram Setup window.
2. Use the [Channels Selector](#) to select the waveform, and then use the other instrument controls to position the waveform in the center of the screen.
3. Use the Histogram Mode controls to turn on the histogram, click either Horiz or Vert.
4. Under Adjust Histogram Box, click Location.
5. Click in an X Position or Y Position entry box; then use the multipurpose knobs to position the histogram box over the area of interest on the waveform.
6. Under Adjust Histogram Box, click Limits.
7. Click in a Left/Right Limit or Top/Bottom Limit entry box; then use the multipurpose knobs to adjust the size of the histogram box.
8. Select the type of scaling by clicking either Linear or Log under Histogram Scaling.



TIP. Click the waveform handle to [select the waveform](#). Hold the left mouse button and drag across the segment of the waveform that you want the histogram to cover; then select Histogram from the pop-up list on the screen.

What do you want to do next?

[Taking Automated Measurements on Histogram Data.](#)

Take automated measurements on histogram data

Use the following steps to take automatic measurements on histogram data:

1. Set up a histogram box over the waveform on the screen.
2. Open the Measurement Setup control window, and then select the Histogram tab.
3. Click the histogram measurement buttons to add the measurements to the display readouts list.

What do you want to do next?

[Setting up a Vertical Histogram.](#)

Start or reset histogram counting

Use this procedure to quickly take a measurement based on the default settings for histograms:

1. Display the waveform(s) to be measured on the screen.
2. From the Measure menu, click Waveform Histograms to open the Waveform Histogram Setup window.
3. Use the [Channels Selector](#) to select the waveform, and then use the other instrument controls to position the waveform in the center of the screen.
4. Click a Histogram Mode button to start histogram counting and display the histogram data:
 - Horiz. Displays a horizontal histogram that shows how time varies in the histogram box.
 - Vert. Displays a vertical histogram that shows how your vertical units vary in the histogram box.

- Off/On. Turns histogram counting and the display on or off.

NOTE. You can only display one type of histogram at a time. Horizontal histograms have a maximum of 1000 bins while, vertical histograms have a maximum of 252 bins.

5. Click a Histogram Scaling option:
 - Linear. Displays histogram data linearly. Bin counts smaller than the maximum counts are scaled linearly by dividing the bin count by the maximum bin count.
 - Log. Displays histogram data logarithmically. Bin counts smaller than the maximum counts are scaled logarithmically. Logarithmic scaling provides better visual details for bins with low counts.
6. Click Adjust Histogram Box Limits, and then use the Top Limit, Bottom Limit, Left Limit, and Right Limit controls to set the size of the histogram box. The histogram box selects the section of the waveform used for histograms.
7. Click Adjust Histogram Box Location, and then use the X Location and Y Location controls to set the location of the histogram box.
8. Click Reset to reset the histogram count. Histograms track numbers of counts. Clicking Reset resets those counts to zero and begins counting from zero.
9. Click Display to toggle the display of the selected histogram on and off.



TIP. To clear histogram data, right-click in the display area, and then select Clear Data from the short cut menu.

Using display modes

Display a waveform

This procedure demonstrates the display adjustments you can make.

1. Connect a signal to an [input channel](#).
2. Press Run on the front-panel.
3. Push the Ch <1–4> button for the channel that has the signal connected to it.
4. Adjust the front-panel vertical controls to achieve a good display of the waveform.
5. Use the front-panel horizontal knobs to adjust the Scale and Position of the waveform and to set the sample Resolution.

NOTE. The Resolution knob also sets the record length. (See [Horizontal acquisition window interrelated parameters](#) for details.)

6. Push the Level knob (Set 50%) if required to stabilize the display.
7. To adjust the point around which the waveform expands and contracts, click on the horizontal reference marker, and drag it along the horizontal axis until it aligns to the point on the waveform that you want to be stationary on screen.

NOTE. If horizontal delay is off, the horizontal reference point is the same as the horizontal position.

8. Release the Horizontal Reference, and then adjust the Horizontal Scale to expand or contract the waveform.

Horizontal reference marker



Set up XY display format

Use the following steps to set up the instrument in XY Display format:

1. Determine the *waveform pairs* you want to display.
2. Click Display in the toolbar, or select Appearance in the Display menu.
3. In the Display control window, open the Appearance tab.
4. Under Format, click the XY button.
5. Use the vertical scale and position controls of the waveform connected to the X-axis source to set horizontal scale and position of the XY waveform.
6. Use the vertical scale and position controls of the waveform connected to the Y-axis source to set vertical scale and position of the XY waveform.

Use MultiView zoom with waveforms

The instrument must be installed and operating, with a signal connected to an input channel, and the horizontal and vertical controls and triggering set up.

1. Obtain a stable display of the waveform to be measured.
2. Click and drag across the segment of the waveform that you want to see in greater detail.
3. Select Zoom <1-4> On from the shortcut menu to magnify the highlighted waveform segment.

NOTE. The instrument displays the zoomed area of the waveform as magnified in the bottom graticule. You can also press the front-panel MultiView Zoom button to split the screen and add a zoom graticule.

4. To zoom on multiple areas, repeat steps 2 and 3.
5. Push the front-panel MultiView Zoom button to select the axis you want to focus on in the zoom graticule. The Zoom control window opens, if it is not already present.

NOTE. If zoom is on but the readouts are not attached to the zoom controls, press the MultiView Zoom button to attach the readouts to the zoom controls. Press the MultiView Zoom button again to turn zoom off.

6. To select the waveform you want to scale or position, press the Horiz and Vert buttons.
7. Select the Channel (Ch), Math, or Reference (Ref) waveform from the drop-down list.
8. Use the multipurpose knobs to adjust the Position and Factor of the zoomed waveform. Note that as you adjust the factor or position, the instrument adjusts the Zoom box relative to the unmagnified waveform.
9. Click Setup in the Zoom control window to open the Zoom Setup control window.
10. To change the size of the unmagnified (Acquisition) and Zoom windows, select one of the following from the Graticule Size drop-down list:
 - 50-50. Allocates half of the available display for the zoomed graticule and half of the available display for the acquisition window.
 - 80-20. Allocates 80% of the available display for the zoomed graticule and 20% for the acquisition window.
 - Full. Uses the entire display for the zoomed graticule.

11. Click the Lock and Scroll tab to select a zoom lock and scroll setting:
 - To scroll a single zoomed area, click Zoom <1–4>, and then click an AutoScroll button.
 - To scroll multiple zoomed areas simultaneously, click Lock, and then click the Zoom <1–4> buttons you want to scroll through.
12. To quickly determine the magnification factor and position of a zoomed waveform, check the controls on the appropriate tab (Horizontal or Vertical) of the Zoom Setup control window.
13. To reset all Zoom settings to their defaults, click the Position Factor Reset button in the Zoom Setup control window.

Choosing a color palette

Choose a color palette

Use the following information to help you select a color palette:

1. Select Colors In the Display menu, or click Display in the toolbar.
2. Open the Colors tab.
3. Under Record View Palettes or FastAcq/WfmDB Palettes, click a button to select a palette for your application. Use the following criteria:
 - Normal. Use this palette to display hues and lightness levels for best overall viewing. Every waveform has its own color: shades of yellow for channel one; shades of blue for channel two, shades of pink for channel three, shades of green for channel four.
 - Green. Use this palette to display waveforms and the graticule style in shades of green. The Green palette simulates the display of an analog oscilloscope. Areas of the waveform with the highest sample density appear in lighter shades while the areas of lower sample density appear in darker shades.
 - Gray. Use this palette to display waveforms and the graticule in shades of gray. Areas of the waveform with the highest sample density appear in lighter gray shades, while areas of the waveform with lower sample density appear in darker gray shades.
 - Temp. Use this (temperature) palette to display variable persistence style waveforms. Areas of the waveform with the highest sample density appear in warmer colors (red shades), while areas of the waveform with lower sample density appear in cooler colors (blue shades). This palette is best suited for seeing detail within a single waveform.
 - Spectral. Use this palette to display variable persistence style waveforms. Areas of the waveform with the highest sample density appear in blue shades, while areas of the waveform with lower sample density appear in red shades. This palette is best suited for seeing detail within a single waveform.
 - User. Use this palette to select a color previously defined for the User palette.

NOTE. To define a custom color for the User palette, click the Edit button and follow the steps to [Customize Color Palettes](#).

Customize the display palette

From the Display menu, select User Palette, or click the Edit button in the Colors tab of the Display control window.

Overview. Use this control window to customize the color of your waveform display.



To use.

1. Click the Source drop-down list to select the waveform for which you want to change the color.
2. Select HLS from the Wfm Palette drop-down menu; then click in the Hue, Saturation, or Lightness entry boxes and use the multipurpose knobs to adjust the percentage of each of these attributes.
3. If you prefer:
 - Select Temp (Temperature Grading) from the Wfm Palette menu to define areas of the waveform with the highest sample density to appear in warmer colors (red shades) while the areas of lowest sample density appear in cooler colors (blue shades).
 - Select Spectral (Spectral Grading) from the Wfm Palette menu to define areas of the waveform with the highest sample density to appear in blue shades while the areas of lowest sample density appear in red shades.
4. Click the Reset button to return the User palette to the default, if desired.

To activate the Display Setup Control Window, click the Setup button.

Behavior. Increasing the hue value changes the color to blue tones. Decreasing the hue value changes the color to red tones. For best viewing, set the lightness to 50. Higher numbers tend to wash out the color and lower numbers can darken the color and make it difficult to see. Lower saturation values reduce the amount of color displayed in the waveform. Higher saturation values increase the amount of color.

What do you want to do next?

[Learn about changing the display colors.](#)

[Learn about changing the overall display appearance.](#)

[Learn about the display persistence.](#)

Saving and restoring instrument setups

Save the instrument setups

Use the following procedure to save the current setup to oscilloscope memory:

1. Use the instrument controls to set up the instrument for your application.
2. From the File menu, highlight Save As; then select Setup from the submenu.
3. In the Save As dialog box, select one of the 10 locations under Save in Oscilloscope Memory.
4. In the Save in drop-down list, specify where to save the setup.
5. In the Name list box, enter a name for the setup, use the default name, or select [Auto-increment file name](#) if you want to save a series of files without typing in a new name each time.
6. Click Save.

7. Click OK to overwrite an existing instrument setup, if desired.

NOTE. *The data in reference waveforms is not saved with the instrument setups. However, the setup information includes which reference waveforms are turned on and which are used with math waveforms and automatic measurements. If you want to save the reference waveform data, save the reference waveform separate from the instrument setup.*

Further note that user preferences and GPIB configurations are not stored with instrument setups, and are not affected by the front panel Default Setup button.

What do you want to do next?

[Create Reference Waveforms.](#)

Recall an instrument setup

Use this procedure to recall a saved instrument setup:

1. From the File menu, select Recall.
2. In the Recall dialog box, click the Setup icon.
3. Navigate to the location where you saved the setup file
4. Select the setup, then click Recall.

NOTE. *The data in reference waveforms is not saved with instrument setups. However, the setup information does include which reference waveforms are turned on and which are used with math waveforms and automatic measurements. If you want to save the reference waveform data, save the reference waveform separate from the instrument setup. You can then recall the saved waveform to the restored setup.*

Delete instrument setups

Use this procedure to delete all instrument setups previously saved to the oscilloscope memory.

1. From the File menu, highlight Delete; then select All Setups from the submenu.
2. In the resulting Delete all setups? dialog box, click Yes.

Use the following procedure to delete an instrument setup previously saved to a Windows directory.

1. From the File menu, select Recall.
2. In the Recall dialog box, click Setup.
3. Navigate to the directory where the setup was saved
4. Select the setup.
5. Click the  next to the directory.

Using the programmer online guide

Programmer online help

You can control the instrument via GPIB (on some instruments), from a remote PC, or from an Internet or Intranet connection. Programming information is available as a separate file you can install.

Using application software

Oscilloscope applications software

You can install and run optional application software packages on the instrument. These software packages provide advanced capabilities that support several applications, such as jitter analysis and disk drive measurements.

Each application can be purchased and installed on the instrument at any time. Contact your Tektronix representative for purchasing information. Follow the installation instructions that come with the application.

To open your application software on the instrument, click Analyze in the menu bar, and then select the application to run.

NOTE. Application software packages have their own online help that is separate from the main instrument online help.

Add a software application to the instrument

Because the instrument is an open Windows platform, you can easily install and remove additional software applications. Follow the instructions that came with your software and the basic Windows instructions to install and remove your application.

NOTE. When adding software to the instrument, avoid making changes to system files. See [Windows Interface](#) for more information.

Setting up a dual display

Set up a dual display

Use the following steps to set up the instrument for dual display operation. You can use the main display for most instrument operations while you use a second monitor to access other PC applications that you may have installed.

You can also drag up to five dockable control windows from the TekScope application onto the display of the second monitor.

For example, this feature allows you to have the Horizontal/Acquisition, the Horizontal Zoom, and the Display Setup Control Windows (half screen) open on the second monitor at the same time.

In addition to the five dockable windows on the second monitor, you can have one dockable window open on the main display. If you open a seventh dockable window, whichever window has not been used for the longest amount of time will automatically close.

TIP. You may want to print this procedure since it requires you to power off the instrument.



1. Power off the instrument.
2. Connect an external monitor to a video port on the instrument.
3. Connect a keyboard and mouse.
4. Power on the instrument and external monitor.

5. After the instrument display appears, click Minimize in the File menu or press **CTRL+M** to minimize the instrument application.
6. Right-click on the desktop and select Properties to open the Display Properties dialog box.
7. Open the Display Devices tab to define the Operating Mode and Display Selection of the monitors.
8. In the Display Selection drop downs, set the Primary Device to Notebook, and set the Secondary Device to Monitor.
9. In the Operating Mode drop down, select Extended Desktop.

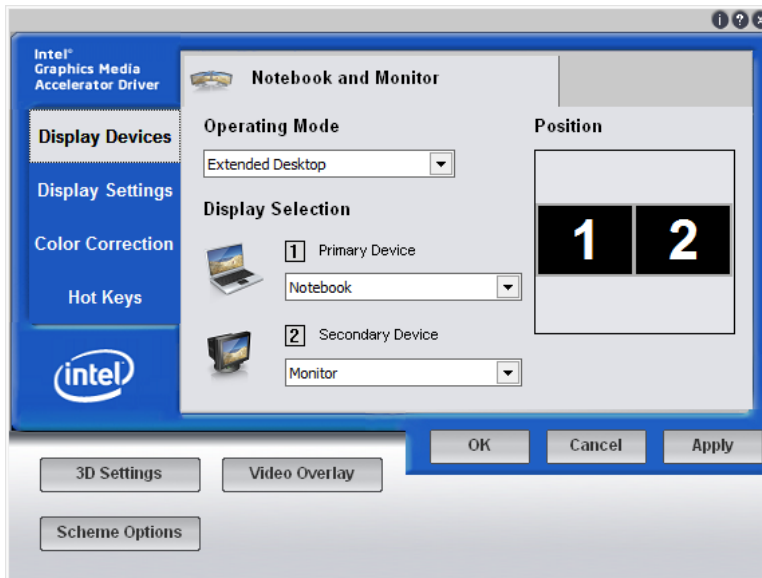

NOTE. Do not change the display settings for the internal monitor. The display settings must be 1024 x 768 pixels and colors must be set to 32-bit color. Ensure that the second monitor is also set to 32-bit color. If you use other instrument display settings, the video port may not work properly. However, you can use a resolution setting other than 640 x 480 on the second monitor.

10. Click Apply.
11. Click OK.
12. Click OK.
13. Drag any item, except for the instrument application, from the desktop of the instrument to the new monitor. You can also drag the task bar.

Connecting to a network

Enable a network connection

Use the following steps to enable network access to the instrument. You must begin this procedure with the instrument powered off.



TIP. You may want to print these instructions before you proceed.

1. Attach a keyboard and mouse to the instrument.
2. Power on the instrument.
3. Use the Windows Network Connection Wizard to define the instrument as a network client and configure it for your network. You can find the network setup program in the Windows Start menu if you select Settings > Control Panel, and then double-click Network Connections.
4. Consult with your network administrator for specific instructions for these settings.

Exiting or minimizing the oscilloscope application

Exit the instrument application

From the File menu, click Exit to quit the instrument application or click the  icon in the upper-right corner of the screen.

To restart the instrument application, launch the TekScope icon from the Windows taskbar, Start menu, or your desktop.

Minimize the instrument application

To temporarily close the TekScope application (so you can use other Windows programs):

- Select Minimize from the File menu.
- Right-click anywhere in the graticule and select Minimize from the shortcut menu.
- Click the  button in the Menu bar.

To restore the application, click the TekScope icon in the Windows taskbar.

Shut down the instrument

When you push the front-panel *On/Standby switch*, the instrument starts a shutdown process (including a Windows shutdown to preserve settings) before it goes into standby mode. Avoid disconnecting the power cord to shut down the instrument.

NOTE. It may be necessary to hold the *On/Standby switch* for up to 20 seconds for the shutdown process to initiate.

To completely remove power to the instrument, perform the shutdown process described above, and then disconnect the power cord from the power source.

Adjusting display contrast

Adjust the display contrast

If you find that the instrument screen is too bright or too dark, use these steps to adjust the LCD display contrast to your preference. You need to have a mouse attached to perform this procedure.

1. Right-click on the Windows desktop.
2. Select Properties.
3. Select the Settings tab.
4. Click Advanced.
5. Select the Color tab.
6. Adjust slider controls for desired contrast.
7. Click OK to apply.

Oscilloscope reference

Functional model

The instrument has four high-level subsystem processes, consisting of both hardware and software functions, and the data that connects them.

Digital signal acquisition system

This system acquires a waveform record from each input signal you probe. This system consists of the following subsystems:

- **Input Channels.** Condition the input signal, primarily through the use of analog hardware, before converting the signal to a digital format.
- **Trigger System.** Recognizes a specific event of interest on the input signal and informs the Time base system of the occurrence of the trigger event
- **Time base System.** Triggers the Acquisition system to start an acquisition cycle. In more general terms, synchronizes the capturing of digital samples in the Acquisition system to the trigger events generated from the Trigger system.

Acquisition system

This system converts and stores the analog signal to a digital format.

Signal processing and transformation

This system performs transformations or operations on user-specified waveform data (channel, reference, and/or math waveforms). Automatic measurements, spectral waveforms, and histogram generation are examples of signal processing and transformation.

Display and UI

This system provides output (and sometimes input) of instrument-data elements in a form suitable to the user and also provides user input control.

What do you want to do next?

[Learn about a process overview of the instrument operation.](#)

[Learn about the Acquisition System.](#)

[Learn about the Display.](#)

Process overview

Process overview

1. The instrument starts in the idle state; it enters this state at power on, upon receiving most control setting changes, or on finishing acquisition tasks.
2. Control settings are implemented as they are requested. When you toggle the Run/Stop control to Run, the instrument starts the hardware.
3. The instrument acquires samples until the pretrigger portion of the waveform record (channel) being acquired is filled.
4. The instrument then begins looking for a trigger. Acquiring continues to take place, keeping the pretrigger points current, until triggering criteria are met or a trigger is forced (Auto trigger mode only). The instrument accepts the trigger.
5. The instrument acquires samples until the posttrigger portion of the waveform record (channel) being acquired is filled.
6. If averaging or enveloping is on, the record becomes part of the multi-acquisition record that these modes produce. The process loops back to step 3 to acquire additional records until the number of acquisitions required for the acquisition mode currently set are processed, and then processing continues to step 7.
7. At this point, the acquisition record is in memory and is available to the instrument for measurement of its parameters, display, and so on.
8. The instrument then checks for a user-specified stop condition and either returns to its idle state or continues at step 3, according to what it finds.

Keep in mind that this instrument samples in real time or random equivalent time; both sampling systems provide pretrigger information by using the trigger to stop an already running acquisition. Both sampling systems also sample the input after it is scaled, providing improved input protection and dynamic range.

What do you want to do next?

[Learn about the Acquisition System.](#)

[Learn more about triggering.](#)

Waveform acquisition

Signal connection

This diagram displays the signal connection model for each input channel.

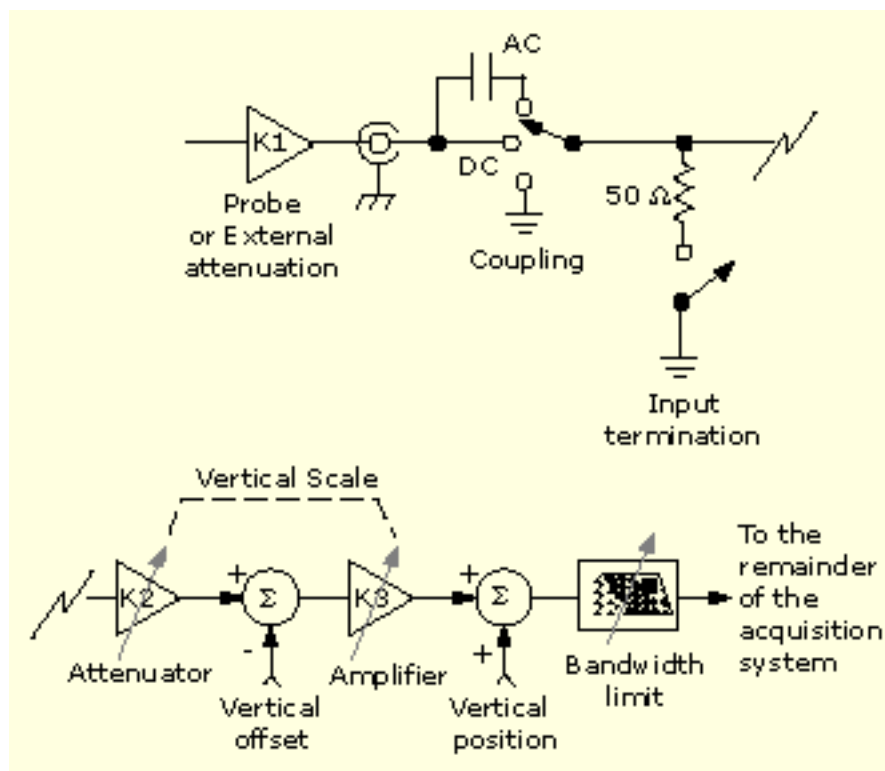

What do you want to do next?

[Learn more about coupling.](#)

[Learn more about the vertical acquisition system.](#)

Probes and signal connection

Select the probe or cable that brings the signal into the instrument. Choose the probe or cable that best fits your acquisition task, whether it is connecting an active probe to test a digital circuit, or connecting to a test fixture through BNC cables to characterize a device. The connection to the instrument depends on your application.

Up to four acquisition channels are available. You can display each channel as a waveform or use the channel data to create other waveforms, such as math and reference waveforms.

Tektronix provides a variety of probes and cables for this product. You can also check your Tektronix catalog for connection accessories to support your probing requirements.

For more information about a particular probe, read the documentation that came with that probe.

What do you want to do next?

[Get a list of compatible probes.](#)

Input conditioning

You can use input conditioning to ensure that the instrument acquires the best possible data for processing.

- Set the [Vertical scale](#) to control the size of the vertical acquisition window for each channel to capture all or part of the input signal vertical amplitude. When vertical scaling is set to capture a fraction of the input signal (to increase detail), the vertical offset control determines which part of the input signal is captured by the vertical acquisition window. (See note.)
- Set the [Horizontal scale](#) to control the size of the horizontal acquisition window to capture as much as you want of the input signal(s). Set the horizontal position to change the trigger position or to delay the window relative to a trigger event and to control where in the input signal (data stream) that the horizontal acquisition window acquires. (See note.)

For additional information on how to use the acquisition windows, refer to the following:

- [Vertical Acquisition Window Considerations](#)
- [Horizontal Acquisition Window Considerations](#)

The instrument can automatically obtain and display a stable waveform of usable size. Push the Autoset button to automatically set the instrument controls based on the characteristics of the input signal. Autoset is much faster and easier than a manual control-by-control setup.

The instrument can also be reset to its factory default settings by pushing the front-panel Default Setup button.

Use of some input conditioning controls or features may be limited when other control settings are in effect. Voltage offset is incompatible with reference waveforms because offset is an acquisition control for live waveforms (channels), not stored waveforms (reference).

NOTE. The terms *vertical acquisition window* and *horizontal acquisition window* refer to the vertical and horizontal range of the segment of the input signal that the acquisition system acquires. The terms do not refer to any display windows on screen.

What do you want to do next?

[Learn more about Autoset.](#)

[Learn about horizontal acquisition interrelated parameters.](#)

Bandwidth enhancement

Bandwidth enhancement is a DSP implemented FIR filter that flattens the oscilloscope frequency response, and makes the phase response more linear. This results in better matching of channel responses and better signal fidelity. On some oscilloscope models, the bandwidth may be extended beyond what the analog channel exhibits, while other models provide no bandwidth extension but use the enhanced filter to reduce noise and provide better signal fidelity.

Bandwidth filtering. The bandwidth enhancement (BW) filter reduces noise and alias magnitudes in the frequency range of the stop band below and above the Nyquist frequency. In oscilloscopes that do not extend the bandwidth, overall noise is reduced when the filter is on. In oscilloscopes that incorporate a small amount of bandwidth extension, the filter increases noise at frequencies just above the transition band but decreases noise at frequencies in the stop band and the aliased stop band. The overall amount of noise with the filter on may be more or less depending on the oscilloscope model and the enhanced filter characteristics used within that model.

The BW enhancement filter will only operate at the base sample rate of the channel A/D converters and is applied at that sample rate. If ET or IT acquisition modes are used, the filter will be applied to the data before interpolation in IT mode and before it is placed into bins in ET mode. If the sample rate is lower than base rate, then the filter will turn off. The vertical bandwidth field will display BW' when the filter is on.

The individual filters are calibrated at manufacturing for each of the four channels and for multiple attenuator settings. The calibrated filters from these attenuator settings are used for the remaining attenuator settings.

For instrument models >3.5 GHz, the bandwidth enhanced filters are calibrated with a reference plane at the SMA, or 2.92 mm TekConnect input to a channel depending on the oscilloscope model.

Controls. From the Menu bar, select Vertical > Bandwidth Enhancement.

- When Analog Only is selected, the bandwidth enhancement filter is not applied to the input data.
- When Digital Filters (DSP) Enabled is selected, the bandwidth enhancement filter is turned on whenever the base sample rate of the channel, or higher, is selected using the horizontal time base controls. When in Enabled, the filter will turn off if the sample rate goes lower than the base rate or if other oscilloscope settings are selected that do not support the filter operation, such as Fast Acquisition.

Coupling

All instruments and probes specify a maximum signal level. Do not exceed the limit, even momentarily, as the input channel or probe may be damaged. Use external attenuators if necessary to prevent exceeding the limits.

Coupling determines whether an input signal is directly connected to the input channel (DC coupling), connected through a DC blocking capacitor (AC coupling), or not connected at all (GND coupling).

The input resistance of each input channel can be 1 M Ω or 50 Ω . To properly terminate signals when using coaxial cables, or to support active probes with different termination requirements, select the termination in the Channel menu Vertical Settings panel.

All probes expect a specific coupling and input termination. Both coupling and input termination are displayed on the screen. If the instrument determines the coupling and termination required by the probe, either implicitly because of the TekProbe/TekVPI interface or through performing a probe compensation, the instrument sets the required coupling and input termination.

Consider the following when you use 50 Ω termination with any channel:

- The instrument does not accurately display frequencies under 200 kHz if AC coupling is selected.
- The instrument reduces the maximum volts per division setting for the channel to 1 V from 10 V (10 V from 100 V with a 10X probe attached), since input amplitudes appropriate for the higher settings would overload the 50 Ω input.

What do you want to do next?

[Learn about the Vertical Setup window.](#)

[Learn about the Termination control window.](#)

Scaling and positioning

The scaling and positioning controls determine the portion of the input signal received by the acquisition system. Set vertical scaling, positioning, and DC offsets to display the features of interest on your waveform and to avoid clipping.

Each waveform Graticule contains ten major divisions. This represents the maximum digitizing range of the instrument for any given vertical scale. Vertical waveform data that is outside (above and/or below) of the waveform Graticule is clipped; that is, the data values exceed the digitizing capability of the ADC at the current settings. This causes inaccuracies in amplitude-related measurements. For more information see [Vertical Acquisition Window Considerations](#).

Set the horizontal scale, position, and resolution (record length) to include the acquired waveform record waveform attributes of interest with good sampling density on the waveform. These settings define the horizontal acquisition window, described in [Horizontal Acquisition Window Considerations](#).

NOTE. The terms vertical acquisition window and horizontal acquisition window refer to the vertical and horizontal range of the segment of the input signal that the acquisition system acquires. The terms do not refer to any display windows on screen.

What do you want to do next?

[Learn about the Vertical Setup Position and Scale controls.](#)

[Learn about the Vertical Offset control.](#)

Vertical acquisition window considerations

You can set the vertical scale, position, and offset of each channel independently of other channels. Vertical scale and offset specify the vertical acquisition window for each channel. Parts of the signal amplitude that fall within the vertical window are acquired; parts outside (if any) are not.

The offset control subtracts a constant DC level from the input signal before the vertical scale factor is applied, and the vertical position control adds a constant number of divisions of signal after the scale factor is applied to the resulting difference.

The vertical scale and position controls have the following affects on the vertical acquisition window and the displayed waveform:

The vertical volts per division you set determines the vertical size of the acquisition window, allowing you to scale it to contain all of a waveform amplitude or only part. Figures A and B below show two vertical acquisition windows that contain the entire waveform, but only the window in Figure B contains the entire waveform in the graticule on screen.

NOTE. Amplitude-related automatic measurements (for example, peak-to-peak and RMS) will be accurate for vertical windows like those shown in Figures A and B below because neither waveform is clipped (that is, both waveforms are acquired). But if signal amplitude were to extend outside the vertical acquisition window, the data acquired is clipped. Clipped data causes inaccurate results if used in amplitude-related automatic measurements. Clipping also causes inaccurate amplitude values in waveforms that are stored or exported for use in other programs.

If the scale of a math waveform is changed so that the math waveform is clipped, it will affect the amplitude measurements on that math waveform as follows:

- The vertical position adjusts the display of the graticule relative to the vertical acquisition window (position is a display control). Figure B shows how vertical position moves the waveform graticule vertically in the acquisition window to place the acquired waveform in the graticule display. That is all position does; it does not determine what data is acquired as do vertical scale and offset.

Figure A

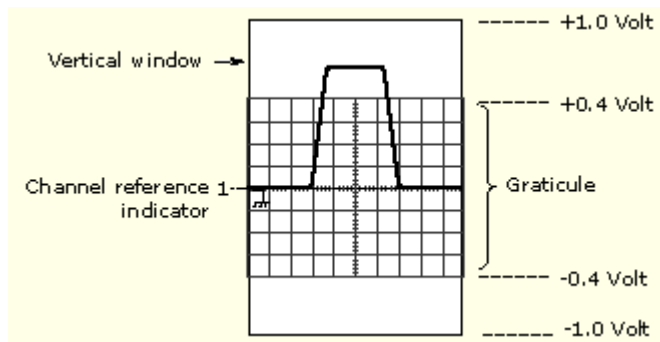
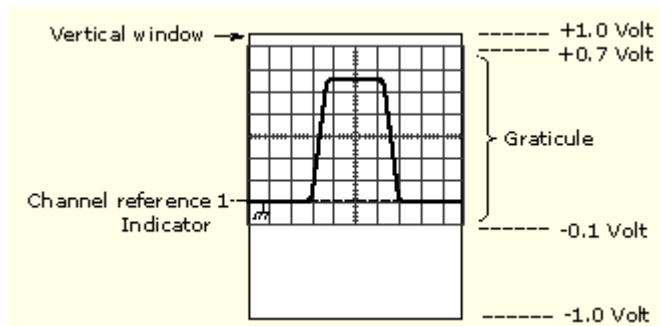
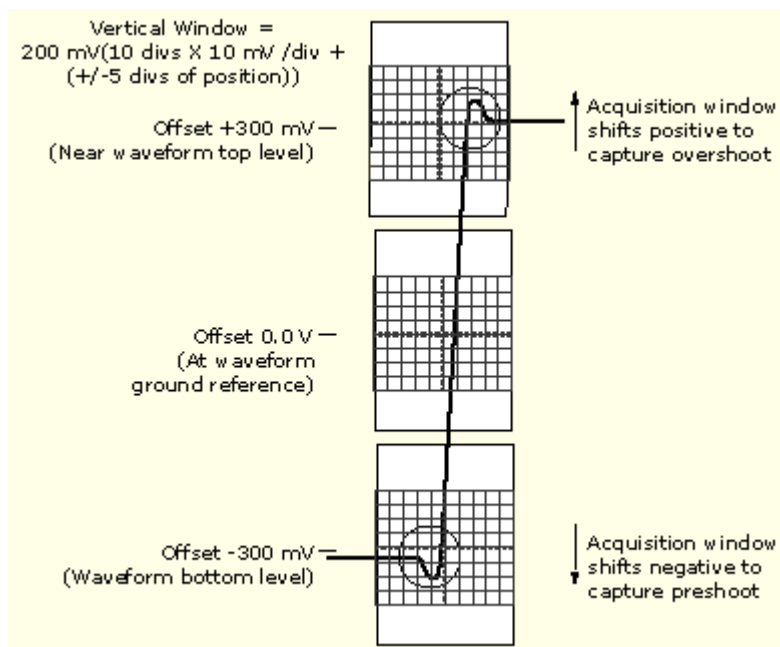

Figure B



- As you vary vertical offset, the middle voltage level moves relative to zero. This moves the vertical acquisition window up and down on the waveform. With input signals that are smaller than the window, it appears the waveform moves in the window. Actually, a larger signal shows what really happens: the offset moves the middle of the vertical acquisition window up and down on the input signal. The next figure shows how offset moves the acquisition window to control the portion of the waveform amplitude the window captures.
- Applying a negative offset moves the vertical range down relative to the DC level of the input signal. Likewise, applying a positive offset moves the vertical range up. See the following illustration.



What do you want to do next?

[Learn about horizontal acquisition window considerations.](#)

[Learn about setting offset.](#)

Horizontal acquisition window considerations

The instrument lets you define the horizontal acquisition window parameters that determine which segment of an incoming signal that becomes the waveform record, following acquisition. For additional information, see [Waveform Record](#).

These common parameters specify a horizontal acquisition window that is applied to all channels in parallel. See [Independent vs. Shared Window](#) for additional information.

These parameters are shown in the next figure (horizontal window with delay on):

- The trigger position determines where the trigger event will be located in the waveform record. To see more pretrigger data move your trigger position to the right on the graticule.
- The horizontal position determines the number of pretrigger and posttrigger samples. Samples before the trigger point are pretrigger samples and those after the trigger point are posttrigger samples. When Delay is off, the horizontal position is the same as the trigger position.
- The horizontal delay determines the time from the trigger point to the Horizontal Reference.

- The horizontal scale determines the horizontal size of the window relative to any waveform, allowing you to scale it to contain a waveform edge, a cycle, or several cycles.

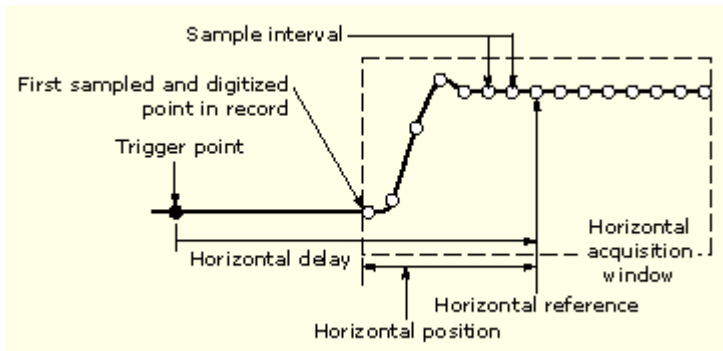

What do you want to do next?

[Learn more about Horizontal Setup.](#)

Horizontal acquisition window interrelated parameters

Horizontal Scale, Record Length, Sample Interval, and Resolution are related parameters that specify the horizontal acquisition window.

Because the horizontal acquisition window must fit in the 10 horizontal division display, for most cases, you can set the Time Duration of the horizontal acquisition window (10 divs × the scale setting) as described below. By also setting a Record Length in samples, you indirectly set the Resolution, Sample Interval, and Sample Rate for the horizontal acquisition window (waveform record).

The relationship between these horizontal elements is as follows:

- Time Duration (seconds) = 10 divs (window size) × Horizontal Scale (sec/div)
- Time Duration (seconds) = Sample Interval (seconds/sample) × Record Length (samples), where Time Duration is the horizontal acquisition window time duration, and Sample Interval (sec/sample) = Resolution (sec/sample) = 1/Sample Rate (samples/sec)

Note that it is the Sample Interval that changes to accommodate the window Time Duration (and its scale setting) and the Record Length setting.

The elements behave as follows:

- If the Record Length or Time Duration change, the Sample Interval will vary to accommodate the change. The Sample Interval can vary up to the highest Sample Rate, (this corresponds to the lowest Sample Interval, and the highest Resolution).
- If the Sample Interval reaches its lower limit, the Record Length must decrease if the Time Duration decreases (you set faster scale settings), or Time Duration must increase (forcing slower scale settings) if Record Length increases (you set longer record lengths. The equation becomes: Maximum Record Length = Time Duration ÷ Min Sample Interval.

NOTE. Resolution and the equivalent elements, Sample Interval and Sample Rate, are derived and cannot be set directly. You can, however, check the Resolution at anytime in the resolution readout. Also note that the front-panel Resolution knob actually adjusts the Record Length to increase sample density.

This discussion assumes that Horizontal Scale is held constant. You can hold the Sample Rate constant instead by clicking Hold Sample Rate constant on the Record Length tab of the User Preferences control window.

What do you want to do next?

[Overview Learn about horizontal scale.](#)

[Learn about record length.](#)

[Learn about horizontal resolution.](#)

Independent versus shared window

The instrument applies the same horizontal acquisition window to all channels from which it acquires data. Unlike the vertical acquisition window that you size and offset independently for each channel, the same time/div, resolution (record length), and horizontal position (from the same trigger point) apply to all channels simultaneously.

One trigger, from a single trigger source, will locate a common horizontal acquisition window for all active channels, which you can shift in parallel by setting the horizontal position control.

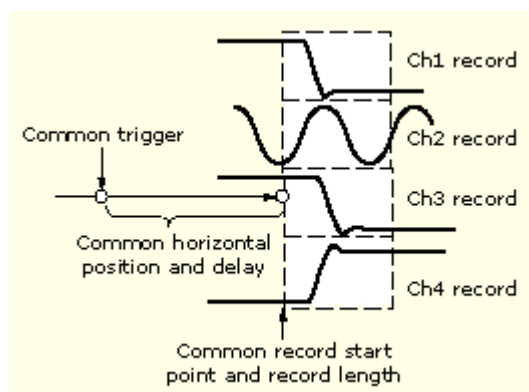

What do you want to do next?

[Learn more about the horizontal acquisition window.](#)

Incompatible acquisition features

The following table shows which acquisition features and modes are incompatible with other features or modes:

| Incompatible with | Control/Feature | Explanation |
|---|-----------------|---|
| Reference Waveforms (Ref 1– 4) | Voltage Offset | Offset is an acquisition control, not a display control |
| Single shot acquisition | Average | Acquisitions continue until the specified number of waveforms have been acquired and averaged |
| Single shot acquisition | Envelope | Acquisitions continue until the specified number of waveforms have been acquired for the enveloped waveform |
| Measurements | Roll | Measurements are not available until you stop acquisitions |
| Envelope, Average, or WfmDB acquisition modes | Roll | Using these acquisition modes will turn Roll mode off |

Autoset considerations

Autoset acquires samples from the input signal and attempts to take the following actions based on the input data:

- Evaluates the amplitude range of the input signals and sets the size and vertical offset of the vertical acquisition window to acquire the signal with good resolution, but without clipping.
- Sets the trigger to the approximate midlevel of the signal being Autoset and switches to edge trigger mode.
- Evaluates the signal transitions and sets the horizontal scale to produce a waveform display of 2 or 3 cycles of the input signal.

Sometimes Autoset cannot produce a correct display due to the nature of the input signal. If so, you may have to adjust the scale, trigger, and acquisition controls manually. The following are some conditions that can cause Autoset to fail:

- No signal present
- Signals with extreme or variable duty cycles
- Signals with multiple or unstable signal periods
- Signals with too low amplitude
- No recognizable trigger signal
- Signals with a frequency < 20 Hz
- Signals with a frequency above the bandwidth of the instrument

What do you want to do next?

[Learn about adjusting the horizontal scale.](#)

[Learn about trigger setup.](#)

[Learn about horizontal acquisition controls.](#)

Acquisition hardware

Before a signal can be acquired, it must pass through the input channel where it is scaled and digitized. Each channel has a dedicated input amplifier and digitizer, as shown in the next figure; each channel can produce a stream of digital data from which the instrument extracts waveform records.

Refer to Signal Connection for further description of scaling, positioning, and DC offsetting of channels.

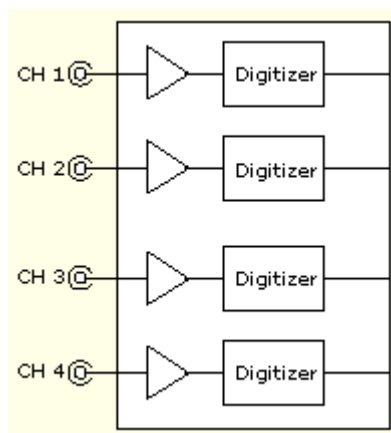

What do you want to do next?

[Learn about the sampling process.](#)

Signal connection

This diagram displays the signal connection model for each input channel.

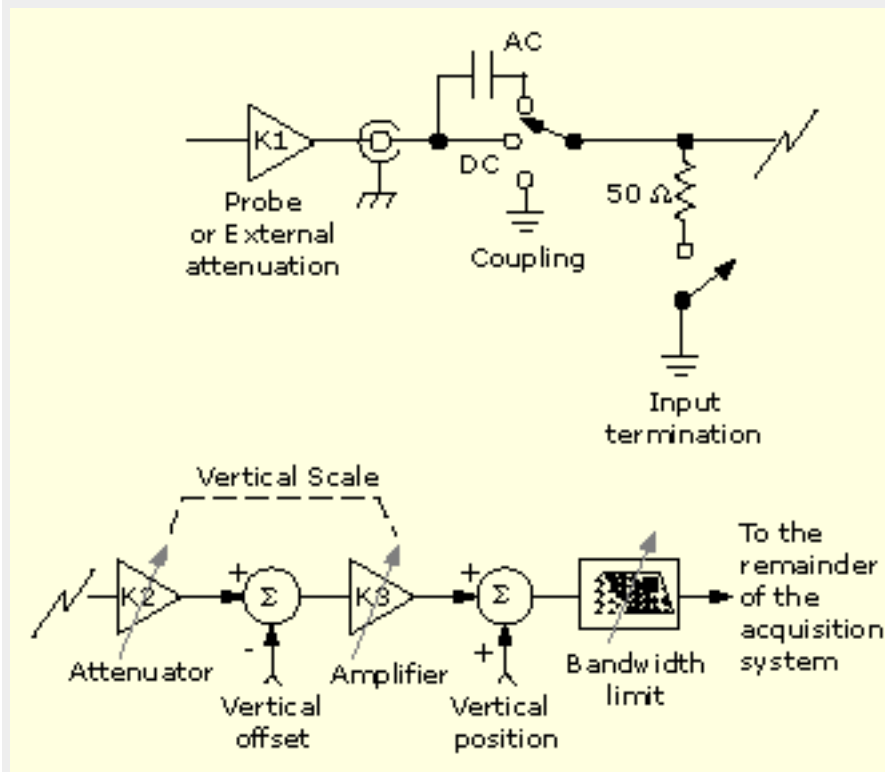

What do you want to do next?

[Learn more about coupling.](#)

[Learn more about the vertical acquisition system.](#)

Sampling process

Acquisition is the process of sampling an analog signal, converting it into digital data, and assembling it into a waveform record, which is then stored in acquisition memory. Sampling is the process that provides a waveform record per trigger event as shown in the next figure.

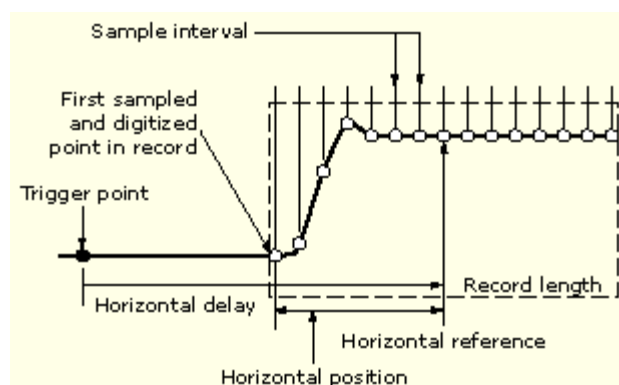

The signal parts within the vertical range of the amplifier are digitized as shown in the next figure.

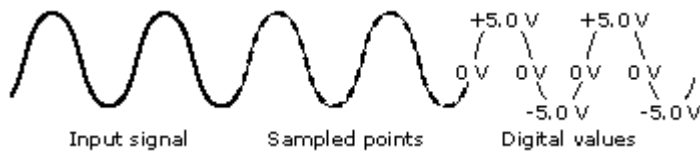

What do you want to do next?

[Learn about sampling modes.](#)

Sampling modes

The acquisition system can process the data as it is acquired, averaging or enveloping the waveform data to produce enhanced waveform records. Once the waveform record exists (enhanced or not), you can use the post processing capabilities of the instrument to further analyze that record.

Refer to [Acquisition Mode](#) for a description of the acquisition modes.

[Learn about waveform measurements.](#)

Waveform record

While sampling on the input signal provides the data that makes up the waveform record for any given channel, the instrument builds the waveform record through use of some common parameters ("common" means they affect the waveforms in all channels).

The instrument builds the waveform record through use of the following parameters:

- **Sample interval.** The time between recorded sample points. Adjust this by turning the **Horizontal Scale** knob or pushing **Acquire** and changing the record length in the Acquire menu.
- **Record length.** The number of samples required to fill a waveform record. Set this by pushing the **Acquire** button and using the lower and side menus.
- **Trigger point.** The zero time reference in a waveform record. It is shown on the screen by an orange T.
- **Horizontal position.** When **Delay Mode** is on, this is the time from the trigger point to the expansion point. Adjust this by turning the **Horizontal Position** knob. Use a positive time to acquire the record after the trigger point. Use a negative time to acquire it before the trigger point.
- **Expansion point.** The point that the horizontal scale expands and contracts around. It is shown by an orange triangle.

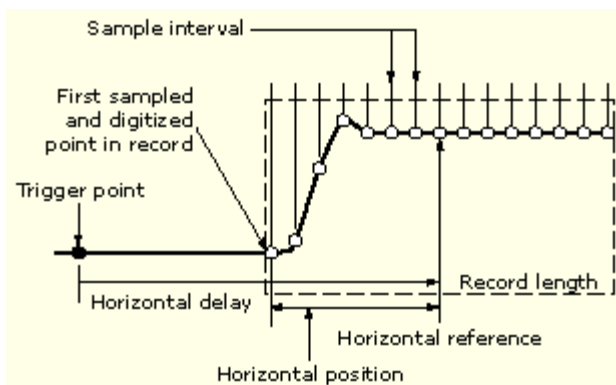

Figure 18: The waveform record and its defining parameters (horizontal delay on)

The previous figure shows that the instrument acquires points in order from left to right.

When all of the points in the waveform record have been sampled and digitized, the waveform record is stored in acquisition memory and becomes available for display (or use in math waveforms, storage, and so on).

What do you want to do next?

[Learn about Horizontal window considerations.](#)

[Learn about Horizontal Acquisition Window interrelated parameters.](#)

Interleaving

The instrument can interleave channels to attain higher real-time digitizing rates and longer record length when only one or two channels are turned on without equivalent-time sampling. The instrument applies the resources of unused channels (that is, channels that are turned off) to sample those that are in use (turned on).

Once you set the horizontal scale to exceed the maximum digitizing rate for the number of channels in use, the instrument will not be able to get enough samples to create a waveform record. At that point, the instrument will switch from real-time to equivalent-time to obtain additional samples.

[Learn about equivalent time sampling.](#)

Interpolation

When the sample density falls to less than one sample per display column, the instrument must calculate intermediate points to display a waveform. This process is called interpolation.

There are two options for interpolation:

- **Sin(x)/x Interpolation.** Computes record points using a curve fit between the actual values acquired. It assumes that all the interpolated points fall along that curve.
- **Linear Interpolation.** Computes record points between actual acquired samples by using a straight line fit. It assumes that all the interpolated points fall in their appropriate point in time on that straight line.

What do you want to do next?

[Learn about using the MultiView Zoom feature.](#)

[Go to a step-by-step procedure for displaying waveforms.](#)

Trigger function

Triggering concepts

Overview. User selected trigger conditions are used to capture waveforms for measurement and analysis.

The next figure shows how triggers fit into the overall instrument operation.

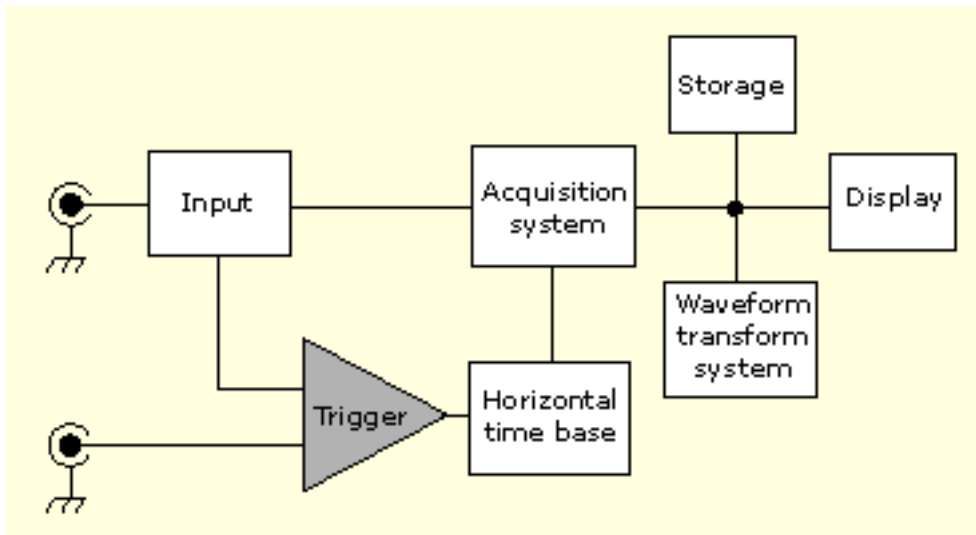

Triggers help you capture meaningful waveforms to display on screen. This instrument has simple edge triggers as well as a variety of advanced triggers.

The trigger event. The trigger event establishes the time-zero point in the waveform record. All waveform record data are located in time with respect to that point. The instrument continuously acquires and retains enough sample points to fill the pretrigger portion of the waveform record (that part of the waveform that is displayed before, or to the left of, the triggering event on screen).

When a trigger event occurs, the instrument starts acquiring samples to build the posttrigger portion of the waveform record (displayed after, or to the right of, the trigger event). Once a trigger is recognized, the instrument will not accept another trigger until the acquisition is complete and the holdoff time has expired.

What do you want to do next?

[Learn about trigger sources.](#)

[Learn about trigger types.](#)

[Learn about trigger modes.](#)

[Learn about trigger holdoff.](#)

Trigger sources

The trigger source provides the signal that triggers acquisition. Use a trigger source that is synchronized with the signal that you are acquiring and displaying.

NOTE. This online help supports many oscilloscope models from Tektronix. Some of these sources may not be available on your instrument. Some of the sources may not be available on your instrument with its current setup.

You can derive your trigger from the following sources:

- **Input channels.** These are the most commonly used trigger sources. You can select any one of the four input channels. The channel that you select as a trigger source will function whether it is displayed or not.
- **Digital channels.** These sources are available on MSO instruments. You can select any combination of digital channels.
- **Bus.** This source is used to trigger a parallel bus or a serial bus. You can include any combination of analog, math, or digital channels to build a parallel bus with up to 20 bits (and a clock), or use any channel as a component in a serial bus. You define the trigger as a bus pattern for parallel buses or as a bus cycle for serial buses.
- **AC Line Voltage.** This source is often used to look at signals related to the power line frequency (for example, signals from devices such as lighting equipment and power supplies). Because the instrument generates the trigger from the power line, you do not have to use a channel input.
- **Auxiliary Trigger.** (AUX IN) provides a fifth source that you can use as a trigger input when you need to use the four input channels for other signals. For example, you might want to trigger on a clock while displaying four other logic signals. To use the auxiliary trigger, connect the signal to the auxiliary input connector on the front panel. The input connector is not compatible with most probes, nor can you display the auxiliary trigger signal.
- **iCapture.** This source is available on MSO instruments. If you select iCapture in the Vertical menu, you can then select the iCapture channel as the trigger source.

The trigger level range for the front-panel auxiliary input (Aux In) is adjustable from +5 V to –5 V. The maximum input voltage depends on the instrument model, check your instrument specifications.

What do you want to do next?

[Learn about trigger types.](#)

[Learn about trigger modes.](#)

Trigger types

NOTE. This online help documents features and options available for several instrument models. Your instrument may not have every feature discussed in this online help, depending on its configuration.

From the Trig menu, select A Event Trigger Setup or B Event Trigger Setup.

To use. Click the Select button for selecting the trigger type in the Trigger Selection dialog box.

The triggers type available are listed as follows:

Edge trigger. This is the simplest and most commonly used trigger type, used with both analog and digital signals. An edge trigger event occurs when the trigger source passes through a specified voltage level in the specified direction (rising or falling signal voltage).

Bus trigger. This trigger is used with both analog and digital signals used to set up parallel buses or a serial buses. A bus trigger event occurs when the instrument detects a bus pattern that you specify for a parallel bus, or a bus cycle you select for a serial bus.

NOTE. This online help supports many oscilloscope models from Tektronix. This feature is only available on some models.

[Glitch trigger](#), [Transition trigger](#), [Pattern trigger](#), [Runt trigger](#), [Window Trigger](#), [State trigger](#), [Width trigger](#), [Timeout trigger](#), and [Setup/Hold trigger](#)

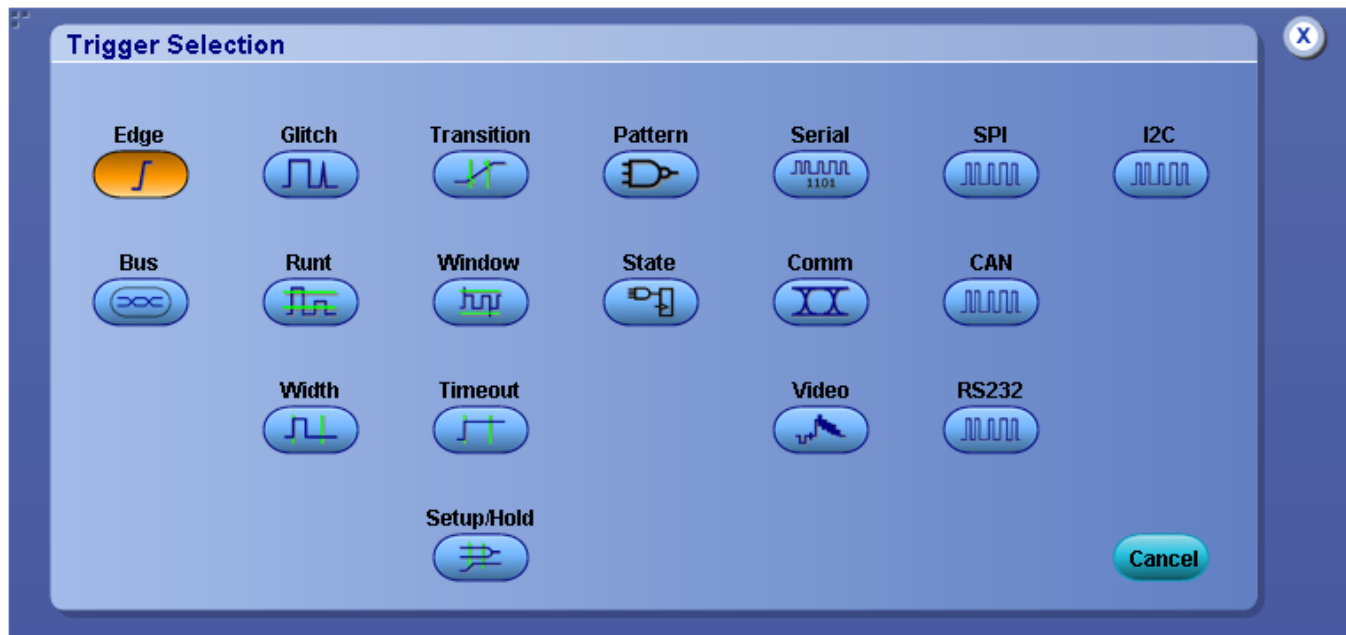

Pulse trigger. Pulse trigger on B event is not available on MSO/DPO5000B Series instruments.

These are special-purpose triggers that are primarily used with digital signals. The following types of pulse triggers are available: Glitch, Runt, Window, Width, Transition, and Timeout. Pulse triggers are available on the main and B event triggers only.

Logic trigger. Logic trigger on B event is not available on MSO/DPO5000B Series instruments.

These are special-purpose triggers that are primarily used with digital logic signals. Two of the types, Pattern and State, trigger the instrument based on the Boolean operator that you select for the trigger sources. A third type, Setup and Hold, triggers when data in one trigger source changes state within the setup and hold times that you specify relative to a clock in another trigger source. Logic triggers are available on the main and B event triggers.

Communication trigger. Communication trigger is not available on MSO/DPO5000B Series instruments.

Available with Mask Testing, this trigger is designed to work with communication masks and standards. Mask testing automatically uses Communication triggers.

NOTE. You must install the [Serial mask testing option](#) on some instruments before you can access the Comm triggers.

Video trigger. Video trigger is available on DPO7000C and MSO/DPO5000B Series instruments.

These are used to trigger the instrument on specified fields or lines of a video signal. You can use one of several preset video signal formats or set a custom format.

Serial trigger. Serial trigger is not available on MSO/DPO5000B Series instruments.

Serial triggering allows you to define a 64-bit pattern and trigger on it. The serial pattern can be set in radices of binary or hex. Serial triggering also offers Recovered Clock as the clock source in addition to Ch1 – Ch4. Use serial triggering in conjunction with mask testing to trigger the instrument on communications codes and standards. The communication codes and standards work together to define the parameters for the trigger event.

What do you want to do next?

[Learn about trigger sources.](#)

[Learn about trigger modes.](#)

Trigger modes

The trigger mode determines how the instrument behaves in the absence of a trigger event:

- **Normal** trigger mode enables the instrument to acquire a waveform only when it is triggered. If no trigger occurs, the instrument does not acquire a waveform, and the last waveform record acquired remains "frozen" on the display. If no last waveform exists, no waveform is displayed.
- **Auto** trigger mode enables the instrument to acquire a waveform even if a trigger does not occur. Auto mode uses a timer that starts after a trigger event occurs. If another trigger event is not detected before the time out, the instrument forces a trigger. The length of time it waits for a trigger event depends on the time base setting.

Auto mode, when forcing triggers in the absence of valid triggering events, does not synchronize the waveform on the display. In other words, successive acquisitions are not triggered at the same point on the waveform; therefore, the waveform will appear to roll across the screen. If valid triggers occur, the display will become stable.

What do you want to do next?

[Learn about trigger sources.](#)

[Learn about trigger types.](#)

Trigger holdoff

Trigger holdoff can help stabilize triggering. When the instrument recognizes a trigger event, it disables the trigger system until acquisition is complete. In addition, the trigger system remains disabled during the holdoff period that follows each acquisition. Adjust holdoff to obtain stable triggering when the instrument is triggering on undesired trigger events.

A digital pulse train is a good example of a complex waveform. Each pulse looks like any other, so many possible trigger points exist. Not all of these will result in the same display. The holdoff period allows the instrument to trigger on the correct edge, resulting in a stable display.

At the longer holdoff time for the top waveform, unstable triggering occurs. With a shorter holdoff set for the bottom waveform, triggers all occur on the first pulse in the burst to remedy the unstable trigger.

The Holdoff setting range is 1.5 μ s (minimum holdoff available) to 12 s (maximum holdoff available). For more information on how to set holdoff, [click here](#). You can also set a default holdoff. The default holdoff is the general-purpose holdoff for most applications and varies with the horizontal scale. It is equal to five times the current horizontal scale setting.

[Learn about trigger coupling.](#)

[Learn about trigger modes.](#)

Trigger coupling

Trigger coupling determines what part of the signal is passed to the trigger circuit. Edge triggering can use all available coupling types: AC, DC, Low Frequency Rejection, High Frequency Rejection, Noise Rejection, and RF coupling (SX models only). All of the advanced trigger types use DC coupling only. For a description of each coupling type, [click here](#).

[Learn about trigger position.](#)

[Learn about trigger holdoff.](#)

Trigger slope and level

The slope control determines whether the instrument finds the trigger point on the rising or the falling edge of a signal. The level control determines where on that edge the trigger point occurs. See the next figure.

What do you want to do next?

[Learn about trigger position.](#)

[Learn about trigger slope.](#)

Horizontal trigger position

Horizontal position is an adjustable feature that defines where the trigger occurs on the waveform record. It lets you choose how much the instrument acquires before and after the trigger event. The part of the record that occurs before the trigger is the pretrigger portion. The part that occurs after the trigger is the posttrigger portion. A longer posttrigger period may be useful when you want to see the effects an event has on your system under test.

Pretrigger data can be valuable when troubleshooting. For example, if you are trying to find the cause of an unwanted glitch in your test circuit, you can trigger on the glitch and make the pretrigger period large enough to capture data before the glitch. By analyzing what happens before the glitch, you may uncover information that helps you find the source of the glitch.

[Learn about trigger coupling.](#)

[Learn about trigger slope.](#)

[Learn about glitch triggers.](#)

Delayed trigger system

You can trigger with the A (Main) trigger system alone or you can combine the A (Main) trigger with the B (Delayed) trigger to trigger on sequential events. When using sequential triggering, the A trigger event arms the trigger system, and the B trigger event triggers the instrument when the B trigger conditions are met.

A and B triggers can (and typically do) have separate sources. The B trigger condition can be based on a time delay or a specified number of counted events.

For more details on delayed triggering, click [here](#).

[Learn about advanced triggering.](#)

Advanced triggering

You can check the advanced trigger status in the readout. The readout indicates the trigger type and then shows sources, levels, or any other parameters that are important for the particular trigger type.



Bus trigger

A bus trigger occurs when a supported instrument detects a bus pattern that you specify for a parallel bus, or a bus cycle you select for a serial bus.

You can set the instrument to trigger on a parallel bus when the instrument detects a match to the bus pattern, or when the instrument detects that the value on the bus is < or > the value of the bus pattern. The pattern can be in Binary, Hex, or Symbolic format.

You can set the instrument to trigger on an SPI bus when the instrument detects an SS or an MISO + MOSI bus cycle. For the MISO + MOSI selection, click the Edit button to define the Data Value pattern, and then set the Format to match.

You can set the instrument to trigger on an I2C bus when the instrument detects a Start, Stop, Repeated Start, Missing Ack, Address, Data, or Addr + Data bus cycle or activity. For some Trigger On selections, you need to set additional fields to define other parameters, such as for an Address. In this example, you need to set an Address Format, Address Value (click the Edit button), Data Direction, and Addressing Mode.

You can set the instrument to trigger on a USB bus when the instrument detects a Sync, Reset, Suspend, Resume, End of Packet, Token (Address) Packet, Data Packet, Handshake Packet, Handshake Packet, Special Packet, or Error bus cycle or activity. For some Trigger On selections, you need to set additional fields to define other parameters, such as for a Token (Address) Packet. In this example, you need to set a Token Type, Trigger when address is, Address Format, Address (click the Edit button), and when endpoint is equal to Endpoint Format, and Endpoint.

You can set the instrument to trigger on an RS232 bus when the instrument detects a Start, End of Packet, Data, or Parity Error bus cycle or activity. For some Trigger On selections, you need to set additional fields to define other parameters, such as for a Data. In this example, you need to set a Data Format, Number of Bytes, and Data Value (click the Edit button).

You can set the instrument to trigger on an 8b10b bus when the instrument detects a Pattern, Character/Symbol, Error, or Any Control Character. For some Trigger On selections, you need to set additional fields to define other parameters, such as for a Pattern.

For all the serial standard buses, you can also set the component threshold levels through the Logic Thresholds Setup button.

Communication trigger

Use the Comm trigger to trigger the instrument in conjunction with mask testing on communications codes and standards. The controls work together to define the parameters for the trigger event. Comm triggers are not available on DPO7000SX instruments.

The standards that appear in the Standard drop-down list depend on the coding format that you selected. The coding format also determines whether upper, lower, single, or clock threshold levels or pulse forms are used. The standard determines the bit rate.

Communication triggering

Communication (Comm) triggers are one type of trigger. Comm triggers are designed to work with communication masks and standards. When you select a mask to test, it is associated with a specific communication standard. The mask you select determines the Comm trigger needed for that standard. Comm triggers are not available on DPO70000SX instruments.

NOTE. The Comm Trigger is designed to work with communications mask and standard testing. Mask testing automatically uses Communication triggers. You must install the [Serial Communications Mask Testing Option](#) on some instruments before you can access the Comm triggers.

Eye diagrams that are set up with an external clock use a time base position value large enough to guarantee the edge is always before the acquisition record starts. This forces all Comm triggers to disable the B-Trigger.

Even though Comm triggers are designed to work with masks, you can set up Comm triggering without using a mask. You can also set up your own mask to use with Comm triggers.

What do you want to do next?

[Learn about mask testing.](#)

[Learn more about eye measurements.](#)

[Go to the mask testing setup overview.](#)

Glitch trigger









A glitch trigger occurs when the instrument detects a pulse narrower (or wider) than some specified time. You can set the instrument to trigger on glitches of either polarity or to reject glitches of either polarity.

Pattern trigger

A pattern trigger occurs when the inputs to the selected logic function cause the function to become True or False. When you use a pattern trigger, you define:

- The precondition for each logic input: logic high, low, or "don't care"; the logic inputs are the instrument channels
- The Boolean logic function: AND, NAND, OR, or NOR
- The condition for triggering: the Boolean function becomes True (logic high) or False (logic low), and whether the True condition is time qualified

Pattern trigger logic choices are summarized in the next table.

| Pattern | State | Definition ^{1, 2} |
|--|--|--|
| AND  | Clocked AND  | If all the preconditions selected for the logic inputs ³ are TRUE, then the instrument triggers. |
| NAND  | Clocked NAND  | If not all of the preconditions selected for the logic inputs ⁴ are TRUE, then the instrument triggers. |
| OR  | Clocked OR  | If any of the preconditions selected for the logic inputs ⁵ are TRUE, then the instrument triggers. |
| NOR  | Clocked NOR  | If none of the preconditions selected for the logic inputs ⁶ are TRUE, then the instrument triggers. |

Runt trigger

A runt trigger occurs when the instrument detects a short pulse that crosses one threshold but fails to cross a second threshold before recrossing the first.

- You can set the instrument to detect any positive or negative runt pulse, or only those wider than a specified minimum width.
- Runt pulses can also be qualified by the logical state of other channels.

Setup and hold trigger

A setup/hold trigger occurs when a data signal changes state inside of the user specified setup and hold times relative to the clock. When you use setup/hold triggering, you define:

- The channel containing the logic input (the data source) and the channel containing the clock (the clock source)
- The direction of the clock edge to use
- The clocking level and data level that the instrument uses to determine if a clock or data transition has occurred
- The setup and hold times that together define a time range relative to the clock

Data that changes state within the setup/hold violation zone triggers the instrument. The next figure shows how the setup and hold times that you choose position the violation zone relative to the clock.

¹ For state triggers, the definition must be met at the time the clock input changes state

² The definitions given here are correct for the Goes TRUE setting in the Trigger When menu. If that menu is set to Goes False, swap the definition for AND with that for NAND and for OR with NOR for both pattern and state types.

³ The logic inputs are channels 1, 2, 3, and 4 when using Pattern triggers. For State triggers, channel 4 becomes the clock input, leaving the remaining channels as logic inputs.

⁴ The logic inputs are channels 1, 2, 3, and 4 when using Pattern triggers. For State triggers, channel 4 becomes the clock input, leaving the remaining channels as logic inputs.

⁵ The logic inputs are channels 1, 2, 3, and 4 when using Pattern triggers. For State triggers, channel 4 becomes the clock input, leaving the remaining channels as logic inputs.

⁶ The logic inputs are channels 1, 2, 3, and 4 when using Pattern triggers. For State triggers, channel 4 becomes the clock input, leaving the remaining channels as logic inputs.

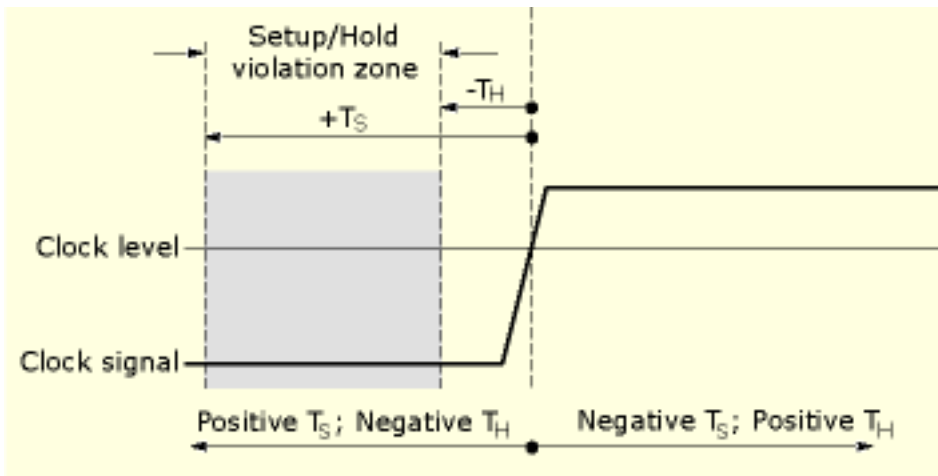
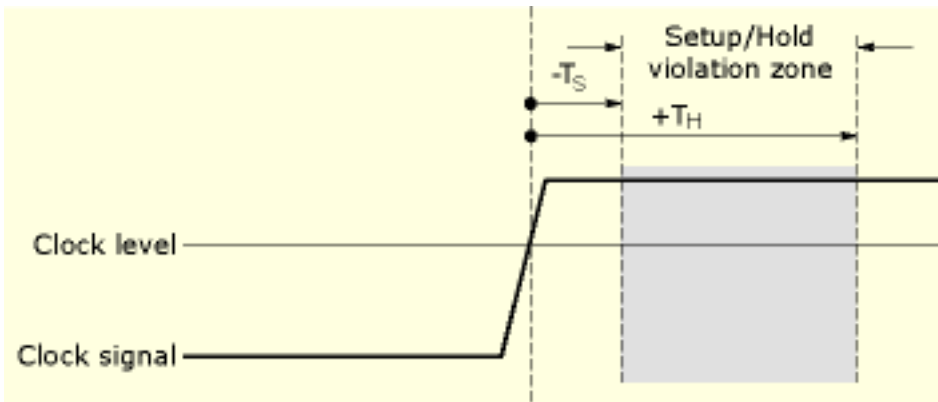
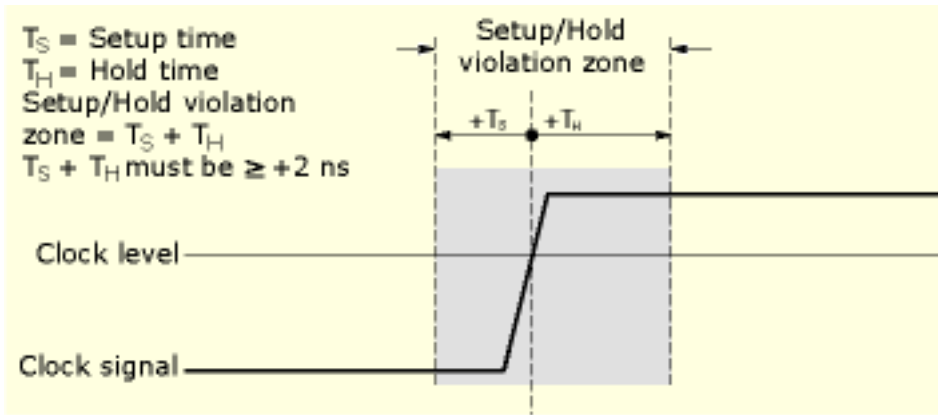

Setup/hold triggering uses the setup/hold violation zone to detect when data is unstable too near the time it is clocked. Each time trigger holdoff ends, the instrument monitors the data and clock sources. When a clock edge occurs, the instrument checks the data stream it is processing (from the data source) for transitions occurring within the setup/hold violation zone. If any occur, the instrument triggers with the trigger point located at the clock edge.

Positive settings for both setup and hold times (the most common application) locate the setup/hold violation zone so that it spans the clocking edge as shown above in the top waveform. The instrument detects and triggers on data that does not become stable long enough before the clock (setup time violation) or that does not stay stable long enough after the clock (hold time violation).

Negative settings for setup or hold times skew the setup/hold violation zone to locate it before or after the clocking edge as shown above in the center and bottom waveforms. The instrument can then detect and trigger on violations of a time range that occurs before or one that occurs after the clock.









NOTE. Keep the hold-time setting to no more than 2.5 ns less than one-half the clock period ($hold\ time < (period/2) - 2.5\ ns$) or the instrument cannot trigger (this assumes a 50% duty cycle clock).

State trigger

A state trigger occurs when the inputs to the logic function cause the function to become True or False at the time the clock input changes state. When you use a state trigger, you define:

- The precondition for logic input channels 1 through 3
- The direction of the state change for the clock input, channel 4
- The Boolean logic function: AND, NAND, OR, or NOR
- The condition for triggering: the Boolean function becomes True (logic high) or False (logic low)

State trigger logic conditions are summarized in the following table.

| Pattern | State | Definition ^{7, 8} |
|--|--|---|
| AND  | Clocked AND  | If all the preconditions selected for the logic inputs ⁹ are TRUE, then the instrument triggers. |
| NAND  | Clocked NAND  | If not all of the preconditions selected for the logic inputs ¹⁰ are TRUE, then the instrument triggers. |
| OR  | Clocked OR  | If any of the preconditions selected for the logic inputs ¹¹ are TRUE, then the instrument triggers. |
| NOR  | Clocked NOR  | If none of the preconditions selected for the logic inputs ¹² are TRUE, then the instrument triggers. |

⁷ For state triggers, the definition must be met at the time the clock input changes state.

⁸ The definitions given here are correct for the Goes TRUE setting in the Trigger When menu. If that menu is set to Goes False, swap the definition for AND with that for NAND and for OR with NOR for both pattern and state types.

⁹ The logic inputs are channels 1, 2, 3, and 4 when using Pattern triggers. For State triggers, channel 4 becomes the clock input, leaving the remaining channels as logic inputs.

¹⁰ The logic inputs are channels 1, 2, 3, and 4 when using Pattern triggers. For State triggers, channel 4 becomes the clock input, leaving the remaining channels as logic inputs.

¹¹ The logic inputs are channels 1, 2, 3, and 4 when using Pattern triggers. For State triggers, channel 4 becomes the clock input, leaving the remaining channels as logic inputs.

¹² The logic inputs are channels 1, 2, 3, and 4 when using Pattern triggers. For State triggers, channel 4 becomes the clock input, leaving the remaining channels as logic inputs.

Timeout trigger

A timeout trigger occurs when the instrument does not detect an expected pulse transition within a user specified period of time, such as when a signal gets stuck either high or low. If the pulse transition occurs prior to a specified timeout time (the expected case), then no trigger results.

Transition time trigger

Transition triggering is based on the slope (change in voltage/change in time) of a pulse edge.

Use the transition trigger to trigger the instrument on pulse edges that traverse between two thresholds at faster or slower rates than the specified time. You can set up the instrument to trigger on positive or negative edges.

Video trigger

Use the Video trigger to trigger the instrument on specified fields or lines of a composite video signal. You can select from several preset video signal formats or set a custom format.

NOTE. Only composite signal formats are supported. Graphic display formats such as RGB and VGA are not supported. Video trigger is not available on some instruments.

Width trigger

A width trigger occurs when the instrument detects a pulse that is inside or outside some specified time range. The instrument can trigger on positive or negative width pulses. Width triggers can also be qualified by the logical state of other channels.

Window trigger

NOTE. Window trigger is not available on MSO/DPO5000B Series instruments.

Use the Window trigger to trigger the instrument when the input signal rises above an upper threshold level or falls below a lower threshold level.

After setting these levels, you can specify whether you want to trigger the instrument as the signal is entering or leaving the threshold window. You can further qualify the trigger event in terms of time, or by the logical state of other channels.

Sequential triggering

In applications that involve two or more signals, you may be able to use sequential triggering to capture more complex events. Sequential triggering uses the A (Main) trigger to arm the trigger system, and then uses the B (Delayed) trigger to trigger the instrument if a specific condition is met.

You can choose one of two trigger conditions:

- **Trigger After Time.** After the A trigger arms the trigger system, the instrument triggers on the next B-trigger event that occurs after the trigger delay time. You can set the trigger delay time with the keypad or the multipurpose knobs.
- **Trigger on nth Event.** After the A trigger arms the trigger system, the instrument triggers on the nth B event. You can set the number of B events with the keypad or the multipurpose knobs.

NOTE. The traditional delayed trigger mode called "Runs After" is controlled by the Horizontal Delay feature. You can use horizontal delay to delay acquisition from any trigger event, whether from the A (Main) trigger alone or from a sequential trigger that uses both the A (Main) and B (Delayed) triggers. See [Triggering with Horizontal Delay On](#) for more information.

Keep in mind the following when using sequential triggers:

- In most cases, you will set separate trigger sources for the A (Main) and B (Delayed) triggers.
- Sequential triggering for Trigger after Time or Trigger on nth Event is available for all trigger types.
- The B trigger can be any trigger type except Bus.

What do you want to do next?

[Learn more about sequential triggering.](#)

[Learn about advanced triggers.](#)

Triggering with horizontal delay off

The next figure compares the sequential trigger choices A Only, Trig After Time, and Trig on nth Event when horizontal delay is off. Each illustration shows where pretrigger and posttrigger data is acquired relative to the trigger event.

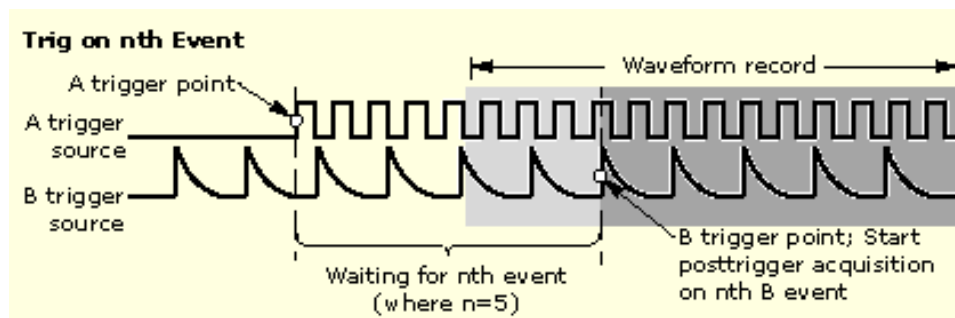
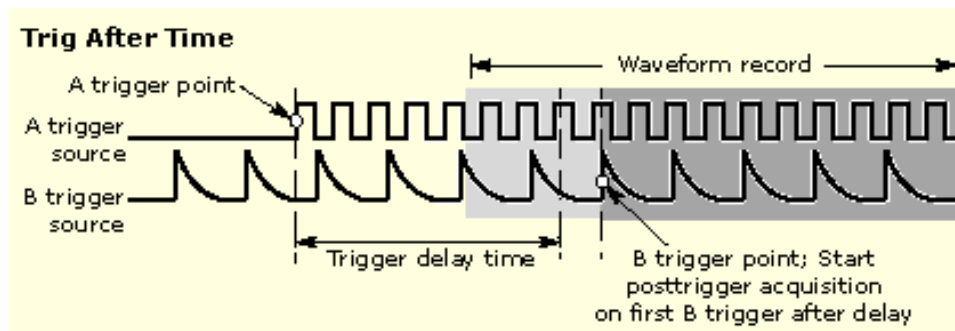
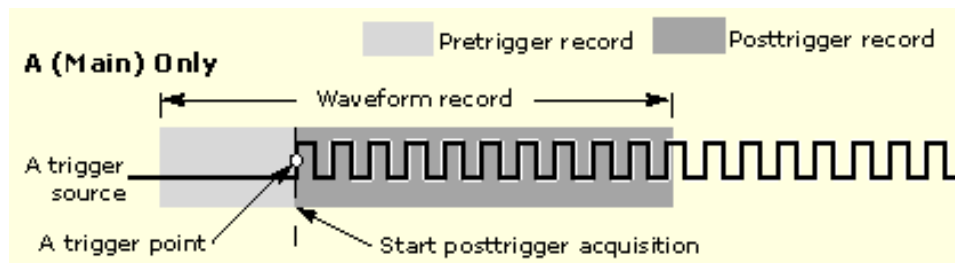

What do you want to do next?

[Learn more about sequential triggering.](#)

[Learn about advanced triggers.](#)

Triggering with horizontal delay on

You can use horizontal delay when you want to acquire a waveform record that is separated from the trigger event by a significant interval of time. The horizontal delay function can be used with any trigger setup.

You can turn horizontal delay on and off from the front panel, the Horizontal/Acquisition control window, and many of the Trigger control windows.

The next figure compares the sequential trigger choices A Only, Trig After Time, and Trig on nth Event when horizontal delay is on. Each illustration shows where pretrigger and posttrigger data is acquired relative to the trigger event.

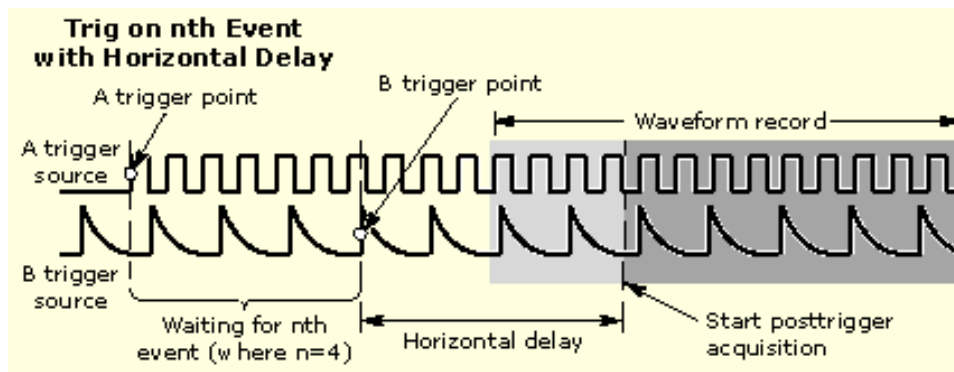
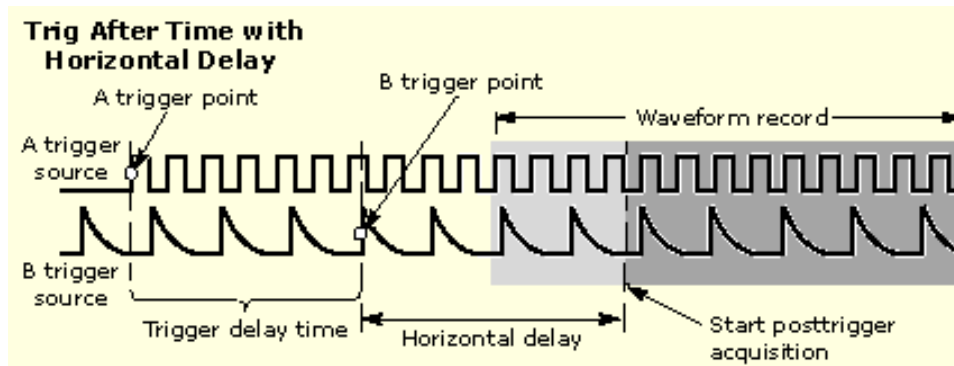
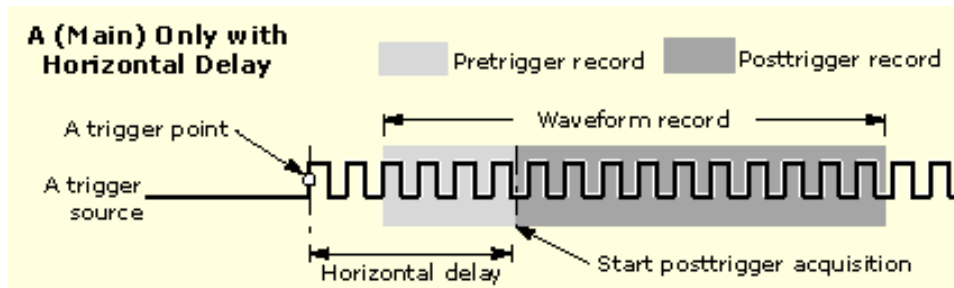

What do you want to do next?

[Learn about advanced triggers.](#)

[View a summary of triggering and horizontal delay.](#)

Triggering and horizontal delay summary

The next figure shows all combinations of triggering and horizontal delay.

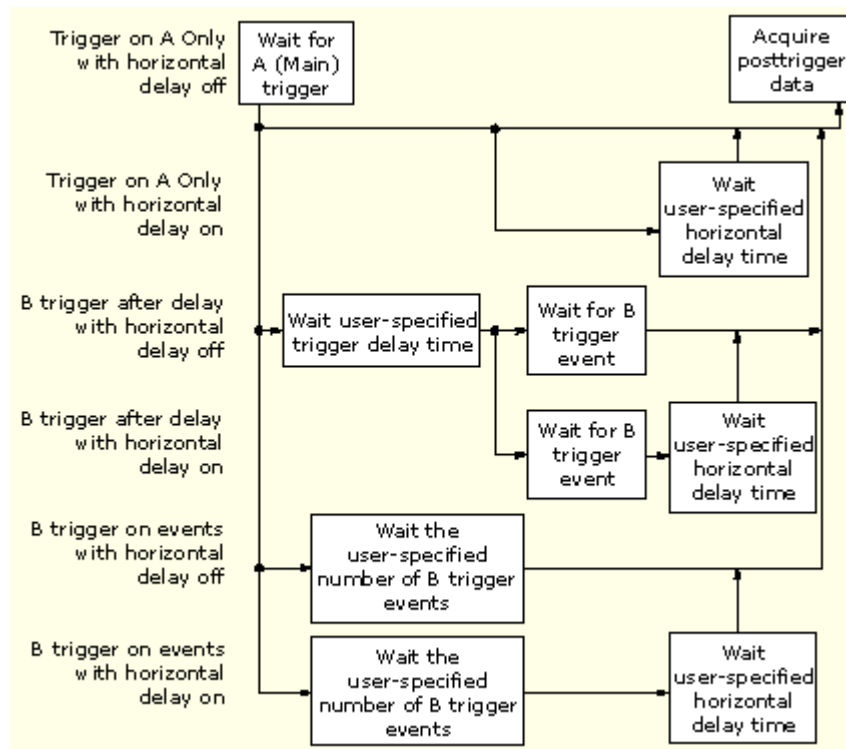

What do you want to do next?

[Go to a step-by-step procedure for sequential triggering.](#)

[Learn about advanced triggers.](#)

Waveform display

Display overview

This instrument includes a flexible, customizable display that lets you control how waveforms appear. The next figure shows how the display features fit into the overall instrument operation.

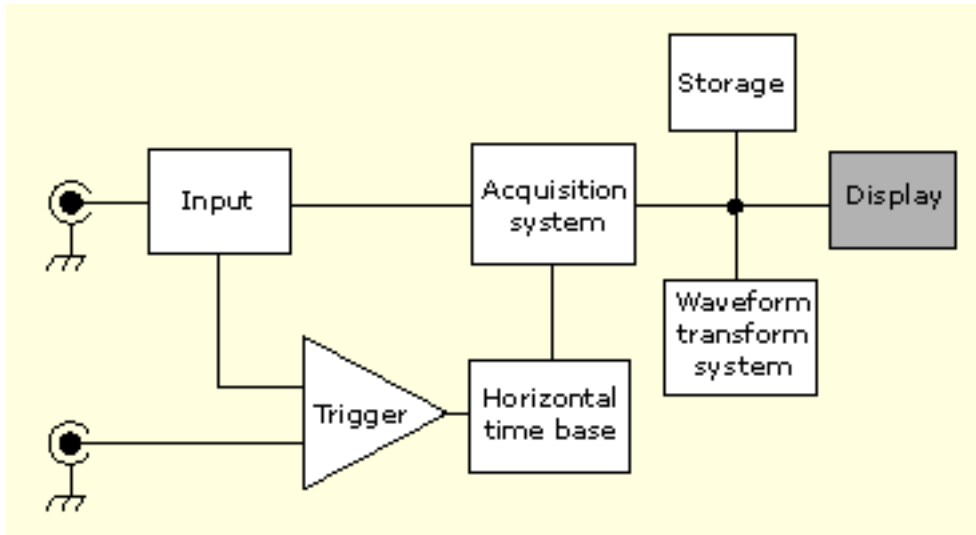

What do you want to do next?

[Learn about display elements.](#)

[Learn about customizable display elements.](#)

[Go to a step-by-step procedure for displaying waveforms.](#)

Display elements

The waveform shown below is displayed as part of the user interface (UI) application. Some terms that are useful in discussing the UI follow.

1. **Menu Bar.** Access the controls for data I/O, printing, online help, and instrument functions here.
2. **Buttons/Menu.** Click to toggle between the toolbar and menu bar modes.
3. **Multipurpose Knob Readout.** Adjust and display the parameters controlled by the multipurpose knobs.
4. **Display.** Live, reference, and math waveforms are displayed here, along with cursors.
5. **Waveform Handle.** Click and drag to change the vertical position of a waveform.
6. **Controls Status.** Obtain a quick reference to the vertical selections, scale, and parameters. Probe status is provided for some probe tips.
7. **Readouts.** The cursor and measurement readouts are displayed in this area. Measurements are selectable from the menu bar or toolbar. If a control window is displayed, some combinations of readouts move to the graticule area.

8. **Status.** Displays the acquisition status, mode, and number of acquisitions; trigger status; date; time; and quick reference to horizontal parameters

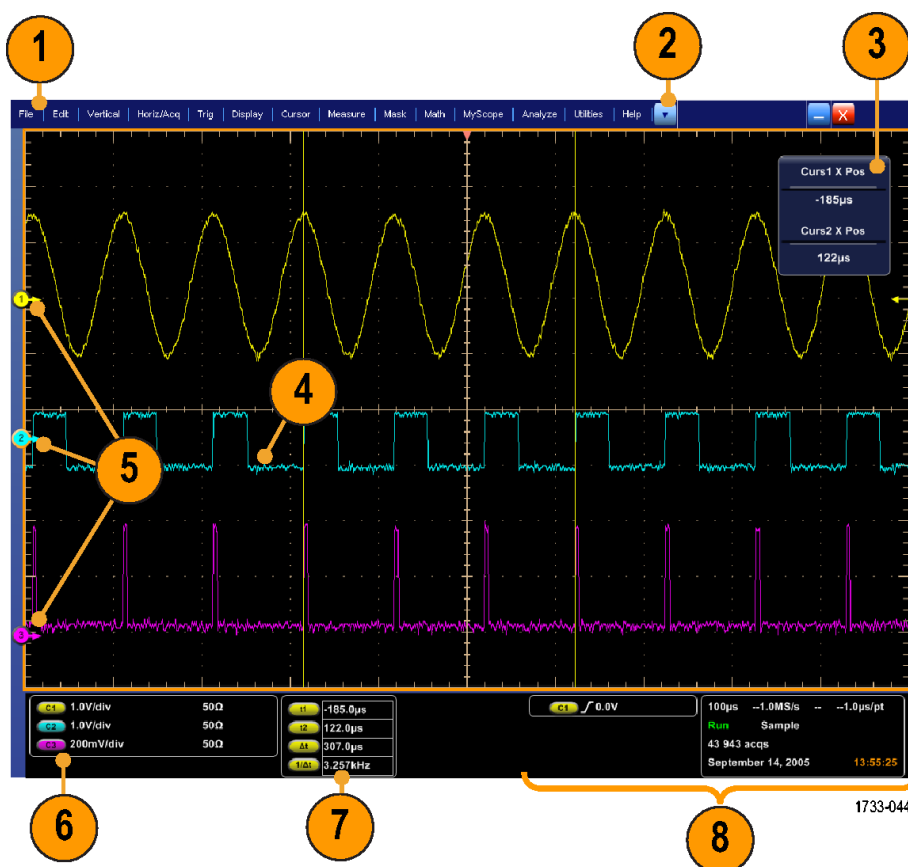

See the next figure for some ideas on how to manipulate the display elements.

1. Click to toggle between toolbar and menu bar modes and select toolbar extensions.
2. Drag cursors to measure waveforms on screen.
3. Drag the horizontal reference marker to reposition a waveform.
4. Click the waveform handle to assign the multipurpose knobs to waveform vertical position and scale.
5. Drag across the waveform area to create a box for zooming, enabling/disabling histograms, and gating measurements.

6. Drag the trigger level marker to change the trigger level.

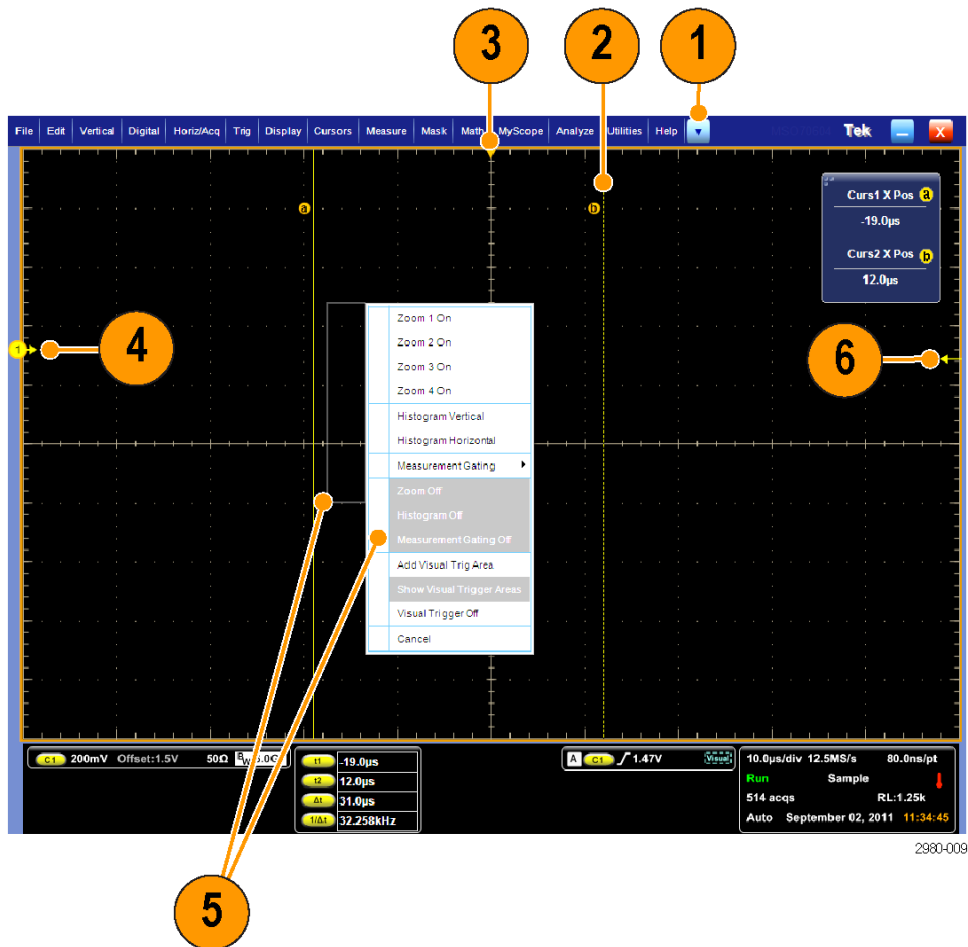

What do you want to do next?

[Learn about acquisition preview.](#)

[Learn about customizable display elements.](#)

[Go to a step-by-step procedure for displaying waveforms.](#)

Customizable display elements

The following lists contains information on customizable display elements and their points of access.

Color Palette (Graticule and Waveform):

Access these elements through the Display menu Colors command, Display menu Display Palette submenu, or Display Setup control window Colors tab (Disp toolbar button):

- **Normal.** Displays hues and lightness levels for best overall viewing. The color of each channel waveform matches the color of the corresponding front-panel vertical SCALE knob.
- **On the Spectral Grading) palette.** Areas of the waveform with the highest sample density appear in blue shades and the areas of lowest sample density appear in red shades.

- **On the Temp (Temperature Grading) palette.** Areas of the waveform with the highest sample density appear in warmer colors (red shades) and the areas of lowest sample density appear in cooler colors (blue shades).
- **Gray (Monochrome Gray).** Displays waveforms in shades of gray. Areas of the waveform with the highest sample density appear in lighter gray shades and the areas of lowest sample density appear in darker gray shades.
- **Green (Monochrome Green).** Displays waveforms in shades of green. Areas of the waveform with the highest sample density appear in lighter green shades and the areas of lowest sample density appear in darker green shades.

Date and Time:

Access these elements through the Display menu Objects command, Display menu Display Date & Time command, or Display Setup control window Objects tab Disp toolbar button):

- **Toggle.** Alternates the display of the date and time on the graticule. To set the time and date, use the Utilities menu Set Time & Date command.

Display Format:

Access these elements through the Display Appearance or Display Format commands, the Display toolbar button, or the Display Setup Control Window Appearance tab:

- **XY or YT Formatting.** For additional information, see [Display Format](#).

Display Persistence:

Access these elements through the Display menu Display Persistence submenu commands or Display Setup control window Appearance tab (Disp toolbar button):

- **Infinite persistence.** Continuously accumulates record points on the waveform until you change one of the acquisition display settings. Use for displaying points that may occur outside the normal acquisition envelope.
- **Variable persistence.** Accumulates record points on the waveform for a specified time interval. Each record point decays independently according to the time interval.
- **Off.** Shows waveform record points for the current acquisition only. Each new waveform record replaces the previously acquired record for a channel.

Display Style:

Access these elements through the Display menu Display Style submenu commands or Display Setup control window Appearance tab (Disp toolbar button):

- **Vectors.** Displays waveforms with lines drawn between record points.
- **Dots.** Displays waveform record points as dots on the screen.
- **Inten Samp (Intensified Samples).** Shows the actual samples on interpolated waveforms.

Graticule Style:

Access these elements through the Display menu Graticule Style command or Display Setup control window Objects tab Disp toolbar button):

- **Full.** Provides a grid, cross hairs, and frame on the instrument display. Use for quick estimates of waveform parameters.
- **Grid.** Shows a frame and grid on the instrument display. Use for full-screen measurements with cursors and automatic readouts when cross hairs are not needed.
- **Cross Hair.** Shows cross hairs and a frame on the instrument display. Use for making quick estimates of waveforms while leaving more room on the display for automatic readouts and other data.
- **Frame.** Shows only a frame on the instrument display. Use with automatic readouts and other screen text when other display features are not needed.

- **IRE.** Use for NTSC video signals.
- **mV.** Use for video signals other than NTSC.

Math Colors:

Access these elements through the Display menu Colors command or Display Setup control window Colors tab (Disp toolbar button):

- **Default.** Uses the default system color (red) for math waveforms.
- **Inherit.** Uses the same color for the math waveform as the waveform the math function is based on.

Reference Colors:

Access these elements through the Display menu Colors command or Display Setup control window Colors tab (Disp toolbar button):

- **Default.** Uses the default system color (white) for reference waveforms.
- **Inherit.** Uses the same color for the reference waveform as the original waveform.

Screen Text:

Access these elements through the Display menu Screen Text command or Display Setup control window Screen Text tab (Disp toolbar button):

- **Up to eight (8) lines of text.** Provides notes for screen shots, printouts, or for other instrument users.
- **Display.** Turns the text display on and off.
- **Properties.** Opens the Text Properties control window for positioning of the text on the display.
- **Clear.** Erases the entire text of the selected line.

Trigger Level Marker:

Access these elements through the Display menu Objects command or Display Setup control window Objects tab (Disp toolbar button):

- **Short.** Displays a short arrow on the side of the graticule by the active waveform.
- **Long.** Displays a horizontal line through the active waveform.

Waveform Interpolation:

Access these elements through the Display menu Waveform Interpolation submenu or Display Setup control window Appearance tab (Disp toolbar button):

- **Sin(x)/x.** Provides $\text{Sin}(x)/x$ interpolation of the waveform.
- **Linear.** Provides linear interpolation of the waveform.

What do you want to do next?

[Learn about waveform display and the time base.](#)

[Learn about using the MultiView Zoom feature.](#)

[Go to a step-by-step procedure for displaying waveforms.](#)

Acquisition preview

The acquisition preview attempts to show what the next acquisition will look like when the acquisition is delayed due to slow triggers or long acquisition duration, or when the acquisitions have stopped. Acquisition preview recalculates math waveforms, but does not represent changes in trigger levels, trigger modes, or different acquisition modes.

Acquisition preview has some limitations. For example, if the horizontal scale is changed to a setting that is significantly faster or slower, the waveform display is cleared.

NOTE. *There is no acquisition preview in Fast Acquisitions mode.*

What do you want to do next?

[Learn more about waveform display.](#)

[Learn about waveform display and time base.](#)

[Go to a step-by-step procedure for displaying waveforms.](#)

Waveform display

Content to be determined

Operations on the time base

In general, to adjust the time base, use the front-panel horizontal Scale, Resolution, and Positions knobs. Only channel waveforms can be set directly.

Here are some key points to remember about how horizontal operations relate to the waveform types:

- Reference waveforms are shown with the horizontal settings in effect at the time that they are saved. You cannot adjust these settings. See [Saving and Recalling Waveforms](#) more information on reference waveforms.
- Math waveforms are shown with the horizontal settings derived from the math expression that creates them. You cannot change these directly. See [Creating or Using Math Waveforms](#) for more information on math waveforms.
- All waveforms are displayed within the horizontal divisions that the graticule provides. However, some waveforms may actually be wider or narrower than the display due to acquisition rate/time scale combinations and acquisition preview.

What do you want to do next?

[Learn about the horizontal reference point.](#)

[Learn about using the MultiView Zoom feature.](#)

[Go to a step-by-step procedure for displaying waveforms.](#)

Horizontal position and the horizontal reference point

The time value you set for horizontal position is measured from the trigger point to the horizontal reference point. This is not the same as the time value from the trigger point to the start of the waveform record, unless you set the horizontal reference to 0%. See the next figure.

What do you want to do next?

[Learn about interpolation.](#)

[Learn about using the MultiView Zoom feature.](#)

[Go to a step-by-step procedure for displaying waveforms.](#)

Using the MultiZoom feature

Use the instrument MultiZoom feature to magnify an acquisition vertically, horizontally, or in both dimensions to let you see the fine detail in your signals without changing the acquisition parameters (sample rate, record length, and so on). For example, to temporarily expand the front corner of a pulse to inspect its aberrations, push the front-panel MultiZoom button to expand it horizontally and vertically.

To help you use Multizoom effectively, consider how it operates on waveforms:

- When zooming vertically, the instrument expands up to four zoomed areas at one time. The zoomed areas can all be on the same waveform or they can be on different Channel, Math or Reference waveforms. Each zoomed area has its own vertical position and factor.
- When zooming horizontally, the Zoom Source is either the acquisition waveform or one of the zoomed areas.
- When zooming either horizontally or vertically, Zoom expands or contracts the waveform by the Zoom Factor.

What do you want to do next?

[Go to a step-by-step procedure for displaying waveforms.](#)

[Go to a step-by-step procedure for using MultiView Zoom.](#)

Waveform measurement

Automatic measurements

All channel, reference, and math waveforms can serve as sources for automatic measurements. Some measurements, such as Delay and Phase, require two sources.

NOTE. Automatic measurements are not available on digital channels.

The following automatic measurement categories are available:

- [Amplitude](#)
- [Time](#)
- [More](#) (miscellaneous)
- [Histogram](#)
- [Communication](#)

Click the category for a list of the measurements that you can choose from in each category.

The instrument can take and update up to eight measurements at one time. You can apply measurements to any combination of sources. For example, you can take all eight measurements on Channel 1, or you can take measurements on a combination of channel waveforms, math waveforms, reference waveforms, and/or histograms.

High/Low method. The levels that the automatic measurement system derives as the High (top) or Low (bottom) for a waveform influence the fidelity of amplitude and aberration measurements. Select among the modes the instrument provides for determining these levels:

- Histogram mode sets the values statistically. It selects the most common value either above or below the midpoint (depending on whether it is defining the High or Low reference level). Since this statistical approach ignores short term aberrations (overshoot, ringing, and so on), Histogram is the best setting for examining pulses. See the next figure.
- Min-Max mode uses the highest and lowest values of the waveform record. This setting is best for examining waveforms that have no large, flat portions at a common value, such as sine waves and triangle waves (almost any waveform except for pulses). See the next figure.

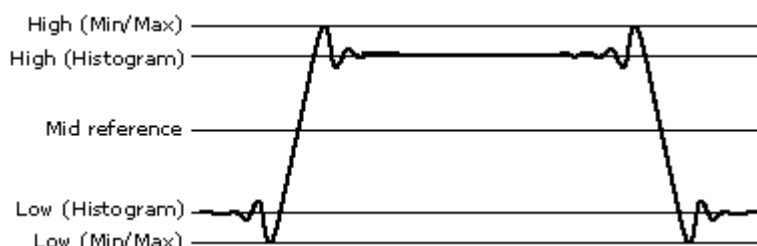

Reference levels method. A second set of levels affect the fidelity of time-related measurements. For example, the measurement system calculates rise time from the waveform edge that transitions from the Low to the High reference levels.

The instrument provides the following calculation methods (see the next figure):

- Relative Reference is calculated as a percentage of the High/Low range.
- Absolute Reference is set by absolute values in user units.

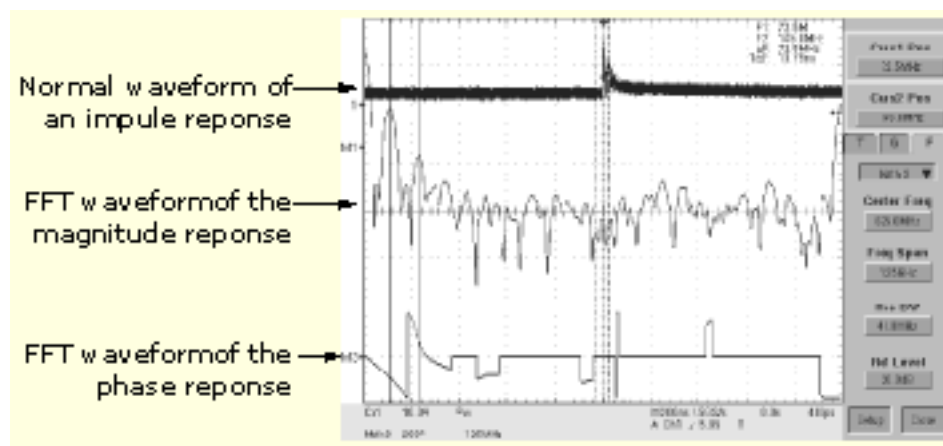

What do you want to do next?

[Learn about cursor measurements.](#)

[Go to a step-by-step procedure for taking automatic measurements.](#)

Measurement variables

By knowing how the instrument makes calculations, you may better understand how to use your instrument and how to interpret your results. The instrument uses a variety of variables in its calculations. These include:

High, low. *High* is the value used as the 100% level in measurements such as fall time and rise time. For example, if you request the 10% to 90% rise time, then the instrument calculates 10% and 90% as percentages with *High* representing 100%.

Low is the value used as the 0% level in measurements such as fall time and rise time.

The exact meaning of *High* and *Low* depends on which of two calculation methods you choose from the High-Low Setup item of the Measure menu. These are *Min-max* and *Histogram*.

Min-Max method. defines the 0% and the 100% waveform levels as the lowest amplitude (most negative) and the highest amplitude (most positive) samples. The min-max method is useful for measuring frequency, width, and period for many types of signals. Min-max is sensitive to waveform ringing and spikes, however, and does not always measure accurately rise time, fall time, overshoot, and undershoot.

The min-max method calculates the High and Low values as follows:

High = Max

and

Low = Min

Histogram method. attempts to find the highest density of points above and below the waveform midpoint. It attempts to ignore ringing and spikes when determining the 0% and 100% levels. This method works well when measuring square waves and pulse waveforms.

The oscilloscope calculates the histogram-based *High* and *Low* values as follows:

1. It makes a histogram of the record with one bin for each digitizing level (256 total).
2. It splits the histogram into two sections at the halfway point between *Min* and *Max* (also called *Mid*).
3. The level with the most points in the upper histogram is the *High* value, and the level with the most points in the lower histogram is the *Low* value. (Choose the levels where the histograms peak for *High* and *Low*)

If *Mid* gives the largest peak value within the upper or lower histogram, then return the *Mid* value for both *High* and *Low* (this is probably a very low amplitude waveform).

If more than one histogram level (bin) has the maximum value, choose the bin farthest from *Mid*.

This algorithm does not work well for two-level waveforms with greater than about 100% overshoot.

HighRef, MidRef, LowRef, Mid2Ref. You set the various reference levels, through the Reference Level selection of the Measure menu. They include:

HighRef. the waveform high reference level. Used in fall time and rise time calculations. Typically set to 90%. You can set it from 0% to 100% or to a voltage level.

MidRef. the waveform middle reference level. Typically set to 50%. You can set it from 0% to 100% or to a voltage level.

LowRef. the waveform low reference level. Used in fall and rise time calculations. Typically set to 10%. You can set it from 0% to 100% or to a voltage level.

Mid2Ref. the middle reference level for a second waveform (or the second middle reference of the same waveform). Used in delay time calculations. Typically set to 50%. You can set it from 0% to 100% or to a voltage level.

Other variables. The instrument also measures several values itself that it uses to help calculate measurements.

Record Length. is the number of data points in the time base. You set it with the Horizontal menu Record Length item.

Start. is the location of the start of the measurement zone (X-value). It is 0.0 samples unless you are making a gated measurement. When you use gated measurements, it is the location of the left vertical cursor.

End. is the location of the end of the measurement zone (X-value). It is $(RecordLength - 1.0)$ samples unless you are making a gated measurement. When you use gated measurements, it is the location of the right vertical cursor.

Hysteresis. is the hysteresis band 10% of the waveform amplitude. It is used in *MCross1*, *MCross2*, and *MCross3* calculations.

For example, once a crossing has been measured in a negative direction, the waveform data must fall below 10% of the amplitude from the *MidRef* point before the measurement system is armed and ready for a positive crossing. Similarly, after a positive *MidRef* crossing, waveform data must go above 10% of the amplitude before a negative crossing can be measured. Hysteresis is useful when you are measuring noisy signals, because it allows the oscilloscope to ignore minor fluctuations in the signal.

MCross calculations. **MCross1**, **MCross2**, and **MCross3** refer to the first, second, and third *MidRef* cross times, respectively.

The polarity of the crossings does not matter for these variables, but the crossings alternate in polarity; that is, *MCross1* could be a positive or negative crossing, but if *MCross1* is a positive crossing, *MCross2* will be a negative crossing.

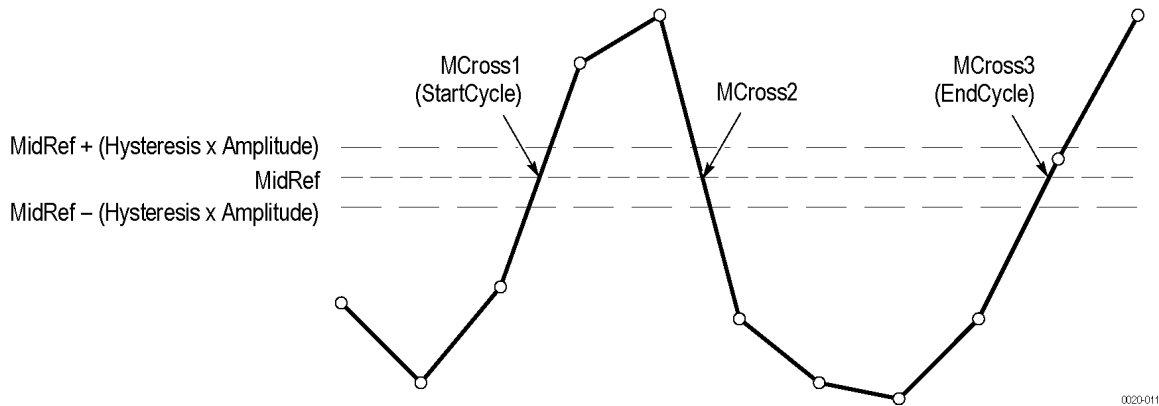

Figure 19: MCross Calculations

The instrument calculates these values as follows:

1. Find the first *MidRefCrossing* in the waveform record or the gated region. This is *MCross1*.
2. Continuing from *MCross1*, find the next *MidRefCrossing* in the waveform record (or the gated region) of the opposite polarity of *MCross1*. This is *MCross2*.
3. Continuing from *MCross2*, find the next *MidRefCrossing* in the waveform record (or the gated region) of the same polarity as *MCross1*. This is *MCross3*.

MCross1Polarity is the polarity of first crossing (no default). It can be rising or falling.

StartCycle is the starting time for cycle measurements. It is a floating-point number with values between 0.0 and (*Record Length* – 1.0), inclusive.

$$\text{StartCycle} = \text{MCross1}$$

EndCycle is the ending time for cycle measurements. It is a floating-point number with values between 0.0 and (*Record Length* – 1.0), inclusive.

$$\text{EndCycle} = \text{MCross3}$$

Waveform[<0.0 ... RecordLength–1.0>]; holds the acquired data.

TPOS is the location of the sample just before the trigger point (the time reference zero sample). In other terms, it contains the domain reference location. This location is where time = 0.

TSOFF is the offset between *TPOS* and the actual trigger point. In other words, it is the trigger sample offset. Values range between 0.0 and 1.0 samples. This value is determined by the instrument when it receives a trigger. The actual zero reference (trigger) location in the measurement record is at (*TPOS* + *TSOFF*).

Measurement algorithms

The automated measurements are defined and calculated as follows:

Amplitude. $Amplitude = High - Low$

Area. The arithmetic area for one waveform. Remember that one waveform is not necessarily equal to one cycle. For cyclical data you may prefer to use the cycle area rather than the arithmetic area.

If $Start = End$ then return the (interpolated) value at $Start$.

Otherwise,

$$Area = \int_{Start}^{End} Waveform(t) dt$$

0020-012

Details of the integration algorithm are given later. [Integration Algorithm](#)

Cycle area. Amplitude (voltage) measurement. The area over one waveform cycle. For data not cyclical, you might prefer to use the Area measurement.

If $StartCycle = EndCycle$ then return the (interpolated) value at $StartCycle$.

$$CycleMean = \int_{StartCycle}^{EndCycle} Waveform(t) dt$$

0020-013

Details of the integration algorithm are given later. [Integration Algorithm](#)

Burst width. Timing measurement. The duration of a burst.

1. Find $MCross1$ on the waveform. This is $MCrossStart$.
2. Find the last $MCross$ (begin the search at $EndCycle$ and search toward $StartCycle$). This is $MCrossStop$. This could be a different value from $MCross1$.
3. Compute $BurstWidth = MCrossStop - MCrossStart$

Cycle mean. Amplitude (voltage) measurement. The mean over one waveform cycle. For non-cyclical data, you might prefer to use the Mean measurement.

If $StartCycle = EndCycle$ then return the (interpolated) value at $StartCycle$.

$$CycleMean = \frac{\int_{StartCycle}^{EndCycle} Waveform(t) dt}{(EndCycle - StartCycle) \times SampleInterval}$$

0020-014

Details of the integration algorithm are given later. [Integration Algorithm](#)

Cycle RMS. The true Root Mean Square voltage over one cycle.

If $StartCycle = EndCycle$ then $CycleRMS = Waveform[Start]$.

Otherwise,

$$CycleRMS = \sqrt{\frac{\int_{StartCycle}^{EndCycle} (Waveform(t))^2 dt}{(EndCycle - StartCycle) \times SampleInterval}}$$

0020-015

Details of the integration algorithm are given later. [Integration Algorithm](#)

Delay. Timing measurement. The amount of time between the *MidRef* and *Mid2Ref* crossings of two different traces, or two different places on the same trace.

Delay measurements are actually a group of measurements. To get a specific delay measurement, you must specify the target and reference crossing polarities and the reference search direction.

Delay = the time from one *MidRef* crossing on the source waveform to the *Mid2Ref* crossing on the second waveform.

Delay is not available in the Snapshot display.

Extinction ratio. Optical measurement between 1 and 100. In real circuits, the extinction ratio is typically 8 to 30. Values ≤ 1 or ≥ 100 generate errors. An Extinction Ratio of 1 or 100 means a problem exists. The optical probe and the instrument must be calibrated. All inputs are micro watts and are not negative. Extinction ratio is dimensionless.

Extinction Ratio = (High/Low)

Low $\geq 1 \mu W$

Extinction %. Optical measurement.

Extinction % = $100.0 / Extinction Ratio$

Extinction dB. Optical measurement. Extinction dB is typically 8 to 12 db. To exceed this range the input may be from nonoptical probes or noncommunication lasers.

$$\text{Extinction dB} = 10.0 (\log_{10}(\text{Extinction Ratio}))$$

Fall time. fall time

Timing measurement. The time taken for the falling edge of a pulse to drop from a *HighRef* value (default = 90%) to a *LowRef* value (default = 10%).

The following figure shows a falling edge with the two crossings necessary to calculate a Fall measurement.

1. Searching from *Start* to *End*, find the first sample in the measurement zone greater than *HighRef*.
2. From this sample, continue the search to find the first (negative) crossing of *HighRef*. The time of this crossing is *THF*. (Use linear interpolation if necessary.)

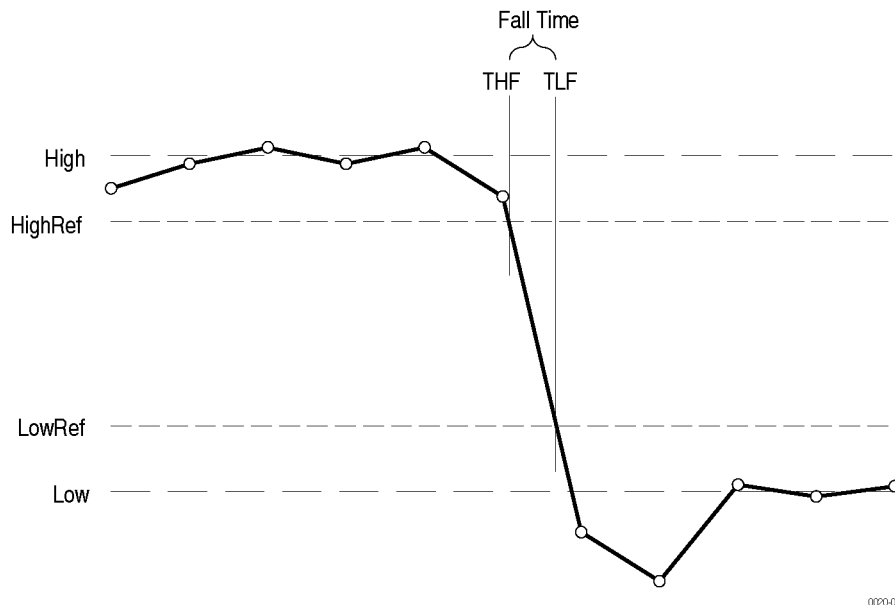

Figure 20: Fall Time

3. From *THF*, continue the search, looking for a crossing of *LowRef*. Update *THF* if subsequent *HighRef* crossings are found. When a *LowRef* crossing is found, it becomes *TLF*. (Use linear interpolation if necessary.)
4. $\text{FallTime} = \text{TLF} - \text{THF}$

Frequency. Timing measurement. The reciprocal of the period. Measured in Hertz (Hz) where 1 Hz = 1 cycle per second.

If *Period* = 0 or is otherwise bad, return an error.

$$\text{Frequency} = 1 / \text{Period}$$

High. 100% (highest) voltage reference value. See [High Low](#).

Using the min-max measurement technique:

$$\text{High} = \text{Max}$$

Low. 0% (lowest) voltage reference value calculated. See [High Low](#)

Using the min-max measurement technique:

$$Low = Min$$

Maximum. Amplitude (voltage) measurement. The maximum voltage. Typically the most positive peak voltage.

Examine all *Waveform[]* samples from *Start* to *End* inclusive, and set *Max* equal to the greatest magnitude *Waveform[]* value found.

Mean. The arithmetic mean for one waveform. Remember that one waveform is not necessarily equal to one cycle. For cyclical data you may prefer to use the cycle mean rather than the arithmetic mean.

If *Start* = *End* then return the (interpolated) value at *Start*.

Otherwise,

$$Mean = \frac{\int_{Start}^{End} Waveform(t) dt}{(End - Start) \times SampleInterval}$$

0020-017

Details of the integration algorithm are given later. [Integration Algorithm](#)

Mean dBm. The normalized mean. If the waveform source is from an optical probe, this can give average optical power.

$$Mean\ dBm = 10.0 (\log_{10}(Mean / 0.001))$$

Minimum. Amplitude (voltage) measurement. The minimum amplitude. Typically the most negative peak voltage.

Examine all *Waveform[]* samples from *Start* to *End* inclusive, and set *Min* equal to the smallest magnitude *Waveform[]* value found.

Negative duty cycle. Timing measurement. The ratio of the negative pulse width to the signal period expressed as a percentage.

NegativeWidth is defined in *Negative Width*, below.

If *Period* = 0 or undefined then return an error.

$$NegativeDutyCycle = \frac{NegativeWidth}{Period} \times 100\%$$

0020-018

Negative overshoot. Amplitude (voltage) measurement.

$$\text{NegativeOvershoot} = \frac{\text{Low} - \text{Min}}{\text{Amplitude}} \times 100\%$$

0020-019

Note that this value should never be negative (unless *High* or *Low* are set out-of-range).

Negative width. Timing measurement. The distance (time) between *MidRef* (default = 50%) amplitude points of a negative pulse.

If *MCross1Polarity* = –

then

$$\text{NegativeWidth} = (\text{MCross2} - \text{MCross1})$$

else

$$\text{NegativeWidth} = (\text{MCross3} - \text{MCross2})$$

Waveform[Start]

Optical power. See [Mean dBm](#).

Peak to peak. Amplitude measurement. The absolute difference between the maximum and minimum amplitude.

$$\text{PeaktoPeak} = \text{Max} - \text{Min}$$

Period. Timing measurement. Time taken for one complete signal cycle. The reciprocal of frequency. Measured in seconds.

$$\text{Period} = \text{MCross3} - \text{MCross1}$$

Phase. Timing measurement. The amount of phase shift, expressed in degrees of the target waveform cycle, between the *MidRef* crossings of two different waveforms. Waveforms measured should be of the same frequency or one waveform should be a harmonic of the other.

Phase is a dual waveform measurement; that is, it is measured from a target waveform to a reference waveform. To get a specific phase measurement, you must specify the target and reference sources.

Phase is determined in the following manner:

1. The first *MidRefCrossing* (*MCross1Target*) and third (*MCross3*) in the source (target) waveform are found.
2. The period of the target waveform is calculated (see *Period* above).
3. The first *MidRefCrossing* (*MCross1Ref*) in the reference waveform crossing in the same direction (polarity) as that found *MCross1Target* for the target waveform is found.
4. The phase is determined by the following:

$$Phase = \frac{MCross1Ref - MCross1Target}{Period} \times 360$$

0020-020

If the target waveform leads the reference waveform, phase is positive; if it lags, negative.

Phase is not available in the Snapshot display.

Positive duty cycle. Timing measurement. The ratio of the positive pulse width to the signal period, expressed as a percentage.

PositiveWidth is defined in *Positive Width*, following.

If *Period* = 0 or undefined then return an error.

$$PositiveDutyCycle = \frac{PositiveWidth}{Period} \times 100\%$$

0020-021

Positive overshoot. Amplitude (voltage) measurement.

$$PositiveOvershoot = \frac{Max - High}{Amplitude} \times 100\%$$

0020-022

Note that this value should never be negative.

Positive width. Timing measurement. The distance (time) between *MidRef* (default = 50%) amplitude points of a positive pulse.

If *MCross1Polarity* = +

then

$$PositiveWidth = (MCross2 - MCross1)$$

else

$$PositiveWidth = (MCross3 - MCross2)$$

Rise time. Timing measurement. Time taken for the leading edge of a pulse to rise from a *LowRef* value (default = 10%) to a *HighRef* value (default = 90%).

The following figure shows a rising edge with the two crossings necessary to calculate a Rise Time measurement.

1. Searching from *Start* to *End*, find the first sample in the measurement zone less than *LowRef*.
2. From this sample, continue the search to find the first (positive) crossing of *LowRef*. The time of this crossing is the low rise time or *TLR*. (Use linear interpolation if necessary.)
3. From *TLR*, continue the search, looking for a crossing of *HighRef*. Update *TLR* if subsequent *LowRef* crossings are found. If a *HighRef* crossing is found, it becomes the high rise time or *THR*. (Use linear interpolation if necessary.)
4. $RiseTime = THR - TLR$

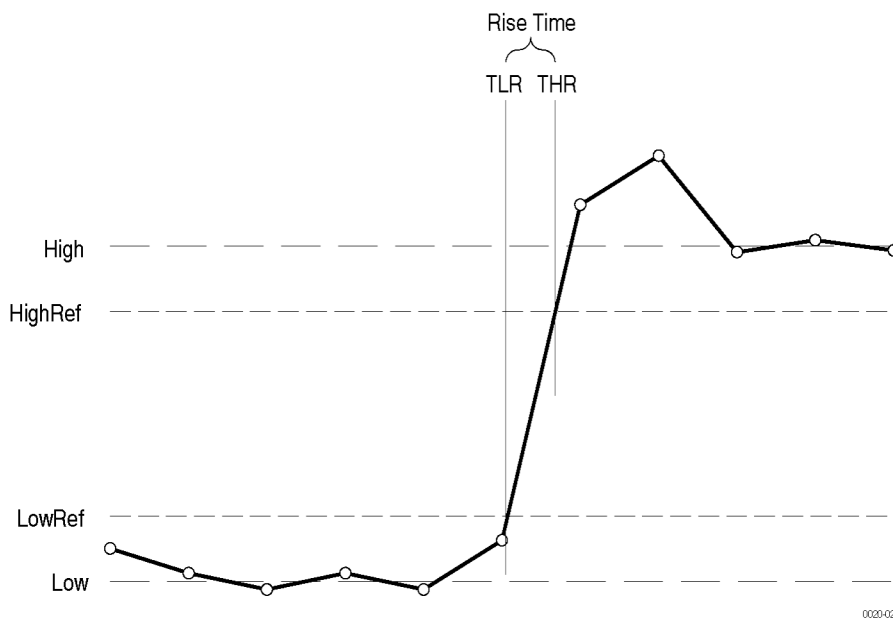

Figure 21: Rise Time

RMS. Amplitude (voltage) measurement. The true Root Mean Square voltage.

If $Start = End$ then $RMS =$ the (interpolated) value at $Waveform[Start]$.

Otherwise,

$$RMS = \sqrt{\frac{\int_{Start}^{End} (Waveform(t))^2 dt}{(End - Start) \times SampleInterval}}$$

Details of the integration algorithm are given later. [Integration Algorithm](#)

Integration Algorithm. The integration algorithm used by the instrument is as follows:

$$\int_A^B W(t)dt \text{ is approximated by } \int_A^B \hat{W}(t)dt \text{ where:}$$

0020-025

$W(t)$ is the sampled waveform

$\hat{W}(t)$ is the continuous function obtained by linear interpolation of $W(t)$

A and B are numbers between 0.0 and $RecordLength - 1.0$

If A and B are integers, then:

$$\int_A^B \hat{W}(t)dt = s \times \sum_{i=A}^{B-1} \frac{W(i) + W(i + 1)}{2}$$

0020-026

where s is the sample interval.

Similarly,

$$\int_A^B (W(t))^2 dt \text{ is approximated by } \int_A^B (\hat{W}(t))^2 dt \text{ where:}$$

0020-027

$W(t)$ is the sampled waveform

$\hat{W}(t)$ is the continuous function obtained by linear interpolation of $W(t)$

A and B are numbers between 0.0 and $RecordLength - 1.0$

If A and B are integers, then:

$$\int_A^B (\hat{W}(t))^2 dt = s \times \sum_{i=A}^{B-1} \frac{(W(i))^2 + W(i) \times W(i + 1) + (W(i + 1))^2}{3}$$

0020-028

where s is the sample interval.

Measurements on envelope waveforms

Time measurements on envelope waveforms must be treated differently from time measurements on other waveforms, because envelope waveforms contain so many apparent crossings. Unless otherwise noted, envelope waveforms use either the minima or the maxima (but not both), determined in the following manner:

1. Step through the waveform from *Start* to *End* until the sample min and max pair do not straddle *MidRef*.

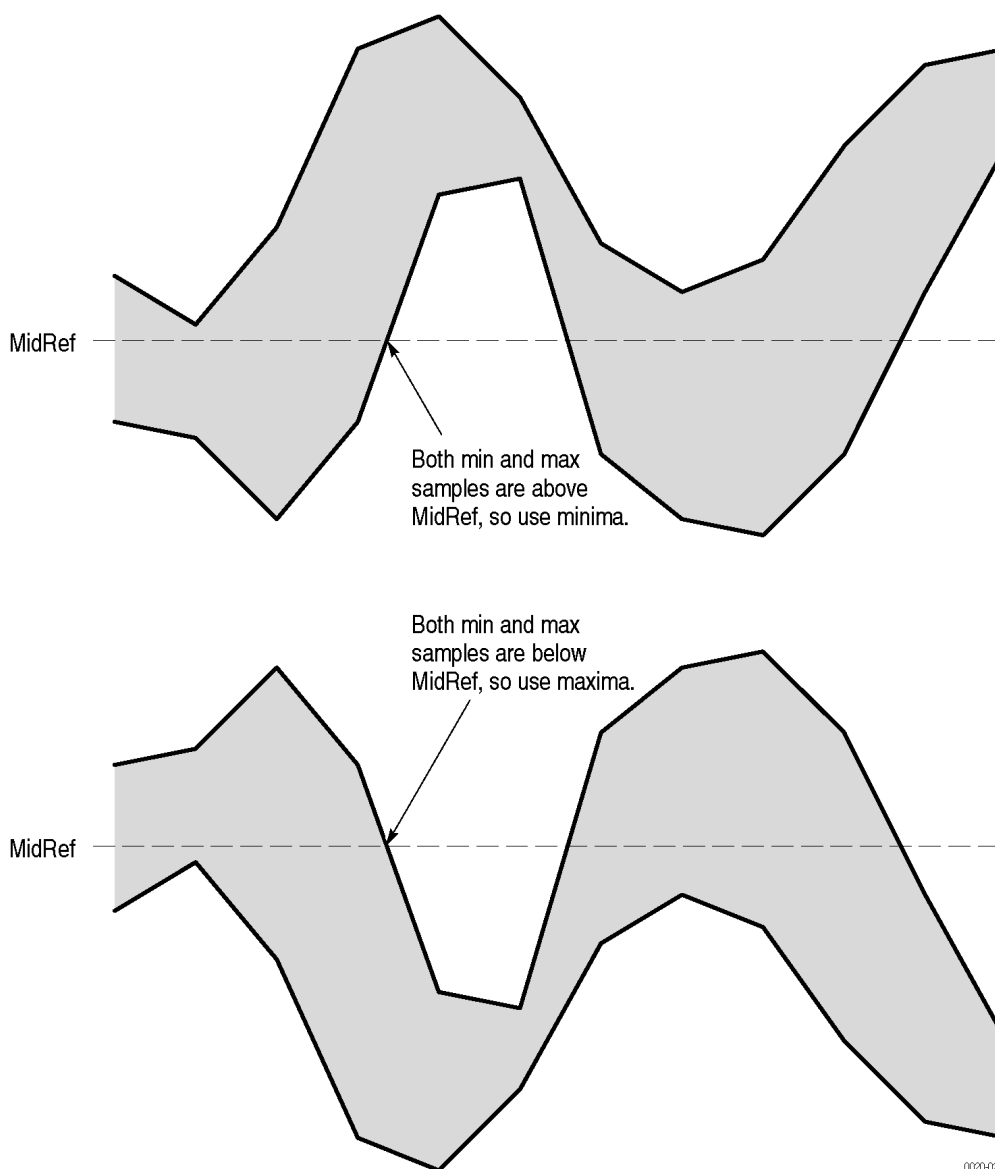

Figure 22: Choosing Minima or Maxima to Use for Envelope Measurements

2. If the pair $> MidRef$, use the minima, else use maxima.
If all pairs straddle *MidRef*, use maxima. See the figure.

The Burst Width measurement always uses both maxima and minima to determine crossings.

Missing or out-of-range samples

If some samples in the waveform are missing or off-scale, the measurements will interpolate between known samples to make an appropriate guess as to the sample value. Missing samples at the ends of the measurement record will be assumed to have the value of the nearest known sample.

When samples are out of range, the measurement will give a warning to that effect (for example, CLIPPING) if the measurement could change by extending the measurement range slightly. The algorithms assume the samples recover from an overdrive condition instantaneously.

For example, if *MidRef* reference level is set directly, then *MidRef* would not change even if samples were out of range. However, if *MidRef* was chosen using the % choice from the **Set Levels in % Units** selection of the Measure menu, then *MidRef* could give a CLIPPING warning.

NOTE. When measurements are displayed using Snapshot, out of range warnings are NOT available. However, if you question the validity of any measurement in the snapshot display, you can select and display the measurement individually and then check for a warning message.

Measurement warnings

The following measurement warnings can be generated by the instrument. They may be generated in various situations such as those described below. In general, measurement warnings produce measurement results that are uncertain.

| Warning | Description |
|--|--|
| Not yet computed | Displayed until a measurement is completed. This is displayed if you hit the clear button and the instrument is waiting for a trigger. |
| LTGT | This is a measurement warning that's only generated in some cases where null samples are present in a waveform, such as an ET waveform or a math waveform generated by <code>arbflt()</code> functions. It is a warning that strictly speaking a measurement might be larger then or less then the reported value because some samples were null in measured waveform. |
| Uncertain | This is a generic warning regarding an uncertain result and can result for measurements that depend on multiple sub-measurements to generate a result (such as area, or rms that need to measure times and voltages). If one of the sub-measurements generates a warning the combination of warnings may be combined to simply report 'uncertain' to the user. |
| Low signal amplitude | This is reported when the measurement system tries to find a cross for a waveform less then 50 digitizing levels high. |
| Unstable histogram | This is generated for histogram measurements when the resulting histogram size is too narrow to perform an accurate measurement. It might show up for some eye measurements. |
| Low resolution | This is a common warning that can occur when there is insufficient horizontal resolution to get accurate timing measurements. |
| Uncertain edge | This warning is generated in eye diagram measurements when there isn't sufficient resolution to determine an edge to measure. |
| Clipping positive Clipping negative Clipping pos neg | These are generated in response to any input waveform that has generated an over range or under range DAC value, indicating the waveform went off screen. |

Measurement errors



The following measurement errors can be generated by the instrument. They may be generated in various situations such as those described below. In general, measurements producing an error will produce nothing.

| Error | Description |
|-----------------------------|--|
| Unstable | These are generic error messages that occur when the measurement system was unable to obtain a correct measurement |
| Measurement system error | |
| Zero period | These occur when the measurement system was unable to correctly measure the period of a waveform |
| No period found | |
| No period 2nd waveform | |
| Low signal amplitude | These occur when the measurement system was unable to correctly measure the signal amplitude of a waveform |
| Low amplitude 2nd wfm | |
| Invalid gate | This error can occur if measurement gating was turned on and gated a measurement to a region that was insufficient to complete a measurement |
| Waveform does not close ref | These errors can occur when the measurement system cannot correctly find edge crossings for the specified edge crossing and waveform |
| No second ref crossing | |
| No ref cross 2nd wfm | |
| No backwards ref cross | |
| Wfm does not cross Ref | |
| No ref cross 2nd wfm | |
| No ref cross 1st wfm | |
| Constant waveform | This can be generated from various timing based measurements on flat waveforms |
| No valid edge | This can occur when the measurement package was unable to extract a valid edge crossing in some timing measurements |

Cursor types

Because cursor measurements give immediate feedback on the amplitude or time values they measure, they are usually quick to take and are more accurate than graticule measurements. Also, since you can position cursors wherever you want them on the waveform, they are easier to localize to a waveform segment or feature than automatic measurements.

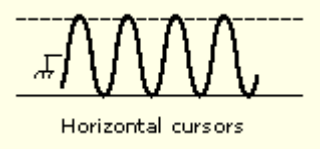
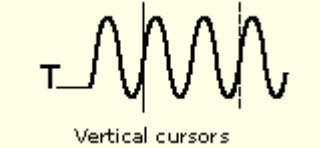
The following table defines the cursor types.

| Cursor function | Measurements |
|--|---|
|  <p data-bbox="186 399 373 420">Horizontal cursors</p> | <p data-bbox="795 273 1453 325">Horizontal cursors measure vertical parameters (amplitude) in volts, watts, or IRE. The cursor readouts are defined as:</p> <p data-bbox="795 336 1396 367">V1 = Level @ Cursor 1 with respect to its source ground level.</p> <p data-bbox="795 367 1396 399">V2 = Level @ Cursor 2 with respect to its source ground level.</p> <p data-bbox="795 399 1218 430">ΔV = Level @ Cursor 2 - Level @ Cursor 1.</p> <p data-bbox="795 430 1445 525">Level is cursor displacement from the source ground multiplied by the source in volts/div. The two cursors may have different sources and therefore can have different volts/div settings.</p> |
|  <p data-bbox="203 672 357 693">Vertical cursors</p> | <p data-bbox="795 535 1437 630">Vertical cursors measure horizontal parameters. Typically the horizontal parameters are in time or frequency, but depend on the units you select. The cursor readouts are defined as:</p> <p data-bbox="795 630 1323 661">T1 = Time @ Cursor 1 with respect to the trigger point</p> <p data-bbox="795 661 1323 693">T2 = Time @ Cursor 2 with respect to the trigger point</p> <p data-bbox="795 693 1193 724">ΔT = Time @ Cursor 2 - Time @ Cursor 1</p> <p data-bbox="795 724 1396 798">Time is divisions of displacement of the cursor from its source trigger point multiplied by the source in time/div.</p> |
|  <p data-bbox="178 934 397 955">Waveform and Screen</p> | <p data-bbox="795 808 1453 861">Waveform cursors measure vertical parameters (typically volts) and horizontal parameters (typically time or frequency) simultaneously.</p> <p data-bbox="795 861 1453 955">Each cursor is, in effect, both a vertical and horizontal cursor. These paired cursors cannot be moved off of the waveform. The two cursors can have a different source.</p> <p data-bbox="795 955 1453 1123">Use screen cursors to indicate an arbitrary X and Y position in the waveform display area represented by the intersection of a vertical and horizontal cursor line. Screen cursors measure both vertical parameters (typically volts) and horizontal parameters (typically time or frequency).</p> |

What do you want to do next?

[Learn about histograms.](#)

[Go to a step-by-step procedure for taking automatic measurements.](#)

Histograms

The instrument can display histograms constructed from the selected waveform data. You can display both vertical (voltage) and horizontal (time) histograms, but only one at a time. Use histogram measurements to get statistical measurement data for a section of a waveform along one axis.

The histogram source can be any channel, math, or reference waveform.

Turning on histograms starts histogram counting and data accumulation. A sample histogram display is shown below. Histogram data is continuously accumulated until you explicitly turn off histograms. This allows you to continue collecting histogram data even when you turn off the histogram display.

In addition to using limit controls to set histogram box boundaries, you can also use standard Windows drag-and-drop to resize and reposition the histogram box.

Histograms are not available in Zoom modes.

[Go to a step-by-step procedure for starting histogram counting.](#)

[Go to a step-by-step procedure for taking automatic measurements.](#)

Typical math waveforms

You create math waveforms when you create a math expression. You do so by applying numerical constants, math operators and functions to operands. You can display and manipulate these derived math waveforms much like you can the channel and reference waveforms (see [Using Math Waveforms](#)).

NOTE. Math calculations are not available on digital channels.

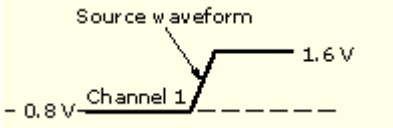
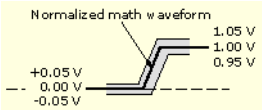
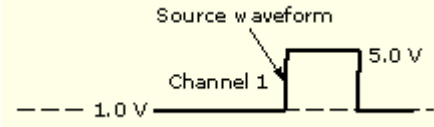
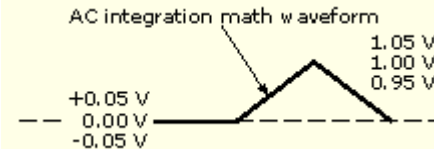
| Some examples of typical math waveforms | |
|---|---|
| To normalize this waveform: |  |
| Enter this math expression: | $(Ch1 - Meas1) / Meas2$, where Ch1 is the waveform shown above Meas1 = Low of Ch1 Meas2 = amplitude of Ch1 |
| And get this math waveform: |  |
| To simulate AC coupling on this waveform: |  |
| Enter this expression: | $Intg(Ch1 - Avg(Ch1))$, where Ch1 is the waveform shown above Avg is the average function |
| And get this math waveform: |  |

Offset, position, and scale. The settings that you make for offset, scale, and position affect the math waveform you obtain. Here are some tips for obtaining a good display:

- Scale and position the source waveform so that it is contained on the screen. (Off-screen waveforms may be clipped, resulting in errors in the derivative waveform.)
- Use vertical position and vertical offset to position your source waveform. The vertical position and offset will not affect your derivative waveform unless you position the source waveform off screen so that it is clipped.

What do you want to do next?

[Learn about math waveform sources.](#)

[Go to a step-by-step procedure for creating math waveforms.](#)

Math waveforms

Once you have acquired waveforms or taken measurements on waveforms, the instrument can mathematically combine them to create a waveform that supports your data-analysis task. For example, you might have a waveform clouded by background noise. You can obtain a cleaner waveform by subtracting the background noise from your original waveform. Or, you can integrate a single waveform into an integral math waveform as shown below.

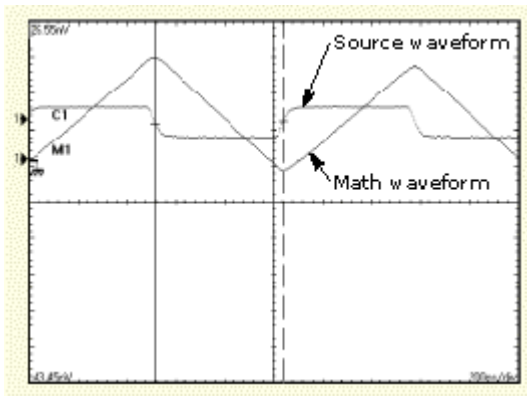

With spectral analysis you can analyze waveforms in the frequency domain. The interface is similar to a dedicated spectrum analyzer, so you do not need to know the details of the underlying algorithms. See the next figure.

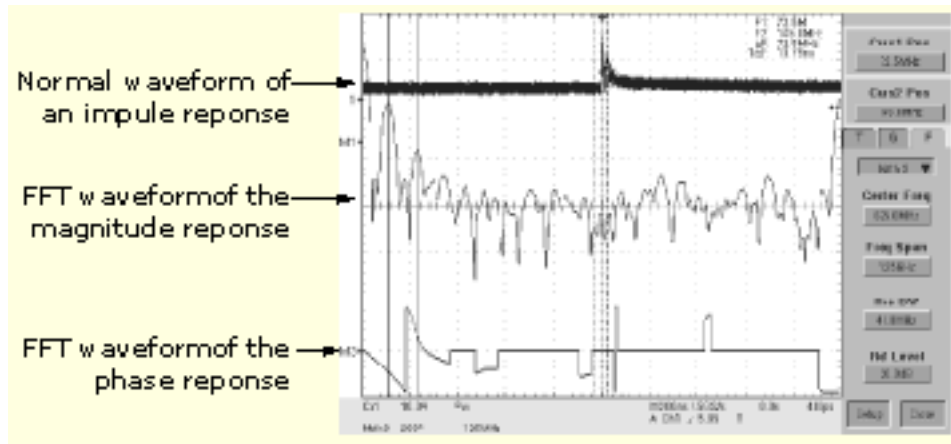

This instrument supports mathematical combination and functional transformations of waveforms it acquires. The next figure shows this concept:

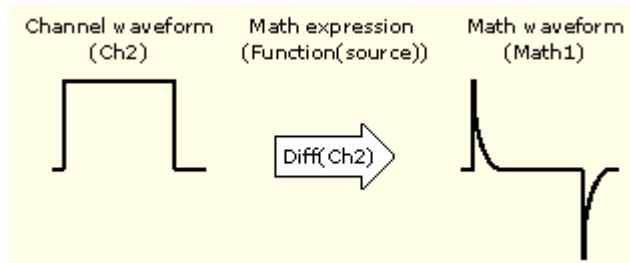

You create math waveforms to support the analysis of your channel and reference waveforms. By combining and transforming source waveforms and other data into math waveforms, you can derive the data view that your application requires. Create math waveforms that result from:

- Mathematical operations on one or several waveforms: add, subtract, multiply, and divide.
- Functional transformations of waveforms, such as integration, differentiation, and so on.
- Spectral analysis of waveforms, such as testing impulse response.

You can create up to four math waveforms.

Measurement scalars can be used in math expressions. For example, you can measure the average of a waveform (using the measurement capabilities of the instrument) and subtract it from the original waveform to define a new math waveform. Measurements 1 through 8 are allowed in a math definition, but not measurement functions, such as rise (Ch1).

This instrument supports the following operations for math waveforms:

- Vertical display scaling and positioning
- Taking automatic measurements
- Taking cursor measurements
- Using histograms
- User defined vertical units

In addition to the operations listed above, you can save math waveforms as reference waveforms.

You cannot use the following math waveforms for some operations:

- Circular Math-on-Math. You cannot use circular definitions of math waveforms. For example, if you define Math2 = Ch1 - Math1, and then define a second math waveform as Math3 = Ch2 + Math2, you cannot define a third math waveform as Math1 = Math2 + Ch3. If you do, the Math1 definition is rejected with an error because a circular definition is not allowed.
- Fast Acquisitions. Math is not allowed in Fast Acquisitions mode.
- Roll Mode. Math is not allowed in roll mode until you push STOP.
- Different Length Sources. If you use two waveforms (channel and reference waveforms) of different lengths, the length of the math waveform will be the shorter of the two lengths.

What do you want to do next?

[Learn about creating math waveforms.](#)

[Go to a step-by step procedure for using math waveforms.](#)

Math waveform differentiation

The math capabilities of the instrument include waveform differentiation. This allows you to display a derivative math waveform that indicates the instantaneous rate of change of the waveform acquired.

Derivative waveforms are used in the measurement of slew rate of amplifiers and in educational applications. You can create a derivative math waveform and then use it as a source for another derivative waveform. The result is the second derivative of the waveform that was first differentiated.

The math waveform, derived from the sampled waveform, is computed based on the following equation:

$$Y_n = (X(n + 1) - X_n) * 1/T$$

Where: **X** is the source waveform, **Y** is the derivative math waveform, and **T** is the time between samples.

Since the resultant math waveform is a derivative waveform (see the next figure), its vertical scale is in volts/second (its horizontal scale is in seconds). The source signal is differentiated over its entire record length; therefore, the math waveform record length equals that of the source waveform.

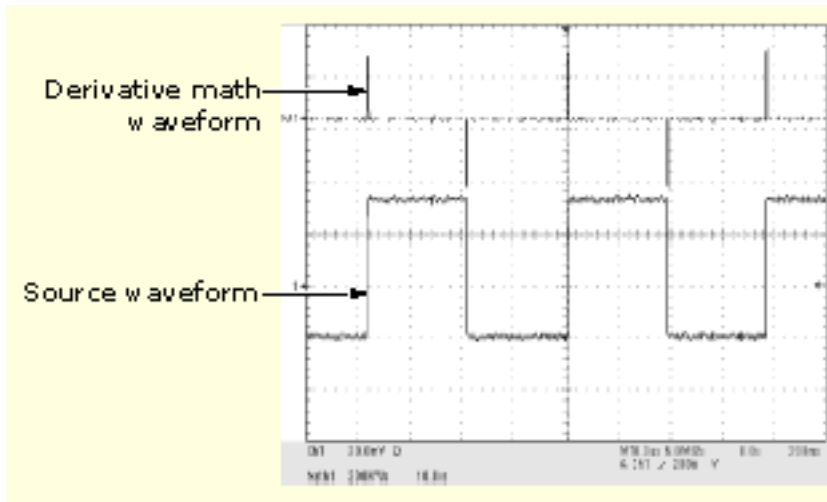

Cursor Measurements. You can also use cursors to measure derivative waveforms. Use the steps in [Taking Cursor Measurements](#). When using that procedure, note that the amplitude measurements on a derivative waveform will be in volts per second rather than in volt-seconds as is indicated for the integral waveform measured in the procedure.

NOTE. *Cursor measurements are not available on digital channels.*

What do you want to do next?

[Learn more about cursor measurements.](#)

[Go to a step-by-step procedure for creating math waveforms.](#)

[Go to a step-by-step procedure for using math waveforms.](#)

Math waveform sources

You can create Math waveforms from the following:

- Channel waveforms
- Reference waveforms
- Measurement scalars (automated measurements) that measure channel, reference, or math waveforms, or histograms.
- Other math waveforms
- Variables

Dependencies. In general, math waveforms that include sources as operands are affected by updates to those sources:

- Shifts in amplitude or DC level of input sources that cause the source to clip also clip the waveform data supplied to the math waveform.
- Changes to the vertical offset setting for a channel source that clips its data also clips the waveform data supplied to the math waveform.
- Changes to the acquisition mode globally affects all input channel sources, modifying any math waveforms using them. For example, with the acquisition mode set to Envelope, a Ch1 + Ch2 math waveform will receive enveloped channel 1 and channel 2 data, and will also be an envelope waveform.
- Clearing the data in a waveform source causes a baseline (ground) to be delivered to any math waveform that includes that source until the source receives new data.

What do you want to do next?

[Learn about math waveform expression syntax.](#)

[Go to a step-by-step procedure for creating math waveforms.](#)

[Go to a step-by-step procedure for using math waveforms.](#)

Math waveform expression syntax

You can build math waveforms using the Predefined Expressions or Equation Editor control window. To help you create valid math waveforms, the following tools will block most illegal entries by disabling any window element that would create an invalid entry in the math waveform expression.

Predefined expressions are performed from the Math Setup control window by selecting an expression.

The following syntax describes the valid math expressions you can use with the Equation Editor:

```

<MathWaveform> := <Expression>
<Expression> := <UnaryExpression> | <BinaryExpression>
<UnaryExpression> := <UnaryOperator> ( <Term> ) | <UnaryOperator> ( <Expression> )
<BinaryExpression> := <Term> <BinaryOperator> <Term> | <Scalar>
<BinaryOperator> <Term> | <Term> <BinaryOperator> <Scalar>
<Term> := <Waveform> | ( <Expression> )
<Scalar> := <Integer> | <Float> | <Meas-Result>
<Waveform> := <ChannelWaveform> | <ReferenceWaveform> | <MathWaveform>
<ChannelWaveform> := Ch1 | Ch2 | Ch3 | Ch4
<ReferenceWaveform> := Ref1 | Ref2 | Ref3 | Ref4
<MathWaveform> := Math1 | Math2 | Math3 | Math4
<UnaryOperator> := Invert | Derivative | Integral | Average | Max | Min | Filter |
Vmag | Exp | log 10 | log e | sqrt | Spectral Magnitude | Spectral Phase | Spectral
Real | Spectral Imag
<BinaryOperator> := + | - | / | *
<Meas-Result> := meas1 | meas2 | meas3 | meas4 | meas5 | meas6 | meas7 | meas8

```

What do you want to do next?

[Learn about math waveform differentiation.](#)

[Go to a step-by-step procedure for creating math waveforms.](#)

[Go to a step-by step procedure for using math waveforms.](#)

Math waveform offset, position, and scale

The settings that you make for offset, scale, and position affect the math waveform you obtain. Here are some tips for obtaining a good display:

- Scale and position the source waveform so that it is contained on the screen. (Off-screen waveforms may be clipped, resulting in errors in the derivative waveform).
- Use vertical position and vertical offset to position your source waveform. The vertical position and offset will not affect your derivative waveform unless you position the source waveform off screen so that it is clipped.

What do you want to do next?

[Learn about waveform integration.](#)

[Go to a step-by-step procedure for creating math waveforms](#)

[Go to a step-by step procedure for using math waveforms.](#)

Waveform integration

The math capabilities of the instrument include waveform integration. This allows you to display an integral math waveform that is an integrated version of the acquired waveform.

Use integral waveforms in the following applications:

- Measuring power and energy, such as in switching power supplies.
- Characterizing mechanical transducers, as when integrating the output of an accelerometer to obtain velocity.

The integral math waveform, derived from the sampled waveform, is computed based on the following equation:

$$y(n) = \text{scale} \sum_{i=1}^n \frac{x(i) + x(i-1)}{2} T$$

Where: **x(i)** is the source waveform, **y(n)** is a point in the integral math waveform, **scale** is the output scale factor, and **T** is the time between samples.

Since the resultant math waveform is an integral waveform, its vertical scale is in volt-seconds (its horizontal scale is in seconds). The source signal is integrated over its entire record length; therefore, the math waveform record length equals that of the source waveform.

Offset and position. When creating integrated math waveforms from live channel waveforms, consider the following:

- You should scale and position the source waveform so that it is contained on screen. (Off screen waveforms may be clipped, which will result in errors in the integral waveform.)
- You can use vertical position and vertical offset to position your source waveform. The vertical position and vertical offset will not affect your integral waveform unless you position the source waveform off screen so that it is clipped.

DC offset. The source waveforms that you connect to the instrument often have a DC offset component. The instrument integrates this offset along with the time-varying portions of your waveform. Even a few divisions of offset in the source waveform may be enough to ensure that the integral waveform saturates (clips), especially with long record lengths.

What do you want to do next?

[Learn about spectral math waveforms.](#)

[Go to a step-by-step procedure for creating math waveforms.](#)

[Go to a step-by step procedure for using math waveforms.](#)

Math plugins

Using math plugins

Math plugins extend the current built-in math system on your instrument. When the TekScope application starts, it scans C:\Users\Public\Tektronix\Plugins\Math and C:\Users\

Once the instrument has started, the plugin is used in the math system like any built in function. For example, if one of the libraries provides two functions, MyAdd and MyMultiply, each of which takes two vector inputs, the following math definitions are valid:

- $\text{Math1} = \text{MyAdd}(\text{Ch1}, \text{Ch2})$
- $\text{Math1} = \text{MyMultiply}(\text{Ch1} + \text{Ch2}, \text{Ch3})$
- $\text{Math2} = \text{MyAdd}(\text{Ref1}, \text{Math1})$
- $\text{Math1} = \text{MyMultiply}(\text{Ch1}, \text{Ch2}) + \text{Inv}(\text{Ch3})$
- $\text{Math1} = \text{MyMultiply}(\text{Avg}(\text{Ch1}), \text{Ch2})$

The math system generates standard syntax errors if there is an issue with a math equation using a plugin, such as a missing parenthesis. If there is an error with the plugin itself, math reports a plugin specific error. This may be that the plugin is not valid because it has mismatched input and output types or that an argument specified in the equation does not match the type expected by the plugin (for example, a string was expected but a FastFrame waveform was supplied).

Writing math plugins

You can write plugins in any .NET language. The following examples use C#. When writing a plugin, reference the ScopeSupportBase.dll and TekScriptingEngine.dll system assemblies. Additionally, tag all plugins with the C# attribute [Math] if they are to be loaded into the system.

Six different classes are used inside plugins: INormalizedVector, IFastFrame, IWaveformDB, IString, ISettings and IRange. The first two, INormalizedVector and IFastFrame, are waveform vector types used by the instrument. The third, IWaveformDB is a pixmap waveform. IStrings, ISettings and IRange are used to pass additional information into a plugin.

Waveform types. All waveform classes contain a member called `SourceName`. This is a string that contains the symbol name of the waveform source. If the source is a channel, math or reference waveform, the `SourceName` will be `Ch<x>`, `Math<n>` or `Ref<n>`, respectively. If the waveform is an intermediate, the `SourceName` will be `Intermediate0`, if it is the output waveform or `Intermediate<n>` if it's an input vector, where `<n>` corresponds to which argument it is. Examples of intermediates are:

- `Math1=MyAdd(Ch1, Ch2)*Ch3`: The output of `MyAdd` is an intermediate because it still needs to be multiplied by `Ch3` before being put into `Math1`. The `SourceName` for the output waveform will be `Intermediate0`.
- `Math1=MyAdd(Ch1*Ch2, Ch3)`: The first input is an intermediate because two channels are being multiplied together. Its `SourceName` will be `Intermediate1`.
- `Math1=MyAdd(Ch1, Ch2/Ch3)`: The second input is an intermediate because two channels are being divided. Its `SourceName` will be `Intermediate2`.

`INormalizedVector` is the basic waveform type used by TekScope. The length of the vector is found in the `Count` member of the class. Array indices are used to access values inside the vector:

```
INormalizedVector output;
```

```
INormalizedVector input1;
```

```
for (long i = 0; i < input1.Count; i++)
```

```
    output[i] = input1[i];
```

`IFastFrame` is built on top of `INormalizedVector`. An `IFastFrame` is a grouping of `INormalizedVectors`. `IFastFrames` are generated when `FastFrame` is enabled on the instrument. The number of frames is stored in the member called `FrameCount`. You can iterate through the frames by setting the `CurrentFrame` (note: frames are 1 counted so you should iterate from 1 to `FrameCount`). Once you set the `CurrentFrame`, you use the `IFastFrame` the same as an `INormalizedVector`.

```
IFastFrame output;
```

```
IFastFrame input1;
```

```
IFastFrame input2;
```

```
for (long f = 1; f <= output.FrameCount; f++)
```

```
{
```

```
    input1.CurrentFrame = f;
```

```
    input2.CurrentFrame = f;
```

```
    output.CurrentFrame = f;
```

```
for (long i = 0; i < output.Count; i++)
```

```
    output[i] = input1[i] * input2[i];
```

```
}
```

The final waveform type is `IWaveformDB` (waveform database or DPO data). This type essentially tracks hits in a visual manner. The higher the value that is stored into a point relative to the other values stored, the brighter the color will be. Unlike an `INormalizedVector` or an `IFastFrame`, the `IWaveformDB` goes both horizontally and vertically across the screen. The horizontal length is in `Horizontal.Count` and the vertical height is in `Vertical.Count`. To access a point inside the `IWaveformDB`, use double array indices where the vertical position comes before the horizontal position:

```
IWaveformDB output;
```

```
long hCount = output.Horizontal.Count;
```

```
long vCount = output.Vertical.Count;
```

```
for (long hh = 0; hh < hCount - 1; hh++)
```

```
{  
  Parallel.For(0, vCount, vv =>  
  {  
    output[vv, hh] = output[vv, hh + 1];  
  });  
}
```

If the output type of a plugin is `IWaveformDB`, when the plugin is called the output waveform is populated with the values the plugin returned the last time it was called. If this is the first time the plugin was called, all of the values inside the `IWaveformDB` will be zero (displays as clear).

The advanced user can change the vertical scale and position, as well as the horizontal scale and spacing by setting `Vertical.Scale`, `Vertical.Position`, `Horizontal.Scale`, and `Horizontal.Spacing` in the `IWaveformDB`.

IString. A plugin may use an unlimited number of `IStrings` as input. An `IString` is simply a string and is used to pass meta data or additional information into a plugin.

ISettings: scope settings. You can access information about instrument settings through ISettings. Settings for the math target, as well as the input and output waveforms, are put into the dictionary. However, if the waveform is an intermediate, no setting information is available. Examples of intermediates are:

- `MATH1=Add(Ch1*Ch2, Ch3)`: `Ch1*Ch2` is an intermediate
- `MATH1=Add(Ch1, Ch2)*Ch3`: The output of `Add` is an intermediate

To look up information in ISettings, you need to know the waveform name. For input or output waveforms, this is put into the `SourceName` field. This is either `Ch<n>`, `Math<n>`, `Ref<n>` or `Intermediate<n>` if it is a channel, math, reference, or intermediate waveform respectively. To find the name of the target math, look up `MathTarget` in ISettings (a string of the form `Math<n>` is returned).

Once you have the waveform name, you can look up the following information:

- Vertical scale (`"VScale"`)
- Vertical offset (`"VOffset"`)
- Vertical position (`"VPosition"`)
- Vertical units (`"VUnits"`)
- Horizontal scale (`"HScale"`)
- Horizontal offset (`"HOffset"`)
- Horizontal position (`"HPosition"`)
- Horizontal units (`"HUnits"`)

Additionally, the following information about the target math is available:

- LPCT
- MPCT
- HPCT
- HYSTPCT

The recommended method for looking up information is to use the `ISettings::GetNumber(string sourceName, string name, double defaultValue)` and `ISettings::GetString(string sourceName, string name, double defaultValue)` functions. For example, to get the name of the target math:

```
string mathTarget = settings.GetString("", "mathTarget", "");
```

Or to get the vertical scale for an input:

```
double scale = settings.GetNumber(!string.IsNullOrEmpty(input1.SourceName) ?
input1.SourceName : "", "vscale", double.NaN);
```

Note: Strings are not case sensitive, so `VSCALE` and `vscale` return the same information.

You can also use the array operators to look up information, but if the information is not in the dictionary you may end up with null objects:

```
string mathTarget = settings["mathTarget"];
double scale = settings["ch1.vscale"];
```

This may be useful for debug purposes however.

IRange: gating information. Currently, the `IRange` parameter will always be null. It is in place to support future features.

Plugin rules. Plugins require at least one and at most two vector inputs (either INormalizedVector or IFastFrame). If two vector inputs are used by the plugin, they both must be the same type. Additionally, plugins may take an unlimited number of IStrings as input. When using IString inputs, it is important to remember that the entire math equation, when typed into the editor, is limited to 128 characters.

Plugins can generate an INormalizedVector, IFastFrame or IWaveformDB waveform as output. If the output type is INormalizedVector, the vector input(s) must also be INormalizedVector. For IFastFrame and IWaveformDB outputs, the inputs can be INormalizedVector or IFastFrame.

If FastFrame is turned off and the plugin takes IFastFrames as input, the plugin is given IFastFrames that consist of only one frame. How the plugin behaves when FastFrame is turned on depends on the output waveform type. If the output is an INormalizedVector, which takes only INormalizedVector as input, the plugin is called once per frame and the math system handles iterating through all of the frames. If the plugin produces IFastFrame or IWaveformDB it is called once per FastFrame acquisition. When the plugin takes as input an IFastFrame, it is given all of the frames at once. If the plugin takes an INormalizedVector as input, the plugin will only see the first frame which is put into the INormalizedVector. The rest of the frames in the FastFrame are not seen by the plugin.

Table 4: Summary of valid plugin signatures and behavior

| Output Type | Vector Input Type | FastFrame Off | FastFrame On |
|-------------------|-------------------|--|--|
| INormalizedVector | INormalizedVector | Called once per acq | Called once per frame |
| IFastFrame | INormalizedVector | Called once per acq | First frame put into INormalizedVector |
| IFastFrame | IFastFrame | Called once per acq; Only contains one frame | Called once per FastFrame |
| IWaveformDB | INormalizedVector | Called once per acq | First frame put into INormalizedVector |
| IWaveformDB | IFastFrame | Called once per acq; Only contains one frame | Called once per FastFrame |

Example plugins. If the Application Developer Kit has been installed on the instrument, example plugins can be found in Microsoft Visual Studio. When you create a new project, choose Visual C#->Tektronix->Math to access the examples.

Create a plugin. To create a plugin, you need to use either one of our Visual Studio templates or create a new project using the .NET language of your choice. To create a C# plugin from scratch, you first need to create a new, empty C# project. Once you create your project, add references to ScopeSupportBase, TekScriptingEngine, System.Data, System.Data.DataSequence, System.XML and System.Xml.Linq. In your code, use System, System.Collections.Generic, System.Linq, System.Text, and Tek.Scope.Support.

There are no requirements for the name of the class or namespace the plugins use. In this example the namespace is MyMathPlugins and the class name is MyMath. The plugin function is a public, static function inside the class with the math attribute. We call our plugin Add, and it takes two INormalizedVectors as input and produces an INormalizedVector.

```
namespace MyMathPlugins
{
    class MyMath
    {
        // Add(<wfm>, <wfm>):
        // This plugin adds two INormalizedVector inputs
        [Math]
        public static void Add(ISettings settings, IRange gate, INormalizedVector output, INormalizedVector input1,
INormalizedVector input2)
        {
            // We only want to add up to the shorter input length
            if (input1.Count < input2.Count)
            {
                output.Count = input1.Count;
                output.Horizontal.Spacing = input1.Horizontal.Spacing;
                output.Horizontal.ZeroIndex = input1.Horizontal.ZeroIndex;
            }
            else
            {
                output.Count = input2.Count;
                output.Horizontal.Spacing = input2.Horizontal.Spacing;
                output.Horizontal.ZeroIndex = input2.Horizontal.ZeroIndex;
            }
            // Add two inputs together
            for (long i = 0; i < output.Count; i++)
                output[i] = input1[i] + input2[i];
        }
    }
}
```

When compiling the project, make sure the target platform is Any CPU. Once the DLL is compiled (release or debug, both work), it should be placed in the appropriate directory on the instrument. Restart the instrument application, and the plugin is ready to use like any existing math operator.

MATLAB custom functions

The Custom Analysis Interface for use with MATLAB provides two options for writing MATLAB custom analysis functions: a basic function interface and a more advanced class-based interface. Both types are available in demo form on the instrument in C:\Users\Public\Tektronix\Plugins\Math\MATLAB.

Using the basic Function interface to create MATLAB functions. The function interface uses a simple signature: `function [output] = exampleProcessingFunction(firstTime, varargin)`. Your function should take two inputs: a Boolean that indicates whether or not this is the first time the function has been called and a variable length array. Put the results that you want the instrument to display into the output variable of the same length as the input array.

If this is the first time the function has been called as part of the math expression, `firstTime` is true. In this case, the `varargin` array consists of the record length and the sample rate:

```
recordLength = varargin{1}; sampleRate = varargin{2}; and the output is expected to be true: output = true;
```

If you have any one time processing, such as filter creation, do this when `firstTime` is true. If you want to have variables from a previous execution of the function available, you should mark the variables persistent. See the examples for more information. Note that persistent variables are automatically cleared before the first execution of the function.

If this is not the first time the function has been called, then `firstTime` is false and `varargin` will consist of the waveform inputs. The math expression may have one or two waveform inputs to the MATLAB function:

```
input1 = varargin{1}; if numel(varargin) == 2    input2 = varargin{2}; end
```

From here you can do any computations you want and put the results into the output. Your MATLAB function can use any features available in MATLAB or installed toolboxes to perform its calculations. Note that the output must have the same length as the inputs. If your output vector is shorter, zero out the remaining points.

Using a Class to create MATLAB functions. An advanced user can create a MATLAB custom analysis function by subclassing `instrument.integration.AlgorithmDefinition`. The `waterfall.m` class shows an example of this type of custom analysis function. This is more complex than using a function but allows more control of behavior than the basic function capability. By using a subclass, you can implement custom tear-down behaviors, such as closing plots automatically when an analysis function is no longer being called.

Your class should be a subclass of `instrument.integration.AlgorithmDefinition`:

```
classdef myClass < instrument.integration.AlgorithmDefinition
```

There are four methods your class may need to implement: a constructor, a destructor, a process, and a `stopProcessingHook`. The default destructor and `stopProcessingHook` from the superclass may be sufficient for your class. However, at minimum you need to implement a constructor and the process function:

```
classdef myClass < instrument.integration.AlgorithmDefinition
    methods
    function obj = myClass(sampleRate,pointsPerRecord)
    obj@instrument.integration.AlgorithmDefinition(sampleRate,pointsPerRecord);
    end
    function [result] = process(obj,varargin)
        result = varargin{1};
    end
    end
end
```

The constructor is called the first time the analysis function is used in a specific math expression on the instrument. Here anything that requires setup before processing data, such as plots, should be configured. The parent constructor can be called from your custom construct if necessary (the constructor for `AlgorithmDefinition` sets up some basic settings information about the instrument).

The process function is the main workhorse of the class. This function computes results and returns data to the instrument. Like the custom analysis functions created using the basic function interface, the length of the results returned by your process function should match the length of the input.

The `stopProcessingHook` function is called when the analysis function is no longer in use by the instrument. This may happen when you edit or clear a math function, or in other situations when the instrument math system expects that the state should be reset. For example, if your analysis function is displaying a plot, this would be the time to close the plot.

Finally, the destructor is called when the analysis function is no longer in use. Typically you call the `stopProcessingHook` function from here to aid in cleanup.

Spectral math waveforms

The math capabilities of the instrument include waveform spectral analysis. This section describes how you can control the analysis intuitively with time domain and frequency domain controls. These controls merge the time domain controls with the frequency domain controls to provide a complete spectral analyzer.

Signals may be represented by their characteristics in both the time and the frequency domain. By combining and transforming source waveforms into spectral math waveforms, you can simultaneously view signal characteristics in both domains.

This spectral analyzer provides a complete set of controls and features that allow you to make time and frequency domain measurements without the need to learn extensive details about FFT algorithms.

- **Frequency Domain Controls.** Use traditional spectrum analyzer controls to set the center frequency, span, and resolution bandwidth directly.
- **Time Domain Controls.** The time domain controls for the acquired waveform set the time duration and the resolution (time between samples). You can easily set the required sample rate and record length.
- **Gating Controls.** These controls are the bridge that connects the time domain to the frequency domain. You can perform spectral analysis on a gated region of the input waveform. This gating also determines the resolution bandwidth.
- **Window Functions.** Eight different window functions are available to shape the filter response.
- **Magnitude Versus Frequency.** Displays log data in dB, dBm, or linear mode. You can display the real or imaginary parts of the spectral magnitude only. Reference level offset and reference level controls give complete control over the vertical position and offset of the spectrum.
- **Phase Versus Frequency.** Displays phase data as a function of frequency in radians or degrees. You may zero the noise phase for magnitudes below a threshold level. Finally, you may select Phase unwrap and dq/dw, group delay.
- **Spectral Averaging.** You can turn on averaging in the frequency domain for phase and magnitude waveforms.
- **Multiple Analyzer Control Locks.** Up to four spectral analyzers can be used simultaneously. They can all be assigned to different gates on the same source waveform or to different channel sources. The controls of Math1 and Math2 can be locked, and the controls of Math3 and Math4 can be locked. When controls are locked, turning a control on one analyzer changes the control on the other analyzer to the same value. Other combinations of locking, including all four analyzers, are available using GPIB commands.

The same exclusions for math waveforms apply to spectral math waveforms. In addition, sources for spectral math waveforms must be channel waveforms.

What do you want to do next?

[Learn about using the spectral math controls.](#)

[Go to a step-by-step procedure for creating a spectral math waveform.](#)

Spectral math controls

The spectral analyzer contains five primary control categories. These are shown in the table below.

Click one of the links for more information on using each type of control.

| <i>Time controls</i> | <i>Gate controls</i> | <i>Frequency controls</i> | <i>Magnitude controls</i> | <i>Phase controls</i> |
|-------------------------|----------------------|---------------------------|--------------------------------|-------------------------------|
| Source | Position | Center | dB, dBm linear, real imaginary | degrees, radians, group delay |
| Duration, record length | Duration | Span | Ref level | Zero threshold |
| Duration, sample rate | Window | Resolution bandwidth | Ref level offset | Phase Unwrap |
| Resolution | | | | |

What do you want to do next?

[Learn about using spectral analyzer windows.](#)

[Learn how to recognize aliasing.](#)

[Go to a step-by-step procedure for defining a spectral math waveform.](#)

Spectral math time controls

The operation of the time domain controls for the spectral analyzer is summarized by the following rules:

- Duration selects the time from the beginning to the end of the acquired waveform. You may set duration using the record length control or the sample rate control.
- Resolution determines the time between samples. Duration is kept constant as resolution is changed. Therefore, the Resolution control affects both the sample rate and the record length simultaneously.
- Most often, you will want to use a short record length because long record lengths can slow instrument response. However, long record lengths lower the noise relative to the signal and increase the frequency resolution for the spectral math waveform. More importantly, they might be needed to capture the waveform feature that you want to include in the waveform.

Examples of how duration and resolution affect the acquired waveform are shown in the next figure.

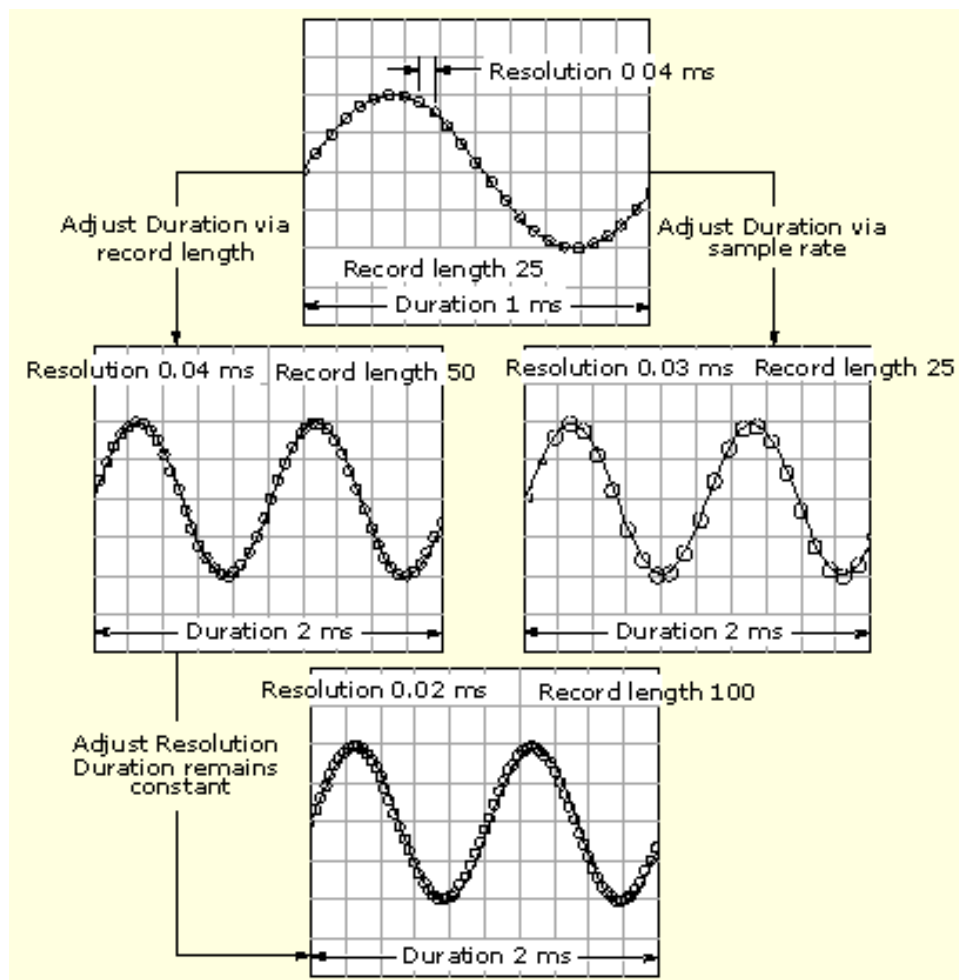

What do you want to do next?

[Go to a list of all spectral math controls.](#)

[Learn more about spectral math controls.](#)

[Go to a step-by-step procedure for defining a spectral math waveform.](#)

Spectral math gating controls

Gating determines which portion of the acquired waveform is transformed into the frequency domain. The gate has a position and a width control.

The gate position is the time in seconds from the trigger location to the center 50% position of the gate interval (see the next figure). The position and width units are seconds.

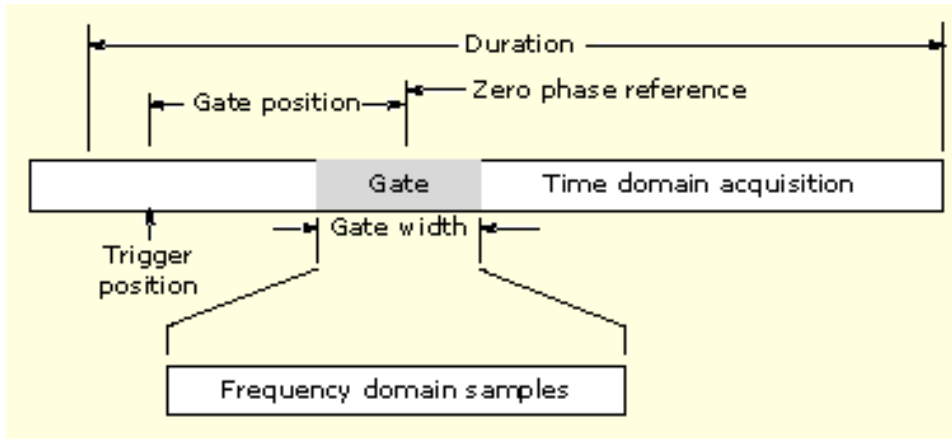

The gate must reside within the duration interval of the source waveform. If the source waveform duration is adjusted, and the gate position and width would result in the gate being outside of that duration, then the gate position or width is set within the limits.

The width of the gate affects the resolution bandwidth of the spectral analyzer. Gate width has units of seconds. The resolution bandwidth directly controls the gate width, but the numerical value is entered in units of hertz. Therefore, the time domain gate markers move as you adjust the resolution bandwidth control.

The data contained in the gated region is transformed into the frequency domain.

The gate is identified on the display using dashed markers (similar to cursors). The default gate width setting is equal to the duration of the source waveform.

What do you want to do next?

[Go to a list of all spectral math controls.](#)

[Learn more about spectral math controls.](#)

[Go to a step-by-step procedure for defining a spectral math waveform.](#)

Spectral math frequency domain controls

The gated region of the source waveform is transformed into a spectral phase or magnitude waveform. The horizontal units are always hertz. The vertical units depend on whether phase or magnitude is selected. The frequency domain controls for the spectral waveform are span, center, and resolution bandwidth. The spectrum normally appears on the display fit to a screen width of 10 divisions.

Span

Span is the frequency at the end of the spectral waveform minus the frequency at the beginning of the waveform. The span control maximum value is equal to the current sample rate divided by two. Therefore, if you are unable to increase the span to the desired value and if you want to keep the same source waveform duration, go to the time base controls and increase the sample rate using the resolution control. Or, if you want to also decrease the source waveform duration, adjust the sample rate control. If you decrease the sample rate, the span setting may decrease, if necessary, to keep the span less than the sample rate divided by two.

Center

This is the frequency at the center of the spectral waveform. Center is equal to the start frequency plus one half of the span. The adjustment range depends on the sample rate and the current span setting. Remember that the span must always be in the interval of zero to one half of the sample rate. Therefore, if the span is set to full, the center frequency control will not have any adjustment range and will remain at one half of the sample rate. It is necessary to decrease the span before the center will have an adjustment range. If you are unable to increase the center to the desired value, increase the sample rate using either the sample rate or resolution controls. You may also change sample rate by using the HORIZONTAL SCALE knob on the instrument front panel.

Resolution bandwidth (RBW)

This is the 3 dB down bandwidth of the spectral analyzer frequency response to a sine wave input. The resolution bandwidth is affected by two parameters:

- Different window functions produce different filter response shapes in the spectrum and result in different resolution bandwidths.
- The gate width of the input data affects the RBW because the RBW is inversely proportional to the gate width. So, adjusting the gate width changes the RBW. Gate width has units of seconds. The RBW directly controls the gate width, but the numerical value is entered in units of hertz. Therefore, the time domain gate markers move as you adjust the RBW control.

The next figure demonstrates the effects of adjusting the center frequency and span. Center frequency is a horizontal position control for the spectrum. Span is a horizontal scale control. Resolution bandwidth adjusts the bandwidth of the analyzer filters without affecting the span and center frequency.

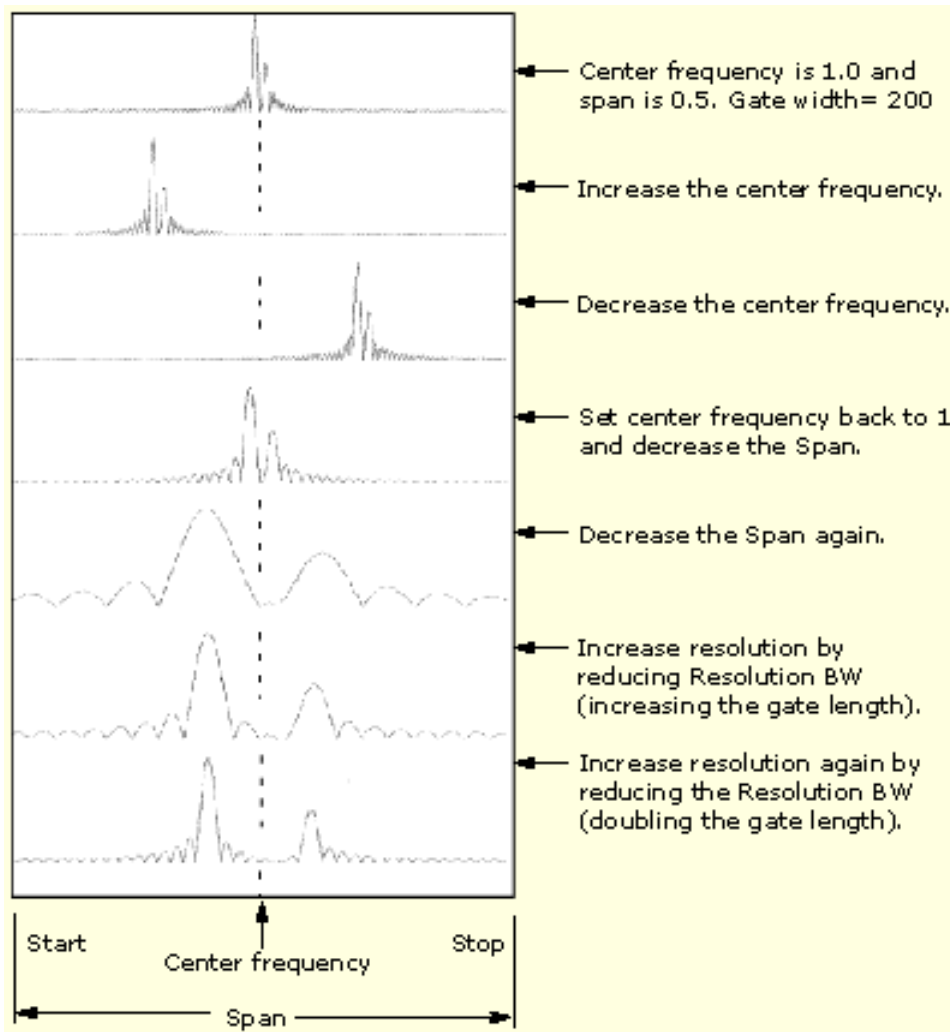

What do you want to do next?

[Go to a list of all spectral math controls.](#)

[Learn more about spectral math controls.](#)

[Go to a step-by-step procedure for defining a spectral math waveform.](#)

Spectral math magnitude controls

Vertical units can be either linear or log. You can select from the following choices by clicking the Math menu button. Then select the Spectral Analysis Setup command.

Mag tab

Select the desired scale type, Linear, dB, or dBm:

- **Linear.** When the spectrum is linear magnitude the vertical units are the same as the source waveform. Usually this is volts. However, it may also be watts or amperes.
- **dB.** This sets the vertical scale of the magnitude spectrum to dB. Use the Reference Level Offset to set which vertical position in the magnitude spectrum will be zero dB. The following equation applies:

$$\text{dB} = 20 \log (|X| - \text{Ref})$$

Where **X** is a complex data point in the spectrum and **Ref** is the Reference Level Offset value.

- **dBm.** This selects dB as described in the above equation, but also sets the Reference Level Offset to a value that is equivalent to 1 mW of power into 50 ohms. Therefore, if the input units are volts, then the value is set to 223.6 mV. If the input units are amperes, then the value is set to 40 mA. If the input units are watts, then the value is set to 1 mW.

Reference level

| Reference level | |
|-----------------|--|
| | <p>This sets the vertical position of the displayed spectrum. Its value is the magnitude at the top of the display screen. When this control is adjusted, the spectral waveform along with its zero reference marker move vertically on the screen as shown. This control does not change the spectral data.</p> |

Reference level offset

| Reference level offset | |
|------------------------|---|
| | <p>This changes the value of Ref in the equation for dB shown above. Unlike the Reference Level control, this control actually changes the output data values in the spectrum. Zero dB is shown on the display screen by the marker associated with the spectral waveform. Adjusting the Reference Level Offset causes the spectral waveform to move vertically with respect to the waveform reference marker as shown. This moves the waveform without changing the Reference Level control setting. Sometimes it is beneficial to adjust this control so that the peak of a fundamental is at zero dB. Then you can measure other harmonics in terms of how many dB they are away from the fundamental. Click the dBm button to preset this level to the equivalent of 1 mW into 50 ohms.</p> |

Real and imaginary magnitudes

You can display the linear magnitude of the real data or the imaginary data in the spectrum. This is useful if you process the spectrum off line and transform it back into a time domain trace. You can save the real and the imaginary spectrum into reference memory, and export the waveforms directly into Mathcad, MATLAB, or Excel documents to update in real time.

To turn on a real or imaginary spectrum, click the Math menu button, select Define/Edit Expression Editor, and select the Freq tab. Click either the Real or the Imag buttons and enter an expression. Click the appropriate channel button, and click Apply.

What do you want to do next?

[Go to a list of all spectral math controls.](#)

[Learn more about spectral math controls.](#)

[Go to a step-by-step procedure for defining a spectral math waveform.](#)

Spectral math phase controls

Select the phase controls

You can set the vertical units to Degrees, Radians, or Group Delay in seconds. To do this, click the Math toolbar button, click Spectral Analysis Setup, and select the Phase tab. Then select the desired scale type from Degrees, Radians, or Group Delay.

Phase reference position

Phase is a relative measurement that must have a time domain reference point. The phase value is specified with respect to this phase reference position.

For the spectral analyzer, the phase reference position is the 50% position of the gate, that is, the middle of the gate interval of the data that is input to the spectral analyzer. This is true for all window functions except for the Tek Exponential window. This window has a reference point at the 20% position of the gate.

Phase unwrap

The spectral analyzer produces phase values from $-\pi$ to $+\pi$ radians or -180 to 180 degrees. However, when you perform impulse response testing and the phase is continuous, then phase values outside these ranges may occur. The spectral analyzer then wraps the data with discontinuities in the display from $+180$ to -180 degrees. Phase unwrap will display the correct result by unwrapping the phase.

Phase unwrap is only valid when the phase spectrum is a continuous function of frequency. Therefore, do not use it when analyzing the harmonic content of the typical repetitive signal.

Suppression threshold

Random noise in the spectrum may have phase values over the entire range. This could make the phase display unusable. However, you can set the suppression threshold control to a level in dB. The phase of any complex spectral points with a magnitude below this threshold is set to zero. See the next figure for an example.

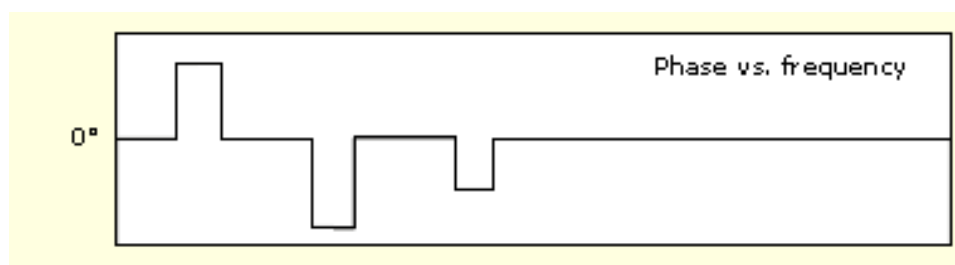
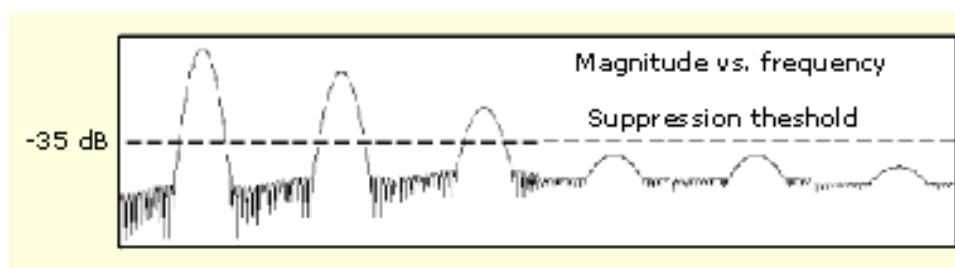

Group delay

When the phase spectrum is a continuous function of frequency, group delay may be computed. This is true of impulse response testing where an impulse is fed into the system, and the spectrum of the response of the system output is computed.

Group delay measures how well a system passes a signal in terms of phase distortion. Group delay is the derivative of the phase with respect to frequency.

This feature is not useful for analysis of harmonic content of signals where the phase response is not continuous.

Impulse response testing

When performing impulse response testing of a system, place the impulse at the zero-phase reference position of the acquisition. This produces a correct phase display. Because the Tek Exponential window has its zero phase reference position at the 20% point, more of the impulse response is captured. All other window functions have their phase reference position at the 50% position in the gated region.

There are several ways to adjust the position of the zero phase reference point with respect to your input signal:

- Adjust the spectral analyzer gate position
- Perform fine adjustment using the front-panel trigger level control
- Adjust the front-panel horizontal Position control

Spectral analyzer windows

In the time domain, a window is a bell-shaped function equal in length to the gate duration.

For most windows, this function tapers to zero at both ends of the gate region. Before computation of the spectral transformation, the window is multiplied, sample by sample, times the input data in the gated region. The window function affects the shape of the spectral analyzer response in the frequency domain.

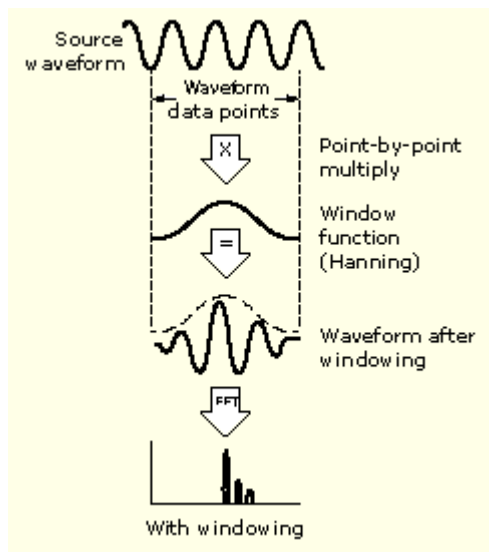

The window functions affect the ability to resolve frequency in the output spectrum and can affect the accuracy of the magnitude and phase measurements. The previous figure shows how the time domain record is processed.

Accurate magnitude measurements require that the input source waveform be stationary within the gated region. This means that waveform parameters, such as frequency and amplitude, should not change significantly as a function of time within the gate region that is input to the spectral analyzer. Also, the gate width must be greater than or equal to the period of the start frequency of the span of the spectral analyzer. That is, there must be at least one cycle of the harmonic being measured within the gated region.

There are eight different spectral analyzer windows:

- *Rectangular*
- *Gaussian*
- *Hamming*
- *Blackman-Harris*
- *Hanning*
- *Flattop2*
- *Kaiser-Bessel*
- *Tek Exponential*

Your choice of window function will depend on the input source characteristics that you want to observe and the characteristics of the window function. The window characteristics are shown in the following table.

| Window | 3 dB BW in bins | Scallop loss | Nearest side lobe | Zero phase reference | Coefficients |
|-----------------|-----------------|--------------|-------------------|----------------------|--|
| Rectangular | 0.89 | 3.96 dB | -13 dB | 50% | 1.0 |
| Hamming | 1.3 | 1.78 dB | -43 dB | 50% | 0.543478, 0.456522 |
| Hanning | 1.44 | 1.42 dB | -32 dB | 50% | 0.5, 0.5 |
| Kaiser-Bessel | 1.72 | 1.02 dB | -69 dB | 50% | 0.40243, 0.49804, 0.09831, 0.00122 |
| Blackman-Harris | 1.92 | 0.81 dB | -92 dB | 50% | 0.35875, 0.48829, 0.14128, 0.01168 |
| Gaussian | 2.0 | 0.76 dB | -79 dB | 50% | a = 3.75 (not cosine series) |
| Flattop2 | 3.8 | 0.0065 dB | -90 dB | 50% | 0.213348, -0.206985, 0.139512, -0.043084, 0.003745 |
| Tek Exponential | 1.42 | 0.60 dB | -67 dB | 20% | not applicable |

3 dB BW in bins

This is the bandwidth in units of bins, which are the intervals between spectral output samples when no zero fill is used. The bandwidth is measured between the points on the lobe that are 3 dB down from the peak of the lobe. The bandwidth in hertz may be computed by dividing the BW in bins by the gate duration in seconds. This is also referred to as resolution bandwidth (RBW).

Coherent gain

The gain factor normally associated with different window functions is correctly scaled into the magnitude spectrum output. Therefore, the magnitudes in the output spectrum do not change as different windows are selected.

Scallop loss

This is the magnitude error of the spectral analyzer when the frequency of the observed signal is exactly half way between two frequency samples of the spectrum when the interpolation ratio due to zero fill of the FFT is one. When zero fill is in effect, scallop loss is essentially eliminated because of the interpolation in the frequency domain due to zero fill. If you work with span settings less than full and you work with larger resolution bandwidth settings, zero fill is in effect most of the time.

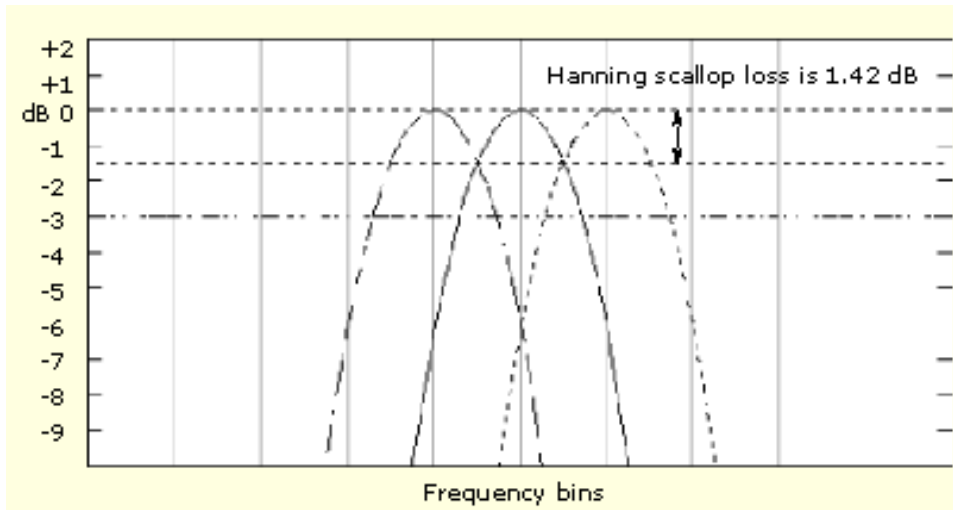

Nearest side lobe

This is the difference in magnitude between the spectral lobe peak in the spectrum and the next side lobe that occurs due to energy leakage. Different windows have different leakage characteristics. The more narrow the resolution bandwidth of the window the more leakage in the spectrum.

Zero phase reference

This is the position in the time domain gate that is the reference point for phase in the output spectrum. That is, if a sine wave input has its peak at the zero phase reference position, then it reads out as zero phase in the spectrum. If the phase is to be correct when doing impulse response testing, the impulse in the time domain must be located at this position in the gate interval.

Coefficients

These are used to generate the windows that are constructed from a cosine series. For the Gaussian window, the value of "a" is given instead of a set of coefficients. You can find descriptions of cosine series windows in the *Handbook of Digital Signal Processing Engineering Applications* by Elliot. ISBN 0-12-237075-9.

What do you want to do next?

[Go to a list of all spectral math controls.](#)

[Learn about using spectral analyzer windows.](#)

[Go to a step-by-step procedure for defining a spectral math waveform.](#)

Spectral analyzer window types

In the time domain, a window is a bell-shaped function equal in length to the gate duration.

For most windows, this function tapers to zero at both ends of the gate region. Before computation of the spectral transformation, the window is multiplied, sample by sample, times the input data in the gated region. The window function affects the shape of the spectral analyzer response in the frequency domain.

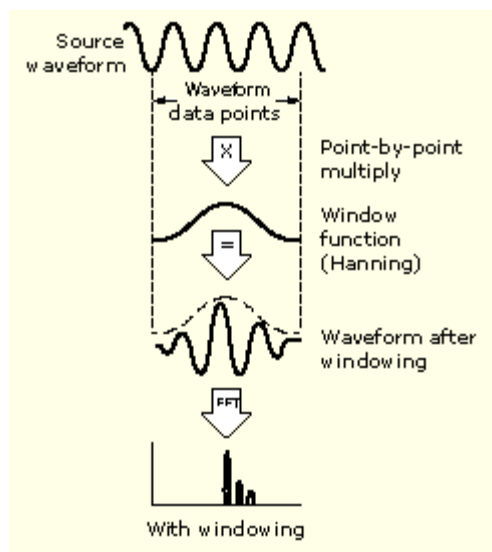

The window functions affect the ability to resolve frequency in the output spectrum and can affect the accuracy of the magnitude and phase measurements. The previous figure shows how the time domain record is processed.

Accurate magnitude measurements require that the input source waveform be stationary within the gated region. This means that waveform parameters, such as frequency and amplitude, should not change significantly as a function of time within the gate region that is input to the spectral analyzer. Also, the gate width must be greater than or equal to the period of the start frequency of the span of the spectral analyzer. That is, there must be at least one cycle of the harmonic being measured within the gated region.

There are eight different spectral analyzer windows:

- *Rectangular*
- *Gaussian*
- *Hamming*
- *Blackman-Harris*
- *Hanning*
- *Flattop2*
- *Kaiser-Bessel*
- *Tek Exponential*

Your choice of window function will depend on the input source characteristics that you want to observe and the characteristics of the window function. The window characteristics are shown in the following table.

| Window | 3 dB BW in bins | Scallop loss | Nearest side lobe | Zero phase reference | Coefficients |
|-----------------|-----------------|--------------|-------------------|----------------------|--|
| Rectangular | 0.89 | 3.96 dB | -13 dB | 50% | 1.0 |
| Hamming | 1.3 | 1.78 dB | -43 dB | 50% | 0.543478, 0.456522 |
| Hanning | 1.44 | 1.42 dB | -32 dB | 50% | 0.5, 0.5 |
| Kaiser-Bessel | 1.72 | 1.02 dB | -69 dB | 50% | 0.40243, 0.49804, 0.09831, 0.00122 |
| Blackman-Harris | 1.92 | 0.81 dB | -92 dB | 50% | 0.35875, 0.48829, 0.14128, 0.01168 |
| Gaussian | 2.0 | 0.76 dB | -79 dB | 50% | a = 3.75 (not cosine series) |
| Flattop2 | 3.8 | 0.0065 dB | -90 dB | 50% | 0.213348, -0.206985, 0.139512, -0.043084, 0.003745 |
| Tek Exponential | 1.42 | 0.60 dB | -67 dB | 20% | not applicable |

3 dB BW in bins

This is the bandwidth in units of bins, which are the intervals between spectral output samples when no zero fill is used. The bandwidth is measured between the points on the lobe that are 3 dB down from the peak of the lobe. The bandwidth in hertz may be computed by dividing the BW in bins by the gate duration in seconds. This is also referred to as resolution bandwidth (RBW).

Coherent gain

The gain factor normally associated with different window functions is correctly scaled into the magnitude spectrum output. Therefore, the magnitudes in the output spectrum do not change as different windows are selected.

Scallop loss

This is the magnitude error of the spectral analyzer when the frequency of the observed signal is exactly half way between two frequency samples of the spectrum when the interpolation ratio due to zero fill of the FFT is one. When zero fill is in effect, scallop loss is essentially eliminated because of the interpolation in the frequency domain due to zero fill. If you work with span settings less than full and you work with larger resolution bandwidth settings, zero fill is in effect most of the time.

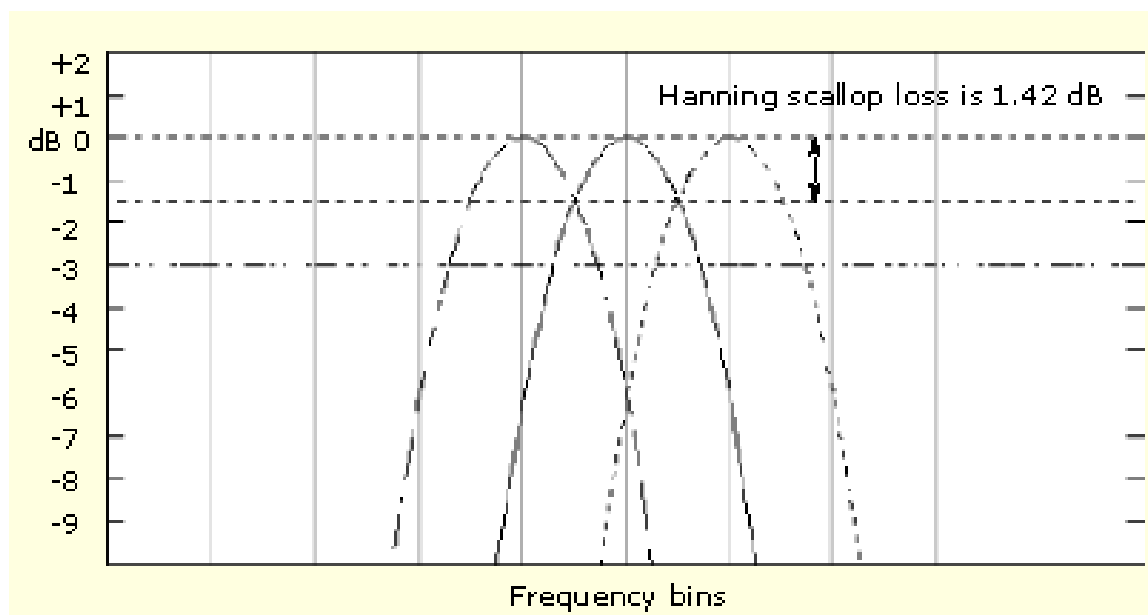

Nearest side lobe

This is the difference in magnitude between the spectral lobe peak in the spectrum and the next side lobe that occurs due to energy leakage. Different windows have different leakage characteristics. The more narrow the resolution bandwidth of the window the more leakage in the spectrum.

Zero phase reference

This is the position in the time domain gate that is the reference point for phase in the output spectrum. That is, if a sine wave input has its peak at the zero phase reference position, then it reads out as zero phase in the spectrum. If the phase is to be correct when doing impulse response testing, the impulse in the time domain must be located at this position in the gate interval.

Coefficients

These are used to generate the windows that are constructed from a cosine series. For the Gaussian window, the value of "a" is given instead of a set of coefficients. You can find descriptions of cosine series windows in the *Handbook of Digital Signal Processing Engineering Applications* by Elliot. ISBN 0-12-237075-9.

What do you want to do next?

[Learn about recognizing aliasing.](#)

Flattop2 window

This window has the lowest scallop loss of any of the windows. It also has a wider resolution bandwidth but lower side lobe attenuation. Also, it is unique because the time domain shape has negative values.

NOTE. The Flattop2 window is useful for high accuracy magnitude measurements for signals that do not require very narrow bandwidth.

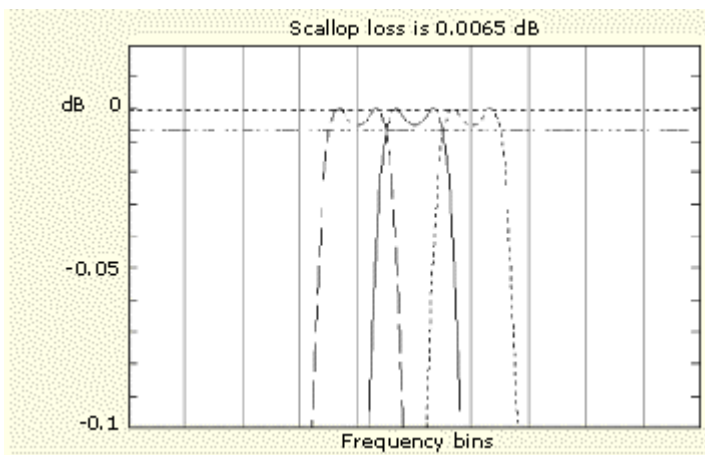
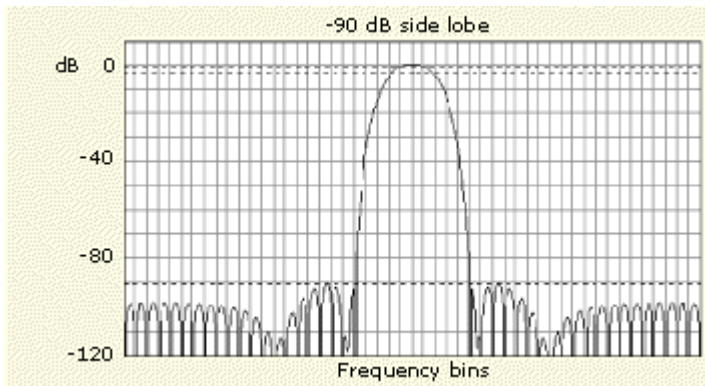
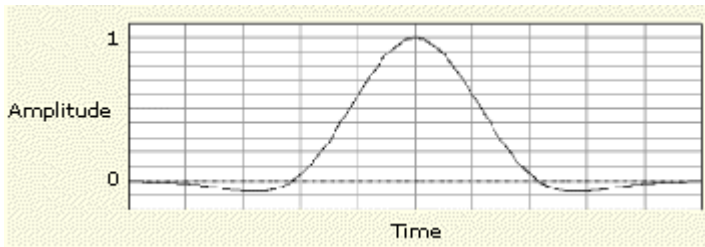

What do you want to do next?

[Learn about using spectral analyzer windows.](#)

Gaussian window

This is the default window function (see the next figure). It is unique in that the time-domain shape of an exponential Gaussian function transforms into a Gaussian exponential shape in the frequency domain.

NOTE. This window provides optimal localization in both the time and the frequency domain

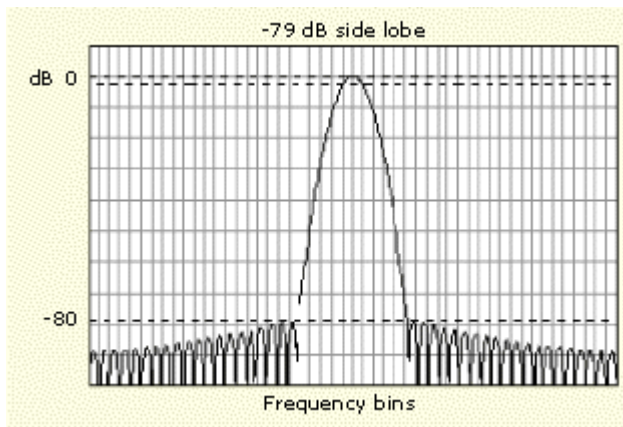
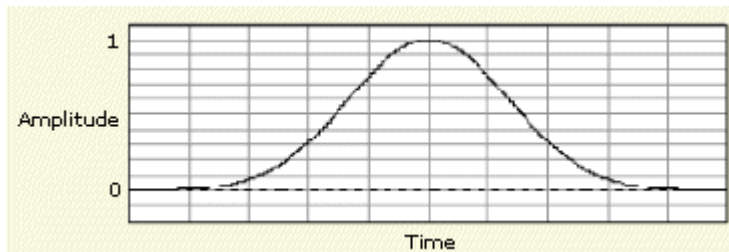

What do you want to do next?

[Learn about using spectral analyzer windows.](#)

Hamming window

This window is unique in that the time domain shape does not taper all the way to zero at the ends. This makes it a good choice if you wanted to process the real and imaginary parts of the spectrum off line and inverse transform it back to the time domain. Because the data does not taper to zero, you can remove the effect of the window function from the result.

What do you want to do next?

[Learn about using spectral analyzer windows.](#)

Hanning Kaiser-Bessel and Blackman-Harris windows

These windows have various resolution bandwidths and scallop losses (see the figures below). Choose the one that best allows you to view the signal characteristics you are interested in.

NOTE. The Blackman-Harris window has a low amount of energy leakage compared to the other windows. The Hanning window has the narrowest resolution bandwidth, but higher side lobes.

Hanning window

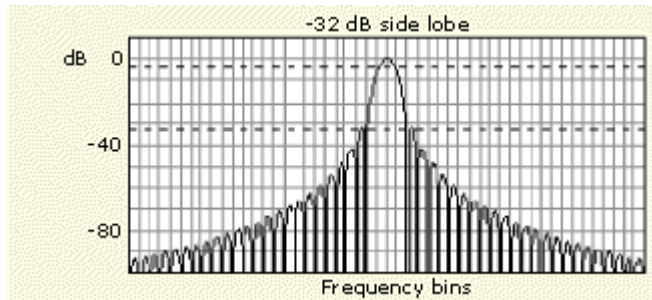
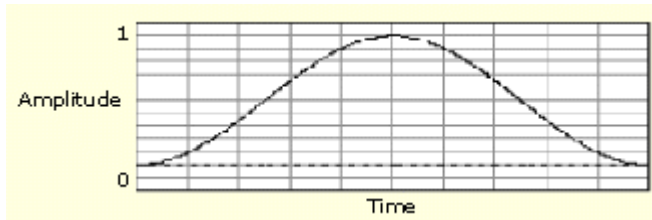

Kaiser-Bessel window

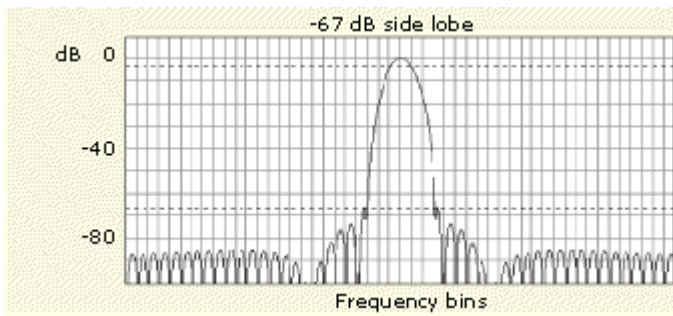
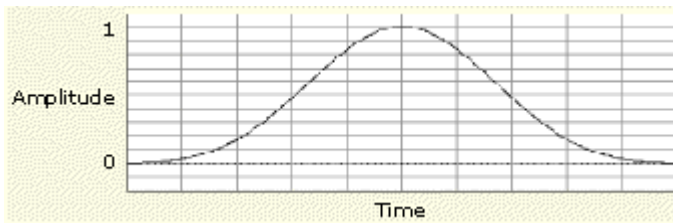

Blackman-Harris window

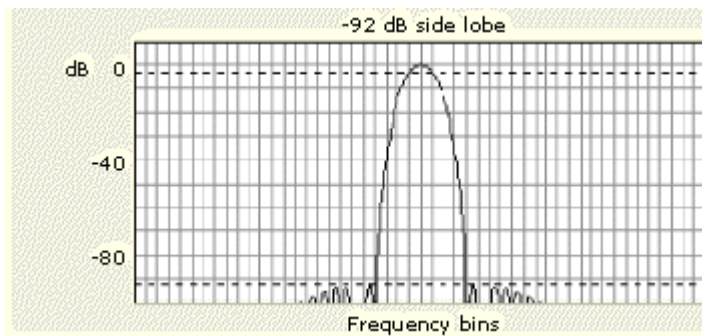
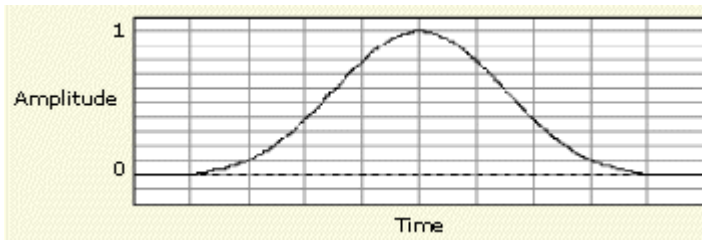

What do you want to do next?

[Learn about using spectral analyzer windows.](#)

Rectangular window

This window is equal to unity (see the next figure). This means the data samples in the gate are not modified before input to the spectral analyzer. Rectangular windows are best for measuring transients or bursts where the signal levels before and after the event are nearly equal.

NOTE. This window has the narrowest resolution bandwidth of any of the windows, but it also has the most spectral leakage and the highest side lobes.

What do you want to do next?

[Learn about using spectral analyzer windows.](#)

Tek-Exponential window

In the time domain, it is not a symmetrical bell shape as is the case with the other windows. Instead, it is exponential with a peak at the 20% position of the time domain gate. The frequency domain shape is triangular.

NOTE. Use this window for impulse-response testing where the 20% position is the zero phase reference point. More of the acquired data record length is used to capture the impulse response.

Exact details of how to compute its values were published in the article; *Impulse-Response Testing Lets a Single Test Do the Work of Thousands*, by John Pickerd, EDN magazine, April 27, 1995.

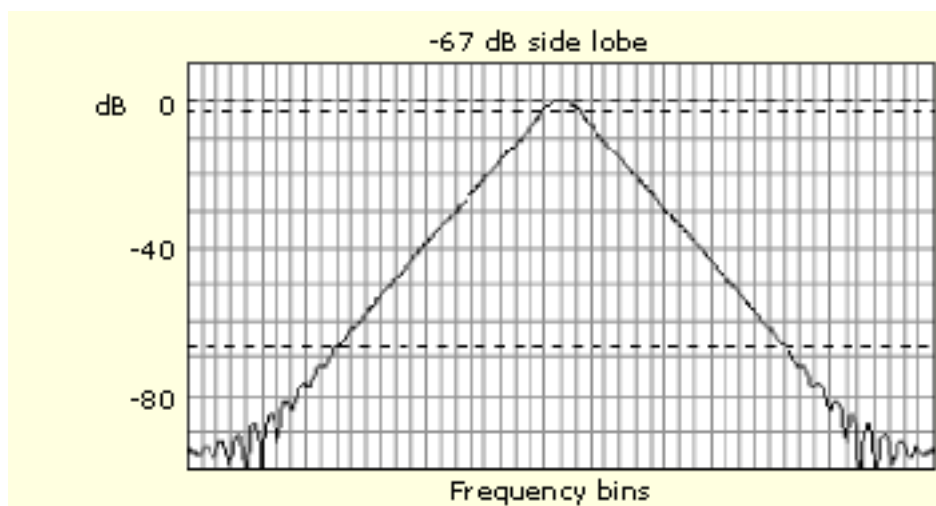
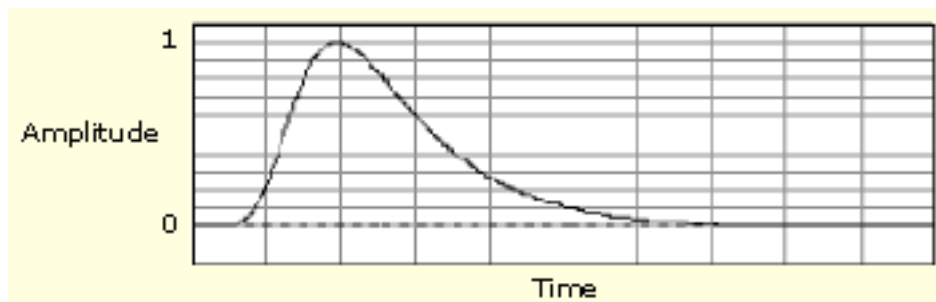

What do you want to do next?

[Learn about using spectral analyzer windows.](#)

Recognizing aliasing

Aliasing occurs when the input frequency of a signal is greater than one half of the sampling frequency (the sample rate).

Set the sample rate high enough so that the signals in the spectrum appear at their correct frequency as opposed to a lower aliased frequency value. Also, complex signal shapes that have many harmonics in them, such as a triangle or square wave, can appear to be OK in the time domain when in fact many of the harmonics in that signal are aliased.

One way to check for aliasing is to increase the sample rate and observe whether any of the harmonics unwrap to different frequency locations.

Another way to recognize aliasing is to realize that higher order harmonics usually have decreasing magnitudes compared to lower order harmonics. Thus, if you see a series of increasing harmonic magnitude values as frequency increases then you can suspect that they may be aliased. In the spectral math waveform, the actual higher frequency components are under sampled, and therefore they appear as lower frequency aliases that "fold back" around the Nyquist point. (See the next figure.) You may test by increasing the sample rate and observing if aliases unwrap to different frequency positions.

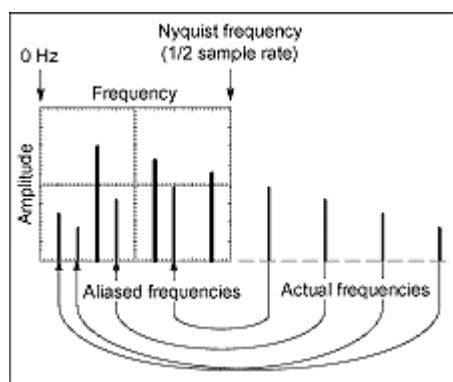

If you have a variable-frequency signal source, another way to observe aliasing is to adjust the frequency slowly while watching the spectral display. If some of the harmonics are aliased, you will see the harmonics decreasing in frequency when they should be increasing or vice versa.

Once you have displayed a spectral math waveform, use cursors to measure its frequency amplitude or phase angle. See [Setting Cursor Sources](#) for detailed steps.

You can use automated measurements to measure spectral math waveforms. See [Taking Automatic Measurements](#) for step-by-step instructions.

What do you want to do next?

[Learn about horizontal setup.](#)

Mask testing

Mask key points

There are a number of mask test key points to be aware of prior to using, editing, or creating a mask.

Mask testing. Only one mask standard is active at any one time. If you have one mask selected or enabled and then select a new mask, the new mask replaces the previous mask. You cannot test to multiple standards simultaneously.

Autofit and persistence interaction. The Autofit function moves the waveform vertically and horizontally in a mask to reduce the number of segment hits within a mask. If persistence is set to infinite or variable, each Autofit waveform movement clears existing persistence data. If Autofit makes frequent waveform movements, there may be little or no displayed waveform persistence data.

Segments and mask hits. Each mask can have a maximum of 16 segments. Segments can overlap. The number of mask hits is the sum of all hits in all segments, regardless of whether or not segments overlap. For example, if a waveform crosses over an area where two segments overlap, both segments will count the waveform hit.

Vertices. Each segment can have a maximum of 50 vertices. Vertices are numbered counterclockwise, with vertex one generally located at the bottom left of each segment. The active (selected) vertex is indicated by an X. The instrument automatically assigns numbers to vertices during mask creation or editing.

Mask margin tolerance. Mask margin tolerance moves the mask segment boundaries by the specified percentage. Negative margins reduce the size of the segment, making it easier to pass a mask test. Positive numbers make it harder to pass and allow you to perform margin testing on your design. If a user defined mask has more than three segments, turning on mask margins generates an error message. Turning mask margin tolerance off redraws the mask segment margins to their default values, but leaves the numeric value as it is, allowing you to quickly toggle between default and user-set margin values.

Standards and bandwidth. When the instrument system bandwidth (which includes the instrument, attached probes, and/or cabling) falls into the range of 1.5 to 1.8 (0.8 for optical signals) times the data signal bit rate, the third harmonic of the data signal is significantly attenuated. The instrument displays useful qualitative information, but quantitative rise-time measurements under these conditions may not be accurate.

For example, a FC531E Elec mask has a bit rate of 531.25 Mb/s; 1.5 to 1.8 times this value is a range of 796.5 MHzBW to 955.8 MHzBW. Therefore, you should not use an instrument with less than 1 GHz measurement system for making quantitative rise-time measurements of this standard.

When just the instrument bandwidth falls within 1.5–1.8 (0.8 for optical signals) times the bit rate of a selected mask standard, the instrument displays the message "Consider system bandwidth when testing at this bit rate." in the status area above the graticule.

What do you want to do next?

[Learn more about eye measurements.](#)

[Learn about communication triggering.](#)

[Go to mask testing setup overview.](#)

Serial mask testing with mask testing

The [Serial Mask Testing option](#) provides electrical mask testing on communication standards and communication triggering.

Mask testing consists of two tasks: signal violation detection and pass/fail testing. Signal violation detection lets you test communications signals for time or amplitude violations against a predefined mask. Each mask consists of one or more polygonal regions called segments. The signal waveform data should stay outside of the segments defined by the mask. Any signal data that occurs inside a mask segment is called a mask segment violation or "hit."

You can select from any of the included standard telecommunications masks, or you can define your own custom masks. Selecting a mask automatically sets the instrument communications triggers to properly display most communication signals in the mask.

Pass/Fail testing defines the mask testing parameters, including the number of waveforms to test, how many mask hits are allowed before failing a test, setting a mask margin tolerance value, and what action to perform upon the completion or failure of a test.

Communication triggering enables you to trigger on and display waveforms for industry-standard communications signals. See [Mask Types and Standards](#) for a list of the supported standards on which you can trigger.

Automatic communication signal measurements enable you to make automatic measurements on communications signals. See the [Communication Measurement](#) tab in the Measurement setup window for the available measurements.

The following are Serial Mask Testing key features:

- Predefined masks for testing or triggering on industry-standard signals, such as ITU-T G.703, ANSI T1.102, Fibre Channel, Ethernet, Video, SONET, Rapid IO, USB, IEEE 1394b, OIF Standards and their subsets
- Autoset, which quickly adjusts the instrument vertical and horizontal controls to display a waveform in a mask
- Autofit, which positions the signal on each acquisition to minimize mask segment hits
- Mask margins, which allow you to adjust the default mask margin tolerances
- Pass/Fail testing to continuously test a specified number of waveforms against a mask
- A mask editor for creating, saving, and recalling user-defined masks
- Waveform database technology to perform mask testing based on waveforms accumulated in a database, rather than a single waveform stored in acquisition memory
- Communications triggers to trigger the instrument on industry-standard communications signals
- Automatic measurements on communications signals

NOTE. *If a standard listed in this manual is not available on your instrument, it is because the configuration or bandwidth of your instrument cannot test that standard.*

Although this oscilloscope is not a calibrated optical reference receiver, you can use it with mask testing to evaluate general optical signal characteristics and wave shape, using an external O/E converter.

What do you want to do next?

[Learn more about mask testing.](#)

[Learn more about eye measurements.](#)

[Learn about communication triggering.](#)

[Go to mask testing setup.](#)

Levels used in taking eye measurements

All eye-diagram measurements are based on the power level, the voltage level, or the time locations of edges within each acquisition.

The next figure shows the areas of an eye-diagram used to calculate measurements.

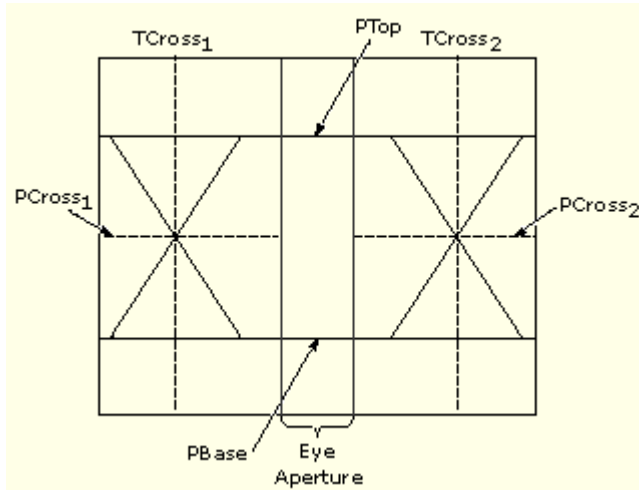

P values. The **P** values include the mean and standard deviation of the vertical location of **PTop** and **PBase**. These areas are used with a specified sample size to statistically measure the following values ¹:

- PTop Mean. This is the mean value of PTop.
- PTop Sigma. This is the standard deviation of PTop.
- PBase Mean. This is the mean value of PBase within the Eye Aperture.
- PBase Sigma. This is the standard deviation of PBase within the Eye Aperture.

T1 values. The **T1** values are vertical and horizontal values associated with the left-most crossing point. These areas are used to establish the following values:

- TCross₁ Mean. This is the horizontal mean of the left-crossing point at TCross₁.
- TCross₁ Sigma. This is the horizontal standard deviation of the left-crossing point at TCross₁.
- TCross₁ Peak-to-Peak. This is the horizontal peak-to-peak deviation of the left-crossing point at TCross₁.
- PCross₁ Mean. This is the vertical mean of the left-crossing point at PCross₁.

T2 values. The **T2** values are vertical and horizontal values associated with the right-most crossing point. These areas are used to establish the following directions:

- TCross₂ Mean. This is the horizontal mean of the right-crossing point at TCross₂.
- TCross₂ Sigma. This is the horizontal standard deviation of the right-crossing point at TCross₂.
- TCross₂ Peak-to-Peak. This is the horizontal peak-to-peak deviation of the right-crossing point at TCross₂.

¹ The Eye Aperture defaults to the center 20% of the interval from TCross₁ to TCross₂.

DCD values. The duty cycle distortion (DCD) values are horizontal values associated with the right-most crossing point at 50% of the eye height. These areas are used to establish DCD_{pk-pk} , the horizontal peak-to-peak deviation of the left-crossing point at half the height of the eye.

What do you want to do next?

[Learn about communication triggering.](#)

[Go to mask testing setup overview.](#)

Output

Saving and recalling setups

This instrument can save a number of different instrument setups for later recall, limited only by the space that you have to store the setups.

By saving and recalling different setups, you can switch from setup to setup without having to first manually record your settings and then manually set them. This capability is helpful when you want to:

- Save and recall a setup that optimizes the instrument for displaying and analyzing a certain signal
- Save a series of setups to help automate a procedure through recall of a sequence of saved setups as part of performing the procedure
- Save a setup for sharing with a second instrument

If you do not have an attached keyboard, you can still name setup files. The Save and Recall dialog boxes include a pop-up keyboard that you can use with your mouse or the touch screen to enter the setup path name and file name.

The instrument excludes the following items when saving setups:

- Channel waveforms and reference waveforms. Control settings (scale, position, and so on) are saved but not the waveform data. Upon recall of the setup, the settings are applied, but the data is not restored.
- Math waveforms. Control settings and the math expression are retained but not the waveform data. Upon setup recall, however, the math waveform expressions are applied, but math waveform data is not restored.
- User options stored in the Windows registry. These include all options set in the User Preferences control window.
- If you want to save a waveform in a useful format for other applications, such as a spreadsheet, use the save or save as function (see [Saving and Copying Waveform Data](#)).

A few other things to remember when saving and recalling setups:

- Recalling a setup replaces the current setup with the recalled setup. If you do not want to lose your current setup, save the setup file for later recall.
- Saved setups may contain settings inappropriate for waveforms currently in your instrument. For example, if you save a setup that displays a math waveform that is the average of reference waveform 1, when you recall the setup, if the reference is empty, the math and reference waveforms are not displayed.

What do you want to do next?

[Learn about saving and recalling waveforms.](#)

[Learn about exporting waveform data.](#)

Saving and recalling waveforms

This instrument can save any number of waveforms, limited only by the space that you have to store them.

By saving a waveform, you can recall it at a later time for comparison, evaluation, and documentation. This is helpful when you want to:

- Recall a waveform for further evaluation or comparison with other waveforms.
- Extend the waveform carrying capacity of the instrument. The instrument supports four reference, four channel, and four math waveforms. If you want more than four reference waveforms, you can save additional references to disk for recall later.

The Reference Setup control window contains a Label field for including comments with your saved waveforms.

If you do not have an attached keyboard, you can still enter comments and name reference waveform files. The Reference Setup control window includes a pop-up keyboard that you can use with your mouse or the touch screen to enter the waveform path name, file name, and comments.

The instrument recalls each waveform into one of the reference waveform locations Ref <1–4>. You cannot recall into a channel or a math waveform.

What do you want to do next?

[Learn about saving and copying waveform data.](#)

[Learn about saving and recalling setups.](#)

Saving and copying waveform data

This instrument supports saving waveform data to a file. The instrument can save waveforms, images, and measurements in several formats. You can also copy waveform data to the Windows clipboard for use with other applications, such as spreadsheets or math analysis applications.

A few things to remember when saving waveform data:

- Waveform data are saved as a series of comma-separated values (CSV), which are amplitudes without units. There is no timing information, but data is placed in the file in sequence from the first sample in the waveform record to the last.
- Because the waveform data are saved as CSV, without timing and scaling information, the instrument does not save these waveforms directly. (It only saves the data.) If you intend to recall a waveform later, save it (see the procedure [Saving A Waveform](#)) using the .wfm file type.
- You may also choose to copy a waveform and paste it directly into an application such as Microsoft Word or Excel. If so, select your waveform, and then select Copy in the Edit menu.

File formats. To make saved files more useful, select a file format usable by your analysis tools:

- BMP. This creates (.bmp) files in a bitmap file format usable by many graphic programs. (Available for screen captures.)
- JPEG. This creates (.jpg) files in a compressed image format usable by many graphic programs. (Available for screen captures.)
- PNG. This creates (.png) files usable by many graphic programs. (Available for screen captures.)
- TIFF. This creates (.tiff) files usable by many graphic programs. (Available for screen captures.)
- HDF5. This creates a Hierarchical Data Format (.h5) file of the entire waveform.
- Tek Waveform. This creates (.wfm) files that can be recalled back into an instrument reference file.
- Spreadsheet CSV. This creates (.csv) files in a format usable by spreadsheets (Excel, Lotus 1-2-3, and Quattro Pro).
Spreadsheet TXT. This creates (.txt) files in a text format usable by text and word processors and spreadsheets.
- MATLAB. This creates (.dat) files in a format usable by MATLAB.
- Mathcad. This creates (.dat) files in a format usable by MathCad. The MathCad file is an ASCII file, the first five values of which contain the following header information:
 - The first header value holds the record length.
 - The second header value holds time, in seconds, between samples.
 - The third header value holds the trigger position (expressed as an index in the data position).
 - The fourth header value refers to the fractional trigger position.
 - The fifth header value holds the horizontal offset in seconds.

NOTE. The delimiters are carriage returns.

What do you want to do next?

[Learn about saving and recalling setups.](#)

[Learn about saving and recalling waveforms.](#)

[Learn more about CSV text format.](#)

Miscellaneous

ACos

Inserts the text ACOS(into the math expression.

Acquisition interval

The acquisition interval is the time between sample points. For mathematical purposes, it is the time covered by the waveform record divided by the record length.

Acquisition window

The acquisition window defines what data are sampled from the input signal to form a waveform record.

- The vertical scale and offset controls set the vertical size and vertical center of this window independently for each channel.
- The horizontal scale and position controls set the horizontal size and position for all channels in unison.

Active probes

Active voltage probes often contain preamplifiers that provide high resistance and low capacitance at the probe tip. Some active voltage probes contain differential amplifiers that provide high Common Mode Rejection Ratio (CMRR).

Active current probes often contain Hall-effect sensors that extend the probe bandwidth down to DC.

Many active probes, especially high frequency probes, can drive a 50 Ω instrument input.

Amplitude

This voltage measurement is the high value minus the low value measured over the entire waveform or gated region:

Amplitude = High – Low

Analog oscilloscope sweeps

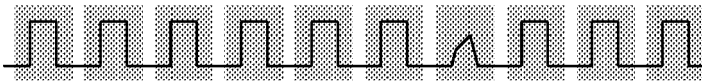

Area

Area is a voltage-over-time measurement. The measurement is the area over the entire waveform or gated region expressed in volt-seconds. The area above the common reference point is positive while the area below the common reference point is negative.

[Taking Automatic Measurements](#)

ASin

Inserts the text ASIN(into the math expression.

ATan

Inserts the text ATAN(into the math expression.

Auto trigger mode

Auto trigger mode causes the instrument to trigger if a valid trigger event does not occur within a set amount of time.

Auto trigger mode is useful when probing DC signal levels such as power supplies or logic levels that are stuck high or low. It is also useful when looking for activities on signal nodes such as oscillations when you first set up the instrument. The length of time it waits for a trigger event depends on the time base setting.

B-Event scan setup

B-Event Scan is particularly useful for creating overlapped eye diagrams, and applies to all standard Pinpoint Trigger A- and B-Events sequenced by Trig on nth Event in non-FastAcq mode.

The B-Event Scan initializes the Start Event value to 1 and the End Event value to 8. The Start Event must be less than or equal to the End Event value. Advance After, advances the B-Event value after the given number of acquisitions have occurred depending on the selected Advance method (Sequential, Random, and Toggle).

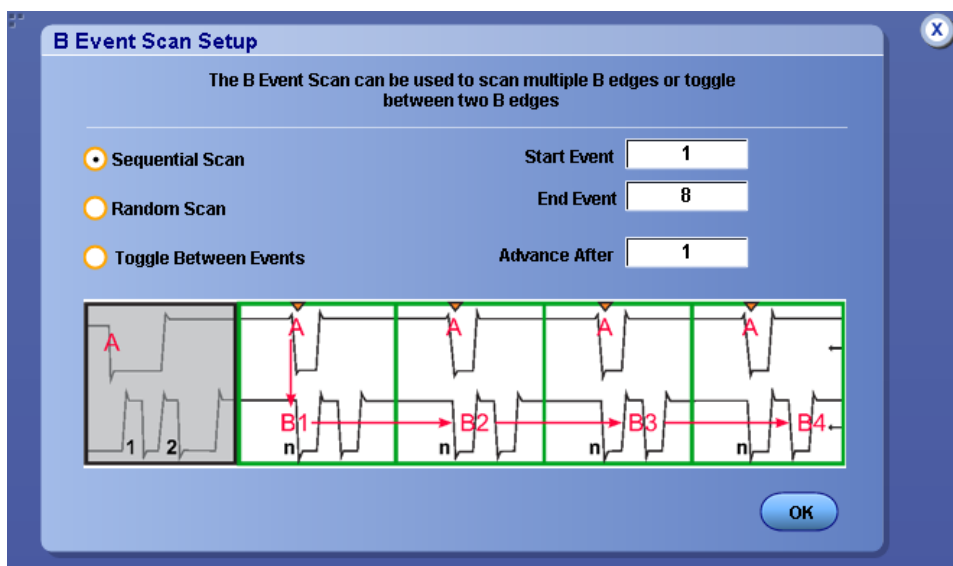

- When set to Sequential, the B-Event value is sequentially incremented after each acquisition completes, until the Start Event reaches the End Event. At this point the B-Event value is set to Start Event value again.
- When set to Random, the B-Event value is set to a random value between the Start Event and End Event values for each set of Advance After acquisitions.
- When set to Toggle, the B-Event value alternates between the Start Event and End Event for each set of Advance After acquisitions.

This process continues and occurs at hardware speed. The range for the B-Event, Start Event, and End Event is from 1 to 2e9.

CAN bit rate

1. Click in the Nominal Bit Rate entry box.
2. Use the multipurpose knob to set the bit rate for the trigger.

CAN format

In the CAN Format drop-down list, specify the format.

CAN signal type

In the drop-down Signal Type list, select the type of data to trigger on.

Center frequency

The center frequency is the frequency at the center of the frequency span. The maximum center frequency is equal to the sample rate divided by two (the Nyquist frequency) minus one half the span. The minimum center frequency is equal to one half of the span.

If the frequency span is set to maximum, then the center frequency will not move. To increase the center frequency beyond the present limits, either reduce the frequency span or increase the sample rate. To decrease the center frequency beyond the present limits, reduce the frequency span.

Channels selector

Specify the Channel <1 – 4> and waveform type (Channel, Math, or Reference) for oscilloscope operations.

- Click Ch and specify a channel to dedicate the controls for use with an input on the front panel.
- Click Math to dedicate the controls for use with the a math waveform.
- Click Ref to dedicate the controls for use with the a reference waveform.
- Shaded buttons Indicate unused or undefined waveforms.



Clear button

Removes all of the characters from the math expression.

Clear data control

Access this control from the Edit menu.

Use the Clear Data control to reset waveform, measurement, and histogram data, mask hit data, template violations, persistence, statistics, mask pass/fail test data. The Clear data control only clears the accumulated data; it does not turn off any functions.

Clock edge

The Clock Edge determines whether the instrument finds the trigger point on the rising edge (left button) or the falling edge (right button) of the clock signal.

Level

Click in the Level entry box and use the multipurpose knob and to set the threshold on which you want to trigger. Different levels are available depending on the code selected:

- The upper level controls the upper level trigger point
- The lower level controls the lower level trigger point
- The clock level sets the clock threshold on which you want to trigger

Communication trigger codes and standards

The communication trigger standards available for an instrument depend on the bandwidth and or the configuration of that instrument. Comm triggers are not available on DPO70000SX instruments. The following tables list the Communication Trigger Codes and Standards available with Mask Testing.

NOTE. The Comm Trigger is designed to work with communications mask and standard testing. Mask testing automatically uses Communication triggers. You must install the [Serial Communications Mask Testing Option](#) on some instruments before you can access the Comm triggers.

| AMI trigger standards | | | |
|-----------------------|------------------|------------------|-------------------------|
| Custom | 32Mb 32.064 Mb/s | 97Mb 97.728 Mb/s | DS1 1.544 Mb/s |
| DS1A 2.048 Mb/s | DS1C 3.152 Mb/s | DS2 6.312 Mb/s | DS2 Rate Sym 6.312 Mb/s |

| AMI trigger standards | | | |
|--------------------------|-------------------------|-------------------------|--------------------------|
| DS2 Rate Coax 6.312 Mb/s | DS3 44.736 Mb/s | E1 2.048 Mb/s | E2 8.448 Mb/s |
| E3 34.368 Mb/s | STS-1 51.84 Mb/s | | |
| Custom | DS3 44.736 Mb/s | STS-1 51.84 Mb/s | |
| Custom | DS2 6.312 Mb/s | DS2 Rate Sym 6.312 Mb/s | |
| Custom | DS1 1.544 Mb/s | DS1C 3.152 Mb/s | DS2 Rate Coax 6.312 Mb/s |
| Custom | DS4NA 139.26 Mb/s | E4 139.26 Mb/s | |
| STM1E 155.52 Mb/s | STS-3 155.52 Mb/s | | |
| Custom | E1 2.048 Mb/s | E2 8.448 Mb/s | |
| E3 34.368 Mb/s | DS1A 2.048 Mb/s | | |
| Custom | 100Base-TX 125 Mb/s | | |
| Custom | 2.5 IBand 2.5 Gb/s | FC133 132.8 Mb/s | FC266 265.6 Mb/s |
| FC531 531.2 Mb/s | FC1063 1.0625 Gb/s | FC2125E 2.125 Gb/s | G1 ATA 1.5 Gb/s |
| GB Ethernet 1.25 Gb/s | FS USB 12 Mb/s | HS USB 480 Mb/s | |
| OC1/STM0 51.84 Mb/s | OC3/STM1 155.5 Mb/s | OC12/STM4 622.1 Mb/s | |
| OC48/STM16 2.488 Gb/s | OC48-FEC 2.666 Gb/s | S400b 491.5 Mb/s | S800b 983.0 Mb/s |
| S1600b 1.966 Gb/s | XAU1 3.125 Gb/s | RapidIO 500M 500 Mb/s | RapidIO 750M 750 Mb/s |
| RapidIO 1.0G 1.0 Gb/s | RapidIO 1.5G 1.5 Gb/s | RapidIO 2.0G 2.0 Gb/s | SFI/SPI-5 2.5G 2.5 Gb/s |
| SFI/SPI-5 3.1G 3.1 Gb/s | RIO Serial 1G 1.25 Gb/s | RIO Serial 2G 2.5 Gb/s | RIO Serial 3G 3.125 Gb/s |
| VSR OC192 1.244 Gb/s | TFI-5 2.5G 1.488 Gb/s | TFI-5 3.1G 3.11 Gb/s | Serial 8b/10b 3.125 Gb/s |

Set up communication trigger coding

From the Trig menu, select Comm Setup.

Overview. Use these controls to select the coding format for triggering on a communication signal and the standard to use with the coding format.

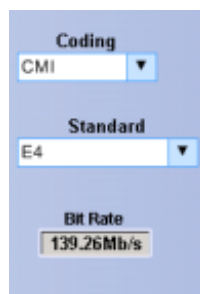

To use.

- In the Coding drop-down list box, select the coding format for triggering the communication signal.
- In the Standard drop-down list box, select the standard to use with the coding format.
- The Standard sets the bit rate.

Behavior. The coding format determines which standards are available as well as other parameters, such as trigger threshold and pulse form. The standard selected determines the bit rate. Changing the bit rate causes the standard to change to your own customized standard.

What do you want to do next?

[Learn about Communication Trigger Pulse Form.](#)

[Go to the Communication Trigger control window.](#)

Select the comm trigger pulse form

From the Trig menu, select Comm Setup.

Overview. Pulse Form directs the instrument to trigger on a voltage change from the prior bit. This can be positive, negative, or neutral if there was no change.

Depending on the code used, the pulse form can also indicate that triggering is to occur on an eye diagram.



To use. Click the pulse form you want the instrument to use for triggering:

- 1 triggers the instrument on a positive pulse form.
- 0 triggers the instrument on a neutral pulse form.
- -1 triggers the instrument on a negative pulse form.
- Eye triggers the instrument on an eye diagram.

Behavior. The available pulse forms are determined by which code is used for the signal. For example, the only pulse form available for NRZ codes is eye diagram.

What do you want to do next?

[Learn about Communication Trigger Coding.](#)

[Go to the Communication Trigger control window.](#)

Set the comm trigger source

- Use the Source drop-down list to select the channel for the Comm trigger source.
- Use the Type drop-down list to select the clock source for the trigger.
- Use the Polarity drop-down list to select the polarity of the clock source.

Control window handle

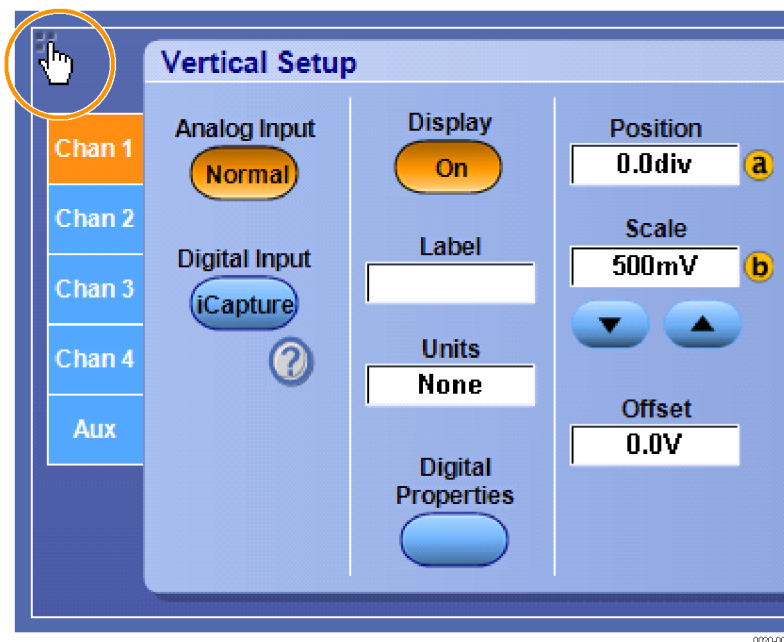

Cos

Inserts the text COS(into the math expression.

Cosh

Inserts the text COSH(into the math expression. The COSH function computes the hyperbolic cosine of x.

Crossing percent

Crossing percent measurement is the eye crossing point expressed as a percentage of eye height.

$$\text{Crossing Percent} = 100 \times \frac{(\text{pCross1Mean} - \text{pBaseMean})}{(\text{pTopMean} - \text{pBaseMean})}$$

Set the cursor sources (XY display)

From the Cursor menu, select Cursor Setup.

Overview. Use these controls to define the source for both Cursor 1 and Cursor 2 for any cursor type.

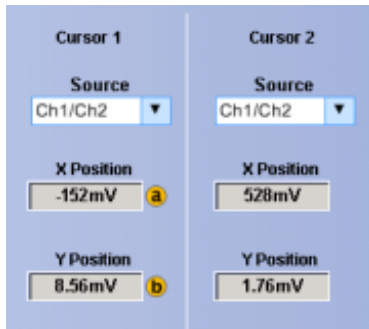

To use.

1. Click the Source drop-down list to select the measurement source for the cursor.
2. Click in a Position entry box and use a multipurpose knob to adjust the position of the cursor.

Behavior. If the cursor type is V Bars or H Bars, setting the Cursor 1 source sets the Cursor 2 source to the same value. To have different sources for Cursor 1 and Cursor 2, set the Cursor 1 source first, and then set the Cursor 2 source.

NOTE. Only Screen Cursors have both an X and Y Position controls.

The Multi-Purpose Knobs Adj buttons appear only with Screen cursors. Click the Adj buttons to assign the multipurpose knobs to the X-axis and the Y-axis controls.

What do you want to do next?

[Learn about cursor types.](#)

[Learn about cursor styles.](#)

[Learn about Cursor Readouts in XY display format.](#)

Customize color palettes

1. Click a User palette button in the Display control window, Colors tab.
2. Click the Edit button.
3. Click in the Hue, Saturation, or Lightness entry boxes; then use the multipurpose knobs to adjust the attributes.

Cycle area

The cycle area is a voltage over time measurement. The measurement is the area over the first cycle in the waveform or the first cycle in the gated region expressed in volt-seconds. The area above the common reference point is positive while the area below the common reference point is negative.

Cycle mean

This voltage measurement is the arithmetic mean over the first cycle in the waveform or the first cycle in the gated region.

Cycle RMS

This voltage measurement is the true Root Mean Square voltage over the first cycle in the waveform or the first cycle in the gated region.

Data direction

In the Data Direction drop-down list, specify the data direction.

Data threshold

1. Click in the Data Threshold entry box.
2. Use a multipurpose knob to set the threshold voltage for the trigger.

Dead time between acquisitions

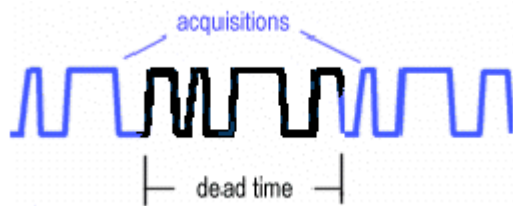

Delay edges

The Delay Edge buttons determine whether the measurements will be taken on the rising or falling edge of the waveform. After selecting an edge, the graphic in the control window is updated to show the edge from which the measurements will be taken.

Delay

This timing measurement is the time between the mid reference (default 50%) amplitude point of two different waveforms

Trigger delay

Use the Trig Delay control to trigger the instrument a specified period of time after the A trigger. After the A trigger arms the trigger system, the instrument triggers on the next B trigger event that occurs after the time that you specify with the Trig Delay control.

- Click in the Trig Delay entry box, and then use the multipurpose knob to enter the delay time.

Trigger events

Use the Trig Event control to trigger the instrument a specified number of events after the A trigger. After the A trigger arms the trigger system, the instrument triggers on the nth B trigger event.

- Click Trig Event, and then use the multipurpose knob to enter the number of B trigger events.
- Click the increment/decrement buttons to enter the number of B trigger events.

Select digital input iCapture

NOTE. *iCapture is available only on MSO7000C/DX Series instruments and DPO7000DX instruments with option MSOU installed.*

The supported instrument uses iCapture to display analog characteristics of up to four signals connected to up to four of the D15-D0 digital channel through a logic probe.

From the Vertical menu, select Vertical Setup.

To use.

- Click the Digital Input iCapture button when you want to display the analog characteristics of a single digital channel.
- Click the Digital Source selection box and select a digital channel to acquire and process as an analog input waveform.

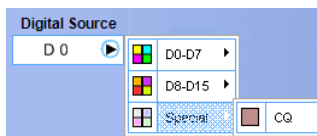

NOTE. *Right-click on the digital source waveform handle in the waveform window to reroute from one analog channel to any of the other three analog channels. For example, right-click on D0 captured on Ch1 and select iCapture on Ch2 to reroute source D0 to Ch2.*

What do you want to do next?

[Continue to learn about the Vertical Setup controls.](#)

[Learn about the Digital Properties button.](#)

Set up trigger path alignment

NOTE. *This online help supports many oscilloscope models from Tektronix. This feature is only available on some models.*

The exact trigger location is used in alignment process to avoid jitter. To minimize logic trigger errors, trigger adjustment aligns the 16 digital probe trigger paths (excluding the clock) using a specified analog path as a reference source to provide the best trigger alignment possible. You need the Logic Probe Deskew Fixture to deskew the logic probe against one analog probe on supported instruments. The fixture provides an edge source for the instrument to time-align the 16 logic trigger paths from the logic probe tips.

NOTE. *Refer to the Logic Probe Deskew Fixture Instructions, Tektronix part number 071-2613-XX, for information on equipment needed, and procedures to connect and perform the deskew routine.*

To use.

- Calibrate the analog probe connected to the reference channel.
- Click the Align Trigger Path button to start the trigger path alignment routine for the logic probe.
- Click the Clear Trigger Path Alignment button to clear the instrument memory of previously-aligned probe data.

Set logic properties

NOTE. *Logic Properties option is available only on MSO5000B and MSO70000C/DX Series instruments and DPO5000B Series instruments with option MSOE installed, and DPO70000DX instruments with option MSOU installed.*

From the Vertical menu, select Vertical Setup. From the Math menu, select Math Setup.

To use.

- Click the Logic Properties button when you want to specify the voltage threshold level of the Ch1-Ch4 (live) and M1-M4 (math) channels to use as logic waveforms and to include in a bus.
- Click the Logic Properties button to set the voltage threshold levels in the [Logic Threshold Setup Window](#).

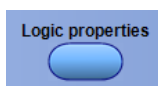

What do you want to do next?

[Continue to learn about the Vertical Setup controls.](#)

[Learn about the Logic Threshold Setup menu.](#)

Set the logic thresholds

NOTE. *The Logic Threshold Setup option is available only on MSO5000B and MSO70000C/DX Series instruments and DPO5000B Series instruments with option MSOE installed, and DPO70000DX instruments with option MSOU installed.*

Select the Vertical Setup or the Math Setup menu, and then click the Logic Properties button.

Overview. Use this control window to specify the voltage threshold level of the Ch1-Ch4 (live) and the M1-M4 (math) channels to use as logic waveforms and to include in a bus.

To use.

- Click the Threshold entry box for the desired channel and use the keypad to enter a value or use the multipurpose knobs to select a voltage level.
- Click the OK button.

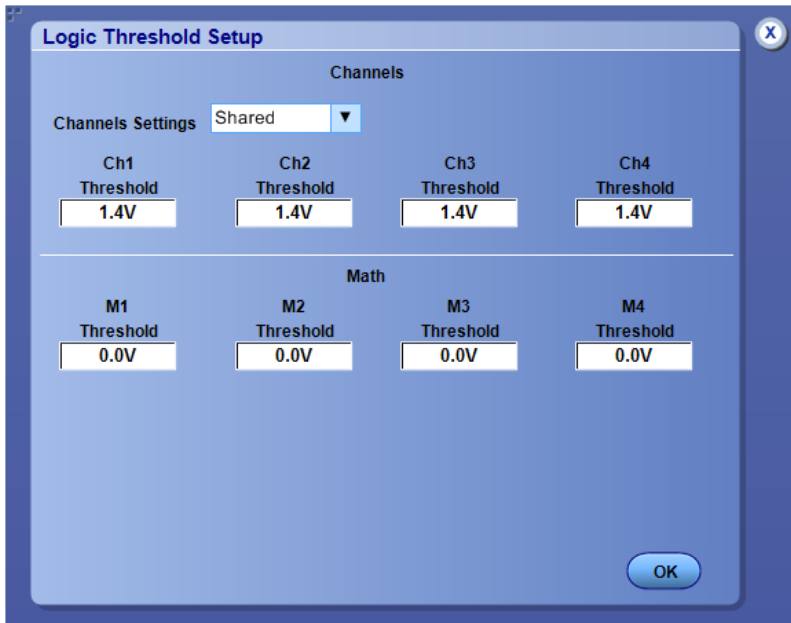

What do you want to do next?

[Learn about the digital channel setup.](#)

[Learn about bus setups.](#)

Select the display style

From the Display menu, select Display Setup; then open the General tab.

To use. Click one of the buttons to select the waveform display style.



Behavior.

- Vectors displays waveforms with lines drawn between record points.
- Dots displays waveform record points as dots on the screen. Dots are useful when you want to display multivalued waveforms such as eye diagrams.
- Inten Samp (Intensified Samples) shows only the actual samples. When you use intensified samples, you identify the actual sample points in an interpolated waveform.

You can also use the Display menu Display Style submenu to directly access the style options.

NOTE. The Vectors and Inten Samp selections are not available when using the XY or XYZ Display Formats.

What do you want to do next?

[Learn about changing the display colors.](#)

[Learn about using text with screen displays.](#)

[Learn about changing the appearance of objects in the display.](#)

Eye diagram

The eye diagram is a synchronized display of a data stream that shows signal levels and transition regions, typically over one cycle.

The eye diagram has the appearance of an opened eye. Compared to a normal instrument display, the eye diagram generally appears as an untriggered waveform. This is because on successive cycles the signal is high and then low. The areas of interest are the transition regions and eye opening.

Select the math color

From the Display menu, select Colors, or open the Colors tab in the Display control window.

To use. Click one of the buttons to select the color scheme for math waveforms.

- Click Default to use the default system color for the selected math waveform.
- Click Inherit to use the same color as the waveform the reference function is based on.



What do you want to do next?

[Learn about changing the overall display appearance.](#)

[Learn about changing the appearance of objects in the display.](#)

[Learn about using text with screen displays.](#)

Select the reference color

From the Display menu, select Colors, or open the Colors tab in the Display control window.

To use. Click one of the buttons to select the color scheme for reference waveforms.

- Click Default to use the default system color for the selected reference waveform.
- Click Inherit to use the same color as the original waveform.



What do you want to do next?

[Learn about changing the overall display appearance.](#)

[Learn about changing the appearance of objects in the display.](#)

[Learn about using text with screen displays.](#)

Select the trigger level marker

From the Display menu, select Objects, or open the Objects tab in the Display control window.

To use. Click one of the buttons to select the trigger level indicator.



Behavior. The trigger level markers indicate the voltage level where the trigger or threshold levels of the active waveform occur:

- The Short trigger level marker displays a short arrow on the side of the graticule by the active waveform.
- The Long trigger level marker displays a horizontal line through the active waveform.

NOTE. The trigger level indicator does not appear on inactive waveforms, reference waveforms, or fast acquisition signals.

What do you want to do next?

[Learn about changing the overall display appearance.](#)

[Learn about changing the display colors.](#)

[Learn about using text with screen displays.](#)

Duty cycle distortion

Duty cycle distortion is the peak-to-peak time variation of the first eye crossing measured at the MidRef as a percent of the eye period.

$$\text{DCD}(\text{sec}) = 100\% \times \text{TDCDp-p} / (\text{TCross2mean} - \text{TCross1mean})$$

Edit a user mask

Use the Mask Edit Setup to alter a user mask.

1. From the Masks menu, select Mask Edit Setup to display the Mask Edit control window.
2. Under Mask Elements, use the up and down arrows to select the Segment and Vertex you want to edit. The selected segment appears in red and a white X indicates the selected vertex.
3. Click in the Horizontal and or Vertical controls under Mask Value to change the horizontal or vertical values of the mask.
4. Click Save to save your changes to the user mask.

Editor button

Closes this window and opens the Equation Editor control window so you can edit the math expression.

Enter math equation editor (Operands)

From the Math menu, select Equation Editor, or click the Editor button in the Math Setup or Spectral Setup control windows.

To use. Click an individual button to enter a character or operator into the math expression.

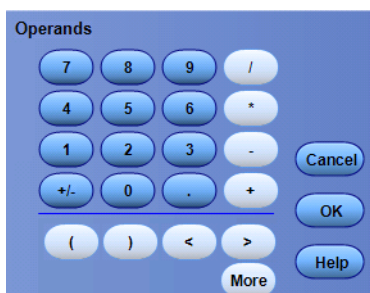

Behavior. The characters are entered into the math expression one at a time.

What do you want to do next?

[Learn about the Math Setup controls.](#)

[Learn about averaging math waveforms.](#)

Set up e-mail on trigger

Click Setup to access the E-mail on Event control window where you configure sending e-mail on events.

Enhanced bandwidth indicator.

Extinction ratio

Extinction ratio is the ratio of eye top to base. This measurement is only valid when the acquisition mode is set to WfmDB, FastAcq is enabled, or the measurement is taken on a reference waveform saved in FastAcq mode.

$\text{Ext Ratio} = \text{pTopMean} / \text{pBaseMean}$

Extinction ratio decibel

Extinction ratio decibel is the ratio of eye top to base expressed in decibels.

This measurement is only valid when the acquisition mode is set to WfmDB, FastAcq is enabled, or the measurement is taken on a reference waveform saved in FastAcq mode.

$\text{Ext dB} = 10 \times \text{Log}(\text{pTopMean} / \text{pBaseMean})$

Eye base

Eye Base is the base value used in the extinction ratio measurements.

$\text{Eye Base} = \text{pBaseMean}$

Eye diagram

The eye diagram is a synchronized display of a data stream that shows signal levels and transition regions, typically over one cycle.

The eye diagram has the appearance of an opened eye. Compared to a normal instrument display, the eye diagram generally appears as an untriggered waveform. This is because on successive cycles the signal is high and then low. The areas of interest are the transition regions and eye opening.

Eye height

Eye height is the measurement of the eye height in volts.

$\text{Eye Height} = (\text{pTopMean} - 3 \times \text{pTopSigma}) - (\text{pBaseMean} + 3 \times \text{pBaseSigma})$

Eye top

Eye Top is the top value used in the extinction ratio measurements.

Eye Top = pTopMean

Eye width

Eye width is the measurement of eye width in seconds.

Eye width = (tCross2Mean - 3 × pTopSigma) - (tCross1Mean + *tCross1Sigma)

Set up e-mail configuration

From the Utilities menu, highlight E-mail on Event; then Select Setup from the submenu. In the E-mail on Event Setup window, click the Config button.

Overview. Use this dialog box to enter the address of the mail server to use when sending E-mail on events. You must have a server entered in the SMTP Server Address box for your instrument to send e-mail.

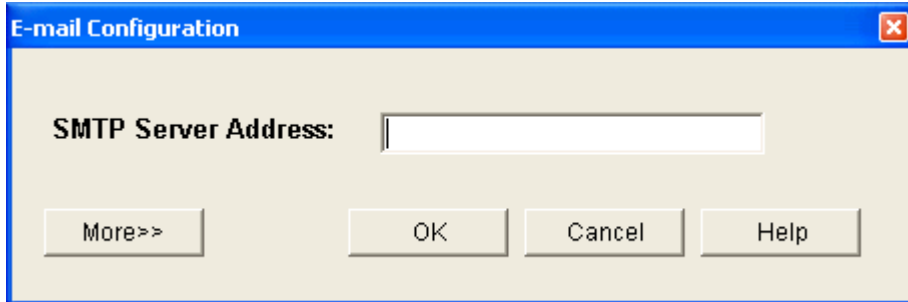

You can customize your e-mail by selecting the number of attempts to make, entering a From address, setting the time out length, entering a login and password if necessary, and entering a host name.

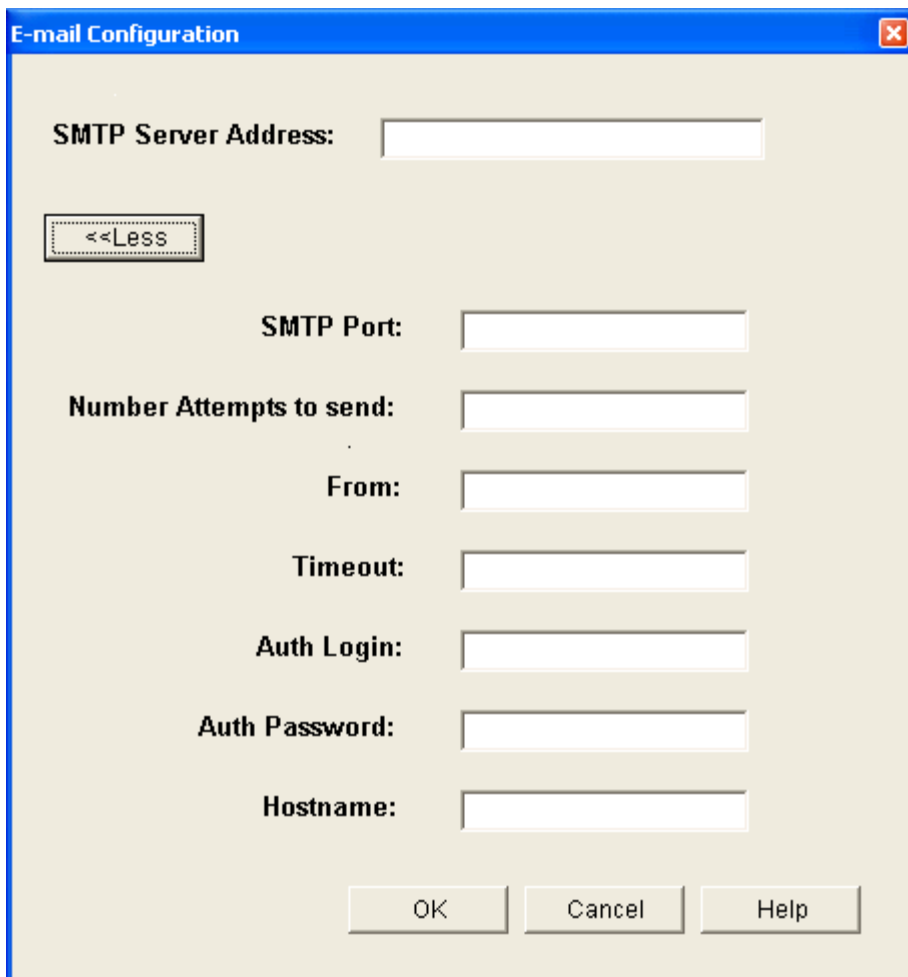

To use.

- Enter the SMTP server address.
- Click OK if you want to accept the default values.
- Click More>> if you want to customize your e-mail.
- Enter the appropriate information in each box that you need to change from the default.

Behavior. The number you enter in the Number Attempts to Send entry box is the number of times the system will try to send the e-mail if it is not successful on the first try. The default is 1.

Entering an address in the From entry box puts that address in the From field of the e-mail. The default value is the instrument model number. Entering your own address allows the instrument to send you e-mail if there is a problem sending to the recipient.

Entering a number in the Timeout entry box will override the default time out for sending e-mail to the server.

If your mail server requires a login or password, enter the login in the Auth Login entry box and the password in the Auth Password entry box.

Entering a network ID in the Hostname entry box makes the e-mail appear as though it did not come from the instrument.

What do you want to do next?

[Learn about E-mail on Event Setup.](#)

Send an e-mail on trigger

To send e-mail on a trigger event, click the E-mail on Trigger button to On.

NOTE. E-mail on Event must be configured to enable E-mail on Trigger (Use the Utilities > E-mail on Event > Setup window).

Fall time

This timing measurement is the time required for the falling edge of the first pulse in the waveform or gated region to fall from the high reference value (default = 90%) to the low reference value (default = 10%) of the final value.

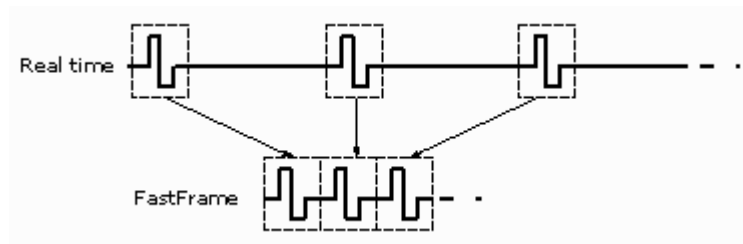
FastFrame acquisitions

Force a trigger

Click this button to force the instrument to trigger and complete the current acquisition, regardless of whether any other trigger event occurs.

NOTE. This command has no effect if the acquisition system is not running.

Frequency

This timing measurement is a measure of the first cycle in a waveform or gated region. Frequency is the reciprocal of the period; it is measured in Hertz (Hz) where one Hz is one cycle per second.

Frequency span

The frequency span is the range of frequencies over which the spectral analysis is performed. The maximum span is from DC to one half of the sample rate (the Nyquist frequency). A smaller frequency span allows a greater range of center-frequency adjustment. If a larger frequency span is desired, increase the sample rate.

Getting the analysis and connectivity support tools

This instrument offers several tools you can install to support data export for use with data-analysis tools.

These tools ship with the Tektronix instrument that this online help supports. You can find them on the product software DVD that ships with this instrument. You can find the Readme file on the CD-ROM that you use to install the analysis and connectivity tools.

For more information:

- For general information and examples on how each of these tools can help you use your instrument, see the *Getting Started with OpenChoice Solutions Manual* with the CD-ROM (020-2513-XX).
- For online information about the VXIplug&play driver, access the driver online help in from the help system of your software development environment in which you install the driver. The driver online help describes each function of the driver and presents these components in a hierarchical outline corresponding to the standard VXIplug&playmodel.
- For further reference information on TekVISA, see the *TekVISA Programming Manual* (071-1101-XX).
- For online information on the TekVISA Excel toolbar, access the online help for the TekVISAExcel Toolbar from the Excel Help menu once you have installed the toolbar.

Ground terminal

Use this terminal to connect the instrument to the same ground as the unit under test.

Guidelines for working with math waveforms

Use the following guidelines when working with math waveforms:

- Keep math waveforms simple. If the math expression becomes too complex, try separating the expression into more than one math waveform and then combining the waveforms (for example, Math1 = Math2 + Math4).
- Math calculations are not available on digital channels.
- You cannot use math waveforms with Fast Acquisition mode.
- Math waveforms cannot be turned on without a math expression.
- Math waveforms cannot be created from a reference waveform that was saved in Fast Acquisition mode.
- To avoid syntax errors in a math expression, verify the use of operators, parentheses, operands, and the spelling of functions.

- When working with reference waveforms, if one or more reference waveforms are used as part of a math waveform, the number of frames in the math waveform is the smallest of all source waveforms (reference, math, or channel waveforms).
- If one or more reference waveforms are used in a math waveform, the record length is equal to the smallest of all the source waveforms (reference, math, or channel waveforms). The math is calculated using the first point from each source, followed by the next point, and so forth. This is true even if the sources have different times between points in the record.

High

The high level measurement is the value used as 100% whenever high reference, mid reference, or low reference values are needed, such as in fall time or rise time measurements. This value can be calculated using either the min/max or histogram method. The min/max method uses the maximum value found. The histogram method uses the most common value found above the midpoint. This value is measured over the entire waveform or gated region.

High impedance probes

Most general-purpose probes have high input impedance.

The high input resistance of passive probes (typically 10 M Ω) provides negligible DC loading and provides accurate DC amplitude measurements.

Most passive probes require the instrument input impedance to be 1 M Ω . However, their 8 pF to 12 pF (over 60 pF for 1X) capacitive loading can distort timing and phase measurements.

Use high resistance passive probes for measurements involving the following:

- Device characterization (above 15 V, thermal drift applications)
- Maximum amplitude sensitivity using 1X probe
- Large voltage range (between 15 V and 500 V)
- Qualitative or go/no-go measurements

High reference

The High Reference defines the high reference level of a waveform; the default level is 90%. This reference level is used with the Low Reference level in the calculation of rise and fall times. To change this level, click the control, and then set the level with the multipurpose knob.

Histogram box limits - horizontal

1. Select a mode:

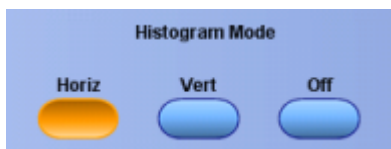

2. Specify the adjustment:

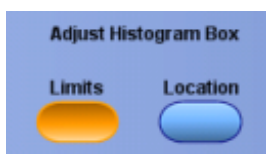

3. Enter limits:

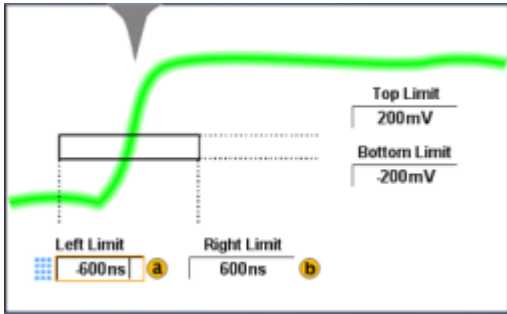

Histogram box limits - vertical

1. Select a mode:

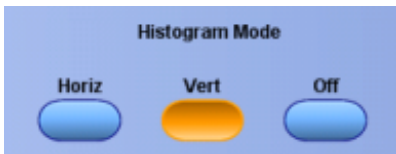

2. Specify the adjustment:

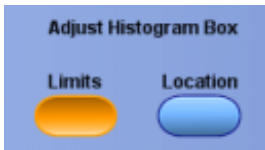

3. Enter limits:

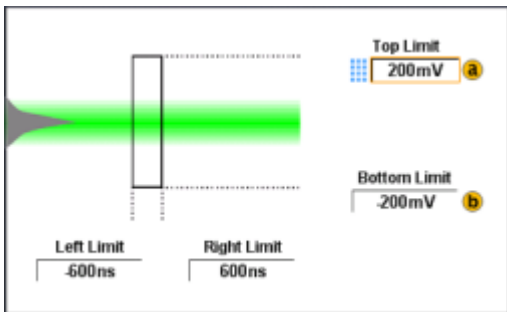

Histogram box location - horizontal

1. Select a mode:



2. Specify the adjustment:

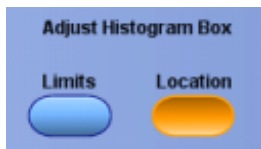

3. Enter limits:

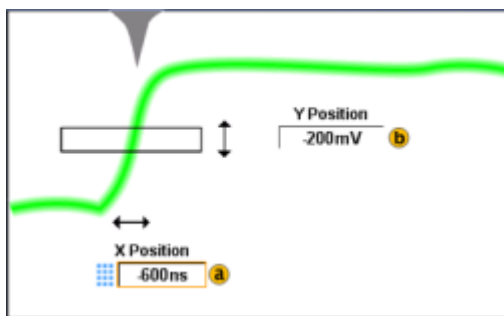

Histogram box location - vertical

1. Select a mode:

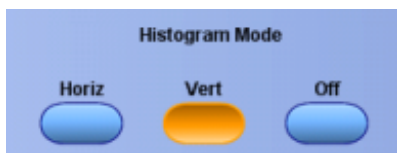

2. Specify the adjustment:

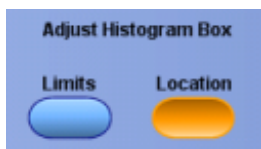

3. Enter limits:

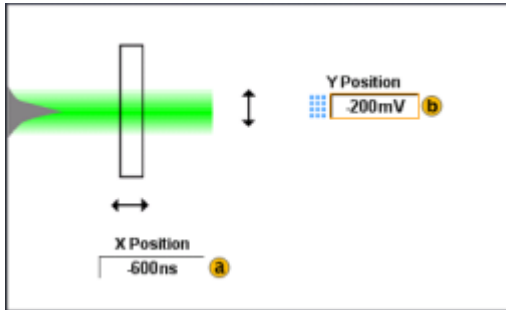
**Histogram max**

Displays the voltage of the highest nonzero bin in vertical histograms or the time of the right-most nonzero bin in the horizontal histograms.

Histogram mean

Measures the average of all acquired points within or on the histogram box.

Histogram min

Displays the voltage of the lowest nonzero bin in vertical histograms or the time of the left-most nonzero bin in the horizontal histograms.

Hits in box

Displays the number of points in or on the histogram box.

Maximum

This voltage measurement is the maximum amplitude. It is typically the most positive peak voltage and is measured over the entire waveform or gated region.

Mean plus or minus 1 StdDev

The percentage of points in the histogram that are within one standard deviation of the histogram mean.

Mean plus or minus 2 StdDev

The percentage of points in the histogram that are within two standard deviations of the histogram mean.

Mean plus or minus 3 StdDev

The percentage of points in the histogram that are within three standard deviations of the histogram mean.

Minimum

This voltage measurement is the minimum amplitude. It is typically the most negative peak voltage and is measured over the entire waveform or gated region.

Peak hits

Displays the number of points in the largest bin of the histogram.

Pk-Pk

Displays the peak-to-peak value of the histogram.

- Vertical histograms display the "voltage" of the highest nonzero bin minus the "voltage" of the lowest nonzero bin.
- Horizontal histograms display the "time" of the right-most nonzero bin minus the "time" of the left-most nonzero bin.

StdDev (standard deviation)

The standard deviation (Root Mean Square deviation) of all acquired points within or on the histogram box.

Waveform count

Displays the number of waveforms that have contributed to the histogram.

Median

The middle point of the histogram box. Half of all acquired points within or on the histogram box are less than this value and half are greater than this value.

Set the horizontal delay

Use the Horizontal Delay Mode control to enter the amount of horizontal delay.

1. Click the Horizontal Delay Mode button to set the horizontal delay to on.
2. Click in the Acquisition Delay entry box and use the multipurpose knob to enter a value.

NOTE. You can also enter a delay value with the front-panel Horizontal Position knob.

Set the horizontal position

Use the Horizontal Position control to move the trigger point within the acquired waveform.

- To acquire waveform data only after the trigger event, set the Horizontal Position control to zero.
- To acquire waveform data leading up to the trigger event, set the Horizontal Position control to any value greater than zero.
- For some setup control windows, you can click in the position control entry box and use the multipurpose to enter a value (in addition to using the front-panel Horizontal Position knob).

Horizontal Position-Scale control window (Delay mode)

From the Horiz /Acq menu, select Position/Scale.

Overview. Use the [Horizontal Position/Scale control window](#) to set the horizontal delay and the horizontal scale of the displayed waveforms when the horizontal delay is on.

To use.

- When [horizontal delay is off](#), the horizontal position control moves the trigger point within the acquired waveform. The horizontal scale control expands or contracts the waveform around the trigger point.
- When [horizontal delay is on](#), you can delay the acquisition relative to the trigger event.

For more information on horizontal delay, see [Horizontal Position/Scale Control Window: Horiz Delay On](#).

What do you want to do next?

[Learn more about the Horizontal Position controls.](#)

Set the horizontal position

From the Horiz /Acq menu, select Position/Scale to open the [Horizontal Position/Scale control window](#).

Overview. The horizontal position control moves the trigger point within the acquired waveform.

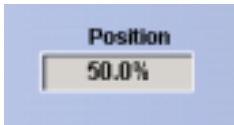

To use.

- Click in the Position entry box and use the multipurpose knob or keypad to change the setting.

Behavior. You can select the amount of data that appears before and after the trigger event. To acquire waveforms leading up to the trigger event, set the horizontal position control to the maximum time setting. To acquire waveforms after the trigger event, set the horizontal position control to the minimum time setting.

The horizontal reference point is shown as a small inverted triangle.



TIP. Use the dedicated front-panel Position knob to change the horizontal position.

What do you want to do next?

[Learn about the Horizontal Scale control.](#)

Set the horizontal scale

From the Horiz /Acq menu, select Position/Scale to open the [Horizontal Position/Scale control window](#).

Overview. The Horizontal Scale control adjusts the time base.

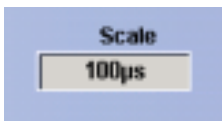

To use.

- Click in the Scale entry box and use the multipurpose knob or keypad to change the setting.

Behavior. The Scale control scales all live displayed waveforms at the same time.

The scale units depend on the waveform type. In most cases the horizontal units will be time. However, the horizontal units can also be frequency.



TIP. Use the dedicated front-panel Horizontal Scale knob to change the horizontal scale.

What do you want to do next?

[Learn about the Horizontal Setup control window.](#)

[Learn about the Acquisition Setup control window.](#)

Horizontal reference marker



Horizontal delay mode

Use the Horizontal Delay Mode button to delay the acquisition relative to the trigger event.

- When Horizontal Delay Mode is On, use the Acquisition Delay control to enter the delay time.
- You can also enter the delay time with the front-panel Horizontal Position knob.



TIP. The Horizontal Delay Mode button functions identically to the Delay Mode button in the Horizontal/Acquisition control window.

Set the horizontal delay

From the Horiz /Acq menu, select Position/Scale to open the [Horizontal Position/Scale control window](#).

Overview. The Horiz Delay control delays the acquisition relative to the trigger event.

**To use.**

- Click Delay Mode On or push the front-panel Delay button to activate horizontal delay.
- Click in the Horiz Delay entry box and use the multipurpose knob or keypad to change the setting. You can also use the dedicated Horizontal Position knob on the front panel.

Behavior. The horizontal delay feature is useful when you want to acquire waveform details that are separated from the trigger event by a significant interval of time.

For example, you can trigger the instrument on a sync pulse that occurs once every 10 ms, and then look at the high-speed characteristics that occur 6 ms after the pulse.



TIP. A convenient way to use the horizontal delay is to make quick comparisons between two different points in time. Trigger the instrument on one area of interest and then set the horizontal delay to acquire the other area of interest. You can then toggle the horizontal delay on and off to compare details at the two points in time.

What do you want to do next?

[Learn more about the Horizontal Position controls.](#)

Set the horizontal scale when delay is on

From the Horiz /Acq menu, select Position/Scale to open the [Horizontal Position/Scale control window](#).

Overview.

To use.

- Click in the Scale entry box and use the multipurpose knob or keypad to change the setting.

Behavior. Use the Scale control to adjust the time base. This control scales all live displayed waveforms at the same time. When horizontal delay is on, the scale expands or contracts around the horizontal reference point instead of the trigger point.

The scale units depend on the waveform type. In most cases the horizontal units will be time. However, the horizontal units can also be frequency.



TIP. Use the dedicated front-panel Horizontal Scale knob to change the horizontal scale.

What do you want to do next?

[Learn more about the Horizontal Position controls.](#)

[Learn about the Horizontal Setup control window.](#)

[Learn about the Acquisition Setup control window.](#)

Acquisition mode

From the Horiz /Acq menu, select Horizontal/Acquisition Setup; then open the Acquisition tab.

The Acquisition Mode controls determine the method of acquisition.

To use.

- If you use Average or Envelope mode, select the number of waveforms for that mode using the multipurpose knob.
- If you use Waveform Database mode, use the multipurpose knob to select the number of samples.

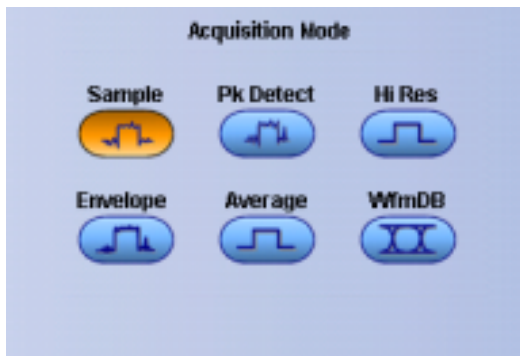

Behavior. A single waveform data point can be made up of several sequentially acquired data points. The waveform data points can also be created from a composite of sampled data taken from multiple acquisitions. The acquisition modes determine how the waveform data points are produced from the sampled data.

Sample. This mode creates a record point by saving one or more samples during each *acquisition interval*. Sample mode is the default acquisition mode. The instrument does no post processing of acquired samples in this mode.

Pk Detect. Peak Detect mode alternates between saving the highest sample in one acquisition interval and the lowest sample in the next acquisition interval. Peak Detect mode only works with real-time, noninterpolated sampling.

Hi Res. High Resolution mode averages all samples taken during an acquisition interval to create a record point. This average results in a higher-resolution, lower-bandwidth waveform. This mode only works with real-time, noninterpolated sampling.

NOTE. A key advantage of Hi Res mode is its potential for increasing resolution regardless of the input signal. The following table indicates that you can obtain up to 15 significant bits with Hi Res mode. Note that the resolution improvements are limited to speeds slower than 40 ns/div.

| Additional resolution bits | | |
|----------------------------|----------|---------|
| 2.5 GS/s | 8.5 bits | 1.1 GHz |
| 1 GS/s | 9 bits | 440 MHz |
| 250 MS/s | 10 bits | 110 MHz |
| 50 MS/s | 11 bits | 22 MHz |
| 10 MS/s | 12 bits | 4.4 MHz |
| 2.5 MS/s | 13 bits | 1.1 MHz |
| 1 MS/s | 14 bits | 440 kHz |
| 250 KS/s | 15 bits | 110 kHz |
| 25 KS/s | >15 bits | 11 kHz |
| 250 S/s | >15 bits | 110 Hz |
| 25 S/s | >15 bits | 11 Hz |
| 2.5 S/s | >15 bits | 1.1 Hz |

Envelope. This mode acquires and displays a waveform record that shows the extremes in variations over several acquisitions. The instrument saves the highest and lowest values in two adjacent intervals similar to Peak Detect mode. Unlike Peak Detect mode, the peaks are gathered over many trigger events.

After each trigger event, the instrument acquires data and then compares the minimum and maximum values from the current acquisition with those stored from the previous acquisition. The final display shows the most extreme values for all the acquisitions for each point in the waveform record.

Acquiring and displaying a noisy square wave signal illustrates the difference between the modes. Note how Average mode reduces the noise while Envelope mode captures its extremes:

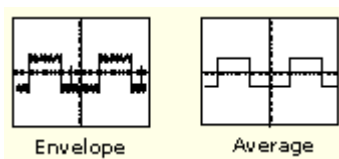

Average. This mode acquires and displays a waveform record that is the average result of several acquisitions. This mode reduces random noise. Use the multipurpose knobs to specify the number of waveforms that you want to average.

WfmDB. Waveform Database mode acquires and displays a waveform that is the accumulation of several acquisitions. In addition to time and amplitude, the waveform displays a count of the number of times a specific sample point has been acquired. The value at each point on the waveform is a counter that reflects the hit intensity. The instrument acquires data after each trigger event using Sample mode. It then determines the location of each sample point and accumulates it with shared data from previous acquisitions. This is the only mode that can be used when doing mask testing with an optical standard. Fast Acq is inhibited in Waveform Database mode.

What do you want to do next?

[Learn about Fast Acquisitions mode.](#)

[Learn about Roll mode.](#)

Horizontal/Acquisition control window (Acquisition tab)

From the Horiz /Acq menu, select Horizontal/Acquisition Setup; then open the Acquisition tab.

Overview

Use the Acquisition tab to set the acquisition parameters for all live waveforms. The Acquisition controls are common to all channels. This means that you cannot acquire in Sample mode on channel 1 while channel 2 acquires in Envelope mode.

For information on the controls, click on the buttons.

[Acquisition mode](#) on page 768

[Fast Acquisitions](#)

[Roll Mode](#)

[Sampling Modes](#)

[FastFrame Control Windows](#)

[External Signals Control Window](#)

Behavior

Acquisition is the process of sampling the analog input signal, digitizing the signal to convert it into digital data, and then assembling the signal information into a waveform record. The instrument creates a digital representation of the input signal by sampling the voltage level of the signal at regular time intervals. The sampled and digitized points are stored in memory along with the corresponding timing information. The instrument uses the digital representation of the signal for display, measurements, or for further processing.

Use the controls on this tab to define the sampling method, the acquisition mode, turn Fast Acquisitions on or off, and activate an external reference.

What do you want to do next?

[Acquisition mode](#) on page 768

Set horizontal delay and horizontal position

From the Horiz /Acq menu, select Horizontal/Acquisition Setup; then open the [Horizontal tab](#).

Overview. Use this control to select the amount of data that appears before the trigger event.

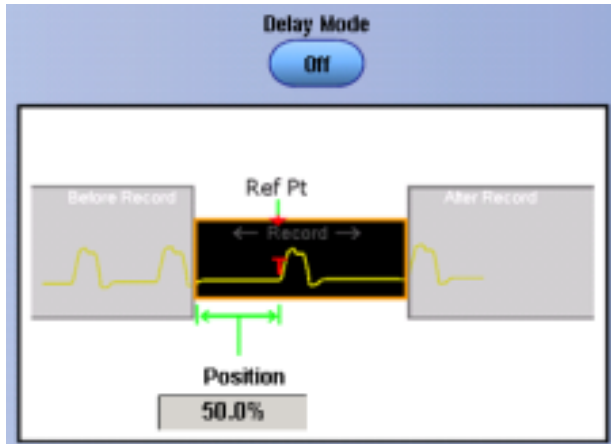

To use.

- Click **Delay Mode** to toggle Delay Mode Off, and then click in the Position entry box. Use a multipurpose knob or the front-panel Horizontal Position knob to set the horizontal position.
- Click **Delay Mode** to toggle Delay Mode On, and then click in the Horiz Delay (Horizontal Delay) or Ref Point (Reference Point) entry boxes. Use a front panel multipurpose knob or the keypad to set these values.

Behavior. The Position control moves the trigger point within the acquired waveform.

The Horiz Delay and Ref Point controls only appear when the Delay Mode is On. Horiz Delay enables the instrument to look for a trigger and then wait a specified time before acquiring data. This is useful when you know that the data you are interested in occurs a set time after the trigger.

Use the Ref Point control to specify the amount of pretrigger data. The reference point is represented on the screen by a small inverted triangle.



TIP. Use the dedicated Horizontal Delay button to turn the Horizontal Delay on and off. Or, use the Horiz/Acq menu Delay Mode On command.

You can also toggle the Horizontal Delay on and off to quickly compare signal details at two different areas of interest, one near the trigger location and the other centered at the delay time.

What do you want to do next?

[Go to the Horizontal Setup control window.](#)

[Return to the Acquisition Setup control window.](#)





Horizontal control window readouts

From the Horiz /Acq menu, select Horizontal/Acquisition Setup; then open the [Horizontal tab](#).

Overview. Use the horizontal readouts, similar to those shown below, to obtain a quick overview of the horizontal settings.

NOTE. You cannot change the Horizontal controls directly from the readouts.

To use. The readout values are determined by the Horizontal control settings. The type and number of readouts will change depending on the setup of the horizontal controls.

-  Resolution Readout. This readout displays the time between sample points. In most cases, the acquisition interval is the same as the resolution.
-  Sample Rate Readout. This readout displays the number of acquisition samples per second. The faster the sample rate, the more accurately the instrument can represent fine details in a fast signal.
-  Duration Readout. This readout displays the time to cross the 10-division screen.
-  Record Length Readout. This readout displays the number of samples that make up the waveform record.
-  Digital Record Length. This readout displays the number of samples that make up the digital waveform record.

NOTE. Digital Record Length is available only on MSO5000B Series instruments and DPO5000B Series instruments with option MSOE.

What do you want to do next?





[Learn more about the Horizontal Setup controls.](#)

Horizontal controls

From the Horiz /Acq menu, select Horizontal/Acquisition Setup; then open the [Horizontal tab](#).

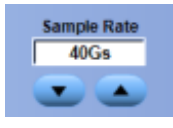
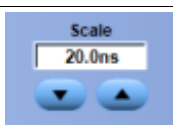
Overview. Use the Mode controls to adjust the time base.

To use. Click in a Horizontal Controls entry box to map it to one of the multipurpose knobs; then use the knob to change the value. You can also use the pop-up keypad to enter a value.

| Horizontal controls | |
|--|---|
|  | <p>Use this control to set the sample rate for the waveform record. In general, higher sampling rates produce more accurate measurements.</p> |
|   | <p>Use this control to adjust the scale of live waveforms, including math waveforms. Scale units depend on the waveform type; in most cases the horizontal units will be time, but they can also be frequency.</p> <p>TIP. Use the dedicated front-panel Horizontal Scale knob to change the horizontal scale.</p> |
|  | <p>Use this control to define the length of the waveform record. The record length is the number of sample points that make up the waveform record.</p> <p>NOTE. Record lengths of less than 1000 samples are not supported.</p> |
|  | <p>Click this button to maximize the updated rate by setting a record length limit in the Set Record Length Limit dialog box. This feature is available in Automatic mode only.</p> |

Behavior. When you change the record length, you can choose to hold either the sample rate or the horizontal scale constant. The remaining variables will change in response to the record length changes.

Maximum record length depends on the following:

- The amount of memory.
- The ability to combine the memory length of unused channels.

NOTE. Hi Res and Avg modes require twice the acquisition memory of other acquisition modes. When you select these modes, the instrument sets the record length accordingly to keep it from running out of memory.

Delay mode.

- When Delay Mode is Off the scale expands or contracts around the [trigger point](#).
- When Delay Mode is On the scale expands or contracts around the horizontal reference point.

Horizontal zoom. You can use the [Horizontal Zoom control window](#) to change the horizontal scale and position of reference waveforms within the Zoom window(s).

What do you want to do next?

[Learn more about the Horizontal Setup controls.](#)

I2C addressing mode

In the Addressing Mode drop-down list, select the bit addressing mode.

Installing software

The instrument system and application software is pre-installed at the factory. If you have to reinstall the software for any reason, refer to the instruction manuals that accompanied the product.

Software release notes. Read the software release notes (README.TXT) on the product software DVD before performing installation procedures. This file contains additional information that supersedes other product documentation.

To view the README.TXT file, start the Windows Notepad accessory and open the file from the product software DVD that came with your instrument.

Accessory software. The product software DVD contains accessory software and files that you can install on the instrument or on another PC. Refer to the instructions that accompany the DVD for installation information.

Desktop applications. You can install desktop application software on the instrument. The instrument has been tested with the following software products installed:

- Microsoft Office (Word, Excel, PowerPoint, etc.)
- MathCad
- MATLAB

Other software products may be compatible but have not been tested by Tektronix. If the instrument malfunctions after you install software, uninstall the software and then reinstall the instrument application to restore proper operation.

Before installing other desktop applications, exit the instrument application. To do this, click Exit on the File menu.

Interactions of roll mode and other instrument settings

Roll mode can interact with other instrument settings:

- If Roll mode is on and you turn on Fast Acquisitions, Roll mode will be suppressed until you turn Fast Acquisitions off.
- If Roll mode is on, math waveforms and measurements are updated only after acquisition is stopped (when you manually stop an acquisition). If you stop an acquisition before a record is filled, the math waveform or measurements will be calculated on the partial data.
- Roll mode is only valid for real-time acquisition modes such as Sample, Peak Detect, and Hi Res. Roll mode is ignored in Average or Envelope acquisition modes.
- Deskew values are ignored when Roll mode is on.
- If you attempt to save a waveform when Roll mode is on, only the waveform points in the acquisition memory are saved.
- The maximum record length where Roll mode is allowed is 10 M.

IVI drivers

IVI drivers conform to specifications produced by the IVI Foundation.

Unlike VXI-plug&play drivers, IVI drivers provide a standard interface to different classes of instruments, including oscilloscopes and spectrum analyzers.

IVI drivers have the ability to simulate instruments, automatically check ranges, and multithread safety features.

Jitter 6 sigma

Jitter 6 sigma is six times the RMS value of the edge jitter in the current horizontal units.

$$\text{Jitter 6 sigma} = 6 \times (\text{JitterRMS})$$

Jitter peak-to-peak

Jitter p-p is the peak-to-peak value for the edge jitter in the current horizontal units.

$$\text{Jitter PP} = \text{TCross1PP}$$

Jitter root mean square

Jitter RMS is the RMS value of the edge jitter in the current horizontal units.

$$\text{Jitter RMS} = \text{TCross 1sigma}$$

Lock mask

Lock Mask to Waveform resizes the mask to reflect changes in the horizontal or vertical settings of the instrument.

Logic pattern

Select the Boolean logic function for the combination of the input channels. The instrument will trigger on a clock edge when the input waveforms match the specified logic pattern.

Logic pattern inputs

The instrument input channels represent the data inputs; the channel inputs combine to form a logic pattern.

Each channel can have a value of high (H), low (L), or "don't care" (X):

- A value is considered high if the channel input voltage is greater than the specified threshold voltage.
- A value is considered low if the channel input voltage is less than the specified threshold voltage.
- Use the "don't care" selection for any channels that will not be used as part of the pattern.

Logic pattern trigger criteria

Use the Pattern drop-down list to determine when the instrument should trigger.

- Select True to trigger the instrument when the logic patterns are true.
- Select False to trigger the instrument when the logic patterns are false.

You can also specify that the pattern is true (or false) for a specified amount of time before the instrument triggers. To specify the time:

- Click in the Time entry box.
- Set the time with the multipurpose knob.

NOTE. The Time control is unavailable when you select True or False.

Logic pattern and state pattern editor (bus tab)

Use the controls to set up the Logic Pattern or the Logic State trigger pattern for the instrument to use to detect a bus value.

The maximum pattern size (number of bits) for Logic Pattern or Logic State trigger is 20 bits. The display pattern format is binary, hexadecimal, ASCII, or decimal. The pattern display format can also be symbolic. The binary pattern uses the symbols 0, 1, and X (it is a do not care bit and is not case-sensitive). The hexadecimal pattern uses the symbols 0, 1, 2, 3, 4, 5, 6, 7, 8, 9, A, B, C, D, E, F, and X. Five hexadecimal characters will convey all 20 digital inputs. The characters show up in the binary, hexadecimal, ASCII, and decimal fields. The non-selected entries are automatically populated with the correct data corresponding to what you enter in the selected entry field. An X is shown in the field when you do not enter enough characters.

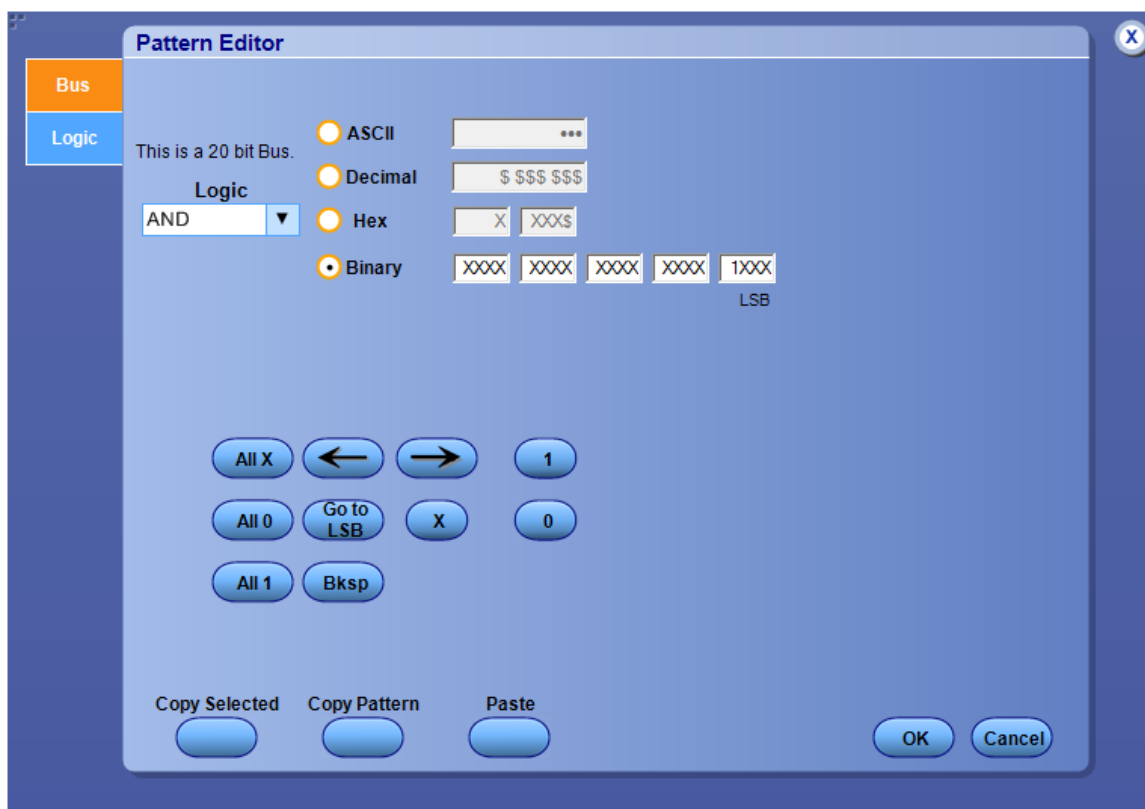

What do you want to do next?

[Learn how to set the voltage threshold level for channels used as digital waveforms and to define a pattern.](#)

[Learn about bus setups.](#)

Logic pattern and state pattern editor (digital tab)

Use the controls to set up the Logic Pattern or the Logic State trigger pattern of the channels the instrument uses as logic waveforms to detect a bus value.

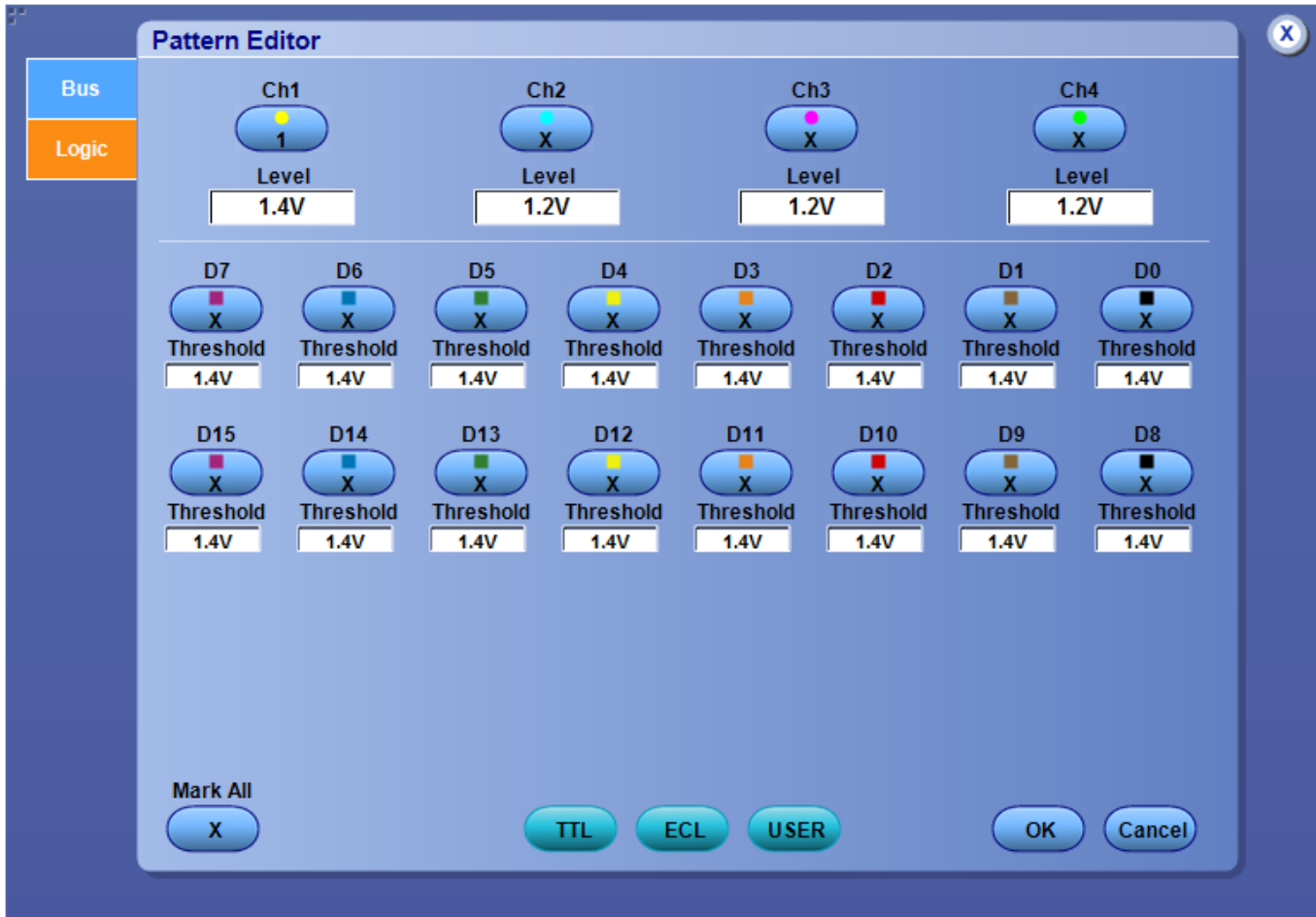

What do you want to do next?

[Learn how to define a pattern for the instrument to use to detect a bus value.](#)

[Learn about bus setups.](#)

Logic clock inputs

For the supported instruments, you need to connect one of the channel inputs to a clock signal. The instrument combines all of the channel inputs to form a logic pattern.

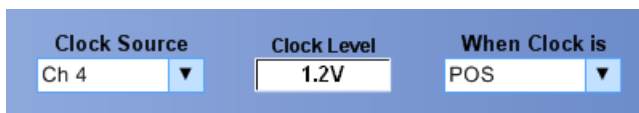

Logic pattern format

NOTE. This online help file supports many oscilloscope models from Tektronix. This feature is only available on some models.

Select the Logic Pattern or Logic State trigger type. You can change the format of the pattern after you define a logic pattern.

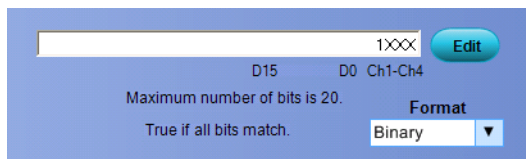

- ASCII causes the instrument to represent the bus pattern value as an ASCII value.
- Decimal causes the instrument to represent the bus pattern value as a decimal value.
- Hex causes the instrument to represent the bus pattern value as a hexadecimal value.
- Binary causes the instrument to represent the bus pattern value as a binary value.

Logic pattern setup

NOTE. This online help file supports many oscilloscope models from Tektronix. This feature is only available on some models.

Use the controls to set up the Logic Pattern or Logic State trigger pattern. Click the Edit button to access the Pattern Editor dialog box.

NOTE. The Logic Pattern or Logic State trigger setups include the D15-D0 digital channels.

For information on the Pattern Editor dialog box, click the buttons.

- [Bus Pattern](#)
- [Digital Pattern](#)

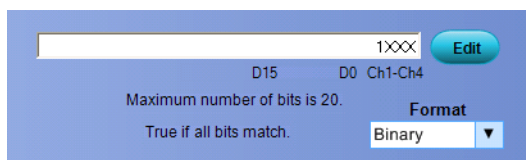

Logic state inputs

Channels 1, 2, and 3 represent the data inputs. Channel 4 should be connected to the clock signal. The channel inputs combine to form a logic pattern.

Each channel can have a value of high (H), low (L), or "don't care" (X).

- A value is considered high if the channel input voltage is greater than the specified threshold voltage.
- A value is considered low if the channel input voltage is less than the specified threshold voltage.
- Use the "don't care" selection for any channels that will not be used as part of the pattern.

Logic state trigger criteria

Use the Trigger When Pattern selection to determine when the instrument should trigger.

- Select True to trigger the instrument when the logic patterns go true.
- Select False to trigger the instrument when the logic patterns go false.

Low

The low level measurement is the value used as 0% whenever high reference, mid reference, or low reference values are needed, such as in fall time or rise time measurements.

This value can be calculated using either the min/max or histogram method. The min/max method uses the minimum value found. The histogram method uses the most common value found below the midpoint. This value is measured over the entire waveform or gated region.

Low impedance probes

Most low impedance (Z_0) passive probes measure frequencies or timing measurements more accurately than general-purpose probes, but they take less accurate amplitude measurements. They offer a higher bandwidth to cost ratio.

The low input impedance passive probes must be terminated in a 50 Ω instrument input. Input capacitance is much lower than high impedance passive probes, typically 1 pF, but input resistance is also lower (500 Ω to 5000 Ω typically). Although that DC loading degrades amplitude accuracy, the lower input capacitance reduces high frequency loading to the circuit under test. That makes low input impedance passive probes ideal for timing and phase measurements when amplitude accuracy is not a major concern. Low input passive impedance probes are useful for measurements up to 40 V.

Low reference

The Low Reference defines the low reference level of a waveform; the default level is 10%. This reference level is used with the High Reference level in the calculation of rise and fall times. To change this level, click the control and then, set the level with the multipurpose knob.

Enable mask autosegment autofit

From the Mask menu, highlight Mask Configure; then select Autosegment. From the Mask Setup control window, click the Autosegment Config button.

Overview. Use this control to minimize hits.



To use. Click the Autofit Once button to autofit the waveform after autosegment is performed.

Behavior. When Autofit is turned on, the waveform is autofitted once at the end of every autosegment. Autosegment will take longer but hits will be minimized. Autofit will only move the signal if there are mask hits.

What do you want to do next?

[Learn about trigger level autosegment.](#)

[Learn about vertical autosegment.](#)

[Learn about horizontal autosegment.](#)

Mask autosest horizontal controls

From the Mask menu, highlight Mask Configure; then select Autoset. From the Mask Setup control window, click the Autoset Config button.

Overview. Use these controls to choose whether to have autoset affect the horizontal scale or position.

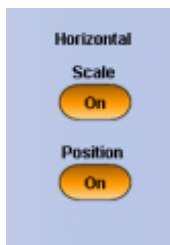

To use. Click the Scale and Position controls to turn these horizontal control functions on or off.

Behavior. Turning on the Scale or Position horizontal control functions sets up these adjustments to align the signal within the mask when autoset is done.

What do you want to do next?

[Learn about vertical autoset.](#)

[Learn about trigger level autoset.](#)

[Learn about autofit for autoset.](#)

Select the mask autoset mode

From the Mask menu, highlight Mask Configure; then select Autoset. From the Mask Testing control window, click the Autoset Config button.

Overview. Use these controls to select whether autoset will be done automatically or manually.



To use.

- Click Auto to have autoset done automatically after a standard mask is selected.
- Click Manual to make adjustments manually.

Behavior. If Auto is selected, an autoset is done automatically after a standard mask is selected. The purpose of the manual autoset mode is to adjust everything that can be done without having any waveform data.

What do you want to do next?

[Learn about trigger level autoset.](#)

[Learn about vertical autoset.](#)

[Learn about horizontal autoset.](#)

[Learn about autofit for autoset.](#)

Control the mask autoset trigger level

From the Mask menu, highlight Mask Configure; then select Autoset. From the Mask Setup control window, click the Autoset Config button.

Overview. Use this control to choose whether to have autoset affect the trigger level.



To use. Click the Trigger Level button to turn it off or on.

Behavior. When the Trigger Level control is turned on, the trigger levels are adjusted to match the signal when autoset is performed.

What do you want to do next?

[Learn about autofit for autoset.](#)

[Learn about vertical autoset.](#)

[Learn about horizontal autoset.](#)

Set mask autoset vertical controls

From the Mask menu, highlight Mask Configure; then select Autoset. From the Mask Setup control window, click the Autoset Config button.

Overview. Use these controls to choose whether to have autoset affect the vertical scale or position. You can also choose whether to have autoset affect DC compensation.

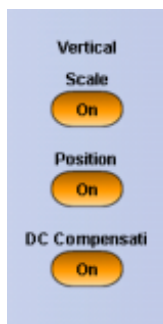

To use. Click the Scale, Position, and DC Compensation controls to turn these vertical control functions on or off.

Behavior. Turning on the Scale, Position, or DC compensation sets these vertical adjustments up to be performed on an autoset.

What do you want to do next?

[Learn about horizontal autoset.](#)

[Learn about trigger level autoset.](#)

[Learn about autofit for autoset.](#)

Mask hit count

Each mask can have a maximum of 16 segments. Segments can overlap. The number of mask hits is the sum of all hits in all segments, regardless of whether or not segments overlap. If a waveform crosses over an area where two segments overlap, both segments will count the waveform hit.

When you set Hit Count to on, the counts will appear in the [Pass/Fail Test Summary](#).

Math arbitrary filters

This section describes the library of FIR filters that are available for use under the ArbFilt <x>(< fsource waveform>) function in the Tektronix oscilloscope waveform math section. The user may find this under the path: C:\Users\[Username]\Tektronix\TekScope\Math Arbitrary Filters\<filename>. The filename of each filter identifies its type as low pass, high pass, etc and also identifies its normalized cutoff frequency or other identifying factors. The precise magnitude characteristics of these filters are shown in the following graphs. These are all linear phase filters.

You can use the [Math Equation Editor](#) to set up a waveform filter.

Low pass filters. The following graphs show the available set of low pass filters. Their normalized frequency response is shown from 0 to $\frac{1}{2}$ the sample rate. These filters will operate at any sample rate with cutoff frequency scaled as shown below on the graphs. The filters have normalized cutoff frequencies of 0.05, 0.1, 0.15, 0.20, 0.25, 0.3, 0.35, 0.40, and 0.45. Stop band rejection is typically between -50 and -60 dB.

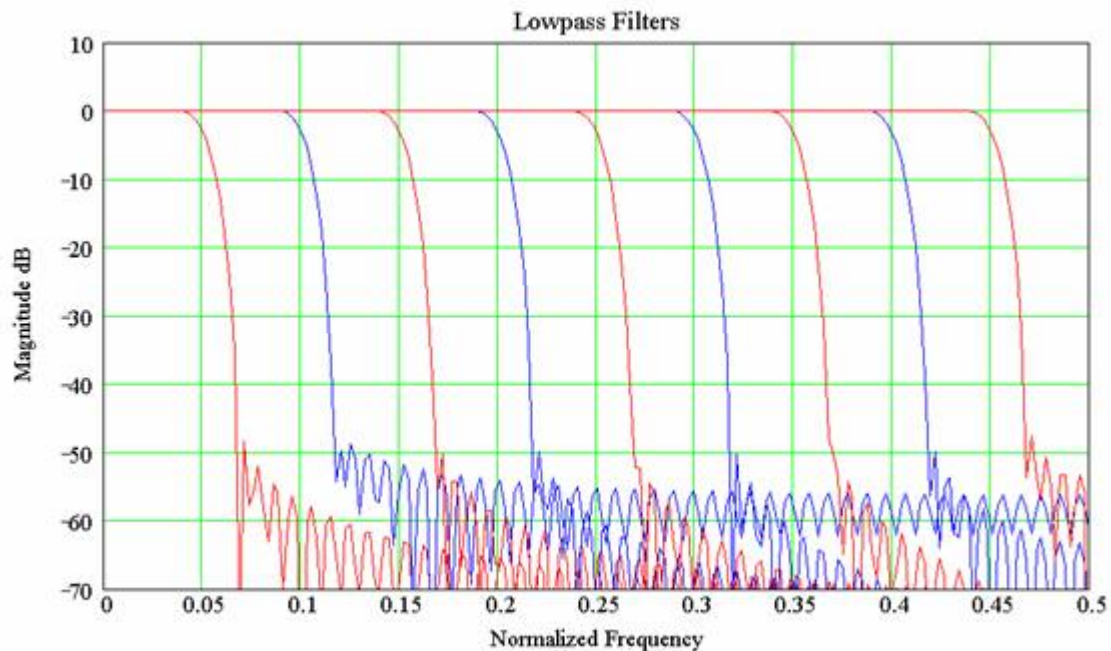

Figure 23: Frequency response of the available low pass filters

The following table lists the available low pass filters:

| File name | Normalized cutoff frequency |
|-------------------|-----------------------------|
| lowpass_0.05bw.fl | 0.05 |
| lowpass_0.10bw.fl | 0.10 |
| lowpass_0.15bw.fl | 0.15 |
| lowpass_0.20bw.fl | 0.20 |
| lowpass_0.25bw.fl | 0.25 |
| lowpass_0.30bw.fl | 0.30 |
| lowpass_0.35bw.fl | 0.35 |
| lowpass_0.40bw.fl | 0.40 |
| lowpass_0.45bw.fl | 0.45 |

High pass filters. The following graphs show the available set of high pass filters. Their normalized frequency response is shown from 0 to $\frac{1}{2}$ the sample rate. These filters will operate at any sample rate with cutoff frequency scaled as shown below on the graphs. The filters have normalized cutoff frequencies of 0.05, 0.1, 0.15, 0.20, 0.25, 0.3, 0.35, 0.40, and 0.45. Stop band rejection is typically between -50 and -60 dB.

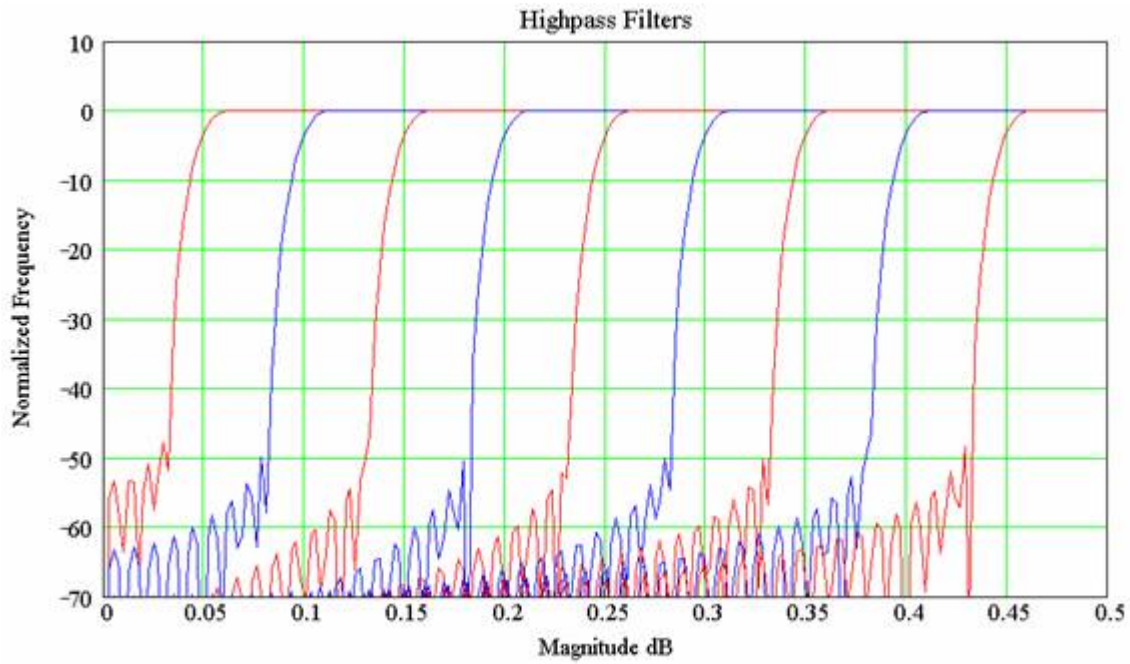
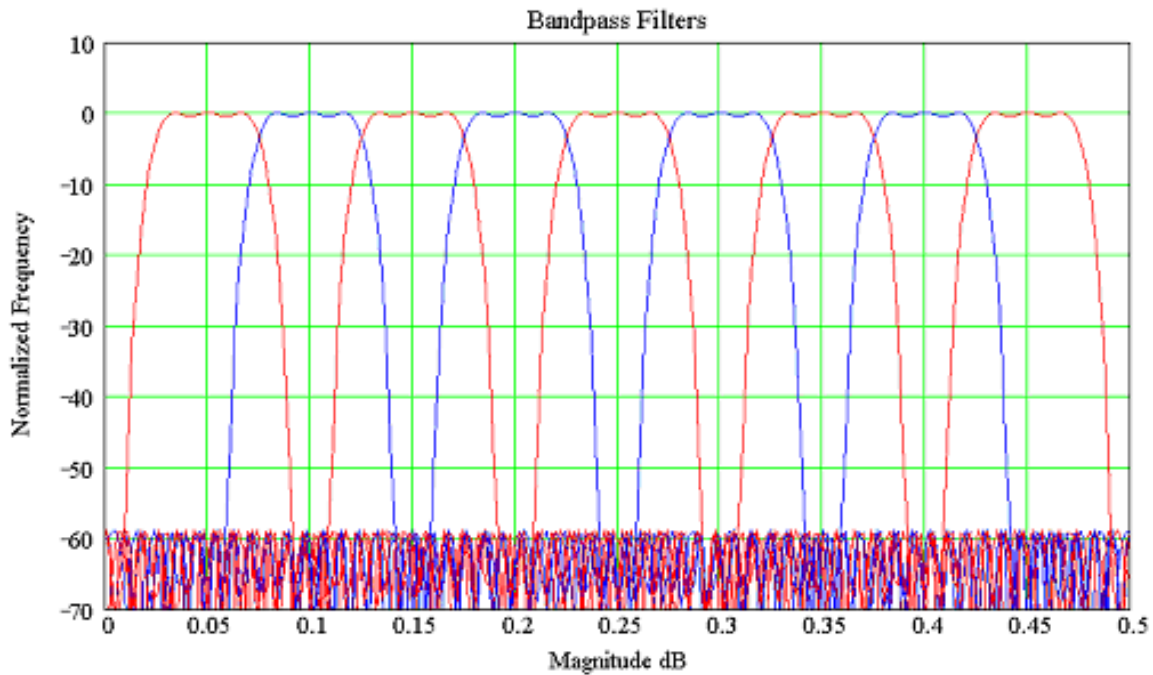

Figure 24: Frequency response of the available high pass filters

The following table lists the available high pass filters:

| File name | Normalized cutoff frequency |
|---------------------|-----------------------------|
| highpass_0.05bw.ftf | 0.05 |
| highpass_0.10bw.ftf | 0.10 |
| highpass_0.15bw.ftf | 0.15 |
| highpass_0.20bw.ftf | 0.20 |
| highpass_0.25bw.ftf | 0.25 |
| highpass_0.30bw.ftf | 0.30 |
| highpass_0.35bw.ftf | 0.35 |
| highpass_0.40bw.ftf | 0.40 |
| highpass_0.45bw.ftf | 0.45 |

Band pass filters. Each filter has a bandwidth of 0.05 times the sample rate. They will operate at any sample rate. The available center frequencies are 0.05, 0.10, 0.15, 0.20, 0.25, 0.30, 0.35, 0.40, 0.45. Stop band attenuation is approximately -60 dB and pass band ripple is around 1dB.



The following table lists the available normalized band pass filters:

| File name | Normalized bandwidth | Normalized center frequency |
|---------------------------------|----------------------|-----------------------------|
| bandpass_0.05bw_0.05center.flit | 0.05 | 0.05 |
| bandpass_0.05bw_0.10center.flit | 0.05 | 0.10 |
| bandpass_0.05bw_0.15center.flit | 0.05 | 0.15 |
| bandpass_0.05bw_0.20center.flit | 0.05 | 0.20 |
| bandpass_0.05bw_0.25center.flit | 0.05 | 0.25 |
| bandpass_0.05bw_0.30center.flit | 0.05 | 0.30 |
| bandpass_0.05bw_0.35center.flit | 0.05 | 0.35 |
| bandpass_0.05bw_0.40center.flit | 0.05 | 0.40 |
| bandpass_0.05bw_0.45center.flit | 0.05 | 0.45 |

Band stop filters. Each filter has a bandwidth of 0.1 times the sample rate. They will operate at any sample rate. The available center frequencies are 0.10, 0.15, 0.20, 0.25, 0.30, 0.35, and 0.40. Stop band attenuation is approximately -110 dB, however, the noise floor of the oscilloscope will not allow for that depth.

With an FFT and long record length, and averaging turned on, one can approach noise floors in the -110 dBm range on an 8-bit oscilloscope. However, the oscilloscope will have some spurious signals above that floor. This is possible because the FFT is an average calculation internally and the averaging function increases the vertical bits of resolution.

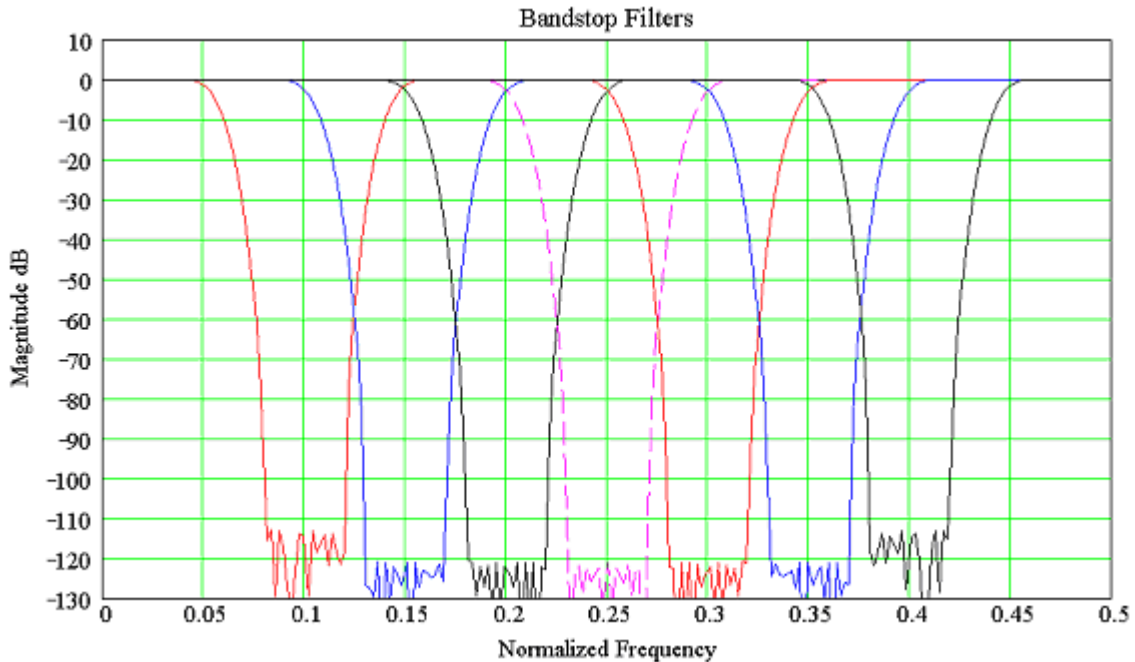

Figure 25: Frequency response of the available band stop filters

The following table lists the available normalized band stop filters:

| File name | Normalized bandwidth | Normalized center frequency |
|-------------------------------|----------------------|-----------------------------|
| bandstop_0.1bw_0.10center.ftt | 0.1 | 0.10 |
| bandstop_0.1bw_0.15center.ftt | 0.1 | 0.15 |
| bandstop_0.1bw_0.20center.ftt | 0.1 | 0.20 |
| bandstop_0.1bw_0.25center.ftt | 0.1 | 0.25 |
| bandstop_0.1bw_0.30center.ftt | 0.1 | 0.30 |
| bandstop_0.1bw_0.35center.ftt | 0.1 | 0.35 |
| bandstop_0.1bw_0.40center.ftt | 0.1 | 0.40 |

Smoothing filters. These are sometimes called box car filters. They simply average together adjacent samples along the time record. The filter coefficients for these filters are all equal to $1/M$ where M is the length of the filter. The name of the files indicates the length of the smoothing filter.

Smoothing filters are low pass filters with a somewhat less than optimal stop band characteristic. However, they are commonly used to remove high frequency noise from a displayed trace. Take care in using to insure that the pass band of the signal you are filtering is well within the pass band of the filter you choose. That will insure that only noise is removed. Lengths of 3, 5, 10, 20, 50, 100, and 200 are provided in the library. The red trace is for filter length 3, followed by blue trace at 5, followed by magenta trace for 10, and so on.

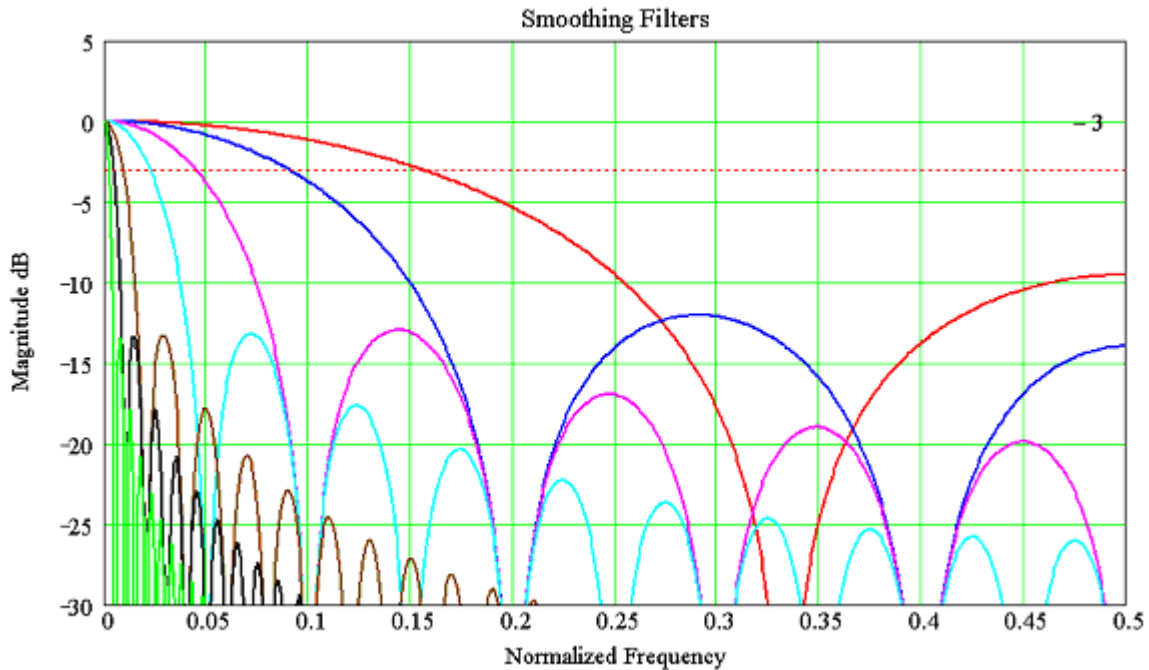

Figure 26: Frequency response of the available smoothing filters

The following table lists the available smoothing filters:

| File name | Length | Normalized bandwidth | Stop band attenuation dB |
|---------------|--------|----------------------|--------------------------|
| smooth3.ftt | 3 | 0.1558 | -9.4 |
| smooth5.ftt | 5 | 0.0903 | -12 |
| smooth10.ftt | 10 | 0.0446 | -12.9 |
| smooth20.ftt | 20 | 0.0224 | -13.2 |
| smooth50.ftt | 50 | 0.00887 | -13.2 |
| smooth100.ftt | 100 | 0.0045 | -13.2 |
| smooth200.ftt | 200 | 0.0022 | -13.2 |

Hilbert transform filter. The ideal Hilbert transform filter has a gain of one at all frequencies and shifts the phase of all frequencies by 90 degrees. This type of filter is one of the types that may be specified in the Remez Exchange algorithm. This filter departs from its desired behavior in the frequency range of 0 to 0.025 times the sample rate and also in the range of about 0.475 to 0.5 times the sample rate. This type of filter can be used to create quadrature signals over a wide frequency range. The filename for this filter is HilbertTransform90PhaseShift.flit.

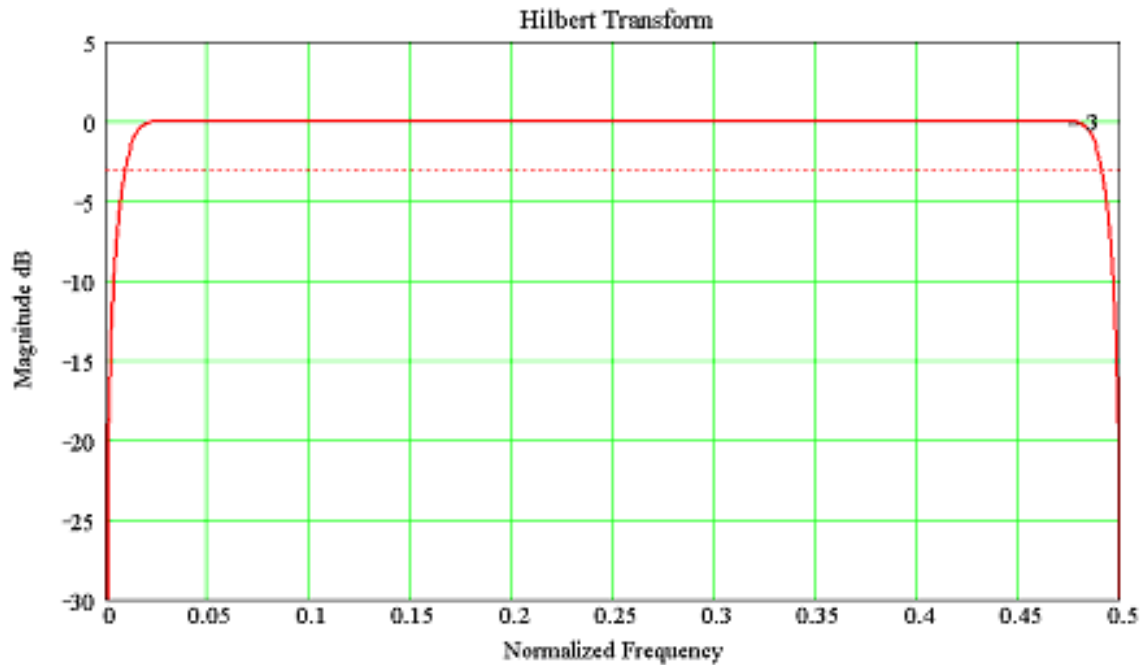

Figure 27: Frequency response of the Hilbert transform filter

Differentiator. The ideal differentiator is a high pass filter that shifts phase by 90 degrees and its' frequency response would be linear from DC to 0.5. Since this is not easily realized, the filter provided in the library makes a good differentiator for the frequency range of DC to 0.45.

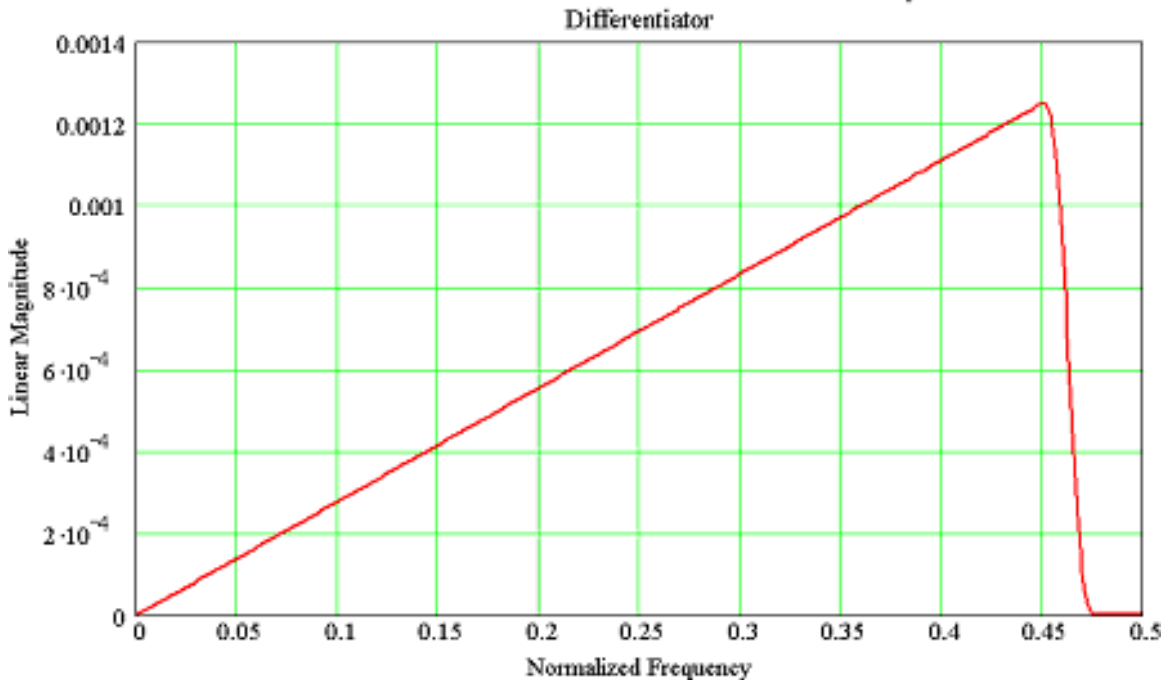

Figure 28: Frequency response of the differentiator filter

This section describes the ASCII file format for storing filters for use in the Tektronix oscilloscope waveform math section. A filter menu function allows the user to specify a disk file name containing the filter. A single file format allows the user to specify a different set of coefficients for each sample rate that the filter operates at. If the desired sample rate is not in the file list, then the filter will not be applied to the data. The file format also allows the user to specify that the set of filter coefficients is normalized. This allows the same set of filter coefficients to operate at all sample rates.

The ASCII file format is specified as follows:

```
# Comments are preceded by # symbol
< sampleRate > coef1, coef2, ..., coefN
< sampleRate > coef1, coef2, ..., coefN
| |
| |
< sampleRate > coef1, coef2, ..., coefN
```

Each set of filter coefficients in a file are specified in one row preceded by the sample rate value at which that set will operate. If the user specifies the @ symbol for the sample rate then the filter will operate at all sample rates. If the @ symbol is specified then there should only be one set of filter coefficients in the file. However, the user may have other rows with sample rates specified and they will be ignored. There will be a separate row for each sample rate the filter is to operate at. Each row may have a different number of coefficients with a maximum of 1000. The file may contain up to 20 rows.

An example of file content for a normalized filter is shown below. This example is the contents of the smooth5.ftt file:

```
@ 0.2, 0.2, 0.2, 0.2, 0.2
```

An example of a filter that is setup to operate at a specific sample rate is given as follows. This is the contents of a file named 200MHz_mult_sample_rates.ftt that is included in the library directory on the oscilloscope.

```
#This is a 4th order Bessel Thompsen low pass filter.
#200MHz bandwidth, will operate at any of the following sample rates:
# 40 GS/s, 20 GS/s, 10 GS/s, 5 GS/s, 2.5 GS/s, 1 GS/s, 500 MS/s
5e8; 1.968e-007,1.008,-0.00978,0.002267,-0.0002208,1.643e-005,-1.397e-006,1.434e-007
1e9; 9.524e-008,0.3899,0.4877,0.1304,-0.004733,-0.004566,.....
2.5e9; 3.868e-008,0.01885,0.1081,0.1982,0.2284,0.1981,.....
5e9; 1.935e008,0.0007332, 0.009428, 0.02874, 0.05408, 0.07921, .....
1e10; 9.673e-009,3.445e-006,0.0003666,0.001831,0.004714,0.008978,0.01437,0.....
2e10; 4.837e-009, 1.657e-008, 1.723e-006, 4.274e-005, 0.00018334-009, .....
4e10; 2.418e-009, -3.524e-009, 8.284e-009, -1.795e-008,8.613e-007, .....
```

Enter a math expression

From the Math menu, select Equation Editor, or click the Editor button in the Math Setup or Spectral Setup control windows.

To use.

- Select a Math <1-4> waveform from the drop-down list.
- Click in the readout field to enter the math expression.
- Click a button to enter its character or operator into the expression.
- Click the Editor button and use the Math Equation Editor controls to insert numerals, math operators, and variables into a math expression.
- Use the [Text Edit Controls](#) to move the insertion point (cursor) within the expression.

Behavior. The characters are entered into the math expression one at a time.

What do you want to do next?

[Learn about the Math Setup controls.](#)

[Learn about averaging math waveforms.](#)

Display a math equation

From the Math menu, select Equation Editor, or click the Editor button in the Math Setup or Spectral Setup control windows.

To use.

- Click Off/On to turn the math waveform display on and off.
- Click Avgs to open the [Adjust Math Parameters](#) control window. Use this window to define the number of times you want to average the selected math waveform.

Behavior. These controls only affect the selected math waveform.

What do you want to do next?

[Learn about the Equation Editor.](#)

Set the math display and vertical controls

From the Math menu, select Math Setup.

To use.

- Click a Math <1-4> tab to identify a math waveform.
- Click in the Math <1-4> = data entry field to enter the math expression, or select a [predefined expression](#).
- Click Off/On to turn the math waveform display on and off.
- Click Avgs to open the [Adjust Math Parameters](#) control window. Use the Math Parameter control window to define the number of times that you want to average the selected math waveform.
- Click in the Vertical Control entry boxes and use the multipurpose knobs to change the vertical position and scale of the selected math waveform.
- Use the Label entry box to attach a meaningful label to the waveform.
- Use the Units to assign custom vertical units for each math waveform.
- Click the Logic Properties button and open the [Logic Threshold Setup](#) menu to set the thresholds for each channel or math waveform.

Behavior. These controls only affect the selected math waveform. The Position control increases or decreases the vertical position of the waveform one pixel at a time. The Scale control changes the displayed waveform only; it has no effect on the acquisition hardware.

 **TIP.** To open the Math Equation Editor, double-click in the math expression field or click the Editor button.

NOTE. If Autoscale is not checked, vertical scale and position are not calculated when a math waveform is turned on or the math equation is changed.

What do you want to do next?

[Learn about the Equation Editor.](#)

Maximum

This voltage measurement is the maximum amplitude. It is typically the most positive peak voltage and is measured over the entire waveform or gated region.

Mean

This voltage measurement is the arithmetic mean over the entire waveform or gated region.

Set up a histogram measurement

From the Measure menu, select Measurement Setup; then open the Histog tab.

To use. Use the Histogram tab to select automatic histogram measurements.

1. Select a source with the [Channels Selector](#).
2. Click a Measurements button to add a Histogram measurement to the Measure list:

| Histogram measurements | | | |
|------------------------|--------|--------|---------|
| WfmCt | Median | Pk-Pk | U+ /-1S |
| Hits in Box | Max | Mean | U+ /-2S |
| Peak Hits | Min | St Dev | U+ /-2S |

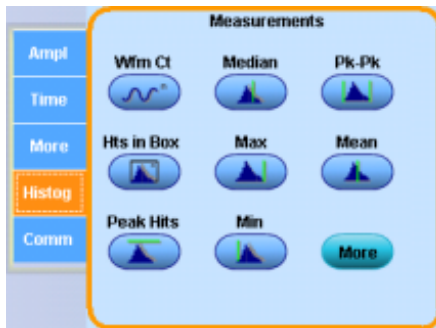

3. Click Display On in the upper-right corner of the [Measurement Setup Control Window](#) to turn the measurement display on and off.

Behavior. Measurements are updated approximately three times a second, or less for long record lengths. Measurements are calculated after each acquisition. You can display up to eight automatic measurements.



TIP. Select the individual measurements directly from the Measure menu Histogram Measurements submenu.

What do you want to do next?

[Learn about taking amplitude measurements.](#)

[Learn about taking timing measurements.](#)

[Learn about other measurements.](#)

[Learn about communications measurements.](#)

[Learn more about the Measurements list.](#)

[Learn more about the Measurement controls.](#)

Waveform count

Displays the number of waveforms that have contributed to the histogram.

Hits in Box

Displays the number of points in or on the histogram box.

Peak Hits

Displays the number of points in the largest bin of the histogram.

Median

The middle point of the histogram box. Half of all acquired points within or on the histogram box are less than this value and half are greater than this value.

Histogram Max

Displays the voltage of the highest nonzero bin in vertical histograms or the time of the rightmost nonzero bin in the horizontal histograms.

Histogram Min

Displays the voltage of the lowest nonzero bin in vertical histograms or the time of the leftmost nonzero bin in the horizontal histograms.

Pk-Pk

Displays the peak-to-peak value of the histogram.

- Vertical histograms display the "voltage" of the highest nonzero bin minus the "voltage" of the lowest nonzero bin.
- Horizontal histograms display the "time" of the rightmost nonzero bin minus the "time" of the leftmost nonzero bin.

Histogram Mean

Measures the average of all acquired points within or on the histogram box.

StdDev (standard deviation)

The standard deviation (Root Mean Square (RMS) deviation) of all acquired points within or on the histogram box.

Mean \pm 1 StdDev

The percentage of points in the histogram that are within one standard deviation of the histogram mean.

Mean \pm 2 StdDev

The percentage of points in the histogram that are within two standard deviations of the histogram mean.

Mean \pm 3 StdDev

The percentage of points in the histogram that are within three standard deviations of the histogram mean.

Set up the measurement list

From the Measure menu, select Measurement Setup.

To use.

- To add a measurement to the list, select the waveform type (Channel, Math, or Reference), and then click one of the Measurements buttons.
- To delete a measurement, select the measurement, and then click Clear Selected.
- To delete all measurements, click Clear All.
- Click Annotations to quickly select a measurement already included in the list.
- Click Display in the upper-right corner of the control window to turn the measurement displays on and off.

| Measure | Source |
|---------|--------|
| | |
| | |
| | |
| | |
| | |
| | |
| | |
| | |

Behavior. This list contains your selected automatic measurements. You can add up to eight automatic measurements to the list. The measurements appear on the main screen when the Display button is On.

When you click Clear without selecting a measurement, the last measurement in the list is deleted.



TIP. To quickly move the measurements from one channel to another, select all of the measurements in the list (click the first measurement, hold the left mouse button, and drag the mouse to the last measurement), and then select a new channel from the Source control. Similarly, you can change all of the measurements from one type to another if you select all the measurements in the list and click on a single measurement button.

What do you want to do next?

[Learn more about the Measurement controls.](#)

[Return to the Measurement Setup control window overview.](#)

Minimum

This voltage measurement is the minimum amplitude. It is typically the most negative peak voltage and is measured over the entire waveform or gated region.

Natural antilog

1. Inserts the text EXP(into the math expression.
2. Enter an argument to the function.

The natural antilog function raises e to the power of the argument.

Negative duty cycle

This timing measurement is the ratio of the negative pulse width to the signal period expressed as a percentage. The duty cycle is measured on the first cycle in the waveform or gated region.

$$\text{Negative Duty Cycle} = ((\text{Negative width}) \div \text{Period}) \times 100\%$$

Negative overshoot

This voltage measurement is measured over the entire waveform or gated region and is expressed as:

$$\text{Negative Overshoot} = (\text{Low} - \text{Minimum}) \times \text{Amplitude} \times 100\%$$

Negative width measurement

This timing measurement is the distance (time) between the mid reference (default 50%) amplitude points of a negative pulse.

The measurement is made on the first pulse in the waveform or gated region.

Noise peak-to-peak

Noise p-p is the peak-to-peak value of the noise of the top or base of the signal as specified by you.

To ensure accurate noise values, be sure to set the signal type to Eye when measuring an Eye signal.

$$\text{Noise Pk-Pk} = \text{PToppk-pk or PBasepk-pk}$$

Noise root mean square

Noise RMS is the RMS value of the noise of the top or base of the signal as specified by you.

To ensure accurate noise values, be sure to set the signal type to Eye when measuring an Eye signal.

$$\text{Noise RMS} = \text{PTopsigma or PBasesigma}$$

Normal trigger mode

Normal trigger mode causes the instrument to wait for a valid trigger event before displaying waveform data. Normal trigger mode is most useful during single-shot acquisitions.

Nyquist frequency

The highest frequency that any digital oscilloscope can measure without errors is one-half of the sample rate or frequency. This frequency is called the Nyquist frequency.

The FFT waveform displays the input signal frequency components from DC (0 Hz) to the Nyquist frequency.

Set up zoom AutoScroll

From the Vertical or Horiz /Acq menu, select Zoom Controls; then open the Scroll tab.

Overview. Use the AutoScroll control window to set the scroll speed and lock zoomed areas together.



To use.

- To scroll a single zoomed area, open the Zoom tab and select the zoom area (1–4).
- Open the Scroll tab and click an Auto Scroll arrow button.
- Click in the Scroll Speed entry box, and then use a multipurpose knob to set the scroll speed.
- To scroll multiple zoomed areas simultaneously, click Lock, and then click the zoomed areas (1–4) you want to scroll through. This locks the zoomed areas in their relative horizontal positions.

Behavior. If the zoom areas are unlocked, the Horizontal Position and Factor controls affect only the selected zoom area. The Horizontal Position and Factor will affect all zoom areas that are locked together, such that a change to one zoom area will change the horizontal position and factor of all the locked zoom areas.

What do you want to do next?

[Learn about the Zoom Setup controls.](#)

[Return to the Vertical Setup control window overview.](#)

[Return to the Horizontal Setup control window.](#)

[Learn about the Zoom Control window.](#)

Set the cursor position (XY display)

From the Cursor menu, select Cursor Position.

Overview. Use the Cursor Position control window to position the cursors with the multipurpose knobs.



To use.

1. Click the Source drop-down list to select the measurement source for the cursor.
2. Click in one of the cursor position entry boxes and use a multipurpose knob to enter the cursor position.

Behavior. The cursor units depend on the cursor type. The cursor position readouts appear on the display graticule. When using the IRE graticule style, amplitude cursor readouts are shown in IRE units.

Cursor position does not change if the cursor source changes or if the waveform is repositioned.



TIP. Use the pop-up keypad or your external keyboard to specify exact numerical cursor coordinates.

What do you want to do next?

[Learn about the Cursor Setup controls.](#)

[Learn about the cursor types.](#)

Set display persistence

From the Display menu, highlight Display Persistence; then select Persistence Controls.

To use. Click one of the buttons to select the display persistence.

- Click Infinite (persistence) to continuously accumulate record points on the waveform until you change one of the acquisition display settings.
- Click Variable; then click in the Time entry box and use the multipurpose knobs to set the persistence time.
- Click Reset to clear the persistence.
- Click Controls to activate the Persistence Control window.
- Click Setup to open the Display control window.



Behavior.

- Use infinite persistence for displaying record points that may occur outside the normal acquisition envelope.
- Use Variable to accumulate record points on the waveform for a specified time interval. Each record point decays independently according to the time interval.
- If you click Off, the waveform record points appear for the current acquisition only.



TIP. Use the Display menu Display Persistence submenu or right-click in the graticule and select Display Persistence from the shortcut menu to directly access the persistence options.

What do you want to do next?

[Learn about changing the display colors.](#)

[Learn about using text with screen displays.](#)

[Learn about changing the appearance of objects in the display.](#)

Set the FastFrame analyze tab controls

From the Horiz /Acq menu, select FastFrame; then open the Analyze tab.

Overview. Use the *FastFrame Control Window* Analyze tab to select the viewing frame (Selected Frame) when FastFrame is turned on. You can also select the reference frame.

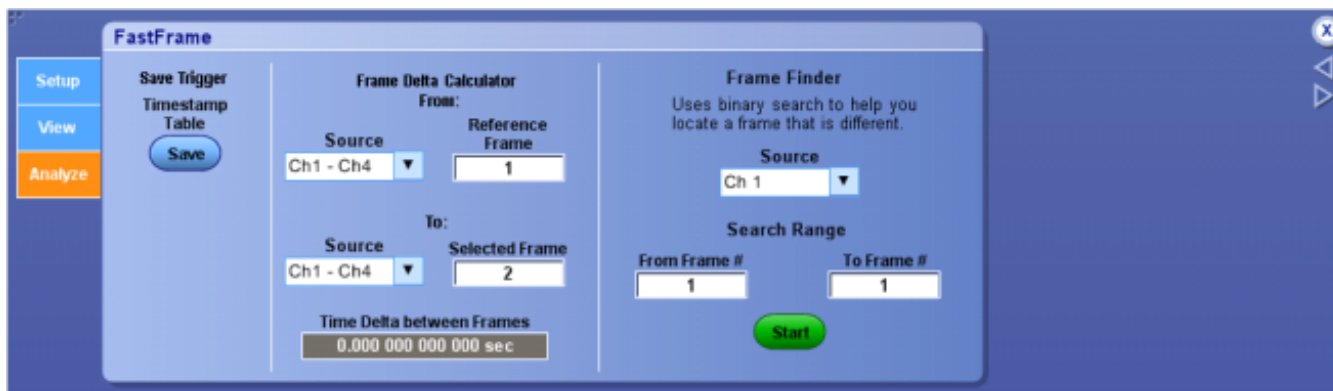

To use.

1. Select the Source channel from the drop-down list, and then use the multipurpose knob to select the Reference Frame.
2. Select the Source channel from the drop-down list, and then use the multipurpose knob to identify the Selected Frame.
3. Click the *Timestamp* Table Save button to display the Save As dialog box and save FastFrame time stamps in a table format.

Behavior. The Selected Frame displays the frame of interest. The Selected Frame can use any Channel, Math, or Reference waveform as the source waveform. The instrument will display one frame at a time. You can use the Selected Frame control to scroll through all of the frames until you find the frame of interest.



TIP. Use the Reference frame to establish a reference frame when using time stamps. You can view the time stamps by turning on the readouts.

Time delta between frames. You can calculate the Time Delta (differences) between Frames and display those differences. These time stamps are displayed in a format that shows the date and time. The Timestamp Table displays the current time stamps and readout information. This table is read-only.

Frame

A frame is a segment of the entire data record. When used with FastFrame, each segment contains all of the data of a single acquisition. Each captured event is stored sequentially in its own frame. The frames appear in the order they were captured.

Time stamp readout format

The Time Stamp readouts are displayed in the following format:

Day/Month/Year/ Hours/Minutes/Seconds/ Milliseconds/Microseconds/Nanoseconds/Picoseconds

Frame finder. Set up the Frame Finder to search for individual frames; then click Start to initiate the search.

What do you want to do next?

[Go to the Horizontal Setup control window.](#)

[Return to the Acquisition Setup control window.](#)

Time stamps. Time stamps are a convenient way of measuring the time between triggers when using FastFrame.

Set up FastFrame setup tab controls

From the Horiz /Acq menu, select FastFrame Setup; then open the Setup tab.

Overview. Use the [FastFrame Control Window](#) Setup tab to select the event Duration and Frame Size when FastFrame is turned on.

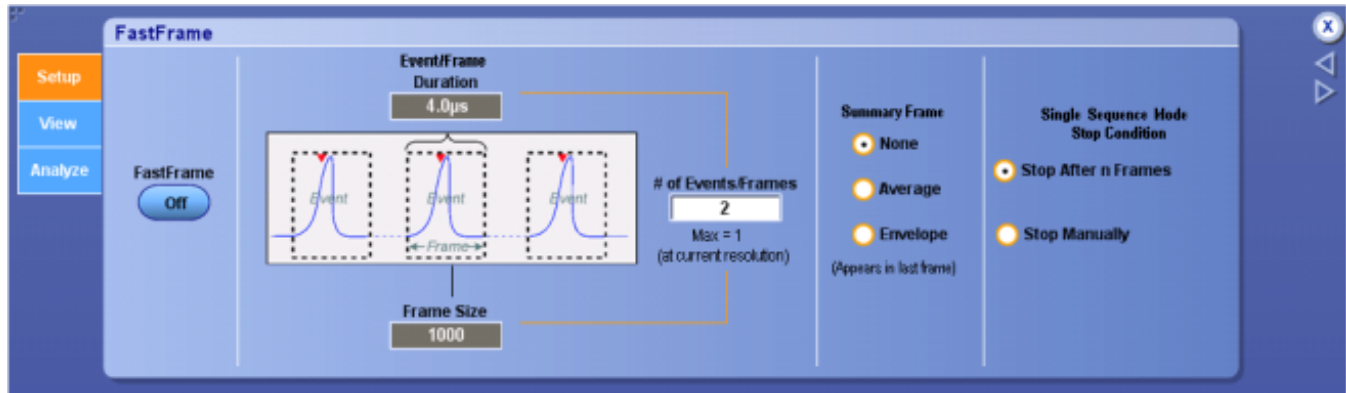

To use.

1. Click the FastFrame button to turn FastFrame mode On or Off.
2. Click in the Event/Frame entry boxes and use the multipurpose knobs to select the Frame Size, Duration, and the Number of Events/Frames.
3. Click a None, Average, or Envelope option button from the Summary Frame list to replace the last frame with one that is the computed, average or envelope, of all frames in the set.
4. Click a Single Sequence Mode Stop Condition option button to define how to stop FastFrame acquisition.
5. Start the acquisition; it is recommended that you use Single acquisition mode rather than Run/Stop mode.

NOTE. If you change the oscilloscope controls while Fastframe is running, the controls will be returned to the user and the maximum number of frames may not be captured.

Behavior. The Frame Size is the record length and defines the number of samples in each frame.

The Event/Frame Duration defines the number of frames to store in the acquisition memory of a single channel. The product of the frame size and the event/frame duration is constrained within the available memory. If more frames are needed, the instrument will automatically decrease the record length; if more samples are needed, the instrument will automatically decrease the frame count.

NOTE. Because of the overhead associated with each frame, the maximum number of frames the instrument can capture (from a given record length) is less than the number theoretically possible.

What do you want to do next?

[Learn about the Reference Frame and time stamps.](#)

[Learn some tips for using FastFrame.](#)

Set up FastFrame view tab controls

From the Horiz /Acq menu, select FastFrame; then open the View tab.

Overview. Use the *FastFrame Control Window* View tab to specify how to view frames when FastFrame is turned On.

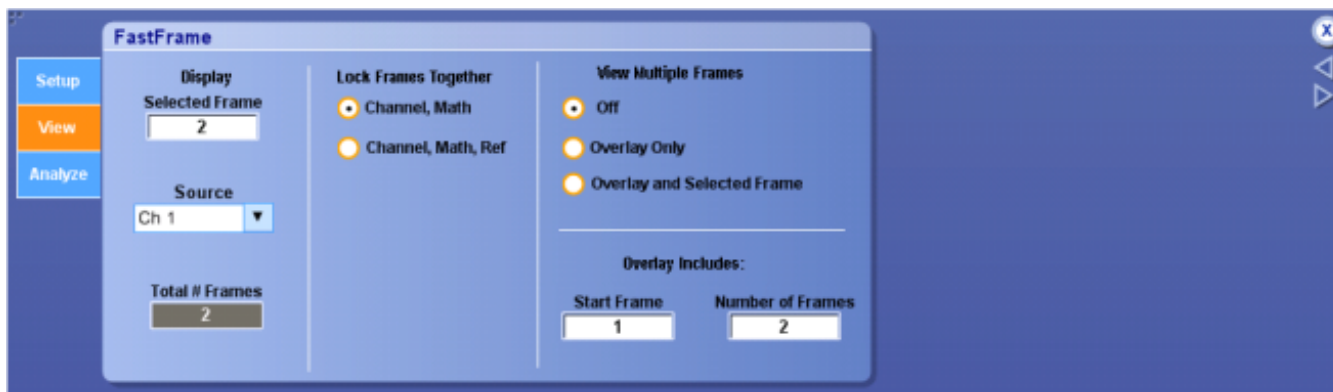

To use.

1. Select the Source channel from the drop-down list, and then use the multipurpose knob to identify the Selected Frame.
2. Click either the Channel, Math or Channel, Math, Ref option buttons to determine which frames you want to lock together.
3. Click a View Multiple Frames option button to toggle this function between Off, Overlay Only, or Overlay and Selected Frame. When Overlay is selected, two additional fields are displayed: Start Frame and Number of Frames. These fields allow you to select a range of frames that are displayed in the color of the Source channel.

NOTE. In *Overlay Only*, the frames are superimposed over each other. The *Selected Frame* is displayed in blue unless you are using the *Spectral* or *Temperature* palette; then the selected waveform is displayed in the same color as the other frames. The instrument does not support *Overlay and Selected Frame* view when the display format is set to *XYZ*.



TIP. You may find it difficult to distinguish the dark blue *Selected Frame* if you have previously selected *Spectral* or *Temp* for the *Color Palette*.

Behavior. The Selected Frame displays the frame that you want to view. You can use the MultiView Zoom features of the instrument to magnify the waveform of interest. The Selected Frame can use any Channel, Math, or Reference waveform as the source waveform.

When View Multiple Frames is off, the instrument will display one frame at a time. You can use the Selected Frame control to scroll through all of the frames until you find the frame of interest.

When you click a Lock Frame Together <Channel, Math> option button, the channel and math waveforms are locked together. Adjusting a channel waveform also adjusts a related math waveform. All reference waveforms are locked together, but they are separate from channel and math waveforms.

When you set the Selected Frame Source Ch1 to Frame 3, then the Selected Frame Ch2, Ch3, Ch4, Math1, Math2, Math3 and Math4 are also set to frame 3. When you set the Selected Frame Source Ref1 to Frame 2, then the Selected Frame Ref2, Ref3, and Ref4 are also set to Frame 2.

To lock the reference and all selected frames together, click the Lock Frames Together <Channel, Math, Ref> option button. When these frames are locked, they maintain the same relative distance from each other as you adjust either frame. For example: if channels and maths are set to frame 2, and references are set to frame 3, then after selecting Lock <Channel, Math, Ref>, an increment of 1 frame will cause channels to display frame 3 and references to display frame 4.

When you click the View Multiple Frames <Overlay> button, the Start Frame and the Number of Frames fields are displayed. Use the upper multipurpose knob to enter the Start Frame (first frame) in the frame sequence that you want to view. Use the lower multipurpose knob to enter the total number of frames that you want to view.

For example, if you have 1000 frames and you want to view frames 75 through 100, use the upper multipurpose knob to enter 75 in the Start Frame field and the lower multipurpose knob to enter 26 in the # of Frames field. The result of these settings is that frames 75 through 100 are displayed superimposed over each other in the color of the selected Source, and the current (selected frame) is displayed superimposed in dark blue, unless you are using the Spectral or Temperature color palette.

What do you want to do next?

[Learn about the reference frame and time stamps.](#)

[Learn some tips for using FastFrame.](#)

Select waveform save options

From the File menu, highlight Save As; then select Waveform from the submenu. In the Save As dialog box, click the Waveform Options button.

Overview. Use the Waveform Save Options dialog box to set the parameters for the waveform you want to save.

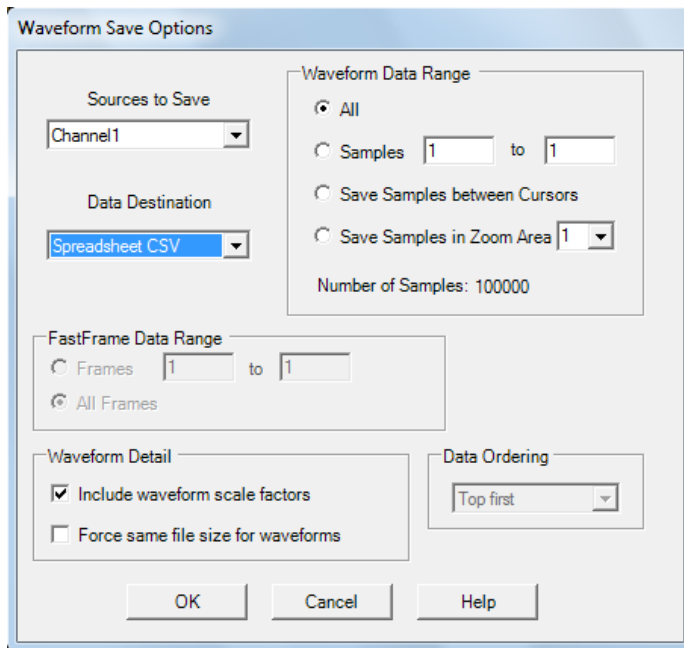

To use.

1. Select the data format (Data Destination) for the waveform you want to save:
 - a. Select Spreadsheet (TXT) to include spreadsheet data separated by white space.
 - b. Select Spreadsheet (CSV) to include spreadsheet data separated by commas.
 - c. Select Mathcad or Matlab to save the waveform in Mathcad or Matlab format.
 - d. Select TekWaveform (*.wfm) to save the waveform in the TekScope waveform format. When waveform is selected, save waveform options like waveform data range, FastFrame data range, waveform detail and data ordering are disabled.
 - e. Select HDF5 (*.h5) to save the waveform in HDF5 format. HDF5 saves the entire waveform. When HDF5 is selected, save waveform options like waveform data range, FastFrame data range, waveform detail and data ordering are disabled.
2. Select a valid waveform from the Sources to Save list: Channel <1–4>, Math <1–4>, Ref <1–4>, All Digital, All Analog, All Math, or All Displayed Sources.
3. Select the number of samples you want to save under Waveform Data Range:
 - a. Select a range of samples.
 - b. Select only the Samples between Cursors. If you select Samples between Cursors, you can use the multipurpose knobs to adjust the positions if the cursors are already active. If they are not, the cursors are activated in their most recent positions.
 - c. Select only Samples in Zoom Area.
 - d. Select All samples.
4. If the waveform is a FastFrame waveform, specify the FastFrame Data Range.
5. Click the Include waveform scale factors check box if you want to include waveform details like header information (record length, sample interval, trigger point information, and so on). If you only want to include the waveform voltage values, clear the selection.
6. If you are saving Fast Acquisition data, select the Data Ordering from the drop-down list.
7. Click OK to return to the [Save As dialog box](#), where you can assign your own file name and save the waveforms to a specified folder. By default, the file is saved to the C:\Users\[Username]\Tektronix\TekScope\waveforms folder. If the information is saved as a CSV file, then the file is saved to the C:\Users\[Username]\Tektronix\TekScope\data folder by default.

Behavior. The waveform data is saved as numeric values. The data destination you select here is the file type selection used in the Save As dialog box. Use the Save As dialog box to finalize the selections and to save the waveform to a file. Options are grayed out if they are not available with the currently selected data destination.

What do you want to do next?

[Learn about saving waveforms.](#)

[Learn more about CSV text format.](#)

CSV text format

In the Tektronix oscilloscope, you can save the waveform data generated in CSV format. You can import this waveform data into an Microsoft Excel spreadsheet for analysis. The waveform data occupies five columns in the spreadsheet.

NOTE. Do not enter math formulas or other data in the first 3 columns. Data in the first 3 columns is deleted if you paste new waveform data into the spreadsheet.

The first column is the name of the parameter (such as Record Length, Sample Interval, Trigger Point, and Trigger Time), the second column is the value of the parameter, the third column is the unit associated with each of the parameters, the fourth column is the time of the waveform sample relative to the trigger point, and the fifth column is the value of the sampled waveform that was converted from the oscilloscope's internal digitizing levels.

time = sample interval * (index – trigger point)

Where:

sample interval = the Sample Interval from column two

index = the sample number of the sample being calculated

trigger point = the sample number of the Trigger Point

The information in the first to fourth columns is generated only if you select the Include waveform scale factors option and when you paste or export data.

Deselect the Include waveform scale factors option when you want to analyze and/or plot the data for several waveforms captured with the same setup on a given instrument. The values in the first to fourth columns are same for all the waveforms. So you need to export these columns only once.

Set mask test controls

From the Mask menu, select Mask Controls. You can also click the Controls button in the Mask Testing - Pass/Fail Setup or Mask Testing - Pass/Fail Results control windows.

Overview. Use this control window to run a test and view the results. You can also reset or start the test and return to the Mask Setup control window from this control window.



To use.

- Click On/Off to start and stop the test.
- Click Reset to reset the test.
- Click the drop-down arrow in the Test Summary field to select a different source. Status, Total Hits, and Failed Wfms are read only fields.
- Click Setup to return to the Mask Setup control window.

Behavior. This control window allows a mask test to run on a full screen and still provide access to the start, stop and reset functions. In addition, you can see the test summary for each input selected.

What do you want to do next?

[Learn about test summary.](#)

[Learn about hits per segment.](#)

[Learn about test results.](#)

Set up a delay measurement

From the Measure menu highlight Time; then select Delay from the submenu, or open the Time tab in the Measurement Setup control window and click the Delay button under Measurements.

Overview. Use the Delay Measurement control window to set up the instrument to measure the delay between two waveforms.

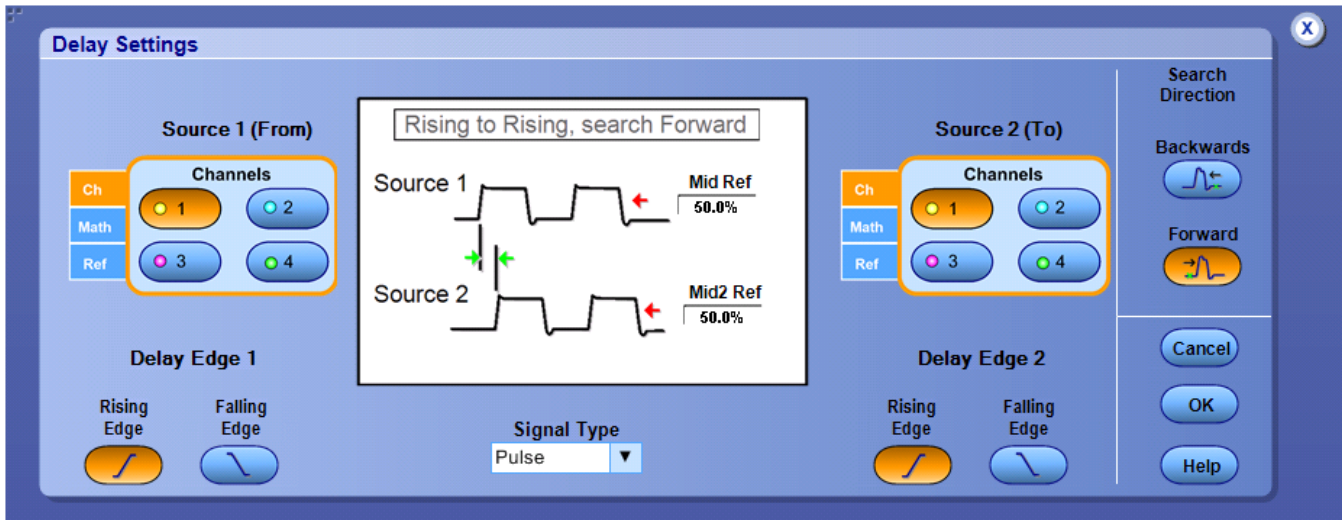

To use.

1. Select the source waveforms from the [Channels Selector](#).
2. Use the other controls in the control window to select the Delay Edges, Mid Reference point, Mid2 Reference point, and to specify the Search Direction.
3. Click OK to add the measurement to the measurement list, or click Cancel to cancel the measurement and return to the Measurement control window.

Behavior. This timing measurement is the time between the mid reference crossing of two different waveforms, or the gated region of the waveforms.

The graphic in the control window shows the points on the waveforms from which the delay measurement will be taken. The graphic is updated each time you change the control settings. The Delay direction controls only apply to Source 2. When you click Forward, the instrument starts searching for the desired edge at the beginning of the record. When you click Backwards, the instrument starts searching for the desired edge from the end of the record. If the edge for Source 1 is before the edge for Source 2, then the delay is greater than zero. Otherwise the delay is less than zero.

Mid reference. The Mid reference defines the middle reference level of a waveform; the default level is 50%. This reference value is primarily used for making measurements between edges such as pulse widths. To change this level, click the control, and then set the level with the multipurpose knob.

Mid2 reference. The Mid2 reference defines the middle reference used on the second waveform specified in delay or phase measurements; the default level is 50%. To change this level, click the control, and then set the level with the multipurpose knob.

What do you want to do next?

[Learn about taking amplitude measurements.](#)

[Learn about taking histogram measurements.](#)

[Learn about other measurements.](#)

[Learn about taking communications measurements.](#)

[Learn more about the Measurements List.](#)

Delay edges

The Delay Edge buttons determine whether the measurements will be taken on the rising or falling edge of the waveform. After selecting an edge, the graphic in the control window is updated to show the edge from which the measurements will be taken.

Set up a phase measurement

From the Measure menu highlight More; then select Phase from the submenu. You can also open the More tab in the Measurement Setup control window, and then click the Phase button under Measurements

Overview. Use the Phase Measurement Setup control window to set up the instrument to take phase measurements.

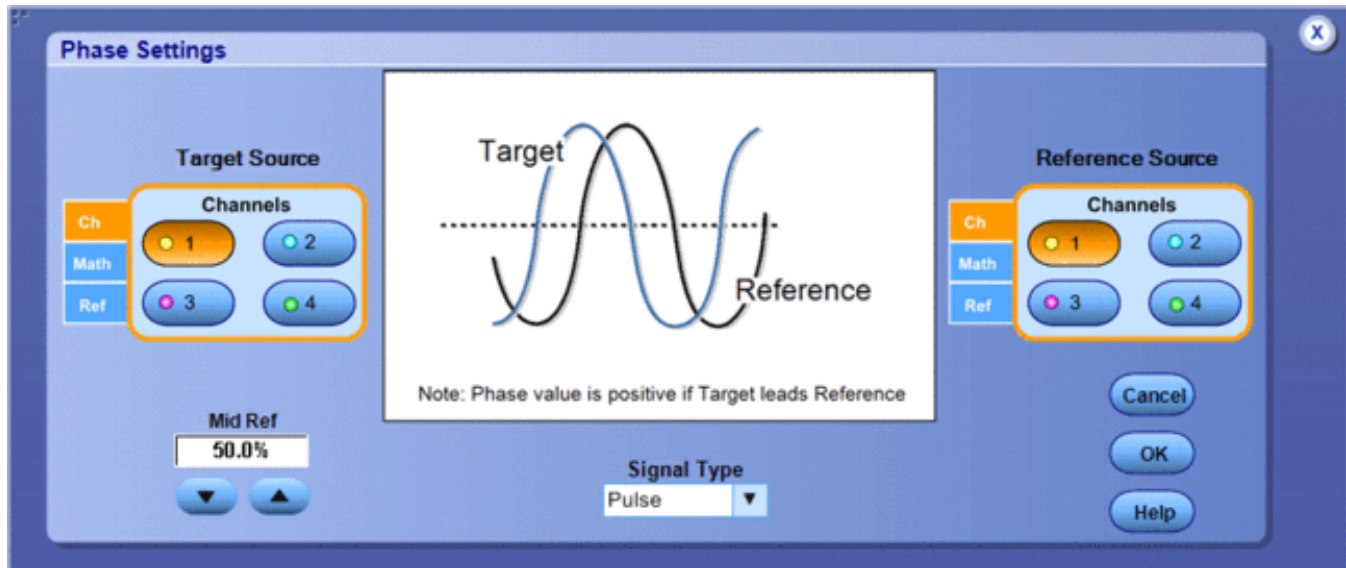

To use.

1. Use the [Channels Selector](#) to select the target and reference source waveforms.
2. Then use the Mid Reference control to specify the voltage reference point in the waveform.
3. Click OK to add the measurement to the measurement list or click to cancel the measurement and return to the Measurement Setup control window.

Behavior. This measurement is the amount of time one waveform leads or lags another waveform. Phase is expressed in degrees, where 360° comprise one waveform cycle. The measurement is taken at the voltage level specified by the Mid Reference control.

Mid reference. The Mid reference defines the middle reference level of a waveform; the default level is 50%. This reference value is primarily used for making measurements between edges such as pulse widths. To change this level, click the control, and then set the level with the multipurpose knob.

What do you want to do next?

[Learn about taking amplitude measurements.](#)

[Learn about taking timing measurements.](#)

[Learn about taking histogram measurements.](#)

[Learn about taking communications measurements.](#)

[Learn more about the Measurements List.](#)

MyScope controls

Click one of links below to access detailed information on the controls in each category:

- [File](#)
- [Edit](#)
- [Vertical](#)
- [Horizontal](#)
- [Trigger](#)
- [Display](#)
- [Cursors](#)
- [Measure](#)
- [Mask](#)
- [Math](#)
- [Utilities](#)

NOTE. Some MyScope controls operate differently than the identical control in the user interface.

What do you want to do next?

[Learn about the MyScope Setup and Edit control windows.](#)

Select timestamp save options

From the File menu, highlight Save As; then select Timestamp Table from the submenu. In the Save As dialog box, click the Timestamp Options button.

Overview. Use the Timestamp Save Options dialog box to set the parameters for the time stamp you want to save.

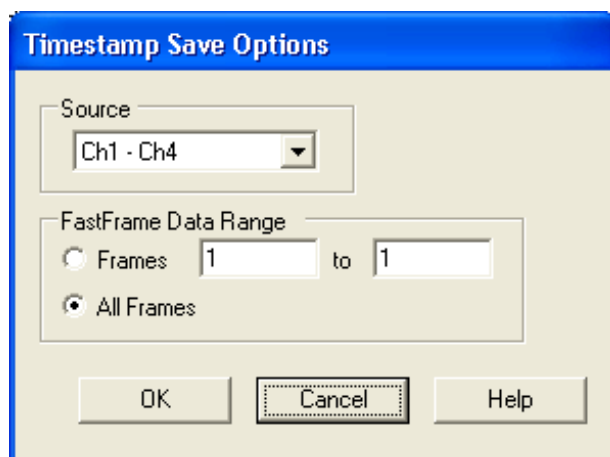

To use.

1. Select the data Source for the time stamp you want to save.
2. Set the FastFrame Data Range for the time stamp.
3. Click OK to return to the Save As dialog box, where you can assign your own file name and save the time stamp to the specified folder. By default, the file is saved to the C:\Users\[Username]\Tektronix\TekScope\data folder.

Behavior. The time stamp table data is saved as a .txt file.

Select the graticule size

From the Vertical or Horiz/Acq menus, highlight Zoom Graticule Size; then select Size from the submenu.

To use.

- Click one of the Graticule Size buttons to set the proportion of the display area for the acquisition window and zoom window.
- Click Setup to access the Zoom Setup control window.

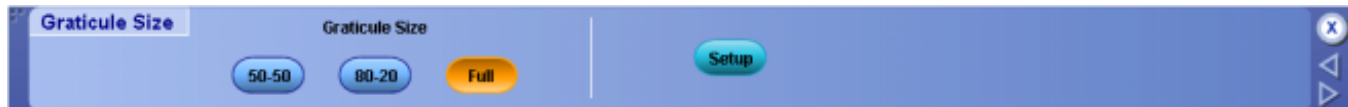

Behavior. Click the 50-50 button to allocate half of the available display for the zoomed graticule and half of the available display for the acquisition window. Click 80-20 to allocate 80% of the available display for the zoomed graticule and 20% for the acquisition window. Click Full to use the entire display for the zoomed graticule.

What do you want to do next?

[Learn about the Zoom Setup controls.](#)

[Go to the Zoom Setup control window.](#)

Select the termination-coupling

From the Vertical menu, select Termination or Coupling.

Overview. Use the Termination control window to select channel input resistance or probe coupling parameters.

For information on the controls, click the buttons.

- [Termination](#)
- [Coupling](#)



NOTE. This online help documents features and options available for several instrument models. Your instrument may not have every feature discussed in this online help.

To use.

- The correct input termination is set automatically when you attach a probe with a TekProbe or TekVPI interface. For other probes, you must set the input termination manually.
- Select the input coupling for the signal from the attached probe to the instrument.

What do you want to do next?

[Learn more about the Bandwidth controls.](#)

Offset and clipping

Clipping. The circled portion of the incoming waveform is clipped, and therefore, is not acquired.

The clipped portion cannot be processed or displayed.

Offset can move the acquisition window vertically relative to the incoming waveform.

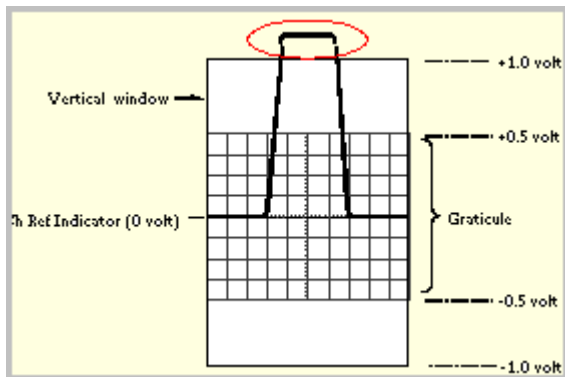

Offset removes clipping. By setting an offset to vertically shift the acquisition positive relative to the waveform, the clipped portion can be acquired.

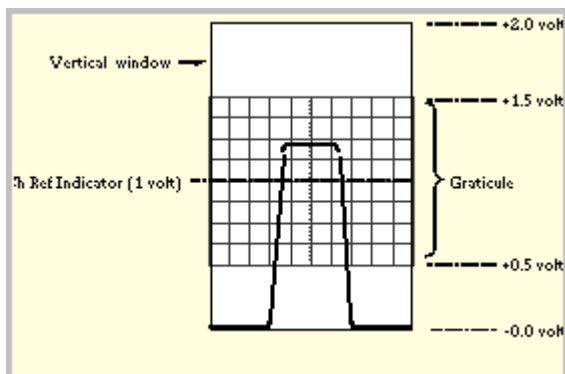

The On-Screen MultiView zoom menu

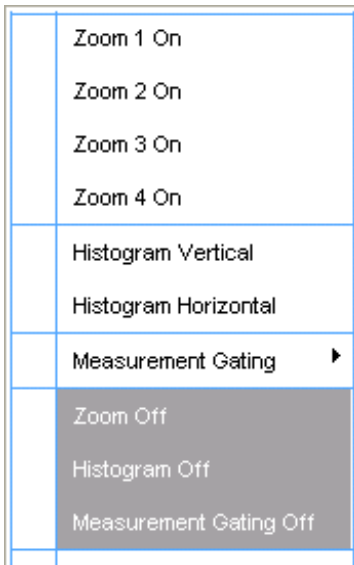

Peak to peak

This voltage measurement is the absolute difference between the maximum and minimum amplitude in the entire waveform or gated region.

Period

This measurement is the time required to complete the first cycle in a waveform or gated region. Period is the reciprocal of frequency and is measured in seconds.

Select trigger polarity

Select the polarity from the drop-down list.

- Click Positive to trigger on a positive-going pulse.
- Click Negative to trigger on a negative-going pulse.
- Click Either to trigger the instrument on either polarity.

Positive duty cycle

This timing measurement is the ratio of the positive pulse width to the signal period expressed as a percentage.

The duty cycle is measured on the first cycle in the waveform or gated region.

$$\text{Positive Duty Cycle} = ((\text{Positive width}) \div \text{Period}) \times 100\%$$

Positive overshoot

This voltage measurement is measured over the entire waveform or gated region.

$$\text{Positive overshoot} = (\text{Maximum} - \text{High}) \times \text{Amplitude} \times 100\%$$

Positive width

This timing measurement is the distance (time) between the mid reference (default 50%) amplitude points of a positive pulse.

The measurement is made on the first pulse in the waveform or gated region.

Predefined functions

From the Math menu, select Math Setup.

To use. Click a button to use one of the predefined math expressions to create the math waveform based on live (channel) waveforms. If the channels are active, you can access each expression directly from the Math menu.

Behavior. These buttons provide common predefined math expressions.

- Click Ch1-Ch2 and Ch3-Ch4 to create math waveforms that are the difference between two input waveforms. Use these functions to view differential signals.
- Click Ch1*Ch2 or Ch3*Ch4 to create math waveforms that are the product of the two input waveforms. For example, you can obtain a power waveform by multiplying a voltage waveform by a current waveform.
- Click Spectral Mag to create a spectral magnitude waveform.
- Click Spectral Phase to create a spectral phase waveform.

The math waveform is based on the last active waveform on the screen. A spectral waveform is created from a channel waveform; you cannot create a spectral waveform from math or reference waveforms.



TIP. Use the [Equation Editor](#) to manually create and edit math waveforms.

What do you want to do next?

[Learn about the Equation Editor.](#)

Probe calibration output

Use the Probe Calibration output to calibrate or deskew passive or active voltage probes.

Probe calibration restrictions

Some probes cannot be calibrated or compensated. This might be because the probes have an attenuation factor greater than 20X. You will get an error message if you try to compensate such a probe.

The instrument cannot compensate for probes that may have gain and/or offset errors that are too great (>2% or >50 mV offset). If these errors are within the specified limits of your probe, you may want to use another probe. If the errors are outside the limits, have your probe checked by service personnel.

Probe calibration is not recommended for the P5050 passive probe. This probe typically has little gain and offset error, and therefore, the performance improvement after a probe calibration is not worth the time needed to do the probe calibration.

Probe compensation

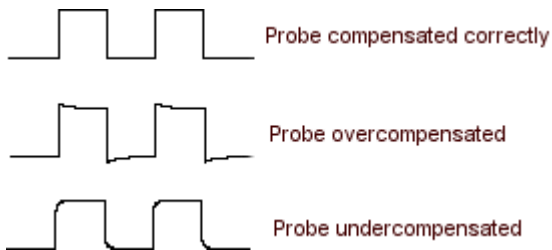

Probe compensation adjustment

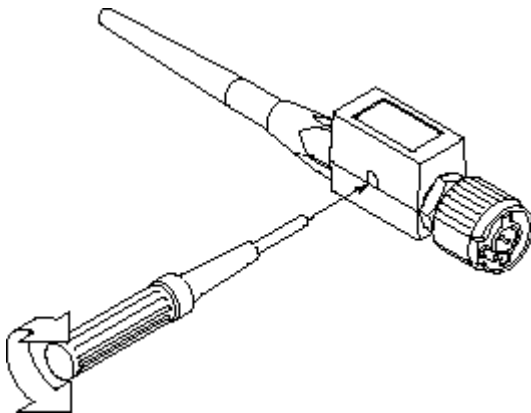

Probe compensation output

Use the Probe Compensation output to compensate or deskew passive or active voltage probes.

Quality factor

Quality factor is the ratio of eye size to noise.

$$\text{Quality Factor} = \frac{(P_{\text{Topmean}} - P_{\text{Basemean}})}{(P_{\text{Topsigma}} + P_{\text{Basesigma}})}$$

Recall a template waveform

Use this procedure to recall a template waveform to a reference location.

1. From the File menu click Recall.
2. Under Recall What: click Waveform, and then select the waveform you want to recall.
3. Select Ref <1–4> from the Destination drop-down list.
4. Click Recall.

Recall a mask

Use the Mask Edit Setup control window to recall a mask.

1. From the Mask menu, select Mask Edit Setup.
2. In the Mask Edit control window, click the Recall button.
3. In the Recall dialog box, click User Mask; then select the mask you want to recall.
4. Click Recall to recall the mask.

NOTE. The default folder for saving masks is `C:\Users\[Username]\Tektronix\TekScope\Masks`. If you saved masks in a different folder, click the Look in drop-down list to find the folder where your masks are saved.

Horizontal modes

From the Horiz /Acq menu, select Horizontal/Acquisition Setup; then open the [Horizontal tab](#).

Overview. The instrument has three horizontal modes. The default mode is Automatic; the default record length limit is 200,000 points.

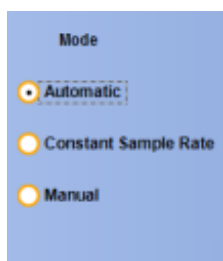

To use. Select the mode that works best for your application.

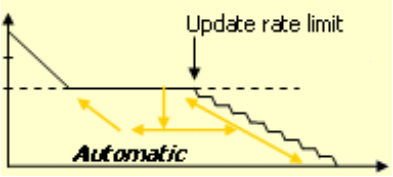
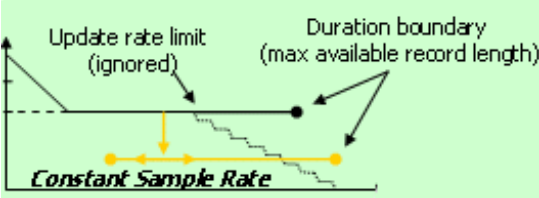
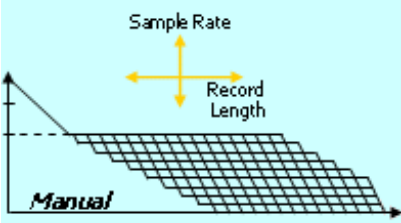
| Horizontal mode | |
|---|--|
| <p>Automatic. Use this mode to set the Scale and Sample Rate; the record length is a dependent variable. If the current time-per-division scale has a record length equal to the record length limit, changing the time-per-division to a larger value will decrease the sample rate to the next available setting. If the current record length is less than the record length limit, the record length can exceed the record length limit by one record length setting. If the sampling mode is real time, and the sample rate is at the real-time limit, attempting to increase the sample rate has no effect.</p> <p>To set the Record Length Limit, click the Advanced button and enter the limit in the Set Record Length Limit dialog box. You can use the buttons or keypad. The instrument will keep the set record length near this limit to produce the best sequence of reduction in sample rate, as the time-per-division is increased.</p> <p>Record length limiting takes place when you change the time-per-division setting. You can use the Sample Rate control to temporarily exceed the record length limit by any amount. The default maximum limit depends on the instrument model and record length option you purchased.</p> |  |
| <p>TIP. You can use the front panel Horizontal Resolution knob to change the sample rate in Automatic mode.</p> | |
| <p>NOTE. The instrument supports Mask testing in Automatic mode only.</p> | |
| <p>Constant Sample Rate. Use this mode to set the Sample Rate and Scale; the record length is a dependent variable. For ≥ 4 GHz instrument models, the default sample rate supports bandwidth filter operation. The maximum record length for your instrument depends on instrument model and record length option.</p> |  |
| <p>Manual. Use this mode to set the Sample Rate and Record Length; the horizontal scale is a dependent variable calculated from the sample rate and record length.</p> |  |
| <p>TIP. You can use the front panel Horizontal Scale knob to change the record length in Manual mode.</p> | |

Behavior. Sample rate, scale, and record length are interactive in all modes. If you increase the scale, the sample rate must decrease if either the maximum record length or the record length limit you set is reached.

Automatic and Constant Sample Rate modes are identical, with the exception that in Constant Sample Rate mode the user cannot set the record length limit. In both cases, the instrument maintains the sample rate constant as set specified by the user.

NOTE. Manual mode uses the maximum record length available for the instrument you purchased.

What do you want to do next?

[Learn more about the Horizontal Setup controls.](#)

Reference point

Use the Ref Point control to define the horizontal reference point within the acquired waveform. The horizontal reference point determines the location within the acquired data where the scale controls will expand or contract the waveform.

- When Horizontal Delay is On, the reference point is the trigger point plus the Horizontal Delay time.
- When the horizontal delay is Off, the reference point is the trigger point.

Resolution bandwidth

The resolution bandwidth controls the bandwidth of the spectral analyzer filters. You can adjust the resolution bandwidth in units of hertz. The resolution bandwidth is measured at the -3 dB points on each side of the peak spectral lobe of the filter.

Resolution bandwidth is inversely proportional to the gate duration in the time domain. Changing the gate duration changes the resolution bandwidth. Changing the spectral analyzer window function also changes the resolution bandwidth but will not affect the gate duration.

To decrease the resolution bandwidth beyond the present limits, increase the time domain gate duration. If this is insufficient, increase the record length and then increase the gate duration again. You can also try the rectangular or Hamming window to maximize the frequency resolution (minimize resolution bandwidth).

Rise time

This timing measurement is the time required for the leading edge of the first pulse in the waveform or gated region to rise from the low reference value (default = 10%) to the high reference value (default = 90%) of the final value.

RMS

This voltage measurement is the true Root Mean Square voltage over the entire waveform or gated region.

Set the RS-232 baud rate

Click in the Baud Rate entry box and use the multipurpose knob to set the baud rate for the trigger.

Select the RS-232 data parity

In the Data Parity drop-down list, select the parity for the trigger.

Set the upper and lower threshold values

The upper and lower threshold levels define the voltage limits of a runt pulse.

- To set the upper threshold, click in the Upper Level entry box, and then use the multipurpose knob to set the voltage level.
- To set the lower threshold, click in the Lower Level entry box, and then use the other multipurpose knob to set the voltage level.

Runt trigger criteria

- Select Occurs from the Runt drop-down list to trigger on any runt.
- Select Wider from the Runt drop-down list to trigger on a runt pulse of a minimum width; click in the Width entry box and use the multipurpose knob to set the minimum pulse width.
- Select Logic from the Trigger if Runt drop-down list to trigger on a logic-qualified runt pulse. When the instrument detects that a runt has occurred, it checks the logical state of two other available channels and triggers only if their conditions are met. Each channel can have a value of high (H), low (L), or "don't care" (X). A value is considered high if the channel input voltage is greater than the specified threshold voltage; a value is considered low if the channel input voltage is less than the specified threshold voltage.
- Use the X "don't care" selection for any channels that will not be used as part of the pattern.

Save a mask

Use the Mask Edit Setup control window to save a mask:

1. From the Mask menu, select Mask Edit Setup.
2. In the Mask Edit control window, click Save.
3. In the Save As dialog box, select User Mask. You may need to click More to access the User Mask selection.
4. Enter a file name in the Name box. If you do not have a keyboard attached, click the keyboard icon to use the pop-up keyboard to enter the file name.
5. Click Save to save the mask. The default folder for saving masks is `C:\Users\[Username]\Tektronix\TekScope\Masks`. If you want to save the mask in a different folder, click the Save in drop-down list, and then click a folder to select it.

Scallop loss

Scallop loss is the difference between the actual magnitude and the computed magnitude of a signal that is halfway between two frequency bins in the spectral output data. Scallop loss is only noticeable when the spectral analyzer is not using zero-fill such as when it is set to full span.

If zero-fill is in use, frequency domain interpolation occurs and there is minimal scallop loss. Zero-fill cannot be directly controlled; it is affected by changing settings of resolution bandwidth or gate width. When in use, a minimum of 20% of the FFT input is always zero, effectively removing scallop loss error by interpolating in the frequency domain.

NOTE. For most settings, descriptions of amplitude accuracy due to scallop loss (as discussed in other publications) do not apply to this oscilloscope when used as a spectral analyzer because of zero-fill. Full span is the most likely setting where scallop loss might occur.

Selecting a spectral window

A spectral window determines what the filter shape of the spectral analyzer will be in the frequency domain. It may be described by a mathematical function that is multiplied point-by-point times the input data to the spectral analyzer.

The following spectral windows are available with the instrument:

- Rectangular
- Hamming
- Hanning
- Kaiser-Bessel
- Blackman Harris
- Gaussian
- Tek Exponential
- Flatop2

The windows are listed in the order of their ability to resolve frequencies (resolution bandwidth). You can easily observe the shape of a window in the frequency domain by feeding a sine wave into the instrument and setting the center frequency of the spectral analyzer to the same frequency. Then reduce the resolution bandwidth to spread out the lobe horizontally. You can then select different window functions and observe their shape.

Window attributes.

- In the time domain, windows are typically bell shaped and go to zero at the ends of the record. For cases where you may be doing impulse response testing, the impulse should be centered at the zero phase reference point (for most windows, this is the 50% position of the gate and 20% for the Tek Exponential window).
- Different window functions affect the resolution bandwidth of the spectral analyzer.
- Various window shapes affect the scallop loss.
- The shape of the frequency domain lobe is determined by the window function. Some windows have better resolution bandwidth, but they do so at the expense of side lobe attenuation and energy leakage into adjacent bins. For example, a rectangular window typically spills energy into many bins showing signals that don't exist; but it has the best frequency resolution. If you are using a window where leakage is occurring, you may want to use spectral gating to reduce the amplitude errors when measuring a given frequency.

Scallop loss

Scallop loss is the difference between the actual magnitude and the computed magnitude of a signal that is halfway between two frequency bins in the spectral output data. Scallop loss is only noticeable when the spectral analyzer is not using zero-fill such as when it is set to full span.

If zero-fill is in use, frequency domain interpolation occurs and there is minimal scallop loss. Zero-fill cannot be directly controlled; it is affected by changing settings of resolution bandwidth or gate width. When in use, a minimum of 20% of the FFT input is always zero, effectively removing scallop loss error by interpolating in the frequency domain.

NOTE. For most settings, descriptions of amplitude accuracy due to scallop loss (as discussed in other publications) do not apply to this oscilloscope when used as a spectral analyzer because of zero-fill. Full span is the most likely setting where scallop loss might occur.

Leakage

Leakage results when the time domain waveform used to create the FFT function is periodic but contains a noninteger number of waveform cycles. When the record contains a fraction of a cycle, there are discontinuities at the ends of the record.

These discontinuities cause energy from each discrete frequency to leak over on to adjacent frequencies. This results in amplitude errors when measuring any given frequency. Different windows have different leakage characteristics.

Selected waveform versus deselected waveform

| Waveform handle | |
|---|--|
|  | <p>The waveform handle indicates if a waveform is selected or deselected.</p> <p>The waveform handle is outlined in the same color as the graticule when the waveform is selected. The waveform handle is outlined in black when a waveform is deselected.</p> |

Sequence triggering (horizontal delay on)

From the Trig menu, select A - B Trigger Sequence; then open the A -> B Seq tab.

Overview. Select the A-B Seq tab to use the A Event (main) trigger with the B Event trigger to capture complex data.

For information on the controls, click the buttons.

- [Trigger Summary](#)
- [A Only](#)
- [A->B Trig after Time](#)
- [A->B Trig on nth Event](#)
- [Horizontal Delay Mode](#)
- [A->B Seq \(No Delay\)](#)
- [Counter Measurements](#)

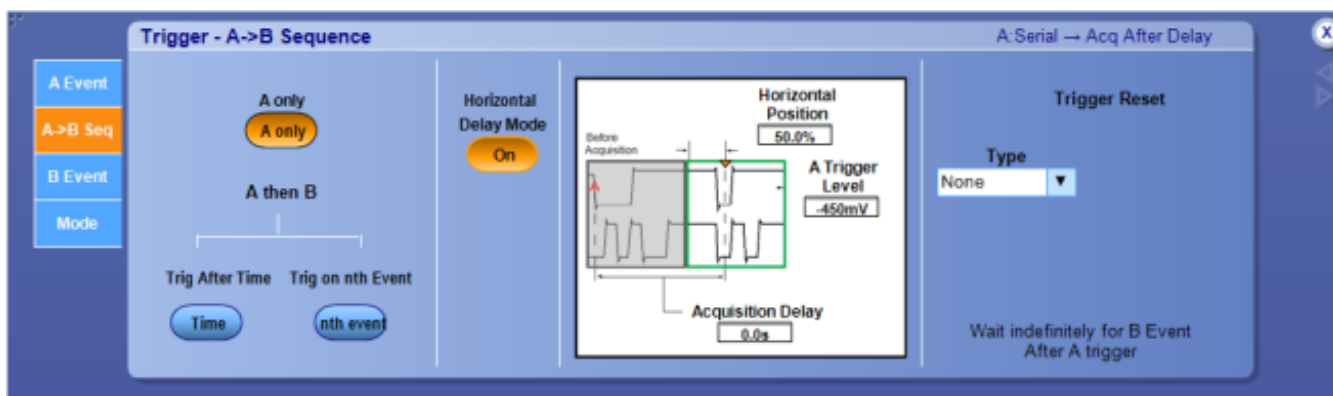

The following screen appears on DPO7000SX Series instruments:

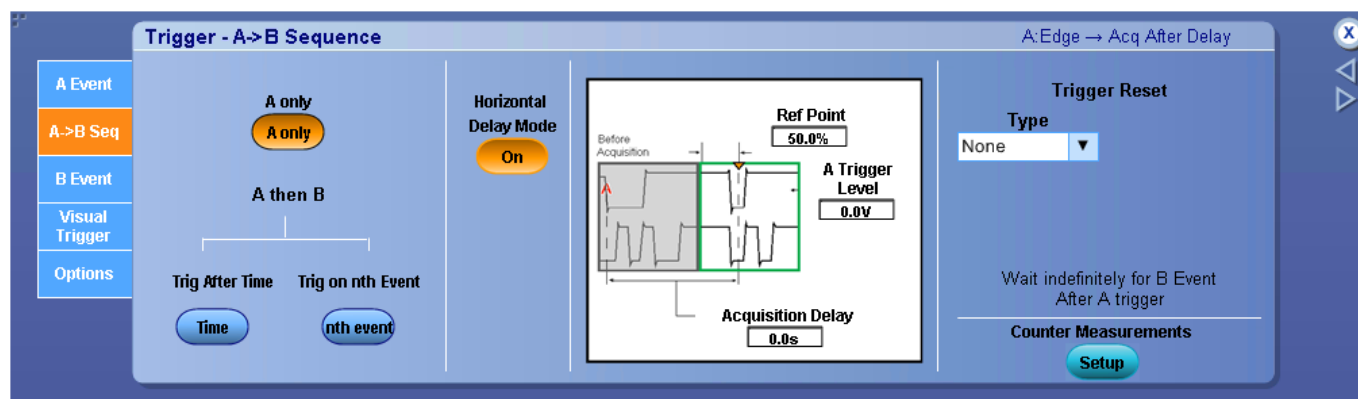

Behavior. Select A - B Trigger Sequence to use the A Event (main) trigger with the B Event trigger to capture complex data. The A Event trigger arms the trigger system. The instrument then triggers on the B Event trigger defined by events or time. You can also set up the instrument to delay the B Event Trigger by a specified time period by turning Horizontal Delay Mode on.

When you click on the trigger window controls, the trigger graphic displays a visual indicator of the trigger criteria. Depending on the trigger type, the instrument will update the graphic as you define the trigger parameters.

What do you want to do next?

[Learn about the A Event trigger types.](#)

[Learn about B Event triggers.](#)

[Learn about Trigger Mode and Holdoff.](#)

[Return to the Trigger Setup control window.](#)

Change the serial bit rate

From the Trig menu, select Serial Pattern Setup.

To use. To change the bit rate of the serial bus on the display, double-click the Bit Rate entry box, and use the keypad or the multipurpose knob to enter a new bit rate.

Behavior. The Standard you select determines the bit rate range. Adjusting the bit rate will change the standard to Custom.

Select the serial clock source

From the Trig menu, select Serial Pattern Setup.

To use.

- In the Clk Src drop-down list, select the clock source for the trigger. The instrument makes one attempt to recover the clock from the data.

Behavior. If you are using R Clk as the clock source, and the clock recovery system does not lock to the input signal, the input signal may be missing or the trigger level may be incorrect. In such an event, correct the problem and push the Level control Set 50% knob, to force the instrument to make another attempt at recovering the clock.

Select the serial coding standard

From the Trig menu, select Serial Pattern Setup.

To use.

- In the Coding drop-down list, select the coding standard for the trigger.

Behavior. The standard sets the bit rate. Changing the bit rate causes the standard to change to your own customized standard.

Select the serial data format

From the Trig menu, Select Serial Pattern Setup.

To use.

- In the Format drop-down list, select the data format, Binary or Hex, depending on how you want to view the data.

Select the serial data source

From the Trig menu, select Serial Pattern Setup.

To use.

- In the Data Src drop-down list, select the data source for the trigger.

Behavior. Depending on which clock source you use, the Clk Polarity and Clk Level controls appear. Use these controls to set the clock polarity and clock level threshold.

Select the serial data standard

From the Trig menu, select Serial Pattern Setup.

To use.

- In the Standard drop-down list, select the data standard for the trigger.

Serial mask testing option

- Install Option MTM on DPO7000C and MSO/DPO5000B Series instruments.
- Install Option MTH on DPO7000C/DX and MSO7000C/DX Series instruments.

Define the serial pattern data

From the Trig menu, select RS-232, Serial, or SPI Setup and then click the Edit button.

To use.

1. Select either the Binary or Hex format option.
2. Use the editor controls to define the pattern to trigger on:
 - Use the alpha - numeric buttons to insert a character in the text box.
 - Click the Home button to place the cursor at the right most position of the text box.
 - Click the Left arrow button to move the cursor one space to the left.
 - Click the Bksp button to delete one character at a time from left to right.
 - Click the Right arrow button to move one space to the right.
 - Click the Clear button to clear the text box.
3. Click Enter to complete the edit.

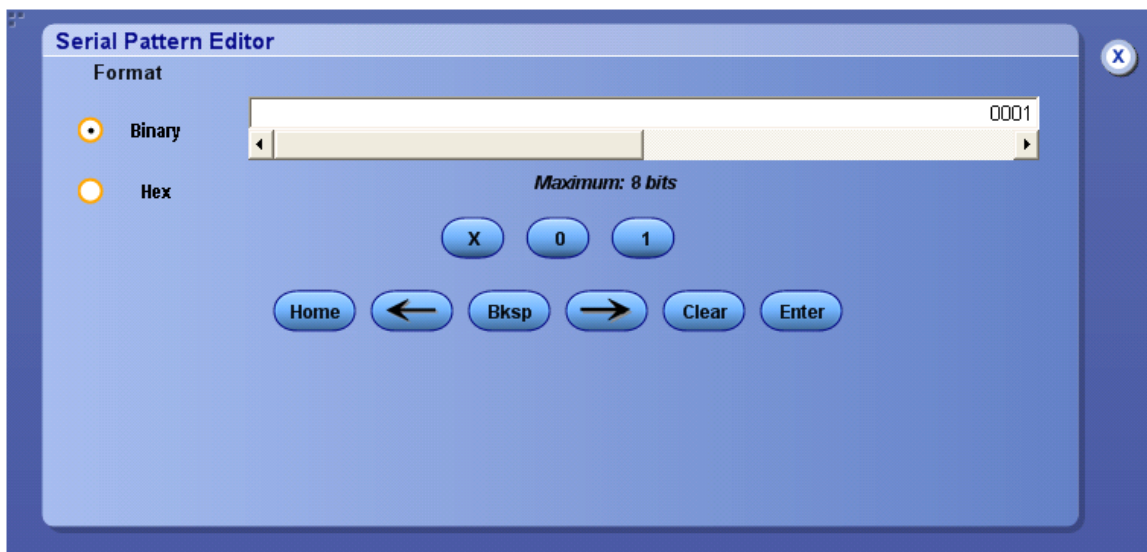

Behavior. If you select the hexadecimal format and the binary pattern cannot be displayed in hexadecimal format, then the serial pattern data will display a question mark (?) instead of an alpha - numeric character.

Clicking the X, 0, or 1 button inserts that character to the left of the cursor in the text box.

What do you want to do next?

[Learn more about other trigger types.](#)

[Go to the Serial Trigger control window.](#)

Define the serial trigger on pattern

From the Trig menu, select Serial Pattern Setup.

To use. Use these controls to define a NRZ pattern for the instrument to trigger on.

Pattern

1. In the Format drop-down list box, select Binary or Hex.
2. Click the Edit button and use the Serial Pattern Editor to define the pattern.
3. Click Enter.

Lock

Lock automatically finds and locks on to a long repeating pseudo-random bit sequence (PRBS). Pattern Lock enables the instrument to take samples at specific locations in a data stream to define the trigger.

1. Click in the Bit Pattern Length entry box and use the multipurpose knobs to define the bit length of a pattern to search for.
2. Click in the Shift Amount entry box and use the multipurpose knobs to define the number of bits to shift from the zero bit position of the initial lock.
3. Click the left or right arrows to increment from bit zero by the Shift Amount to redefine the pattern to be used as the trigger.

Set up FastFrame operation

Follow these steps to use FastFrame mode:

1. Set up the Trigger control window to trigger on the signal of interest.
2. Adjust the horizontal and vertical controls to display a waveform without any clipping.
3. Adjust the Resolution controls to set the number of samples you want to acquire with each acquisition.
4. From the Horiz/Acq menu select FastFrame Setup.
5. Configure the number of frames (Frame Count) you want to capture.
6. Touch the FastFrame button to turn on the FastFrame mode.
7. After the acquisition is complete, select the frame that you want to view under the Frame Viewing section.

Set to 50 with comm triggers

Push the front-panel Level knob.

Overview. The Set to 50% control sets the trigger threshold to 50% for some Comm triggers, and to a high of 75% with a low of 25% for others.

Behavior. When either AMI or MLT-3 code is selected with Comm triggers the Set 50% control measures peak-to-peak level and sets an upper threshold value at 75% and a lower threshold value at 25%. Other codes work exactly the same as Edge, Width, Glitch, and Timeout triggers; the threshold is set to 50%.

Clock source channel

Use the Clock Source drop-down list to select the input channel that is connected to the clock signal.

Set the clock threshold level

To set the clock threshold voltage level:

1. Click in the Clock Level or Threshold entry box.
2. Use the multipurpose knob to set the voltage level.

Select the data source channel

Use the Source drop-down list to select the input channel that is connected to the data signal.

Set the data threshold level

To set the data threshold voltage level:

1. Click in the Data Level entry box.
2. Use the multipurpose knob to set the data voltage level.

Set the setup and hold times

Use the Setup Time and the Hold Time controls to specify the setup and hold limits.

1. Click in a data entry box.
2. Use the multipurpose knobs to set the limits.

Enter a spectral math equation

From the Math menu, select Equation Editor, or click the Editor button in the Math Setup or Spectral Setup control windows.

To use.

- Select a Math <1-4> waveform from the drop-down list.
- Click in the readout field to enter the math expression.
- Click a button to enter its character or operator into the expression.
- Click the [Editor](#) button and use the Math Equation Editor controls to insert numerals, math operators, and variables into a math expression.
- Use the [Text Edit Controls](#) to move the insertion point (cursor) within the expression.

Behavior. These controls only affect the selected math waveform.

What do you want to do next?

[Learn about the Equation Editor.](#)

Enter a spectral math expression

From the Math menu, select Advanced Spectral, or click Advanced in the Math Setup control window; then open the Create/Edit tab.

To use. Use these controls to insert spectral analysis functions into the math expression.

1. Click one of the buttons to insert a function into the math expression.

Magnitude

Phase

Real

Imaginary

Average

2. Use the [Channels Selector](#) to select one of the input channel waveforms to create the Math waveform.
3. Click Avgs to open the [Adjust Math Parameters](#) control window. Use this window to define the number of times you want to average the selected math waveform.

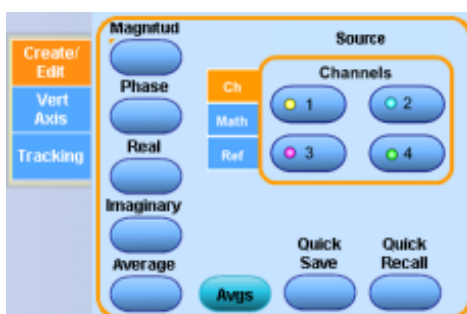

What do you want to do next?

[Learn about the Math Setup controls.](#)

[Learn about setting up the instrument for spectral magnitude waveforms.](#)

Magnitude

Inserts the text SpectralMag(into the math expression. Select one of the waveforms as an argument to the function. This function creates an FFT magnitude waveform.

Phase

Inserts the text SpectralPhase(into the math expression. Select one of the waveforms as an argument to the function. This function creates an FFT phase waveform.

Real number

Inserts the text SpectralReal(into the math expression. Select one of the waveforms as an argument to the function. This function creates a waveform that displays only the real part of the FFT.

Imaginary number

Inserts the text SpectralImag(into the math expression. Select one of the waveforms as an argument to the function. This function creates a waveform that displays only the imaginary part of the FFT.

Average

Inserts the text AVG(into the math expression. Enter an argument to the function. The average function produces the average of the argument.

Spectral tracking

From the Math menu, select Advanced Spectral; then open the Tracking tab.

Use these controls to lock two math waveforms together. This is useful when you want to generate both a magnitude waveform and a phase waveform from the same source.

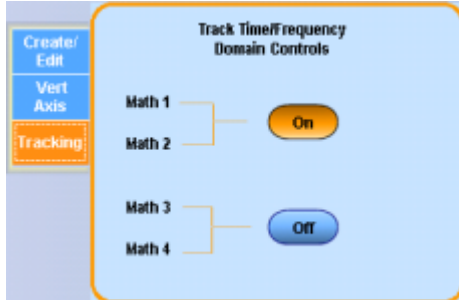

When you lock the spectral controls together, any changes you make to one math waveform are also made to the other math waveform.

You can only lock Math1 with Math2 and Math3 with Math4.

Locking is useful, for example, when Math1 is the spectral magnitude and Math2 is the spectral phase of the same signal. Locking forces the magnitude and phase waveforms to track if you change the spectral controls.

What do you want to do next?

[Learn about the Math Setup controls.](#)

Set up the spectral vertical axis

From the Math menu, select Advanced Spectral; then open the Vert Axis tab.

To use. Use these controls to specify the vertical scale for advanced spectral waveforms. The available selections will vary depending on the settings you make in the Create/Edit tab.

Set the magnitude scale. Use these controls to specify the vertical scale for magnitude waveforms.

- Click one of the Scale buttons to specify the vertical units as linear (V, A, W), dBm (1mW into 50 Ω), or dB (logarithmic).
- Click in an entry box and use the multipurpose knobs to set the reference Level at the top of the screen.
- Use the Level Offset control to position the waveform with respect to the 0 dB reference level without changing the reference level at the top of the screen.

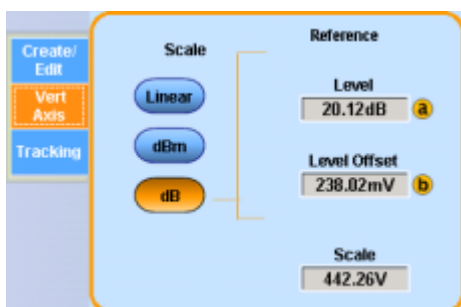

NOTE. The reference level offset is used to calculate the log magnitude in dB. Adjusting the reference level positions the waveform with respect to the top of the screen but does not change the position of the waveform with respect to the ground reference marker.

Changing the reference level offset moves the waveform with respect to its ground reference marker.

Set the Phase Scale. Use these controls to specify the vertical scale for spectral phase waveforms.

Click one of the Scale buttons to specify the vertical units in degrees, radians, or as group delay.

- Group delay unwraps and differentiates the phase. All phase values out of the spectral transformation are between π and $-\pi$ even though the actual phase value may be outside this range.
- Click Unwrap to work on a continuous phase function to unwrap the phase value and show the true range. The phase unwrap begins with a phase value obtained at the first spectral sample after DC.
- Click in the suppression Threshold entry box and use the multipurpose to set the level. Suppression prevents random noise from making the display unusable. Any spectral points with magnitudes less than the threshold will have phase values set to zero (degrees or radians). To set a dB level for the suppression threshold, select dB scale from the magnitude tab, and then set a horizontal bar cursor to the level on the magnitude spectrum. Read the dB value from the cursor and use the multipurpose knob to enter the value as the suppression threshold.

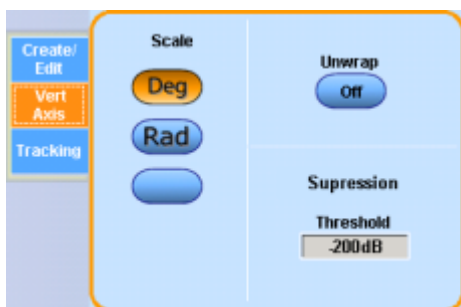

Set the Linear Scale. Click in an entry box and use a multipurpose knob to specify the position and scale for a linear display.



What do you want to do next?

[Learn about locking math waveforms together.](#)

[Learn about the Math Setup controls.](#)

Set the spectral vertical controls

From the Math menu, select Basic Spectral or click Basic in the Math Setup control window.

To use. Use these controls to specify the vertical scale for magnitude and phase waveforms.

- Click either the Magnitude or Phase button.
- Click one of the Vertical Control buttons to specify the vertical units.
- Click in an entry box and use the multipurpose knobs to adjust the level, scale, position, or offset on screen.
- For Magnitude waveforms, use the Reference Level Offset control to position the waveform with respect to the 0 dB reference level without changing the reference level at the top of the screen.

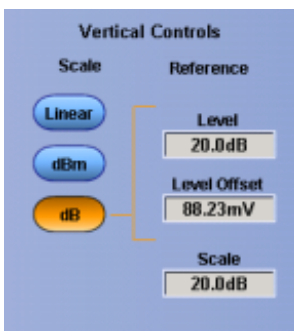

Behavior. The reference level offset is used to calculate the log magnitude in dB. Adjusting the reference level positions the waveform with respect to the top of the screen but does not change the position of the waveform with respect to the ground reference marker.

Changing the reference level offset moves the waveform with respect to its ground reference marker.

What do you want to do next?

[Learn about setting up the instrument for spectral phase waveforms.](#)

[Learn about the Math Setup controls.](#)

SPI bus trigger polarity

The SS, MISO, and MOSI Active controls allow you to select when the enable is active.

- Select (H) High or (L) Low from the drop-down menu.

The SCLK Active control provides compensation for inverted signals or synchronization on the falling edge of the clock.

- Select Rising or Falling from the drop-down menu.

SPI bus trigger threshold

1. Click in the SS Threshold or SCLK Threshold entry boxes.
2. Use the multipurpose knobs to set the threshold voltage levels for the trigger.

SPI data source

In the drop-down list box, specify the MISO and or MOSI data source.

Supported ADEs

TekVISA supports these Application Development Environments:

- Microsoft C/C++
- Microsoft Visual Basic
- LabVIEW graphics software using the G language
- MATLAB analysis software

TekProbe-TekVPI interfaces

These interfaces enable the instrument to sense information about the probe such as the serial number and other unique identification information. It also allows the instrument to provide power directly to the probe.

With this information, the instrument can automatically set up its requirements to match the characteristics of the probe, such as termination and attenuation.

Set the timeout trigger criteria

- Click Stays High to trigger the instrument when the pulse is high for the specified time.
- Click Stays Low to trigger the instrument when the pulse is low for the specified time.
- Click Either to trigger the instrument if the signal has not crossed the threshold value for the specified time.

Set the Time-Out value

The time-out value determines when the instrument will trigger.

1. Click in the Timer entry box.
2. Use the multipurpose knob to set the time-out value.

Set the upper and lower threshold levels for transition time

Use the upper and lower threshold levels to measure the transition time as shown in the trigger graphic.

1. Click in the Upper Level entry box and use the multipurpose knob to set the voltage level.
2. Click in the Lower Level entry box and use the other multipurpose knob to set the voltage level.

Set the transition time trigger criteria

1. Click in the Time entry box and use the multipurpose knob to set the target transition time.
2. Click in the Transition entry box.
 - **<**. Triggers the instrument when the transition time is less than the specified time.
 - **Greater Than**. Triggers the instrument when the transition time is greater than the specified time.

Trigger coupling

The trigger coupling determines what part of the signal is passed to the trigger circuitry. All trigger types except edge triggering use DC coupling only. Edge triggering can use all available coupling choices.

- **DC**. This coupling passes all input signals to the trigger circuitry.
- **AC**. This coupling passes the input signals above 60 Hz to the trigger circuitry.
- **HF Reject**. This coupling attenuates signals above 50 kHz before passing the signal to the trigger circuitry.
- **LF Rej**. This coupling attenuates signals below 80 kHz before passing the signal to the trigger circuitry.
- **Noise Rej**. This coupling provides stable triggering by increasing the trigger hysteresis. Increased hysteresis reduces the trigger sensitivity to noise but may require greater signal amplitude.
- **RF**. Increases sensitivity and bandwidth at the highest operating frequencies (SX models only).

Set the glitch width criteria

These controls specify the action of the glitch width criteria. The trigger graphic displays the criteria you have selected.

1. Click in the Width entry box and set the width with the multipurpose knob.
2. Use the Glitch Width drop-down list box to specify the action:
 - **Less Than**. Triggers the instrument only on glitches narrower than the specified width
 - **Greater Than**. Triggers the instrument only on pulses wider than the specified width.

Trigger graticule

All graticule types are available for selection from the drop-down list. The IRE graticule is normally used with the NTSC signals, and the mV graticule is normally used with all other video signals.

Trigger holdoff (Auto)

When the Trigger Holdoff is set to Auto, the instrument automatically calculates the trigger holdoff time. It is normally equal to five times the current Horizontal Scale setting.

After a trigger event, the instrument will not accept another trigger event until after the holdoff value is exceeded. Holdoff is usually specified in units of time, but other units may be used.

Trigger holdoff (Random)

When Trigger Holdoff is set to Random, the instrument delays the trigger a random amount of time between triggers. This means that successive acquisitions are unrelated to the previous trigger signal.

Trigger holdoff (Time)

After a trigger event, the instrument will not accept another trigger event until after the holdoff value is exceeded. Holdoff is usually specified in units of time, but other units can be used.

When the Trigger Holdoff is set to Time, you can manually adjust the value with the multipurpose knob. Use this option when the signal that you want to trigger on has several possible trigger points. Use the Trigger Holdoff control to delay the trigger system for a specified amount of time between triggers so that you can obtain a stable display.

Set the trigger level

The trigger level determines the voltage level where the trigger point occurs.

To use.

- Adjust the trigger level with the front-panel Trigger Level knob.
- Click in the Level entry box in a Trigger control window and use the multipurpose knob to adjust the level.

Select the trigger on options

Select a value from the Trigger On drop-down list to specify where the trigger will occur on the video signal. The Trigger On drop-down list contains the options Field, All Lines, and Line #.

- If you select Field, use the drop-down list to select Odd, Even, or All.
- If you select Line #, click in entry field and use the multipurpose knob to set the line number. Line numbers wrap when their limits are reached. The range of line numbers depends on the chosen Format.

NOTE. If you select the NTSC format, use the multipurpose knob to first scroll through all of the odd lines, and then the even lines.

Select the bus trigger on data

In the Trigger On drop-down menu, select the type of data to trigger on. The available selections are different for each bus type.

Select the glitch trigger polarity

The Polarity buttons set the glitch polarity.

- Click Pos to trigger on a positive-going pulse.
- Click Neg to trigger on a negative-going pulse.
- Click Either to trigger on positive or negative glitches.

Set the trigger qualification

You can qualify some trigger types by the logical state of other channels or by a bus pattern for MSO7000C/DX Series instruments.

- Click Occurs to trigger the instrument only when the defined trigger type occurs. No qualification occurs.
- Click Logic to trigger the instrument when the defined trigger type occurs and the logic input conditions occur.
- Click Occurs And to trigger the instrument when the defined trigger type occurs and the bus pattern occurs on the selected bus.

Set the trigger occurs and qualification

NOTE. This online help supports many oscilloscope models from Tektronix. This feature is only available on some models.

For the supported instruments, use the controls to set up the Occurs And pattern for the instrument to qualify the following triggers: Glitch, Runt, Setup/Hold, Timeout, Transition, Width, and Window.

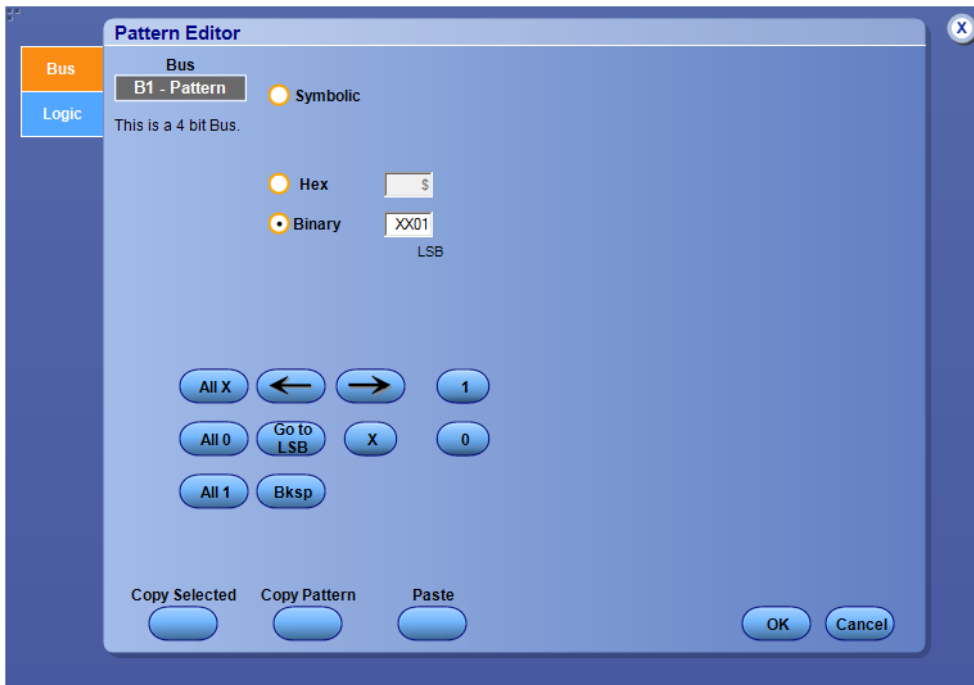

What do you want to do next?

[Learn how to set the voltage threshold level for channels used as digital waveforms.](#)

[Learn about bus setups.](#)

HF filtering

NOTE. This online help supports many oscilloscope models from Tektronix. This feature is only available on some models.

Use the HF filter to extend the range of the Glitch/Pulse Width/Time-Out Timers to work with digital data rates above 4 Gbps. The timers require that the minimum reset time be ≥ 250 ps, which is 1 UI at 4 Gbps. Reset pulse widths shorter than 250 ps violate the minimum reset time. Use the HF Filter to eliminate pulses narrower than 250 ps.

Envelope triggering

NOTE. This online help supports many oscilloscope models from Tektronix. This feature is only available on some models.

The envelope function is useful to work with RF burst signals in the 1 GHz to 20 GHz range. Use the envelope function when the signal of interest contains high frequency data that you do not want to trigger on. The envelope function allows the trigger to ignore the high speed data or high frequency carrier and will passed the envelope shape of the signal to the trigger. The high frequency burst data is seen as a single pulse. The envelope function works with edge, glitch, pulse width, or timeout trigger modes. The envelope function also works with digital data above 1.5 Gbps.

For best results when using the Envelope Detector, move the waveform handle so the DC level of the signal is at the vertical center of the graticule. For example, here the waveform handle was moved up so the DC level is at 0 volts (vertical center of graticule).

With the DC level at vertical center of graticule, pressing the Push Set 50% button finds the best triggering level. Manual adjustment is also available.

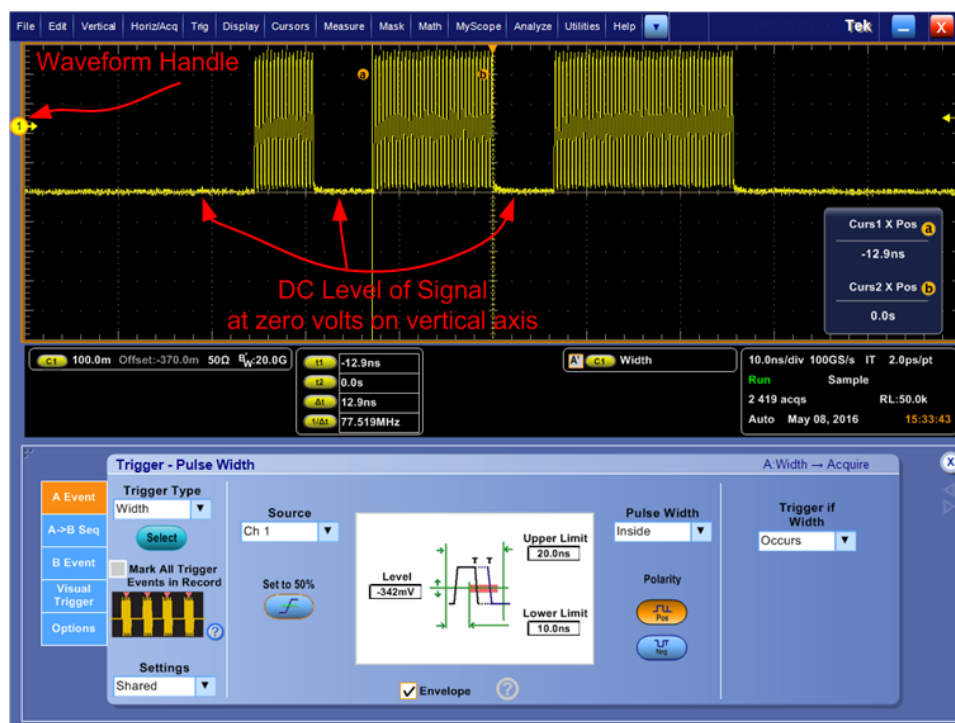

On 70K SX instruments, the Envelope checkbox can be found on the A- and B-Event Edge, Glitch, Width, and Timeout trigger menus. You can use zero, one, or two timers to trigger on burst conditions.

On 7K, 70KC, and 70KD instruments, the hardware implementation is different, and is best used to trigger on the gap between bursts, using A- and B-Event Glitch, Width, and Timeout triggers.

When using Envelope with Edge trigger on a signal as shown, positive polarity triggers on the leading edge of the burst, while negative polarity triggers on the trailing edge of the burst. Polarity changes have similar effects on the other trigger types where the Envelop Detector is available.

Set the trigger reset conditions

1. In Trigger Reset Type drop-down menu, select a condition for a trigger reset.
2. Use the drop-down menus to set up Time, Transition, State, Source, or Threshold conditions for the specified reset.

Trigger settings (Shared - independent)

This feature determines how the instrument applies trigger levels to the input channels:

- **Shared.** Sets the trigger level in common across all input channels. Changing the trigger level of one channel changes the trigger levels of all input channels to the same level.
- **Independent.** Allows you to set a unique trigger level for each input channel. Changing the trigger level on one channel does not affect the trigger level setting of the other input channels.

Trigger source

The trigger source determines the source of the trigger signal. The input channels are the most commonly used trigger sources and are available for all trigger types.

NOTE. You have the option to add user-defined label for analog, reference, bus, and digital sources.

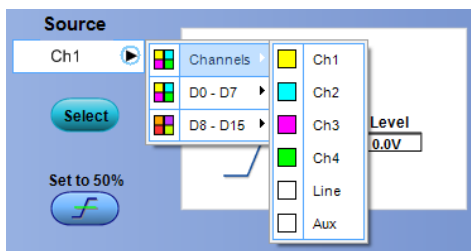

Figure 29: To trigger on an input channel, select a channel.

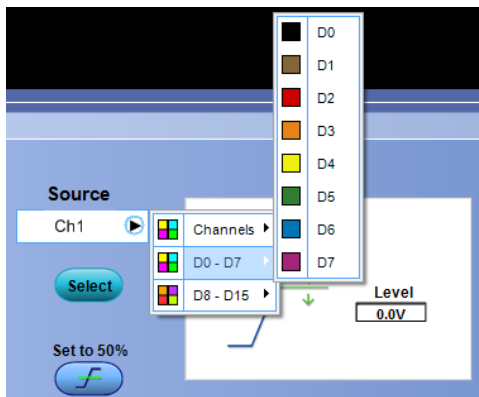

Figure 30: If your instrument has digital channels, trigger on a digital channel by selecting a digital channel.

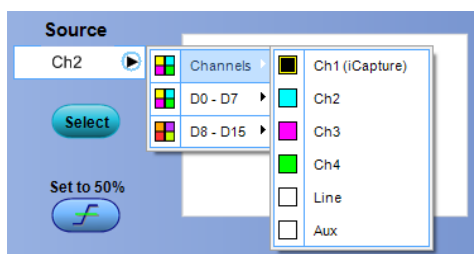

Figure 31: If your instrument has digital channels and, in the Vertical menu you selected an iCapture signal, trigger on a the iCapture channel by selecting the channel.

Trigger summary

In the upper-right corner of the setup window, the trigger summary provides a one-line summary of the trigger setups. Use this summary to get an overview of the trigger setups without having to look through all of the trigger tabs.

Window event trigger

To qualify the trigger for Window triggering, select from these drop-down list selections:

- **Enter Window.** Triggers the instrument when the signal enters the window as defined by the threshold levels.
- **Exit Window.** Triggers the instrument when the signal leaves the window as defined by the threshold levels.
- **Inside > t.** Triggers the instrument when the signal leaves the window, defined by the threshold levels, after remaining inside the window longer than the time specified by Width:
 - Click POS to trigger on waveforms with a positive polarity exiting the window.
 - Click NEG to trigger on waveforms with a negative polarity exiting the window.
 - Click EITHER to trigger on either polarity.
- **Outside > t.** Triggers the instrument when the signal reenters the window, defined by the threshold levels, after remaining outside the window longer than the time specified by Width.

Set the trigger width limits

To trigger on a pulse width outside a range of limits:

1. Select Outside from the Pulse Width drop-down list.
2. Set the Upper Limit and Lower Limit with the multipurpose knobs.

To trigger on a pulse width within a range of limits:

1. Select Inside from the Trig When drop-down list and
2. Set Upper Limit and Lower Limit with the multipurpose knobs or pop-up keypad.

Set the trigger polarity

The polarity buttons define the polarity of the pulse width.

- Click Pos to trigger on a positive-going pulse.
- Click Neg to trigger on a negative-going pulse.

Using FastFrame acquisitions

Consider the following operating characteristics when using FastFrame :

- You can push Run/Stop to terminate a FastFrame sequence. If any frames were acquired, they are displayed. If no frames were acquired, the previous FastFrame waveform is displayed.
- Because FastFrame introduces additional processing time into the operation cycle of acquire, process, and display, it is best to use Single Sequence Acquisition (see Acquire menu, Stop After menu). With Single Sequence selected, you will see the current acquisition sequence; otherwise, the display lags the current sequence by one sequence. You can also see the current sequence by pushing the Run/Stop button to stop the acquisition.
- FastFrame greatly reduces the minimum trigger holdoff time, enabling you to acquire and store records at rates of up to 225,000 captures per second (until the number of frames requested has been acquired). FastAcq mode also provides exceptionally fast acquisition rates. Both modes have advantages. FastFrame preserves the actual data associated with each trigger event for further analysis or visual inspection, but only acquires at the fast rate for short bursts of time. FastAcq mode combines the data from all trigger events into a single pixel map, but can acquire at exceptionally fast rates continuously, not just for short bursts.
- In single sequence acquisition mode, statistics are calculated using all frames in the current acquisition except for Average and Envelope frames. If the currently selected frame is the Average or Envelope Frame, measurements are taken on the frame but statistics are still based on all frames excluding the Average and Envelope frames. Statistics reset with each new single sequence acquisition.
- On a reference waveform, statistics are derived from all frames in that reference waveform when FastFrame is on. If FastFrame is off, the statistics reflect only the first frame that is displayed.

Use print screen

If you have an attached keyboard you can use the Print Screen (Prt Sc) key to copy the screen contents to the Windows clipboard. This bitmap does not include the waveforms or graticule. The waveforms and graticule are displayed by the graphics adapter outside of normal Windows mechanisms.

To use. To capture the instrument screen with its graticule and waveforms, use the Edit menu Copy command after selecting Image in the Copy Setup menu, or to build a bitmap file, select the File menu Save As command. Click Options under Screen Capture, and then select Full Screen under View. For additional information, see [Save As Dialog Box: Screen Captures](#).

You can display the current date and time on screen so that they appear on hard copies you print. To do this, toggle the Display Date/Time button On from the Display Setup control window Objects tab. If you need to reset the date and time for any reason, right-click the date and time and then select Set Date/Time.

Behavior. Pressing the Print Screen key on an attached keyboard copies the screen image minus the waveform and graticule to the Windows clipboard. Using the Edit menu Copy command copies the screen image with the waveform and graticule.

Analyze menu

The Analyze menu provides access to search and place marks on acquired waveforms. It also provides access to tools for DDR analysis and other applications that are installed on your instrument.

Cursors menu

Use the Cursors menu options to select cursor types, mode, and position, and to turn cursors on and off.

Digital menu

NOTE. *The Digital Menu is available only on MSO5000B and MSO7000C/DX Series instruments and DPO5000B Series instruments with option MSOE installed, and DPO7000DX instruments with option MSOU installed.*

Use the Digital menu options to set parameters for the D15-D0 digital channels, and to set up buses based on analog, math, and digital waveforms from which the instrument can acquire, decode, and display data (or bus forms).

On MSO/DPO5000B Series instruments, you have the option to turn on or turn off the MagniVu feature.

Display menu

Use Display menu options to change the way that waveforms appear on the instrument. This includes the style, intensity, color, format, text, and persistence. You can also change the graticule type and the items that appear on the display, such as date and time.

Edit menu

Use the Edit menu for copying images, waveforms, or measurements to the clipboard for use in other applications. You can select items from the menu or you can select Copy Setup to fine tune the parameters with the Copy control window before copying items to the clipboard.

You can also use the Edit menu to clear data and [undo the last Autoset](#).

File menu

Use the File menu for basic file operations such as saving, recalling, and deleting waveforms or setups. You can also use the File menu for standard Windows operations such as printing files and loading the most recent setup.

Horizontal-Acquisition menu

Use the Horizontal/Acquisition menu options to set the horizontal and acquisition parameters for waveforms. This menu also provides access to the Zoom controls, Autoset, and Fast Acquisitions.

On MSO5000B models and on DPO5000B models with option MSOE, you have the option to turn on or turn off the MagniVu feature.

Mask menu

Use the Mask menu commands to setup or edit or a user mask.

Math menu

Math menu options enable you to perform mathematical operations on waveforms, build algebraic expressions, perform math-on-math operations, analyze histograms, or use advanced spectral analysis.

MyScope menu

Use the MyScope Menu to create a new MyScope control window, open or edit an existing one, display the active MyScope window, or recall recently used ones.

Measurement menu

Use Measurement menu commands to select from and set up a variety of automatic measurements. Commands are also available on this menu for further in-depth analysis, gating (bounding), statistics, communication, and histograms.

Trigger menu

Use the Trigger menu to set up the instrument to trigger on live waveforms. Several different types of triggering are available.

Utilities menu

The Utilities menu provides access to utilities used by the instrument such as instrument calibration, instrument diagnostics, and user preferences. All utilities are accessible from the menu bar only. None of the utilities are directly accessible from the front panel controls or from the toolbar.

Vertical menu

Use the Vertical menu options to set vertical parameters for waveforms. This menu also provides access to the Zoom controls and the probe compensation, deskew, and attenuation functions.

Set the vertical position

From the Vertical menu, select Position/Scale.

Overview. Use the Position control to set the vertical position of the selected waveform.

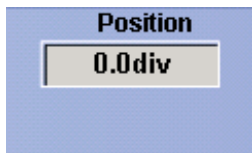

To use.

- Click in the Position entry box to map it to one of the multipurpose knobs; then use the knob to move the waveform.
- You can also use the up-down arrows to change the value.

Behavior. The Position control moves the vertical position of the waveform 0.2 divisions (0.02 divisions with FINE control). Increasing the position value moves the waveform up, and decreasing the position value moves the waveform down.

The Position control differs from the Offset control; for information on the Offset control for channel waveforms refer to the [Vertical Offset Control Window](#).



TIP. Several alternatives are available for adjusting the position of a waveform:

- Use the dedicated knob on the front panel for the selected waveform.
- Enter a value with the on-screen pop-up keypad.
- Use an attached keyboard to type a value directly into the position field.

What do you want to do next?

[Learn more about offsetting channel waveforms.](#)

[Learn more about the Vertical controls.](#)

[Learn more about the Waveform controls.](#)

[Learn more about the Vertical Scale controls.](#)

Set the vertical scale

From the Vertical menu, select Position/Scale.

Overview. Use the Scale control to set the vertical scale value of the selected waveform.

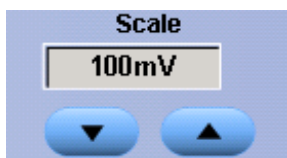

To use.

- Click in the Scale entry box to map it to one of the multipurpose knobs; then use the knob to move the waveform.
- You can also use the up-down arrows to change the value.

Behavior. Each waveform has its own vertical scale parameter. For a signal with constant amplitude, increasing the scale causes the waveform to appear smaller. Decreasing the scale causes the waveform to appear larger.

The scale affects all waveforms, but affects channel waveforms differently:

- For channel waveforms, the scale setting controls the vertical size of the *acquisition window* as well as the display scale. The range and resolution of the scale value depends on the attached probes and any other external factors you may have specified.
- For reference or math waveforms, the scale setting controls the display only. Scaling these waveforms has no effect on the acquisition hardware.
- Use the dedicated knob on the front panel for the selected waveform.
- Enter a value with the on-screen pop-up keypad.
- Use an attached keyboard to type a value directly into the position field.

What do you want to do next?

[Learn more about the Vertical controls.](#)

[Learn more about the Waveform controls.](#)

Select the bandwidth

From the Vertical menu, select Vertical Setup.

Overview. Use the following controls (similar to the example shown below) to set the bandwidth and filter unwanted high-frequency noise from the waveform. You can also use the *Bandwidth Enhancement Controls* to normalize the bandwidths between selected channels.

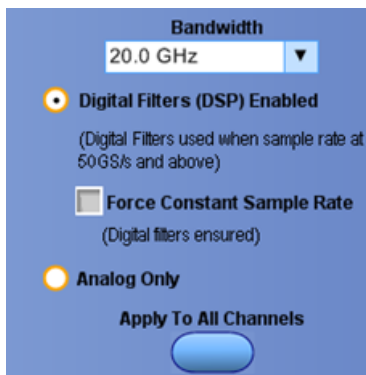

To use. Click the appropriate option buttons and use the drop-down list box to specify the bandwidth you want to acquire. The available selections and controls will vary depending on the instrument model and probe you are using.

Behavior. Bandwidth refers to the range of frequencies the instrument can acquire and display accurately with less than 3 dB attenuation. Each input channel has its own bandwidth selection.

To take accurate measurements, the input frequency should be much less than the rated bandwidth of the instrument. A good rule to follow is to ensure the bandwidth of the instrument system is three to five times the bandwidth of the signal that you want to measure.

What do you want to do next?

[Continue to learn about the Vertical Setup controls.](#)

[Return to the Vertical Setup control window overview.](#)

Bus pattern condition

For the supported instruments, use the control to select how many occurrences of the pattern to detect before the instrument triggers.

Bus selection

For the supported instruments, use the control to select the Bus on which to trigger from the list of bus setups.

Bus time condition

For the supported instruments, click the Time entry box and enter a value with the keypad or use the multipurpose knobs to select a value.

Trigger logic state condition

For various trigger types, in the Trigger if Logic State drop-down list, select True to trigger the instrument when the logic patterns are true. Select False to trigger the instrument when the logic patterns are false.

Set the parallel bus pattern

For the supported instruments, use the controls to set up the Parallel Bus parameters. Click the Edit button to access the Pattern Editor dialog box.

For information on the Pattern Editor dialog box, click the buttons.

- [Bus Pattern](#)
- [Digital Pattern](#)

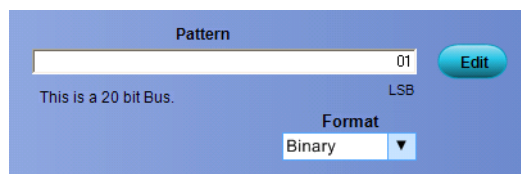

Bus pattern editor (Bus tab)

When you select a parallel bus and click the Edit button, use the Pattern Editor controls to set up the bus trigger pattern for the instrument to use to detect a specific parallel bus value.

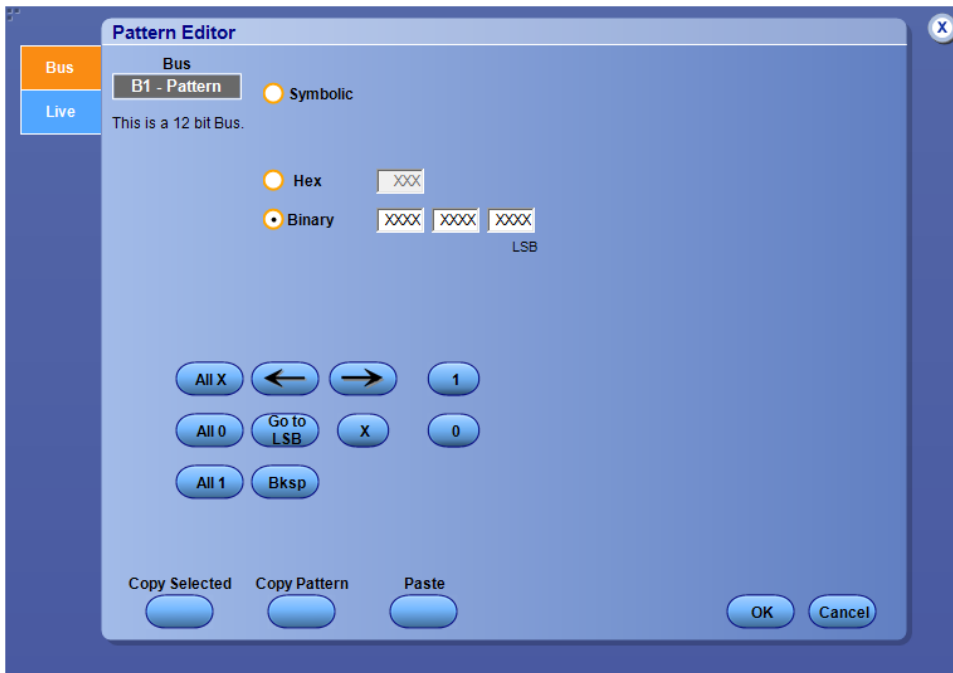

When you select a serial bus and click the Edit button, use the Pattern Editor controls to set up the bus trigger pattern for a serial bus value. For example, the Data (SPI bus), or the Address, Data, or Address and Data (I2C bus) bus values.

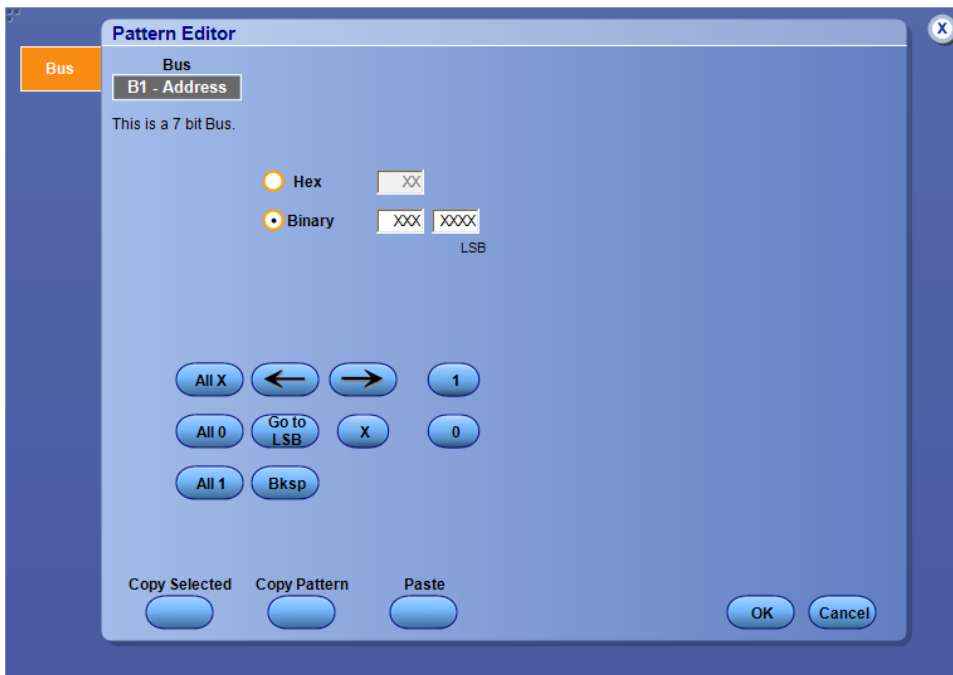

What do you want to do next?

Learn how to set the voltage threshold level for logic waveforms and to define a pattern.

Learn about bus setups.

Bus pattern editor (Bus tab)

Use the Pattern Editor controls to set up the bus trigger pattern for the instrument as follows:

For parallel bus. Select the parallel bus and click Edit button.

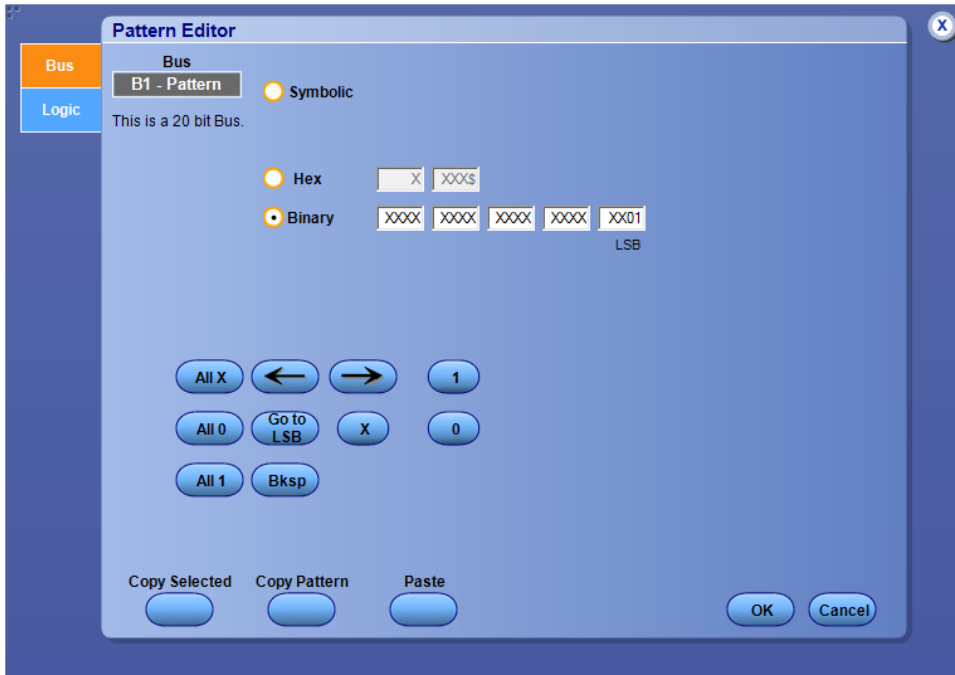

Select a bus and click Edit button.

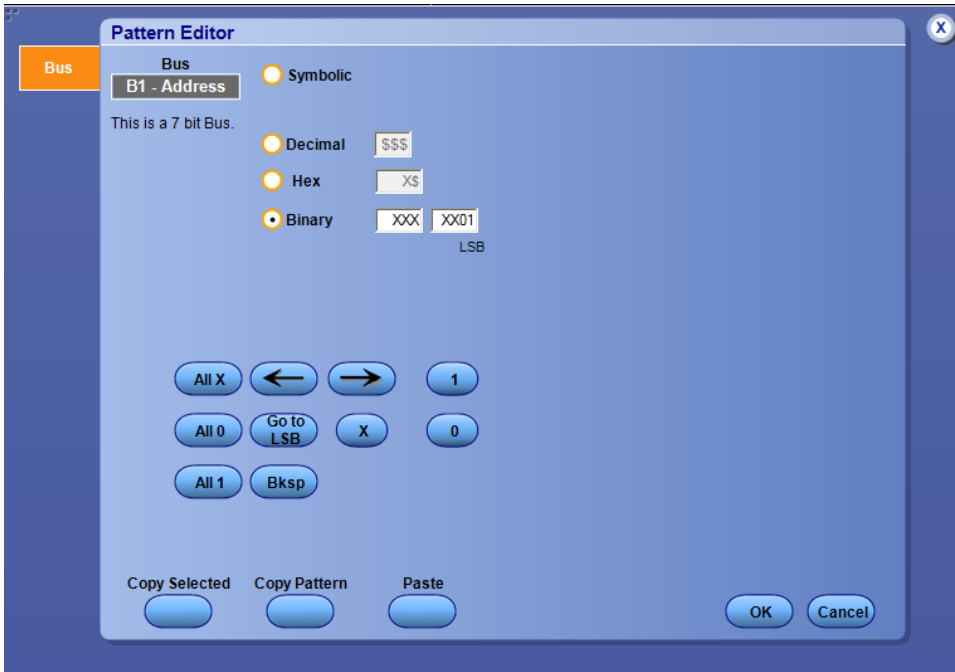

For serial bus. Select a bus SPI (with Trigger On set to Data), RS232 (with Trigger On set to Data), I2C (with Trigger On set to Data), or USB (with Trigger On set to Special Packet, Special Type set to SPLIT 1000, and select Hub Address or Port Address) and click Edit button. The Bus field would display the text depending on the type of bus selected (address, data, hub, or port). For example for data bus (B1), the field would display B1Data.

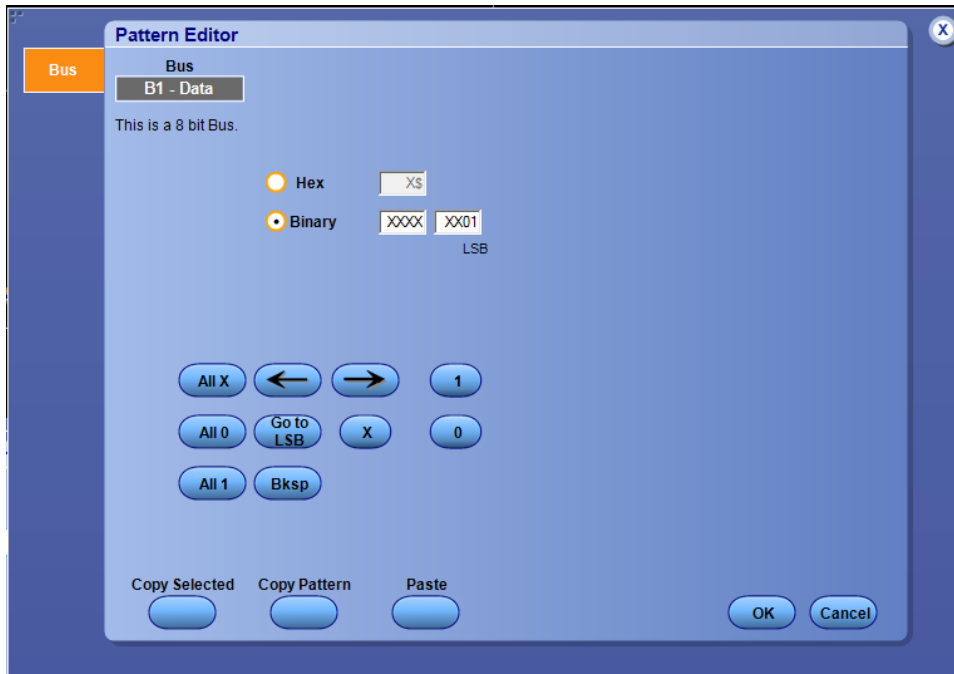

Select a bus I2C (with Trigger On set to Address or Addr+Data) or USB (with Trigger On set to Token Address Packet or Data Packet) and click the Edit button. The Bus field would display the text depending on the type of bus selected (address, data, hub, or port). For example for data bus (B1), the field would display B1Data.

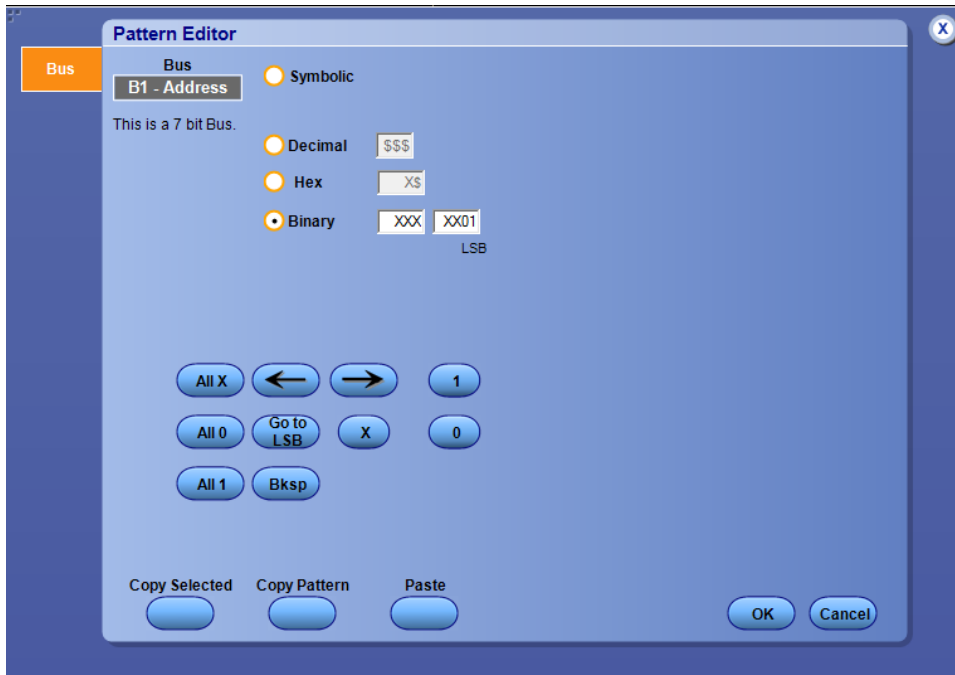

What do you want to do next?

[Learn how to set the voltage threshold level for logic waveforms and to define a pattern.](#)

[Learn about bus setups.](#)

Bus pattern editor (Logic tab on MSO series)

Use the controls to set the bus trigger pattern of the channels the instrument uses as logic waveforms to detect a parallel or serial bus value. Click a channel button to select the value for that channel: 0, 1, or X. For convenience, you can also change the voltage reference level threshold values.

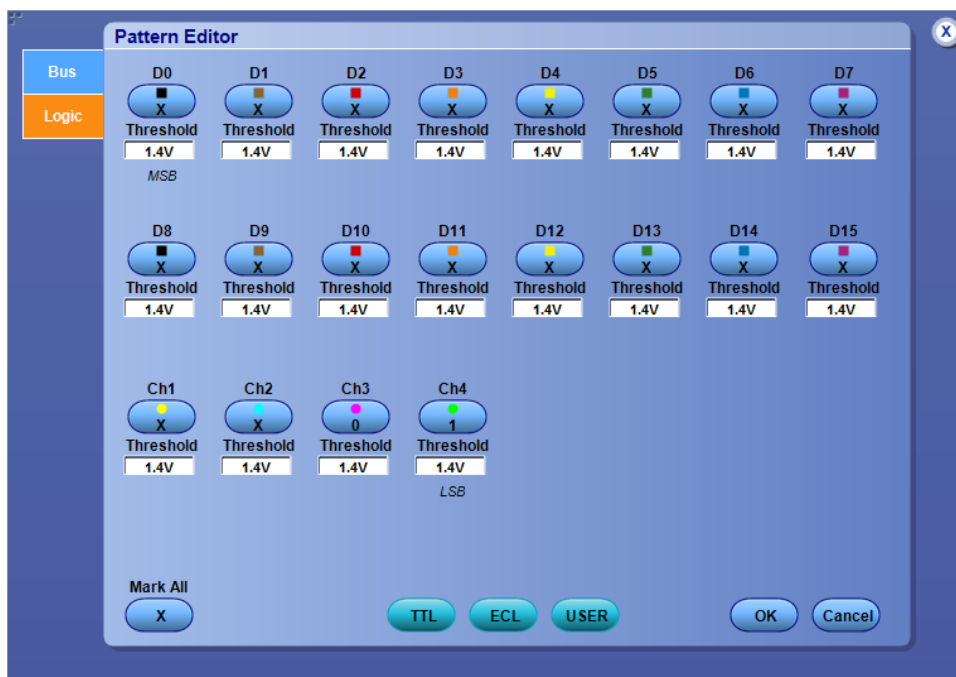

What do you want to do next?

[Learn how to define a pattern for a bus.](#)

[Learn about bus setups.](#)

Bus pattern editor (Live tab)

Use the controls to set the bus trigger pattern of the channels the instrument uses as logic waveforms to detect a parallel or serial bus value. Click a channel button to select the value for that channel: 0, 1, or X. For convenience, you can also change the voltage reference level threshold values.

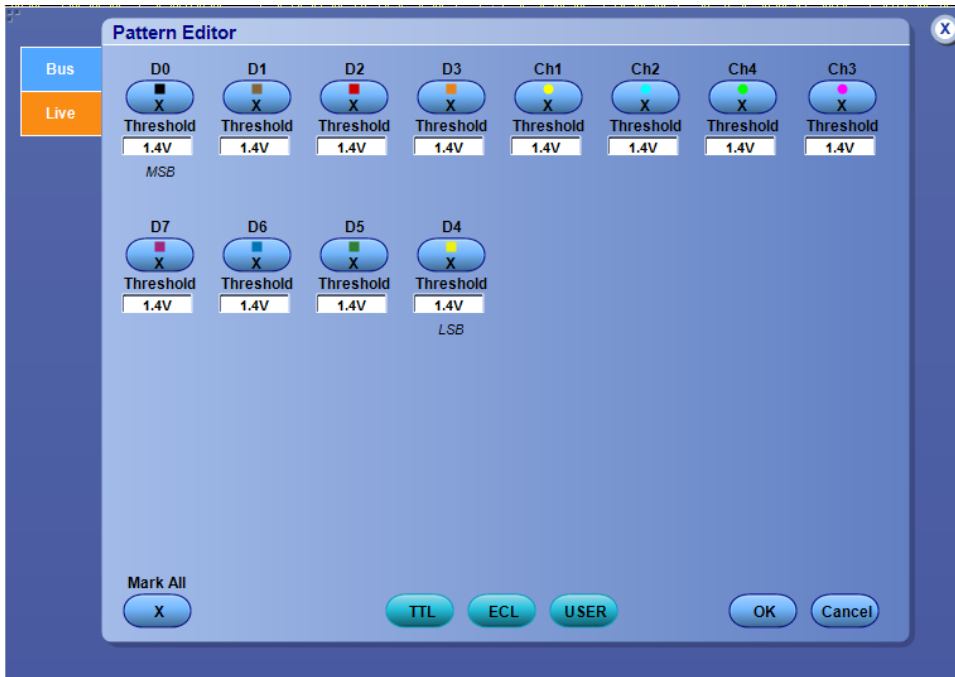

What do you want to do next?

[Learn how to define a pattern for a bus.](#)

[Learn about bus setups.](#)

Bus pattern format

For MSO7000C/DX Series instruments, from the Trigger menu, select the Bus trigger type. You can change the format of the bus pattern after you define a pattern.

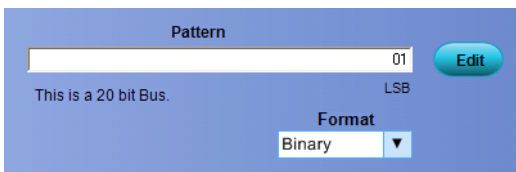

- Hex causes the instrument to display the bus pattern as a hexadecimal value.
- Binary causes the instrument to display the bus pattern as a binary value.
- Decimal causes the instrument to display the bus pattern as a decimal value.

Bus trigger on selections

For MSO Series instruments, select the type of data to trigger on. The available selections in the Trigger On drop-down list are different for each serial bus.

Set logic thresholds

NOTE. This online help file supports many oscilloscope models from Tektronix. This feature is only available on some models.

For the supported instruments, from the Trigger menu or from the Search and Mark menu, select the Bus, the Logic Pattern, or the Logic State trigger. Click the Logic Thresholds button to access the Threshold Setup dialog box.

Use the controls to set up the Threshold Setup parameters for a Pattern or a State trigger.

NOTE. When you select a Pattern or a State trigger as the B Event, digital channels are not available.

Levels / Thresholds Setup

Channels

Channel Settings: Shared

| Ch1 Level | Ch2 Level | Ch3 Level | Ch4 Level |
|-----------|-----------|-----------|-----------|
| 1.4V | 1.2V | 1.2V | 1.2V |

Digital Channels

| D7 Threshold | D6 Threshold | D5 Threshold | D4 Threshold | D3 Threshold | D2 Threshold | D1 Threshold | D0 Threshold |
|---------------|---------------|---------------|---------------|---------------|---------------|--------------|--------------|
| 1.4V | 1.4V | 1.4V | 1.4V | 1.4V | 1.4V | 1.4V | 1.4V |
| D15 Threshold | D14 Threshold | D13 Threshold | D12 Threshold | D11 Threshold | D10 Threshold | D9 Threshold | D8 Threshold |
| 1.4V | 1.4V | 1.4V | 1.4V | 1.4V | 1.4V | 1.4V | 1.4V |

Digital Threshold:

Apply OK

The instrument displays a different Threshold Setup dialog box for each type of bus defined: parallel or serial types.

This is an example of the Threshold Setup dialog box when you select a parallel bus in the Bus list of the Trigger menu.

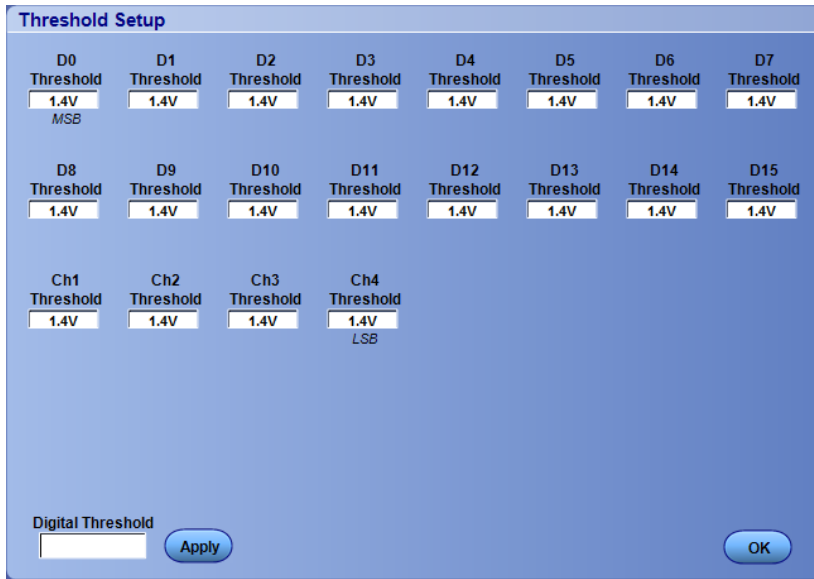

This is an example of the Threshold Setup dialog box for a 4-bit parallel bus.

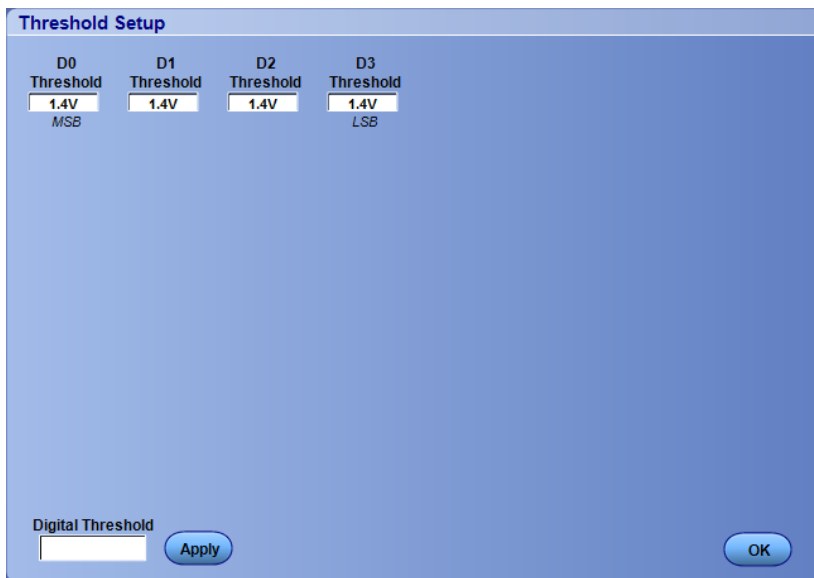

This is an example of the Threshold Setup dialog box for an I2C serial bus.

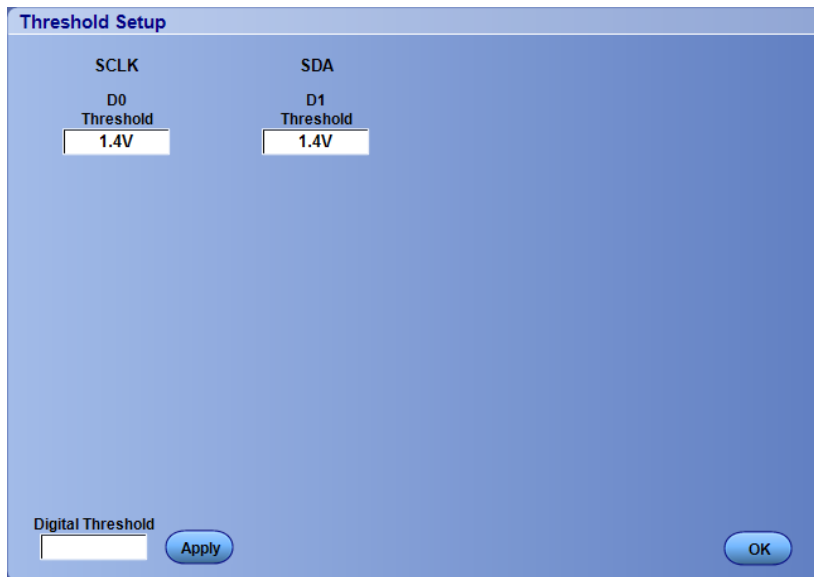

The dialog box is titled "Threshold Setup" and has a blue background. It contains two columns of settings. The left column is for "SCLK" and has a "D0 Threshold" field with the value "1.4V". The right column is for "SDA" and has a "D1 Threshold" field with the value "1.4V". At the bottom left, there is a "Digital Threshold" field which is empty. At the bottom right, there are two buttons: "Apply" and "OK".

This is an example of the Threshold Setup dialog box for an SPI serial bus.

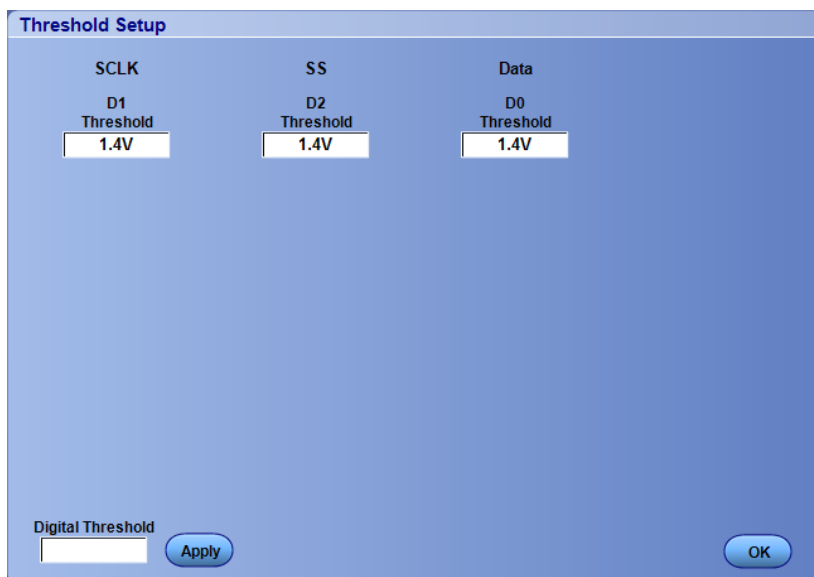

The dialog box is titled "Threshold Setup" and has a blue background. It contains three columns of settings. The left column is for "SCLK" and has a "D1 Threshold" field with the value "1.4V". The middle column is for "SS" and has a "D2 Threshold" field with the value "1.4V". The right column is for "Data" and has a "D0 Threshold" field with the value "1.4V". At the bottom left, there is a "Digital Threshold" field which is empty. At the bottom right, there are two buttons: "Apply" and "OK".

This is an example of the Threshold Setup dialog box for an RS232 serial bus.

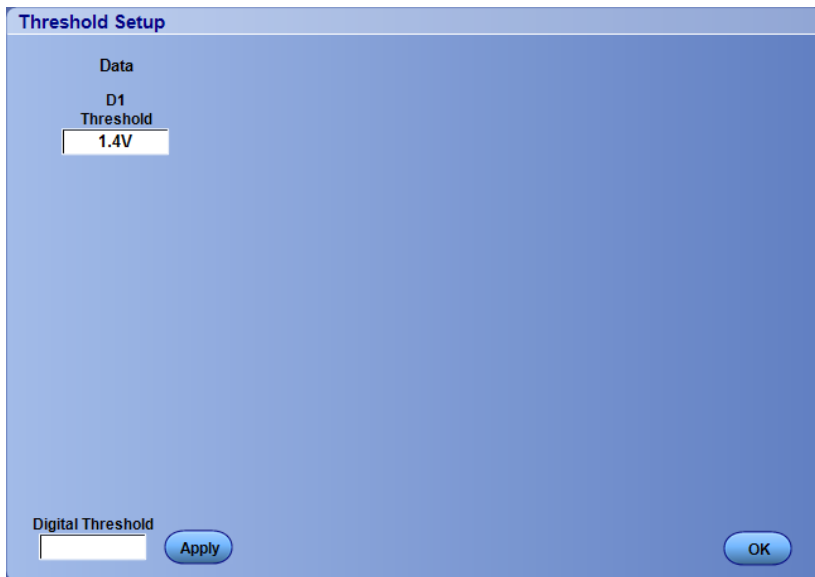

This is an example of the Threshold Setup dialog box for an USB serial bus.

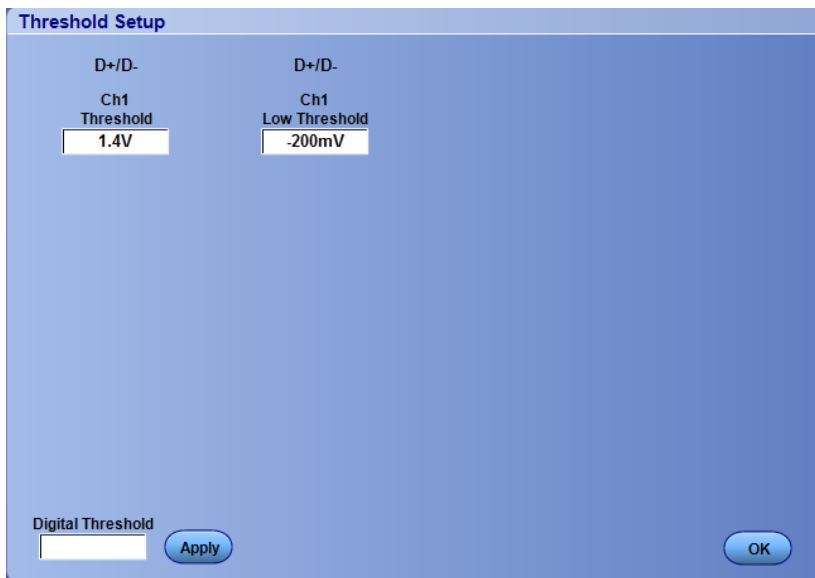

What do you want to do next?

[Learn about the Global Threshold field.](#)

[Learn about bus setups.](#)

Select the coupling

From the Vertical menu, select Vertical Setup.

Overview. Use the Coupling controls to couple the signal from the attached probe to the instrument.

Available controls depend on the instrument model, selected termination, and attached probe. Some example control groups are shown.

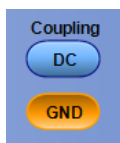

To use.

- Select DC to display waveforms with AC and DC components.
- Select AC to display waveforms with AC components.
- Select GND to display a zero-volt waveform. Use this selection to establish the ground reference point on the display.

What do you want to do next?

[Continue to learn about the Vertical Setup controls.](#)

[Return to the Vertical Setup control window overview.](#)

Set display characteristics

From the Vertical menu, select Vertical Setup.

To use.

1. Click Display to turn the channel waveform display on and off.
2. [Assign a label to the waveform](#) with the pop-up keyboard to make it easier to identify on the screen.
3. Set the units of vertical scale in the Units text box.



Behavior. The tab selector on the side of the Vertical Setup control window identifies the channel waveform source. The Display button, the label, and units apply only to the selected waveform.

Each waveform (channel, math, or reference) has its own Display button, label, and units. If you do not enter a label for the selected waveform, the label will be left blank. You can position the label anywhere on the graticule by clicking and dragging it to the desired location.

Any displayed channel waveform can be turned off without impacting any math functions, measurements, or histograms done on that waveform. You may want to turn some waveform displays off to make the remaining waveforms easier to view and analyze.



TIP. Use the dedicated front-panel Ch <1 - 4> buttons to turn the channel waveforms on or off.

What do you want to do next?

[Continue to learn about the Vertical Setup controls.](#)

Set the offset

From the Vertical menu, select Vertical Setup.

To use. Use the Offset controls to set the value of the selected Channel vertical offset. This shifts the vertical [acquisition window](#) to match the waveform data you want to acquire.

1. Click a channel tab to select the vertical input channel.
2. Click in the Offset entry box and use a multipurpose knob to set the offset value.



Behavior. Use the Offset control to eliminate *clipping the waveform*. The offset control affects the vertical acquisition window by subtracting a DC bias from the waveform. This moves the level at the vertical center of the acquisition window of the selected channel. Visualize offset as scrolling the acquisition window toward the top of a large signal for increased offset values and scrolling toward the bottom for decreased offset values.

The offset control affects the waveform display by defining the channel reference indicator to match the offset rather than the ground level. The offset affects only channel waveforms as compared to the position control that affects all waveforms, including math and reference waveforms.

What do you want to do next?

[Continue to learn about the Vertical Setup controls.](#)

Set the vertical position-scale

From the Vertical menu, select Vertical Setup.

To use. Use the Position control to set the vertical position of the waveform and the Scale control to set the vertical scale.

1. Click a Chan <1–4> tab to select the waveform on screen.
2. Click in the Position entry box and use the multipurpose knobs to adjust the position of the waveform.
3. Click in the Scale entry box and use the multipurpose knobs to adjust the vertical sensitivity.

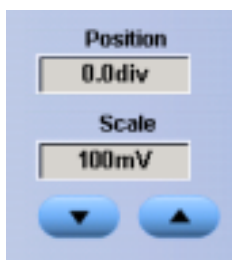

TIP. You can also use the dedicated Position and Scale knobs on the front panel to control the position and scale of the selected waveform.

Behavior. Each waveform has its own vertical Position control. The control increases or decreases the vertical position of the waveform 0.2 divisions (0.02 divisions using the Fine knob). Increasing the position value of the waveform moves the waveform up, and decreasing the position moves the waveform down.

Each waveform also has its own vertical Scale control. For a signal with a constant amplitude, increasing the scale causes the waveform to appear smaller. Decreasing the scale causes the waveform to appear larger.

For channel waveforms, the scale setting controls the vertical size of the [acquisition window](#) as well as the display scale. The range and resolution of the scale value depends on the attached probes and any other external factors that you may have specified.

NOTE. The vertical system bandwidth (B_{Ω}) readout will display the probe tip bandwidth if the tip is limiting the bandwidth of the selected channel. See [User interface map](#) for the location of the readouts.

What do you want to do next?

[Continue to learn about the Vertical Setup controls.](#)

Multipurpose knobs

The multipurpose knobs can be used to set screen interface parameters (On DPO70000SX instruments requires the DPO7AFP accessory). To use, click a control on the screen to map it to the multipurpose knob(s).

| Control | Description |
|---|--|
| <p>On MSO/DPO5000B Series instruments</p> | <p>You can undo any mapping by right-clicking the multipurpose knob(s) and selecting Deassign Multipurpose Knobs, or from the Utilities menu, select the Deassign Multipurpose Knobs command. The mapping is deassigned until you perform that function again.</p> <p>Turn the knob(s) or scroll with the mouse wheel until the desired selection appears in the readout mapped to the knob. Push the FINE button, or click the mouse wheel to use the knob to make small changes, for example, to add another decimal place for greater accuracy.</p> <p>When no control windows are open and cursors are turned on, the multipurpose knobs control the cursor positions.</p> |

NOTE. These knobs are automatically mapped when certain functions are performed, for example, when the MultiView Zoom button is pushed.

Bandwidth readout (BW)



Nominal system bandwidth consists of a combination of factors including, but not limited to, probe bandwidth, probe tip bandwidth, and bandwidth selections made in the Vertical Setup Control Window.

Select the probe controls

From the Vertical menu, select Vertical Setup.

Overview. The Probe controls provide access to the Probe Setup, Compensation, Deskew, and Attenuation control windows.

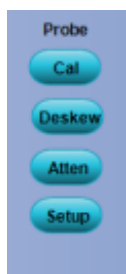

To use. Click the Probe buttons to display the Probe Setup control windows:

- Use [Setup](#) to configure the attached probe type. The setup will vary depending on the individual probe you connect.
- Use [Cal](#) to check the status of the attached probe and to compensate the entire signal path from the probe tip to the digitized signal.
- Use [Deskew](#) to compensate the vertical channels for propagation delays of different length probes.
- Use [Atten](#) to change the default attenuation or gain for the selected probe channel.

What do you want to do next?

[Learn more about the Attenuation controls.](#)

[Learn more about the Deskew controls.](#)

[Learn more about the Probe Compensation controls.](#)

[Return to the Vertical Setup control window overview.](#)

Select the termination

From the Vertical menu, select Vertical Setup.

To use. Use the Termination controls to select the channel input resistance:

For DPO7000C and MSO/DPO5000B oscilloscopes:

- Select 1 M Ω for use with *high impedance passive probes*.
- Select 50 Ω for use with most *active probes* and low impedance (Z_0) probes.

NOTE. Termination is automatically set for TPP0500 and TPP1000 Series probes on the MSO/DPO5000B Series instruments.



For MSO/DPO7000C/DX and DPO7000SX oscilloscopes, Termination is fixed at 50 Ω .



Behavior. The correct termination is set automatically when you attach a probe with a [TekProbe/TekVPI interface](#) to the instrument. However, you may have to set the termination manually if you use a probe without a TekProbe Interface.

Consider the following when using 50 Ω termination with any channel:

- AC coupling is not available with 50 Ω termination.
- The instrument reduces the maximum vertical scale setting for the channel with a X10 probe attached, since the amplitudes appropriate for the higher settings would overload the 50 Ω input.
- The instrument switches to 50 Ω and disables AC coupling (and switches coupling to DC if AC is selected) if you connect an active probe. The active probes also reduce the maximum vertical scale setting as described above. This behavior results in 50 Ω , nonalternating current coupling, which is appropriate for active probes.

What do you want to do next?

[Continue to learn about the Vertical Setup controls.](#)

[Return to the Vertical Setup control window overview.](#)

Low impedance probes

Most low impedance (Z_0) passive probes measure frequencies or timing measurements more accurately than general-purpose probes, but they take less accurate amplitude measurements. They offer a higher bandwidth to cost ratio.

The low input impedance passive probes must be terminated in a 50 Ω instrument input. Input capacitance is much lower than high impedance passive probes, typically 1 pF, but input resistance is also lower (500 Ω to 5000 Ω typically). Although that DC loading degrades amplitude accuracy, the lower input capacitance reduces high frequency loading to the circuit under test. That makes low input impedance passive probes ideal for timing and phase measurements when amplitude accuracy is not a major concern. Low input passive impedance probes are useful for measurements up to 40 V.

Set the termination voltage

Termination Voltage is available only on MSO/DPO70000DX/SX Series instruments.

From the Vertical menu, select Vertical Setup.

To use. Use the Termination Voltage control to set the channel termination voltage:

- Click **Termination Voltage**.
- Set the termination voltage using the keypad or multipurpose knobs.

Behavior. Oscilloscope inputs have traditionally been terminated to ground. The signals being measured often are not ground referenced. Pulling signals to ground can impair measurement results or potentially damage the DUT.

The instrument delivers variable termination voltage up to ± 3.5 Volts to the device under test (DUT), and supports a large offset range.

This allows you to adjust the oscilloscope to mirror the conditions and behavior of the DUT, and measure high-speed signals in an environment similar to the one in which they operate.

Using the combination of termination voltage and offset to center the oscilloscope reference point in the operating range of the DUT maximizes the available dynamic range and minimizes the noise of the measurement system.

What do you want to do next?

[Continue to learn about the Vertical Setup controls.](#)

[Return to the Vertical Setup control window overview.](#)

Video trigger autose

Autose automatically sets the video trigger controls for the selected format and optimizes the vertical sensitivity and time per division for viewing video lines and fields. These controls do not appear if you select the Custom format.

- Click Lines or Fields to optimize the settings.

Select the video trigger format

Select one of the predefined video signal formats from the drop-down list:

- 525i/NTSC
- 625i/PAL
- SECAM
- Bilevel
- Trilevel
- 1080i/60
- 1080i/50
- 480p/60
- 576p/50
- 720p/30
- 720p/50
- 720p/60
- 875i/60
- 1080/24sF
- 1080p/24
- 1080p/25
- 1080p/30
- 1080p/50
- 1080p/60

Specify the video trigger holdoff

1. Click in the Holdoff field.
2. Specify Holdoff By Time or By Fields.
3. Use the multipurpose knob to change the value.

If you are setting a Custom format, only the By Time control is available.

Select the video trigger polarity

Select either Normal or Inverted polarity.

- Normal. This polarity generally triggers on the negative polarity, since the sync pulse leading edge is negative for most standard formats.
- Inverted. Use this polarity when probing circuitry that inverts the video signal.

Working with your oscilloscope

The following topics describe features of your Tektronix oscilloscope. Even if you are an experienced user, you may want to browse through these topics to learn new ways of doing familiar tasks.

Basic operations.

- [Using the Instrument Interface](#)
- [Changing Control Settings](#)
- [Moving and Docking Control Windows](#)
- [Controlling from within the Graticule Area](#)
- [Initializing the Instrument](#)
- [Choosing and Connecting Probes](#)
- [Creating your Own Control Windows](#)

Waveform operations.

- [Using Time Bases and Triggering](#)
- [Looking at Waveform Details](#)
- [Using Fast Acquisition and DPO](#)
- [Using Logic Waveforms MSO Series](#)
- [Using Waveform Math](#)
- [Using Spectral Analysis](#)
- [Characterizing a Signal](#)
- [Adding Application-Specific Measurements](#)

Windows environment.

- [Connecting to a Network](#)
- [Printing a Hard Copy](#)
- [Using Other PC Applications](#)
- [Using a Second Monitor](#)
- [Connecting to Other Instruments](#)
- [Access Shortcut Menus with Right-click](#)

Set the window trigger levels

The upper and lower threshold levels define the voltage limits of the window.

To adjust the upper threshold level:

1. Click the Upper Level entry box.
2. Use the multipurpose knob to set the voltage level.

To adjust the lower threshold level:

1. Click the Lower Level entry box.
2. Use the other multipurpose knob to set the voltage level.

Index

- 3 dB BW in bins, 727
- 8B10B bus
 - setting up, 585
- 8B10B serial bus
 - trigger, 316
- 8B10B Serial Bus
 - search for any character, 317
 - search for character symbol, 317
 - search for data, 317
 - search for error, 317
 - search for pattern, 317
 - Trigger on Any Control Character, 387, 399
 - Trigger on Character/Symbol, 387, 399
 - Trigger on Error, 387, 399
 - Trigger on Pattern, 387, 404, 406
- A**
- A event trigger types, 379, 380
- AC line voltage, 665
- Accessories, 4
- ACos, 741
- Acquire data, 654
- Acquired waveform, 655
- Acquisition
 - control window, 199
 - hardware, 660
 - Incompatible features, 659
 - interval, 200
 - Interval, 741
 - modes, 768
 - preview, 683
 - run/stop button, 78
 - setting modes, 580
 - setup control window, 188
 - single button, 78
 - starting and stopping, 78
 - status lights, 78
 - system, 651
 - window, 489, 741, 841, 856, 857
- Active probes, 4, 45, 74, 578, 655, 742
- Add sources
 - parallel bus, 149
- Adjust, 248, 650, 683
- Advanced trigger button, 76
- Aliasing
 - recognizing, 735
- Amplitude measurements, 91, 274, 742
- Analog
 - oscilloscopes, 65, 176, 179, 644
 - signal, 188
 - simulating, 176, 179, 644
- Analog channel, 579
- Analog signal
 - setting up, 579
- Analysis tools, 19
- Annotation, 563
- Application software packages, 22, 26, 67, 647
- Applications, 15
- Arbitrary filters, math, 783
- ASin, 742
- ATan, 742
- Attenuation, 67, 509, 859
- Auto trigger mode, 742
- Auto-increment file name, 617
- Autofit
 - masks, 226
- Automatic measurements, 274, 597, 600, 684
- Autoscroll, 797
- Autoset
 - autoset considerations, 660
 - button, 79
 - horizontal mask controls, 781
 - input conditioning, 654
 - mask alignment controls, 226
 - mask autoset mode, 781
 - mask configuration control, 224
 - undo, 191
 - vertical mask controls, 782
- Autoset preferences, 191
- Auxiliary front panel, 61
- Auxiliary input connector, 69
- Auxiliary trigger, 665
- Average, 265, 827
- Averaging

- acquisition mode, 768
- math waveforms, 604

B

- B event trigger, 461
- Bandwidth
 - control window, 495
 - enhancement, 496, 654
 - readout, 859
- Blackman-Harris window
 - defined, 732
- Bus
 - 8B10B serial trigger, 316
 - configuring, 587
 - custom serial trigger, 363
 - DDR serial trigger, 361
 - Ethernet serial trigger, 356
 - I2C serial trigger, 323
 - MIL-1553 serial trigger, 353
 - MIL-STD-1553 serial trigger, 353
 - parallel trigger, 364, 385
 - RS-232 serial trigger, 318
 - SPI serial trigger, 321, 340, 342, 346, 349
 - trigger, 364
 - USB serial trigger, 327
- Bus clear, 111
- Bus decode method, 158
- Bus display, 111
- Bus display components, 157
- Bus display views, 157
- Bus layers, 157
- Bus list, 109, 110
- Bus menu options
 - bus display, 111
 - bus list, 109, 110
 - bus position, 113
 - clear bus, 111
 - configure, 154
 - decode method for parallel buses, 158
 - display bus components for parallel buses, 157
 - number of lanes, 135
 - parallel bus and clock polarity, 153
 - parallel bus and clock source, 152

- parallel bus and remove a channel, 152
- parallel bus setup, 147, 148
- parallel bus source, 149
- serial bus channel threshold, 140
- serial bus data rate, 138
- serial bus input, 139
- serial bus threshold high, 139
- setup, 107

- Bus pattern editor
 - bus tab, 844
 - live tab to set thresholds, 849
 - logic tab to set thresholds, 848
- Bus pattern editor (DPO/MSO5000B Series)
 - bus tab, 845
- Bus position, 113
- Bus trigger
 - defined, 669

C

- Calibration
 - probe, 859
- CAN Serial Bus
 - Trigger on Pattern, 401, 408
- Capturing the screen, 524
- Center frequency
 - control, 719
- Changing cursor positions, 94
- Channel position
 - digital inputs, 102
- Channel selector, 473, 744
- Channel threshold
 - digital inputs, 102
- Checking trigger status, 622
- Clear bus, 111
- Clear data control, 744
- Clipping, 655
- Clipping waveforms, 489, 490, 856
- Clock polarity
 - parallel bus, 153
- Clock source
 - parallel bus, 152
- Coefficients, 727
- Coherent gain, 727
- Color palette
 - black and white, 519, 541

- color, 519, 541
- gray scale, 519
- gray-scale, 541
- monochrome gray, 65, 179, 644
- monochrome green, 65, 179, 644
- normal, 179
- spectral, 179
- temperature, 179
- Comm trigger control window, 414
- Comm trigger pulse form, 746
- Comm triggering, 670
- Communication mask triggering, 637
- Communication trigger
 - defined, 669
- Communication trigger codes and standards option, 744
- Comparing data, 621
- Compensate
 - probe, 504, 578
- Compensation
 - instrument, 554
 - probe, 513, 578
 - signal path, 577
- Components for display of parallel buses, 157
- Configure e-mail, 757
- Configure mask, 222
- Connect
 - signal, 653
- Connecting probes, 45
- Connecting to a system under test
 - logic probe, 100
- Connectivity tools, 19
- Connector cleaning, 36
- connector protection, 37
- Connectors
 - Audio port, 81
 - AUX TRIG OUT, 81
 - CH3 OUT, 81
 - COM 1, 81
 - COM 2, 81
 - Connectors
 - 12.5 GHz clock, 81
 - DisplayPort, 81
 - DVI-I, 81
 - EXT REF, 81
 - front panel, 69
 - GPIO, 81
 - LAN, 81
 - parallel port, 81
 - PS-2 keyboard, 81
 - REF OUT, 81
 - serial port, 81
 - side panel, 81
 - signal out, 81
 - trigger port, 81
 - USB, 81
 - video port, 81
- Compensate
 - probe, 499
- Continuous mask testing, 234
- Control
 - frequency domain, 715
 - gating, 715
 - time domain, 715
- Control window handle, 43
- Control windows
 - acquisition mode, 199
 - adjust parameters, 248
 - advanced math setup, 247
 - attenuation, 509
 - autoset undo, 191
 - AUX OUT configuration, 552
 - bandwidth, 495
 - bus configuration, 154
 - bus setup, 107
 - copy setup: images, 519
 - copy setup: measurements, 522
 - copy setup: waveforms, 520
 - coupling, 492
 - cursor position, 90
 - cursor setup, 85
 - cursor type setup, 87
 - deskew, 507
 - deskew/attenuation/Invert, 493
 - digital setup, 99
 - display on-off, 486
 - display setup, 169
 - docking, 43
 - edge trigger, 416
 - equation editor, 262

- Freq/Per trigger, 417
- gating, 292
- glitch trigger, 419
- GPIB configuration, 551
- histogram, 294
- horizontal & acquisition setup, 183
- horizontal position/scale, 186
- instrument compensation, 554
- instrument diagnostics, 556
- label, 488
- logic pattern trigger, 423
- logic state trigger, 431
- mark, 299
- mask setup, 219
- measurement setup, 272
- measurement statistics, 289
- moving, 43
- page setup dialog box, 525
- position-scale, 487
- probe compensation, 499
- qualification expression editor, 472
- recall instrument setup, 534
- recall visual trigger setup, 475
- reference levels, 290
- reference waveform, 529
- resolution, 198
- run/stop, 194
- runt trigger, 423
- save instrument setup, 533, 539
- search and mark, 310
- setup and hold trigger, 426
- spectral setup, 252
- termination, 810
- text properties, 171
- timeout trigger, 432
- transition time trigger, 435
- trigger mode, 382
- trigger mode & holdoff, 476
- trigger setup, 379
- user preferences: keypad defaults, 561
- user preferences: prompt before action, 561
- vertical acquisition, 656
- vertical offset, 489
- vertical setup, 481
- waveform display, 486
- waveform label, 488
- width trigger, 439
- zoom, 202, 485
- Controls
 - search and mark, 310
- Copy Event Table, 369, 370
- Copy setup control window
 - images, 519
 - measurements, 522
 - waveforms, 520
- copying
 - images, 26, 519
 - measurements, 26, 522, 524
 - screen, 26
 - waveforms, 520
- Copying waveform data, 740
- Cos, 747
- Cosh, 747
- Coupling
 - control window, 492
 - controls, 855
- Creating
 - create math waveforms, 604, 702
 - custom control windows, 45
 - math waveforms, 701
 - spectral Waveforms, 612
 - user masks, 607, 610
- CSV Text Format, 804
- Cursor
 - button, 79, 85
 - function, 699
 - horizontal, 87, 91, 699
 - limitations, 94
 - measurements, 94, 597
 - modes, 85, 93
 - paired, 87
 - position control window
 - XY display
 - XY display, 797
 - readouts, 91–93, 178
 - screen, 93
 - setup control window, 85
 - split, 87

- type control window, 87, 699
 - units, 90
 - vertical, 87, 92, 699
 - waveform, 92, 699
 - Cursor measurements
 - sources, 88, 595
 - styles, 89
 - units, 94
 - XY Display Format, 96
 - Cursor Sources
 - XY display, 747
 - YT display, 88
 - Cursors menu options
 - controls, 87
 - mode, 93
 - on/off button, 85
 - position, 90
 - setup, 85
 - type, 87
 - Custom bus
 - setting up, 586, 587
 - Custom control window
 - editing, 594
 - Custom controls, 809
 - Custom serial bus
 - trigger, 363
 - Customer feedback, 18
 - Customer support, 16
 - Customize color, 644
- ## D
- Date, 550
 - dB, 721
 - dBm, 721
 - DC offset, 706
 - DDR serial bus
 - trigger, 361
 - Dead time, 193
 - Deassign multipurpose knobs, 560
 - Decode method for parallel buses, 158
 - Default settings for histograms, 641
 - Default setup button, 45, 79
 - Defining a spectral math waveform, 613
 - definition, 671
 - Delay button, 75, 772
 - Delay measurement
 - setup, 806
 - Delay mode, 187, 766, 767
 - Delete
 - setups, 532, 535
 - waveforms, 532, 535
 - Deskew
 - control window, 507
 - interaction with fast acquisition, 193, 507
 - procedure, 45, 578, 859
 - Diagnostics, 556
 - Digital channel position, 102
 - Digital channel threshold, 102
 - Digital menu options
 - setup, 99
 - Digital oscilloscopes, 65
 - Digital probe, 100
 - Digital signal acquisition system, 651
 - Digital signals
 - connecting a logic probe, 100
 - Digitals
 - saving, 546
 - Digitizer, 660
 - Disk drive signals, 67
 - Display
 - format, 169
 - XY format, 175
 - XYZ format, 175
 - YT format, 175
 - Display bus, 111
 - Display elements, 678
 - Display format XY, 176
 - Display menu options
 - appearance, 169
 - colors, 173
 - date & time, 172
 - format, 175
 - graticule, 178
 - objects, 172
 - palette, 179
 - persistence, 174
 - screen text, 170
 - setup, 169, 170, 172, 173
 - style, 752
 - waveform interpolation, 177

- Display palette, 644
- Display resolution, 1
- Displayed waveform, 655
- Displaying waveforms, 642
- Displays
 - appearance, 169, 650
 - color palette, 173
 - colors, 173, 179, 753, 754
 - contrast, 650
 - control window, 486
 - intensity, 176
 - objects, 172
 - on/off, 855
 - persistence, 174
 - persistence control window, 798
 - screen objects, 172
 - screen text, 170
 - setup control window, 169, 170, 172, 173
 - styles, 752
 - trigger marker, 754
 - waveform Display control window, 486
 - XY format, 643, 752
 - XYZ format, 752
- Dockable windows, 27, 647
- Documentation, 15
- Dots, 752
- DPO, 65, 193
- DPO7AFP, 61
- Dual display, 22, 27, 647
- E**
- E-mail configuration dialog box, 757
- E-mail on
 - event, 611
 - limit test failure, 537, 557
 - mask test failure, 537, 557
 - trigger, 537, 557
- E-mail on event control window, 537, 557
- E-mail on event setup window, 558
- Edge button, 76
- Edge trigger control window, 416
- Edit custom window, 377
- Edit mask, 240
- Edit menu, 839
- Edit menu options
 - clear data, 744
 - copy, 524
 - copy setup, 519, 520, 522
 - select for copy, 524
 - Undo last autoset, 191
- Edit MyScope, 377
- Editing a user mask, 755
- Editing MyScope control windows, 594
- Effective number of bits
 - enhanced, 192
- Eliminating aliases, 261
- Enabling a network connection, 649
- Enhance Bandwidth, 496
- Enhanced effective number of bits, 192
- ENOB, 192
- Envelope mode, 768
- Equation editor
 - as an option, 66
 - control window, 262
 - edit controls, 474, 755
 - spectral analysis, 262
 - using, 604
- Equivalent time mode, 196
- Error detector
 - error condition setup, 210
 - results tab, 205
 - source setup, 206, 208
 - test pattern setup, 209
- Errors, 699
- Ethernet serial bus
 - trigger, 356
- Ethernet Serial Bus
 - Destination port, 357
 - search for data, 357
 - search port, 357
 - Trigger on End of Packet, 411
 - Trigger on FCS (CRC) Error, 411
 - Trigger on Idle, 411
 - Trigger on IPv4 Header, 411
 - Trigger on MAC Addresses, 411
 - Trigger on MAC Length/Type, 411
 - Trigger on Q-Tag Control Information, 411
 - Trigger on Start Frame Delimiter, 411

- Trigger on TCP header, 411
 - Trigger on TCP/IPv4/MAC Client Data, 411
 - Event table
 - copy, 369, 370
 - export, 370
 - exporting, 371
 - saving, 371
 - selecting columns, 370
 - Event Table, 365
 - Exiting the application, 649
 - Export Event Table, 370, 371
 - Exporting
 - files, 541
 - images, 541
 - measurements, 540
 - waveforms, 802
 - Expression editor
 - visual trigger, 472
 - External reference, 188, 552
 - External signals control window, 552
 - external trigger, 69
 - Eye aperture, 738
 - Eye diagram, 738
 - eye diagrams, 752
- ## F
- failure log, 235
 - fast acquisition
 - turning on and off, 580
 - Fast acquisition, 193
 - Fast restart, 58
 - FastAcq button, 79, 193
 - FastFrame
 - analyze, 799
 - overview, 200
 - setup, 800, 825
 - time stamps, 201, 799
 - view, 801
 - FastFrames, 760, 775, 815
 - Feedback, 18
 - FFT
 - creating waveforms, 612, 826
 - display, 258
 - features, 257
 - locking waveforms, 828
 - magnitude waveforms, 612, 826, 830
 - phase waveforms, 826, 828
 - process, 257
 - window characteristics, 260
 - windows, 259, 819
 - File, 740
 - File menu options
 - display on/off, 486
 - exit, 649
 - export setup, 540, 541, 802
 - instrument setup, 533, 534, 539
 - label, 488
 - page setup, 525
 - position/scale, 487
 - print, 526
 - print preview, 525
 - recall default setup, 534
 - recall wfm, 529
 - run application, 565
 - save wfm, 529
 - File name
 - auto-increment, 546
 - Filters, 783, 842
 - Fine button, 560, 840
 - Fixed license, 570
 - Flattop2 window
 - defined, 730
 - FLEX Serial Bus
 - trigger on cycle count, 406
 - trigger on header fields, 406
 - Floating license, 565, 568
 - Frequency domain
 - controls, 719
 - setup, 613
 - Frequency/Period trigger control window, 417
 - Front Panel
 - autoset, 79
 - channel buttons, 74
 - connectors, 69
 - controls, 74
 - cursors, 79
 - default setup, 45, 79
 - fast acquisition, 79, 193

- intensity, 65, 79
- position, 74
- print, 26, 79, 526
- scale, 74
- termination, 490, 810, 860, 861
- touch screen, 73, 554
- triggering from, 623

Functional model of instrument, 651

G

Gating

- a localized measurement, 599
- controls, 292
- in frequency domain, 719
- in zoom window, 292
- position, 718
- with cursors, 92

Gaussian window

- definition, 731

Glitch trigger

- control window, 419

Glitch triggering, 627

GPIO

- address, 551
- GPIO configuration control window, 551
- programming, 647

Graticule

- and cursors, 92
- controlling within the graticule area, 44
- display elements, 678
- exporting, 541
- labels, 488
- styles, 178
- zoom, 63

Graticule size, 810

Graticule zoom control window, 810

H

H Bar cursors, 87, 91

Hamming window

- defined, 732

Hanning window

- defined, 732

Hardware

- acquisition, 660

hardware applications

- adding, 647
- removing, 647

harmonics, 735

Help

- about tekscope, 21

Hi Res mode, 768, 815

high input impedance probes, 74, 761, 860, 861

High/low method, 684

histogram, 67

Histogram

- automated measurements, 641
- control window, 294
- interaction with fast acquisition, 193
- measurements, 294
- reference level considerations, 290
- vertical, 641

Histogram counting, 641

Histogram mode, 684

Histograms

- saving, 538

Hits, 237

holdoff, 384, 476

Horiz/Acq menu options

- acquisition mode, 199
- autoset, 189
- delay mode on, 772
- equivalent time, 196
- fast acquisitions, 193
- horizontal/acquisition setup, 183, 188
- position/scale, 186
- resolution, 198
- roll mode auto, 195
- run/stop, 194
- zoom controls, 485
- zoom graticule, 202
- zoom lock, 202
- zoom setup, 202

Horizontal acquisition

- bar cursors, 91
- control window readouts, 773
- delay, 62, 63, 187, 443, 621, 657, 677, 766, 767, 772, 821
- delay off, 675

- delay on, 676
- interrelated parameters, 658
- parameters, 658
- position, 657, 662, 683
- position & scale control window, 186, 766, 768
- position controls, 75, 186, 766
- reference, 678
- reference point, 683
- scale controls, 75, 186, 766, 768, 773
- scale setting, 654
- setup control window, 183
- window, 655, 659

Horizontal position, 765

I

- I2C
 - definition, 107
- I2C bus
 - setting up, 584
- I2C serial bus
 - trigger, 323
- I2C Serial Bus
 - search for address, 324
 - search for address and data, 324
 - search for data, 324
 - search for missing ack, 324
 - search for repeated start, 324
 - search for start, 324
 - search for stop, 324
- Impulse-response testing, 734
- Incompatible acquisition features, 659
- Independent cursor mode, 93
- Independent triggers, 836
- Indicator
 - trigger correction, 478
- Initializing the oscilloscope, 45
- Ink saver, 26
- Input
 - resistance, 655
 - termination, 655
- Input amplifier, 660
- Input channel
 - acquisition hardware, 660
 - conditioning, 654

- trigger sources, 665
- input connector protection, 37
- Input signal
 - setting up, 579
- Installing options, 565
- Installing software, 775
- Instrument calibration
 - calibration control window, 554
 - signal path compensation, 554
- Instrument diagnostics control window, 556
- Instrument setups
 - deleting, 646
 - recalling or restoring, 534, 646
 - saving, 533, 539, 645
 - visual trigger setup, 475
- Instrument stacking, 47
- Intensified samples, 752
- Intensity knob, 65, 79, 176
- Interaction of acquisition features, 659
- Interface, 27
- Interpolation, 663
- Invert, 495

J

- Jitter
 - analysis, 282, 647

K

- Kaiser-Bessel window
 - defined, 732
- Key features, 1
- Keyboard
 - pop-up, 40
 - use to change control settings, 40

L

- Labels, 488
- LAN server status control window, 552
- Level, 668
- Level knob, 76
- Line style cursor, 89
- Linear interpolation, 663
- Linear magnitude, 721

- List of bus setups, 109, 110
- Localizing a measurement, 599
- Lock mask, 223
- Logic clock input for a trigger, 778
- Logic probe
 - connecting to a system under test, 100
- Logic trigger pattern editor
 - bus tab, 777
 - digital tab, 778
- Logic triggers
 - logic pattern control window, 380, 423
 - logic state control window, 431
 - runt control window, 423
- Low input impedance probes, 74, 780, 860, 861

M

- Magnitude controls, 721
- Magnitude scale, 613
- magnitude waveforms, 612, 828, 830
- manuals, 15
- Margin tolerance, 736
- Mark
 - clear, 299, 300
 - mark all events, 638
 - set, 299, 300
- Mark all trigger events, 638
- Markers
 - cursor, 85
 - horizontal reference, 44
 - trigger level, 44
- Mask alignment controls, 226
- Mask autoset
 - autofit control, 780
 - automatic mode, 781
 - horizontal control, 781
 - trigger level control, 782
 - vertical control, 782
- Mask configuration
 - autofit controls, 225
 - autoset controls, 224
 - display control, 222
 - display controls, 223
- Mask editing
 - setup window, 227
- Mask hits
 - per segment, 237
- Mask margin
 - controls, 228
- Mask pass/fail
 - define source/tolerance, 228
 - set test notification, 229
 - view results, 235
- Mask polarity, 234
- Mask segments, 237
- Mask setup
 - mask sources control window, 228
 - mask testing control window, 219
- Mask test
 - controls, 805
 - repeat test, 234
 - set limits, 242
 - set pass/fail parameters, 232
 - start or reset, 238
 - summary, 236
- Mask testing
 - communication trigger, 669
 - options, 220
 - overview, 736
- Mask tolerance, 228
- Mask type
 - set polarity, 220
 - set standard, 220
 - standards, 221
- Math equation
 - create waveform, 604
 - operations on time base, 683
 - predefined expressions, 813
- Math equation editor
 - arbitrary filters, 783
 - display functions, 791
 - edit functions, 791
 - filter functions, 269
 - measurement functions, 268
 - spectral functions, 267
 - time functions, 263
 - variables functions, 268
- Math functions
 - custom, 250
 - plugin, 250
- Math menu options
 - Ch1 - Ch2, 813

- Ch1 * Ch2, 813
- Ch3 - Ch4, 813
- Ch3 * Ch4, 813
- display On/Off, 486
- position and scale, 487
- set averages, 248
- setup and control, 247
- spectral setup, 252
- Math plugins
 - using, 707
 - writing, 707
- Math setup control window, 247
- Math variables control window, 249
- Math waveform
 - averaging, 248
 - color, 753
 - create, 604, 701
 - defining, 600
 - differentiation, 703
 - entering functions, 263
 - FFT functions, 267
 - guidelines, 760
 - interactions, 702
 - label, 488
 - offset, 706
 - position, 706
 - properties, 792
 - scale, 600, 706
 - sources, 704
 - spectral, 616
 - using predefined expressions, 603, 813
 - variables, 268
- MATLAB
 - basic function interface, 713
 - creating with a class, 714
 - custom functions, 713
 - plugins, 250
- maximum input voltage, 35
- Maximum signal level, 655
- Mean, 67
- Measure amplitude, 91
- Measurement
 - annotation, 563
 - gating, 599
 - localizing, 599
 - phase, 287
 - snapshot, 271
- Measurement algorithms
 - amplitude, 689
 - area, 689
 - burst width, 689
 - cycle area, 689
 - cycle mean, 690
 - cycle RMS, 690
 - delay, 690
 - end, 687
 - EndCycle, 688
 - envelope waveforms, 697
 - extinction %, 690
 - extinction dB, 691
 - extinction ratio, 690
 - frequency, 691
 - high, 691
 - high, low, 686
 - HighRef, 686
 - histogram method, 686
 - hysteresis, 687
 - integration algorithm, 696
 - low, 692
 - LowRef, 686
 - maximum, 692
 - MCross1, 688
 - MCross1Polarity, 688
 - MCross2, 688
 - MCross3, 688
 - mean, 692
 - mean dBm, 692
 - Mid2Ref, 686
 - MidRef, 686
 - min-max method, 686
 - minimum, 692
 - missing samples, 698
 - negative duty cycle, 692
 - negative overshoot, 693
 - negative width, 693
 - optical power, 693
 - out of range samples, 698

- peak to peak, 693
- period, 693
- phase, 694
- positive duty cycle, 694
- positive overshoot, 694
- positive width, 694
- record length, 687
- rise time, 695
- RMS, 695
- start, 687
- StartCycle, 688
- TPOS, 688
- TSOFF, 688
- variables, 686, 691
- waveform record length, 688
- Measurement errors, 699
- Measurement menu options
 - amplitude measurements, 274
 - display statistics, 289
 - gating control window, 292
 - histogram measurements, 293
 - more tab, 284
 - reference levels, 290
 - reset histograms, 294
 - setup control window, 272
 - time measurements, 277
 - waveform histograms, 294
- Measurement readouts, 273
- Measurement Save Options, 558
- Measurement setups
 - delay, 806
 - phase, 807
- Measurement warnings, 698
- Measurements
 - amplitude, 274
 - automatic, 597, 598, 641
 - communication, 280, 282
 - control window, 272
 - cursor, 93, 597
 - gating, 92, 292
 - histogram, 290, 293, 641
 - horizontal, 92, 93
 - horizontal parameters, 92
 - interaction with fast acquisition, 193
 - list, 268, 795
 - mean, 289
 - miscellaneous, 284
 - reference levels, 290
 - standard deviation, 289
 - statistics, 289
 - statistics control window, 289
 - time, 277
 - using in math waveforms, 268
 - vertical, 92, 93
- Menu bar mode, 28
- MIL-1553 bus
 - setting up, 587
- MIL-1553 serial bus
 - trigger, 353
- MIL-1553 Serial Bus
 - Trigger on Command Word, 408
 - Trigger on Data, 408
 - Trigger on Error, 408
- MIL-STD-1553 serial bus
 - trigger, 353
- Min-max mode, 684
- Minimizing the display, 649
- Minimum value, 266
- MIPI CSI-2 bus
 - setting up, 585
- MIPI DSI-1 bus
 - setting up, 585
- MIPI Serial Bus
 - search for bus turn around, 335
 - search for end of transmission, 335
 - search for error, 335
 - search for escape mode, 335
 - search for long packet, 335
 - search for short packet, 335
 - search for start of transmission, 335
 - search for stop, 335
 - search for warning, 335
- Model numbers, 1
- Monitor, 22, 27, 647
- Moving control windows, 43
- Multi-instrument configuration
 - before startup, 49
 - connection order, 52
 - fast restart, 58

- features not available, 61
- instrument stacking, 47
- power on, 53
- Switching between modes, 58
- Time Synchronized mode, 56, 58
- Multipurpose knobs, 40, 560
- Multizoom
 - using, 643
- MyScope controls, 374, 809
- MyScope setup window, 373

N

- Negative pulse testing, 234
- Network connections, 23, 649
- New features, 863
- New tab, 373
- Number of lanes
 - setup, 135
- Nyquist frequency, 177, 261, 797
- Nyquist point, 735

O

- Offset
 - control, 856
 - math offset and position, 706
- Open custom window, 377
- Open MyScope window, 377
- Options
 - installation, 565, 568, 570
 - MTM, 737
- Options waveforms, 802
- Overview
 - functional, 651

P

- P value, 738
- Page setup dialog box, 525
- Paired cursors, 87, 92
- Parallel bus
 - add sources, 149
 - clock polarity, 153
 - clock source, 152
 - decode method, 158
 - display bus components, 157
 - remove a channel, 152
 - setting up, 583
 - setup for a clocked acquisition, 148
 - setup for an unlocked acquisition, 147
 - trigger, 364, 385
- Parallel bus options, 147–149, 152, 153
- Pass/fail mask test, 229
- Pattern editor for a bus
 - Bus setup control window, 844
- Pattern editor for a bus (DPO/MSO5000B Series)
 - Bus setup control window, 845
- Pattern editor for live tab
 - threshold setup, 849
- Pattern editor for logic tab
 - threshold setup, 848
- Pattern editor to trigger on a bus
 - Logic Pattern setup control window, 777
 - Logic State setup control window, 777
- Pattern editor to trigger on digital inputs
 - Logic Pattern setup control window, 778
 - Logic State setup control window, 778
- Pattern trigger
 - control window, 423
 - pattern triggers, 631
 - triggering on a pattern, 630
- PCIe Serial Bus
 - Trigger on Pattern, 399
- PDF documents, 15
- Peak detect mode, 768
- Performance verification, 15
- Persistence control window, 798
- Phase measurement
 - setup, 807
- Phase scale, 613
- Phase waveform, 66, 828
- pop-up
 - keyboard, 40
 - keypad, 40
- Position, 706
- Position a bus, 113
- Position control, 655
- Position correction, trigger, 478
- Position knob, 75, 772
- Position/scale control window

- position, 840
 - scale, 841
 - Positive pulse testing, 234
 - Posttrigger data, 379
 - Power down, 649
 - Powering on
 - multi-instrument power on, 53
 - Predefined math expressions, 813
 - Preferences
 - keypad defaults, 561
 - prompts, 561
 - trigger level presets, 561
 - user, 561, 562
 - Presets, 561
 - Pretrigger data, 379
 - Preview acquisition, 683
 - Print
 - button, 79
 - Printer
 - external, 4, 26
 - internal, 26, 525, 526
 - page setup, 525
 - selecting, 525
 - Printing
 - button, 79, 526
 - capturing the screen, 524
 - color palette, 26, 524–526
 - copying, 524
 - dialog box, 526
 - Ink saver, 26
 - page setup dialog box, 525
 - preview, 525
 - the screen, 524
 - to a printer, 26, 525, 526
 - Probe calibration procedure
 - restrictions, 813
 - Probe compensation
 - low frequency probes, 504, 578
 - Probe compensation procedure
 - passive probes, 578
 - Probe controls, 859
 - Probe setup
 - compensation, 504
 - control window, 501
 - status, 513
 - tip selection window, 506
 - Probe Setup Control Window, 499
 - Probe tip selection, 506
 - Probes
 - attenuation, 859
 - connecting, 45
 - deskew, 499, 859
 - termination, 74
 - types, 45
 - Product description, 1
 - Product feedback, 18
 - Product software, 4
 - Programmer guide PDF, 15
 - Programming, 647
 - Prompts, 561
 - Protocol Event Table
 - column layout, 368
 - docking, 366
 - resizing a docked table, 367
 - undocking, 366
 - Pulse form, 746
 - Pulse frequency trigger, 417
 - Pulse period trigger, 417
 - Pulse timeout triggering, 629
 - Pulse triggers, 380
 - Pulse width trigger, 439
 - Pulse width triggering, 628
- ## Q
- Qualification editor
 - visual trigger, 472
 - Qualification expression editor, 473
 - Quitting the application, 649
- ## R
- RBW, 719
 - Readouts, 274, 562
 - Recall dialog box instrument setups, 534
 - Recall instrument setup control window, 534
 - Recall user mask, 240
 - Recalling
 - masks, 815

- Setups, 739
 - template, 814
 - Waveforms, 740
- Recalling a template waveform, 814
- Recalling masks, 815
- recalling saved files
 - instrument setups, 646
 - reference waveforms, 531, 618
- Recalling waveforms, 740
- Recommended accessories, 4
- Record
 - Waveform, 662
- Record length, 657, 662, 815
- Rectangular window
 - defined, 734
- Reference color, 754
- Reference level, 721
- Reference level offset, 721
- Reference levels control window, 290, 529
- Reference levels method, 684
- Reference waveform controls, 529
- Reference waveforms, 529, 617, 618, 683
- Remote Desktop Connection, 181
- Remove a channel
 - parallel bus, 152
- Reset, 744
- Resolution, 261, 658
- Resolution bandwidth, 719
- Resolution control window, 198
- Resolution knob, 75
- Return floating license, 572
- Right-click, 45
- Roll mode
 - interactions with other settings, 775
 - setting up, 621
- RS-232 serial bus
 - trigger, 318
- RS-232 Serial Bus
 - search for data, 320
 - search for parity error, 320
 - search for start, 320
- Run/stop button, 78
- Run/stop control window, 194
- Runt pulse triggering, 627
- Runt trigger

- control window, 423

S

- Sample density, 663
- Sample interval, 658, 662
- Sample mode, 768
- Sample rate and user preference, 658
- Sampling
 - defined, 661
 - modes, 196
- Save As dialog box
 - digitals, 546
 - histogram, 538
 - instrument setup, 533, 539
 - measurement, 540
 - screen capture, 541
 - timestamp, 547
 - user mask, 544
 - visual trigger setup, 475
 - waveform, 530, 545
- Save custom window, 376
- Save Event Table, 371
- Save MyScope window, 376
- Save template, 243
- Saving
 - masks, 818
 - setups, 739
 - visual trigger setup, 475
 - waveforms, 740
- Saving a screen capture, 620
- Saving a waveform, 618
- Saving and copying waveform data, 740
- Saving masks, 818
- Saving measurements, 599
- Scale controls
 - math, 706
 - positioning, 655
- Scallop loss, 727
- Screen capture dialog box, 541
- Screen elements
 - control window, 171
 - cursors, 93
 - display text, 170

- objects control window, 172
- Search
 - configure, 303
 - controls, 310
 - count results, 308
 - mark all events, 638
 - mark table, 307
 - parameters, 306
 - place marks automatically, 306
 - select type, 300
 - show marks, 309
 - stop, 309
 - timing results, 307
- Search menu options
 - 8B10B serial bus setup, 316
 - custom serial bus setup, 363
 - DDR serial bus setup, 361
 - Ethernet serial bus setup, 356
 - I2C serial bus setup, 323
 - MIL-1553 serial bus setup, 353
 - parallel bus setup, 364
 - RS-232 serial bus setup, 318
 - SPI serial bus setup, 321, 340, 342, 346, 349
 - USB serial bus setup, 327
- Second monitor, 647
- Selecting an attenuator, 36
- Selecting the sound source, 233
- Sequential triggering
 - A event only, 446, 448, 626
 - after a delay, 450, 452, 626
 - B event, 454, 456, 626
 - triggering on a sequence, 625
 - with horizontal delay on, 821
- Serial bus
 - 8B10B trigger, 316
 - custom trigger, 363
 - DDR trigger, 361
 - Ethernet trigger, 356
 - I2C trigger, 323
 - MIL-1553 trigger, 353
 - MIL-STD-1553 trigger, 353
 - RS-232 trigger, 318
 - SPI trigger, 321, 340, 342, 346, 349
 - USB trigger, 327
 - Serial bus channel threshold setup, 140
 - Serial bus data rate setup, 138
 - Serial bus input setup, 139
 - Serial bus options, 135, 138–140
 - Serial bus threshold high setup, 139
 - Serial error detector
 - error condition setup, 210
 - results tab, 205
 - source setup, 206, 208
 - test pattern setup, 209
 - Serial mask testing, 737
 - Serial pattern data editor, 823
- Service manual, 15
- Set to 50%, 825
- Setting acquisition modes, 580
- Setting cursor sources, 595
- Setting the horizontal scale, 654
- Setting the vertical scale, 654
- setting time and date, 550
- Setting up mask testing, 605
- Setting up roll mode, 621
- Setting up signal input, 579
- Setup and hold trigger
 - control window, 426
- Setup window
 - triggering from, 624
- Setup/hold violations triggering, 634
- Setups
 - recalling, 739
 - saving, 739
- Shared triggers, 836
- Shortcuts, 45
- Shutting down the oscilloscope, 649
- Side lobe, 727
- Side panel connectors, 81
- Signal characterization, 67
- Signal connection, 653
- Signal input, 579
- signal path compensation, 515
- Signal path compensation procedure, 577
- Signal processing and transformation, 651

- Sin(x)/x interpolation, 663
 - Single button, 78, 194
 - Slope
 - trigger, 668
 - SMTP server address, 757
 - Snapshot, 271
 - Software
 - adding applications, 647
 - analysis and connectivity support, 19
 - analysis and connectivity tools, 760
 - installation, 775
 - Source
 - cursor, 595
 - masks, 228
 - Sources
 - math waveforms, 704
 - Sources for automatic measurements, 684
 - Span, 719
 - Specifications, 15
 - Spectral analysis
 - spectrum analyzer controls, 66
 - time domain gating, 260
 - Spectral analyzer windows
 - Blackman-Harris, 727
 - Gaussian, 727
 - Hamming, 727
 - Hanning, 727
 - Kaiser-Bessel, 727
 - Rectangular, 727
 - Tek Exponential, 727
 - using, 727
 - Spectral averaging, 715
 - Spectral math controls
 - frequency, 715
 - gate, 715
 - magnitude, 715
 - phase, 715
 - time, 715
 - Spectral math waveforms
 - example, 616
 - frequency domain, 715
 - gating, 715
 - overview, 715
 - set up, 613
 - time domain, 715
 - Spectral setups
 - control window
 - advanced
 - advanced, 252
 - basic
 - basic, 251
 - frequency, 253
 - gating, 255
 - Spectral waveforms
 - creating, 612, 826
 - features, 66, 257
 - overview, 257
 - SPI bus
 - setting up, 584
 - SPI serial bus
 - trigger, 321, 340, 342, 346, 349
 - SPI Serial Bus
 - search for data, 322, 341, 344, 347, 350, 354
 - search for SS Active, 322, 341, 344, 347, 350, 354
 - Split cursors, 87, 92
 - Standard deviation, 67
 - Starting an acquisition, 78
 - State trigger
 - control window, 431
 - State trigger pattern editor
 - bus tab, 777
 - digital tab, 778
 - Status
 - trigger, 622
 - Status message
 - calibration recommended, 515
 - Stopping an acquisition, 78
 - Support
 - information, 16
 - tools, 760
 - Switching between modes, 58
- ## T
- Taking automatic measurements, 597
 - Technical support, 16
 - Tek exponential window
 - defined, 734
 - Tekprobe interface, 831
 - TekProbe interface, 45
 - TekSecure erase, 549
 - Template

- recall, 814
- saving, 243
- Termination
 - and coupling, 810
 - termination control window, 810
- Test notification, 229, 230
- Test results, 235
- Test summary, 236
- Text properties control window, 171
- Thermal printer, 526
- Thresholds setup
 - Pattern Editor bus tab, 848
 - Pattern Editor live tab, 849
- Time and date, 550
- Time base system, 651
- Time bases, 62
- Time controls
 - duration, 716
 - resolution, 716
- Time domain
 - setup, 613
- Time domain controls, 716
- Time domain gating, 260
- Time duration, 658
- Time measurements, 277
- Time stamps, 799
- Time Synchronized mode, 56, 58
- Timeout trigger
 - timeout trigger control window, 432
- Tolerance, 228
- Toolbar mode, 29
- Touch screen
 - button, 73
 - calibrate, 554
- Tracking cursor mode, 93
- Transition time trigger
 - definition, 674
 - setup, 633
- Trigger
 - bus pattern condition, 843
 - bus pattern condition (MSO/DPO5000B and MSO70000C/DX Series), 843
 - bus pattern editor, 844
 - bus pattern editor (DPO/MSO5000B Series), 845
 - bus selection, 843
 - bus time condition, 843
 - codes, 744, 745
 - considerations, 657
 - indicator, 478
 - live tab of the pattern editor, 849
 - logic clock input, 778
 - logic pattern editor, 777, 778
 - logic state condition, 843
 - logic tab of the pattern editor, 848
 - modes, 667, 742
 - parallel bus pattern, 843
 - pattern editor, 777, 778
 - point, 662
 - position correction, 478
 - setup window, 624
 - slope and level, 668
 - sources, 665
 - standards, 744
 - state pattern editor, 777, 778
 - status, 622
 - system, 651
 - threshold, 825
 - transition time, 674
- Trigger controls
 - advanced button, 76
 - edge button, 76
 - level knob, 76
 - mode, 76
 - slope, 76
 - source, 76
- Trigger menu options
 - A event setup, 380
 - A-B sequence, 443, 821
 - B event setup, 461
 - comm setup, 414
 - edge setup, 416
 - Freq/Per setup, 417
 - glitch setup, 419
 - holdoff, 476
 - I2C serial bus setup, 390
 - logic pattern, 423
 - logic state, 431
 - mode, 382

- parallel bus setup, 385
 - quick select, 380
 - run/stop, 194
 - runt setup, 423
 - setup/hold setup, 426
 - timeout setup, 432
 - transition setup, 435
 - width setup, 439
 - Triggering
 - a glitch, 627
 - a pattern, 630, 631
 - a pulse width, 628
 - a runt pulse, 627
 - a sequence, 625
 - a video signal, 637
 - advanced, 669
 - communication mask, 637
 - from front panel, 623
 - from trigger setup window, 624
 - logic state, 632
 - mark all events, 638
 - modes, 667
 - pulse timeout, 629
 - setup/hold violations, 634
 - sources, 665
 - transition time, 633
 - triggering on, 625, 627–630, 632–634, 636, 637
 - window threshold violations, 636
 - triggering concepts, 664
 - Triggers
 - communication, 670
 - coupling, 76, 78, 832
 - external, 69
 - holdoff, 384, 476
 - holdoff control window, 384
 - level, 382, 561
 - level marker, 754
 - markers, 754
 - menu options, 379
 - mode, 382, 476
 - mode control window, 382
 - out signal, 552
 - posttrigger data, 379
 - pretrigger data, 379
 - sequential, 443, 626, 821
 - setup control window, 379
 - shared/independent, 836
 - types, 379, 380
 - Troubleshooting
 - autoset, 660
 - support information, 16
 - Windows interface, 22
 - Turn off power, 649
 - Turning fast acquisition on and off, 580
 - Type of mask, 220, 605
- ## U
- UltraSync bus cable, 49
 - USB bus
 - setting up, 584
 - USB serial bus
 - trigger, 327
 - USB Serial Bus
 - search for data packet, 328
 - search for end of packet, 328
 - search for error, 328
 - search for handshake packet, 328
 - search for reset, 328
 - search for resume, 328
 - search for special packet, 328
 - search for suspend, 328
 - search for sync, 328
 - search for token (address) packet, 328
 - Trigger on Data Packet, 395
 - Trigger on Error, 395
 - Trigger on Handshake Packet, 395
 - Trigger on Special Packet, 395
 - Trigger on Token (Address) Packet, 395
 - User color palette, 644
 - user interface, 27, 32
 - User interface, 31
 - User mask
 - creating, 607, 610
 - User mask edit, 240
 - User mask setup, 238
 - User preferences control window
 - prompts, 561

- readouts, 562
- trigger level presets, 561
- Using Fast Acquisitions, 580
- Using mask testing, 610
- Using math waveforms, 600
- Using MyScope control windows, 374
- Using zoom, 684
- Using zoom with waveforms, 643
- Utilities menu, 840
- Utilities menu options
 - autoset preferences, 191
 - deassign multipurpose knobs, 560
 - external signals, 552
 - GPIB configuration, 551
 - instrument calibration, 554
 - instrument diagnostics, 556
 - option installation, 565, 568, 570, 572
 - set time & date, 550
 - TekSecure erase, 549
 - user preferences, 561

V

- V Bar cursors, 87
- Variable List, 268
- Variables control window, 249
- vectors, 752
- Vertical acquisition, 656
- Vertical acquisition window, 655
- vertical controls
 - Multiview Zoom button, 80
 - offset, 489
 - position, 74, 857
 - scale, 74, 857
 - V Bar cursors, 92
 - vertical bar cursors, 92
 - vertical offset control window, 489
- Vertical controls
 - vertical setup control window
 - aux tab
 - aux tab, 498
- Vertical menu options
 - attenuation, 509
 - bandwidth, 495

- coupling, 492
- deskew, 507
- display on/off, 855
- label, 488
- offset, 489
- position/scale, 857
- probe cal, 499, 504, 513
- termination, 810
- vertical setup, 481
- zoom controls, 485
- zoom graticule, 202
- zoom setup, 202
- Vertical offset, 656
- vertical scale
 - setting, 654
- Vertices, 736
- Video signal triggering, 637
- video trigger, 674
- Visual qualification
 - define area, 469
 - edit logic, 471
- Visual trigger
 - area creation, 464
 - controls, 467
 - equation editor, 473, 474
 - qualification, 472
 - recall setups, 475
 - setup, 475
- Volts per division
 - maximum, 655
- Vvisual trigger
 - expression editor, 473
- VXI LAN server, 552

W

- Warnings, 698
- Waveform differentiation, 703
- Waveform display control window, 486
- Waveform integration, 706
- Waveform Label control window, 488
- Waveform options dialog box, 802
- Waveform record, 662
- Waveforms
 - averaging, 248

- clipping, 856
- colors, 179, 753, 754
- display, 169, 486, 855
- displaying, 642
- handle, 44
- histogram, 294
- intensity, 176
- interpolation, 169, 177
- label, 44, 488, 855
- math, 66, 247, 262, 603, 604, 753, 760, 813
- position, 487, 840, 857
- recalling and restoring, 531, 618
- reference, 486–488, 529, 530, 545, 617, 618, 754
- saving, 530, 545
- scale, 487, 841, 857
- spectral magnitude, 66, 257, 612, 828, 830
- spectral phase, 66, 257, 828
- WfmDB mode, 768
- Width trigger
 - defined, 674
- Width trigger control window, 439
- Window bin width, 719
- Window threshold violations triggering, 636
- window trigger, 674
- Windows

- dockable, 647
- Windows interface, 22
- Working with your oscilloscope, 863

X

- X style cursor, 89
- XY cursors, 88
- XY format, 175, 176
- XYZ format, 175

Y

- YT format, 175

Z

- Zero phase reference, 727
- Zoom
 - button, 80
 - control window, 485
 - graticule, 63
 - setup window, 202
 - using, 643

