

**TekExpress  
DisplayPort Automated Solution  
Printable Application Help**





**TekExpress**  
**DisplayPort Automated Solution**  
**Printable Application Help**

Copyright © Tektronix. All rights reserved. Licensed software products are owned by Tektronix or its subsidiaries or suppliers, and are protected by national copyright laws and international treaty provisions. Tektronix products are covered by U.S. and foreign patents, issued and pending. Information in this publication supersedes that in all previously published material. Specifications and price change privileges reserved.

TEKTRONIX and TEK are registered trademarks of Tektronix, Inc.

### **Contacting Tektronix**

Tektronix, Inc.  
14150 SW Karl Braun Drive  
P.O. Box 500  
Beaverton, OR 97077  
USA

For product information, sales, service, and technical support:

- In North America, call 1-800-833-9200.
- Worldwide, visit [www.tektronix.com](http://www.tektronix.com) to find contacts in your area.

---

# Table of Contents

|               |     |
|---------------|-----|
| Welcome ..... | vii |
|---------------|-----|

## Getting help and support

|                                |   |
|--------------------------------|---|
| Related documentation .....    | 1 |
| Conventions used in help ..... | 2 |
| Technical support .....        | 2 |

## Getting started

|  |    |
|--|----|
| Installing the software .....              | 3  |
| Compatibility .....                        | 3  |
| Minimum system requirements .....          | 3  |
| Supported probes .....                     | 5  |
| Install the software .....                 | 5  |
| Activate the license .....                 | 5  |
| View version and license information ..... | 6  |
| Introduction to the application .....      | 8  |
| DisplayPort Tx application overview .....  | 8  |
| Application directories and usage .....    | 10 |
| File name extensions .....                 | 11 |

## Operating basics

|                                      |    |
|--------------------------------------|----|
| Start the application .....          | 13 |
| Application panels overview .....    | 13 |
| Exit the application .....           | 14 |
| Application controls and menus ..... | 14 |
| Application controls .....           | 14 |
| Options menu .....                   | 15 |
| Email settings .....                 | 16 |
| Instrument control settings .....    | 17 |
| Panels .....                         | 18 |
| About panels .....                   | 18 |
| Setup panel .....                    | 19 |
| Status panel .....                   | 23 |
| Results panel .....                  | 24 |
| Reports panel .....                  | 25 |

## Saving and recalling test setups

|   |    |
|---|----|
| About test setups .....                             | 27 |
| Save a test setup .....                             | 27 |
| Recall a saved test setup .....                     | 28 |
| Create a test setup from default settings .....     | 28 |
| Recall a saved test setup .....                     | 29 |
| Create a new test setup using an existing one ..... | 30 |
| Delete a test setup .....                           | 30 |

## Setting up and configuring tests

|                                      |    |
|--------------------------------------|----|
| About setting up tests .....         | 31 |
| Equipment connection setup .....     | 34 |
| View connected instruments .....     | 45 |
| Test setup overview .....            | 46 |
| Select DUT parameters .....          | 47 |
| Select a test .....                  | 51 |
| Selecting acquisitions .....         | 52 |
| Configuring tests .....              | 59 |
| Set preferences tab parameters ..... | 63 |
| Reports panel .....                  | 64 |

## Running tests and viewing results

|                                       |    |
|---------------------------------------|----|
| About running tests .....             | 69 |
| Before you click start .....          | 69 |
| Pre-Run checklist .....               | 72 |
| Run a test in pre-recorded mode ..... | 72 |
| View the progress of analysis .....   | 73 |
| View test results .....               | 75 |
| View a report .....                   | 76 |
| View test-related files .....         | 78 |

## Algorithms

|   |    |
|---|----|
| About algorithms .....  | 81 |
| 3.1 Eye diagram testing (Normative) .....                         | 82 |
| 3.2 Non Pre-Emphasis level verification testing (Normative) ..... | 84 |

|   |     |
|---|-----|
| 3.3 Pre-Emphasis level verification testing and Maximum peak-to-peak differential voltage testing (Normative) | 86  |
| 3.4 Inter-Pair skew testing (Normative)   | 90  |
| 3.5 Intra-Pair skew test (Informative)  | 92  |
| 3.10 AC common mode noise (Informative)   | 93  |
| 3.11 Non-ISI jitter measurements (Normative)  | 94  |
| 3.12.1 Total jitter (TJ) and RJ (RJ/TJ) measurement (Normative)   | 95  |
| 3.12.2 HBR2 D10.2 Total Jitter/Random jitter/Deterministic jitter (TJ/RJ/DJ) measurement (Normative)          | 96  |
| 3.14 Main link frequency compliance (Normative)   | 98  |
| 3.15 Spread spectrum modulation frequency (Normative)   | 99  |
| 3.16 Spread spectrum modulation (Normative)   | 100 |
| 3.17 dF-dt spread spectrum deviation HF variation (Informative)   | 101 |
| 3.18 Dual mode TMDS clock (Normative if supported)  | 102 |
| 3.19 Dual mode eye diagram testing (Normative if supported)   | 102 |
| 8.1 AUX channel eye diagram testing   | 103 |
| 8.2 AUX channel eye sensitivity test  | 103 |
| 8.5 Inrush test   | 104 |

## TekExpress programmatic interface

|   |     |
|---|-----|
| About the programmatic interface              | 107 |
| To enable remote access                       | 108 |
| Requirements for developing TekExpress client | 110 |
| Remote proxy object                           | 111 |
| Client proxy object                           | 112 |
| Client programmatic interface example         | 113 |
| Program remote access code example            | 116 |
| DisplayPort programmer interface commands     | 117 |
| ApplicationStatus()                           | 117 |
| Connect()                                     | 118 |
| Disconnect()                                  | 119 |
| GetCurrentStateInfo()                         | 120 |
| GetDutId()                                    | 121 |
| GetPassFailStatus()                           | 122 |
| GetReportParameter()                          | 122 |
| GetResultsValue()                             | 124 |
| LockServer()                                  | 127 |
| RecallSession()                               | 128 |
| Run()   | 129 |

|                                     |     |
|-------------------------------------|-----|
| SaveSession()                       | 129 |
| SaveSessionAs()                     | 130 |
| SendResponse()                      | 130 |
| SelectDevice()                      | 132 |
| SelectSuite()                       | 132 |
| SelectTest()                        | 133 |
| SetDutId()                          | 134 |
| SetGeneralParameter()               | 134 |
| SetTimeOut()                        | 136 |
| SetVerboseMode()                    | 137 |
| Status()                            | 138 |
| Stop()                              | 138 |
| UnlockServer()                      | 139 |
| Handle error codes                  | 139 |
| SetComplianceMode()                 | 140 |
| SetAquireParameter()                | 141 |
| SetAnalyzeParameter()               | 143 |
| TransferImages()                    | 145 |
| GetResultsValueForSubMeasurements() | 145 |
| TransferResult()                    | 146 |

## SCPI commands

|  |     |
|--|-----|
| About SCPI command                     | 147 |
| Socket configuration for SCPI commands | 147 |
| TEKEXP:*IDN?                           | 155 |
| TEKEXP:*OPC?                           | 155 |
| TEKEXP:ACQUIRE_MODE                    | 156 |
| TEKEXP:ACQUIRE_MODE?                   | 156 |
| TEKEXP:EXPORT                          | 157 |
| TEKEXP:INFO?                           | 157 |
| TEKEXP:INSTRUMENT                      | 158 |
| TEKEXP:INSTRUMENT?                     | 158 |
| TEKEXP:LASTERROR?                      | 159 |
| TEKEXP:LIST?                           | 159 |
| TEKEXP:MODE                            | 160 |
| TEKEXP:MODE?                           | 161 |
| TEKEXP:POPUP                           | 161 |
| TEKEXP:POPUP?                          | 162 |
| TEKEXP:REPORT                          | 162 |



---

|                               |     |
|-------------------------------|-----|
| TEKEXP:REPORT? .....          | 163 |
| TEKEXP:RESULT? .....          | 163 |
| TEKEXP:SELECT .....           | 164 |
| TEKEXP:SELECT? .....          | 165 |
| TEKEXP:SETUP .....            | 165 |
| TEKEXP:STATE .....            | 166 |
| TEKEXP:STATE? .....           | 166 |
| TEKEXP:VALUE .....            | 167 |
| TEKEXP:VALUE? .....           | 168 |
| Command parameters list ..... | 169 |
| Examples .....                | 179 |

## Reference

|                       |     |
|-----------------------|-----|
| Deskew channels ..... | 181 |
| Appendix-A .....      | 182 |
| Appendix-B .....      | 184 |



# Welcome

The Tektronix TekExpress DisplayPort software supports CTS 1.4. The Software uses Tektronix DisplayPort AUX controller (DP-AUX) and Unigraf DPR-100 to automate DisplayPort physical layer source compliance tests for Standard and Type-C connectors. The DP-AUX/ DPR-100 puts the DUT in different test modes and eliminates the need for user intervention during testing.

Tektronix provides various tools such as DPOJET (Jitter and Eye Analysis tool), SDLA (Serial Data Link Layer Analysis), and DisplayPort Essential (DisplayPort measurement library) to perform the characterization/debug of the silicon, and TekExpress DisplayPort application to perform the compliance tests.

The TEK-GRL-DP-SINKSW automates the DP Rx testing.

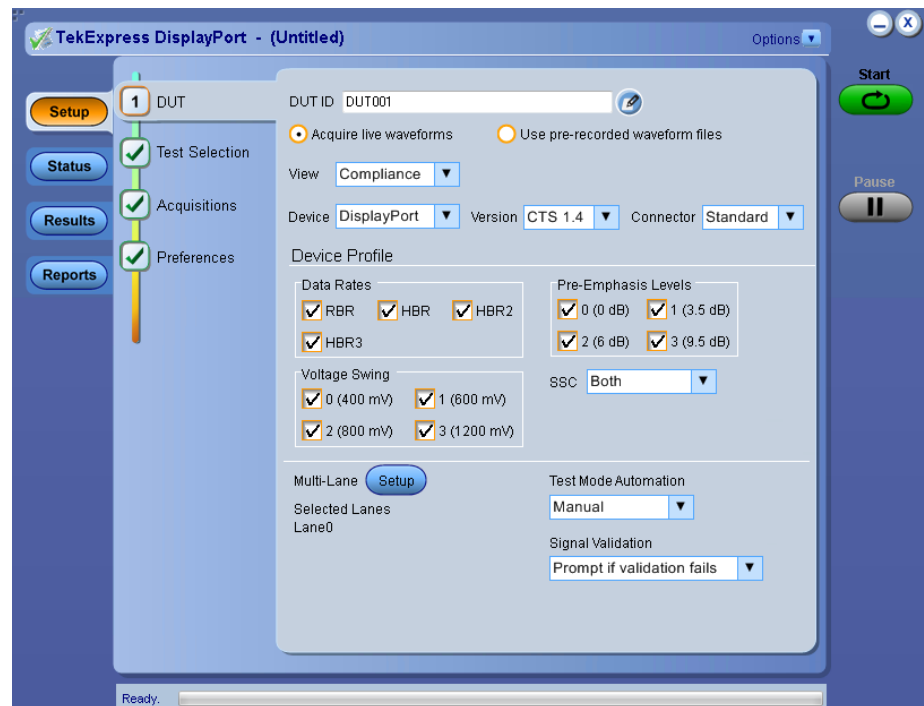



# Getting help and support

## Related documentation

The following manuals are available as part of the TekExpress DisplayPort Tx Automated Solution documentation set.

**Table 1: Product documentation**

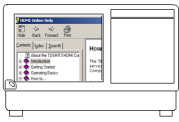
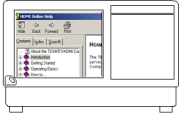
| Item                   | Purpose                        | Location   |
|------------------------|--------------------------------|--|
| Online Help            | In-depth operation and UI help |    |
| PDF of the Online Help | In-depth operation and UI help |  <p>PDF file that ships with the software distribution (TekExpress Displayport-Automated-Test-Solution-Software-Printable-Help-EN-US.pdf). It is also available in <a href="http://www.tek.com">http://www.tek.com</a></p> |

See Also [Technical support](#)

## Conventions used in help

Online Help uses the following conventions:

- The term “DUT” is an abbreviation for Device Under Test.
- The term “select” is a generic term that applies to the two mechanical methods of choosing an option: using a mouse or using the touch screen.

## Technical support

Tektronix values your feedback on our products. To help us serve you better, please send us your suggestions, ideas, or comments on your application or oscilloscope. Contact Tektronix through mail, telephone, or the Web site. See [Contacting Tektronix](#) for more information.

When you contact Tektronix Technical Support, please include the following information (be as specific as possible):

### General Information

- All instrument model numbers
- Hardware options, if any
- Probes used
- Your name, company, mailing address, phone number, FAX number
- Please indicate if you would like to be contacted by Tektronix about your suggestion or comments.

### Application Specific Information

- Software version number
- Description of the problem such that technical support can duplicate the problem
- If possible, save the setup files for all the instruments used and the application
- If possible, save the TekExpress setup files, log.xml, \*.TekX (session files and folders), and status messages text file
- If possible, save the waveform on which you are performing the measurement as a .wfm file

# Getting started

## Installing the software

- Compatibility** The TekExpress DisplayPort Tx application runs on the following Tektronix oscilloscopes:
- DPO/DSA/MSO71254C, DPO/DSA/MSO71604C and DPO/DSA/MSO72004C Series Digital Oscilloscopes
  - DPO/DSA72504D and DPO/DSA73304D Series Digital Oscilloscopes
  - DPO/MSO72304DX/72504DX/73304DX Series Digital Oscilloscopes
  - DPO72304SX, DPO72302SX, DPO73302SX, DPO73304SX, DPO75002SX, DPO75902SX, and DPO77002SX.

**See Also.** [Minimum system requirements](#)

- Minimum system requirements** The following table shows the minimum system requirements for an oscilloscope to run TekExpress.

**Table 2: System requirements**

| Component        | Requirement   |
|------------------|---|
| Oscilloscope     | <ul style="list-style-type: none"><li>■ MSO70000C/DX, DPO70000C/D/DX/SX, and DSA70000C/D series oscilloscopes with at least 8 GHz for Compliance Mode for RBR and HBR, 12.5 GHz for Compliance Mode for HBR2 and 16 GHz for Compliance Mode for HBR3.</li></ul> <p>For list of compatible oscilloscopes, see <a href="#">Compatibility</a>.</p> |
| Processor        | Same as the oscilloscope  |
| Operating System | Same as the oscilloscope (Windows 7 64-bit)   |
| Memory           | Same as the oscilloscope  |
| Hard Disk        | Same as the oscilloscope  |
| Display          | Same as the oscilloscope  |

| Component     | Requirement   |
|---------------|---|
| Software      | <ul style="list-style-type: none"> <li>■ DPOJET, Jitter and Eye Diagram Analysis Tool, v10.0.0.35 or later</li> <li>■ Microsoft Internet Explorer 6.0 SP1 or later</li> <li>■ Microsoft Photo Editor 3.0 or equivalent software for viewing image files</li> <li>■ Adobe Reader 7.0 or equivalent software for viewing portable document format (PDF) files</li> <li>■ SDLA software for creating CTLE and DFE filters</li> </ul> |
| Probes        | TCA-SMA single ended, P7313SMA, P7520A , P7520A, P7516, P7513A, P7720, P7716, P7713, P6245,P6246, P6247, P6248, P6250, P6251 and TCP202.  |
| Test fixtures | <ul style="list-style-type: none"> <li>■ Wilder Display Port fixtures (DP-TPA-P, DP-TPA-R, DP-TPA-C, DPI-TPA-PA, DPI-TPA-PRRCA, MDPI-TPA-PA and MDPI-TPA-PRRCA).</li> <li>■ Vprime Display Port Inrush current test fixture.</li> <li>■ Display Port Interposer Standard Plug to Standard Receptacle.</li> </ul>  |
| Type-C        | DPC-TPA-R, DPC-TPA-C, DPC-TPA-CB, DPC-TPA-PCB, DPC-TPA-RR, DPC-TPA-PR, DPC-TPA-RRCB, DPC-TPA-PRCB, and DPC-TPA-PRRCB  |
| Other Devices | <ul style="list-style-type: none"> <li>■ Microsoft compatible mouse or compatible pointing device</li> <li>■ Four USB ports (two USB ports minimum)</li> <li>■ Unigraf DPR-100 or Tektronix DP-AUX</li> <li>■ GRL Alt Mode controller (GRL-USB-PD-C1) - Optional device</li> </ul>  |

**See Also.** [Compatibility](#)



**Supported probes** The table gives the list of probes recommended for the Display port Tx application.

| Recommended Probe model  |
|--|
| P7313SMA, P7520A , P7520A, P7516, P7513A, P7720, P7716, P7713 differential probe based input, which offers the most efficient test configuration, by offering inputs for all 4 differential DisplayPort signals concurrently. This configuration precludes the testing of common mode and skew measurements. |
| TCA-based single-ended input (direct Tektronix oscilloscope inputs) supports both differential and single-ended tests including intra-pair skew measurements on up to 2 concurrent DisplayPort signals.  |
| For testing Aux measurement are P6245,P6246, P6247, P6248, P6250, P6251.   |

**Install the software** Install the software on a compatible Tektronix Real-Time oscilloscope running Windows 7. For a list of compatible oscilloscopes, see [Compatibility](#).

1. Go to the [www.tek.com](http://www.tek.com) Web site and search for DisplayPortTx to locate the installation file. Download the DisplayPort Tx web installer from <http://www.tek.com>.
2. Close all applications, including any TekVISA applications.
3. Double-click the executable file to extract the installation files.

After extraction, the installer launches and the software automatically installs in the following location:

Windows 7 location: C:\Program Files\Tektronix\TekExpress\TekExpress DisplayPortTx

**See Also.** [Minimum system requirements](#)

**Activate the license** Activate the license using the option installation wizard on the oscilloscope. Follow these steps to activate the TekExpress DisplayPort Tx license:

1. From the oscilloscope menu bar, click **Utilities > Option Installation**.

The TekScope Option Installation wizard opens.

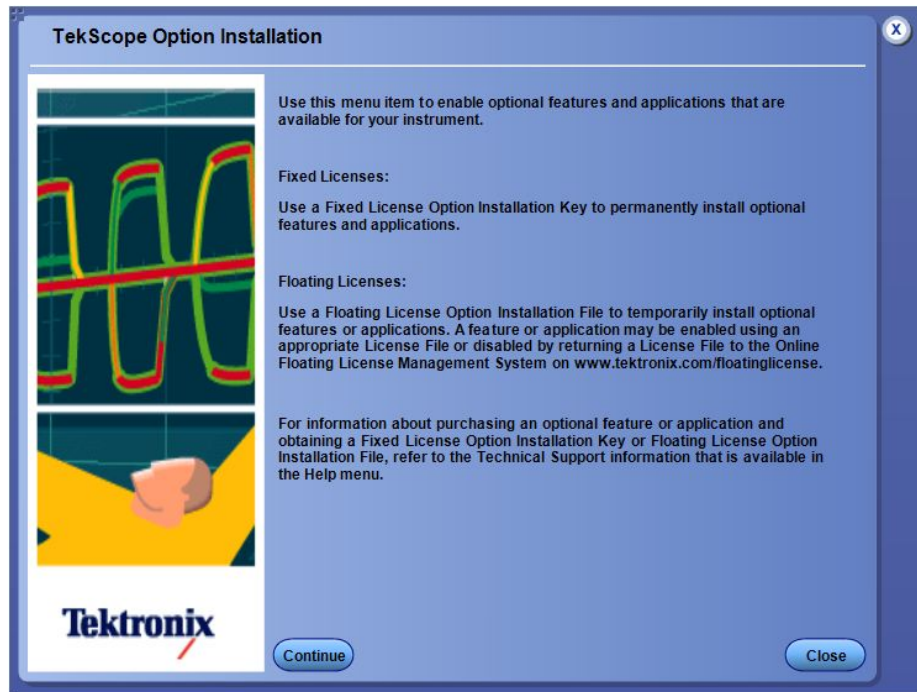

2. Instructions for using the Options Installation window to activate licenses for installed applications is provided in the oscilloscope online help. Press the **F1** key on the oscilloscope keyboard to open the Option Installation help topic. Follow the directions in the topic to activate the license.

**See Also.** [View version and license information](#)

### View version and license information

Use the following instructions to view application version information and version information for the application modules such as the Programmatic Interface and the Programmatic Interface Client.

To view version information for application, click the **Options** button in TekExpress application and select **About TekExpress**. View **Version Details** in the About Tektronix TekExpress DisplayPort pop-up.



---

**NOTE.** This example shows a typical *Version Details* dialog box, and may not reflect the actual values as shown when you open this item in the application.

---

Click **View End-User License Agreement** link in About Tektronix TekExpress DisplayPort pop-up, to view the end-user license agreement.

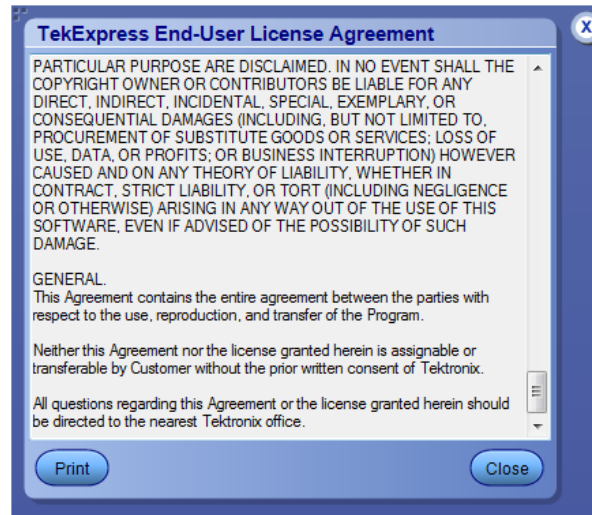

**See Also.** [Activate the license](#)

[Options menu](#)

## Introduction to the application

### **DisplayPort Tx application overview**

TekExpress is the Tektronix Test Automation Framework, developed to support your current and future test automation needs. TekExpress uses a highly modular architecture that lets you deploy automated test solutions for various standards in a relatively short time.

**Key Features:** DisplayPort Tx has the following key features

- Fully-automated compliance testing of DP1.4 Source devices (Standard and Type-C connectors).
- Support for Dual Mode (DP++) and AUX channel tests.
- Integration with Tektronix DP-AUX or Unigraf DPR-100.
- Automatic insertion of modelled channel losses, CTLE equalization and DFE as per the CTS.
- User-Defined mode for characterization, margin testing and debugging (in addition to compliance testing).
- Support for P7313SMA differential probes.
- DP-AUX or Unigraf DPR-100 provides DUT control for full automation, saving hours of manual DUT settings.
- Greater bandwidth allows for increased resolutions, higher refresh rates, and greater color depth.
- Automated testing:
  - Minimizes user intervention when conducting time-consuming testing.
  - Reduces the time required to conduct testing.
- Selective testing:
  - Performs fully-automated testing for transmitter measurements.
  - Allows selecting test individually or in groups.
  - Avoids repeated testing through accurate and reliable results from a single run.
- Quick testing:
  - One-button selection of multiple tests ensures faster testing.
  - Test margins and statistical information promote quick analysis.
  - One-button MHT report format saves time.
- Complete Solution: Complete compliance solution with an elaborate test fixture and signal sources support for SMA cable-based solution provides a cost-effective way to perform compliance testing.
- Customize the setup:
  - Modify the test setup according to the DUT configuration.
  - Run tests using different record lengths.
  - Run test measurements using more than one signal.
- Detailed test reporting:
  - Provides a Pass/Fail summary table.
  - Provides margin details on each test.

- Provides a consolidated report for all tests.
- Provides additional information such as skew, alignment, and signal type selected for each measurement.

**Application directories and usage**

The application directory and associated files are organized as follows:

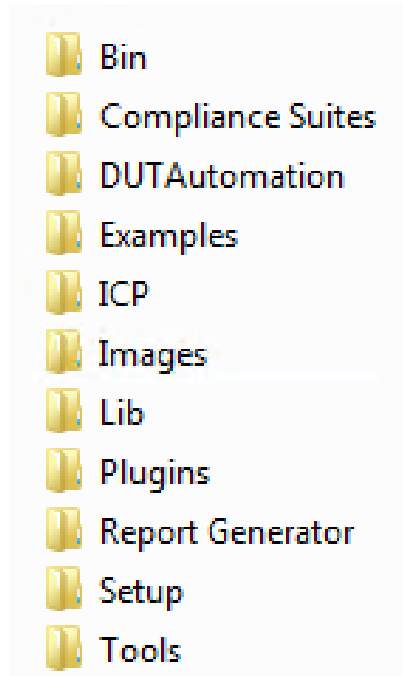

The following table lists the default directory names and their usage.

**Table 3: Application directories and usage**

| Directory names                                | Usage   |
|--|---|
| InstallDir\TekExpress\TekExpress DisplayPortTx | Contains the application and associated files                                   |
| TekExpress DisplayPortTx\Bin                   | Contains the miscellaneous DisplayPort Tx application libraries                 |
| TekExpress DisplayPortTx\Compliance Suites     | Contains compliance-specific files  |
| TekExpress DisplayPortTx\DUTAutomation         | Contains DUT automation controller libraries                                    |
| TekExpress DisplayPortTx\Examples              | Contains various support files  |
| TekExpress DisplayPortTx\ICP                   | Contains instrument and DisplayPort Tx application-specific interface libraries |
| TekExpress DisplayPortTx\Images                | Contains Tektronix log images   |
| TekExpress DisplayPortTx\Lib                   | Contains utility files specific to the DisplayPort Tx application               |
| TekExpress DisplayPortTx\Plugins               | Contains DUT Automation related plug-ins.                                       |

| Directory names                           | Usage   |
|---|---|
| TekExpress DisplayPortTx\Report Generator | Contains style sheets for report generation                       |
| TekExpress DisplayPortTx\Setup            | Contains setup files  |
| TekExpress DisplayPortTx\Tools            | Contains instrument and DisplayPort Tx application-specific files |

**See Also.** [View test-related files](#)

### File name extensions

The TekExpress DisplayPort Tx application uses the following file name extensions:

| File name extension | Description   |
|---------------------|---|
| .TekX               | Session files are saved in this format but the extensions may not be displayed.                                       |
| .seq                | The test sequence file.   |
| .xml                | The encrypted XML file that contains the test-specific configuration information. The log file extension is also xm.l |
| .wfm                | The test waveform file.   |
| .mht                | Test result reports are saved in this format by default. Test reports can also be saved in HTML format.               |
| .pdf                | Test result reports.<br>Application help document.  |
| .csv                | Report is generated in .csv format.   |

**See Also.** [View test-related files](#)

[Application directories and usage](#)

[Before you click start](#)





# Operating basics

## Start the application

To run the DisplayPort Tx application, do any of the following:

- From the TekScope Analyze menu, select **Analyze > TekExpress DisplayPort Tx**.
- Double-click on any DisplayPort saved session file.

While running the application, you can switch between the oscilloscope screen and DisplayPort Tx by clicking the desired window. To keep the application window on top, select **Keep On Top** from the *Options menu*.

---

**NOTE.** *If the application was not terminated properly during the last use, a dialog box asks to recall the previously unsaved session.*

---

## Application panels overview

TekExpress Display Port Solution uses panels to group related configuration, test, and results settings. Click any step button to open the associated panel. A panel may have one or more tabs that list the selections available in that panel. Controls in a panel can change depending on settings made in that panel or another panel.

**Table 4: Application panels**

| Panel name              | Purpose  |
|-------------------------|--|
| <a href="#">Setup</a>   | The Setup panel allows you to configure the test setup. Use this panel to: <ul style="list-style-type: none"><li>■ <a href="#">Select DUT parameters</a>.</li><li>■ <a href="#">Select the test(s)</a>.</li><li>■ <a href="#">Set acquisitions tab parameters</a> for selected tests.</li><li>■ <a href="#">Set configuration tab parameters</a>.</li><li>■ <a href="#">Select preferences tab parameters</a>.</li></ul> |
| <a href="#">Status</a>  | View the acquisition status and analysis status of the selected tests, and view test logs.   |
| <a href="#">Results</a> | View a summary of test results and select result viewing preferences.  |
| <a href="#">Reports</a> | You can find the reports, save reports as specific file types, specify report naming conventions, select report content to include (such as summary information, detailed information, user comments, setup configuration, application configuration), and select report viewing options.  |



## Exit the application

Use the following method to exit the application:

---

**NOTE.** *Using other methods to exit the application results in abnormal termination of the application.*



---



1.  Click  on the application title bar.
2. Do one of the following:
  - If you have an unsaved session or test setup open, you will be asked to save it before exiting. To save it, click **Yes**. Otherwise click **No**. The application closes.
  - A message box appears asking if you really want to exit TekExpress. To exit, click **Yes**.

## Application controls and menus

**Application controls** This section describes the application controls.

**Table 5: Application controls descriptions**

| Item  | Description  |
|---|--|
| <i>Options menu</i>   | Menu to display global application controls.   |
| <i>Panel</i>  | Controls that open panels for configuring test settings and options.   |
| Command buttons   | Button that initiates an immediate action such as the Start, Stop, Pause, and Clear command buttons  |
| Start button<br>Start<br>            | Use the Start button to start the test run of the measurements in the selected order. If prior acquired measurements are not cleared, then new measurements are added to the existing set. |
| Stop button<br>Stop<br>              | Use the Stop button to abort the test.   |
| Pause \ Continue button<br>Pause<br> | Use the Pause button to temporarily pause the current execution. When a test is paused, the button name changes to "Continue".   |

| Item  | Description   |
|---|---|
| Clear button<br>                 | Use the Clear button to clear all existing measurement results. This button is available only on the <a href="#">Results panel</a> .  |
| Application window move icon<br> | Place the cursor over the three-dot pattern in the upper left corner of the application window. When the cursor changes to a hand, drag the window to the desired location. |

**Options menu** The Options menu is located in the upper right corner of the application.

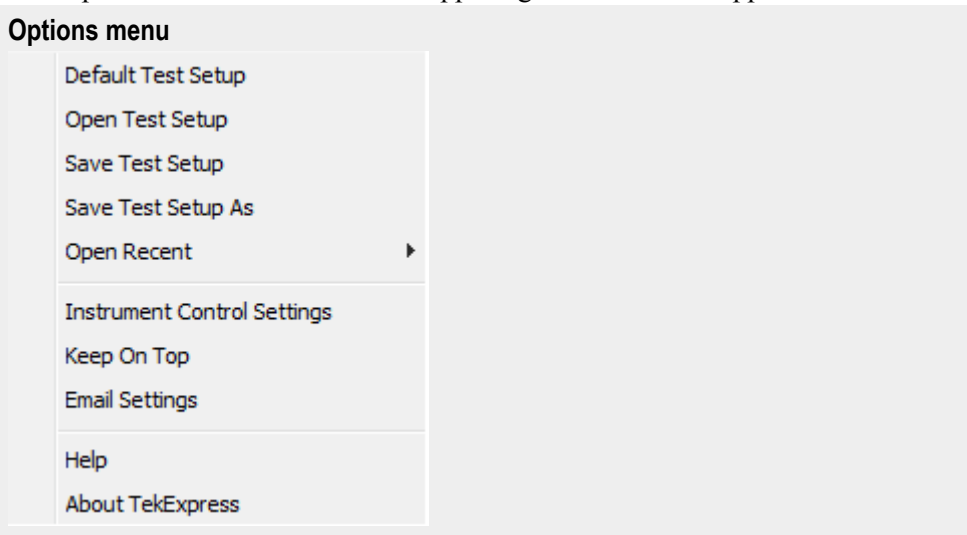

The Options menu has the following selections:

| Menu  | Function  |
|---|---|
| Default Test Setup                          | Opens an untitled test setup with defaults selected   |
| Open Test Setup                             | Opens a saved test setup  |
| Save Test Setup                             | Saves the current test setup selections   |
| Save Test Setup As                          | Creates a new test setup based on an existing one   |
| Open Recent                                 | Displays a menu of recently opened test setups to select from   |
| <a href="#">Instrument control settings</a> | Shows the list of instruments connected to the test setup and allows you to locate and refresh connections to connected instruments |
| Keep On Top                                 | Keeps the TekExpress DisplayPort Tx utility on top of other open windows on the desktop   |
| <a href="#">Email settings</a>              | Use to configure email options for test run and results notifications   |

| Menu             | Function   |
|------------------|--|
| Help             | Displays TekExpress Help   |
| About TekExpress | <ul style="list-style-type: none"> <li>■ Displays application details such as software name, version number, and copyright</li> <li>■ Provides access to <i>license information</i> for your DisplayPort Tx installation</li> <li>■ Provides a link to the Tektronix Web site</li> </ul> |

**See Also.** [Application controls](#)

### Email settings

Use the Email Settings utility to [configure email notifications](#) if you want DisplayPort application to notify you when a tests completes, produces an error, or fails. Select the type of test run information to be included in the notification, such as test reports and test logs, the email message format, and the email message size limit.

**NOTE.** *Recipient email address, sender’s address, and SMTP Server are mandatory fields.*

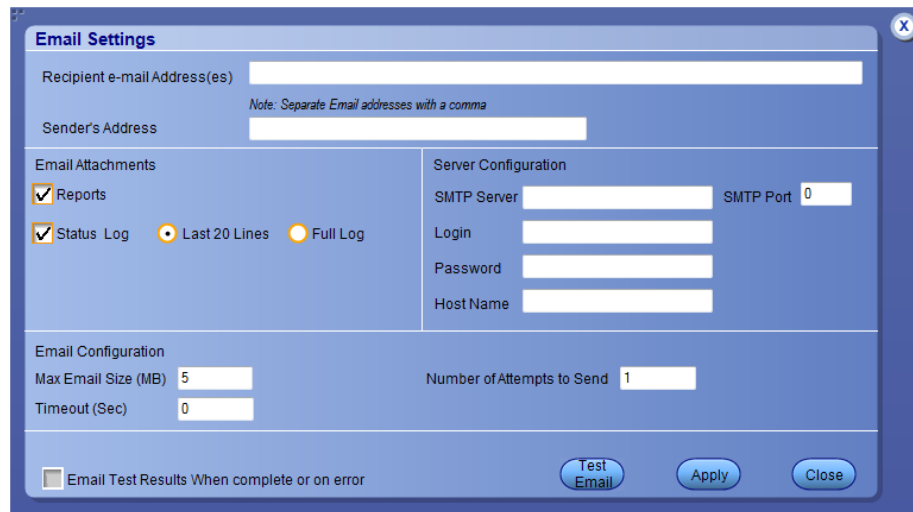

**See Also.** [Options menu](#)

[Select analysis and test notification preferences](#)

## Instrument control settings

The Instrument Control Settings dialog box shows the list of resources found on different connections. It serves two purposes:

- Discovers the connected instruments
- Confirms the instrument connection setup

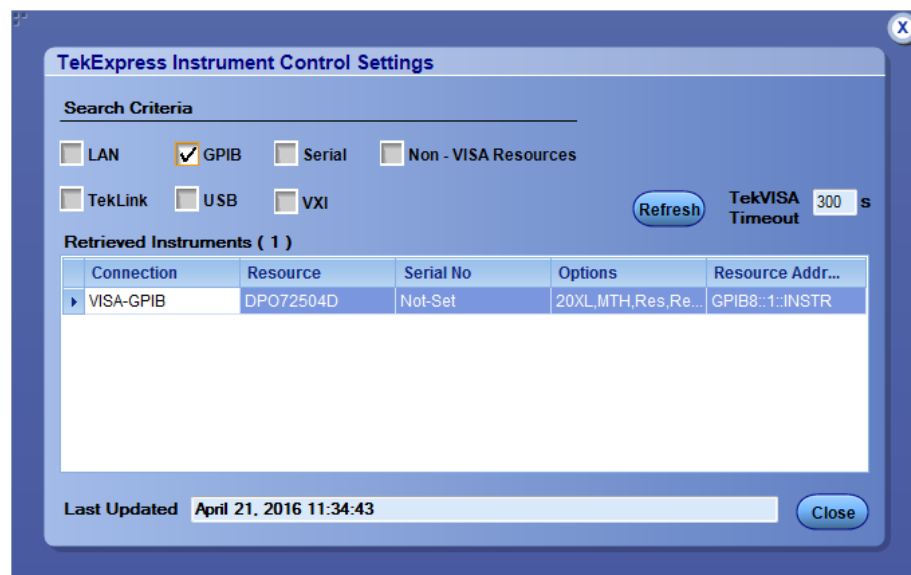

Use the Instrument Control Settings feature to *search for connected instruments* and view instrument connection details. Connected instruments displayed here can be selected for use in the Global Settings section of the Setup panel's Configuration section. See step 2 of *Configure tests* for details.

**See Also.** *Options menu*

## Panels

**About panels** TekExpress DisplayPort Tx has the following main panels:

**Table 6: Application panels**

| Panel name     | Purpose   |
|----------------|---|
| <i>Setup</i>   | The Setup panel allows you to configure the test setup. Use this panel to: <ul style="list-style-type: none"> <li>■ <i>Select device parameters.</i></li> <li>■ <i>Select the test(s).</i></li> <li>■ <i>Select acquisitions parameters</i> for selected tests.</li> <li>■ <i>Configure the selected tests.</i></li> <li>■ <i>Select analysis and test notification preferences.</i></li> </ul> |
| <i>Status</i>  | View the acquisition status and analysis status of the selected tests, and view test logs.  |
| <i>Results</i> | View a summary of test results and select result viewing preferences.   |
| <i>Reports</i> | Browse for reports, save reports, specify report naming conventions, select content to include (such as summary information, detailed information, user comments, plot images, setup configuration), and select other report viewing options.   |

**See Also.** *Application controls*

**Setup panel** The Setup panel has numbered tabs to guide you through the test setup process:

**1. DUT**

**DUT tab, Compliance View**

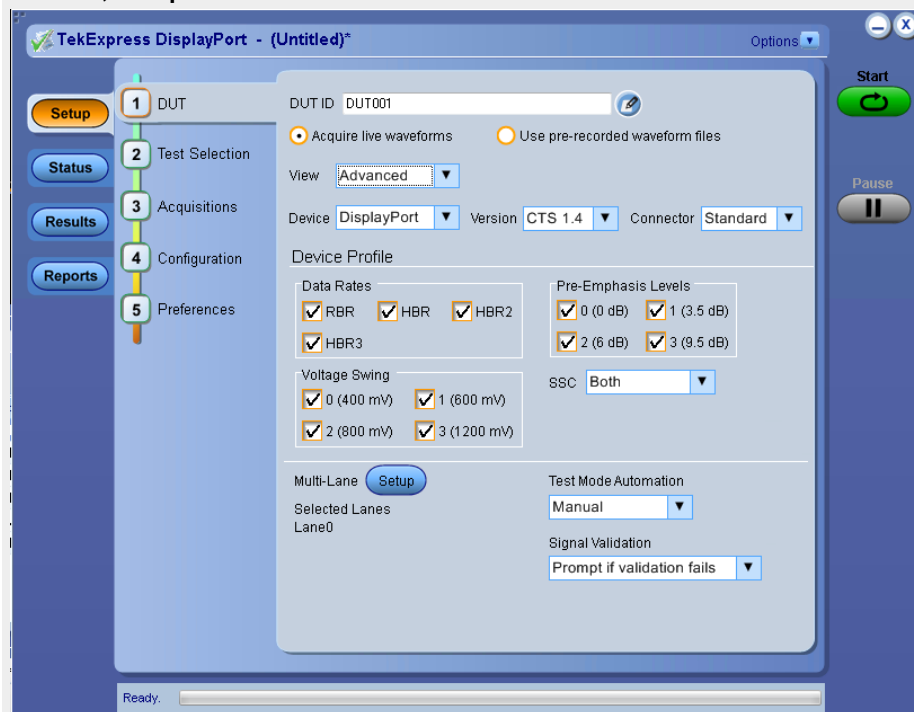

**Advanced View**

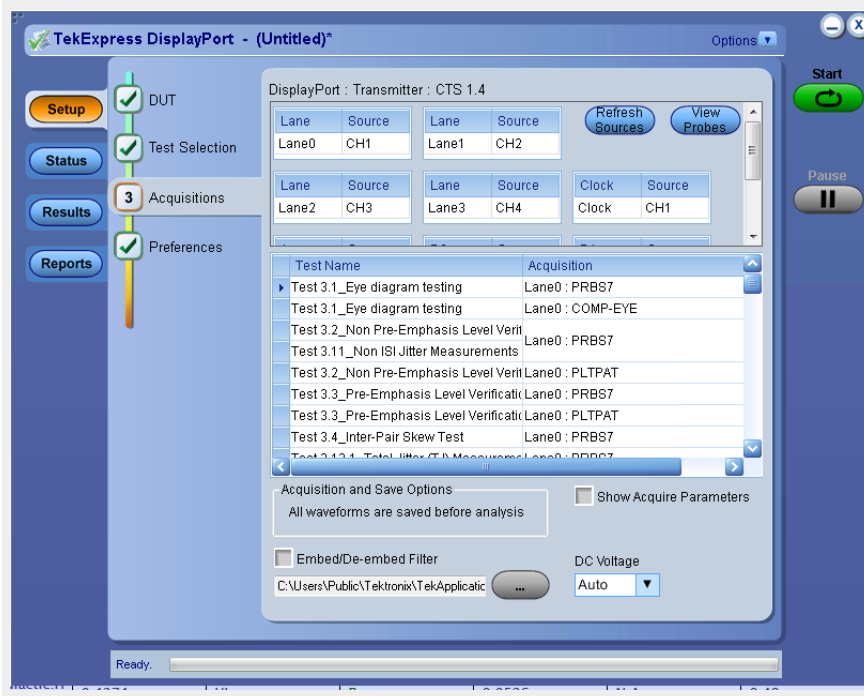

**2. Test Selection**

### Test Selection tab

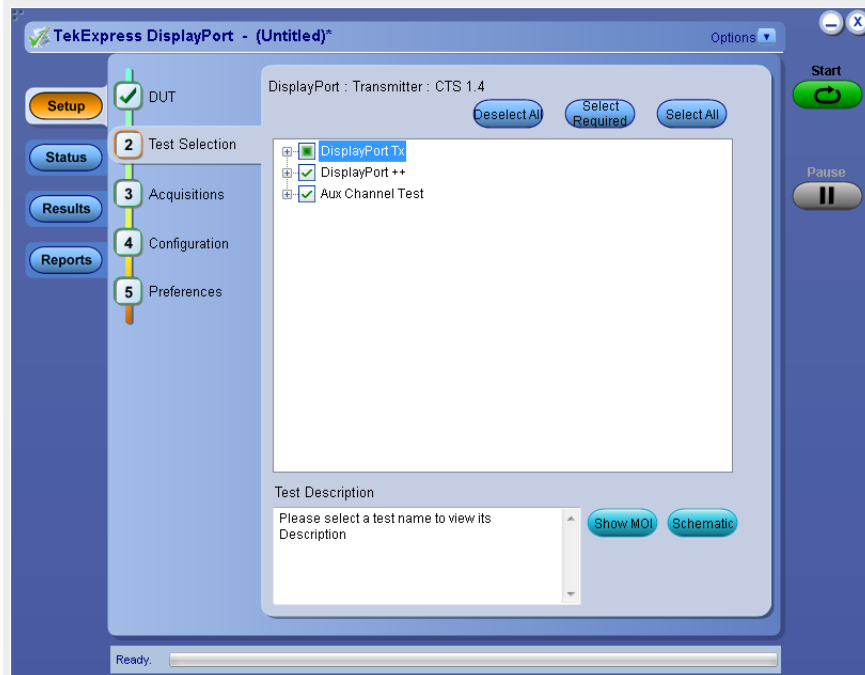
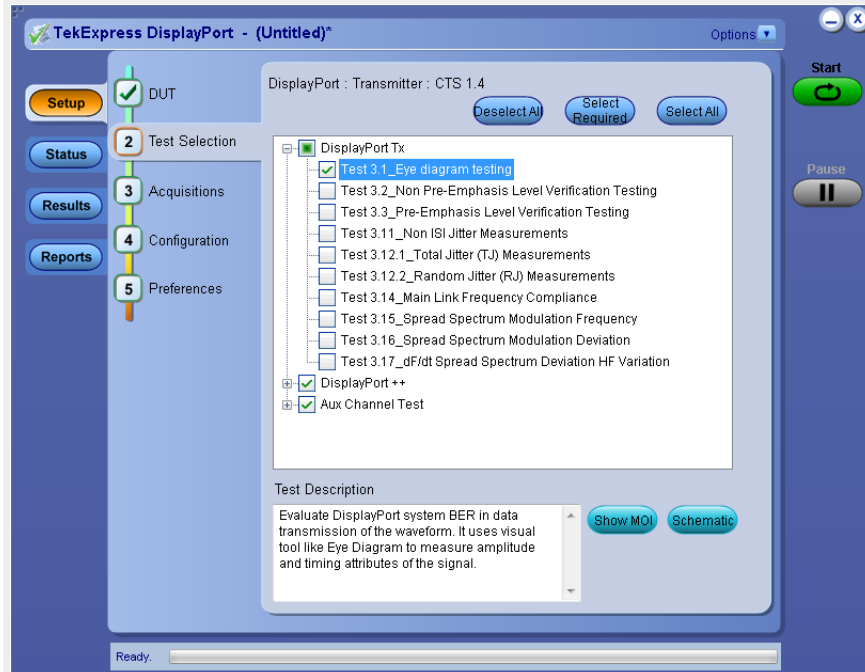

### 3. Acquisitions



### Acquisitions tab

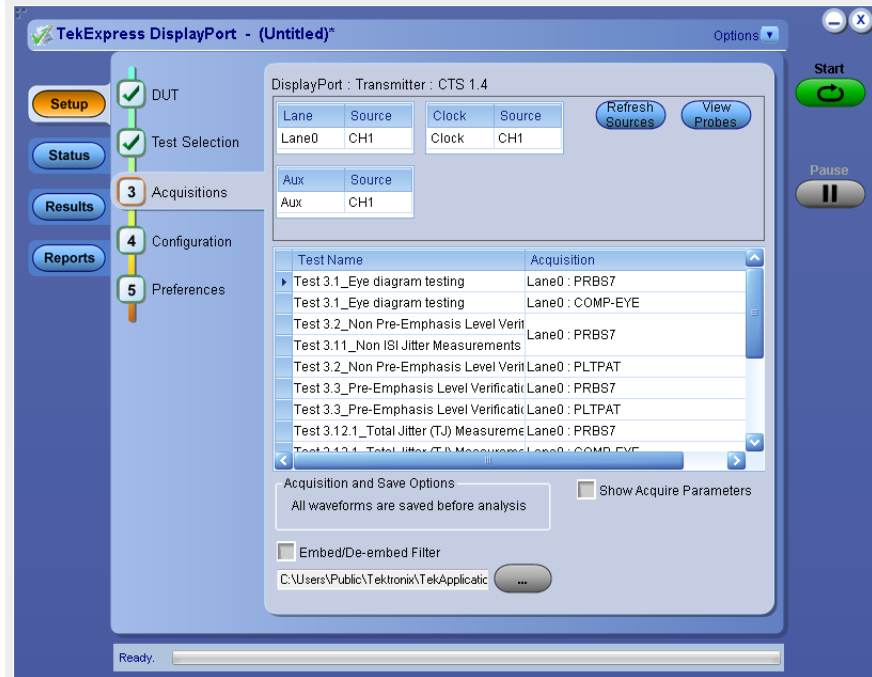
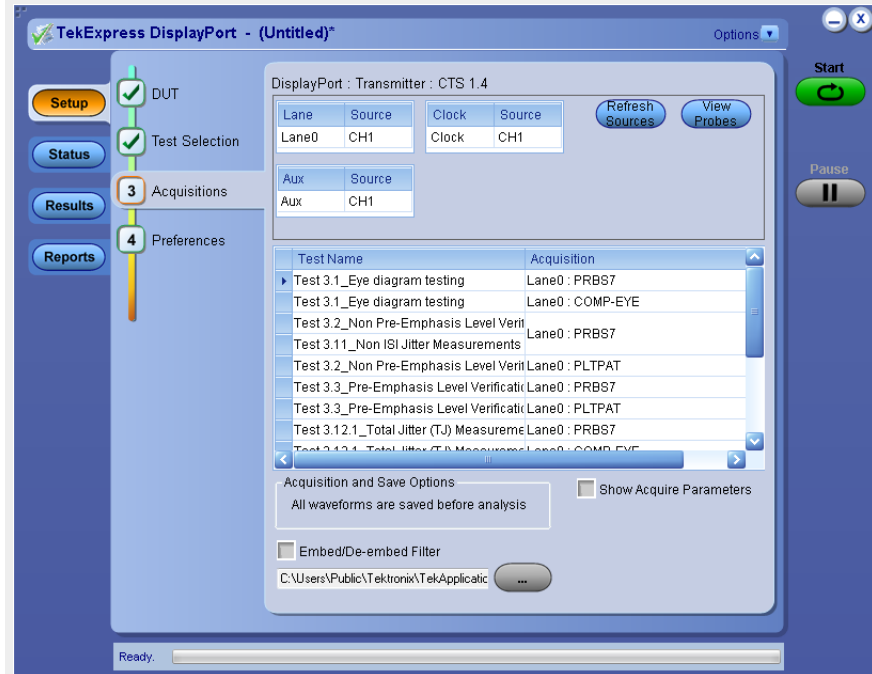

### 4. Configuration

### Configuration tab, Measurements

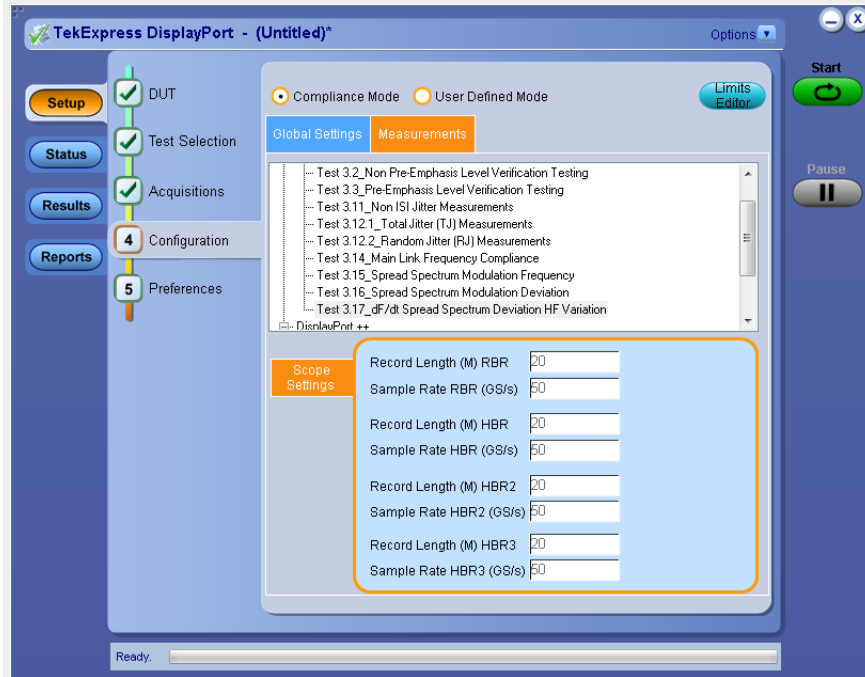

## 5. Preferences

### Preferences tab

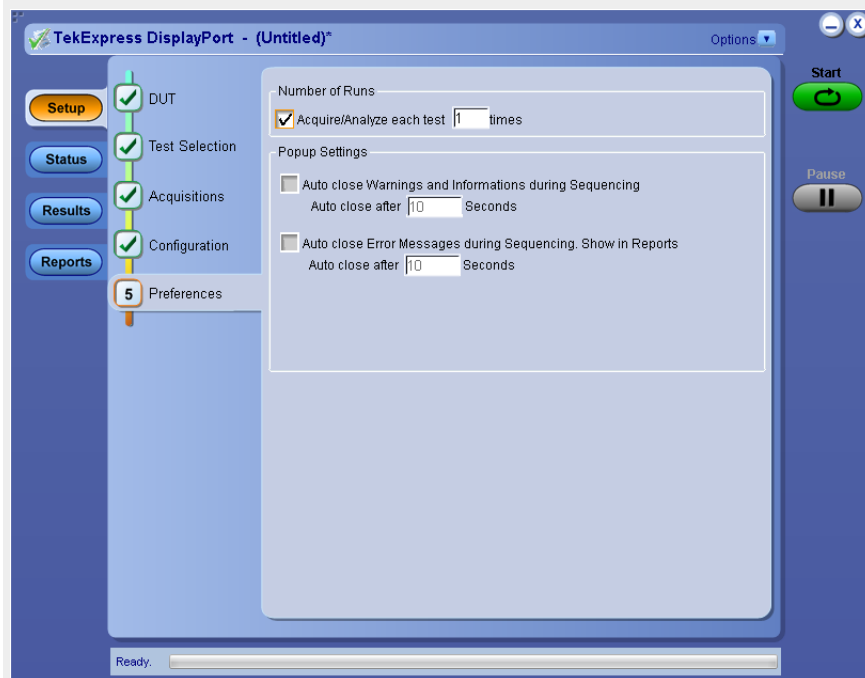

By default, only the DUT, Test Selection, Acquisitions, and Preferences tabs are displayed. The Configuration tab is only available if you select the Advance View option in the DUT tab. Otherwise, configuration settings for tests selected in the Test Selection tab are available from the Configure button on the Test Selection tab.

Options selected in a preceding tab affect options available in the next tab down. For example, Device Profile settings affect the list of tests available for selection in the Test Selection tab. However, you can switch between the tabs in any order if you need to modify your test parameters.

For more information on using the Setup panel, see [About setting up Tests](#).

**See Also.** [About panels](#)

**Status panel** Use the Status panel to track the progress of the test measurements. The Status panel has two tabs: the Test Status tab displays the acquire status and the analysis status of the tests as they are being executed; the Log View tab (shown below) displays a view of the test log.

**Test Status view**

| Test Name  | Acquisition | Acquire Status | Analysis Status |
|--|-------------|----------------|-----------------|
| Lane0  |             |                |                 |
| Test 3.1_Eye diagram testing                           | PRBS7       | Completed      | To be started   |
| Test 3.1_Eye diagram testing                           | COMP-EYE    | In Progress    | To be started   |
| Test 3.2_Non Pre-Emphasis Level Verification Testing   | PRBS7       | Completed      | To be started   |
| Test 3.11_Non ISI Jitter Measurements                  | PRBS7       | Completed      | To be started   |
| Test 3.2_Non Pre-Emphasis Level Verification Testing   | PLTPAT      | Completed      | To be started   |
| Test 3.3_Pre-Emphasis Level Verification               | PRBS7       | Completed      | To be started   |
| Test 3.3_Pre-Emphasis Level Verification               | PLTPAT      | Completed      | To be started   |
| Test 3.12.1_Total Jitter (TJ) Measurements             | PRBS7       | Completed      | To be started   |
| Test 3.12.1_Total Jitter (TJ) Measurements             | COMP-EYE    | In Progress    | To be started   |
| Test 3.12.2_Random Jitter (RJ)                         | D10.2       | Completed      | To be started   |
| Test 3.14_Main Link Frequency Compliance               | D10.2       | Completed      | To be started   |
| Test 3.15_Spread Spectrum Modulation Frequency         | D10.2       | Completed      | To be started   |
| Test 3.16_Spread Spectrum Modulation                   | D10.2       | Completed      | To be started   |
| Test 3.17_dF/dt Spread Spectrum Deviation HF Variation | D10.2       | Completed      | To be started   |

Running...

For more information on using the Status panel, see [View the progress of analysis](#).

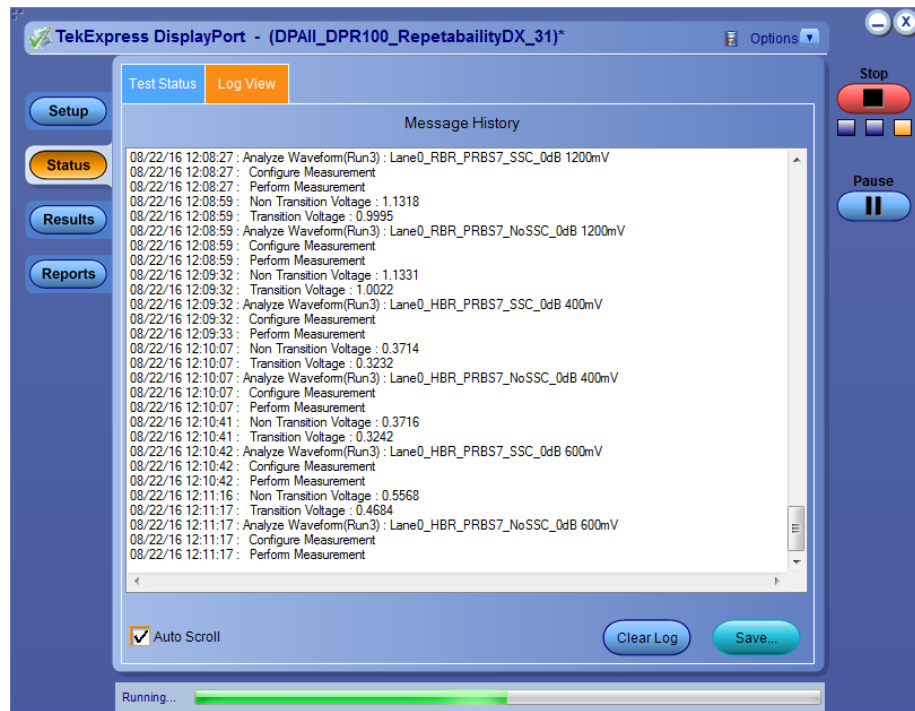

See Also. [About panels](#)

### Results panel

When a test completes running, the application switches to the Results panel to display a summary of test results. Set the viewing preferences for this panel from the Preferences menu in the upper right corner. Viewing preferences include showing whether a test passed or failed, summary results or detailed results, and enabling wordwrap. For information on using this panel, see [View test results](#).



See Also. [About panels](#)

**Reports panel** Use the Reports panel to browse for reports, name and save reports, select report content to include, and select report viewing options.

For information on setting up reports, see [Select report options](#). For information on viewing reports, see [View a report](#).

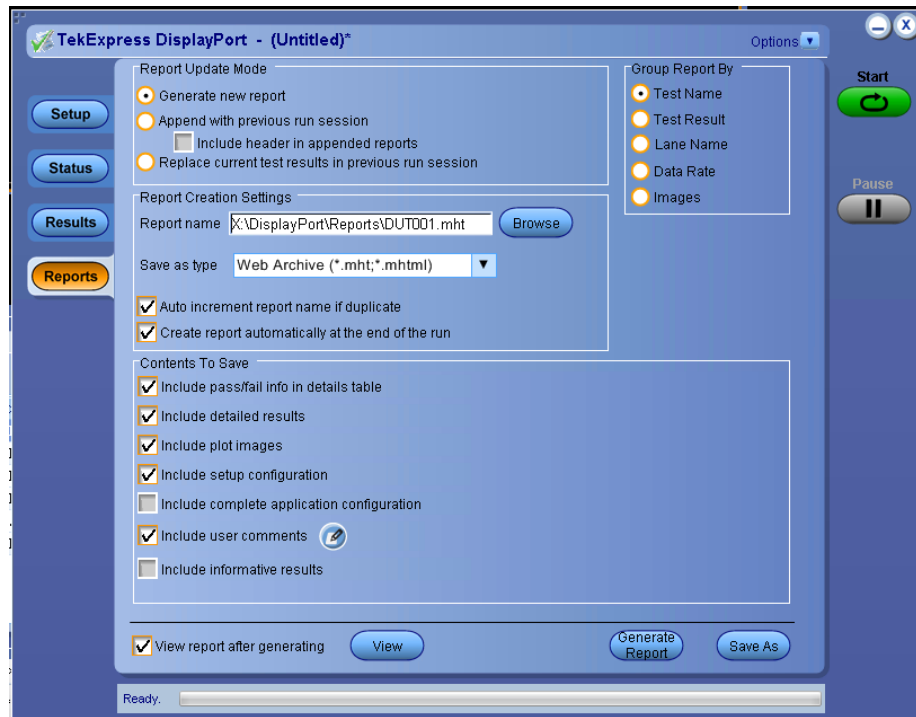

See Also. [About panels](#)

---

# Saving and recalling test setups

## About test setups

TekExpress DisplayPort Tx opens with the default setup selected. Run a test before or after saving a setup. When you save a setup, the test information, such as the selected oscilloscope, general parameters, acquisition parameters, measurement limits, waveforms, and other configuration settings, are all saved under the setup name. Use test setups to:

- [Run a saved test in pre-recorded mode.](#)
- View all the information associated with a saved test, including the Log file, the history of the test status as it executed, and the results summary. For details, see [Recall a saved test setup](#).
- [Create a new test setup based on an existing one.](#)

**See Also** [About setting up tests](#)  
[Save a test setup](#)  
[Delete a test setup](#)

## Save a test setup

You can save a test setup before or after running a test. You can create a new setup from an already opened setup, or using the default setup. When you select the default test setup, all parameters are set to the application's default value.

To Save a test setup, follow the steps:

1. Select the desired options in the Setup panel.
2. Select the desired [report options](#).
3. If desired, run the test to be sure that it captures the information you want. If it does not, edit the parameters.
4. From the Options menu, select **Save Test Setup** to save the setup.

- See Also** [About setting up tests](#)  
[Test setup overview](#)  
[About configuring tests](#)  
[Delete a test setup](#)

## Recall a saved test setup

To Recall a saved test setup, do the following:

1. From the Options menu, select **Open Test Setup**.
2. In the File Open dialog box, select the desired setup from the list and then click **Open**. Setup files are located at X: \DisplayPort folder.

- See Also** [About test setups](#)  
[Create a new test setup based on an existing one](#)  
[Delete a test setup](#)

## Create a test setup from default settings

To create a test setup using default settings, follow the steps:

1. Select **Options > Default Test Setup**. For default test setup, the parameters are set to the application's default value.
2. Click application **Setup** and set the parameters.
3. Click application **Reports** and set the report options.
4. Optional: Click **Start** to run the test and verify that it runs correctly and captures the specified test information and reports. If it does not, then edit the parameters and repeat this step until the test runs to your satisfaction.
5. Select **Options > Save Test Setup**. Enter the file name and click Save. The application saves the file to X:\DisplayPort folder\<session\_name>.





## Recall a saved test setup

To Recall a saved test setup, do the following:

1. Select **Options > Open Test Setup**.

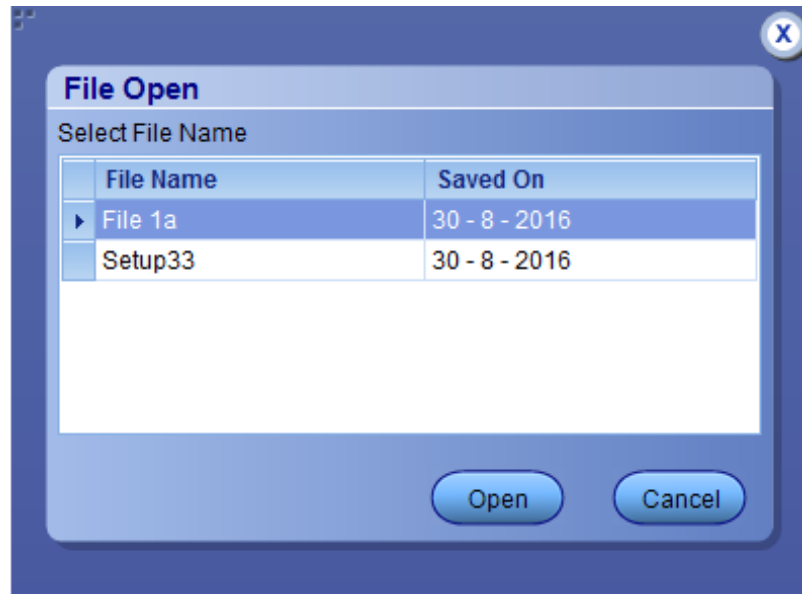

2. Select the setup from the list and click **Open**. Setup files are located at **X:\DisplayPort** folder.

## Create a new test setup using an existing one



To create a new test setup using an existing one, follow the steps:

1. From the Options menu, select **Open Test Setup**.
2. In the File Open dialog box, select the desired setup from the list and then click **Open**.
3. Modify the parameters as desired.
4. From the Options menu, select **Save Test Setup As**.
5. In the File Save As dialog box, enter a test setup name and then click **Save**.

**See Also** [About test setups](#)  
[Delete a test setup](#)

## Delete a test setup

Delete test setups that you no longer need. This also removes them from the test setup list in the Options menu.

1. Make sure the setup you want to delete is not currently selected in TekExpress DisplayPort. To save any of the test information in the test setup folder, save it to a location other than the DisplayPort folder in the My TekExpress folder.
2. Navigate to the DisplayPort on the X: drive and locate the test setup files you want to delete.
3. Delete both the test setup folder and the test setup file (for example,  314-317 and  314-317, respectively).

**See Also** [View test-related files](#)  
[About test setups](#)

---

# Setting up and configuring tests

## About setting up tests

Set up tests using the tabs in the *Setup panel*. Settings in the DUT tab use a top-down, left-to-right logic flow, so that any parameter that affects or acts as a filter for other parameters appears either to the top of or to the left of the affected parameters.

Test options include two views, Compliance and Advanced (selected in the DUT tab of the Setup panel), and two modes, Compliance and User Defined (selected in the configuration settings of the Setup panel). The selected view determines where the test configuration settings are displayed. The selected mode determines whether you can change test configuration settings to include those that are noncompliant. The level of user intervention required depends on the DUT Automation setting and Acquisition parameters.

- **Compliance View** selected with **Compliance Mode**: View configuration options in the Test Selection tab of the Setup panel. Tests will run automatically with little or no user intervention. You will not be able to change test parameters to anything that deviates from the compliance standards. The only test configuration parameters that you can change in this mode are the Real Time Scope and the Digital Filters (DSP), both under Global Settings.
- **Compliance View** selected with **User Defined Mode**: View configuration options in the Test Selection tab of the Setup panel. Tests will run automatically but you will be able to change some test parameters before starting the test.
- **Advanced View** selected with **Compliance Mode**: View configuration options in the Configuration tab of the Setup panel. Tests will run automatically with little or no user intervention. You will not be able to change test parameters to anything that deviates from the compliance standards. The only configuration parameters you can change in this mode are the selected Real Time Scope and the Digital Filters (DSP), both under Global Settings.
- **Advanced View** selected with **User Defined Mode**: View configuration options in the Configuration tab of the Setup panel. Tests will run automatically but you will be able to change some test parameters before starting the test.

## DisplayPort Supported tests

### ■ 3.1 Eye Diagram:

This test evaluates the timing and amplitude support of the overall DisplayPort system objective of Bit Error Rate in data transmission. Eye diagram is plotted to evaluate the timing and amplitude parameters.

This measurement can be run using differential probe as well as single ended probe. Measurement can be run with 1 lane, 2 lanes and 4 lanes connection.

### ■ 3.2 Non Pre-Emphasis Level Verification:

This test is performed to ensure that the system budget is followed and ensures that the level settings are monotonic in nature. Monotonicity helps the Sink can rely on the Source to incrementally increase upon by the sink.

This measurement can be run using differential probe as well as single ended probe. Measurement can be run with 1 lane, 2 lanes and 4 lanes connection.

### ■ 3.3 Pre-Emphasis Level Verification and Maximum Peak-to-Peak Differential Voltage Testing:

This test measures the pre-emphasis of the Source waveform, by measuring the peak to peak differential amplitude. Comparisons are made for the Level 0 transition state as well the as non-transition levels. Maximum peak to peak amplitude is also measured.

This measurement can be run using differential probe as well as single ended probe. Measurement can be run with 1 lane, 2 lanes and 4 lanes connection.

### ■ 3.4 Inter-Pair Skew Test:

This test evaluates the skew, or time delay, between the differential data lanes.

This measurement can be run using differential probe as well as single ended probe. This Measurement can be run only with 2 lanes and 4 lanes connection.

### ■ 3.5 Intra-Pair Skew Test:

This test evaluate the skew or the time delay, between respective sides of a differential data lane.

This measurement can be run using single ended probe. This Measurement can be run only with 1 lane, 2 lanes and 4 lanes connection.

### ■ 3.10 AC Common Mode Noise:

This test evaluates the AC Common mode noise (unfiltered RMS) of the differential data line.

This measurement can be run using single ended probe. This Measurement can be run only with 1 lane, 2 lanes and 4 lanes connection.

### ■ 3.11 Non ISI Jitter Measurements:

This test evaluates the amount of Non-ISI jitter accompanying the data transmission.

This measurement can be run using differential probe as well as single ended probe. Measurement can be run with 1 lane, 2 lanes and 4 lanes connection.

### ■ 3.12 Total Jitter and Random Jitter (RJ/DJ) Measurement:

This test evaluates the total jitter at 10<sup>-9</sup>. This can be measured explicitly at this rate or through an approved estimation technique.

This measurement can be run using differential probe as well as single ended probe. Measurement can be run with 1 lane, 2 lanes and 4 lanes connection.

- 3.14 Main Link Frequency Compliance:

This test ensure that the average data rate under all conditions does not exceed minimum or maximum as set by the standard.

This measurement can be run using differential probe as well as single ended probe. Measurement can be run with 1 lane, 2 lanes and 4 lanes connection.

- 3.15 Spread Spectrum Modulation Frequency:

This test evaluates the frequency of the SSC modulation.

This measurement can be run using differential probe as well as single ended probe. Measurement can be run with 1 lane, 2 lanes and 4 lanes connection.

- 3.16 Spread Spectrum Modulation Deviation:

This test evaluates the range of SSC down-spreading of the transmitter signal.

This measurement can be run using differential probe as well as single ended probe. Measurement can be run with 1 lane, 2 lanes and 4 lanes connection.

- 3.17 dF/dt Spread Spectrum Deviation HF Variation:

This test verifies SSC profile and it does not include any frequency deviation which would exceed 1250ppm/uSec.

This measurement can be run using differential probe as well as single ended probe. Measurement can be run with 1 lane, 2 lanes and 4 lanes connection.

## Dual Mode tests

- 3.18 Dual Mode TMDS Clock:

This test verifies the duty cycle of the TMDS clock waveform of a source operating in dual mode.

This measurement can be run only using differential probe. Measurement can be run with 1 lane, 2 lanes and 4 lanes connection.

- 3.19 Dual Mode Eye Diagram:

This test performs the eye diagram measurement and finds the timing variables and amplitude trajectories for a dual mode source device.

This measurement can be run only using differential probe. Measurement can be run only with 4 lanes connection.

### Aux Channel tests

- 8.1 AUX Manchester Channel Eye Testing:  
Checks if AUX Manchester channel eye waveform timing variables and amplitude trajectories support DisplayPort system.  
This measurement can be run using differential probe as well as single ended probe. Measurement can be run with 1 lane connection.
- 8.2 AUX Channel Eye Sensitivity Test:  
Evaluates the sensitivity to the AUX CH EYE opening of a DUT.  
This measurement can be run using differential probe as well as single ended probe. Measurement can be run with 1 lane connection. This measurement is visible only when DUT automation is not manual.
- 8.5 Inrush Test:  
Evaluate the Inrush energy at the power supply Input of a power consuming DUT.  
This measurement can be run using single ended probe. Measurement can be run with 1 lane connection.

**See Also** [Test setup overview](#)  
[Before you click start](#)  
[Deskew channels](#)  
[About running tests](#)

## Equipment connection setup

To run tests, you need the following equipment (for details, see [Minimum System Requirements](#)):

- A [supported Tektronix oscilloscope](#)
- TCA-SMA or Differential Probes (for example, P7313SMA)
- The device under test
- Test fixtures

The following diagrams show different setups. To view a diagram, click the one for the desired setup.

### AUX Channel Eye diagram using VTM fixture and DP AUX with single ended probes

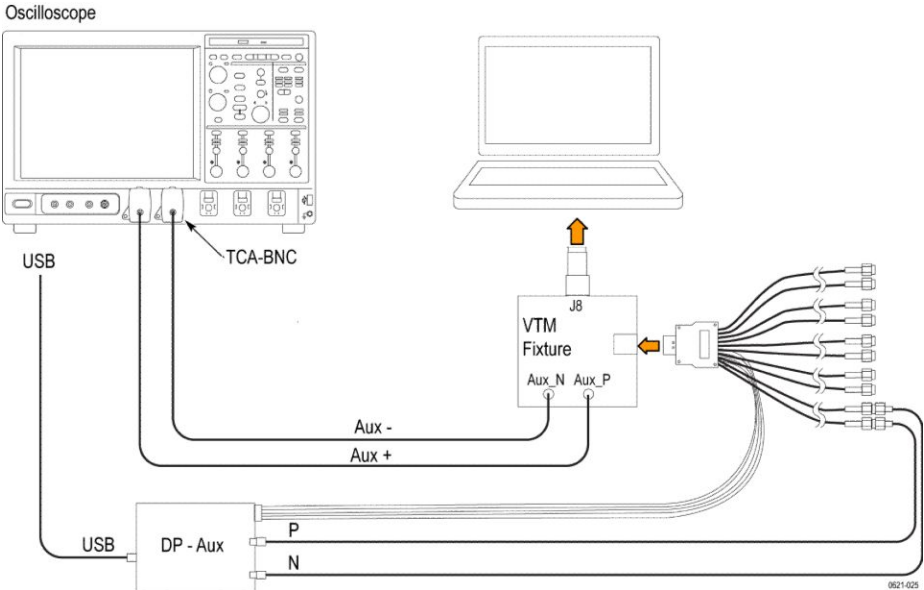

### AUX Channel Eye diagram using VTM fixture and DP AUX with differential probes

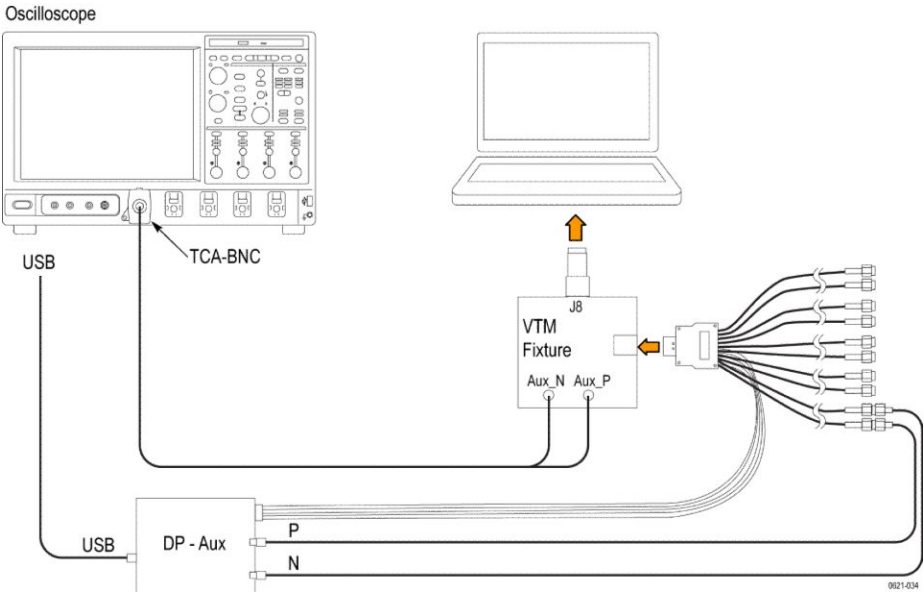

### AUX Channel Eye diagram using Wilder fixture and DP AUX with single ended probes

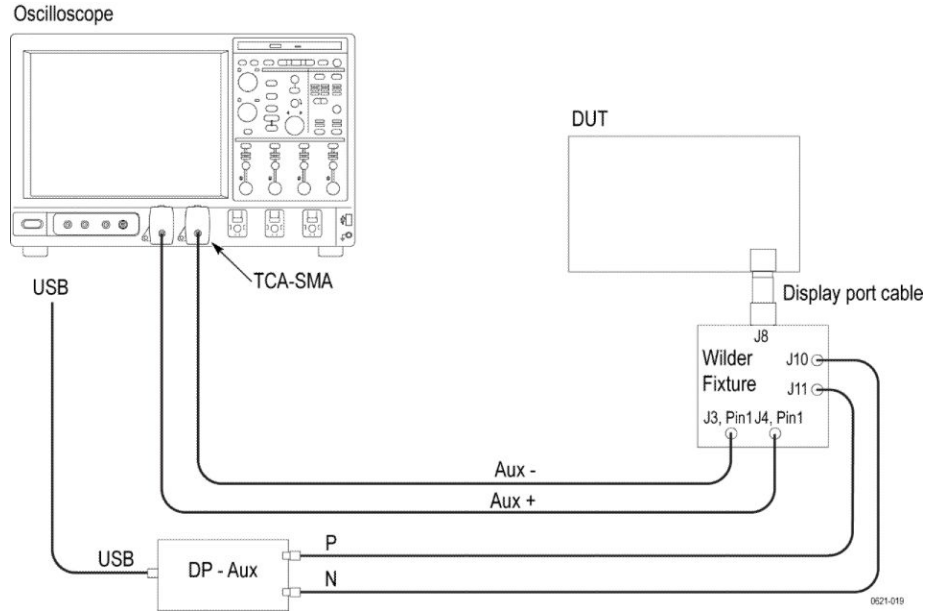

### AUX Channel Eye diagram using Wilder fixture and DP AUX with differential probes

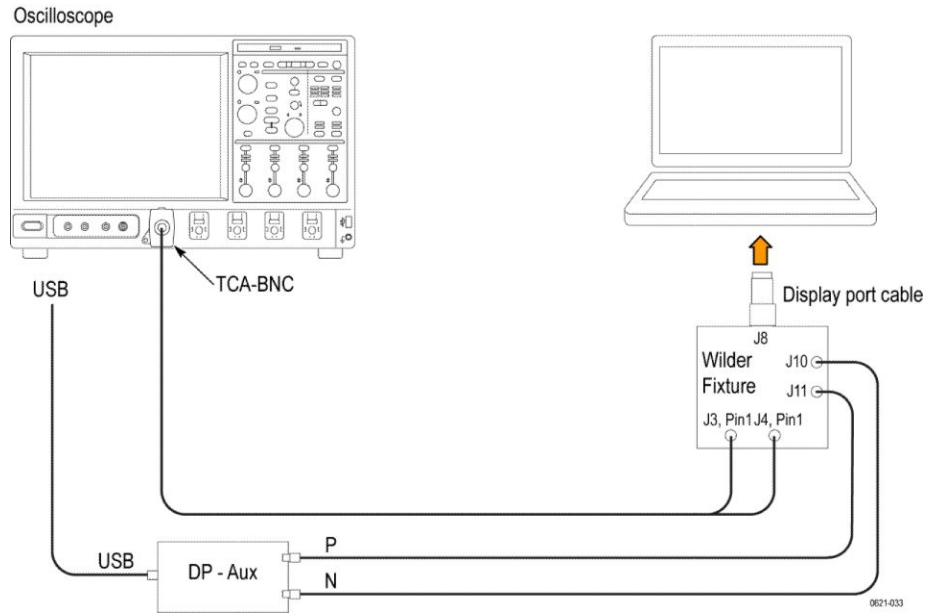



AUX Channel Sensitivity test using VTM fixture and DP AUX with single ended probes

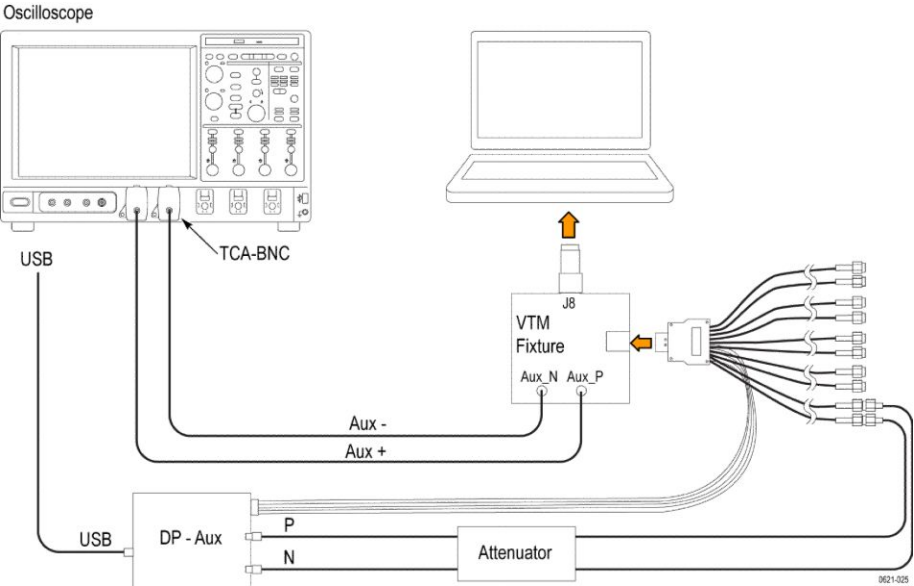

AUX Channel Sensitivity test using VTM fixture and DP AUX with differential probes

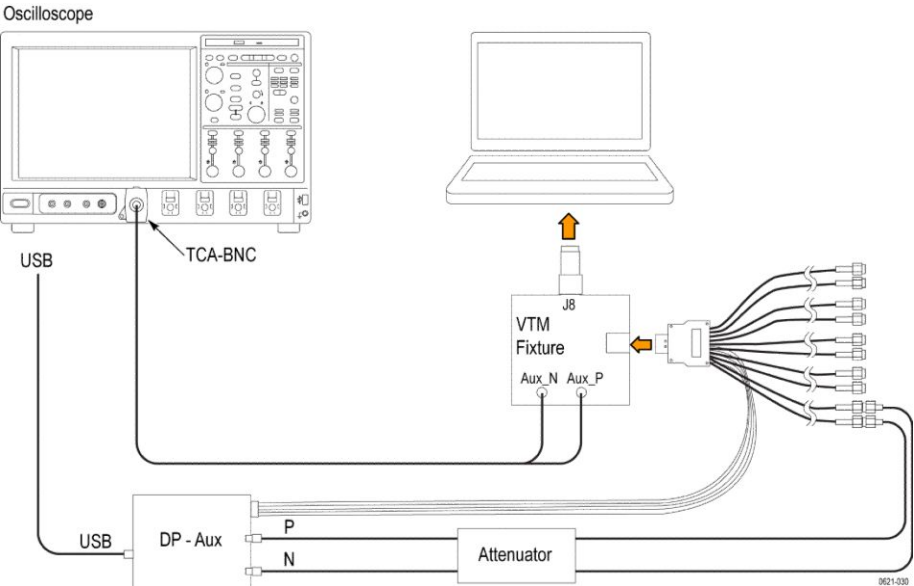

### AUX channel sensitivity setup with DP-AUX and Wilder fixture

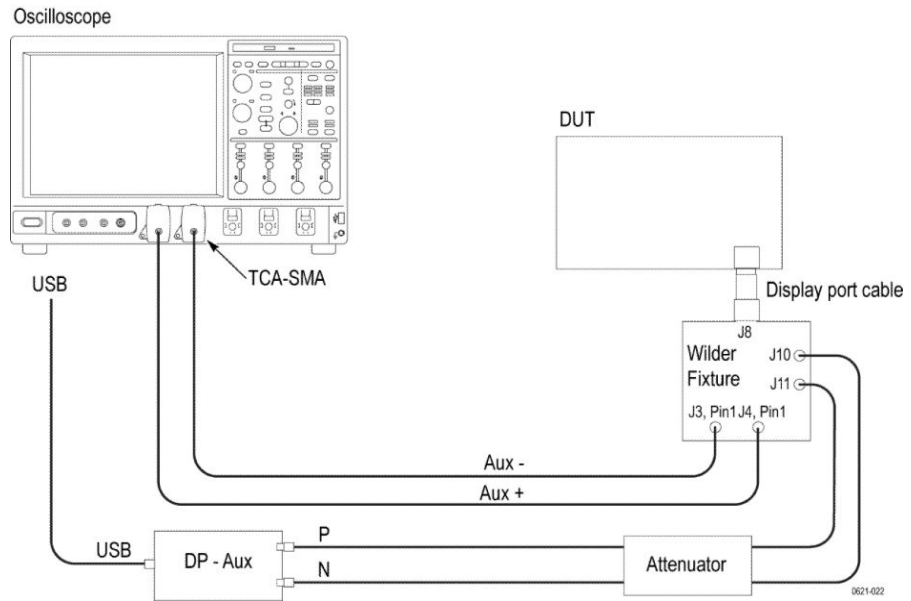

### AUX Channel Sensitivity test using Wilder fixture and DP AUX with differential probes

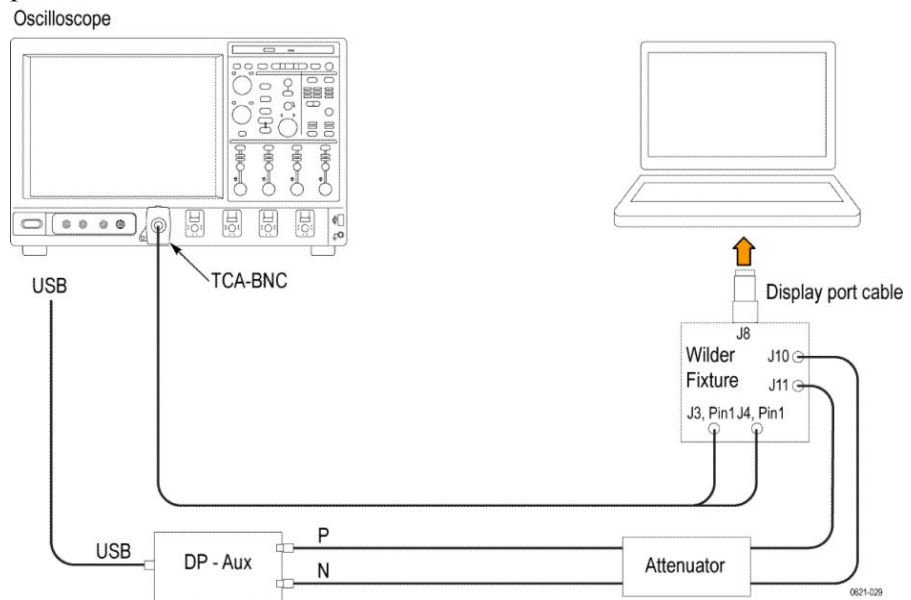

AUX channel Eye diagram and Sensitivity test using VTM fixture and DPR-100 with single ended probes

Oscilloscope

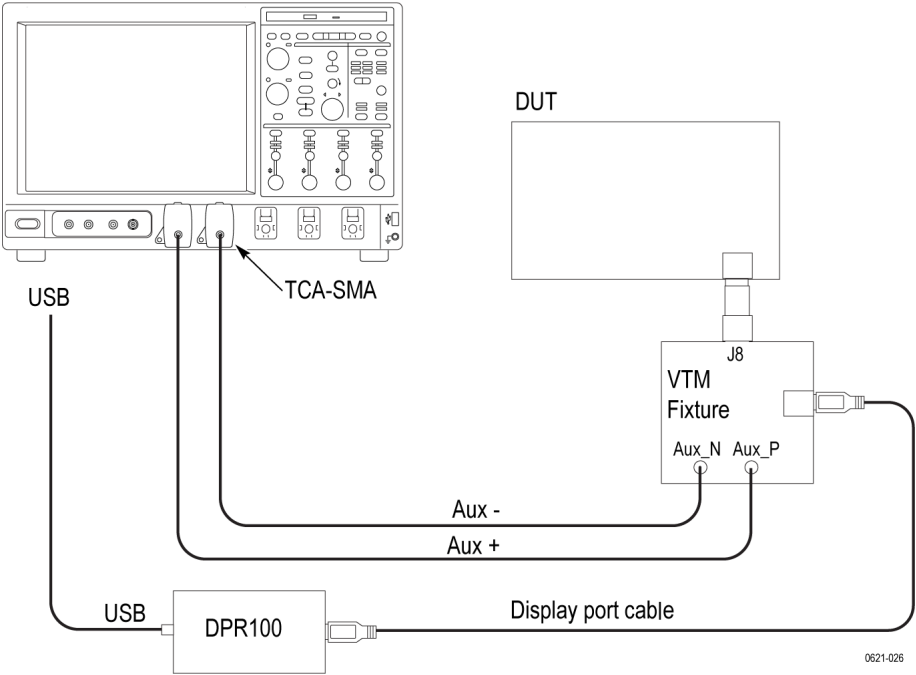

AUX Channel Eye diagram and Sensitivity test using VTM fixture and DPR-100 with differential probes

Oscilloscope

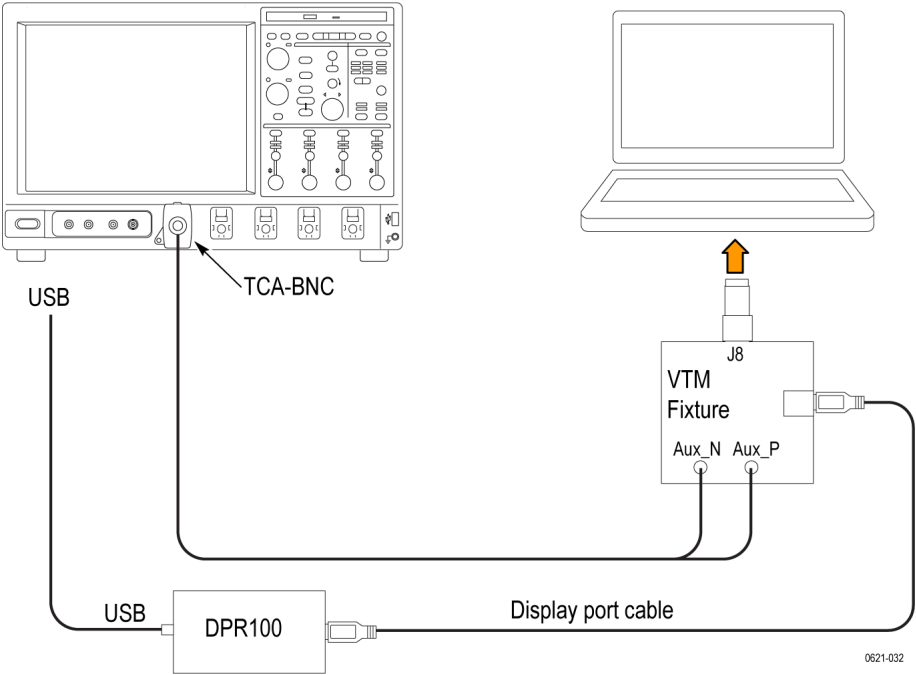

### AUX Channel Eye diagram and Sensitivity test using Wilder fixture and DPR-100 with single ended probes

Oscilloscope

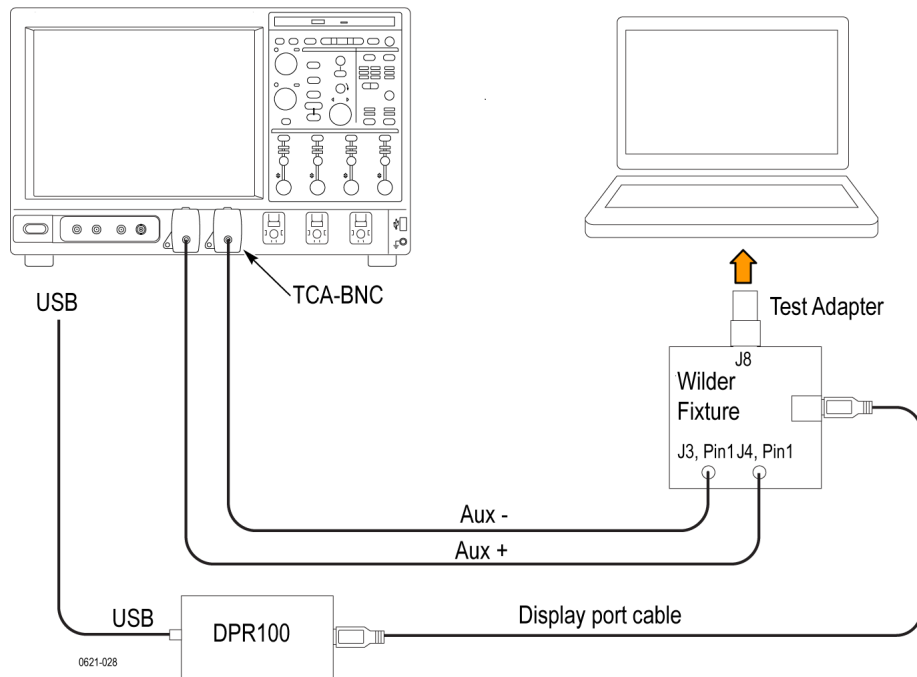

### AUX Channel Eye diagram and Sensitivity test using Wilder fixture and DPR-100 with differential probes

Oscilloscope

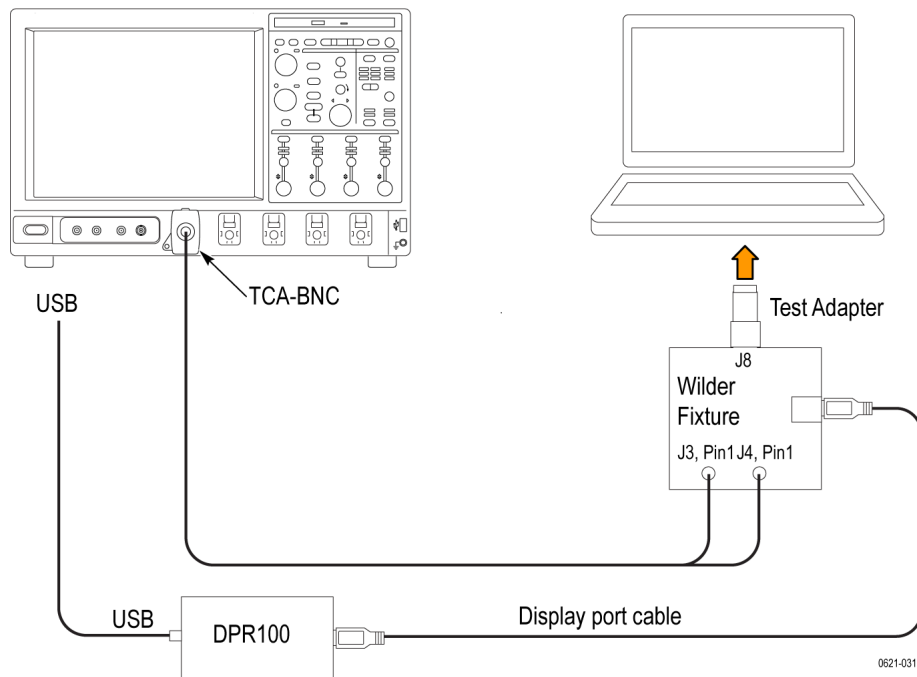

### DisplayPort setup with DP-AUX controller and differential probes

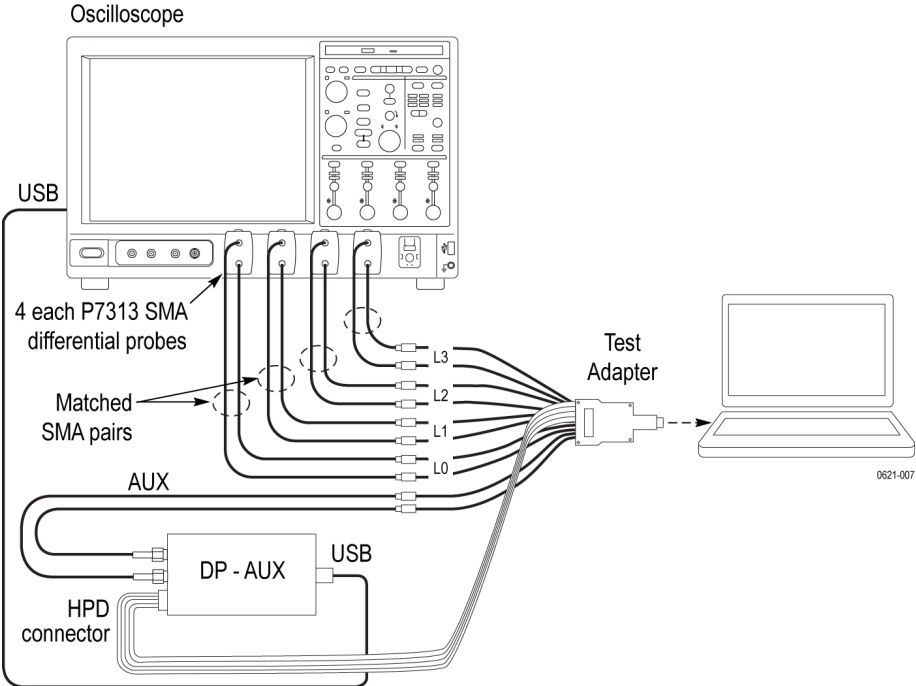

### DisplayPort setup with DP-AUX controller and single ended probes

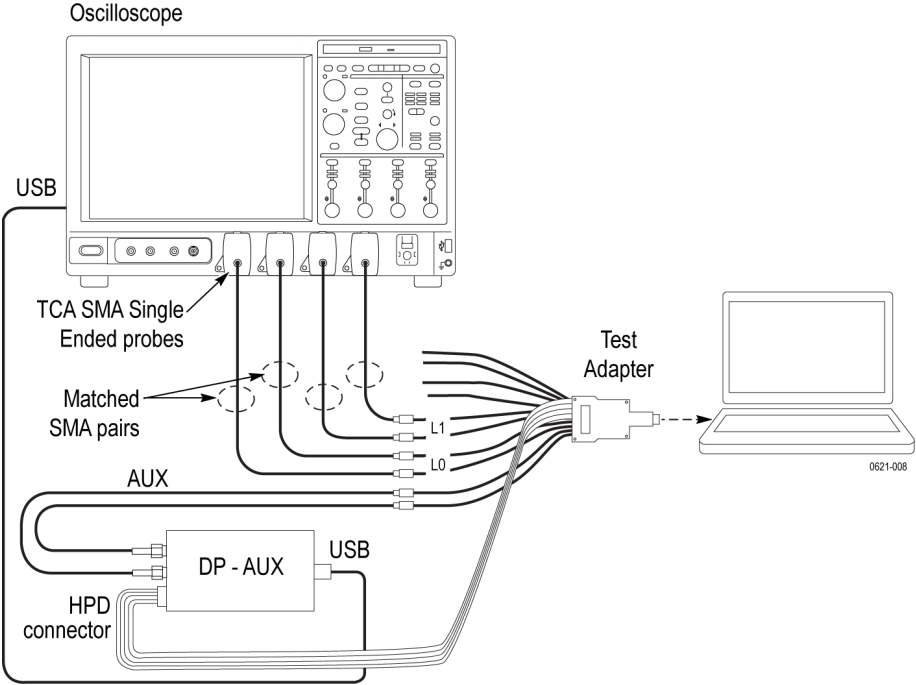

### DisplayPort setup with DPR-100 and differential probes

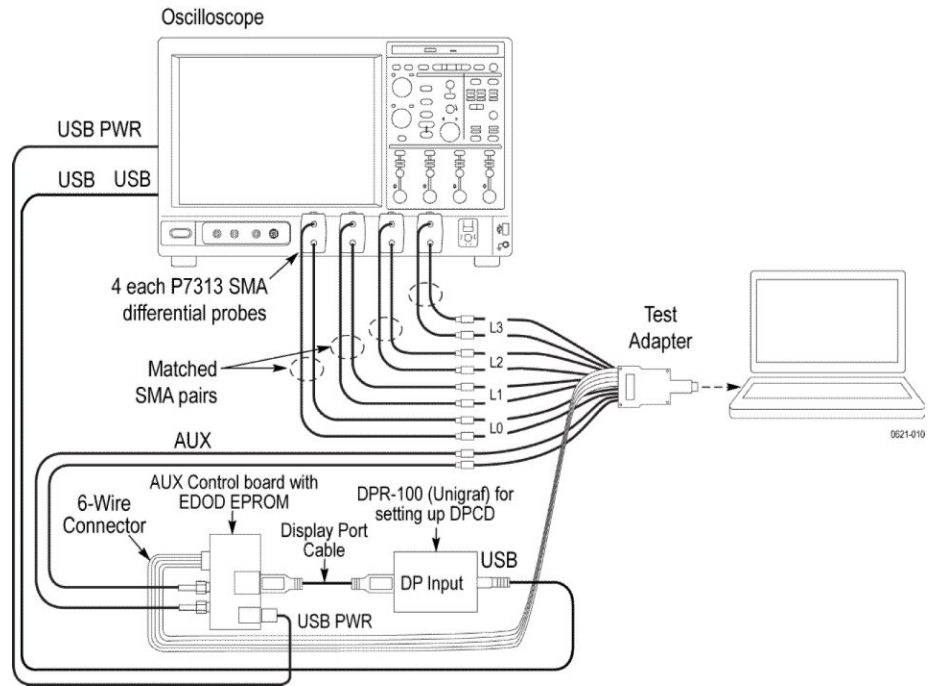

### DisplayPort setup with DPR-100 and single ended probes

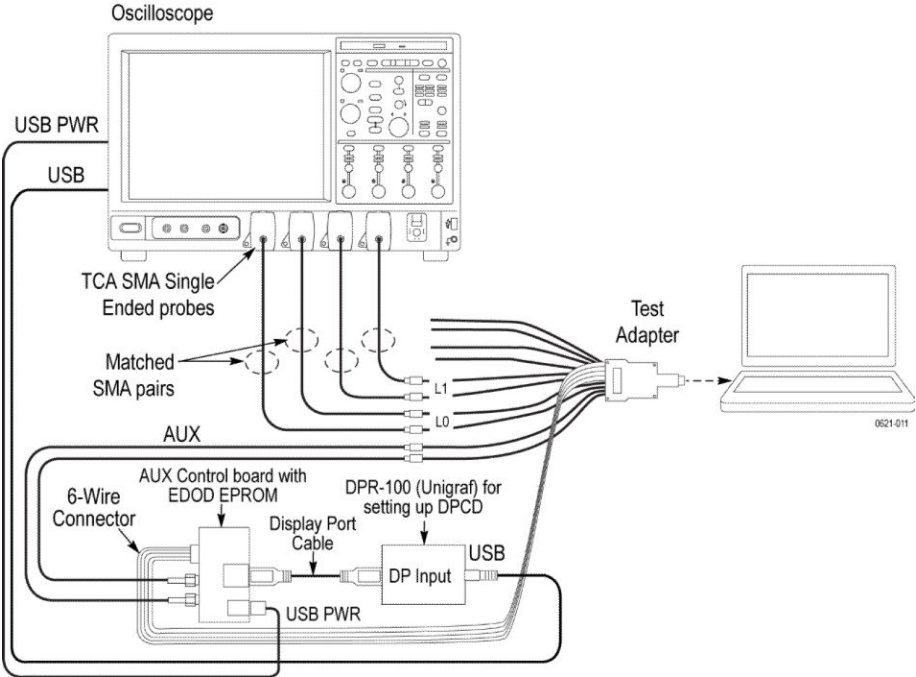

### DisplayPort setup for Dual Mode test

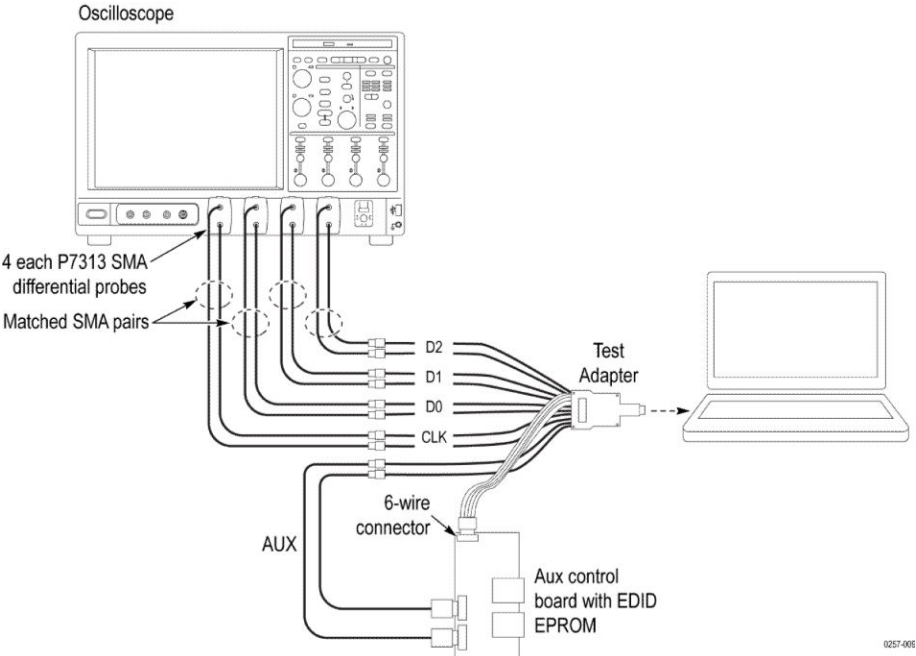

Inrush setup diagram

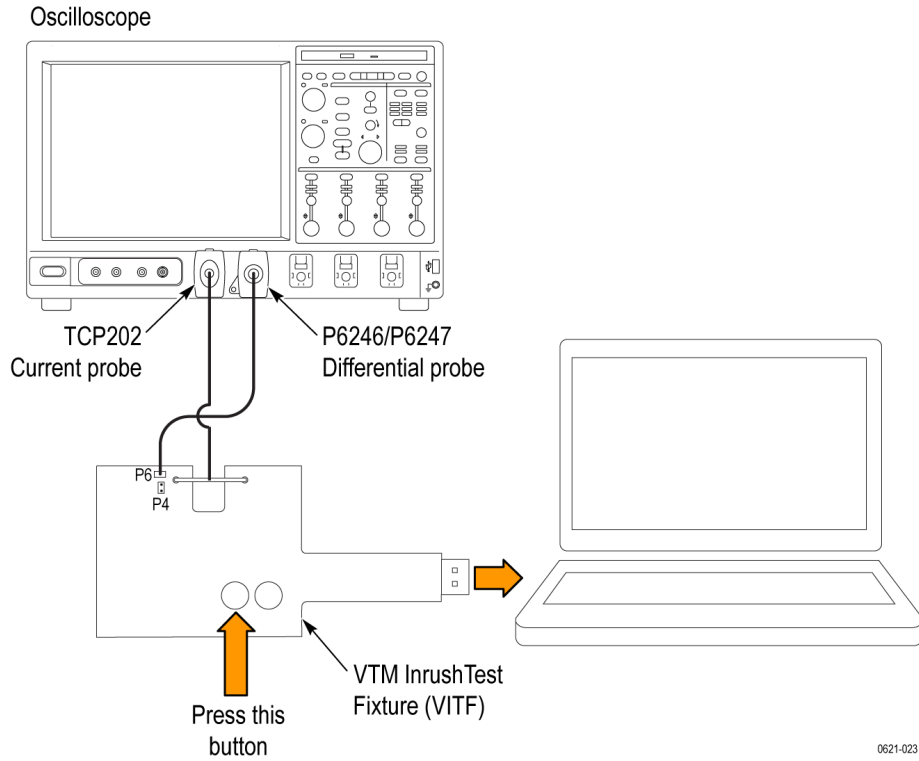

DisplayPort setup for Type C with GRL controller and Type C fixture

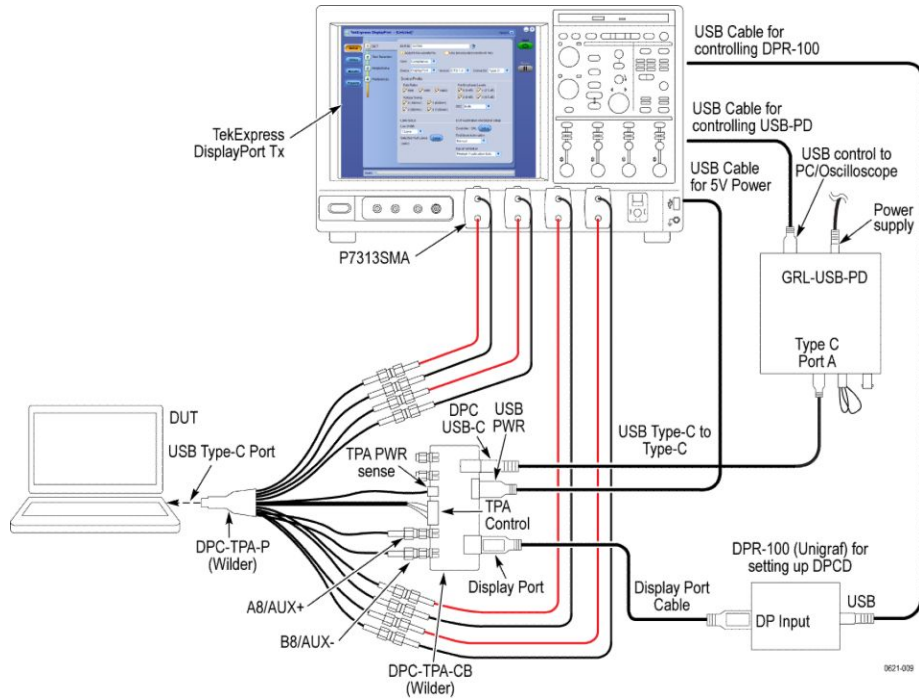

For testing ML0 and ML3 signals(i.e Pins A10-A11, B10-B11), connect recommended DC blocks at the output of the test fixture.



**See Also**    [View connected instruments](#)  
[About setting up tests](#)  
[Pre-Run checklist](#)  
[Deskew channels](#)

## View connected instruments

Use the Instrument Control Settings dialog box to view or search for connected instruments required for the tests. The application uses TekVISA to discover the connected instruments.

To refresh the list of connected instruments:

---

**NOTE.** *The correct instruments required for the test setup must be connected and recognized by the application before running the test.*

---

1. From the Options menu, select **Instrument Control Settings**.
2. In the **Search Criteria** section of the Instrument Control Settings dialog box, select the connection types of the instruments to search for.

Instrument search is based on the VISA layer but different connected cables determine the resource type, such as LAN, GPIB, USB. For example, if you choose LAN, the search will include all the instruments supported by TekExpress that are communicating over the LAN. If the search does not find any instruments that match a selected resource type, a message appears telling you that no such instruments were found.

3. Click **Refresh**. TekExpress searches for connected instruments.
4. After searching, the dialog box lists the instrument-related details based on the search criteria you selected. For example, if you select LAN and GPIB as the search criteria, the application checks for the availability of instruments over LAN, then GPIB.

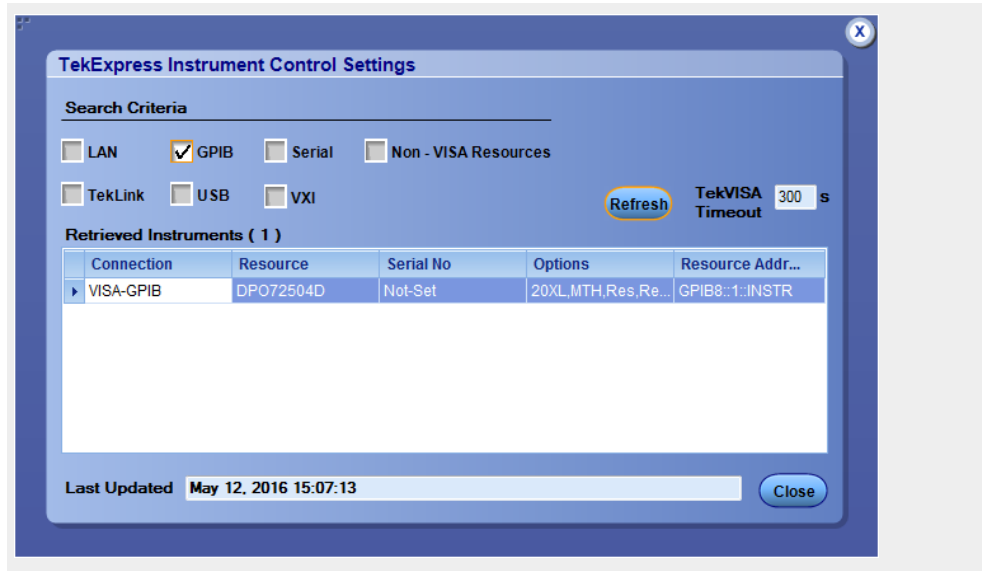

The details of the connected instruments are displayed in the Retrieved Instruments table. The time and date of instrument refresh are displayed in the Last Updated field.

**See Also** [Configure tests](#)  
[Equipment connection setup](#)

## Test setup overview

Test setup includes acquisition and configuration parameters, but you can also select report options when you set up tests. Below are listed the main test setup steps. Most test setup options are located in the [Setup panel](#), but options specific to reports are located in the [Reports panel](#).

1. [Select settings for the device under test.](#)
2. [Select one or more tests.](#)
3. [Select acquisitions.](#)
4. [Configure tests.](#)
5. [Select analysis and test notification preferences.](#)
6. [Select report options.](#)

**See Also** [Before you click start](#)  
[Pre-Run checklist](#)  
[About running tests](#)

**Select DUT parameters** Use the Setup panel DUT tab settings to select settings for the device under test. These options affect the list of available tests in the Test Selection tab.

---

**NOTE.** *If connected DUT does not have certain capabilities, then the user has to select DUT options accordingly and run the test. For example, if the DUT does not support SSC, then the user should select SSC disable option in the drop-down of the DUT panel.*

---

1. In the Setup panel, click the **DUT** tab.
2. Select the global DUT settings that will apply to all tests for the current session:
  - a. If needed, in the DUT ID field, enter the ID for the device. The default value is DUT001. The name in this field appears on test reports.
  - b. (Optional) To add comments that will appear at the top of the test report (if the Include User Comments option is selected in the Report options), click the note pad icon () to the right of the DUT ID field and specify a comment of up to 256 characters.
  - c. Select whether to use a pre-recorded waveform file or acquire a live waveform for testing.
  - d. For View, select **Compliance** or **Advanced**.

---

**NOTE.** *If you select Advanced View, the configuration settings are included in the Setup steps as step 4. If you select Compliance View, the configuration step is not included as a separate step. Access configuration parameters for selected tests from the Configure button in the Test Selection tab.*

---

- e. Displays DisplayPort as the default Device.
- f. By default, displays the latest CTS version.

- g. Select Standard or Type C as the Connector.

If Type C is selected, GRL controller appears. Click **Setup** button, Alt Mode Settings popup appears.

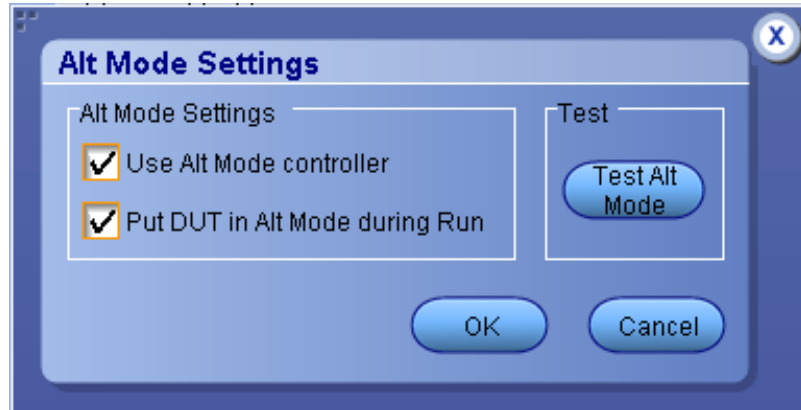

When **Use Alt Mode controller** is

- Selected: The application uses the available alt mode controller during the execution.

It enables Put DUT in Alt Mode during Run.

- When **Put DUT in Alt Mode during Run** is selected, the application will put the DUT in alt mode every time run button is pressed.
- When **Put DUT in Alt Mode during Run** is unselected, the application assumes that the DUT is already in alt mode.
- Unselected: The application will not use the alt mode controller (functions same as in manual mode of operation).

Select the DUT Automation as 'Manual', if you want to put the DUT in the Alt mode using some other device, instead of the GRL controller. To control the DUT, the HPD-IRQ from the Alt mode controller signal must be detected.

---

**NOTE.** *Alt mode controller is used to put the DUT in ALT mode and to issue HPD-IRQ signal.*

---

3. Below listed are the Device Profile options.

Table 7: Device Profile options:

| Setting             | Description / Option   |
|---------------------|--|
| Data Rates          | <p>Select the data rates to include in the tests.</p> <ul style="list-style-type: none"> <li>■ RBR: Reduced Bit Rate (1.62 Gb/S)</li> <li>■ HBR: High Bit Rate (2.7 Gb/S)</li> <li>■ HBR2: High Bit Rate 2 (5.4 Gb/S)</li> <li>■ HBR3: High Bit Rate 3 (8.1 Gb/S)</li> </ul>   |
| Voltage Swing       | All voltage levels are selected by default. At least one voltage swing level must be selected at all times.  |
| Pre-Emphasis Levels | All pre-emphasis levels are selected by default. At least one pre-emphasis level should be selected.   |
| SSC                 | <p>Only one of the following options can be selected at a time for Spread Spectrum Clocking:</p> <ul style="list-style-type: none"> <li>■ SSC Enable: When selected, only the acquisitions that support the SSC On condition will be tested.</li> <li>■ SSC Disable: When selected, only the acquisitions that support the SSC Off condition will be tested.</li> <li>■ Both: When selected, the tests will run under both conditions for those acquisitions that support both.</li> </ul>                 |
| Link Width          | <p>To access this field, you have to click <b>Multi-Lane</b> 'Setup' button. Select the desired number of test lanes to use for this test session. The length width shown here determines the number of test lanes you can select.</p> <ul style="list-style-type: none"> <li>■ 1 Lane: When selected, only one lane can be used</li> <li>■ 2 Lanes: When selected, any one lane or two lanes can be used</li> <li>■ 4 Lanes: When selected, only a lane or two lanes or four lanes can be used</li> </ul> |

| Setting             | Description / Option   |
|---------------------|--|
| Selected Test Lanes | <p>Displays the test lanes selected for the test session<br/>To change lanes selected for testing, click <b>Setup</b>.</p> <ol style="list-style-type: none"> <li>a. In the Test Lane Setup dialog box, select the desired number of lanes from the Link Width drop-down list.</li> <li>b. To select the lanes to use, click the corresponding lane buttons: <ul style="list-style-type: none"> <li>■ To select all four lanes at once, click <b>Select All</b>. If you select this, select <b>4 Lanes</b> from the Link Width drop-down list.</li> <li>■ To deselect all selected lanes, click <b>Deselect All</b>.</li> <li>■ If you select 1 Lane, only one lane can be used.</li> <li>■ If you select 2 Lanes, any one lane or two lanes can be used.</li> <li>■ If you select 4 Lanes, only a lane or two lanes or four lanes can be used.</li> </ul> </li> <li>c. Click <b>OK</b>.</li> </ol> <p>Your selections display in the Link Width section of the DUT tab.</p> |
| DUT Automation      | <p>Displays the type of DUT control currently in use. The user has to configure the settings.</p> <ul style="list-style-type: none"> <li>■ <b>Manual</b> (default): You will be prompted to configure the DUT manually during the test. You can change this to Custom if needed.</li> <li>■ <b>DP AUX</b>: Select this option to configure the DUT using DP AUX.</li> <li>■ <b>DP Nvidia</b>: Select this option to use the Tektronix DP-AUX controller with NVIDIA chip/DUT.</li> <li>■ <b>DPR-100</b>: Select this option to configure the DUT using Unigraf DPR-100.</li> </ul> <p>When DPR-100 is selected, DPR-100 pop appears for the first time. Enter the valid license key to use DPR-100.</p>  |
| Signal Validation   | <ul style="list-style-type: none"> <li>■ <b>Prompt if validation fails</b>: When selected, user is prompted if pattern validation fails. The user will be given the option to Reacquire, Use Anyway, Skip and Abort the execution.</li> <li>■ <b>Skip test if validation fails</b>: When selected, it will skip the corresponding test(s) if pattern validation fails.</li> <li>■ <b>Skip validation</b>: When selected, skips the validation for all the patterns.</li> </ul>   |

**See Also.** [Select a test](#)

[About setting up tests](#)

[Use pre-recorded waveforms for analysis](#)





[Acquire live waveforms for analysis](#)

**Select a test** Use these instructions to select the tests to run on the connected DUT.

1. In the Setup panel, click the **Test Selection** tab.
2. All tests are selected by default. Click **Deselect All** if you do not want to run all tests.
3. Select the desired test(s):
  - To select all required tests, click the **Select Required** button.
  - To select all tests in the list, click the **Select All** button.
  - To select one or more tests, select the check boxes for the tests.

Test selection controls

**Table 8: Setup panel test controls**

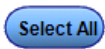
| Button  | Description  |
|---|--|
|  | When the View type selected in the DUT tab is Compliance, this button opens a configuration section for the selected test. If the View type is Advanced, this button is not displayed. |
|  | Displays the schematic document for the selected test. Use to verify the test setup before running the test  |
|  | Deselects all tests in the table   |
|  | Selects tests required for compliance and deselects all other tests currently selected   |
|  | Selects all tests in the test selection panel.   |

**NOTE.** For HBR2 and HBR3 speed: Total Jitter, and Random Jitter tests are dependent on selection of Eye diagram tests.

**See Also.** [Select acquisitions](#)

[About setting up tests](#)

**Selecting acquisitions**

**About acquisitions.** Use the Acquisitions tab in the Setup panel to view *acquisitions parameters* for the selected tests.

The information on the Acquisitions tab is specific to the tests selected in the Test Selection tab and gets updated every time you change the selected tests. Options available also depend on whether you selected to *acquire live waveforms* or *use pre-recorded waveform files* in the DUT tab.

The top section of the Acquisitions tab is the source selection area. The information that appears here depends in part on which type of setup you are using.

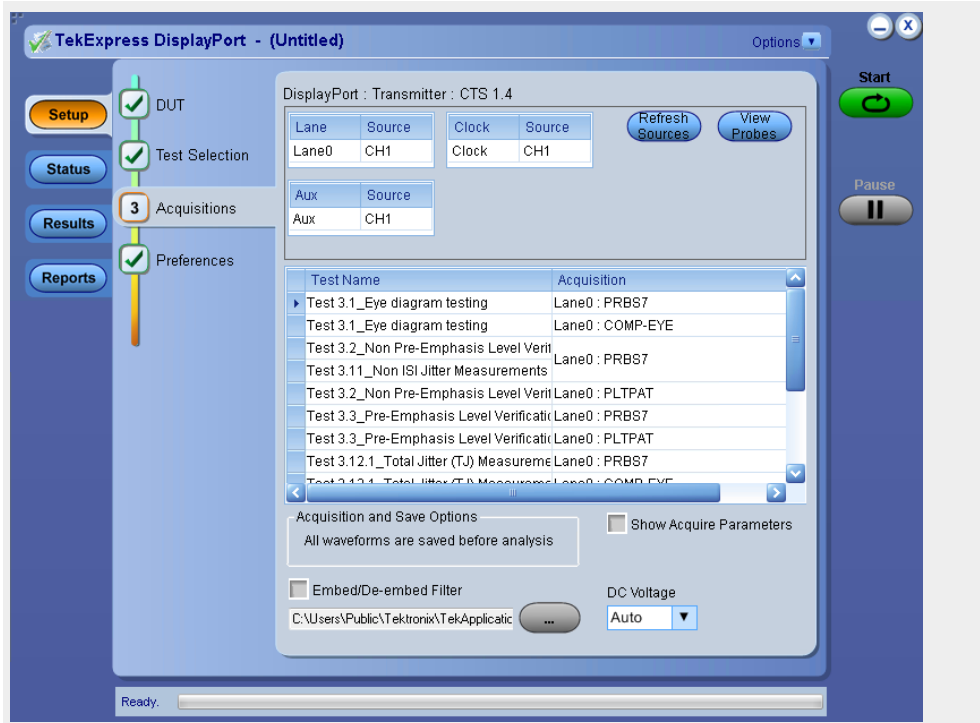



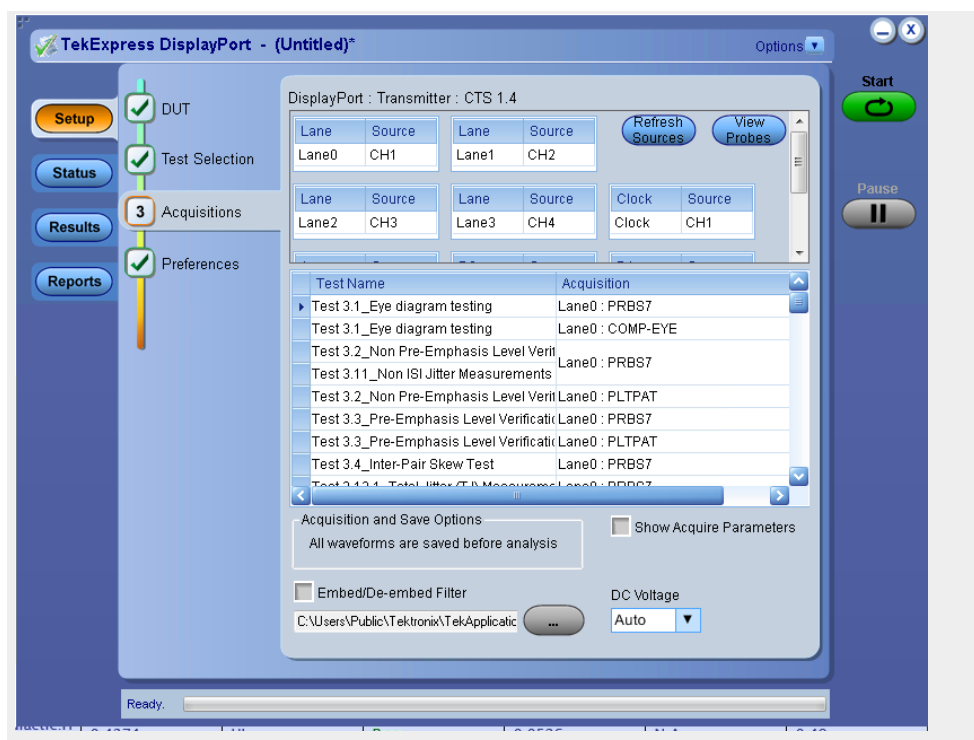

Below the source area is the test acquisition and mapping table. If the same acquisition can be used for multiple tests, then the test acquisitions table will show these rows as merged. Additional acquisition options appear below the table.

**Table 9: Acquisitions table**

| Column name                  | Function   |
|------------------------------|--|
| Test Name                    | Displays the name of the selected test that the acquisitions apply to. One or more tests can perform the same acquisitions.  |
| Acquisition                  | Displays the acquisition type for each measurement.  |
| (Parameter Name)             | Displays a column for each parameter available in the test. Cells in the column might display the status of whether the measurement was included in the measurement, supported by the test, or the parameter setting.                          |
|                              | <b>NOTE.</b> Parameter name is displayed only when <b>Show Acquire parameter</b> is enabled.   |
| Waveform FileName            | Lists the name of the waveform files used for the test. Select waveform files by clicking the button in the row. This allows you to select any waveform file using the standard File Open window. This applies to pre-recorded waveforms only. |
| Acquisition and Save Options | All waveforms are saved before analysis.   |

| Column name             | Function  |
|-------------------------|---|
| Show Acquire Parameters | When enabled displays the parameter name.   |
| De-embed Filter         | Browse to the location of the filter file to de-embed. All filter files are available in this location, C:\Users\Public\Tektronix\TekApplications\DisplayPort\Filters folder.<br><br><b>NOTE.</b> De-embed feature is applicable in live mode only. |
| DC Voltage              | DC voltage settings for acquiring the waveform.   |

---

**NOTE.** For DP++ tests, you must select sources for Clock lane and Data lanes. For Aux tests, select sources for AUX lane.

---

**See Also.** [Select acquisitions](#)

[About setting up tests](#)

**Set acquisition tab parameters.** Use the Acquisitions tab in the Setup panel to view and set acquisition parameters for selected tests. Options available depend on whether you are using a live waveform or a pre-recorded waveform file.

1. In the Setup panel, click the **Acquisitions** tab.
2. If you selected to use a pre-recorded waveform file, in the Acquisitions table, scroll to the Waveform FileName column. For each acquire type row, click the ellipsis button (⋮) and select the desired waveform file or files.
3. If you selected to use live waveforms, then the lane and channel selection tables are displayed near the top of the tab. The selections displayed are based on the available probe setup.
  - To see which probes are connected to which channels, click **View Probes**.
  - To refresh the probe configuration information displayed after changing any probes, click **View Probes** and then click **Refresh** in the Probe Configuration dialog box.
  - To change a lane source, click in the Source column and select a channel from the drop-down list.
4. Select any other desired [acquisition options](#).

**See Also.** [Configure tests](#)

[About setting up tests](#)

[Test setup overview](#)

**Acquisitions parameters.** Available parameters depend on the selected mode (Compliance or User Defined) and the type of waveform being used, live or pre-recorded.

**Table 10: Acquisitions options**

| Option                  | Description   |
|-------------------------|---|
| Show Acquire Parameters | When selected, the acquisition parameters for each test display in the Acquisitions table columns |

**See Also.** [About acquisitions](#)

[Select acquisitions](#)

**Use pre-recorded waveforms for analysis.** Use pre-recorded waveform files to run saved tests or to run a new test using a saved waveform from another test.

[Run a test in pre-recorded mode.](#)

Run a saved test or new test using a pre-recorded waveform file.

1. Open a saved test setup or create a new one.

---

**NOTE.** *If using a saved test and you do not want to overwrite the previous data, save this test setup using the Save As option before proceeding.*

---

2. In the Setup panel, select the **DUT** tab and then select **Use pre-recorded waveform files**. (This selection adds the Waveform FileName column to the Acquisitions table in the Acquisitions tab.)
3. [Change any other DUT parameters](#) as desired.
4. In the Test Selection tab, select the desired test(s).
5. In the Acquisitions tab, locate the row for the desired test. In the Waveform FileName column, click the ellipsis button (⋮) and then select a single waveform file or multiple waveform files.
6. Perform any additional test needed, such as [test configuration](#), and then click **Start**.

**See Also.** [Before you click start](#)

[Pre-Run checklist](#)

[About acquisitions](#)

### Running measurements using pre-recorded waveforms.

1. Go to DUT panel and select the mode to 'Use pre-recorded waveform files'.

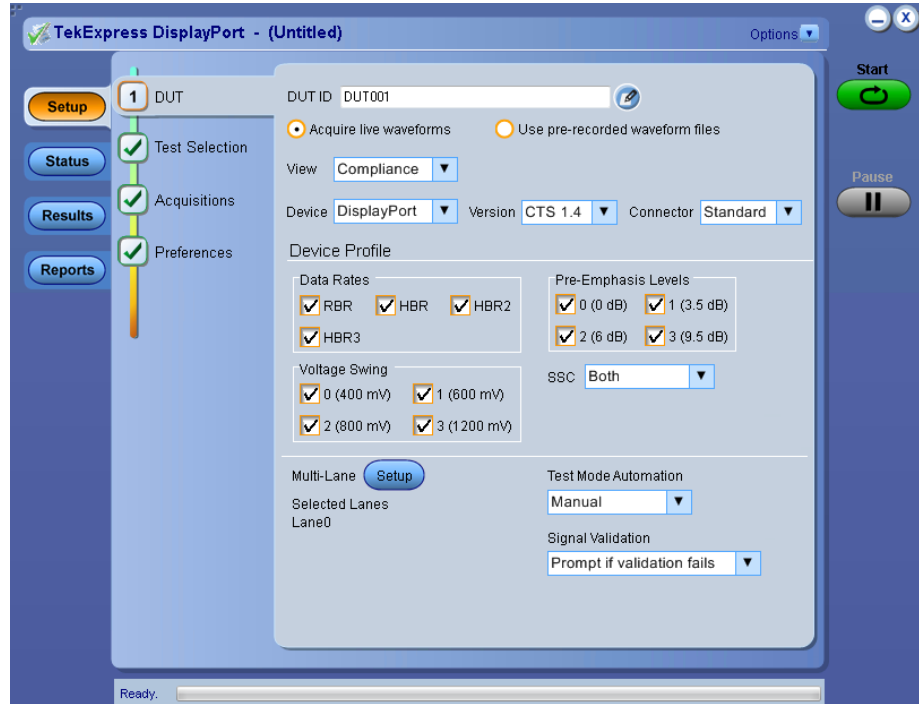

2. Select the DUT settings based on waveforms available for running measurements. Ex: If only SSC waveforms are present then need to select SSC as 'SSC Enable'.
3. Go to Test Selection panel and select desired tests which you want to run using those waveforms.
4. Go to Acquisition panel and make sure all the desired tests are available here.

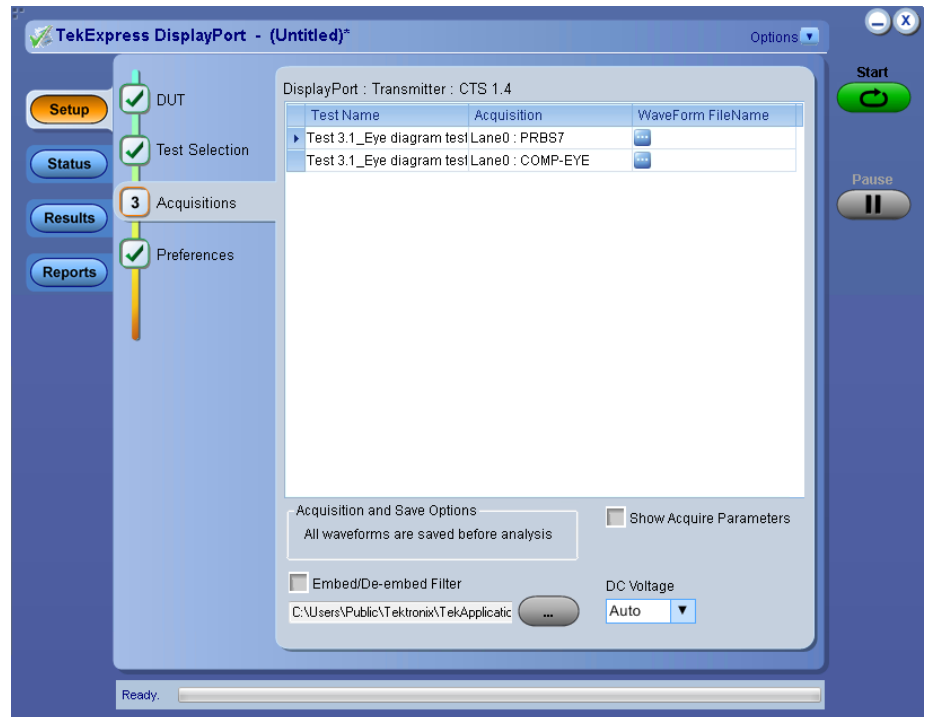

5. Click on the icon present in 'Waveform FileName' column.
6. Make sure all the waveforms you have has proper naming convention. In case of differential signals, waveforms should have naming convention similar to this 'Lane0\_HBR\_D10.2\_SSC\_0dB\_800mV\_20\_50\_diff\_R1' and in case of single ended signals, waveforms should have naming convention similar to this 'Lane0\_RBR\_PRBS7-Single Ended\_SSC\_0dB\_600mV\_20\_50\_SE\_pos\_R1'. Refer to Waveform naming convention.
7. Select all the waveforms required for running test (In order to understand what all waveforms user has to select for running each measurement, load any existing session and switch to pre-recorded mode then go to acquisition panel).

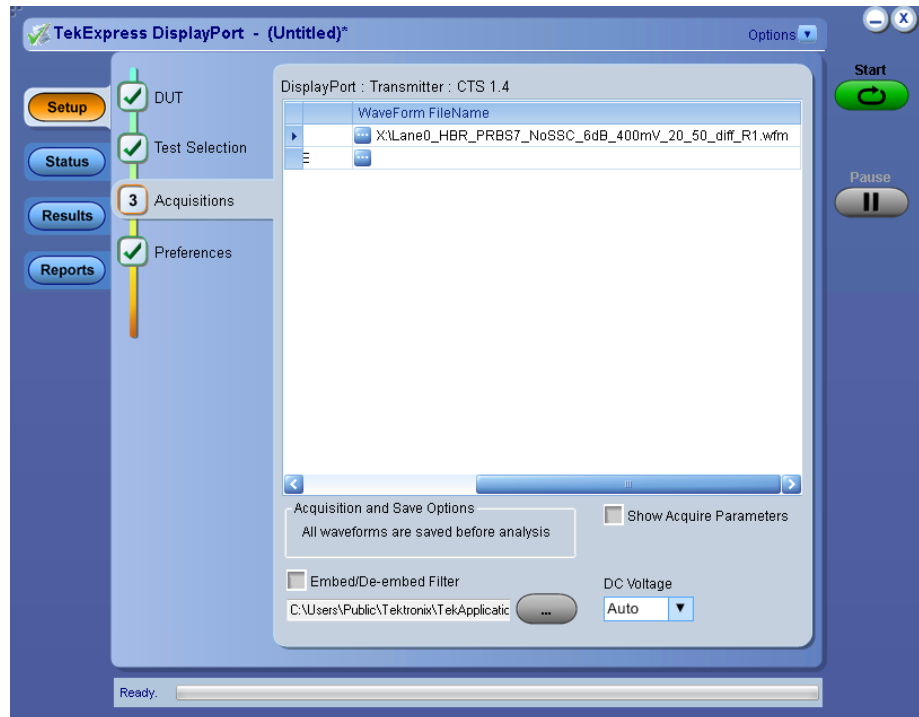

8. Click Start button.
9. If any of the tests has not run completely and report has not generated then please cross check whether you have selected the required DUT parameters in order to run in compliance mode. In this case please select appropriate DUT settings and waveforms then re-run the test.

**Waveforms Naming Convention Diagram**

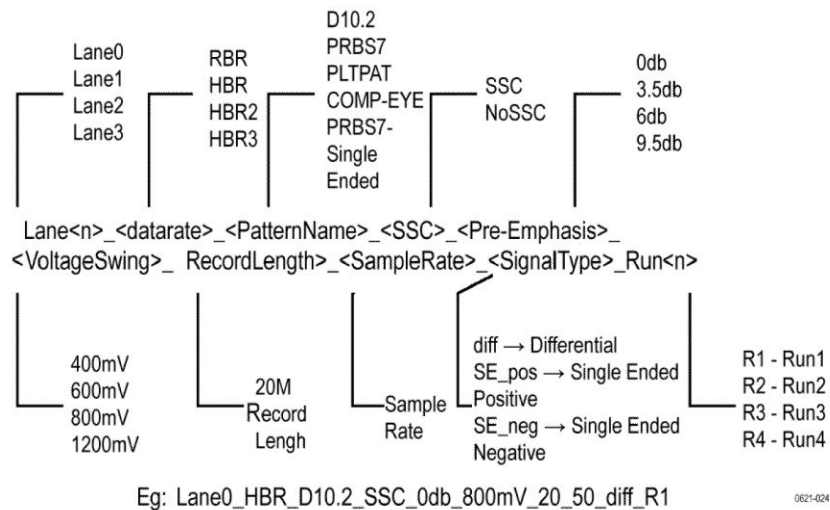

Figure 1: Waveform naming convention

**Acquire live waveforms for analysis.** Use these instructions to set up acquisition for a live waveform.

1. *Open a saved test setup* or *create a new one*.
2. In the Setup panel, select the **DUT** tab, enter the desired DUT ID in the corresponding field and then select **Acquire live waveforms**.
3. *Select other DUT parameters* as desired.
4. In the Test Selection tab, *select the desired test(s)*.
5. In the Acquisitions tab, do any of the following that apply:
  - Select the data sources for the lanes.
  - Select other desired *acquisitions parameters*.
6. *Configure the tests* if you have not done so already, and then click **Start** to run the test.

---

**NOTE.** For DP++ tests, you must select sources for Clock lane and Data lanes. For Aux tests, select sources for AUX lane.

---

**See Also.** [About acquisitions](#)

[Select acquisitions](#)

## Configuring tests

**About configuring tests.** Use configuration settings to view and edit the analysis parameters for selected tests.

The Configuration tab shows Global parameters and Measurement parameters. Global parameters are common for all tests. Measurement parameters are specific to the test selected in the tree view section of the configuration settings. Test-specific parameters can include acquisition, analysis, and limit parameters, and certain oscilloscope settings. Whether you can configure settings depends on which mode you selected, Compliance or User Defined. For more information, see [About setting up tests](#).

---

**NOTE.** If you selected the Compliance View in the DUT tab, you will access test configuration settings using the Configure button in the Test Selection tab. If you selected Advanced View in the DUT tab, access test configuration settings from the Configuration tab in the Setup panel.

---

**See Also.** [Configure tests](#)

[About running tests](#)

**Configure tab parameters.** Use these instructions for configuring tests.

1. Do one of the following:

- If you had selected Compliance View in the DUT tab, then in the Test Selection tab, select the desired test in the list and then click **Configure**.

---

**NOTE.** *To return to test selection from the configuration section, click the Test Selection button.*

---

- If you selected Advanced View, click the **Configuration** tab in the Setup panel.

---

**NOTE.** *You cannot change test parameters that are grayed out.*

---

2. Modify *parameter settings* as desired:

- To use Compliance Mode values, select **Compliance Mode**.

---

**NOTE.** *You cannot change test parameters in Compliance mode, but you can view the selected parameter settings.*

---

- To select the instrument for testing, click **Global Settings**. In the Instruments Detected section, click the drop-down arrow and then select the desired instrument from the list. If you do not see the desired instrument in the list, *refresh the list*.

**See Also.** *Select analysis and test notification preferences*

*Before you click start*

*About setting up tests*



**Common test parameters and values.** The following table lists the measurement parameters common to most tests.

**Table 11: Common parameters and values**

| Parameter type                        | Parameter and default value  |                       |           |                      |            |              |            |                              |                 |     |     |                      |      |  |                     |                       |     |                      |     |  |                     |                       |     |                      |     |                                       |                 |                       |     |                      |     |  |                 |                       |     |                      |     |  |                 |                       |     |                      |     |  |                     |                       |     |                      |     |                                      |                 |     |     |                      |      |  |                    |                       |      |     |     |
|---------------------------------------|--|-----------------------|-----------|----------------------|------------|--------------|------------|------------------------------|-----------------|-----|-----|----------------------|------|--|---------------------|-----------------------|-----|----------------------|-----|--|---------------------|-----------------------|-----|----------------------|-----|---------------------------------------|-----------------|-----------------------|-----|----------------------|-----|--|-----------------|-----------------------|-----|----------------------|-----|--|-----------------|-----------------------|-----|----------------------|-----|--|---------------------|-----------------------|-----|----------------------|-----|--------------------------------------|-----------------|-----|-----|----------------------|------|--|--------------------|-----------------------|------|-----|-----|
| Mode                                  | <p>Determines whether test parameters are in compliance or can be edited</p> <ul style="list-style-type: none"> <li>Compliance: Most test parameter values cannot be edited.</li> <li>User Defined: Most test parameter values can be edited.</li> </ul>   |                       |           |                      |            |              |            |                              |                 |     |     |                      |      |  |                     |                       |     |                      |     |  |                     |                       |     |                      |     |                                       |                 |                       |     |                      |     |  |                 |                       |     |                      |     |  |                 |                       |     |                      |     |  |                     |                       |     |                      |     |                                      |                 |     |     |                      |      |  |                    |                       |      |     |     |
| Global Settings                       | <p>These settings apply to all tests selected for the current session.</p> <ul style="list-style-type: none"> <li>Real Time Scope: Specifies the oscilloscope used for tests.</li> </ul>   |                       |           |                      |            |              |            |                              |                 |     |     |                      |      |  |                     |                       |     |                      |     |  |                     |                       |     |                      |     |                                       |                 |                       |     |                      |     |  |                 |                       |     |                      |     |  |                 |                       |     |                      |     |  |                     |                       |     |                      |     |                                      |                 |     |     |                      |      |  |                    |                       |      |     |     |
| Measurements                          | Shows the parameter settings for the test selected in the tree view section.   |                       |           |                      |            |              |            |                              |                 |     |     |                      |      |  |                     |                       |     |                      |     |  |                     |                       |     |                      |     |                                       |                 |                       |     |                      |     |  |                 |                       |     |                      |     |  |                 |                       |     |                      |     |  |                     |                       |     |                      |     |                                      |                 |     |     |                      |      |  |                    |                       |      |     |     |
| Limits                                | <p>Shows the upper and lower limits for the applicable measurement using different types of comparisons. In Compliance Mode, allows you to view the measurement high and low limits used for the test selected in the tree view of the Measurements tab. When running tests in User Defined Mode, you can edit the limit settings in the Limits Editor.</p>  <p>The screenshot shows a 'Limits Editor' window with a table of measurement limits. The table has columns for Test Name, Display, Compare High, Low Limit, Compare High, and High Limit. The data is as follows:</p> <table border="1"> <thead> <tr> <th>Test Name</th> <th>Display</th> <th>Compare High</th> <th>Low Limit</th> <th>Compare High</th> <th>High Limit</th> </tr> </thead> <tbody> <tr> <td>Test 1_1, An-diagram loading</td> <td>HR12.5:HR12.5:0</td> <td>N/A</td> <td>N/A</td> <td>&lt;= Less Than Or E...</td> <td>0.50</td> </tr> <tr> <td></td> <td>1000m to 4000m (dB)</td> <td>&gt;= Greater Than Or...</td> <td>0.0</td> <td>&lt;= Less Than Or E...</td> <td>0.0</td> </tr> <tr> <td></td> <td>1000m to 4000m (dB)</td> <td>&gt;= Greater Than Or...</td> <td>0.1</td> <td>&lt;= Less Than Or E...</td> <td>0.1</td> </tr> <tr> <td>Test 1_2, You-Pipe-Complex Level test</td> <td>HR12.5:HR12.5:0</td> <td>&gt;= Greater Than Or...</td> <td>0.2</td> <td>&lt;= Less Than Or E...</td> <td>0.9</td> </tr> <tr> <td></td> <td>HR12.5:HR12.5:0</td> <td>&gt;= Greater Than Or...</td> <td>0.0</td> <td>&lt;= Less Than Or E...</td> <td>0.0</td> </tr> <tr> <td></td> <td>HR12.5:HR12.5:0</td> <td>&gt;= Greater Than Or...</td> <td>0.0</td> <td>&lt;= Less Than Or E...</td> <td>0.4</td> </tr> <tr> <td></td> <td>1000m to 4000m (...</td> <td>&gt;= Greater Than Or...</td> <td>0.0</td> <td>&lt;= Less Than Or E...</td> <td>0.0</td> </tr> <tr> <td>Test 1_3, You-Complex Level Test (A)</td> <td>HR12.5:HR12.5:0</td> <td>N/A</td> <td>N/A</td> <td>&lt;= Less Than Or E...</td> <td>0.05</td> </tr> <tr> <td></td> <td>&lt;= Less Than Or...</td> <td>&gt;= Greater Than Or...</td> <td>0.05</td> <td>N/A</td> <td>N/A</td> </tr> </tbody> </table> | Test Name             | Display   | Compare High         | Low Limit  | Compare High | High Limit | Test 1_1, An-diagram loading | HR12.5:HR12.5:0 | N/A | N/A | <= Less Than Or E... | 0.50 |  | 1000m to 4000m (dB) | >= Greater Than Or... | 0.0 | <= Less Than Or E... | 0.0 |  | 1000m to 4000m (dB) | >= Greater Than Or... | 0.1 | <= Less Than Or E... | 0.1 | Test 1_2, You-Pipe-Complex Level test | HR12.5:HR12.5:0 | >= Greater Than Or... | 0.2 | <= Less Than Or E... | 0.9 |  | HR12.5:HR12.5:0 | >= Greater Than Or... | 0.0 | <= Less Than Or E... | 0.0 |  | HR12.5:HR12.5:0 | >= Greater Than Or... | 0.0 | <= Less Than Or E... | 0.4 |  | 1000m to 4000m (... | >= Greater Than Or... | 0.0 | <= Less Than Or E... | 0.0 | Test 1_3, You-Complex Level Test (A) | HR12.5:HR12.5:0 | N/A | N/A | <= Less Than Or E... | 0.05 |  | <= Less Than Or... | >= Greater Than Or... | 0.05 | N/A | N/A |
| Test Name                             | Display  | Compare High          | Low Limit | Compare High         | High Limit |              |            |                              |                 |     |     |                      |      |  |                     |                       |     |                      |     |  |                     |                       |     |                      |     |                                       |                 |                       |     |                      |     |  |                 |                       |     |                      |     |  |                 |                       |     |                      |     |  |                     |                       |     |                      |     |                                      |                 |     |     |                      |      |  |                    |                       |      |     |     |
| Test 1_1, An-diagram loading          | HR12.5:HR12.5:0  | N/A                   | N/A       | <= Less Than Or E... | 0.50       |              |            |                              |                 |     |     |                      |      |  |                     |                       |     |                      |     |  |                     |                       |     |                      |     |                                       |                 |                       |     |                      |     |  |                 |                       |     |                      |     |  |                 |                       |     |                      |     |  |                     |                       |     |                      |     |                                      |                 |     |     |                      |      |  |                    |                       |      |     |     |
|                                       | 1000m to 4000m (dB)  | >= Greater Than Or... | 0.0       | <= Less Than Or E... | 0.0        |              |            |                              |                 |     |     |                      |      |  |                     |                       |     |                      |     |  |                     |                       |     |                      |     |                                       |                 |                       |     |                      |     |  |                 |                       |     |                      |     |  |                 |                       |     |                      |     |  |                     |                       |     |                      |     |                                      |                 |     |     |                      |      |  |                    |                       |      |     |     |
|                                       | 1000m to 4000m (dB)  | >= Greater Than Or... | 0.1       | <= Less Than Or E... | 0.1        |              |            |                              |                 |     |     |                      |      |  |                     |                       |     |                      |     |  |                     |                       |     |                      |     |                                       |                 |                       |     |                      |     |  |                 |                       |     |                      |     |  |                 |                       |     |                      |     |  |                     |                       |     |                      |     |                                      |                 |     |     |                      |      |  |                    |                       |      |     |     |
| Test 1_2, You-Pipe-Complex Level test | HR12.5:HR12.5:0  | >= Greater Than Or... | 0.2       | <= Less Than Or E... | 0.9        |              |            |                              |                 |     |     |                      |      |  |                     |                       |     |                      |     |  |                     |                       |     |                      |     |                                       |                 |                       |     |                      |     |  |                 |                       |     |                      |     |  |                 |                       |     |                      |     |  |                     |                       |     |                      |     |                                      |                 |     |     |                      |      |  |                    |                       |      |     |     |
|                                       | HR12.5:HR12.5:0  | >= Greater Than Or... | 0.0       | <= Less Than Or E... | 0.0        |              |            |                              |                 |     |     |                      |      |  |                     |                       |     |                      |     |  |                     |                       |     |                      |     |                                       |                 |                       |     |                      |     |  |                 |                       |     |                      |     |  |                 |                       |     |                      |     |  |                     |                       |     |                      |     |                                      |                 |     |     |                      |      |  |                    |                       |      |     |     |
|                                       | HR12.5:HR12.5:0  | >= Greater Than Or... | 0.0       | <= Less Than Or E... | 0.4        |              |            |                              |                 |     |     |                      |      |  |                     |                       |     |                      |     |  |                     |                       |     |                      |     |                                       |                 |                       |     |                      |     |  |                 |                       |     |                      |     |  |                 |                       |     |                      |     |  |                     |                       |     |                      |     |                                      |                 |     |     |                      |      |  |                    |                       |      |     |     |
|                                       | 1000m to 4000m (...  | >= Greater Than Or... | 0.0       | <= Less Than Or E... | 0.0        |              |            |                              |                 |     |     |                      |      |  |                     |                       |     |                      |     |  |                     |                       |     |                      |     |                                       |                 |                       |     |                      |     |  |                 |                       |     |                      |     |  |                 |                       |     |                      |     |  |                     |                       |     |                      |     |                                      |                 |     |     |                      |      |  |                    |                       |      |     |     |
| Test 1_3, You-Complex Level Test (A)  | HR12.5:HR12.5:0  | N/A                   | N/A       | <= Less Than Or E... | 0.05       |              |            |                              |                 |     |     |                      |      |  |                     |                       |     |                      |     |  |                     |                       |     |                      |     |                                       |                 |                       |     |                      |     |  |                 |                       |     |                      |     |  |                 |                       |     |                      |     |  |                     |                       |     |                      |     |                                      |                 |     |     |                      |      |  |                    |                       |      |     |     |
|                                       | <= Less Than Or...   | >= Greater Than Or... | 0.05      | N/A                  | N/A        |              |            |                              |                 |     |     |                      |      |  |                     |                       |     |                      |     |  |                     |                       |     |                      |     |                                       |                 |                       |     |                      |     |  |                 |                       |     |                      |     |  |                 |                       |     |                      |     |  |                     |                       |     |                      |     |                                      |                 |     |     |                      |      |  |                    |                       |      |     |     |

**Figure 2: When running tests in User Defined Mode, the cells in the Limits Editor table are active for editing so you can change parameters.**

**See Also.** [Configure tests](#)

[Select acquisitions](#)

**Configure email settings.** Use the Email Settings utility to get notified by email when a measurement completes, or produces any error condition. Follow the steps to configure email settings:

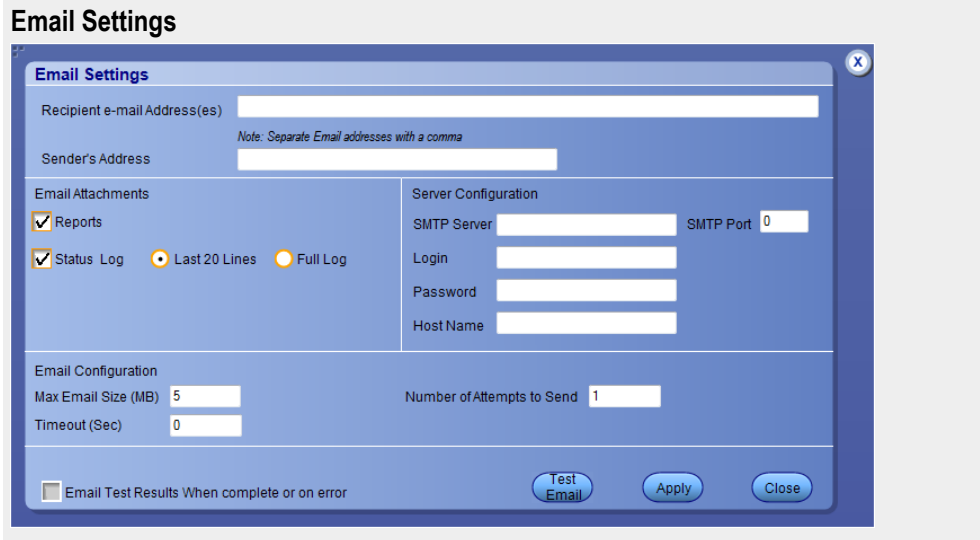

1. From the Options menu, select **Email Settings** to open the Email settings dialog box.
2. (Required) For Recipient email Address(es), enter your email address. To include multiple addresses, separate the addresses with commas.
3. (Required) For Sender's Address, enter the email address used by the instrument. This address consists of the instrument name followed by an underscore followed by the instrument serial number, then the @ symbol and the email server used. For example:  
DPO72004C\_B130099@yourcompany.com.
4. (Required) In the Server Configuration section, type the SMTP Server address of the Mail server configured at the client location, and the SMTP Port number, in the corresponding fields.

If this server requires password authentication, enter a valid login name, password, and host name in the corresponding fields.

---

**NOTE.** *If any of the above required fields are left blank, the settings will not be saved and email notifications will not be sent.*

---

5. In the Email Attachments section, select from the following options:
  - **Reports:** Select to receive the test report with the notification email
  - **Status Log:** Select to receive the test status log with the notification email. If you select this option, then also select whether you want to receive the full log or just the last 20 lines.
6. In the Email Configuration section, select as desired:
  - Select the message file format to send: HTML (the default) or plain text.

- Enter a maximum file size for the email message. Messages with attachments larger than this limit will not be sent. The default is 5 MB.
  - To limit the number of attempts the system makes to send a notification, enter the number in the Number of Attempts to Send field. The default is 1. You can also specify a timeout.
7. Select the **Email Test Results When complete or on error** check box. Use this check box to quickly enable or disable email notifications
  8. To test your email settings, click **Test Email**.
  9. To apply your settings, click **Apply**.
  10. Click **Close** to exit the Email Settings dialog box.

**See Also.** [Configure tests](#)

[Select analysis and test notification preferences](#)

### Set preferences tab parameters

Use the Preferences tab to set the application action on completion of a measurement:

**Table 12: Preferences tab settings**

| Settings   | Description  |
|--|--|
| <b>Number of Runs</b>  |  |
| Acquire/Analyze each test <number> times   | Select to repeat the test run by setting the number of times. By default, it is selected with 1 run. The number of run feature is available only during the live mode. |
| <b>Popup Settings</b>  |  |
| Auto close Warnings and Informations during Sequencing Auto close after <number> Seconds       | Select to auto close warnings/informations during sequencing. Set the Auto close time. By default it is unselected.  |
| Auto close Error Messages during Sequencing. Show in Reports Auto close after <number> Seconds | Select to auto close Error Messages during Sequencing. Set the Auto close time. By default it is unselected.   |

**See Also.** [Select report options](#)

[About setting up tests](#)

**Reports panel** **Select report options.** Click the Reports button and use the Reports panel controls to select which test result information to include in the report, and the naming conventions to use for the report. For example, always give the report a unique name or select to have the same name increment each time you run a particular test.

Select report options before running a test or when creating and saving test setups. Report settings are included in saved test setups.

In the Reports panel, select from the following report options:

1. Select the **Reports** panel.

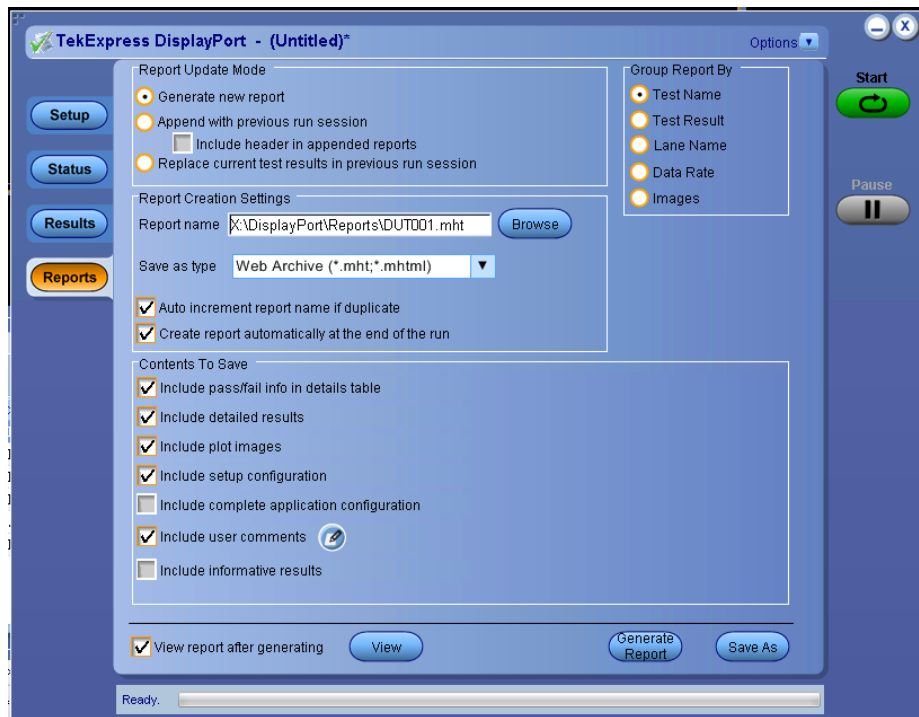

2. Select from the report options. Refer to the following Report Options table for details.

| Setting                                      | Description  |
|--|--|
| <b>Report Update Mode</b>                    |  |
| Generate new report                          | Creates a new report. The report can be in either .mht or .csv or .pdf file formats.   |
| Append with previous run session             | Appends the latest test results to the end of the current test results report.   |
| Include header in appended reports           | Includes header in appended reports.   |
| Replace current test in previous run session | Replaces the previous test results with the latest test results. Results from newly added tests are appended to the end of the report. |

| Setting   | Description  |
|---|--|
| <b>Report Creation Settings</b>                   |  |
| Report name                                       | <p>Displays the name and location from which to open a DisplayPort report. The default location is at \My TekExpress\DisplayPort \Untitled Session. The report file in this folder gets overwritten each time you run a test unless you specify a unique name or select to auto increment the report name.</p> <p>Change the report name or location.</p> <p>Do one of the following:</p> <ul style="list-style-type: none"> <li>■ In the Report Path field, type over the current folder path and name.</li> <li>■ Double-click in the Report Path field and then make selections from the popup keyboard and click the Enter button.</li> </ul> <p>Be sure to include the entire folder path, the file name, and the file extension. For example: C:\Documents and Settings\your user name\My Documents\My TekExpress\DisplayPort \DUT001.mht. This folder (C:\Documents and Settings\<user as="" documents\my="" drive="" in="" is="" mapped="" name&gt;\my="" p="" scope.<="" tekexpress)="" the="" x=""> <p>Open an existing report.</p> <p>Click <b>Browse</b>, locate and select the report file and then click <b>View</b> at the bottom of the panel.</p> </user></p> |
| Save as type                                      | <p>Saves a report in the specified file type, selected from the drop-down list.</p> <p><b>NOTE.</b> If you select a file type different from the default, be sure to change the report file name extension in the Report Name field to match.</p>  |
| Auto increment report name if duplicate           | <p>Sets the application to automatically increment the name of the report file if the application finds a file with the same name as the one being generated. For example: DUT001, DUT002, DUT003. This option is enabled by default.</p>  |
| Create report automatically at the end of the run | <p>Creates report at the end of the run.</p>   |
| <b>Contents To Save</b>                           |  |
| Include pass/fail info in details table           | <p>Includes pass/fail info in the details table of the report.</p>   |
| Include detailed results                          | <p>Includes detailed results in the report.</p>  |
| Include plot images                               | <p>Includes plot images in the report.</p>   |
| Include setup configuration                       | <p>Sets the application to include hardware and software information in the summary box at the top of the report. Information includes: the oscilloscope model and serial number, the oscilloscope firmware version, and software versions for applications used in the measurements.</p>  |
| Include complete application configuration        | <p>Includes complete application configuration in the report.</p>  |

| Setting                      | Description   |
|------------------------------|---|
| Include user comments        | Select to include any comments about the test that you or another user added in the DUT tab of the Setup panel. Comments appear in the Comments section, under the summary box at the beginning of each report. |
| Include Informative Results  | Include or exclude informative results in reports. This needs to be selected before you run the tests for it to get applied.  |
| <b>Group Report By</b>       |   |
| Test Name                    | Groups the tests in the report by test name.  |
| Test Result                  | Groups the tests in the report by test results.   |
| Lane Name                    | It generates report, and all the results in the report will be grouped by lanes.  |
| Data Rate                    | It generates report, and all the results in the report will be grouped by data rates.   |
| View report after generating | Automatically opens the report in a Web browser when the test completes. This option is selected by default.  |
| View                         | Click to view the most current report.  |
| Generate Report              | Generates a new report based on the current analysis results.   |
| Save As                      | Specify a name for the report.  |

**See Also.** [View a report](#)

[About setting up tests](#)

**View a report.** The application automatically generates a report when test analysis is completed and displays the report in your default Web browser (unless you cleared the **View Report After Generating** check box in the Reports panel before running the test). If you cleared this check box, or to view a different test report, do the following:

1. Click the Reports button.
2. Click the Browse button and locate and select the report file to view.
3. In the Reports panel, click View.

For information on changing the file type, file name, and other report options, see Select report options.

**Report contents.** A report shows detailed results and plots, as set in the Reports panel.

## Setup Configuration

| Tektronix TekExpress Automated Test Solution<br>TekExpress DisplayPort |   |                         |                    |
|--|---|-------------------------|--------------------|
| Setup Information  |   |                         |                    |
| DUT ID   | DUT001                                      | Scope Model             | DPO77002SX         |
| Date/Time  | 2016-11-25 09:20:13                         | Scope Serial Number     | B300069            |
| Device Type  | DisplayPort                                 | SPC, FactoryCalibration | PASS,PASS          |
| App Version  | Display Port:10.1.0.56 (Evaluation Version) | Scope F/W Version       | 10.5.0 devBuild 24 |
| TekExpress Version   | Framework:4.2.0.48                          | DPOJET Version          | 10.0.2.1           |
| Execution Mode   | Live  | ProbeCH1 Model          | P7313SMA           |
| Overall Compliance Mode  | Yes   | ProbeCH1 Serial Number  | B010427            |
| OverallResult  | Pass  | ProbeCH2 Model          | P7313SMA           |
| Overall Execution Time   | 6:01:15                                     | ProbeCH2 Serial Number  | B020883            |
| DUT Automation Method  | DPR-100                                     | ProbeCH3 Model          | P7313SMA           |
| Connector  | Standard                                    | ProbeCH3 Serial Number  | B020869            |
| CTS Version  | CTS 1.4                                     | ProbeCH4 Model          | P7313SMA           |
| DPR100 Version   | DP Rev 1.2                                  | ProbeCH4 Serial Number  | B020877            |
| DUT COMMENT:   | General Comment - DisplayPort               |                         |                    |

Setup information is listed in the summary box at the beginning of the report. This information includes the DUT id, date/ time of the report, device type, app version, TekExpress version, execution mode, overall compliance mode, overall test result, overall execution time DUT automation, scope model, scope serial number, SPC factory calibration, and more.

To exclude this information from a report, clear the **Include setup configuration** check box in the Reports tab before running the test. If you selected to include comments in the test report, any comments you added in the DUT tab are shown at the end of the setup information summary.

### DUT comments

If you select to include user comments in the test report, any comments you added in the DUT tab are shown at the end of the report.

## Test Name Summary Table

| Test Name Summary Table  |      |
|--|------|
| Test 3.1_Eye diagram testing   | Pass |
| Test 3.2_Non Pre-Emphasis Level Verification Testing                                 | Pass |
| Test 3.3_Pre-Emphasis Level Verification Testing                                     | Pass |
| Test 3.11_Non ISI Jitter Measurements  | Pass |
| Test 3.12.1_Total Jitter (TJ) Measurements   | Pass |
| Test 3.12.2_Random Jitter (RJ) Measurements  | Pass |
| Test 3.14_Main Link Frequency Compliance   | Pass |
| Test 3.15_Spread Spectrum Modulation Frequency                                       | Pass |
| Test 3.16_Spread Spectrum Modulation Deviation                                       | Pass |
| Total Measurements Executed : 280 : Pass = 265 : Fail = 15 : Skipped = 0 : Error = 0 |      |

The test name summary table indicates whether a test is passed or failed. If the test is passed, the column cell appears is green. If the test is failed, it appears in red. If the test is skipped or has error, it appears in blue. To exclude this information from a report, clear the **Include pass/fail info in details table** check box in the Reports tab before running the test. If Pattern fails and user selects **Skip test if validation fails** then status of that test will be 'Skipped'. In case the user selects 'Reacquire' and it fails to acquire good pattern in 10 attempts then that pattern will be skipped from acquiring. Test status of the test which uses that pattern will be 'Skipped'.

### Details results

Includes detailed measurement information.

| Test 3.1_Eye diagram testing |  |                |       |             |          |           |            |
|------------------------------|--|----------------|-------|-------------|----------|-----------|------------|
| Lane                         | Measurement Details  | Measured Value | Units | Test Result | Margin   | Low Limit | High Limit |
| Lane0                        | MaskHits TP3_EQ1-Zero Length-CTLE-DFE:HBR2 SSC OdB 400mV Run 1 | 0              | Hits  | Pass        | 0.0000   | N.A       | 0          |
| Lane0                        | Width TP3_EQ1-Zero Length-CTLE-DFE:HBR2 SSC OdB 400mV Run 1    | 0.7771         | UI    | Pass        | 0.3571   | 0.42      | N.A        |
| Lane0                        | Height TP3_EQ1-Zero Length-CTLE-DFE:HBR2 SSC OdB 400mV Run 1   | 331.9967       | mV    | Pass        | 227.9967 | 104       | N.A        |
| Lane0                        | MaskHits TP3_EQ1-Worst Case-CTLE-DFE:HBR2 SSC OdB 400mV Run 1  | 15             | Hits  | Fail        | -15.0000 | N.A       | 0          |
| Lane0                        | Width TP3_EQ1-Worst Case-CTLE-DFE:HBR2 SSC OdB 400mV Run 1     | 0.7491         | UI    | Pass        | 0.3291   | 0.42      | N.A        |

To exclude this information from the report, clear the **Include detailed results** check box in the Reports tab.



---

# Running tests and viewing results

## About running tests

After selecting and configuring tests, review the [pre-run checklist](#) and then click **Start** to perform the tests. The application acquires and analyzes the data, then displays a report when the tests are complete.

While the tests are running, other applications may display windows in the background. The TekScope application takes precedence over other applications, but you can switch to other applications using the Alt+Tab key combination. To keep the TekExpress DisplayPort application on top, select **Keep On Top** from the DisplayPort Options menu.

Waveforms generated during the test are automatically saved when you save the related test setup, so you can [run tests in pre-recorded mode](#).

**See Also** [Before you click start](#)  
[About configuring tests](#)  
[About setting up tests](#)

## Before you click start

Before you run tests for the first time, do the following:

1. Understand where your test files are stored on the instrument.

After you install and launch TekExpress DisplayPort, it creates the following folders on the oscilloscope:

- Windows 7: \Program Files\Tektronix\TekExpress\**TekExpress DisplayPortTx**
- \My Documents\My TekExpress\**DisplayPort**
- \My Documents\My TekExpress\DisplayPort\**Untitled Session**

Every time you launch TekExpress DisplayPort, an Untitled Session folder is created in the DisplayPort folder. The Untitled Session folder is automatically deleted when you exit the DisplayPort application.



**CAUTION.**

*Do not modify any of the session files or folders because this may result in lost data or corrupted session files. Each session has multiple files associated with it. When you save a session, a .TekX file, and a folder named for the session and containing the associated files, is created on the oscilloscope X: drive.*

---

2. Map the shared My TekExpress folder as X: (X drive) on all the instruments used in test setups running Microsoft Windows Operating System.

The My TekExpress folder has the share name format <domain><user ID>My TekExpress. Or, if the instrument is not connected to a domain, then the share name format is <instrument name><user ID> My TekExpress. This shared folder is used to save the waveform files and is used during other file transfer operations.

---

**NOTE.** *If the X: drive is mapped to any other shared folder, the application will display a warning message asking you to disconnect the X: drive manually.*

---

3. Make sure that the My TekExpress folder has read and write access, and that the contents are not set to be encrypted:
  - a. Right-click the folder and select **Properties**.
  - b. Select the **General** tab and then click **Advanced**.
  - c. In the Advanced Attributes dialog box, make sure that the option **Encrypt contents to secure data** is NOT selected. Example.

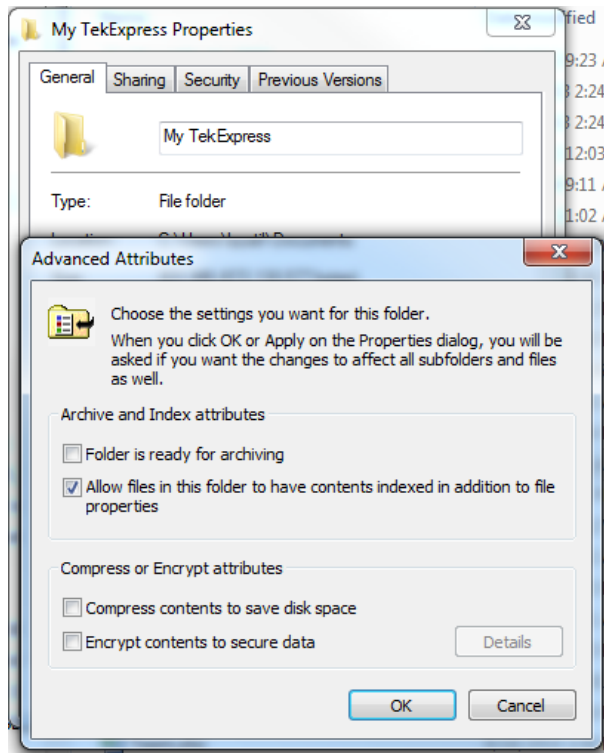

4. See the *pre-run checklist* before you run a test.

**See Also** [View test-related files](#)  
[Application directories and usage](#)  
[File name extensions](#)

## Pre-Run checklist

Do the following before you click Start to run a test. If this is the first time you are running a test on a setup, refer to the information in [Before you click start](#).

1. Make sure that all the required instruments are properly warmed up (approximately 20 minutes).
2. Perform the Signal Path Compensation (SPC).
  - a. On the oscilloscope main menu, select the **Utilities** menu.
  - b. Select **Instrument Calibration**.
3. [Deskew channels](#).
4. Make sure that the application is able to find the oscilloscope. If it cannot, perform a [search for connected instruments](#).
  - a. Launch the DisplayPort application.
  - b. Select the **Setup** panel and then click the **Test Selection** tab.
  - c. Select any test and then click **Configure**.
  - d. In the Configuration section, click **Global Settings**.
  - e. In the Instruments Detected section, click the drop-down arrow to the right of Real Time Scope and make sure that the correct oscilloscope is listed.

See Also [Equipment connection setup](#)

## Run a test in pre-recorded mode

This option allows you to re-run a complete test using just the oscilloscope and the saved test setup files.

---

**NOTE.** *Running the test in pre-recorded mode does not replace the existing saved test results. Instead, if you save the test under the same name, the results are saved in a session folder named for the date and time of the session.*

---

1. [Open the desired saved test setup](#).
2. In the Setup panel, select the **DUT** tab and then select **Use pre-recorded waveform files**.

A Run session field displays, showing the session that ran for this test. If there is more than one session that contains test data (not an empty session folder) these are available in the Run session drop-down list. Select the desired session from the drop-down list.

3. Select the **Acquisitions** tab.
4. In the [Acquisitions table](#), look in the Waveform FileName column.

5. If no waveform files are listed, click the ellipsis button () and then locate and select the desired waveform files. Skip to step 7.
6. If waveform files are listed, verify that the listed files are the ones you want to use. If they are not, or if you want to add a file, do any of the following as needed:
  - To remove a waveform file from the list, click the ellipsis button and select **Remove Waveform File**.
  - To replace a waveform file, click the ellipsis button, select **Replace Waveform File**, then locate and select the desired file.
  - To add a waveform file, click the ellipses button, select **Select Waveform Files**, then locate and select the waveform files.
7. Click **Start** to run the test.

**See Also** [Before you click start](#)  
[About acquisitions](#)

## View the progress of analysis

The *Status panel* displays a record of the test as it executes. By default, the application switches to this panel after you click the Start button. Choose from the following two views by selecting the named tab, even while a test is in progress.

### *Test Status*

The Test Status tab presents a collapsible/expandable table with information about each test as it is running.

**Table 13: Status tab table**

| Column          | Description  |
|-----------------|--|
| Test Name       | Name of the test   |
| Acquisition     | The type of pattern data being acquired  |
| Acquire Status  | Progress state of the acquisition: <ul style="list-style-type: none"> <li>■ To be started</li> <li>■ In progress</li> <li>■ Completed</li> <li>■ N.A.</li> </ul> |
| Analysis Status | Progress state of the analysis: <ul style="list-style-type: none"> <li>■ To be started</li> <li>■ In progress</li> <li>■ Completed</li> </ul>                    |

**Log View**

The Log View tab provides a list of actions that happen as the test executes. Use this tab to monitor, review, or troubleshoot tests.

**Table 14: Log View options**

| Item            | Description   |
|-----------------|---|
| Message History | This window timestamps and displays all run messages.   |
| Auto Scroll     | Select this check box to have the program automatically scroll down as information is added to the log during test execution.                             |
| Clear Log       | Click this button to clear all messages in the Message History window.  |
| Save            | Use to save the log file as a text file for examination. Displays a standard Save File window and saves the status messages in the file that you specify. |

**See Also** [View test results](#)

## View test results

When a test completes, the application switches to the [Results panel](#), which shows a summary of test results.

Each test result occupies a row in the Results table. By default, results are displayed in summary format, with the measurement details collapsed. You can change the view in the following ways:

- To view the results grouped by lane, test, or data rate, select the corresponding item from the Preferences menu.
- To expand all tests listed, select **View Results Details** from the Preferences menu.
- To expand and collapse tests, use the plus and minus buttons to the left of the test rows.
- To collapse all expanded tests, select **Preferences > View Results Summary**.
- To enable or disable the wordwrap feature, select **Preferences > Enable Wordwrap**.
- To expand the width of a column, place the cursor over the vertical line that separates the column from the one to the right. When the cursor changes to a double-ended arrow, hold down the mouse button and drag the column to the desired width.
- To sort the test information by column, click the column head. When sorted in ascending order, a small up arrow is displayed. When sorted in descending order, a small down arrow is displayed.
- To clear all test results displayed, click **Clear** ()

**See Also** [View a report](#)  
[View the progress of analysis](#)

## View a report

After the analysis, a report is automatically generated. By default, the report is displayed in your Web browser unless you cleared the **View Report After Generating** check box in the Reports panel before running the test. If you cleared this check box, or you if want to view a different test report, then do the following:

1. In the Reports panel, click the **Browse** button to the right of the Report Name field and locate the desired report.

The path to the report displays in the Report Name field.

2. At the bottom of the Reports panel, click **View**.

For information on changing the file type, file name, and other report options, see [Select report options](#).

### Report Contents

In the report, a table shows the test name, measurement details, test result (pass/fail), mode, and analysis time.

#### Setup configuration information

Setup configuration information is listed in the summary box at the beginning of the report. This information includes the oscilloscope model and serial number, probe model and serial number, software versions, and more. To exclude this information from a report, clear the **Include Setup Configuration** check box in the Reports tab before running the test. If you selected to include comments in the test report, any comments you added in the DUT tab are shown at the end of the setup information summary.

|  <b>TekExpress Automated Test Solution</b><br>TekExpress DisplayPort |  |                        |                 |
|---|--|------------------------|-----------------|
| <b>Setup Information</b>  |  |                        |                 |
| DUT ID  | DUT001                                       | Scope Model            | DSA72504D       |
| Date/Time   | 2016-11-20 23:05:14                          | Scope Serial Number    | Q200020         |
| Device Type   | DisplayPort                                  | SPC_FactoryCalibration | PASS;PASS;""    |
| App Version   | Display Port: 10.1.0.51 (Evaluation Version) | Scope F/W Version      | 10.3.3 Build 29 |
| TekExpress Version  | Framework: 4.1.1.2                           | DPOJET Version         | 10.0.0.35       |
| Execution Mode  | Live   | ProbeCH1 Model         | 1X              |
| Overall Compliance Mode   | Yes  | ProbeCH1 Serial Number | N/A             |
| OverallResult   | Pass   | ProbeCH2 Model         | TCA292D         |
| Overall Execution Time  | 4:02:53                                      | ProbeCH2 Serial Number | N/A             |
| DUT Automation Method   | DPR-100                                      | ProbeCH3 Model         | N/A             |
| Connector   | Standard                                     | ProbeCH3 Serial Number | N/A             |
| CTS Version   | CTS 1.2                                      | ProbeCH4 Model         | N/A             |
| DPR100 Version  | DP Rev 1.2                                   | ProbeCH4 Serial Number | N/A             |
| DUT COMMENT:  | General Comment - DisplayPort                |                        |                 |

#### Pass/Fail summary

The Pass/Fail Summary column indicates whether a test passed or failed. If the test passed, the column cell is green. If the test failed, it is red. To exclude this information from a report, clear the **Include Pass/Fail Results Summary** check box in the Reports tab before running the test.

#### Detailed results

Includes detailed measurement information.



To exclude this information from the report, clear the **Include Detailed Results** check box in the Reports tab.

### Plot images

Plot images are screen shots captured from the oscilloscope during test execution. They show waveform and measurement data.

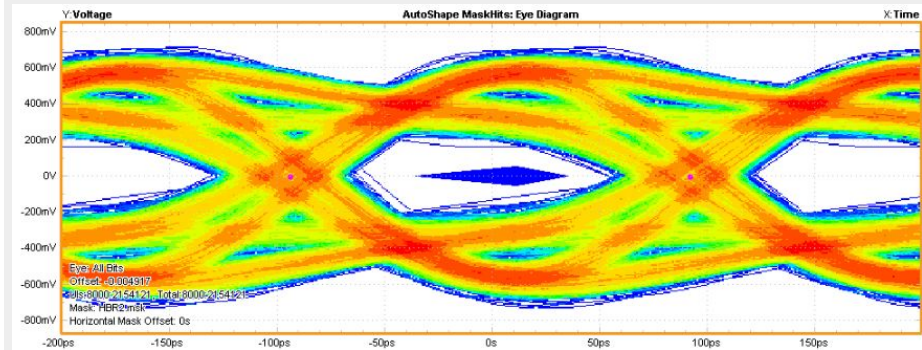

To exclude plot images from a report, clear the **Include Plot Images** check box before running a test.

### Application configuration

This table lists general, common, and acquired parameters used in the test. General parameters are those selected to be included in all tests (where applicable). General parameters, are set in the DUT tab. Acquire parameters are those that were actually used for the acquired pattern during the test. To exclude this information from a report, clear the **Include Complete Application Configuration** check box before running a test.

**See Also**    [View test results](#)  
                   [View test-related files](#)

## View test-related files

Files related to tests are stored in the DisplayPort folder under the My TekExpress shared folder. In the DisplayPort folder, each test setup has a test setup file and a test setup folder, both with the test setup name. The test setup file is preceded by the DisplayPort icon and usually has no visible file extension. For example,  Eye\_PRBS-HBR2 .

Inside the test setup folder is another folder named for the DUT ID used in the test sessions. In the example below, the test setup folder is Eye\_PRBS-HBR2 and the DUT is DUT001:

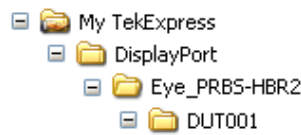

Inside the DUT001 folder are the session folders and files. Each session has a folder and file pair, both named for the test session using the naming convention (date)\_(time). Each session file is stored outside its matching session folder.

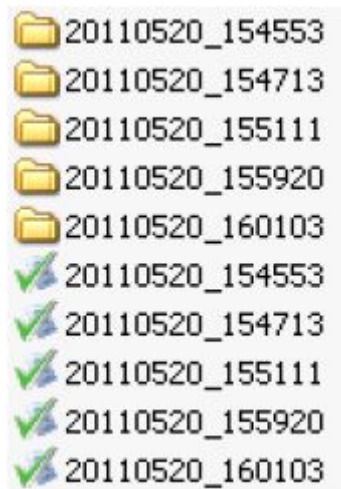

Each session folder contains image files of any plots generated from running the test session, and any waveform files if pre-recorded waveform files were used during the session.

The first time you run a new, unsaved session, the session files are stored in the Untitled Session folder located at ..\My TekExpress\DisplayPort. Once you name and save the session, the Untitled Session folder name is changed to the one you specified.

---

**NOTE.** By default, test report files are saved in the session folder. You can [change where the report file is saved](#) for a specific test session.

---

**See Also**    [File name extensions](#)  
[Before you click start](#)



# Algorithms

## About algorithms

This section describes the measurement algorithms used in the TekExpress DisplayPort application.

### Oscilloscope Setup Guidelines

Before performing any measurements, perform the following steps to ensure accurate measurement results:

- Allow at least 20 minutes warm-up time for oscilloscope.
- Run the oscilloscope SPC calibration routine. Remove all probes from the oscilloscope before running SPC.
- If using probes, perform the probe calibration defined for the specific probes being used.
- Perform deskew to compensate for skew between measurement channels.

### Measurement details

| Measurement Name   | Description   |
|--|---|
| 3.1 : Eye diagram(Normative)   | This test evaluates the timing and amplitude support the overall DisplayPort system objective of Bit Error Rate in data transmission. Eye diagram is plotted to evaluate the timing and amplitude parameters.   |
| 3.2: Non Pre-Emphasis Level Verification Testing(Normative)                                    | This test is performed to ensure that the system budget is followed and ensures that the level settings are monotonic in nature. Monotonicity helps the Sink can rely on the Source to incrementally increase upon by the sink.   |
| 3.3: Pre-Emphasis Level Verification and Maximum Pk-Pk Differential voltage setting(Normative) | This test measures the pre-emphasis of the Source waveform. This is done by measuring the peak to peak differential amplitude. Comparisons are made for the Level 0 transition state as well as non-transition levels. Maximum peak to peak amplitude is also measured. |
| 3.4: Inter-Pair Skew Test(Normative)   | This test measures the skew/time delay between the differential data lanes.   |
| 3.5: Intra-Pair Skew Test (Informative)  | This test measure the skew/time delay between respective sides of a differential data lane.   |
| 3.10: AC Common Mode Noise (Informative)   | This test evaluates the AC Common mode noise (unfiltered RMS) of the differential data line.  |
| 3.11: Non ISI Jitter Measurements (Normative)  | This test evaluates the amount of Non-ISI jitter accompanying the data transmission.  |

| Measurement Name  | Description   |
|---|---|
| 3.12: Total Jitter and Random Jitter(RJ/DJ) Measurement (Normative) | This test evaluates the total jitter at $10^{-9}$ . This can be measured explicitly at this rate or through an approved estimation technique. |
| 3.14: Main Link Frequency Compliance(Normative)                     | This test ensures that the average data rate under all conditions does not exceed minimum or maximum as set by the standard.                  |
| 3.15: Spread Spectrum Modulation Frequency (Normative)              | This test evaluates the frequency of the SSC modulation.  |
| 3.16: Spread Spectrum Modulation (Normative)                        | This test evaluates the range of the SSC down-spreading of the transmitter signal.  |
| 3.17: dF/dt Spread Spectrum Deviation HF Variation (Informative)    | This test verifies whethr the SSC profile does not include any frequency deviation which would exceed 1250ppm/uSec.                           |
| 3.18: Dual Mode TMDS Clock (Normative if supported)                 | This test finds the duty cycle of the TMDS clock waveform of a source operating in Dual Mode.   |
| 3.19: Dual-mode EYE diagram (Normative if supported)                | This test performs the eye diagram measurement and find the timing variables and amplitude trajectories for a dual mode source device.        |

See Also [Before You Click Start](#)

### 3.1 Eye diagram testing (Normative)

This test evaluates the waveform, ensuring that the amplitude trajectories and timing variations of the waveform support the overall DP system objectives of Bit Error Rate in Data transmission.

**Measurement Details** This measurement is performed for the below test conditions:

|                      |                 |                 |                   |                    |                    |
|----------------------|-----------------|-----------------|-------------------|--------------------|--------------------|
| <b>Data Rate</b>     | RBR (Normative) | HBR (Normative) | HBR (Informative) | HBR2 (Informative) | HBR3 (Informative) |
| <b>Test Point</b>    | TP2             | TP2             | TP3_EQ            | TP3_EQ             | TP3_EQ             |
| <b>Pattern</b>       | PRBS7           | PRBS7           | PRBS7             | CP2520             | TPS4               |
| <b>Voltage Swing</b> | Level 2         | Level 2         | Level 2           | Any passing        | Any passing        |
| <b>Pre-Emphasis</b>  | Level 0         | Level 0         | Level 0           | Any passing        | Any passing        |

|                           |                             |                             |                             |                             |                             |
|---------------------------|-----------------------------|-----------------------------|-----------------------------|-----------------------------|-----------------------------|
| <b>SSC</b>                | SSC Enabled<br>SSC Disabled | SSC Enabled<br>SSC Disabled | SSC Enabled<br>SSC Disabled | SSC Enabled<br>SSC Disabled | SSC Enabled<br>SSC Disabled |
| <b>Lanes to be tested</b> | All lanes supported         | All lanes supported         | All lanes supported         | All lanes supported         | All lanes supported         |

- To get TP3\_EQ, waveform is captured at TP2 and Cable emulator applied in SW.
- The eye diagram test should pass both ‘worst case cable’ and a ‘zero length cable’ model.

### Measurement

- Perform the vertical settings such that the waveform occupies 8 divisions.
- Capture 1M Unit Intervals.
- Use the below clock recovery:

| Data Rate        | RBR                   | HBR                   | HBR2                  | HBR3                  |
|------------------|-----------------------|-----------------------|-----------------------|-----------------------|
| <b>PLL Type</b>  | 2 <sup>nd</sup> Order | 2 <sup>nd</sup> Order | 2 <sup>nd</sup> Order | 2 <sup>nd</sup> Order |
| <b>Bandwidth</b> | 5.4 MHz               | 10 MHz                | 10 MHz                | 12 MHz                |
| <b>Damping</b>   | 1.51                  | 1.51                  | 1.0                   | 1.0                   |

- To achieve the worst case cable model (wherever applicable), capture the signal at TP2 and apply the worst case cable emulator using the MATH subsystem in the oscilloscope.
- To achieve the ‘zero length cable’, capture the signal at TP2 and do not embed any cable model.
- For HBR and HBR2 data rate needs Equalization. For each of the acquisitions above, the Analyzer applies a CTLE (Continuous Time Linear Equalization) Transfer Function as defined in VESA specification.
- For HBR3 Data rate needs Equalization. For each of the acquisitions above, the Analyzer applies a CTLE (Continuous Time Linear Equalization) Transfer Function cascaded with a one-tap Decision Feedback Equalizer (DFE) as defined in VESA specification using Tektronix SDLA (Serial Data Link Analysis) software.
- Plot the Eye Diagram. The rendered Eye shall have no signal trajectories entering the mask area as defined in VESA specification.

### 3.2 Non Pre-Emphasis level verification testing (Normative)

This measurement ensures that the system budget is followed and the level settings are monotonic in nature. Monotonicity helps the Sink can rely on the Source to incrementally increase upon by the sink.

#### Measurement Details

This measurement is performed in the following test conditions:

|                           |                           |                           |                           |                           |
|---------------------------|---------------------------|---------------------------|---------------------------|---------------------------|
| <b>Data Rate</b>          | RBR (Normative)           | HBR (Normative)           | HBR2 (Informative)        | HBR3 (Informative)        |
| <b>Test Point</b>         | TP2                       | TP2                       | TP2                       | TP2                       |
| <b>Pattern</b>            | PRBS7                     | PRBS7                     | PLTPAT                    | PLTPAT                    |
| <b>Voltage Swing</b>      | All Nominal Voltage Swing | All Nominal Voltage Swing | All Nominal Voltage Swing | All Nominal Voltage Swing |
| <b>Pre-Emphasis</b>       | Level0                    | Level0                    | Level0                    | Level0                    |
| <b>SSC</b>                | SSC Enabled, SSC Disabled | SSC Enabled, SSC Disabled | SSC Enabled, SSC Disabled | SSC Enabled, SSC Disabled |
| <b>Lanes to be tested</b> | All lanes supported       | All lanes supported       | All lanes supported       | All lanes supported       |

HBR2 and HBR3 - PLTPAT (PreEmphasis Level Test Pattern) is an 80Bit custom pattern.

```
1111100000 1111100000 1111100000 1111100000
1111100000 1111100000 1111100000 1111100000
```

#### Measurement

- This measurement is a ratio between two voltage peak readings each taken at a different nominal level settings with 0dB pre-emphasis setting.
- For each of the voltage peak to peak measurement do the following:
  - Perform the vertical settings such that the waveform occupies 8 divisions.
  - Do the horizontal settings such that oscilloscope can capture more than 1000 qualifying patterns.

$$\text{VoltagePeak\_Peak} = \text{VH\_NPattern} - \text{VL\_Pattern} , \text{ where}$$

VH\_NPattern : is the average of High differential voltage of the qualifying pattern.

VL\_Pattern : is the average of Low differential voltage of the qualifying pattern.

- Qualifying pattern for RBR and HBR

1-0-1-0-1-1-1-1-1-1-1 for the VH measurement

1-0-1-0-0-0-0-1 for the VL measurement

VH is the average of the High or ‘one’ voltage over three UI ending at the 50% point of the 6th bit of the seven successive transmitted ones of the pattern.



VL is the average of the Low or ‘zero’ voltage over two UI ending at the 50% point of the 4th bit of the four successive transmitted 0’s of the pattern.

- Qualifying pattern for HBR2

1-1-1-1-1-0-0-0-0 repeating for the VH and VL measurement

VH is the average of the High or ‘one’ voltage over three UI ending at the 50% point of the 5th bit of the five successive transmitted ones of the pattern.

VL is the average of the Low or ‘zero’ voltage over two UI ending at the 50% point of the 5th bit of the five successive transmitted 0’s of the pattern.

- For each level setting tested use the below equation.

$$\text{Result} = 20 * \text{Log}_{10}[\text{VoltagePeak-Peak\_Level A} / \text{VoltagePeak-Peak\_Level B}]$$

| Measurement | RBR and HBR       |                   | HBR2              |                   | HBR23             |                   |
|-------------|-------------------|-------------------|-------------------|-------------------|-------------------|-------------------|
|             | Veak-Peak_Level A | Veak-Peak_Level B | Veak-Peak_Level A | Veak-Peak_Level B | Veak-Peak_Level A | Veak-Peak_Level B |
| 1           | Level1            | Level0            | Level2            | Level0            | Level2            | Level0            |
| 2           | Level2            | Level1            | Level2            | Level1            | Level2            | Level1            |
| 3           | Level3            | Level2            | Level3            | Level2            | Level3            | Level2            |

- Measurement 3 is optional (test it if the device supports it)
- All the measurements are done at Nominal PreEmphasis level of 0dB
- Compare the result with the limits specified in the VESA specification.

### 3.3 Pre-Emphasis level verification testing and Maximum peak-to-peak differential voltage testing (Normative)

This test evaluates the pre-emphasis of the Source waveform. This is done by measuring the peak to peak differential amplitude. Comparisons are made for the Level 0 transition state as well as non-transition levels. Maximum peak to peak amplitude is also measured.

#### Measurement Details

This measurement is performed in the following test conditions:

|                           |                           |                           |                           |                           |
|---------------------------|---------------------------|---------------------------|---------------------------|---------------------------|
| <b>Data Rate</b>          | RBR (Normative)           | HBR (Normative)           | HBR2 (Informative)        | HBR3 (Informative)        |
| <b>Test Point</b>         | TP2                       | TP2                       | TP2                       | TP2                       |
| <b>Pattern</b>            | PRBS7                     | PRBS7                     | PLTPAT                    | PLTPAT                    |
| <b>Voltage Swing</b>      | All Nominal Voltage Swing | All Nominal Voltage Swing | All Nominal Voltage Swing | All Nominal Voltage Swing |
| <b>Pre-Emphasis</b>       | Level 0                   | Level 0                   | Level 0                   | Level 0                   |
| <b>SSC</b>                | SSC Enabled, SSC Disabled | SSC Enabled, SSC Disabled | SSC Enabled, SSC Disabled | SSC Enabled, SSC Disabled |
| <b>Lanes to be tested</b> | All lanes supported       | All lanes supported       | All lanes supported       | All lanes supported       |

- HBR2 - PLTPAT (PreEmphasis Level Test Pattern) is an 80Bit custom pattern.

1111100000 1111100000 1111100000 1111100000

1111100000 1111100000 1111100000 1111100000

- Constraint for Pre-Emphasis level values

| Voltage swing level | Vdiff_pre_pp support, by Pre-emphasis Level |                    |                    |                  |
|---------------------|---|--------------------|--------------------|------------------|
|                     | 0   | 1                  | 2                  | 3                |
| 0                   | Shall be supported                          | Shall be supported | Shall be supported | May be supported |
| 1                   | Shall be supported                          | Shall be supported | Shall be supported | Not allowed      |
| 2                   | Shall be supported                          | Shall be supported | Not allowed        | Not allowed      |
| 3                   | May be supported                            | Not allowed        | Not allowed        | Not allowed      |

- Measurement**
- Perform the vertical settings such that the waveform occupies 8 divisions.
  - Do the horizontal settings such that oscilloscope can capture more than 1000 qualifying patterns.
  - Transition and non-transition voltage swings are measured for each supported level and pre-emphasis setting. Each transition and non-transition swing is composed of High and Low voltage measurements which are combined to obtain the peak to peak voltage. Non-Transition voltage measurement is performed as per '3.2: Non Pre-Emphasis Level Verification Testing'.
  - For a given voltage level and pre-emphasis level, below are the peak to peak voltage definitions.

$$VT\_LvIX\_PP = VT\_LvIX\_H - VT\_LvIX\_L$$

$$VN\_LvIX\_PP = VN\_LvIX\_H - VN\_X\_LvIX\_L, \text{ where}$$

- $VT\_LvIX\_PP$  : Peak to peak voltage at the transition bit.
- $VN\_LvIX\_PP$  : Peak to peak voltage at the non-transition bit.
- $VT\_LvIX\_H$ ,  $VT\_LvIX\_L$ ,  $VN\_LvIX\_H$ , and  $VN\_LvIX\_L$  are identified in the following two figures showing generalized pre-emphasis and non-pre-emphasized waveforms.

- For RBR and HBR

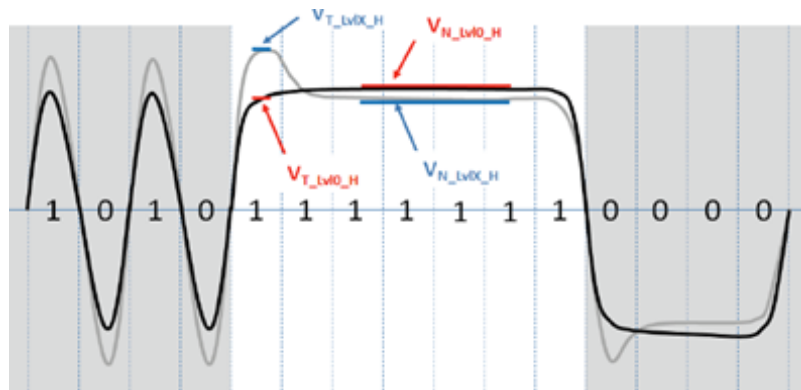

Figure 3: High voltage measurement

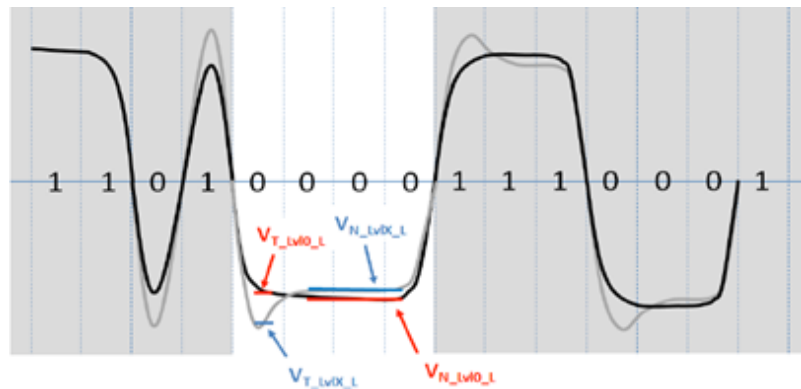

Figure 4: Low voltage measurement

- Qualifying pattern for RBR and HBR  
 0-1-0-1-1-1-1-1-1 for 'High' level measurement  
 1-0-1-0-0-0-0-0-1 for 'Low' Level measurement

For a transition to high measurement, the precondition bits are 0-1-0.  
 For a transition to 'Low' measurement, the precondition bits are 1-0-1.

The transition voltage measurements,  $VT\_LvIX\_H$  and  $VT\_LvIX\_L$ , shall be the average value over the 40% to 70% UI points in the transition bit.

- For HBR2 and HBR3

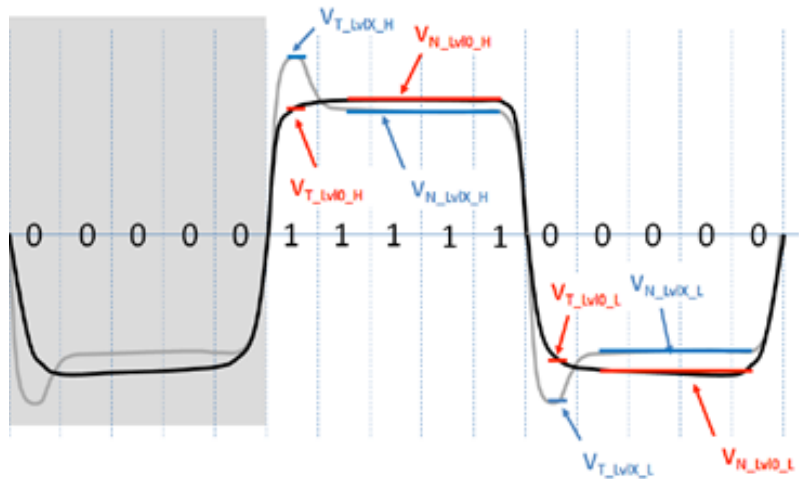

- Qualifying pattern for HBR2 and HBR3  
1-1-1-1-1-0-0-0-0 for 'High' and 'Low' level measurement.  
The transition voltage measurements, VT\_Lv1X\_H and VT\_Lv1X\_L, shall be the average value over the 40% to 70% UI points in the transition bit.
- For N patterns, transition measurements will average 0.3\*N UI of sampled data.
- There are 3 different sets of measurements are done. All the results are Normative
  - Pre-emphasis values for Level 0:
  - Pre-emphasis Delta values for:
    - Level 1 vs. Level 0 Pre-emphasis settings
    - Level 2 vs. Level 1 Pre-emphasis settings
    - Level 3 vs. Level 2 Pre-emphasis settings
  - Non transition voltage range:
    - Level 2 Pre-emphasis setting
    - Level 1 Pre-emphasis setting
    - Level 0 Pre-emphasis setting
- Calculation
  - Pre-emphasis values for Level 0

Result =  $20 \cdot \text{Log} [V_{T\_Lvl0\_PP} / V_{N\_Lvl0\_PP}]$  for all supported levels

- Pre-emphasis Delta values for:

|   |  |
|---|--|
| Level 1 vs. Level 0 (for Voltage swing Level 0,1 and 2)       | Result = $20 \cdot \text{Log} [V_{T\_Lvl1\_PP} / V_{N\_Lvl1\_PP}] - 20 \cdot \text{Log} [V_{T\_Lvl0\_PP} / V_{N\_Lvl0\_PP}]$ |
| Level 2 vs. Level 1 (for Voltage swing Level 0 and 1)         | Result = $20 \cdot \text{Log} [V_{T\_Lvl2\_PP} / V_{N\_Lvl2\_PP}] - 20 \cdot \text{Log} [V_{T\_Lvl1\_PP} / V_{N\_Lvl1\_PP}]$ |
| Level 3 vs. Level 2 (for Voltage swing Level 0, if supported) | Result = $20 \cdot \text{Log} [V_{T\_Lvl3\_PP} / V_{N\_Lvl3\_PP}] - 20 \cdot \text{Log} [V_{T\_Lvl2\_PP} / V_{N\_Lvl2\_PP}]$ |

- Non transition voltage range:

Result =  $\text{MIN}(V_{N\_LvlX\_PP}) / (V_{N\_Lvl0\_PP})$  at each supported level for all supported X. (Level 1, Level 2, and Level 3).

- Compare the result with the limits specified in the VESA specification.

### 3.4 Inter-Pair skew testing (Normative)

This measurement finds the skew, or time delay between the differential data lanes.

#### Measurement Details

This measurement is performed in the following conditions: algorithm runs as follows:

|                           |  |
|---------------------------|--|
| <b>Data rate</b>          | Highest bit rate supported             |
| <b>Test Point</b>         | TP2                                    |
| <b>Pattern</b>            | PRBS7 or DUT dependent custom pattern  |
| <b>Voltage Swing</b>      | Level 2                                |
| <b>Pre-Emphasis</b>       | 0 dB                                   |
| <b>SSC</b>                | SSC Enabled                            |
| <b>Lanes to be tested</b> | Source with 2 or 4 lane operation only |

**Measurement**

- Perform the De-skew of the measurement channel.
- Perform the vertical settings such that the waveform occupies 8 divisions.
- Do the horizontal settings such that oscilloscope can capture more than 100 qualifying edges.
- Capture the waveform on at least 2 channels simultaneously.
- Find the common point on the waveform and use this common point for evaluation of the skew.

At this common point find the time difference between the corresponding edges at the transition point (use transition voltage as 0Volts).

- According the DisplayPort specification, 20UI offset is allowed Lane 0 to Lane 1, Lane 1 to Lane 2, and from Lane 2 to Lane 3. The result is cumulative, between Lane 0 and Lane 2, the offset will be 40UI.

- Skew is calculated as

Inter-Lane Skew Tolerance =  $\{1/\text{NumEdges}\} \sum |T_{\text{Transition\_LaneA}} - T_{\text{Transition\_LaneB}}| - \text{Nominal Skew}$ , where

Nominal Skew: Expected offset between the tested lanes.

- Calculate the below skew values.

|                     |  |
|---------------------|--|
| Two lane operation  | Lane 0 to Lane 1   |
| Four lane operation | Lane 0 to Lane 1<br>Lane 0 to Lane 2<br>Lane 0 to Lane 3<br>Lane 1 to Lane 2<br>Lane 1 to Lane 3<br>Lane 2 to Lane 3 |

- Compare the result with the limits specified in the VESA specification.

### 3.5 Intra-Pair skew test (Informative)

This measurement calculates the skew or time delay between respective sides of a differential data lane.

**Measurement details** This measurement is performed in the following test conditions:

|                           |                            |
|---------------------------|----------------------------|
| <b>Data rate</b>          | Highest bit rate supported |
| <b>Test Point</b>         | TP2                        |
| <b>Pattern</b>            | D10.2                      |
| <b>Voltage Swing</b>      | Level 2                    |
| <b>Pre-Emphasis</b>       | 0 dB                       |
| <b>SSC</b>                | SSC Enabled                |
| <b>Lanes to be tested</b> | All lanes supported        |

#### Measurement Algorithm

- Perform the De-skew of the measurement channel.
- Perform the vertical settings such that the waveform occupies 8 divisions.
- Do the horizontal settings such that oscilloscope can capture more than 100 qualifying edges.
- Capture the Positive and negative channels simultaneously using 2 channels of oscilloscope using 2 single ended probes.
- The rising edge of the data true signal (D+) is compared with the complement's (D-) falling edges, and the rising edge of the complement is compared to falling edge of the data true signal.

Find the time of transition by determining when the waveform crosses the transition amplitude.

- Find VH and VL for single-ended signals D+ and D by finding the average value over the .6 to .75 UI region past the edge.

For D+: measure  $V_{H+}$  ,  $V_{L+}$

For D-:  $V_{H-}$  ,  $V_{L-}$

$V_{Transition\_Data+} = \{V_{H+} + V_{L+}\} / 2$

$V_{Transition\_Data-} = \{V_{H-} + V_{L-}\} / 2$

$Skew = \{1/NumEdges\} \Sigma [ ( D^{+}_{Transition\_High} - D^{-}_{Transition\_Low} ) + ( D^{+}_{Transition\_Low} - D^{-}_{Transition\_High} ) ] / 2$

- Compare the result with the limits specified in the VESA specification.



### 3.10 AC common mode noise (Informative)

This measurement evaluates the AC Common mode noise (unfiltered RMS) of the differential data line.

#### Measurement details

This measurement is performed in the following test conditions:

|                           |                           |
|---------------------------|---------------------------|
| <b>Data rate</b>          | All supported bit rates   |
| <b>Test Point</b>         | TP2                       |
| <b>Pattern</b>            | PRBS7                     |
| <b>Voltage Swing</b>      | All Nominal Voltage Swing |
| <b>Pre-Emphasis</b>       | All Pre-Emphasis levels   |
| <b>SSC</b>                | SSC Enabled, SSC Disabled |
| <b>Lanes to be tested</b> | All lanes supported       |

#### Measurement

- Perform the De-skew of the measurement channel.
- Perform the vertical settings such that the waveform occupies 8 divisions.
- Do the horizontal settings such that oscilloscope can capture more than 100,000 edges.
- Capture the Positive and negative channels simultaneously using 2 channels of oscilloscope using 2 single ended probes.
- Calculate the measurement as below.  

$$V_{TX-AC-CM} = (V_{TX-Plus} + V_{TX-Minus})/2$$
- Compare the result with the limits specified in the VESA specification.

### 3.11 Non-ISI jitter measurements (Normative)

This measurement evaluates the amount of Non-ISI jitter accompanying the data transmission.

**Measurement details**

This measurement is performed in the following test conditions:

|                           |                           |                           |
|---------------------------|---------------------------|---------------------------|
| <b>Data rate</b>          | RBR                       | HBR                       |
| <b>Test Point</b>         | TP2                       | TP2                       |
| <b>Pattern</b>            | PRBS7                     | PRBS7                     |
| <b>Voltage Swing</b>      | All Nominal Voltage Swing | All Nominal Voltage Swing |
| <b>Pre-Emphasis</b>       | Level 0 (0dB)             | Level 0 (0dB)             |
| <b>SSC</b>                | SSC Enabled, SSC Disabled | SSC Enabled, SSC Disabled |
| <b>Lanes to be tested</b> | All lanes supported       | All lanes supported       |

- This measurement is performed only at RBR and HBR data rates.
- The test may or may not pass at other Pre-Emphasis levels.

**Measurement**

- Perform the vertical settings such that the waveform occupies 8 divisions.
- Capture 1M Unit Intervals.
- Use the below clock recovery.

|           |                       |                       |
|-----------|-----------------------|-----------------------|
| Data rate | RBR                   | HBR                   |
| PLL Type  | 2 <sup>nd</sup> Order | 2 <sup>nd</sup> Order |
| Bandwidth | 5.4 MHz               | 10 MHz                |
| Damping   | 1.51                  | 1.51                  |

- Perform the TJ (Total Jitter) measurement using Dual Dirac technique. TJ is estimated as

$$TJ = DJ_{dd} + n * RJ, \text{ Where}$$

- DJ : Deterministic jitter
- RJ : Random jitter
- n : 12 ( to accommodate a Bit Error Ratio value of 1\*10<sup>-9</sup>)

- Calculate Non-ISI jitter as

$$Jitter_{NON\_ISI} = TJ - Jitter_{ISI}, \text{ where}$$

Jitter<sub>ISI</sub> : is data dependent jitter due to ISI.

- Compare the result with the limits specified in the VESA specification.

### 3.12.1 Total jitter (TJ) and RJ (RJ/TJ) measurement (Normative)

This test evaluates the total jitter at  $10^{-9}$ . This can be measured explicitly at this rate or through an approved estimation technique.

**Measurement details** This measurement is performed in the following test conditions:

|                           |                           |                           |                           |                           |                           |
|---------------------------|---------------------------|---------------------------|---------------------------|---------------------------|---------------------------|
| <b>Data rate</b>          | RBR<br>(Normative)        | HBR<br>(Normative)        | HBR<br>(Informative)      | HBR2<br>(Informative)     | HBR3<br>(Informative)     |
| <b>Test Point</b>         | TP2                       | TP2                       | TP3_EQ                    | TP3_EQ                    | TP3_EQ                    |
| <b>Pattern</b>            | PRBS7                     | PRBS7                     | PRBS7                     | CP2520                    | TS4                       |
| <b>Voltage Swing</b>      | All nominal levels        | All nominal levels        | All nominal levels        | Any passing Eye setting   | Any passing Eye setting   |
| <b>Pre-Emphasis</b>       | Level 0                   | Level 0                   | Level 0                   | All nominal levels        | All nominal levels        |
| <b>SSC</b>                | SSC Enabled, SSC Disabled | SSC Enabled, SSC Disabled | SSC Enabled, SSC Disabled | SSC Enabled, SSC Disabled | SSC Enabled, SSC Disabled |
| <b>Lanes to be tested</b> | All lanes supported       | All lanes supported       | All lanes supported       | All lanes supported       | All lanes supported       |

- To get TP3\_EQ, waveform is captured at TP2 and Cable emulator applied in SW.
- The eye diagram test should pass both ‘worst case cable’ and a ‘zero length cable’ model.

#### Measurement

- Perform the vertical settings such that the waveform occupies 8 divisions.
- Capture 1M Unit Intervals.
- Use the following clock recovery values:

|           |                       |                       |                       |                       |
|-----------|-----------------------|-----------------------|-----------------------|-----------------------|
| Data rate | RBR                   | HBR                   | HBR2                  | HBR3                  |
| PLL Type  | 2 <sup>nd</sup> Order | 2 <sup>nd</sup> Order | 2 <sup>nd</sup> Order | 2 <sup>nd</sup> Order |
| Bandwidth | 5.4 MHz               | 10 MHz                | 10 MHz                | 15 MHz                |
| Damping   | 1.51                  | 1.51                  | 1.0                   | 1.0                   |

- To achieve the worst case cable model (Where ever applicable, for the selected data rate), capture the signal at TP2 and apply the worst case cable emulator using the MATH subsystem in the oscilloscope.
- To achieve the ‘zero length cable’, capture the signal at TP2 and do not embed any cable model.
- For HBR and HBR2 data rate needs Equalization. For each of the acquisitions above, the Analyzer applies a CTLE (Continuous Time Linear Equalization) Transfer Function as defined in VESA specification.

- For HBR3 Data rate needs Equalization. For each of the acquisitions above, the Analyzer applies a CTLE (Continuous Time Linear Equalization) Transfer Function cascaded with a one-tap Decision Feedback Equalizer (DFE) as defined in VESA specification using Tektronix SDLA (Serial Data Link Analysis) software.
- Use the Dual-Dirac model to estimate the jitter to a 10<sup>-9</sup> BER. Total Jitter (TJ) is estimated as  

$$TJ = DJ_{dd} + n * RJ$$
 Where  
 RJ: Random jitter  
 n: 12 ( to accommodate a Bit Error Ratio value of 1\*10<sup>-9</sup>)
- Compare the result with the limits specified in the VESA specification.

### 3.12.2 HBR2 D10.2 Total Jitter/Random jitter/Deterministic jitter (TJ/RJ/DJ) measurement (Normative)

This measurement evaluates the total jitter at 10<sup>-9</sup>. This can be measured explicitly at this rate or through an approved estimation technique.

**Measurement details**

This measurement is performed in the following test conditions:

|                           |                             |                             |
|---------------------------|-----------------------------|-----------------------------|
| <b>Data rate</b>          | HBR2                        | HBR3                        |
| <b>Test Point</b>         | TP3_EQ                      | TP3_EQ                      |
| <b>Pattern</b>            | D10.2                       | D10.2                       |
| <b>Voltage Swing</b>      | Any passing Eye setting     | Any passing Eye setting     |
| <b>Pre-Emphasis</b>       | Any passing Eye setting     | Any passing Eye setting     |
| <b>SSC</b>                | SSC Enabled<br>SSC Disabled | SSC Enabled<br>SSC Disabled |
| <b>Lanes to be tested</b> | All lanes supported         | All lanes supported         |

- To get TP3\_EQ, waveform is captured at TP2 and Cable emulator applied in SW.
- The eye diagram test should pass both ‘worst case cable’ and a ‘zero length cable’ model.

- Measurement**
- Perform the vertical settings such that the waveform occupies 8 divisions.
  - Capture 1M Unit Intervals.
  - Use the following clock recovery values:

| Data rate | RBR                   | HBR                   | HBR2                  | HBR3                  |
|-----------|-----------------------|-----------------------|-----------------------|-----------------------|
| PLL Type  | 2 <sup>nd</sup> Order | 2 <sup>nd</sup> Order | 2 <sup>nd</sup> Order | 2 <sup>nd</sup> Order |
| Bandwidth | 5.4 MHz               | 10 MHz                | 10 MHz                | 15 MHz                |
| Damping   | 1.51                  | 1.51                  | 1.0                   | 1.0                   |

- To achieve the worst case cable model (Where ever applicable, for the selected data rate), capture the signal at TP2 and apply the worst case cable emulator using the MATH subsystem in the oscilloscope.
- To achieve the ‘zero length cable’, capture the signal at TP2 and do not embed any cable model.
- For HBR and HBR2 data rate needs Equalization. For each of the acquisitions above, the Analyzer applies a CTLE (Continuous Time Linear Equalization) Transfer Function as defined in VESA specification.
- For HBR3 Data rate needs Equalization. For each of the acquisitions above, the Analyzer applies a CTLE (Continuous Time Linear Equalization) Transfer Function cascaded with a one-tap Decision Feedback Equalizer (DFE) as defined in VESA specification using Tektronix SDLA (Serial Data Link Analysis) software.
- Use the Dual-Dirac model to estimate the jitter to a 10<sup>-9</sup> BER. Total jitter (TJ) is estimated as  

$$TJ = DJ_{dd} + n * RJ, \text{ Where}$$
 RJ: Random jitter  
 n: 12 ( to accommodate a Bit Error Ratio value of 1\*10<sup>-9</sup>)
- Compare the result with the limits specified in the VESA specification.

### 3.14 Main link frequency compliance (Normative)

This measurement ensures that the average data rate under all conditions does not exceed minimum or maximum as set by the standard.

**Measurement details** This measurement is performed in the following test conditions:

|                           |                             |
|---------------------------|-----------------------------|
| <b>Data rate</b>          | All supported bit rates     |
| <b>Test Point</b>         | TP2                         |
| <b>Pattern</b>            | D10.2                       |
| <b>Voltage Swing</b>      | Level 2                     |
| <b>Pre-Emphasis</b>       | 0 dB                        |
| <b>SSC</b>                | SSC Enabled<br>SSC Disabled |
| <b>Lanes to be tested</b> | All lanes                   |

- If the measurement is performed with SSC, then at least 10 full SSC cycles is required.

- Measurement**
- Perform the vertical settings such that the waveform occupies 8 divisions.
  - Set the horizontal settings such that at least 10 full cycles (when SSC is enabled) OR 33usec duration (when SSC is disabled).
  - Find the average data rate/Frequency.
  - Compare the result with the limits specified in the VESA specification.

### 3.15 Spread spectrum modulation frequency (Normative)

This measurement evaluates the Spread Spectrum modulation frequency modulation.

**Measurement details** This measurement is performed in the following test conditions:

|                           |                            |
|---------------------------|----------------------------|
| <b>Data rate</b>          | Highest bit rate supported |
| <b>Test Point</b>         | TP2                        |
| <b>Pattern</b>            | D10.2                      |
| <b>Voltage Swing</b>      | Level 2                    |
| <b>Pre-Emphasis</b>       | 0 dB                       |
| <b>SSC</b>                | SSC Enabled                |
| <b>Lanes to be tested</b> | All lanes                  |

- An evaluation of at least 10 full SSC cycles is required and Mean value should be reported.
- Devices that do not have SSC Enabled shall not be tested.

- Measurement**
- Perform the vertical settings such that the waveform occupies 8 divisions.
  - Set the horizontal settings such that at least 10 full cycles are captured.
  - Find the period trend with low pass filter with 2nd order Butterworth with a 3dB corner frequency of 1.98MHz (to remove the non-SSC jitter components). Find the mean frequency of the period trend compare this with the limits as specified in the VESA specification.

### 3.16 Spread spectrum modulation (Normative)

This measurement evaluates the range of the SSC down-spreading of the transmitter signal.

**Measurement details** This measurement is performed in the following test conditions:

|                           |                            |
|---------------------------|----------------------------|
| <b>Data rate</b>          | Highest bit rate supported |
| <b>Test Point</b>         | TP2                        |
| <b>Pattern</b>            | D10.2                      |
| <b>Voltage Swing</b>      | Level 2                    |
| <b>Pre-Emphasis</b>       | 0 dB                       |
| <b>SSC</b>                | SSC Enabled                |
| <b>Lanes to be tested</b> | All lanes                  |

- An evaluation of at least 10 full SSC cycles is required and Mean value should be reported.
- Devices that do not have SSC Enabled shall not be tested.

- Measurement**
- Perform the vertical settings such that the waveform occupies 8 divisions.
  - Set the horizontal settings such that at least 10 full cycles are captured.
  - Find the period trend with low pass filter with 2nd order Butterworth with a 3dB corner frequency of 1.98MHz (to remove the non-SSC jitter components).
  - For each cycle, the minimum and maximum data rate is evaluated, and for all such cycles the maximum, minimum and optional average data rates are determined. The range is calculated as follows:
 
$$\text{SSC range} = \{[\text{Average}(\text{RateMin values}) - \text{Average}(\text{RateMax Values})] / \text{Nominal Data Rate}\} * 1e6$$
  - Compare the result with the limits specified in the VESA specification.



### 3.17 dF-dt spread spectrum deviation HF variation (Informative)

This measurement verifies whether the SSC profile does not include any frequency deviation which would exceed 1250ppm/uSec.

**Measurement details** This measurement is performed in the following test conditions:

|                           |                            |
|---------------------------|----------------------------|
| <b>Data rate</b>          | Highest bit rate supported |
| <b>Test Point</b>         | TP2                        |
| <b>Pattern</b>            | D10.2                      |
| <b>Voltage Swing</b>      | Level 2                    |
| <b>Pre-Emphasis</b>       | 0 dB                       |
| <b>SSC</b>                | SSC Enabled                |
| <b>Lanes to be tested</b> | All lanes                  |

- An evaluation of at least 10 full SSC cycles is required and peak dF/dT value should be reported.
- Devices that do not have SSC Enabled will not be tested.

**Measurement** The algorithm runs as follows:

- Perform the vertical settings such that the waveform occupies 8 divisions.
- Set the horizontal settings such that at least 10 full cycles are captured.
- Find the period trend with low pass filter with 2nd order Butterworth with a 3dB corner frequency of 1.98MHz (to remove the non-SSC jitter components).
- Once the filtered SSC profile is established, a ‘sliding window’ is moved across the profile values to compute the slope. This window has a width of 0.27us, and the slope value for each horizontal point is calculated from the difference equation:  

$$\text{Slope} = (f(t) - f(t - 0.27 \text{ usec})) / 0.27 \text{ us.}$$
- Compare the peak result with the limits specified in the VESA specification.

### 3.18 Dual mode TMDS clock (Normative if supported)

This measurement confirms that the TMDS clock waveform of a source operating in dual-mode does not exceed acceptable limits.

**Measurement Algorithm** Confirm that the duty cycle of the TMDS clock waveform of a source operating in dual-mode does not exceed acceptable limits. Confirm that the waveform does not carry excessive jitter.

The algorithm runs as follows:

1. Put the device in the mode which transmits the maximum TMDS clock rate supported by the DUT.
2. Based on the frequency of clock, generate the mask.
3. Capture TMDS Clock with at least 400,000 clock periods.
4. Measure the duty cycle, Mask Hit and Jitter.

The measurement is a pass if:

- $40\% < \text{TMDS\_CLOCK duty cycle} < 60\%$
- Mask Hits = 0
- For  $25 \text{ MHz} \leq \text{TMDS Clock Frequency} \leq 165 \text{ MHz}$ : Measured TMDS Clock Jitter  $\leq 0.20 \text{ Tbit}$
- For  $165 \text{ MHz} < \text{TMDS Clock Frequency} \leq 300 \text{ MHz}$ : Measured TMDS Clock Jitter  $\leq 120 \text{ ps}$

### 3.19 Dual mode eye diagram testing (Normative if supported)

This measurement evaluates the waveform and ensures that timing variables and amplitude trajectories meet the requirements for a dual-mode source device.

**Measurement Algorithm** The algorithm runs as follows:

1. Put device in the mode which transmits the maximum TMDS clock rate supported by the DUT and capture clock as well as data on all the lanes simultaneously.
2. Select and run Mask Hits test and TIE measurement from DPOJET.
3. Evaluate results for over 400,000 UI.

The measurement is a pass if

- Mask Hits = 0
- $25 \text{ MHz} \leq \text{TMDS Clock Frequency} \leq 165 \text{ MHz}$ : Data Jitter  $\leq 0.25 \text{ Tbit}$
- $165 \text{ MHz} < \text{TMDS Clock Frequency} \leq 300 \text{ MHz}$ : Data Jitter  $\leq 150 \text{ ps}$

## 8.1 AUX channel eye diagram testing

This measurement checks if AUX channel waveform timing variables and amplitude trajectories support the DisplayPort system.

### Measurement Algorithm

This measurement checks if the Eye opening for the data transmitted by the Aux channel of the DUT is within limits. As the data comes in as a burst, cursors are used. The following are the steps for the measurement:

1. Initiate an AUX transaction from the DUT. Capture the burst of data transmitted by the DUT.
2. Find the edges from the burst. Edges are found such that at least 38 edges are available measurement (16 SYNC pulses, SYNC End, 4 data bits).
3. Mask Hit measurement and eye height measurement are run using DPOJET.
4. Steps 1-3 are repeated for 10 times and results are picked up from DPOJET.

The measurement is a pass if Eye height > 290 mV and there are no mask hits.

## 8.2 AUX channel eye sensitivity test

This measurement evaluates the sensitivity to the AUX CH EYE opening of the DUT.

### Measurement Algorithm

The test verifies the EYE sensitivity of the AUX receiver in the DUT, by controlling the voltage swing of the AUX transmitter in the Reference device. The Reference device shall set the AUX differential voltage swing to 280 mV<sub>diff\_pp</sub> at its connector. Stimulus shall be applied to either the Reference device or DUT to cause AUX CH transactions to occur. This stimulus shall not be included in or affect the measurement.

The algorithm runs as follows:

1. Set Reference Source AUX channel voltage swing to a level between 240 mV and 280 mV<sub>diff\_pp</sub> as measured at its connector.
2. Induce an AUX transaction to setup the DUT to transmit a specific pattern.
3. Determine whether AUX channel communication takes place successfully by checking if the requisite pattern was transmitted.
4. Repeat steps 2 and 3 twenty (20) times.

The measurement is a Pass if no errors are observed.

## 8.5 Inrush test

This measurement evaluates the Inrush energy at the power supply input of a power consuming DUT or to evaluate the inrush tolerance at the power supply output of a power providing DUT.

### Measurement Algorithm

1. Connect the VTM Inrush Test Fixture (VITF) to the source DUT's DP interface port.
2. Power on the VTM fixture using the USB-Mini USB cable connected to one of the oscilloscope's USB ports.
3. Plug the TCP202 Current Probe into CH1 of the oscilloscope, using a TCABNC input adapter. Connect the current probe head to the current-sense loop on the VITF.
4. Plug the P6246/ P6247 differential probe into CH2 of the oscilloscope using a TCABNC input adapter. Set the P6246/ P6247 probe switches to DC Reject = On, BW = 200MHz, and Attenuation  $\div 10$ . Using a square-pin adapter for the P6246/ P6247 probe tip, connect the probe inputs to the VITF, Connector P4, pins 2 and 4. (Alternatively, direct connection using SMA cables between the VTM fixture and the oscilloscope can also be used.
5. Select "Default Setup" using the oscilloscope's front panel button.
6. From Horizontal Setup menu, set horizontal scale to 10.0  $\mu\text{s}/\text{div}$  and sample rate to 25 GS/s (Constant Sample Rate). Check that record length is set to 2.5 M
7. From the Vertical Setup menu, set vertical scale for CH1 to 2.0 A/div as a starting point.
8. Set CH1 bandwidth to 500MHz and CH2 vertical scale to 500 mV/div, BW = 500 MHz.
9. Set trigger for CH1, Positive Edge and set the trigger level as 2A.
10. Move the trigger point near the left-hand side of the scope display. Set it to 10%.
11. From the Math menu set Math1 = ArbFlt(CH1\*CH2) to display Power.
12. For the arbitrary filter, load the filter for "LowPass-norm, 0.05bw" which will reduce spurious noise on the math display.
13. Set Math1 vertical scale to 2W/div, scale 10  $\mu\text{s}$ .
14. Move CH1, CH2, and Math1 vertical position to -3.5 div, so it will be near the bottom of the display.
15. From the Measurement setup menu, navigate to "More"  $\rightarrow$  Area measurement for Math 1 to measure the area under the power curve. The result will come in Ws (Watt-second) format.
16. "Clear" the current acquisition on the oscilloscope. Enable "Single" Acquisition.
17. To test inrush from a Source device, press the source test button (grey button) on the VITF. (Can't be automated need to give user pop up)

- 18.** Observe the oscilloscope main display to see that the current inrush signal at Ch1, Voltage signal at Ch2 and Power signal at Math1. The area under the power curve is calculated to measure energy.
- 19.** Please convert value of TekScope measurement Area  $\mu$ Ws (micro Watt-second) to mJoules (milliJoules ) after dividing by 1000.
- 20.** Compare the Area with the spec limit stipulated in the CTS to determine if the DUT meets the requirement for <0.4 mJoules. The device passes if the measured energy is <0.4 mJoules.



---

# TekExpress programmatic interface

## About the programmatic interface

The Programmatic interface seamlessly integrates the TekExpress test automation application with the high-level automation layer. This also lets you control the state of the TekExpress application running on a local or a remote computer.

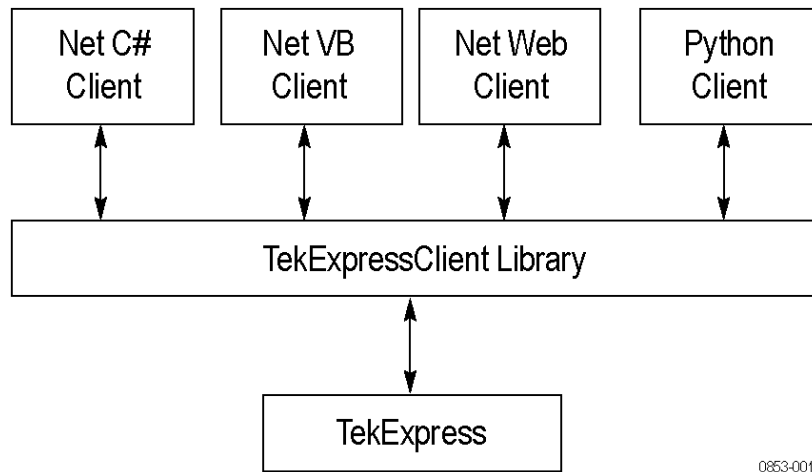

The following terminology is used in this section to simplify description text:

- **TekExpress Client:** A high-level automation application that communicates with TekExpress using TekExpress Programmatic Interface.
- **TekExpress Server:** The TekExpress application when being controlled by TekExpress Client.

TekExpress leverages .Net Marshalling to enable the Programmatic Interface for TekExpress Client. TekExpress provides a client library for TekExpress clients to use the programmatic interface. The TekExpress client library is inherited from .Net MarshalByRef class to provide the proxy object for the clients. The TekExpress client library maintains a reference to the TekExpress Server and this reference allows the client to control the server state.

See also [Requirements for developing TekExpress client](#)

## To enable remote access

To access and remotely control an instrument using the TekExpress programmatic interface, you need to change specific firewall settings as follows:

1. Access the Windows Control Panel and open the Windows Firewall tool (**Start > Control Panel > All Control Panel Items > Windows Firewall**).
2. Click **Advance Settings > Inbound Rules**.
3. Scroll through the **Inbound Rules** list to see if the following items (or with a similar name) are shown:
  - TekExpress DisplayPort
  - TekExpress

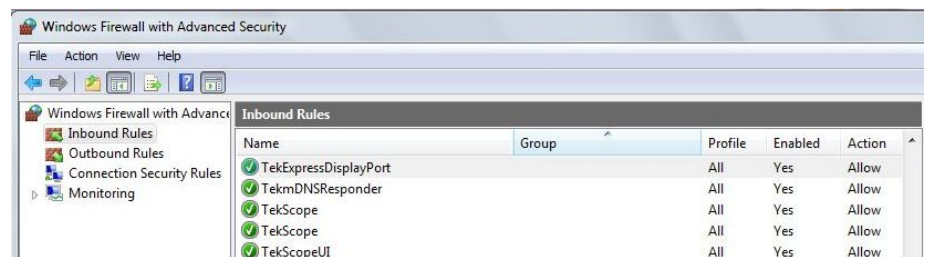

4. If both items are shown, you do not need to set up any rules. Exit the Windows Firewall tool.
5. If one or both are missing, use the following procedure to run the **New Inbound Rule Wizard** and add these executables to the rules to enable remote access to the TekExpress application.
6. On the client side include Client application.exe through which TekExpress application is remotely controlled. For example if the application is controlled using python scripts then "ipy64.exe" should be included as part of Inbound rules.



## Run the New Inbound Rule Wizard

1. Click on **New Rule** (in Actions column) to start the **New Inbound Rule Wizard**.

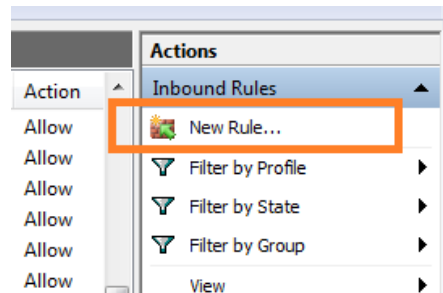

2. Verify that **Program** is selected in the Rule Type panel and click **Next**.
3. Click **Browse** in the Program panel and navigate to and select one of the following TekExpress applications (depending on the one for which you need to create a rule):
  4. TekExpress DisplayPort.exe
  5. TekExpress.exe

---

**NOTE.** See for the path to the application files.

---

6. Click **Next**.
7. Verify that **Allow the connection** is selected in the Action panel and click **Next**.
8. Verify that all fields are selected (**Domain**, **Private**, and **Public**) in the Profile panel and click **Next**.
9. Use the fields in the Name panel to enter a name and optional description for the rule. For example, a name for the TekExpress DisplayPort application could be **TekExpress DisplayPort Application**. Add description text to further identify the rule.
10. Click **Finish** to return to the main Windows Firewall screen.
11. Scroll through the Inbound Rules list and verify that the list shows the rule that you just entered.

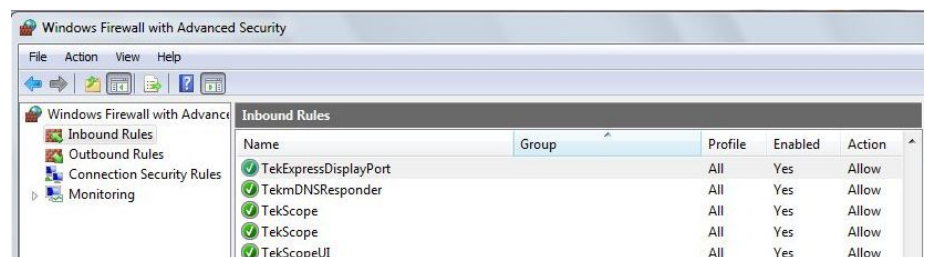

12. Repeat steps *I* through *II* to enter the other TekExpress executable if it is missing from the list. Enter **TekExpress PI** as the name.

13. Scroll through the Inbound Rules list and verify that the list shows the rule that you just entered.
14. Exit the Windows Firewall tool.

- To use the remote access:**
1. Obtain the IP address of the instrument on which you are running TekExpress DisplayPort. For example, 134.64.235.198.
  2. On the PC from which you are accessing the remote instrument, use the instrument IP address as part of the TekExpress DisplayPort PI code to access that instrument. For example:  

```
object obj = piClient.Connect("134.64.235.198",out clientid);
```

## Requirements for developing TekExpress client

While developing TekExpress Client, use the TekExpressClient.dll. The client can be a VB .Net, C# .Net, Python, or Web application. The examples for interfaces in each of these applications are in the Samples folder.

- References required**
- TekExpressClient.dll has an internal reference to IIdlglib.dll and IRemoteInterface.dll.
  - IIdlglib.dll has a reference to TekDotNetLib.dll.
  - IRemoteInterface.dll provides the interfaces required to perform the remote automations. It is an interface that forms the communication line between the server and the client.
  - IIdlglib.dll provides the methods to generate and direct the secondary dialog messages at the client-end.

---

**NOTE.** *The end-user client application does not need any reference to the above mentioned DLL files. It is essential to have these DLLs (IRemoteInterface.dll, IIdlglib.dll and TekDotNetLib.dll) in the same folder as that of TekExpressClient.dll.*

---

**Required steps for a client**

The client uses the following steps to use TekExpressClient.dll to programmatically control the server:

Develop a client UI to access the interfaces exposed through the server. This client loads TekExpressClient.dll to access the interfaces. After TekExpressClient.dll is loaded, the client UI can call the specific functions to run the operations requested by the client. When the client is up and running, it does the following to run a remote operation:

1. To connect to the server, the client provides the IP address of the PC where the server is running.
2. The client locks the server application to avoid conflict with any other Client that may try to control the server simultaneously. “Lock” would also disable all user controls on the server so that server state cannot be changed by manual operation.

If any other client tries to access a server that is locked, it will receive a notification that the server is locked by another client.

3. When the client has connected to and locked the server, the client can access any of the programmatic controls needed to run the remote automations.
4. After the client operations finish, the client unlocks the server.

**Remote proxy object**

The server exposes a remote object to let the remote client access and perform the server-side operations remotely. The proxy object is instantiated and exposed at the server-end through marshalling.

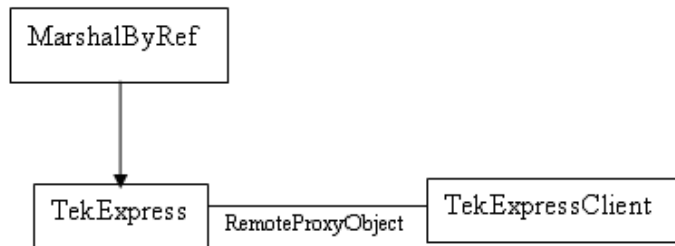

The following is an example:

```

RemotingConfiguration.RegisterWellKnownServiceType (typeof
(TekExpressRemoteInterface), "TekExpress Remote interface",
WellKnownObjectMode.Singleton);
  
```

This object lets the remote client access the interfaces exposed at the server side. The client gets the reference to this object when the client gets connected to the server.

For example,

```
//Get a reference to the remote object
remoteObject =
(IRemoteInterface)Activator.GetObject(typeof(IRemoteInterface),
URL.ToString());
```

## Client proxy object

Client exposes a proxy object to receive certain information.

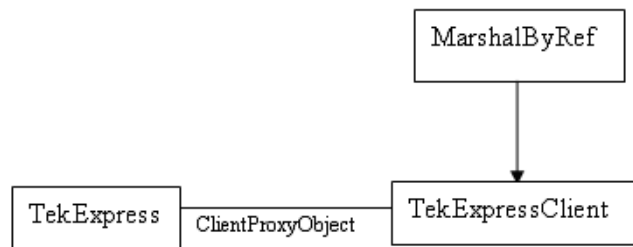

For example,

```
//Register the client proxy object
WellKnownServiceTypeEntry[] e =
RemotingConfiguration.GetRegisteredWellKnownServiceTypes();
clientInterface = new ClientInterface();
RemotingConfiguration.RegisterWellKnownServiceType(typeof(ClientInterface)
, "Remote Client Interface", WellKnownObjectMode.Singleton);
//Expose the client proxy object through marshalling
RemotingServices.Marshal(clientInterface, "Remote Client Inteface");
```

The client proxy object is used for the following:

- To get the secondary dialog messages from the server.
- To get the file transfer commands from the server while transferring the report.

Examples

```
clientObject.clientIntf.DisplayDialog(caption, msg, iconType, btnType);
clientObject.clientIntf.TransferBytes(buffer, read, fileLength);
```

For more information, click the following links:

[Secondary Dialog Message Handling](#)

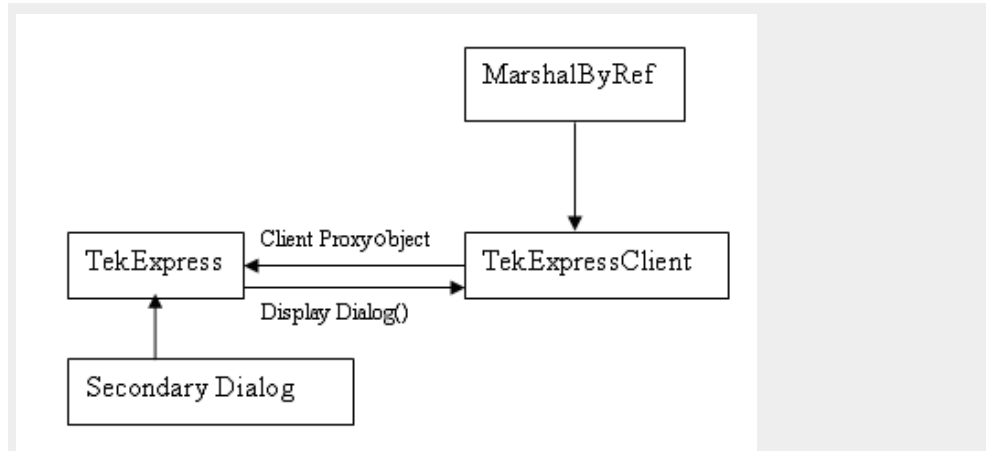

The secondary dialog messages from the Secondary Dialog library are redirected to the client-end when a client is performing the automations at the remote end.

In the secondary dialog library, the assembly that is calling for the dialog box to be displayed is checked and if a remote connection is detected, the messages are directed to the remote end.

#### File Transfer Events

When the client requests the transfer of the report, the server reads the report and transfers the file by calling the file transfer methods at the client-end.

## Client programmatic interface example

An example of the client programmatic interface is described and shown as follows:

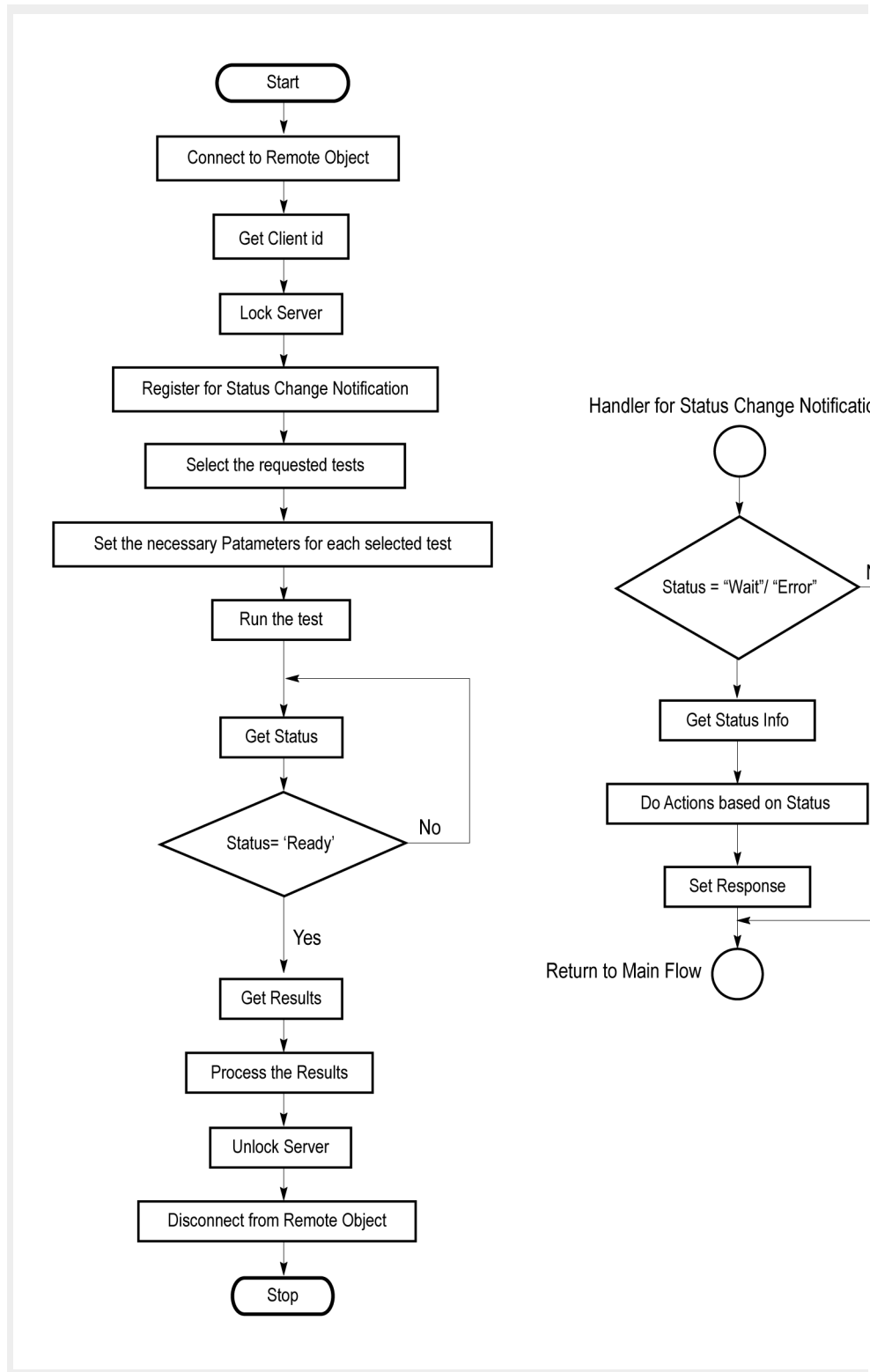

---

**NOTE.** You can find programmatic interface examples under TekExpress DisplayPort Tx\Examples.

---

1. Connect to a server or remote object using the programmatic interface provided.
2. Get the client ID that is created when connecting to the remote object. This client ID is one of the required parameters to communicate with the server.

---

**NOTE.** The server identifies the client with this ID only and rejects any request if the ID is invalid.

---

3. Lock the server for further operations. This disables the application interface.

---

**NOTE.** You can get values from the server or set values from the server to the client only if the application is locked.

---

4. Register for receiving notifications on status change events on the server. To register you need to give a handler as a parameter.

---

**NOTE.** Whenever there is a change in the status of the server, all the clients registered with the server receive a notification from the server.

---

5. Select the tests that you want to run through the programmatic interface.
6. Set the necessary parameters for each test.
7. Run the tests.
8. Poll for the status of the application.

---

**NOTE.** Skip step 8 if you are registered for the status change notification and the status is Ready.

---

9. After completing the tests, get the results.
10. Create a report or display the results and verify or process the results.
11. Unlock the server after you complete all the tasks.
12. Disconnect from the remote object.

**Handler of status change notification**

1. Get the status. If the status is Wait or Error, get the information that contains the title, message description, and the expected responses for the status.
2. Perform the actions based on the status information.
3. Set the response as expected.

See also [Program remote access code example](#)

## Program remote access code example

This code example shows how to communicate between a remote PC and TekExpress DisplayPort.

**Table 15: Remote access code example**

| Task                              | Code  |
|-----------------------------------|---|
| Start the application             |   |
| Connect through an IP address.    | 'assigns client IP address to variable clientID; address valid until connection or measurement session ends (Disconnect). See Connect()<br>clientID = "<br>m_Client.Connect("localhost",out clientID)'True or False |
| Lock the server                   | m_Client.LockServer(clientID)   |
| Disable the Popups                | m_Client.SetVerboseMode(clientID, false)  |
| Set the DUT ID                    | m_Client.SetDutId(clientID, "DUT_Name")   |
| Run with set configurations       | m_Client.Run(clientID)  |
| Wait for the test to complete.    | Do<br>Thread.Sleep(500)<br>m_Client.Application_Status(clientID)<br>Select Case status<br>Case "Wait"   |
| Get the current state information | mClient.GetCurrentStateInfo(clientID, WaitingMsbBxCaption, WaitingMsbBxMessage, WaitingMsbBxButtontexts)  |
| Send the response                 | mClient.SendResponse(clientID, WaitingMsbBxCaption, WaitingMsbBxMessage, WaitingMsbBxResponse)<br>End Select<br>Loop Until status = "Ready"   |
| Save results                      | 'Save all results values from folder for current run<br>m_Client.TransferResult(clientID, logDirname)   |
| Unlock the server                 | m_Client.UnlockServer(clientID)   |
| Disconnect from server            | m_Client.Disconnect(clientID)   |
| Exit the application              |   |



## DisplayPort programmer interface commands

### ApplicationStatus() ApplicationStatus(clientId)

This method gets the status (ready, running, paused) of the server application.

#### Parameters

| Name     | Type   | Direction | Description  |
|----------|--------|-----------|--|
| clientId | string | IN        | Identifier of the client that is performing the remote function. clientId variable |

#### clientId variable

clientId is a user-defined variable that stores the client ID address information. Use the Connect() command to fill this variable:

```
clientId = ""
```

```
m_Client.Connect("localhost",out clientId)True or False
```

The clientId variable is stored until you call the Disconnect command.

---

**NOTE.** The Fail condition for this command occurs in the following conditions:

*If the server is LOCKED the command returns "Server is locked by another client".*

*If the session is UNLOCKED the command returns "Lock Session to execute the command".*

*If the server is NOTFOUND the command returns "Server not found...Disconnect!".*

*If none of these fail conditions occur the command returns "Failed...".*

---

#### Return value

String value that gives the status of the server application.

#### Example

```
m_Client = new Client() //m_Client is a reference to the Client class in the Client DLL.
```

```
returnval as string
```

```
returnval=m_Client.ApplicationStatus(clientID)
```

#### Comments

The application is in the Running, Paused, Wait, or Error state at any given time.

#### Related command(s)

*GetCurrentStateInfo*

*SendResponse*

*Status*

**Connect()** **Connect(string HostIPAddress, out string clientID).** This command connects the client to the server; address is the IP address of the server to which the client is trying to connect. This is required to establish the connection between the client and the server.

---

**NOTE.** *The server must be active and running for the client to connect to the server. Any number of clients can be connected to the server at a time.*

---

**Parameters.**

| Parameter     | Type   | Direction | Description  |
|---------------|--------|-----------|--|
| HostIPAddress | string | IN        | Obtains the IP address of the server to which the client is trying to connect. This is required to establish the connection between the server and the client. |
| clientId      | string | OUT       | Identifier of the client that is performing the remote function. clientId variable   |

**Return value.** Value that indicates the connection status (connection was established or an error occurred). The return value can be a boolean value (true), or a string (returning the error message).

---

**NOTE.** *The Fail condition for this command occurs in the following conditions:*

*If the server is LOCKED the command returns "Server is locked by another client".*

*If the session is UNLOCKED the command returns "Lock Session to execute the command".*

*If the server is NOTFOUND the command returns "Server not found...Disconnect!".*

*If none of these fail conditions occur the command returns "Failed...".*

---

**Example.** try {  
 m\_Client = new Client() //m\_Client is a reference to the Client class in the Client DLL  
 clientID = ""  
 m\_Client.Connect("localhost",out clientID)'True or False  
 }

**Comments.** The server has to be active and running for the client to connect to the server. Any number of clients can be connected to the server at a time. Each client will get a unique id.

**Related command(s).** [Disconnect](#)

**Disconnect()** **Disconnect(clientId).** This command disconnects the client from the server it is connected to.

**Parameters.**

| Parameter | Type   | Direction | Description  |
|-----------|--------|-----------|--|
| clientId  | string | IN        | Identifier of the client that is performing the remote function. clientId variable |

**Return value.** Integer value that indicates the status of the operation upon completion.

1: Success

-1: Failure

**Example.** try

```
{
string returnVal = UnlockServer (clientId);
remoteObject.Disconnect (clientId);
return 1;
}
```

**Comments.** When the client is disconnected, it is unlocked from the server and then disconnected. The id is reused.

**Related command(s).** [Connect](#)

**GetCurrentStateInfo()** **GetCurrentStateInfo(clientID, WaitingMsbBxCaption, WaitingMsbBxMessage, WaitingMsbBxButtontexts).** This command gets the additional information of the states when the application is in Wait or Error state.

Except client ID, all the others are Out parameters.

---

**NOTE.** *This command is used when the application is running and is in the wait or error state.*

---

**Parameters.**

| Parameter               | Type         | Direction | Description  |
|-------------------------|--------------|-----------|--|
| clientId                | string       | IN        | Identifier of the client that is performing the remote function. clientId variable |
| WaitingMsbBxCaption     | string       | OUT       | The wait state or error state message sent to you                                  |
| WaitingMsbBxMessage     | string       | OUT       | The wait state/error state message sent to you                                     |
| WaitingMsbBxButtontexts | string array | OUT       | An array of strings containing the possible response types that you can send       |

**clientId variable**

clientId is a user-defined variable that stores the client ID address information. Use the Connect() command to fill this variable:

```
clientId = ""
```

```
m_Client.Connect("localhost",out clientId)'True or False
```

The clientId variable is stored until you call the Disconnect command.

---

**NOTE.** *The Fail condition for this command occurs in the following conditions:*

*If the server is LOCKED the command returns "Server is locked by another client".*

*If the session is UNLOCKED the command returns "Lock Session to execute the command".*

*If the server is NOTFOUND the command returns "Server not found...Disconnect!".*

*If none of these fail conditions occur the command returns "Failed...".*

---

**Return value.** This command does not return any value.

This function populates the Out parameters that are passed when invoking this function.

**Example.** `m_Client = new Client()` //m\_Client is a reference to the Client class in the Client DLL

```
mClient.GetCurrentStateInfo(clientID, WaitingMsBxBxCaption,
WaitingMsBxBxMessage, WaitingMsBxBxButtontexts)
```

**Comments.**

**Related command(s).** [ApplicationStatus](#)

[SendResponse](#)

**GetDutId()** **GetDutId(clientId, out dutId).** This command returns the DUT id of the current set-up.

**Parameters.**

| Parameter | Type   | Direction | Description  |
|-----------|--------|-----------|--|
| clientId  | string | IN        | Identifier of the client that is performing the remote function. clientId variable |
| dutId     | string | OUT       | The DUT id of the setup.   |

**Return value.** String value that indicates the status of the operation upon completion.

**Example.** `returnVal = remoteObject.GetDutId(clientId, out dutId);`

```
if ((OP_STATUS)returnVal == OP_STATUS.SUCCESS)
```

```
{
```

```
return id;
```

```
}
```

```
else
```

```
return CommandFailed(returnVal);
```

**Comments.** The dutId is an OUT parameter whose value is set after the server processes the request.

**Related command(s).** [SetDutId](#)

**GetPassFailStatus()** **GetPassFailStatus(clientId, device, suite, test).** This command gets the pass or fail status of the measurement after test completion.

---

**NOTE.** *Execute this command after completing the measurement.*

---

**Parameters.**

| Parameter | Type   | Direction | Description   |
|-----------|--------|-----------|---|
| clientId  | string | IN        | Identifier of the client that is performing the remote function.            |
| device    | string | IN        | Valid value is Source.  |
| suite     | string | IN        | Valid value is Source   |
| test      | string | IN        | Specifies the name of the test for which to obtain the pass or fail status. |

**Return value.** String value that indicates the status of the operation upon completion.

**Example.** `GetPassFailStatus(clientId, "Device", "Source", "Test 3.1_Eye diagram testing");`

**GetReportParameter()** **GetReportParameter(clientId, device, suite, test, parameterString).** This command gets the general report details such as oscilloscope model and TekExpress version.

**Parameters.**

| Parameter       | Type   | Direction | Description  |
|-----------------|--------|-----------|--|
| clientId        | string | IN        | Identifier of the client that is performing the remote function.   |
| device          | string | IN        | Specifies the DUT type (Device).   |
| suite           | string | IN        | Valid value is Source  |
| test            | string | IN        | Specifies the name of the test for which to obtain the pass or fail status.  |
| parameterString | string | IN        | Specifies to return the measured value for the indicated test. Enter "Scope Model", "TekExpress Version", or "Application Version" for this argument |

---

**NOTE.** *The Fail condition for this command occurs in the following conditions:*

*If the server is LOCKED the command returns "Server is locked by another client".*

*If the session is UNLOCKED the command returns "Lock Session to execute the command".*

*If the server is NOTFOUND the command returns "Server not found...Disconnect!".*

*If none of these fail conditions occur the command returns "Failed...".*

---

**Return value.** The return value is the connected oscilloscope model, TekExpress base software version, or DPTX application version.

**Example.** GetReportParameter(clientId, "Device", "Source", "", "Application Version")

**GetResultsValue()** **GetResultsValue(clientId, device, suite, test, parameterString)**. This command gets the result values of the specified measurement after the run.



**Parameters.**

| Parameter | Type   | Direction | Description  |
|-----------|--------|-----------|--|
| clientId  | string | IN        | Identifier of the client that is performing the remote function. |
| device    | string | IN        | Specifies the DUT type (Device).                                 |
| suite     | string | IN        | Valid value is Source  |

| Parameter | Type   | Direction | Description   |
|-----------|--------|-----------|---|
| test      | string | IN        | <p>Specifies the name of the test for which to obtain the test result value.</p> <p>"Test 3.1_Eye Diagram Testing"</p> <p>"Test 3.2_Non Pre-Emphasis Level Verification Testing"</p> <p>"Test 3.3_Pre-Emphasis Level Verification"</p> <p>"Test 3.4_Inter-Pair Skew Test" "Test 3.5_Intra-Pair Skew Test"</p> <p>"Test 3.10_AC Common Mode Noise Measurements"</p> <p>"Test 3.11_Non ISI Jitter Measurements"</p> <p>"Test 3.12.1_Total Jitter (TJ) Measurements"</p> <p>"Test 3.12.2_Random Jitter (RJ) Measurements"</p> <p>"Test 3.14_Main Link Frequency Compliance"</p> <p>"Test 3.15_Spread Spectrum Modulation Frequency"</p> <p>"Test 3.16_Spread Spectrum Modulation Deviation"</p> <p>"Test 3.17_dF/dt Spread Spectrum Deviation HF Variation"</p> <p>"Test 3.18_Dual-mode TMDS Clock"</p> <p>"Test 3.19_Dual-mode Eye Diagram Testing"</p> <p>"Test 8.1_AUX Manchester Channel EYE Test"</p> <p>"Test 8.2_AUX Manchester Channel Sensitivity Test"</p> <p>"Test 8.5_Inrush Test"</p> |

| Parameter       | Type   | Direction | Description   |
|-----------------|--------|-----------|---|
| parameterString | string | IN        | Specifies to return the measured value for the indicated test. Enter "Value" for this argument or one of the Column names |

---

**NOTE.** *The Fail condition for this command occurs in the following conditions:*

*If the server is LOCKED the command returns "Server is locked by another client".*

*If the session is UNLOCKED the command returns "Lock Session to execute the command".*

*If the server is NOTFOUND the command returns "Server not found...Disconnect!".*

*If none of these fail conditions occur the command returns "Failed...".*

---

**Return value.** String value that indicates the status of the operation upon completion. Returns the result value in the form of a string.

**Example.** `GetResultsValue(clientId, "Device", "Source", "Test 3.1_Eye diagram testing", "Value");`

## LockServer()

**LockServer(clientId).** This command locks the server. The client has to call this command before running any of the remote automations. The server is locked by only one client.

### Parameters.

| Parameter | Type   | Direction | Description  |
|-----------|--------|-----------|--|
| clientId  | string | IN        | Identifier of the client that is performing the remote function. clientId variable |

**Return value.** Returns the status of the operation upon completion.

```

Example. if (locked)
return "Server has already been locked!";
returnVal = remoteObject.LockServer(clientId);
if ((OP_STATUS)returnVal == OP_STATUS.SUCCESS)
{
locked = true;
return "Server Locked...";
}
    
```

**Comments.** When the client tries to lock a server that is locked by another client, the client gets a message that the server is already locked and it has to wait until the server is unlocked.

If the client locks the server and is idle for a certain amount of time, then the server is automatically unlocked from that client.

**Related command(s).** [UnlockSession](#)

## RecallSession()

**RecallSession(clientId,sessionName).** Recalls a saved session. The name of the session is provided by the client.

### Parameters.

| Parameter   | Type   | Direction | Description  |
|-------------|--------|-----------|--|
| clientId    | string | IN        | Identifier of the client that is performing the remote function. clientId variable |
| sessionName | string | IN        | The name of the session being recalled.  |

**Return value.** String that indicates the status of the operation upon completion.

```

Example. returnVal = remoteObject.RecallSession(clientId,sessionName);
if ((OP_STATUS)returnVal == OP_STATUS.SUCCESS)
return "Session Recalled...";
else
return CommandFailed(returnVal);
    
```

**Comments.** The name parameter cannot be empty. If it is empty, the client is prompted to provide a valid name.

**Related command(s).** [SaveSession](#)

[SaveSessionAs](#)

**Run()** **Run(clientId).** Runs the setup. Once the server is set up and configured, it can be run remotely using this function.

**Parameters.**

| Parameter | Type   | Direction | Description   |
|-----------|--------|-----------|---|
| clientId  | string | IN        | Identifier of the client that is connected to the server<br>clientId variable |

**Return value.** String that returns the status of the operation after completion.

```
Example. returnVal = remoteObject.Run(clientId);
if ((OP_STATUS)returnVal == OP_STATUS.SUCCESS)
return "Run started...";
else
return CommandFailed(returnVal);
```

**Comments.** When the run is performed the status of the run is updated periodically using a timer.

**SaveSession()** **SaveSession(clientId,sessionName).** Saves the current session. The name of the session is provided by the client.

**Parameters.**

| Parameter   | Type   | Direction | Description   |
|-------------|--------|-----------|---|
| clientId    | string | IN        | Identifier of the client that is connected to the server<br>clientId variable |
| sessionName | string | IN        | The name of the session being saved.  |

**Return value.** String that indicates the status of the operation upon completion.

```
Example. returnVal = remoteObject.SaveSession(clientId,sessionName);
if ((OP_STATUS)returnVal == OP_STATUS.SUCCESS)
return "Session Saved...";
else
return CommandFailed(returnVal);
```

**Comments.** The name parameter cannot be empty. If it is empty, the client is prompted to provide a valid name.

Once the session is saved under 'name,' you cannot use this command to save the session with a different name. Use SaveSessionAs to save the session to a new name.

**Related command(s).** [RecallSession](#)

[SaveSessionAs](#)

**SaveSessionAs()** **SaveSessionAs(clientId,sessionName).** Saves the current session in a different name every time this command is called. The name of the session is provided by the client.

**Parameters.**

| Parameter   | Type   | Direction | Description   |
|-------------|--------|-----------|---|
| clientId    | string | IN        | Identifier of the client that is connected to the server<br>clientId variable |
| sessionName | string | IN        | The name of the session being saved.  |

**Return value.** String that indicates the status of the operation upon completion.

**Example.** returnVal = remoteObject.SaveSessionAs(clientId,sessionName);

if ((OP\_STATUS)returnVal == OP\_STATUS.SUCCESS)

return "Session Saved...";

else

return CommandFailed(returnVal);

**Comments.** The same session is saved under different names using this command. The name parameter cannot be empty. If it is empty, the client is prompted to provide a valid name.

**Related command(s).** [RecallSession](#)

[SaveSession](#)

**SendResponse()** **SendResponse(clientID, WaitingMsbBxCaption, WaitingMsbBxMessage, WaitingMsbBxButtontexts).** After receiving the additional information using the command GetCurrentStateInfo(), the client can decide which response to send and then send the response to the application using this function. The response should be one of the strings that was received earlier as a string array in the GetCurrentStateInfo function. The \_caption and \_message should match the information received earlier in the GetCurrentStateInfo function.

---

**NOTE.** This command is used when the application is running and is in the wait or error state.

---

**Parameters.**

| Parameter              | Type         | Direction | Description   |
|------------------------|--------------|-----------|---|
| clientId               | string       | IN        | Identifier of the client that is connected to the server<br>clientId variable |
| WaitingMsBxCaption     | string       | OUT       | The wait state or error state message sent to you                             |
| WaitingMsBxMessage     | string       | OUT       | The wait state/error state message sent to you                                |
| WaitingMsBxButtontexts | string array | OUT       | An array of strings containing the possible response types that you can send  |

**clientId variable**

clientId is a user-defined variable that stores the client ID address information. Use the Connect() command to fill this variable:

```
clientId = ""
```

```
m_Client.Connect("localhost",out clientId)True or False
```

The clientId variable is stored until you call the Disconnect command.

---

**NOTE.** *The Fail condition for this command occurs in the following conditions:*

*If the server is LOCKED the command returns "Server is locked by another client".*

*If the session is UNLOCKED the command returns "Lock Session to execute the command".*

*If the server is NOTFOUND the command returns "Server not found...Disconnect!".*

*If none of these fail conditions occur the command returns "Failed...".*

---

**Return value.** This command does not return any value.

**Example.** m\_Client = new Client() //m\_Client is a reference to the Client class in the Client DLL

```
mClient.SendResponse(clientID, out WaitingMsBxCaption, out  
WaitingMsBxMessage, out WaitingMsBxButtontexts)
```

**Related command(s).** [ApplicationStatus](#)

[GetCurrentStateInfo](#)

**SelectDevice()** **SelectDevice(clientId, device, true).** This command selects the DUT type (Host or Device).

**Parameters.**

| Parameter | Type   | Direction | Description   |
|-----------|--------|-----------|---|
| clientId  | string | IN        | Identifier of the client that is connected to the server<br>clientId variable |
| device    | string | IN        | Specifies the DUT type ( <b>Device</b> )                                      |

**Return value.** String value that indicates the status of the operation upon completion.

**Example.** SelectDevice(clientId,"Device")

**SelectSuite()** **SelectSuite(clientId, device, suite, true).** This command selects one of the two suites: "Host to Module" or "Module to Host."

**Parameters.**

| Parameter | Type   | Direction | Description   |
|-----------|--------|-----------|---|
| clientId  | string | IN        | Identifier of the client that is connected to the server<br>clientId variable |
| device    | string | IN        | Specifies the DUT type ( <b>Device</b> )                                      |
| suite     | string | IN        | string with device connection type. Valid value is Source.                    |

**Return value.** String value that indicates the status of the operation upon completion.

**Example.** SelectSuite(clientId,"Device","Source",true);



**SelectTest()** **SelectTest(clientId, device, suite, test, true).** This command selects a test.

**Table 16: Parameters**

| Parameter | Type   | Direction | Description   |
|-----------|--------|-----------|---|
| clientId  | string | IN        | Identifier of the client that is connected to the server<br>clientId variable   |
| device    | string | IN        | Specifies the DUT type (Device).  |
| suite     | string | IN        | string with device connection type.<br>Valid value is Source.   |
| test      | string | IN        | Name of the DisplayPort test.<br>"Test 3.1_Eye Diagram Testing"<br>"Test 3.2_Non Pre-Emphasis Level Verification Testing"<br>"Test 3.3_Pre-Emphasis Level Verification Testing And Maximum Peak-to-Peak Differential Voltage Testing"<br>"Test 3.4_Inter-Pair Skew Test"<br>"Test 3.5_Intra-Pair Skew Test"<br>"Test 3.10_AC Common Mode Noise Measurements"<br>"Test 3.11_Non ISI Jitter Measurements"<br>"Test 3.12.1_Total Jitter (TJ) Measurements"<br>"Test 3.12.2_Random Jitter (RJ) Measurements"<br>"Test 3.14_Main Link Frequency Compliance"<br>"Test 3.15_Spread Spectrum Modulation Frequency"<br>"Test 3.16_Spread Spectrum Modulation Deviation"<br>"Test 3.17_dF/dt Spread Spectrum Deviation HF Variation"<br>"Test 3.18_Dual-mode TMDS Clock"<br>"Test 3.19_Dual-mode Eye Diagram Testing"<br>"Test 8.1_AUX Manchester Channel EYE Test"<br>"Test 8.2_AUX Manchester Channel Sensitivity Test"<br>"Test 8.5_Inrush Test" |

**Return value.** String value that indicates the status of the operation upon completion.

**Example.** `SelectTest(clientId, "Device", "Source", "Test 3.1_Eye diagram testing", true);`

**SetDutId()** **SetDutId(clientID,newDutId)**. This command changes the DUT ID of the setup. The client must provide a valid DUT ID.

**Parameters.**

| Parameter | Type   | Direction | Description   |
|-----------|--------|-----------|---|
| clientId  | string | IN        | Identifier of the client that is connected to the server<br>clientId variable |
| newDutId  | string | IN        | The new DUT ID of the setup.  |

**Return value.** String that gives the status of the operation after it was performed.

Return value is “DUT Id Changed” on success.

**Example.** `m_Client = new Client() //m_Client is a reference to the Client class in the Client DLL.`

returnval as string

`return=m_Client.SetDutId(clientID,desiredDutId)`

**Comments.**

**Related command(s).** [GetDutId](#)

**SetGeneralParameter()** **SetGeneralParameter(clientId, device, suite, "", paramString)**. This command sets the general parameter and its value based on the "paramString" argument values as listed.

TekExpress programmatic interface SetGeneralParameter()

**Parameters.**

| Parameter   | Type   | Direction | Description   |
|-------------|--------|-----------|---|
| clientId    | string | IN        | Identifier of the client that is connected to the server  |
| device      | string | IN        | Specifies the DUT type (Device)   |
| suite       | string | IN        | Valid value is Source   |
| paramString | string | IN        | Specifies to return the measured value for the indicated test. Enter “Value” for this argument or one of the Column names |

**Return value.** String value that indicates the status of the operation upon completion.

**List of available general parameters.** Appviewmode\$Compliance

Appviewmode\$Advanced

RBR\$Excluded

RBR\$Included

HBR\$Excluded

HBR\$Included

HBR2\$Excluded

HBR2\$Included

HBR3\$Excluded

HBR3\$Included

PreEmphasis-0dB\$Excluded

PreEmphasis-0dB\$Included

PreEmphasis-3.5dB\$Excluded

PreEmphasis-3.5dB\$Included

PreEmphasis-6dB\$Excluded

PreEmphasis-6dB\$Included

PreEmphasis-9.5dB\$Excluded

PreEmphasis-9.5dB\$Included

Voltage swing-400mV\$Excluded

Voltage swing-400mV\$Included

Voltage swing-600mV\$Excluded

Voltage swing-600mV\$Included

Voltage swing-800mV\$Excluded

Voltage swing-800mV\$Included

Voltage swing-1200mV\$Excluded

Voltage swing-1200mV\$Included

SSC\$SSC Enable

SSC\$SSC Disable

SSC\$Both

Link Widths\$1 Lane

Link Widths\$2 Lanes

Link Widths\$4 Lanes

Connector\$Standard

Connector\$Type C

DUT control\$DP AUX

DUT control\$DP AUX-Nvidia  
 DUT control\$DPR-100  
 DUT control\$Manual  
 Enable DeEmbed Filter\$Included  
 Enable DeEmbed Filter\$Excluded  
 Signal Validation\$Skip Pattern if signal fails  
 Signal Validation\$Use signal as is - Don't Check  
 Signal Validation\$Prompt me if signal fails

**Example.** SetGeneralParameter(clientId, "Device", "Source", "", "RBR \$Included")

**SetTimeout()** **SetTimeout(clientId, time).** Sets a timeout period specified by the client. After this timeout period expires, the server is unlocked automatically.

**Parameters.**

| Parameter | Type   | Direction | Description  |
|-----------|--------|-----------|--|
| clientId  | string | IN        | Identifier of the client that is connected to the server |
| time      | string | IN        | The time in seconds that refers to the timeout period    |

**Return Value.** String value that indicates the status of the operation upon completion. On success the return value is “TimeOut Period Changed”.

---

**NOTE.** *The Fail condition for this command occurs in the following conditions:*

*If the server is LOCKED the command returns "Server is locked by another client".*

*If the session is UNLOCKED the command returns "Lock Session to execute the command".*

*If the server is NOTFOUND the command returns "Server not found...Disconnect!".*

*If none of these fail conditions occur the command returns "Failed...".*

---

**Example.** m\_Client = new Client() //m\_Client is a reference to the Client class in the Client DLL. returnval as string returnval=m\_Client.SetTimeout(clientID, time)

**Related command(s).** [setTimeOut\(\)](#)

TekExpress programmatic interface setVerboseMode()

**SetVerboseMode()** **setVerboseMode(clientId, verboseMode).** This command sets the verbose mode to either true or false.

When the value is set to true, any message boxes that appear during the application are routed to the client machine that is controlling TekExpress.

When the value is set to false, all the message boxes are shown on the server machine.

**Parameters.**

| Parameter   | Type    | Direction | Description   |
|-------------|---------|-----------|---|
| clientId    | string  | IN        | Identifier of the client that is connected to the server<br>clientId variable |
| verboseMode | boolean | IN        | Sets the verbose mode to be turned ON (true) or OFF (false).                  |

**Return value.** String that gives the status of the operation after it was performed.  
Returnval as string

When Verbose mode is set to true, the return value is “Verbose mode turned on. All dialog boxes will be shown to client”.

When Verbose mode is set to false, the return value is “Verbose mode turned off. All dialog boxes will be shown to server”.

---

**NOTE.** *The Fail condition for this command occurs in the following conditions:*

*If the server is LOCKED the command returns "Server is locked by another client".*

*If the session is UNLOCKED the command returns "Lock Session to execute the command".*

*If the server is NOTFOUND the command returns "Server not found...Disconnect!".*

*If none of these fail conditions occur the command returns "Failed...".*

---

**Example.** `m_Client = new Client()` //m\_Client is a reference to the Client class in the Client DLL.

**Turn on verbose mode:**

`return=m_Client.SetVerboseMode(clientId, true)`

**Turn off verbose mode:**

`returnval=m_Client.SetVerboseMode(clientId, false)`

**Status()** **Status(clientId, out statusMessages).** This command gives the status of the run as messages. The status messages are generated once the run is started.

**Parameters.**

| Parameter     | Type   | Direction | Description  |
|---------------|--------|-----------|--|
| clientId      | string | IN        | Identifier of the client that is connected to the server |
| statusMessage | string | array OUT | The list of status messages generated during run.        |

**Return value.** String that indicates the status of the operation upon completion.

**Example.** returnVal = remoteObject.QueryStatus(clientId, out statusMessages);  
 if ((OP\_STATUS)returnVal == OP\_STATUS.SUCCESS)  
 return "Status updated...";  
 else  
 return CommandFailed(returnVal);

**Comments.** The status messages are updated periodically after the run begins. The status is an out parameter which is set when the server processes the request.

**Related command(s).** ApplicationStatus (see page) TekExpress programmatic interface Stop()

**Stop()** **Stop(clientId).** Stops the run operation.

**Parameters.**

| Parameter | Type   | Direction | Description   |
|-----------|--------|-----------|---|
| clientId  | string | IN        | Identifier of the client that is connected to the server<br>clientId variable |

**Return value.** String that indicates the status of the operation upon completion.

**Example.** returnVal = remoteObject.Stop(clientId);  
 if ((OP\_STATUS)returnVal == OP\_STATUS.SUCCESS)  
 return "Stopped...";  
 else  
 return CommandFailed(returnVal);

**Comments.** When the session is stopped the client is prompted to stop the session and is stopped at the consent.

**UnlockServer()** **UnlockServer(clientId)**. This command unlocks the server from the client. The client id of the client to be unlocked has to be provided.

**Parameters.**

| Parameter | Type   | Direction | Description   |
|-----------|--------|-----------|---|
| clientId  | string | IN        | Identifier of the client that is connected to the server<br>clientId variable |

**clientId variable**

clientId is a user-defined variable that stores the client ID address information. Use the Connect() command to fill this variable:

```
clientId = ""
```

```
m_Client.Connect("localhost",out clientId)True or False
```

The clientId variable is stored until you call the Disconnect command.

**Return value.** String that indicates the status of the operation upon completion.

```
Example. returnVal = remoteObject.UnlockServer(clientId);
if ((OP_STATUS)returnVal == OP_STATUS.SUCCESS)
{
locked = false;
return "Server UnLocked...";
}
```

**Comments.** When the client is disconnected, it is automatically unlocked.

**Related commands.** [LockSession](#)

**Handle error codes**

The return value of the remote automations at the server-end is OP\_STATUS, which changes to a string value depending on its code, and returned to the client. The values of OP\_STATUS are as follows:

| Code | Value     | Description  |
|------|-----------|--|
| -1   | FAIL      | The operation failed   |
| 1    | SUCCESS   | The operation succeeded  |
| 2    | NOT FOUND | Server not found   |
| 3    | LOCKED    | The server is locked by another client, so the operation cannot be performed |

| Code | Value  | Description   |
|------|--------|---|
| 4    | UNLOCK | The server is not locked; lock the server before performing the operation |
| 5    | NULL   | Nothing   |

---

**NOTE.** *The Fail condition for this command occurs in the following conditions:*

*If the server is LOCKED the command returns "Server is locked by another client".*

*If the session is UNLOCKED the command returns "Lock Session to execute the command".*

*If the server is NOTFOUND the command returns "Server not found...Disconnect!".*

*If none of these fail conditions occur the command returns "Failed...".*

---

### SetComplianceMode()

**SetComplianceMode(clientId, Mode).** This command sets the mode to user defined mode.

#### Parameters.

| Parameter | Type   | Direction | Description  |
|-----------|--------|-----------|--|
| clientId  | string | IN        | Identifier of the client that is connected to the server |
| Mode      | string | IN        | Sets the mode to be tuned 'User-defined' or 'compliance' |

**Example.** Setting mode to user defined:

```
remoteClientObj.SetComplianceMode(id[1],"User-Defined")
```

Setting mode to Compliance:

```
remoteClientObj.SetComplianceMode(id[1],"Compliance")
```

After setting compliance mode, SetAcquireParameter() and SetAnalyzeParameter() commands can be used to set user defined values.



**SetAcquireParameter()** **SetAcquireParameter(string clientID, string device, string suite, string test, string parameterString)**. This method sets the parameter values in the Scope Settings tabs in the test configuration section.

**Parameters.**

| Parameter       | Type   | Direction | Description  |
|-----------------|--------|-----------|--|
| clientId        | string | IN        | Identifier of the client that is connected to the server.          |
| device          | string | IN        | Specifies the name of the device.                                  |
| suite           | string | IN        | Specifies the name of the suite.                                   |
| test            | string | IN        | Specifies the name of the test to obtain the pass or fail status . |
| parameterString | string | IN        | Selects or deselects a test.                                       |

**Return value.** String that displays the status of the operation after it has been performed.

The return value is " " (an empty string) on success.

**Example.** Here parameterString is "Acquire\_Type\$parName\$Parvalue"

```
returnval = remoteClientObj.SetAcquireParameter(id[1], device, suite," Test
3.1_Eye diagram testing"," PRBS7$Sample Rate (GS/s)$25")
```

**List of Acquire parameter.** PRBS7\$RBR:Sample Rate(GS/s)\$50  
PRBS7\$HBR:Sample Rate(GS/s)\$50  
PRBS7\$HBR2:Sample Rate(GS/s)\$50  
PRBS7\$HBR3:Sample Rate(GS/s)\$50  
PRBS7\$RBR:Record Length(M)\$20  
PRBS7\$HBR:Record Length(M)\$20  
PRBS7\$HBR2:Record Length(M)\$20  
PRBS7\$HBR3:Record Length(M)\$20  
D10.2\$RBR:Sample Rate(GS/s)\$50  
D10.2\$HBR:Sample Rate(GS/s)\$50  
D10.2\$HBR2:Sample Rate(GS/s)\$50  
D10.2\$HBR3:Sample Rate(GS/s)\$50  
D10.2\$RBR:Record Length(M)\$20  
D10.2\$HBR:Record Length(M)\$20  
D10.2\$HBR2:Record Length(M)\$20  
D10.2\$HBR3:Record Length(M)\$20  
TMDS Clock\$Record Length (M)\$5  
TMDS Clock\$Sample rate (GS/s)\$50  
TMDS Clock\$Edge trigger slope\$Positive  
TMDS EyeDiagram\$Record Length (M)\$5  
TMDS EyeDiagram\$Sample rate (GS/s)\$50  
TMDS EyeDiagram\$Edge trigger slope\$Positive  
Aux EyeDiagram\$Record Length (M)\$2  
Aux EyeDiagram\$Sample rate (GS/s)\$50  
Aux EyeDiagram\$ Edge trigger slope\$Positive  
Inrush\$Record Length (M)\$2.5  
Inrush\$hSample rate (GS/s)\$50

**SetAnalyzeParameter()** **SetAnalyzeParameter(string clientID, string device, string suite, string test, string parameterString)**. This method sets the parameter values in the Ref Levels and Clock Settings tabs in the test configuration section.

**Parameters.**

| Parameter       | Type   | Direction | Description  |
|-----------------|--------|-----------|--|
| clientId        | string | IN        | Identifier of the client that is connected to the server.          |
| device          | string | IN        | Specifies the name of the device.                                  |
| suite           | string | IN        | Specifies the name of the suite.                                   |
| test            | string | IN        | Specifies the name of the test to obtain the pass or fail status . |
| parameterString | string | IN        | Selects or deselects a test.                                       |

**Return value.** String that displays the status of the operation after it has been performed.

The return value is " " (an empty string) on success.

**Example.** Here parameterString is "parName\$Parvalue"

```
returnval = remoteClientObj.SetAnalyzeParameter(id[1],device,suite," Test
3.1_Eye diagram testing", "Clock recovery method$PLL-Custom BW")
```

**List of Analyze parameter.** PRBS7\$Clock recovery method\$Constant Clock-Mean  
PRBS7\$Signal Type\$CLOCK  
PRBS7\$PLL Model Type\$ONE  
PRBS7\$RBR Damping (m)\$1510  
PRBS7\$RBR Loop bandwidth (MHz)\$5.4  
PRBS7\$HBR Damping (m)\$1510  
PRBS7\$HBR Loop bandwidth (MHz)\$10  
PRBS7\$HBR2 Damping (m)\$1000  
PRBS7\$HBR2 Loop bandwidth (MHz)\$10  
PRBS7\$HBR3 Damping (m)\$1000  
PRBS7\$HBR3 Loop bandwidth (MHz)\$10  
PRBS7\$Ref Levels Autoset Basetop Method\$MINMAX  
PRBS7\$Ref levels\$Absolute  
PRBS7\$Mid level\$-10  
PRBS7\$Hysteresis\$-2  
D10.2\$Clock recovery method\$Constant Clock-Mean  
D10.2\$Signal Type\$CLOCK  
D10.2\$PLL Model Type\$ONE  
D10.2\$RBR Damping (m)\$1510  
D10.2\$RBR Loop bandwidth (MHz)\$5.4  
D10.2\$HBR Damping (m)\$1510  
D10.2\$HBR Loop bandwidth (MHz)\$10  
D10.2\$HBR2 Damping (m)\$1000  
D10.2\$HBR2 Loop bandwidth (MHz)\$10  
D10.2\$HBR3 Damping (m)\$1000  
D10.2\$HBR3 Loop bandwidth (MHz)\$10  
D10.2\$Ref Levels Autoset Basetop Method\$MINMAX  
D10.2\$Ref levels\$Absolute  
D10.2\$Mid level\$-10  
D10.2\$Hysteresis\$-2  
TMDS Clock\$Signal Type\$CLOCK  
TMDS Clock\$Clock Edge\$RISE  
TMDS Clock\$Clock recovery method\$PLL-Custom BW

**TransferImages()** **TransferImages(clientId, filePath).** This command transfers all the images (screen shots) to the specified client and folder (directory from the current run).

**Parameters.**

| Parameter | Type   | Direction | Description  |
|-----------|--------|-----------|--|
| clientId  | string | IN        | Identifier of the client that is connected to the server.<br>clientId variable |
| filePath  | string | IN        | Enclose the path in quotes   |

**Return Value.** String value that indicates the status of the operation upon completion.

Transfers all the images in the form of a string.

**Example.** Images = remoteClientObj.TransferImages(id[1], "C:\\Images")

**GetResultsValueForSubMeasurements()** **GetResultsValueForSubMeasurements(string clientID, string device, string suite, string test, string parameterString, int rowNr).** This method gets the result values for individual submeasurements after the run.

**Parameters.**

| Parameter       | Type   | Direction | Description   |
|-----------------|--------|-----------|---|
| clientId        | string | IN        | Identifier of the client that is connected to the server.                                   |
| device          | string | IN        | Specifies the name of the device  |
| suite           | string | IN        | Specifies the name of the suite.  |
| test            | string | IN        | Specifies the name of the test to obtain the pass or fail status.                           |
| parameterString | string | IN        | ParameterString string<br>IN Specifies to return the measured value for the indicated test. |
| int rowNr       | int    | IN        | The last parameter accepts the row number of table for that particular test.                |

**Return Value.** String that gives the status of the operation after it has been performed .

Returns the result value in the form of a string.

**Example.** resultsValue\_sub =  
 remoteClientObj.GetResultsValueForSubMeasurements(id[1],device,suite,measurement,"Value",2)

**TransferResult()** **TransferResult(clientId, logDirname).** This command transfers the report generated after the run to the specified folder (directory). The report contains the summary of the run. The client has to use this command before the saved session command. The client has to provide the location where the report is to be saved at the client-end.

**Parameters.**

| Parameter  | Type   | Direction | Description  |
|------------|--------|-----------|--|
| clientId   | string | IN        | Identifier of the client that is connected to the server<br>clientId variable                  |
| logDirname | string | IN        | Path to the target folder to which to transfer the report file.<br>Enclose the path in quotes. |

**Return Value.** String that gives the status of the operation after it has been performed

Transfers all the result values in the form of a string.

**Example.** reports = remoteClientObj.TransferResult(id[1],"C:\\reports ")

Examples script files are present in installation directory. Refer the following path for accessing the examples, **C:\Program Files\Tektronix\TekExpress\TekExpress DisplayPortTx\Examples.**

# SCPI commands

## About SCPI command

You can use Standard Commands for Programmable Instruments (SCPI) to communicate with the TekExpress application.

## Socket configuration for SCPI commands

This section describes the steps for TCP/IP socket configuration and TekVISA configuration to execute the SCPI commands.

### TCP/IP socket configuration

1. Click **Start > Control Panel > System and Security > Windows Firewall > Advanced settings**

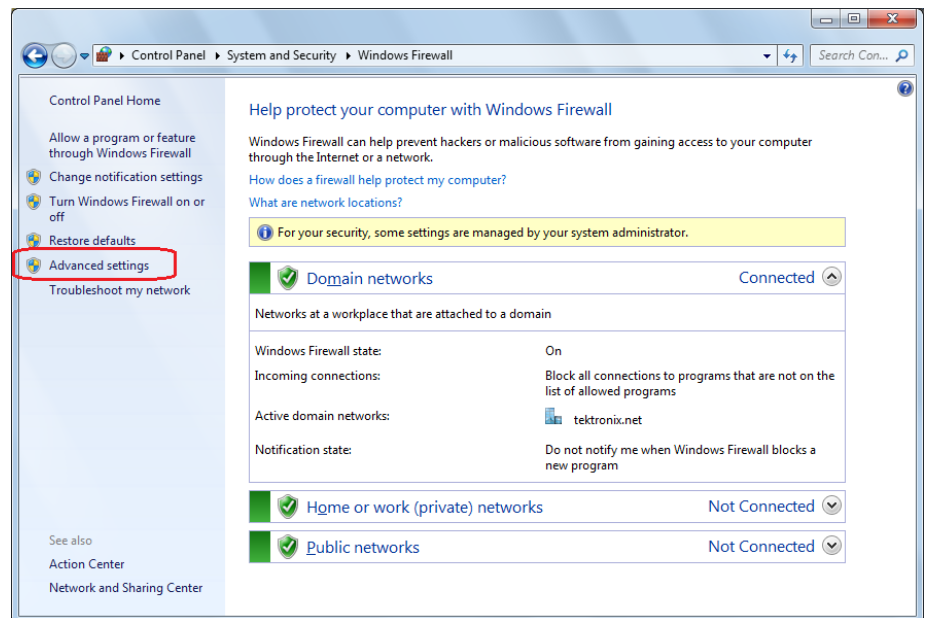

2. In Windows Firewall with Advanced Security menu, select **Windows Firewall with Advanced Security on Local Computer > Inbound Rules** and click **New Rule...**

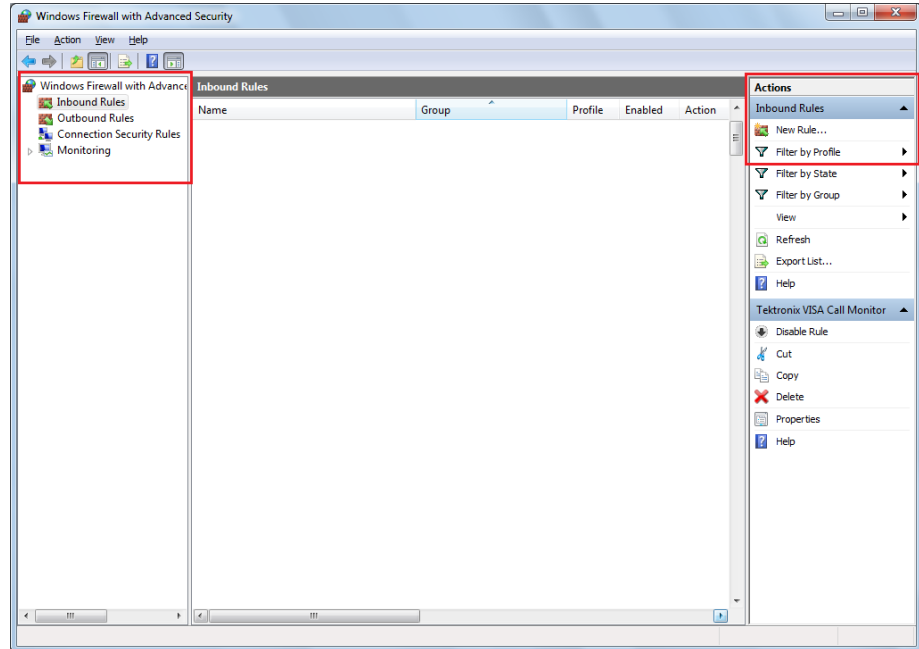

3. In New Inbound Rule Wizard menu
  - a. Select **Port** and click **Next**

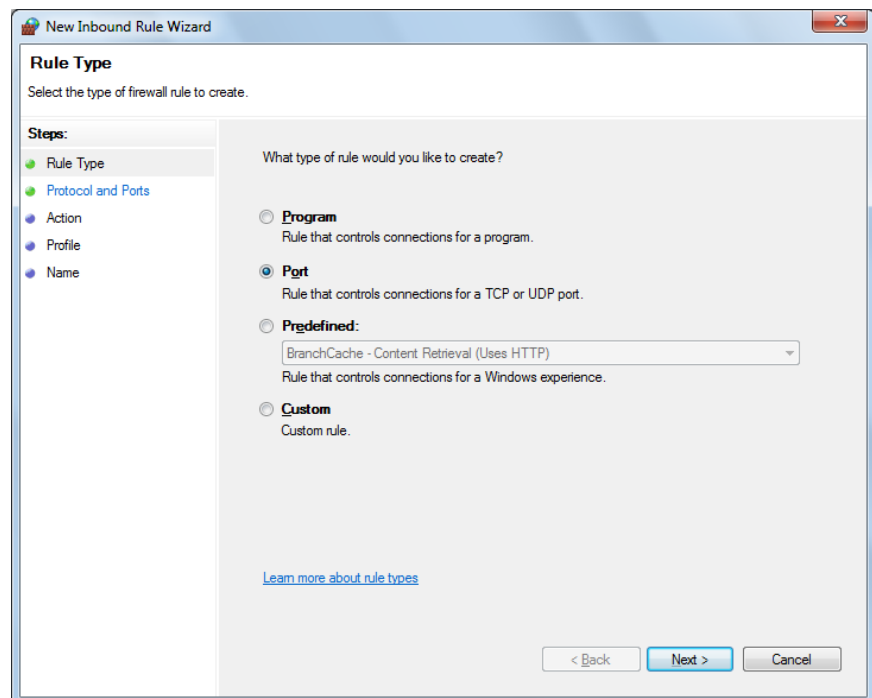



- b. Select **TCP** as rule apply and enter 5000 for **Specific local ports** and click **Next**

The screenshot shows the 'New Inbound Rule Wizard' dialog box, specifically the 'Protocol and Ports' step. The title bar reads 'New Inbound Rule Wizard'. The main heading is 'Protocol and Ports' with the instruction 'Specify the protocols and ports to which this rule applies.' On the left, a 'Steps:' pane lists 'Rule Type', 'Protocol and Ports', 'Action', 'Profile', and 'Name', with 'Protocol and Ports' selected. The main area contains two questions: 'Does this rule apply to TCP or UDP?' with radio buttons for 'TCP' (selected) and 'UDP'; and 'Does this rule apply to all local ports or specific local ports?' with radio buttons for 'All local ports' and 'Specific local ports:' (selected). A text box next to 'Specific local ports:' contains '5000' and an example '80, 443, 5000-5010' is shown below. A link 'Learn more about protocol and ports' is at the bottom. Navigation buttons '< Back', 'Next >', and 'Cancel' are at the bottom right.

- c. Select **Allow the connection** and click **Next**

The screenshot shows the 'New Inbound Rule Wizard' dialog box, specifically the 'Action' step. The title bar reads 'New Inbound Rule Wizard'. The main heading is 'Action' with the instruction 'Specify the action to be taken when a connection matches the conditions specified in the rule.' On the left, a 'Steps:' pane lists 'Rule Type', 'Protocol and Ports', 'Action', 'Profile', and 'Name', with 'Action' selected. The main area contains the question 'What action should be taken when a connection matches the specified conditions?' with three radio button options: 'Allow the connection' (selected), 'Allow the connection if it is secure', and 'Block the connection'. Descriptions are provided for each option. A 'Customize...' button is next to the 'Allow the connection if it is secure' option. A link 'Learn more about actions' is at the bottom. Navigation buttons '< Back', 'Next >', and 'Cancel' are at the bottom right.

d. Select **Domain**, **Private**, **Public** and click **Next**

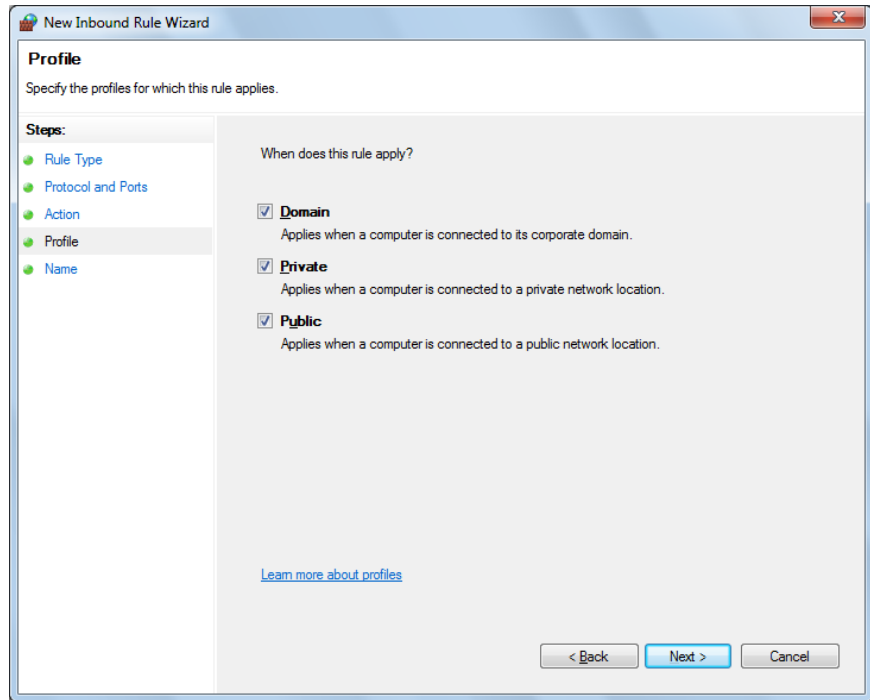

e. Enter **Name**, Description (optional), and click **Finish**

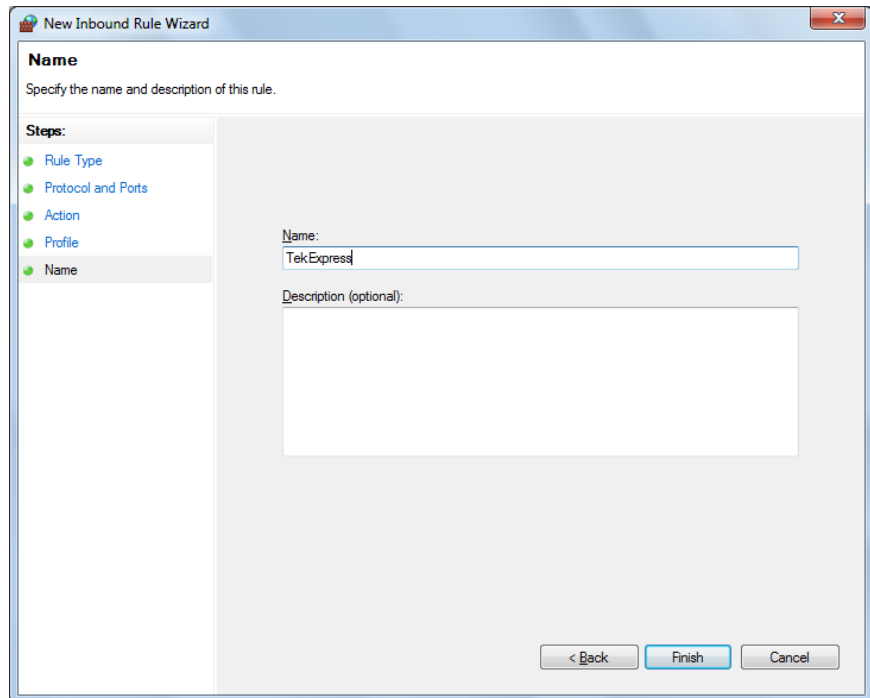

4. Check whether the Rule name is displayed in **Windows Firewall with Advanced Security** menu > **Inbound Rules**

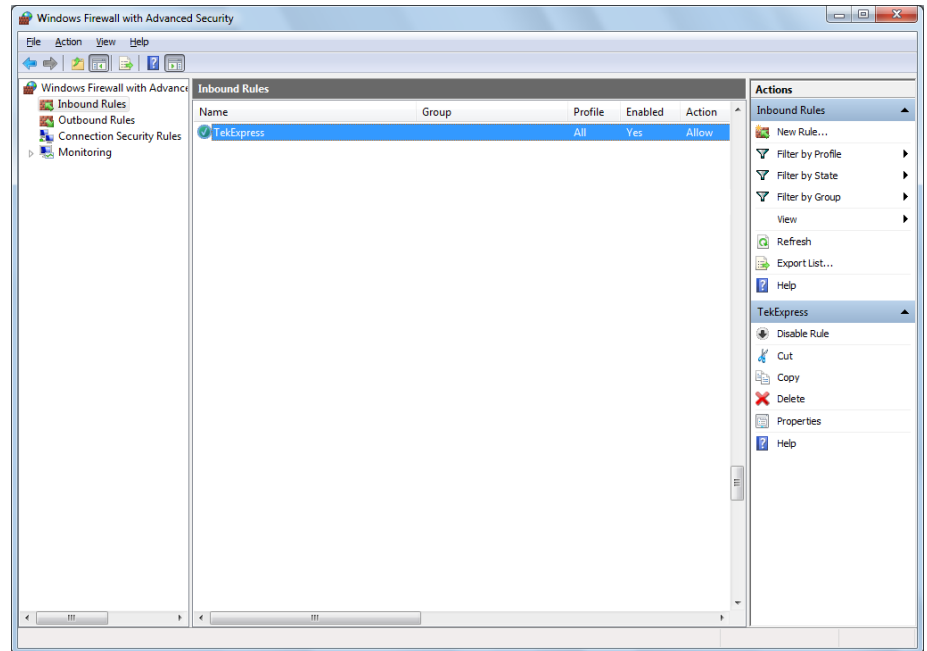

- TekVISA configuration**    1. Click **Start > All Programs > TekVISA > OpenChoice Instrument Manager**

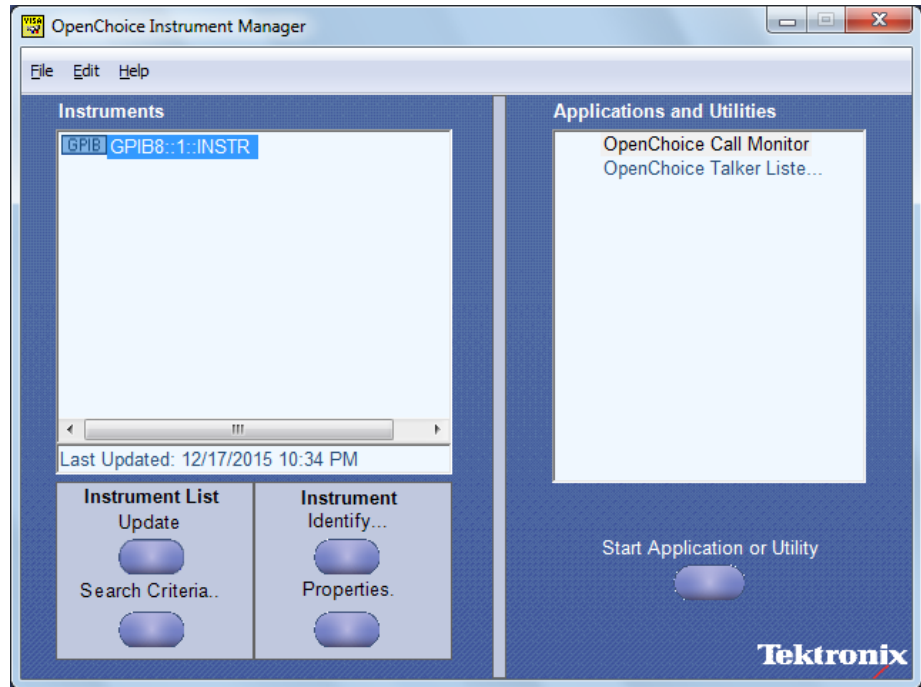

2. Click **Search Criteria**. In Search Criteria menu, click **LAN** to Turn-on. Select **Socket** from the drop-down list, enter the IP address of the

TekExpress device in **Hostname** and type **Port** as 5000. Click  to configure the IP address with Port.

Enter the Hostname as 127.0.0.1 if the TekVISA and TekExpress application are in the same system, else enter the IP address of the TekExpress application system.

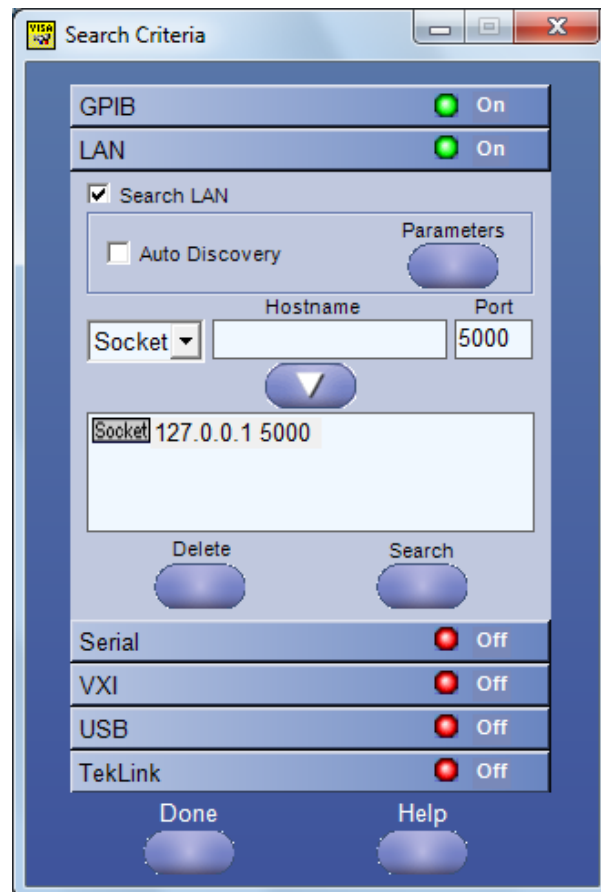

- Click **Search** to setup the TCPIP connection with the host. Check whether the TCPIP host name is displayed in **OpenChoice Instrument Manager > Instruments**

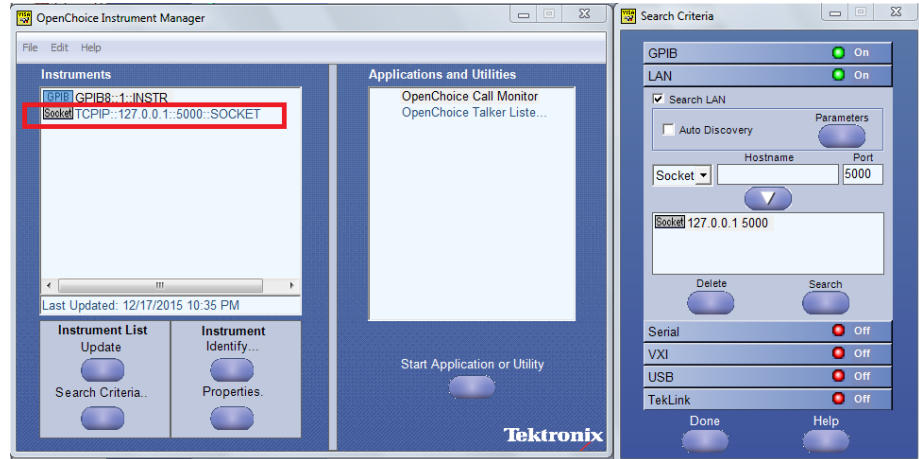

- Double-click **OpenChoice Takler Listener** and enter the Command **\*IDN?** in command entry field and click **Query**. Check that the Operation is successful and Talker Listener Readout displays the Command / Data.

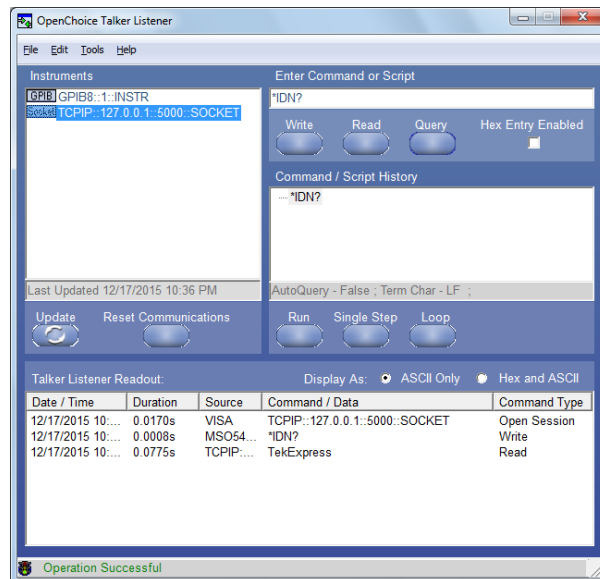

## TEKEXP:\*IDN?

This command queries the active TekExpress application name running on the scope.

**Syntax**    TEKEXP:\*IDN?\n

**Inputs**    NA

**Outputs**    Returns active TekExpress application name running on the scope



---

**TIP.** [Click here](#) for examples.

---

## TEKEXP:\*OPC?

This command queries the execution status of the last executed command.

**Syntax**    TEKEXP:\*OPC?\n

**Inputs**    NA

**Outputs**    0 - last command execution is not complete  
1 - last command execution is complete



---

**TIP.** [Click here](#) for examples.

---

## TEKEXP:ACQUIRE\_MODE

This command sets the acquire mode as live or pre-recorded.

**Syntax**    `TEKEXP:ACQUIRE_MODE {LIVE | PRE-RECORDED}\n`

**Inputs**    `{LIVE | PRE-RECORDED}`

**Outputs**    NA



**TIP.** *[Click here](#) for examples.*

---

## TEKEXP:ACQUIRE\_MODE?

This command queries the acquire mode type.

**Syntax**    `TEKEXP:ACQUIRE_MODE?\n`

**Inputs**    NA

**Outputs**    `{LIVE | PRE-RECORDED}`



**TIP.** *[Click here](#) for examples.*

---



## TEKEXP:EXPORT

This command returns all the bytes of data to the specified file.

| Syntax                             | Outputs                                      |
|------------------------------------|--|
| TEKEXP:EXPORT REPORT\n             | Returns the report file in bytes             |
| TEKEXP:EXPORT WFM,"<FileName>"\n   | Returns the specified waveform file in bytes |
| TEKEXP:EXPORT IMAGE,"<FileName>"\n | Returns the specified image file in bytes    |

**Inputs** FileName - Specifies the file name



**TIP.** [Click here](#) for examples.

## TEKEXP:INFO?

This command queries the information about the file(s).

| Syntax                | Outputs   |
|-----------------------|---|
| TEKEXP:INFO? REPORT\n | <ReportFileSize>,"<ReportFileName.mht>"                                       |
| TEKEXP:INFO? WFM\n    | <WfmFile1Size>,"<WfmFileName1.wfm>" ;<WfmFile2Size>,"<WfmFileName2.wfm>" ;... |
| TEKEXP:INFO? IMAGE\n  | <Image1FileSize>,"<Image1FileName>" ;<Image2FileSize>,"<Image2FileName>" ;... |



**TIP.** [Click here](#) for examples.

## TEKEXP:INSTRUMENT

This command sets the value for the selected instrument type.

**Syntax**    `TEKEXP:INSTRUMENT "<InstrumentType>",<Value>"\n`

**Inputs**    InstrumentType  
               Value



---

**TIP.** Check [Command parameters list](#) for *InstrumentType* and *Value* parameters.

---

**Outputs**    NA



---

**TIP.** [Click here](#) for examples.

---

## TEKEXP:INSTRUMENT?

This command queries the instrument selected for the specified instrument type.

**Syntax**    `TEKEXP:INSTRUMENT? "<InstrumentType>"\n`

**Inputs**    InstrumentType



---

**TIP.** Check [Command parameters list](#) for *InstrumentType* parameters.

---

**Outputs** Returns the instrument selected for the specified instrument type



**TIP.** [Click here for examples.](#)

## TEKEXP:LASTERROR?

This command queries the last error string occurred for the current TCP session. If there are no errors since startup, or since the last call to TEKEXP:LASTERROR?\n, this command returns an empty string.

**Syntax** TEKEXP:LASTERROR?\n

**Inputs** NA

**Outputs** <string>



**TIP.** [Click here for examples.](#)

## TEKEXP:LIST?

This command queries the list of available device, suite, test, version or instrument.

| Syntax                                      | Outputs   |
|---|---|
| TEKEXP:LIST? DEVICE\n                       | Returns the list of available device(s) as comma separated values.                                  |
| TEKEXP:LIST? SUITE\n                        | Returns the list of available suite(s) as comma separated values.                                   |
| TEKEXP:LIST? TEST\n                         | Returns the list of available test(s) as comma separated values.                                    |
| TEKEXP:LIST? VERSION\n                      | Returns the list of available version(s) as comma separated values.                                 |
| TEKEXP:LIST? INSTRUMENT,"<InstrumentType>\n | Returns the list of available instruments' for the given Instrument type as comma separated values. |

---

**NOTE.** This command returns the list of items within double quotes (""). Iterate the receive procedure until the list ends with double quotes otherwise the next query commands won't work as expected.

---

**Inputs** InstrumentType



---

**TIP.** Check [Command parameters list](#) for InstrumentType parameters.

---



---

**TIP.** [Click here](#) for examples.

---

## TEKEXP:MODE

This command sets the execution mode as compliance or user defined.

**Syntax** TEKEXP:MODE {COMPLIANCE | USER-DEFINED}\n

**Inputs** {COMPLIANCE | USER-DEFINED}

**Outputs** NA



---

**TIP.** [Click here](#) for examples.

---

## TEKEXP:MODE?

This command queries the execution mode type.

**Syntax**    `TEKEXP:MODE?\n`

**Inputs**    NA

**Outputs**    {COMPLIANCE | USER-DEFINED}



---

**TIP.** [Click here](#) for examples.

---

## TEKEXP:POPUP

This command sets the response to the active popup shown in the application.

**Syntax**    `TEKEXP:POPUP "<PopupResponse>"\n`

**Inputs**    PopupResponse

**Outputs**    NA



---

**TIP.** [Click here](#) for examples.

---

## TEKEXP:POPUP?

This command queries the active popup information shown in the application.

**Syntax**    `TEKEXP:POPUP?\n`

**Inputs**    NA

**Outputs**    Returns the active popup information in the application.



---

**TIP.** [Click here](#) for examples.

---

## TEKEXP:REPORT

This command generates the report for the current session.

**Syntax**    `TEKEXP:REPORT GENERATE\n`

**Inputs**    GENERATE

**Outputs**    NA



---

**TIP.** [Click here](#) for examples.

---

## TEKEXP:REPORT?

This command queries the queried header field value in the report.

**Syntax**    `TEKEXP:REPORT? "<HeaderField>"\n`

**Inputs**    HeaderField - Specifies to return the measured value for the indicated test.



**TIP.** Check **Report** for HeaderField parameters.

**Outputs**    Returns the queried header field value in the report



**TIP.** [Click here](#) for examples.

## TEKEXP:RESULT?

This command queries the result available in report summary/details table.

| Syntax  | Outputs  |
|---|--|
| <code>TEKEXP:RESULT? "&lt;TestName&gt;"\n</code>  | Return Pass/Fail status of the test.                               |
| <code>TEKEXP:RESULT? "&lt;TestName&gt;","&lt;ColumnName&gt;"\n</code>                   | Returns all the row values of the specified column for the test.   |
| <code>TEKEXP:RESULT? "&lt;TestName&gt;","&lt;ColumnName&gt;",&lt;RowNumber&gt;\n</code> | Returns the column value for the specified row number <sup>1</sup> |

<sup>1</sup> Row number starts from zero.

- Inputs**
- TestName - Specifies the name of the test for which to obtain the test result value.
  - ColumnName - Specifies the column name for the measurement
  - RowNumber - Specifies the row number of the measurement

---

 **TIP.** Check **Results** panel for TestName, ColumnName, and RowNumber parameters.

---

 **TIP.** [Click here](#) for examples.

---

## TEKEXP:SELECT

This command selects the device, suite, version, or test.

**Syntax**

```
TEKEXP:SELECT <string1>,<string2>,<string4>\n
TEKEXP:SELECT TEST,<string3>,<string4>\n
```

**Inputs**

- <string1> = {DEVICE | SUITE | VERSION}
- <string2> = {DeviceName | SuiteName | VersionName}
- <string3> = {"<TestName>" | ALL | REQUIRED }
- <string4> = {TRUE | FALSE}

---

 **TIP.** Check [Command parameters list](#) for DeviceName, SuiteName, VersionName, and TestName parameters.

---

 **TIP.** [Click here](#) for examples.

---



**Outputs** NA

## TEKEXP:SELECT?

This command queries the name of the selected device, suite, version, or test.

**Syntax** TEKEXP:SELECT? {DEVICE | SUITE | TEST | VERSION}\n

**Inputs** {DEVICE | SUITE | TEST | VERSION}

**Outputs** Returns the name of the selected device, suite, version, or test.



**TIP.** [Click here](#) for examples.

## TEKEXP:SETUP

This command sets the value of the current setup.

| Syntax                              | Outputs                  |
|-------------------------------------|--------------------------|
| TEKEXP:SETUP DEFAULT\n              | Restore to default Setup |
| TEKEXP:SETUP OPEN,"<SessionName>"\n | Open the session         |
| TEKEXP:SETUP SAVE\n                 | Save the session         |
| TEKEXP:SETUP SAVE,"<SessionName>"\n | Save the session         |

**Inputs** SessionName - The name of the session



**TIP.** [Click here](#) for examples.

## TEKEXP:STATE

This command sets the execution state of the application.

**Syntax**    `TEKEXP:STATE {RUN | STOP | PAUSE | RESUME}\n`

**Inputs**    `{RUN | STOP | PAUSE | RESUME}`

**Outputs**    NA



---

**TIP.** [Click here](#) for examples.

---

## TEKEXP:STATE?

This command queries the current setup state.

| Syntax              | Outputs  |
|---------------------|--|
| TEKEXP:STATE?       | RUNNING   PAUSED   WAIT   ERROR   READY<br>  STOPPED |
| TEKEXP:STATE? SETUP | SAVED   NOT_SAVED                                    |



---

**TIP.** [Click here](#) for examples.

---

## TEKEXP:VALUE

This command sets the value of parameters of type General, Acquire, Analyze, or DUTID.

**Syntax**

```
TEKEXP:VALUE GENERAL,"<ParameterName>","<Value>"\n
TEKEXP:VALUE ACQUIRE,"<TestName>","<AcquireType>","
<ParameterName>","<Value>"\n
TEKEXP:VALUE ANALYZE,"<TestName>","<ParameterName>". "<Value>"
\n
TEKEXP:VALUE DUTID,"<Value>"\n
```

**Inputs**

- ParameterName - Specifies the parameter name
- TestName - Specifies the test name
- AcquireType - Specifies the acquire type
- Value - Specifies the value to set



---

**TIP.** Check [Command parameters list](#) for ParameterName, AcquireType, and Value parameters.

---

**Outputs** NA



---

**TIP.** [Click here](#) for examples.

---

## TEKEXP:VALUE?

This command queries the value of the parameter for type General, Acquire, Analyze, or DUTID.

| Syntax   | Outputs  |
|--|--|
| TEKEXP:VALUE?<br>GENERAL,"<ParameterName>"\n                               | Returns the value of Parameter for type<br>GENERAL |
| TEKEXP:VALUE? ACQUIRE,"<TestName>",<br>"<AcquireType>","<ParameterName>"\n | Returns the value of Parameter for type<br>ACQUIRE |
| TEKEXP:VALUE? ANALYZE,<br>"<TestName>","<ParameterName>"\n                 | Returns the value of Parameter for type<br>ANALYZE |
| TEKEXP:VALUE? DUTID\n  | Returns the DUTID value                            |

**Inputs**

- ParameterName - Specifies the parameter name
- TestName - Specifies the test name
- AcquireType - Specifies the acquire type



**TIP.** Check [Command parameters list](#) for ParameterName and AcquireType parameters.

**Outputs**

Returns the value of Parameter for type GENERAL | ACQUIRE | ANALYZE | DUTID.



**TIP.** [Click here](#) for examples.

## Command parameters list

This section provides the parameters list for the SCPI commands.

### TekExpress DisplayPort Tx command parameters

#### ParameterName and Value for DUT, Test selection, Acquisition, Configuration and Preferences tabs

Specifies the ParameterName and Value for DUT, Test selection, Acquisition, Configuration and Preferences tabs

**Table 17: ParameterName and Value for DUT tab**

| Parameters        | Description   |
|-------------------|---|
| DUT ID            | Specifies the value parameters. <ul style="list-style-type: none"> <li>■ For DUTID, valid value is: <ul style="list-style-type: none"> <li>■ Comment</li> </ul> </li> </ul> |
| Acquiremode       | Specifies the acquire mode parameters <ul style="list-style-type: none"> <li>■ Acquire live waveforms</li> <li>■ Use pre-recorded waveform files.</li> </ul>                |
| View              | Sets the view mode. <ul style="list-style-type: none"> <li>■ Compliance</li> <li>■ Advanced</li> </ul>  |
| RBR               | <ul style="list-style-type: none"> <li>■ Included</li> <li>■ Excluded</li> </ul>  |
| HBR               | <ul style="list-style-type: none"> <li>■ Included</li> <li>■ Excluded</li> </ul>  |
| HBR2              | <ul style="list-style-type: none"> <li>■ Included</li> <li>■ Excluded</li> </ul>  |
| HBR3              | <ul style="list-style-type: none"> <li>■ Included</li> <li>■ Excluded</li> </ul>  |
| PreEmphasis-0dB   | <ul style="list-style-type: none"> <li>■ Included</li> <li>■ Excluded</li> </ul>  |
| PreEmphasis-3.5dB | <ul style="list-style-type: none"> <li>■ Included</li> <li>■ Excluded</li> </ul>  |

| Parameters           | Description  |
|----------------------|--|
| PreEmphasis-6dB      | <ul style="list-style-type: none"> <li>■ Included</li> <li>■ Excluded</li> </ul>   |
| PreEmphasis-9.5dB    | <ul style="list-style-type: none"> <li>■ Included</li> <li>■ Excluded</li> </ul>   |
| SSC                  | <ul style="list-style-type: none"> <li>■ SSC Enable</li> <li>■ SSC Disable</li> <li>■ Both</li> </ul>  |
| Voltage swing-400mV  | <ul style="list-style-type: none"> <li>■ Included</li> <li>■ Excluded</li> </ul>   |
| Voltage swing-600mV  | <ul style="list-style-type: none"> <li>■ Included</li> <li>■ Excluded</li> </ul>   |
| Voltage swing-800mV  | <ul style="list-style-type: none"> <li>■ Included</li> <li>■ Excluded</li> </ul>   |
| Voltage swing-1200mV | <ul style="list-style-type: none"> <li>■ Included</li> <li>■ Excluded</li> </ul>   |
| Link Widths          | <ul style="list-style-type: none"> <li>■ 1 Lane</li> <li>■ 2 Lanes</li> <li>■ 4 Lanes</li> </ul>   |
| DUT control          | <ul style="list-style-type: none"> <li>■ DP AUX</li> <li>■ DP AUX-Nvidia</li> <li>■ Manual</li> <li>■ DPR-100</li> </ul>                           |
| Signal Validation    | <ul style="list-style-type: none"> <li>■ Skip validation</li> <li>■ Skip test if validation fails</li> <li>■ Prompt if validation fails</li> </ul> |

**Table 18: ParameterName and Value for Test selection tab**

| Parameters | Description  |
|------------|--|
| TestName   | <p>Specifies the test measurement name.<br/>Valid values for DisplayPort Tx are:</p> <ul style="list-style-type: none"> <li>■ Test 3.1_Eye diagram testing</li> <li>■ Test 3.2_Non Pre-Emphasis Level Verification Testing</li> <li>■ Test 3.3_Pre-Emphasis Level Verification Testing</li> <li>■ Test 3.4_Inter-Pair Skew Testing</li> <li>■ Test 3.5_Intra-pair Skew Test</li> <li>■ Test 3.10_AC Common Mode Noise Measurements</li> <li>■ Test 3.11_Non ISI Jitter Measurements</li> <li>■ Test 3.12.1_Tota Jitter (TJ) Measurements</li> <li>■ Test 3.12.2_RandomJitter (RJ) Measurements</li> <li>■ Test 3.14_Main Link Frequency Compliance</li> <li>■ Test 3.15_Spread Spectrum Modulation Frequency</li> <li>■ Test 3.16_Spread Spectrum Modulation Deviation</li> <li>■ Test 3.17_dF/dt Spread Spectrum Deviation HF Variation</li> </ul> <p>Valid valued for DisplayPort++ are:</p> <ul style="list-style-type: none"> <li>■ Test 3.18_Dual-mode TMDS Clock</li> <li>■ Test 3.19_Dual-mode Eye Diagram Testing</li> </ul> <p>Valid valued for AUX Channel Test are:</p> <ul style="list-style-type: none"> <li>■ Test 8.1_AUX Manchester Channel EYE Test</li> <li>■ Test 8.2_AUX Channel EYE Sensitivity Test</li> <li>■ Test 8.5_Inrush Test</li> </ul> |

**Table 19: ParameterName and Value for Acquisitions tab**

| Parameters              | Description  |
|-------------------------|--|
| Probe1, Probe 2         | Specifies the probe source channel for each listed signal.<br>Valid values are: <ul style="list-style-type: none"> <li>■ CH1</li> <li>■ CH2</li> <li>■ CH3</li> <li>■ CH4</li> </ul> |
| Show Acquire Parameters | TRUE or FALSE  |
| Embed/De-embed Filter   | <ul style="list-style-type: none"> <li>■ Included</li> <li>■ Excluded</li> </ul>   |

**Table 20: ParameterName and Value for Preferences tab**

| Parameters                                | Description   |
|---|---------------|
| Number of Runs                            | 1 to 250      |
| Timer Warning Info Message Popup          | TRUE<br>FALSE |
| Timer Warning Info Message Popup Duration | 1 to 60       |
| Timer Error Message Popup                 | TRUE<br>FALSE |
| Timer Error Message Popup                 | 1 to 60       |

**ParameterName and Value for General, Acquire and Analyze**

Specifies the ParameterName and Value for General, Acquire and Analyze. The configuration parameters available are not same for measurements.

**Table 21: ParameterName and Value for General**

| ParameterName      | Value   |
|--------------------|---|
| Report Update Mode | <ul style="list-style-type: none"> <li>■ New</li> <li>■ Append</li> <li>■ Replace</li> </ul>                                  |
| Report name        | X:\DisplayPort\Reports\DUT001.mht   |
| Save As Type       | <ul style="list-style-type: none"> <li>■ Web Archive (*.mht;*.mhtml)</li> <li>■ PDF (*.pdf)</li> <li>■ CSV (*.csv)</li> </ul> |



| ParameterName                                     | Value  |
|---|--|
| Auto increment report name if duplicate           | <ul style="list-style-type: none"> <li>■ Included</li> <li>■ Excluded</li> </ul>   |
| Create report automatically at the end of the run | <ul style="list-style-type: none"> <li>■ Included</li> <li>■ Excluded</li> </ul>   |
| Include pass/fail results Summary                 | <ul style="list-style-type: none"> <li>■ Included</li> <li>■ Excluded</li> </ul>   |
| Include detailed results                          | <ul style="list-style-type: none"> <li>■ Included</li> <li>■ Excluded</li> </ul>   |
| Include plot images                               | <ul style="list-style-type: none"> <li>■ Included</li> <li>■ Excluded</li> </ul>   |
| Include setup configuration                       | <ul style="list-style-type: none"> <li>■ Included</li> <li>■ Excluded</li> </ul>   |
| Include user comments                             | <ul style="list-style-type: none"> <li>■ Included</li> <li>■ Excluded</li> </ul>   |
| Include informative results                       | <ul style="list-style-type: none"> <li>■ Included</li> <li>■ Excluded</li> </ul>   |
| Report Group mode                                 | <ul style="list-style-type: none"> <li>■ Test Name</li> <li>■ Test Result</li> <li>■ Lane Name</li> </ul>                      |
| View report after generating                      | <ul style="list-style-type: none"> <li>■ Included</li> <li>■ Excluded</li> </ul>   |
| Save As type                                      | <ul style="list-style-type: none"> <li>■ Web Archive (*.mht;*.mhtml)</li> <li>■ PDF (*.pdf)</li> <li>■ CSV (*.csv;)</li> </ul> |
| DSP Filter  | <ul style="list-style-type: none"> <li>■ Included</li> <li>■ Excluded</li> </ul>   |
| DSP Filter:RBR Bandwidth (GHz)                    | 4 to Scope Maximum BW limit  |
| DSP Filter:HBR Bandwidth (GHz)                    | 8 to scope Maximum BW  |

| ParameterName                   | Value                    |
|---------------------------------|--------------------------|
| DSP Filter:HBR2 Bandwidth (GHz) | 12.5 to scope Maximum BW |
| DSP Filter:HBR3 Bandwidth (GHz) | 12.5 to scope Maximum BW |

**Table 22: ParameterName and Value for Acquire**

| Test Name  | AcquireType                   | ParameterName                            | Value                |                    |                    |
|--|-------------------------------|--|----------------------|--------------------|--------------------|
| All Tests under DisplayPort Tx node <ul style="list-style-type: none"> <li>■ Test 3.1_Eye diagram testing</li> <li>■ Test 3.2_Non Pre-Emphasis Level Verification Testing</li> <li>■ Test 3.3_Pre-Emphasis Level Verification Testing</li> <li>■ Test 3.4_Inter-Pair Skew Testing</li> <li>■ Test 3.5_Intra-pair Skew Test</li> <li>■ Test 3.10_AC Common Mode Noise Measurements</li> <li>■ Test 3.11_Non ISI Jitter Measurements</li> <li>■ Test 3.12.1_Tota Jitter (TJ) Measurements</li> <li>■ Test 3.12.2_RandomJitter (RJ) Measurements</li> <li>■ Test 3.14_Main Link Frequency Compliance</li> <li>■ Test 3.15_Spread Spectrum Modulation Frequency</li> <li>■ Test 3.16_Spread Spectrum Modulation Deviation</li> <li>■ Test 3.17_dF/dt Spread Spectrum Deviation HF Variation</li> </ul> | PRBS7<br>D10.2                | RBR:Sample Rate(GS/s)                    | 10 to 100            |                    |                    |
|  |                               | HBR:Sample Rate(GS/s)                    | 10 to 100            |                    |                    |
|  |                               | HBR2:Sample Rate(GS/s)                   | 10 to 100            |                    |                    |
|  |                               | HBR3:Sample Rate(GS/s)                   | 10 to 100            |                    |                    |
|  |                               | RBR:Record Length(M)                     | 10 to 50             |                    |                    |
|  |                               | HBR:Record Length(M)                     | 10 to 50             |                    |                    |
|  |                               | HBR2:Record Length(M)                    | 10 to 50             |                    |                    |
|  |                               | HBR3:Record Length(M)                    | 10 to 50             |                    |                    |
| Test 3.18_Dual-mode TMDS Clock<br>Test 3.19_Dual-mode Eye Diagram Testing  | TMDS Clock<br>TMDS EyeDiagram | Record Length (M)                        | 5<br>10<br>20        |                    |                    |
|  |                               | Sample rate (GS/s)                       | 10<br>25<br>50       |                    |                    |
|  |                               | Edge trigger slope                       | Positive<br>Negative |                    |                    |
|  |                               | Test 8.1_AUX Manchester Channel EYE Test | Aux EyeDiagram       | Record Length (M)  | 2<br>4<br>5        |
|  |                               |  |                      | Sample rate (GS/s) | 6.25<br>12.5<br>50 |
| Edge trigger slope   | Positive<br>Negative          |  |                      |                    |                    |

| Test Name            | AcquireType | ParameterName      | Value            |
|----------------------|-------------|--------------------|------------------|
| Test 8.5_Inrush Test | Inrush      | Record Length (M)  | 2.5<br>5         |
|                      |             | Sample rate (GS/s) | 12.5<br>25<br>50 |

**Table 23: ParameterName and Value for Analyze**

| Test Name                     | AcquireType  | ParameterName                     | Value   |
|-------------------------------|--|-----------------------------------|---|
| Test 3.1_Eye diagram testing  | PRBS7  | Clock recovery method             | PLL-Custom BW<br>Constant Clock-Mean                              |
|                               |  | PLL Model Type                    | ONE<br>TWO  |
|                               |  | RBR Damping (m)                   | 500 to 2000   |
|                               |  | RBR Loop bandwidth (MHz)          | 0.1 to 10   |
|                               |  | HBR Damping (m)                   | 500 to 2000   |
|                               |  | HBR Loop bandwidth (MHz)          | 0.1 to 10   |
|                               |  | HBR2 Damping (m)                  | 500 to 2000   |
|                               |  | HBR2 Loop bandwidth (MHz)         | 0.1 to 10   |
|                               |  | HBR3 Damping (m)                  | 500 to 2000   |
|                               |  | HBR3 Loop bandwidth (MHz)         | 0.1 to 10   |
|                               |  | Ref Levels Autoset Basetop Method | AUTO<br>MINMAX<br>FULLHISTOGRAM<br>EYEHISTOGRAM                   |
|                               |  | Ref levels                        | Absolute<br>Percentage  |
|                               |  | Mid level                         | -10 to 10 (Ref level=Absolute)<br>20 to 80 (Ref level=Percentage) |
| Hysteresis                    | -2 to 2 (Ref level=Absolute)<br>2 to 20 (Ref level=Percentage) |                                   |   |
| Test 3.4_Inter-Pair Skew Test | PRBS7  | Ref Levels Autoset Basetop Method | AUTO<br>MINMAX<br>FULLHISTOGRAM<br>EYEHISTOGRAM                   |
|                               |  | Ref levels                        | Absolute<br>Percentage  |
|                               |  | Mid level                         | -10 to 10 (Ref level=Absolute)<br>20 to 80 (Ref level=Percentage) |
|                               |  | Hysteresis                        | -2 to 2 (Ref level=Absolute)<br>2 to 20 (Ref level=Percentage)    |

| Test Name                             | AcquireType  | ParameterName                     | Value   |
|---------------------------------------|--|-----------------------------------|---|
| Test 3.5_Intra-Pair Skew Test         | PRBS7  | Ref Levels Autoset Basetop Method | AUTO<br>MINMAX<br>FULLHISTOGRAM<br>EYEHISTOGRAM                   |
|                                       |  | Ref levels                        | Absolute<br>Percentage  |
|                                       |  | Mid level                         | -10 to 10 (Ref level=Absolute)<br>20 to 80 (Ref level=Percentage) |
|                                       |  | Hysteresis                        | -2 to 2 (Ref level=Absolute)<br>2 to 20 (Ref level=Percentage)    |
| Test 3.11_Non ISI Jitter Measurements | PRBS7  | Clock recovery method             | PLL-Custom BW<br>Constant Clock-Mean                              |
|                                       |  | PLL Model Type                    | ONE<br>TWO  |
|                                       |  | RBR Damping (m)                   | 500 to 2000   |
|                                       |  | RBR Loop bandwidth (MHz)          | 0.1 to 10   |
|                                       |  | HBR Damping (m)                   | 500 to 2000   |
|                                       |  | HBR Loop bandwidth (MHz)          | 0.1 to 10   |
|                                       |  | HBR2 Damping (m)                  | 500 to 2000   |
|                                       |  | HBR2 Loop bandwidth (MHz)         | 0.1 to 10   |
|                                       |  | HBR3 Damping (m)                  | 500 to 2000   |
|                                       |  | HBR3 Loop bandwidth (MHz)         | 0.1 to 10   |
|                                       |  | Ref Levels Autoset Basetop Method | AUTO<br>MINMAX<br>FULLHISTOGRAM<br>EYEHISTOGRAM                   |
|                                       |  | Ref levels                        | Absolute<br>Percentage  |
|                                       |  | Mid level                         | -10 to 10 (Ref level=Absolute)<br>20 to 80 (Ref level=Percentage) |
| Hysteresis                            | -2 to 2 (Ref level=Absolute)<br>2 to 20 (Ref level=Percentage) |                                   |   |

| Test Name                                  | AcquireType  | ParameterName                     | Value   |
|--|--|-----------------------------------|---|
| Test 3.12.1_Total Jitter (TJ) Measurements | PRBS7  | Clock recovery method             | PLL-Custom BW<br>Constant Clock-Mean                              |
|  |  | PLL Model Type                    | ONE<br>TWO  |
|  |  | RBR Damping (m)                   | 500 to 2000   |
|  |  | RBR Loop bandwidth (MHz)          | 0.1 to 10   |
|  |  | HBR Damping (m)                   | 500 to 2000   |
|  |  | HBR Loop bandwidth (MHz)          | 0.1 to 10   |
|  |  | HBR2 Damping (m)                  | 500 to 2000   |
|  |  | HBR2 Loop bandwidth (MHz)         | 0.1 to 10   |
|  |  | HBR3 Damping (m)                  | 500 to 2000   |
|  |  | HBR3 Loop bandwidth (MHz)         | 0.1 to 10   |
|  |  | Ref Levels Autoset Basetop Method | AUTO<br>MINMAX<br>FULLHISTOGRAM<br>EYEHISTOGRAM                   |
|  |  | Ref levels                        | Absolute<br>Percentage  |
|  |  | Mid level                         | -10 to 10 (Ref level=Absolute)<br>20 to 80 (Ref level=Percentage) |
| Hysteresis                                 | -2 to 2 (Ref level=Absolute)<br>2 to 20 (Ref level=Percentage) |                                   |   |

| Test Name                                   | AcquireType  | ParameterName                     | Value   |
|---|--|-----------------------------------|---|
| Test 3.12.2_Random Jitter (RJ) Measurements | PRBS7  | Clock recovery method             | PLL-Custom BW<br>Constant Clock-Mean                              |
|   |  | PLL Model Type                    | ONE<br>TWO  |
|   |  | RBR Damping (m)                   | 500 to 2000   |
|   |  | RBR Loop bandwidth (MHz)          | 0.1 to 10   |
|   |  | HBR Damping (m)                   | 500 to 2000   |
|   |  | HBR Loop bandwidth (MHz)          | 0.1 to 10   |
|   |  | HBR2 Damping (m)                  | 500 to 2000   |
|   |  | HBR2 Loop bandwidth (MHz)         | 0.1 to 10   |
|   |  | HBR3 Damping (m)                  | 500 to 2000   |
|   |  | HBR3 Loop bandwidth (MHz)         | 0.1 to 10   |
|   |  | Ref Levels Autoset Basetop Method | AUTO<br>MINMAX<br>FULLHISTOGRAM<br>EYEHISTOGRAM                   |
|   |  | Ref levels                        | Absolute<br>Percentage  |
|   |  | Mid level                         | -10 to 10 (Ref level=Absolute)<br>20 to 80 (Ref level=Percentage) |
| Hysteresis                                  | -2 to 2 (Ref level=Absolute)<br>2 to 20 (Ref level=Percentage) |                                   |   |
| Test 3.18_Dual-mode TMD5 Clock              | TMD5 Clock   | Signal Type                       | CLOCK<br>DATA<br>AUTO   |
|   |  | Clock Edge                        | RISE<br>FALL<br>BOTH  |
|   |  | Clock recovery method             | PLL-Custom BW   |

## Examples

This section provides the examples for the SCPI commands.

| Example   | Description   |
|---|---|
| TEKEXP:*IDN?  | It returns the active TekExpress application name running on the scope.   |
| TEKEXP:*OPC?  | It returns the last command execution status.   |
| TEKEXP:ACQUIRE_MODE PRE-RECORDED                                  | It sets the acquire mode as pre-recorded.   |
| TEKEXP:ACQUIRE_MODE?  | It returns LIVE when acquire mode is set to live.   |
| TEKEXP:EXPORT REPORT  | It returns the report file in bytes. This can be written into another file for further analysis.  |
| TEKEXP:INFO? REPORT   | It returns "100,"ReportFileName.mht"", when 100 is the filesize in bytes for the filename ReportFileName.   |
| TEKEXP:INFO? WFM  | It returns "100,"WfmFileName1.wfm"";200,"WfmFileName2.wfm"" when 100 is the filesize in bytes for the filename WfmFileName1.wfm and 200 is the filesize in bytes for the filename WfmFileName2.wfm.       |
| TEKEXP:INSTRUMENT "Real Time Scope",DPO72504D ( GPIB8::1::INSTR ) | It sets the instrument value as DPO72504D ( GPIB8::1::INSTR ) for the selected instrument type Real Time Scope.   |
| TEKEXP:INSTRUMENT? "Real Time Scope"                              | It returns "DPO72504D ( GPIB8::1::INSTR )", when DPO72504D ( GPIB8::1::INSTR ) is the selected instrument for the instrument type Real Time Scope.  |
| TEKEXP:LASTERROR?   | It returns ERROR: INSTRUMENT_NOT_FOUND, when no instrument is found.  |
| TEKEXP:LIST? DEVICE   | It returns "Transmitter" when Transmitter is the available device.  |
| TEKEXP:LIST? INSTRUMENT,"Real Time Scope"                         | It returns "DPO72504D ( GPIB8::1::INSTR ),MSO72504 ( TCP/IP::134.64.248.91::INSTR )" when DPO72504D ( GPIB8::1::INSTR ), MSO72504 ( TCP/IP::134.64.248.91::INSTR ) are the list of available instruments. |
| TEKEXP:MODE COMPLIANCE  | It sets the execution mode as compliance.   |
| TEKEXP:MODE?  | It returns COMPLIANCE when the execution mode is compliance.  |
| TEKEXP:POPOP "OK"   | It sets OK as the response to active popup in the application.  |
| TEKEXP:POPOP?   | It returns "OK", when OK is the active popup information shown in the application.  |
| TEKEXP:REPORT GENERATE  | It generates report for the current session.  |
| TEKEXP:REPORT? "Scope Model"                                      | It returns "DPO73304SX" when DPO73304SX is the scope model.   |
| TEKEXP:REPORT? "DUT ID"   | It returns "DUT001" when DNI_DUT001 is the DUT ID.  |
| TEKEXP:RESULT? "Test 3.1_Eye diagram testing"                     | It returns Pass, then the test result is Pass.  |
| TEKEXP:RESULT? "Test 3.1_Eye diagram testing", "Margin"           | It returns list of values then that is 'Margin' column data.  |
| TEKEXP:RESULT? "Test 3.1_Eye diagram testing", "Units",0          | It returns the unit of the first row of result.   |
| TEKEXP:SELECT DEVICE,"DisplayPort"                                | It selects device "DisplayPort".  |
| TEKEXP:SELECT TEST,"Test 3.1_Eye diagram testing", TRUE           | It selects "Test 3.1_Eye diagram testing" measurement.  |
| TEKEXP:SETUP DEFAULT  | It restores the application to default setup.   |

| Example                               | Description  |
|---------------------------------------|--|
| TEKEXP:STATE STOP                     | It stops the test execution.   |
| TEKEXP:STATE?                         | It returns as READY when the application is ready to run next measurement. |
| TEKEXP:STATE? SETUP                   | It returns as NOT_SAVED when the current setup is not saved.               |
| TEKEXP:VALUE GENERAL,"RBR","Included" | It selects RBR data rate.  |
| TEKEXP:VALUE? GENERAL,"RBR"           | It returns 'Included', then RBR is selected in DUT panel.                  |

Examples script files are present in installation directory. Refer the following path for accessing the examples, **C:\Program Files\Tektronix\TekExpress\TekExpress DisplayPortTx\Examples**.



---

# Reference

## Deskew channels

If skew is present between positive and negative channels, then the channels need to be deskewed before being used for waveform measurements. TekExpress DisplayPort solution provides support for channel deskew using the following method:

1. Determine what the skew is for each channel.
2. From the TekScope menu, click **Vertical** and select **Deskew**.
3. In the Deskew/Attenuation window, click the channel (1 – 4) button for the first channel to be deskewed.
4. Click in the Ch(x) Deskew Time entry field and enter the skew. The skew can be +ve or –ve.
5. Click the channel button for the next channel and repeat step 4, above.
6. After entering the skew for all the channels that require it, from the Options menu in TekExpress DisplayPort, select **Deskew**.
7. In the Deskew dialog box, select the desired level:
  - Less than 100 mV signal amplitude: Select this if the signal amplitude is such that the oscilloscope's vertical setting is less than 100 mV/division.
  - 100 mV or greater signal amplitude: Select this if the signal amplitude is such that the oscilloscope's vertical setting is greater than 100 mV/division.
8. Click **Read Deskew/Attn**.
9. When finished, click **Close**.

Each input channel has its own deskew settings. Deskew compensates individual channels for probes or cables of different lengths. The instrument applies the delay values after each completed acquisition. The deskew values are saved as part of the instrument setup. The deskew values for the selected channel are retained until you change the probe, you restore a saved setup, or you recall the factory setup.

See Also [Pre-Run checklist](#)

## Appendix-A

Following are the Compliance parameters for all DisplayPort measurements for CTS 1.2.

**Table 24: Compliance Parameters list for all DisplayPort measurements for CTS 1.2**

| Test ID | Test Name                                   | Data Rate | Pre-emphasis Level | Voltage Swing    | SSC                           |
|---------|---|-----------|--------------------|------------------|-------------------------------|
| 3.1     | Eye Diagram testing                         | RBR       | Level 0 (0 dB)     | Level 2 (800 mV) | SSC Enabled/SSC Disabled/Both |
|         |   | HBR       | Level 0 (0 dB)     | Level 2 (800 mV) | SSC Enabled/SSC Disabled/Both |
|         |   | HBR2      | All                | All              | SSC Enabled/SSC Disabled/Both |
| 3.2     | Non Pre-emphasis Level Verification Testing | RBR       | Level 0 (0 dB)     | All              | SSC Enabled/SSC Disabled/Both |
|         |   | HBR       | Level 0 (0 dB)     | All              | SSC Enabled/SSC Disabled/Both |
|         |   | HBR2      | Level 0 (0 dB)     | All              | SSC Enabled/SSC Disabled/Both |
| 3.3     | Pre-emphasis Level Verification Testing     | RBR       | All                | All              | SSC Enabled/SSC Disabled/Both |
|         |   | HBR       | All                | All              | SSC Enabled/SSC Disabled/Both |
|         |   | HBR2      | All                | All              | SSC Enabled/SSC Disabled/Both |
| 3.4     | Inter Pair Skew Test                        | RBR       | Level 0 (0 dB)     | Level 2 (800 mV) | SSC Enabled/SSC Disabled/Both |
|         |   | HBR       | Level 0 (0 dB)     | Level 2 (800 mV) | SSC Enabled/SSC Disabled/Both |
|         |   | HBR2      | Level 0 (0 dB)     | Level 2 (800 mV) | SSC Enabled/SSC Disabled/Both |
| 3.5     | Intra Pair Skew Test                        | RBR       | Level 0 (0 dB)     | Level 2 (800 mV) | SSC Enabled/SSC Disabled/Both |
|         |   | HBR       | Level 0 (0 dB)     | Level 2 (800 mV) | SSC Enabled/SSC Disabled/Both |
|         |   | HBR2      | Level 0 (0 dB)     | Level 2 (800 mV) | SSC Enabled/SSC Disabled/Both |
| 3.10    | AC Common Mode Noise Measurements           | RBR       | All                | All              | SSC Enabled/SSC Disabled/Both |
|         |   | HBR       | All                | All              | SSC Enabled/SSC Disabled/Both |
|         |   | HBR2      | All                | All              | SSC Enabled/SSC Disabled/Both |

| Test ID | Test Name                                    | Data Rate | Pre-emphasis Level | Voltage Swing    | SSC                           |
|---------|--|-----------|--------------------|------------------|-------------------------------|
| 3.11    | Non ISI Jitter Measurements                  | RBR       | Level 0 (0 dB)     | All              | SSC Enabled/SSC Disabled/Both |
|         |  | HBR       | Level 0 (0 dB)     | All              | SSC Enabled/SSC Disabled/Both |
| 3.12.1  | Total Jitter (TJ) Measurements               | RBR       | Level 0 (0 dB)     | All              | SSC Enabled/SSC Disabled/Both |
|         |  | HBR       | Level 0 (0 dB)     | All              | SSC Enabled/SSC Disabled/Both |
|         |  | HBR2      | Same as Test 3.1   | Same as Test 3.1 | Same as Test 3.1              |
| 3.12.2  | Random Jitter Measurements                   | HBR2      | Same as Test 3.1   | Same as Test 3.1 | Same as Test 3.1              |
| 3.14    | Main Link Frequency Compliance               | RBR       | Level 0 (0 dB)     | Level 2 (800 mV) | SSC Enabled/SSC Disabled/Both |
|         |  | HBR       | Level 0 (0 dB)     | Level 2 (800 mV) | SSC Enabled/SSC Disabled/Both |
|         |  | HBR2      | Level 0 (0 dB)     | Level 2 (800 mV) | SSC Enabled/SSC Disabled/Both |
| 3.15    | Spread Spectrum Modulation Frequency         | RBR       | Level 0 (0 dB)     | Level 2 (800 mV) | SSC Enabled                   |
|         |  | HBR       | Level 0 (0 dB)     | Level 2 (800 mV) | SSC Enabled                   |
|         |  | HBR2      | Level 0 (0 dB)     | Level 2 (800 mV) | SSC Enabled                   |
| 3.16    | Spread Spectrum Modulation Deviation         | RBR       | Level 0 (0 dB)     | Level 2 (800 mV) | SSC Enabled                   |
|         |  | HBR       | Level 0 (0 dB)     | Level 2 (800 mV) | SSC Enabled                   |
|         |  | HBR2      | Level 0 (0 dB)     | Level 2 (800 mV) | SSC Enabled                   |
| 3.17    | dF/dt Spread Spectrum Deviation HF Variation | RBR       | Level 0 (0 dB)     | Level 2 (800 mV) | SSC Enabled                   |
|         |  | HBR       | Level 0 (0 dB)     | Level 2 (800 mV) | SSC Enabled                   |
|         |  | HBR2      | Level 0 (0 dB)     | Level 2 (800 mV) | SSC Enabled                   |

## Appendix-B

Following are the Compliance parameters for all DisplayPort measurements for CTS 1.4.

**Table 25: Compliance Parameters list for all DisplayPort measurements for CTS 1.4**

| Test ID | Test Name                                   | Data Rate | Pre-emphasis Level | Voltage Swing    | SSC                           |
|---------|---|-----------|--------------------|------------------|-------------------------------|
| 3.1     | Eye Diagram testing                         | RBR       | Level 0 (0 dB)     | Level 2 (800 mV) | SSC Enabled/SSC Disabled/Both |
|         |   | HBR       | Level 0 (0 dB)     | Level 2 (800 mV) | SSC Enabled/SSC Disabled/Both |
|         |   | HBR2      | All                | All              | SSC Enabled/SSC Disabled/Both |
|         |   | HBR3      | All                | All              | SSC Enabled/SSC Disabled/Both |
| 3.2     | Non Pre-emphasis Level Verification Testing | RBR       | Level 0 (0 dB)     | All              | SSC Enabled/SSC Disabled/Both |
|         |   | HBR       | Level 0 (0 dB)     | All              | SSC Enabled/SSC Disabled/Both |
|         |   | HBR2      | Level 0 (0 dB)     | All              | SSC Enabled/SSC Disabled/Both |
|         |   | HBR3      | Level 0 (0 dB)     | All              | SSC Enabled/SSC Disabled/Both |
| 3.3     | Pre-emphasis Level Verification Testing     | RBR       | All                | All              | SSC Enabled/SSC Disabled/Both |
|         |   | HBR       | All                | All              | SSC Enabled/SSC Disabled/Both |
|         |   | HBR2      | All                | All              | SSC Enabled/SSC Disabled/Both |
|         |   | HBR3      | All                | All              | SSC Enabled/SSC Disabled/Both |
| 3.4     | Inter Pair Skew Test                        | RBR       | Level 0 (0 dB)     | Level 2 (800 mV) | SSC Enabled/SSC Disabled/Both |
|         |   | HBR       | Level 0 (0 dB)     | Level 2 (800 mV) | SSC Enabled/SSC Disabled/Both |
|         |   | HBR2      | Level 0 (0 dB)     | Level 2 (800 mV) | SSC Enabled/SSC Disabled/Both |
|         |   | HBR3      | Level 0 (0 dB)     | Level 2 (800 mV) | SSC Enabled/SSC Disabled/Both |

| Test ID | Test Name                            | Data Rate | Pre-emphasis Level | Voltage Swing    | SSC                           |
|---------|--------------------------------------|-----------|--------------------|------------------|-------------------------------|
| 3.5     | Intra Pair Skew Test                 | RBR       | Level 0 (0 dB)     | Level 2 (800 mV) | SSC Enabled/SSC Disabled/Both |
|         |                                      | HBR       | Level 0 (0 dB)     | Level 2 (800 mV) | SSC Enabled/SSC Disabled/Both |
|         |                                      | HBR2      | Level 0 (0 dB)     | Level 2 (800 mV) | SSC Enabled/SSC Disabled/Both |
|         |                                      | HBR3      | Level 0 (0 dB)     | Level 2 (800 mV) | SSC Enabled/SSC Disabled/Both |
| 3.10    | AC Common Mode Noise Measurements    | RBR       | All                | All              | SSC Enabled/SSC Disabled/Both |
|         |                                      | HBR       | All                | All              | SSC Enabled/SSC Disabled/Both |
|         |                                      | HBR2      | All                | All              | SSC Enabled/SSC Disabled/Both |
|         |                                      | HBR3      | All                | All              | SSC Enabled/SSC Disabled/Both |
| 3.11    | Non ISI Jitter Measurements          | RBR       | Level 0 (0 dB)     | All              | SSC Enabled/SSC Disabled/Both |
|         |                                      | HBR       | Level 0 (0 dB)     | All              | SSC Enabled/SSC Disabled/Both |
| 3.12.1  | Total Jitter (TJ) Measurements       | RBR       | Level 0 (0 dB)     | All              | SSC Enabled/SSC Disabled/Both |
|         |                                      | HBR       | Level 0 (0 dB)     | All              | SSC Enabled/SSC Disabled/Both |
|         |                                      | HBR2      | Same as Test 3.1   | Same as Test 3.1 | Same as Test 3.1              |
|         |                                      | HBR3      | Same as Test 3.1   | Same as Test 3.1 | Same as Test 3.1              |
| 3.12.2  | Random Jitter Measurements           | HBR2      | Same as Test 3.1   | Same as Test 3.1 | Same as Test 3.1              |
|         |                                      | HBR3      | Same as Test 3.1   | Same as Test 3.1 | Same as Test 3.1              |
| 3.14    | Main Link Frequency Compliance       | RBR       | Level 0 (0 dB)     | Level 2 (800 mV) | SSC Enabled/SSC Disabled/Both |
|         |                                      | HBR       | Level 0 (0 dB)     | Level 2 (800 mV) | SSC Enabled/SSC Disabled/Both |
|         |                                      | HBR2      | Level 0 (0 dB)     | Level 2 (800 mV) | SSC Enabled/SSC Disabled/Both |
|         |                                      | HBR3      | Level 0 (0 dB)     | Level 2 (800 mV) | SSC Enabled/SSC Disabled/Both |
| 3.15    | Spread Spectrum Modulation Frequency | RBR       | Level 0 (0 dB)     | Level 2 (800 mV) | SSC Enabled                   |
|         |                                      | HBR       | Level 0 (0 dB)     | Level 2 (800 mV) | SSC Enabled                   |
|         |                                      | HBR2      | Level 0 (0 dB)     | Level 2 (800 mV) | SSC Enabled                   |
|         |                                      | HBR3      | Level 0 (0 dB)     | Level 2 (800 mV) | SSC Enabled                   |

---

| Test ID | Test Name                                    | Data Rate | Pre-emphasis Level | Voltage Swing    | SSC         |
|---------|--|-----------|--------------------|------------------|-------------|
| 3.16    | Spread Spectrum Modulation Deviation         | RBR       | Level 0 (0 dB)     | Level 2 (800 mV) | SSC Enabled |
|         |  | HBR       | Level 0 (0 dB)     | Level 2 (800 mV) | SSC Enabled |
|         |  | HBR2      | Level 0 (0 dB)     | Level 2 (800 mV) | SSC Enabled |
|         |  | HBR3      | Level 0 (0 dB)     | Level 2 (800 mV) | SSC Enabled |
| 3.17    | dF/dt Spread Spectrum Deviation HF Variation | RBR       | Level 0 (0 dB)     | Level 2 (800 mV) | SSC Enabled |
|         |  | HBR       | Level 0 (0 dB)     | Level 2 (800 mV) | SSC Enabled |
|         |  | HBR2      | Level 0 (0 dB)     | Level 2 (800 mV) | SSC Enabled |
|         |  | HBR3      | Level 0 (0 dB)     | Level 2 (800 mV) | SSC Enabled |

---

# Index

## A

- AC Common Mode Noise Measurements test, 93
- Acquire parameters, 55
- Acquire Step By Step, 55
- Acquire Type, 52
- Acquisitions
  - selecting, 54
- Activating the license, 5
- Advanced View, 47
- Algorithms, 81
- Application version, 6
- Auto Scroll, 74

## C

- Channel deskew, 181
- Clear Log files, 74
- Clearing test results, 75
- Client proxy object, 112
- Code example, remote access, 116
- Command buttons, 14
- Comments
  - adding to reports, 47
- Compliance Mode, 31
- Compliance View, 31, 47
- Configure button, 51
- Connected instruments
  - viewing, 45
- Connection requirements, 34
- Conventions used in Help, 2
- CTS version, 47

## D

- Data rates, 49
- Default directory, 10
- Deselect All button, 51
- Deskewing channels, 181
- Device Profile, 47
- dF/dt Spread Spectrum Deviation HF Variation test, 101
- Directories, 10
- DUT Automation, 47

- DUT ID, 47
- DUT settings, 47

## E

- Email Notifications, 62
- Email Options, 63
- Email Settings, 16
- Enable remote access, 108
- Equipment setup, 34
- Evaluation mode, 13
- Exiting the application, 14
- Eye Diagram test, 82

## F

- File name extensions, 11
- Firewall (remote access), 108

## G

- Global Settings, 60, 61

## I

- Inbound Rule Wizard (remote access), 108
- Installing the software, 5
- Instrument Control Settings, 17
- Instruments
  - searching for, 17
  - selecting, 60
  - viewing connected, 45
- Inter-Pair Skew test, 90
- Interface, 107
- Intra-Pair Skew test, 92

## K

- Keep On Top, 13

## L

- Lane source, 54
- Lanes, 54

- License activation, 5
- License Agreement, 6
- Limit margin warning, 63
- Limits Editor, 61
- Link Width, 49
- Live waveforms, 59
- Log files
  - saving, 74

## M

- Main Link Frequency Compliance test, 98
- Measurements, 61
- Menus
  - Options, 15
  - Preferences, 75
- Message History, 74
- Mode, 61
- My TekExpress folder, 69, 78

## N

- New Inbound Rule Wizard, 108
- Non ISI Jitter Measurements test, 94
- Non Pre-Emphasis Level Verification test, 84

## O

- Options Menu, 13, 15
- Oscilloscope setup guidelines, 81
- Oscilloscopes supported, 3

## P

- Panels
  - Reports, 25
  - Results, 24
  - Setup, 23
  - Status, 23
- Pass/Fail Summary, 76
- Plot files, 78
- Plot Images, 76
- Pre-Emphasis Level Verification test, 86
- Pre-recorded Mode, 72
- Pre-recorded waveform files, 55, 72

- Pre-run checklist, 69
- Probe configuration, 52, 54
- Program example, 116
- Programmatic interface, 107

## R

- Random Jitter (RJ) Measurements test, 96
- Reactivating the license, 5
- Related Documentation, 1
- Remote access firewall settings, 108
- Remote proxy object, 111
- Report file type, 64
- Report Name, 64
- Report sections, 76
- Reports
  - selecting contents, 64
  - viewing, 76
- Reports Panel, 25
- Results Panel, 24, 75

## S

- Schematic button, 51
- SCPI commands
  - Command parameters list, 169
  - Examples, 179
  - TEKEXP:\*IDN?, 155
  - TEKEXP:\*OPC?, 155
  - TEKEXP:ACQUIRE\_MODE, 156
  - TEKEXP:ACQUIRE\_MODE?, 156
  - TEKEXP:EXPORT, 157
  - TEKEXP:INFO?, 157
  - TEKEXP:INSTRUMENT, 158
  - TEKEXP:INSTRUMENT?, 158
  - TEKEXP:LASTERROR?, 159
  - TEKEXP:LIST?, 159
  - TEKEXP:MODE, 160
  - TEKEXP:MODE?, 161
  - TEKEXP:POPUP, 161
  - TEKEXP:POPUP?, 162
  - TEKEXP:REPORT, 162
  - TEKEXP:REPORT?, 163
  - TEKEXP:RESULT?, 163



- TEKEXP:SELECT, 164
  - TEKEXP:SELECT?, 165
  - TEKEXP:SETUP, 165
  - TEKEXP:STATE, 166
  - TEKEXP:STATE?, 166
  - TEKEXP:VALUE, 167
  - TEKEXP:VALUE?, 168
  - Select All button, 51
  - Select Required button, 51
  - Selected Test Lanes, 50
  - Server, 110
  - Session files, 78
  - Session folders, 78
  - Set remote access, 108
  - Setup Panel, 23
  - Show Acquire Parameters, 55
  - Signal Path Compensation (SPC), 72
  - Signal validation data rate tolerance, 63
  - Spread Spectrum Modulation Deviation test, 100
  - Spread Spectrum Modulation Frequency test, 99
  - SSC, 49
  - Status Panel, 23
  - System requirements, 3
- ## T
- Technical support, 2
  - TekExpress client, 107
  - TekExpress client requirements, 110
  - TekExpress server, 107
  - Test configuration, 59
  - Test Lanes, 47
  - Test limits, 61
  - Test notifications, 63
  - Test parameters, 61
  - Test Reports, 76
  - Test Results
    - clearing displayed, 75
  - Test selection controls, 51
  - Test setup files, 78
  - Test setup overview, 46
  - Test setups
    - creating based on existing, 30
    - deleting, 30
    - recalling, 28
    - saving, 27
  - Tests
    - configuring, 59
    - running, 69
    - running prerecorded, 72
    - selecting, 51
    - setting up, 31
  - Total Jitter (TJ) Measurements test, 95
- ## U
- Untitled Session folder, 69
  - User Comments
    - including in test reports, 64
    - location in reports, 76
- ## V
- View option, 47
- ## W
- Waveform FileName, 52
  - Waveform files
    - using pre-recorded, 55
  - Waveforms
    - acquiring live, 59

