



SignalVu™
Vector Signal Analysis Software
Printable Help





SignalVu™
Vector Signal Analysis Software
Printable Help

Copyright © Tektronix. All rights reserved. Licensed software products are owned by Tektronix or its subsidiaries or suppliers, and are protected by national copyright laws and international treaty provisions.

Tektronix products are covered by U.S. and foreign patents, issued and pending. Information in this publication supersedes that in all previously published material. Specifications and price change privileges reserved.

TEKTRONIX and TEK are registered trademarks of Tektronix, Inc.

Compiled Help part number 076-0177-14

Contacting Tektronix

Tektronix, Inc.
14150 SW Karl Braun Drive
P.O. Box 500
Beaverton, OR 97077
USA

For product information, sales, service, and technical support:

- In North America, call 1-800-833-9200.
- Worldwide, visit www.tek.com to find contacts in your area.

Table of Contents

Welcome

Welcome	1
---------------	---

About the Tektronix Signal Analyzer

Options	
Options	3
Documentation and support	
Documentation	3
Video tutorials	3

Orientation

Connecting Signals and Selecting the Analysis Channel	5
Front-Panel Controls	5
Touch-Screen Actions	5
Elements of the Display	9

Operating Your Instrument

Presets	13
Setting Options	21

Using the Measurement Displays

Selecting Displays	25
--------------------------	----

Available Measurements

Measurements	
Available Measurements	27

General Signal Viewing

Overview	37
Time Overview	
Time Overview Display	37
Time Overview Settings	39
Navigator View	40
Spectrum	
Spectrum Display	43
Spectrum Settings	45
Spectrogram	
Spectrogram Display	47

Spectrogram Settings	49
Amplitude Vs Time	
Amplitude Vs Time Display	53
Amplitude Vs Time Settings	54
Frequency Vs Time	
Frequency Vs Time Display	55
Frequency Vs Time Settings	56
Phase Vs Time	
Phase Vs Time Display	57
Phase Vs Time Settings	58
RF I & Q Vs Time	
RF I & Q vs Time Display	59
RF I & Q vs Time Settings	60
Common Controls for General Signal Viewing Displays	
General Signal Viewing Shared Measurement Settings	61

Analog Modulation

Overview	73
AM	
AM Display	73
AM Settings	74
FM	
FM Display	79
FM Settings	81
PM	
PM Display	87
PM Settings	89

RF Measurements

Overview	97
Channel Power and ACPR	
Channel Power and ACPR (Adjacent Channel Power Ratio) Display	97
Channel Power and ACPR Settings	100
Signal Strength Display	
Signal Strength Display	103
Signal Strength Settings	104
MCPR	
MCPR (Multiple Carrier Power Ratio) Display	110
MCPR Settings	114
Occupied BW & x dB BW	
Occupied BW & x dB BW Display	121
Occupied BW & x dB BW Settings	124

Spurious	
Spurious display	125
Spurious display settings	130
CCDF	
CCDF Display	137
CCDF Settings	138
Settling Time Measurements	
Settling Time Measurement Overview	141
Settling Time Displays	
Settling Time Displays	145
Settling Time Settings	153
Common Controls for Settling Time Displays	
Settling Time Displays Shared Measurement Settings	153
SEM (Spectrum Emission Mask)	
SEM Display	161
Spectrum Emission Mask Settings	165
Common Controls for RF Measurements Displays	
RF Measurements Shared Measurement Settings	172
WLAN Measurements	
WLAN Overview	179
WLAN Chan Response	
WLAN Channel Response Display	181
WLAN Channel Response Settings	183
WLAN Constellation	
WLAN Constellation Display	184
WLAN Constellation Settings	185
WLAN EVM	
WLAN EVM Display	186
WLAN EVM Settings	187
WLAN Mag Error	
WLAN Magnitude Error Display	188
WLAN Magnitude Error Settings	189
WLAN Phase Error	
WLAN Phase Error Display	190
WLAN Phase Error Settings	191
WLAN Power vs Time	
WLAN Power vs Time Display	192
WLAN Power vs Time Settings	194
WLAN Spectral Flatness	
WLAN Spectral Flatness Display	195
WLAN Spectral Flatness Settings	196

WLAN Summary	
WLAN Summary Display	197
WLAN Summary Settings	201
WLAN Symb Table	
WLAN Symbol Table Display	202
WLAN Symbol Table Settings	204
Common Controls for WLAN Analysis Displays	
WLAN Analysis Shared Measurement Settings	204

802.11ad and 802.11ay Analysis

Overview of 802.11ad and 802.11ay	215
802.11ad/11ay measurements	219
802.11ad/11ay displays.....	220
802.11ad/11ay Constellation Display	
802.11ad/11ay Constellation Display.....	221
802.11ad/11ay EVM vs Time	
802.11ad/11ay EVM vs Time	224
802.11ad/11ay Symbol Table	
802.11ad/11ay Symbol Table Display	227
802.11ad/11ay Summary	
802.11ad/11ay Summary Display	229
802.11ad/11ay Control Panel Settings	
802.11ad/11ay Control Panel Settings.....	232

OFDM Analysis

Overview	245
OFDM Chan Response	
OFDM Channel Response Display	245
OFDM Channel Response Settings	247
OFDM Constellation	
OFDM Constellation Display	248
OFDM Constellation Settings	249
OFDM EVM	
OFDM EVM Display	249
OFDM EVM Settings	250
OFDM Flatness	
OFDM Spectral Flatness Display	251
OFDM Spectral Flatness Settings.....	252
OFDM Mag Error	
OFDM Magnitude Error Display	253
OFDM Magnitude Error Settings	254
OFDM Phase Error	

OFDM Phase Error Display	255
OFDM Phase Error Settings	256
OFDM Power	
OFDM Power Display	257
OFDM Power Settings	258
OFDM Summary	
OFDM Summary Display	259
OFDM Summary Settings	260
OFDM Symb Table	
OFDM Symbol Table Display	261
OFDM Symbol Table Settings	262
Common Controls for OFDM Analysis Displays	
OFDM Analysis Shared Measurement Settings	262

Pulsed RF

Overview	271
Cumulative Histogram Display	
Cumulative Histogram Display	273
Cumulative Histogram display settings	275
Cumulative Statistics Table	
Cumulative Statistics Table display	277
Cumulative Statistics Table display settings	280
Pulse-Ogram	
Pulse-Ogram display	280
Pulse-Ogram display settings	282
Pulse Table Display	
Pulse Table display	282
Pulse Table display settings	284
Pulse Trace Display	
Pulse Trace display	284
Pulse Trace display settings	286
Pulse Statistics	
Pulse Statistics display	286
Pulse Statistics settings	289
Common Controls for Pulsed RF Displays	
Pulsed RF Measurement Settings	290

APCO P25 Analysis

APCO P25 Analysis	309
Overview	309
P25 Standards Presets	310
P25 Displays	311

P25 Measurements	312
P25 Test Patterns	320
P25 Constellation	
P25 Constellation Display	323
P25 Constellation Settings	325
P25 Eye Diagram	
P25 Eye Diagram Display	326
P25 Eye Diagram Settings	327
P25 Power vs Time	
P25 Power vs Time Display	328
P25 Power vs Time Settings	330
P25 Summary	
P25 Summary Display	331
P25 Summary Settings	334
P25 Symbol Table	
P25 Symbol Table Display	334
P25 Symbol Table Settings	336
P25 Frequency Deviation Vs Time	
P25 Frequency Dev vs Time Display	337
P25 Frequency Dev Vs Time Settings	339
Common Controls for P25 Analysis Displays	
P25 Analysis Shared Measurement Settings	340

LTE Analysis

LTE Analysis	353
Overview	353
LTE Standards preset test setups	354
LTE displays	359
LTE measurements	359
LTE Status Messages	366
LTE ACLR	
LTE ACLR display	366
LTE ACLR Settings	369
LTE Channel Spectrum	
LTE Channel Spectrum display	369
LTE Channel Spectrum Settings	371
LTE Constellation	
LTE Constellation display	371
LTE Constellation Settings	372
LTE Power vs Time	
LTE Power vs Time display	373
LTE Power vs Time Settings	375

Common Controls for LTE Analysis Displays	
LTE Analysis Measurement Settings	375

Bluetooth Analysis

Bluetooth Analysis	393
Overview	393
Bluetooth Standards presets	395
Bluetooth displays	397
Bluetooth measurements and test setups	397
Bluetooth Status Messages	402
Bluetooth (BT) Constellation	
Bluetooth Constellation display	403
BT Constellation Settings.....	405
Bluetooth (BT) Eye Diagram	
Bluetooth Eye Diagram display	406
BT Eye Diagram Settings.....	408
Bluetooth (BT) CF Offset and Drift	
Bluetooth Carrier Frequency Offset and Drift display.....	409
BT CF Offset and Drift Settings	410
Bluetooth (BT) Summary	
Bluetooth Summary display	411
BT Summary Settings	415
Bluetooth (BT) Symbol Table	
Bluetooth Symbol Table display	415
BT Symbol Table Settings	418
Bluetooth (BT) Frequency Deviation Vs Time	
Bluetooth Frequency Dev vs Time display	419
BT Frequency Dev Vs Time Settings.....	423
Bluetooth (BT) 20dB Bandwidth	
Bluetooth 20dB Bandwidth display.....	423
BT 20dB BW settings	425
Bluetooth (BT) InBand Emission	
Bluetooth InBand Emission display	426
Common Controls for Bluetooth Analysis Displays for RSA	
Bluetooth Analysis Measurement Settings.....	428

Audio Analysis

Overview	443
Audio Spectrum	
Audio Spectrum Display	443
Audio Spectrum Settings.....	444
Audio Summary	

Audio Summary Display.....	445
Audio Summary Settings	446
Common Controls for Audio Analysis Displays	
Audio Analysis Measurement Settings.....	447

GP Digital Modulation

Overview	457
Constellation	
Constellation Display.....	458
Constellation Settings	459
Demod I & Q vs Time	
Demod I & Q vs Time Display.....	460
Demod I & Q vs Time Settings	462
EVM vs Time	
EVM vs Time Display.....	462
EVM vs Time Settings	463
Eye Diagram	
Eye Diagram Display.....	464
Eye Diagram Settings	466
Frequency Deviation vs Time	
Frequency Deviation vs Time Display	466
Frequency Deviation vs Time Settings.....	468
Magnitude Error vs Time	
Magnitude Error vs Time Display	468
Magnitude Error vs Time Settings.....	470
Phase Error vs Time	
Phase Error vs Time Display	470
Phase Error vs. Time Settings.....	472
Signal Quality	
Signal Quality Display	472
Signal Quality Settings.....	477
Symbol Table	
Symbol Table Display.....	478
Symbol Table Settings.....	479
Trellis Diagram	
Trellis Diagram Display.....	479
Trellis Diagram Settings	481
Common Controls for GP Digital Modulation Displays	
GP Digital Modulation Shared Measurement Settings	481
Standard Settings Button.....	482
Symbol Maps	
Symbol Maps.....	499

User Filters	
Overview: User Defined Measurement and Reference Filters	504
User Filter File Format	505
Marker Measurements	
Using Markers	
Using Markers	509
Controlling Markers with the Touchscreen Actions Menu	509
Measuring Frequency and Power in the Spectrum Display	512
Common Marker Actions	
Marker Action Controls	513
Peak	513
Next Peak	513
Marker to Center Frequency	513
Sync Scope C1/C2 to Active Marker	513
Define Markers Control Panel	
Enabling Markers and Setting Marker Properties	514
Markers Toolbar	
Using the Markers Toolbar	515
Noise Markers in the Spectrum Display	
Measuring Noise Using Delta Markers in the Spectrum Display	516
Mask Testing	
The Mask Test Tool	519
Mask Test Settings	519
Define Tab (Mask Test)	519
Actions Tab	524
Analyzing Data	
Analysis Settings	
Analysis Settings	525
Analysis Time Tab	525
Spectrum Time Tab	527
Frequency Tab	527
Units Tab	530
Analyzing Data Using Replay	
Replay Overview	531
Replay Menu	533
Acq Data	533
Replay All Selected Records	534
Replay Current Record	534
Replay from Selected	534

Pause	534
Stop.....	534
Select All	534
Select Records from History.....	535
Replay Toolbar.....	535

Amplitude Corrections

Amplitude Settings	537
External Gain/Loss Correction Tab.....	537
External Gain Value	537
Apply External Corrections To.....	538
External Loss Tables	538

Controlling the Acquisition of Data

Acquisition Controls in the Run Menu	
Continuous Versus Single Sequence.....	541
Run	541
Resume.....	541
Abort	541
Acquisition Controls in the Acquire Control Panel	
Acquire.....	542
Vertical	543
IQ Sampling Parameters	544
Scope Settings.....	546
Scope Data Tab.....	547
Advanced	547
Timing Reference.....	549

GNSS and Antenna Features

How to set up GNSS	553
How to use the Antenna feature.....	555

Signal Database and Channel Navigation

How to use the Signal Database	561
Channel Navigation toolbar	564

Managing Data, Settings, and Pictures

Saving and Recalling Data, Settings, and Pictures.....	567
Data, Settings, and Picture File Formats	570
Printing Screen Shots	574

Reference

Application Help	575
About the Vector Signal Analysis Software	575
Menus	
Main menu overview	576
File Menu	
File Menu	577
View Menu	
View Menu	581
Run Menu	
Run Menu	584
Replay	
Replay Menu	585
Markers Menu	
Markers Menu	585
Setup Menu	
Setup Menu	585
Presets Menu	
Presets Menu	585
Application Presets	586
Tools Menu	
Tools Menu	586
Window menu	
Window menu	587
Help Menu	
Help Menu	587
PI Command Search	
PI Command Search tool	588
Favorites bar	
Favorites bar menus	588
Troubleshooting	
Error and Information Messages	589
Displaying the Windows Event Viewer	596
Dealing with Sluggish Instrument Operation	597
Upgrading the Product Software	
How to Find Out if Software Upgrades are Available	598
Changing Settings	
Settings	598

Glossary

Index

Welcome

This Help provides in-depth information on how to use the SignalVu™ Vector Signal Analysis Software.

Using the signal analysis engine of the RSA5100 and RSA6100 Series real-time signal analyzer, this vector signal analysis software helps you move your analysis of acquisitions off the instrument.

NOTE. *Some of the screen illustrations in this document are taken from the vector signal analysis software version that runs on the RSA5100 Series Real-time Signal Analyzers. These instruments support additional hardware-based functionality and buttons that are not present in the SignalVu™ or SignalVu-PC application.*

Options

To view a listing of the optional application licenses (options) installed in your application, select **Help > About Tektronix Real Time Signal Analyzer**.

Application licenses can be added to your software. For the latest information on available licenses, see the [Tektronix Web site](#).

Documentation

In addition to the application Help, the following documents are available. For the most up to date documentation, visit the Tektronix Web site www.tek.com/downloads.

- **SignalVu Reference** (Tektronix part number 077-0224-XX). This document provides a brief overview of the SignalVu software. It identifies elements of the SignalVu screen, elements of different displays and includes a menu tree. The Reference Manual is provided as a printable PDF file.
- **SignalVu Programmer Manual** (077-0223-XX). This document provides supplementary information about the remote commands for the SignalVu software. The Programmer Manual is provided as a printable PDF file. For detailed descriptions of the remote commands, see the *RSA6100 Series Real-Time Spectrum Analyzers*, *RSA5100 Series Real-Time Signal Analyzers Programmer Manual* and the *DPO7000*, *DPO7000B/C*, *DSA7000B/C*, *MSO70000/C*, *MSO5000*, and *DPO5000 Series Digital Oscilloscopes Programmer Manual*.
- **SignalVu Printable Help Document (PDF)** (077-0225-XX). A PDF file version of the help that can easily be printed.

The SignalVu documentation PDFs are located on the *Optional Applications Software for Windows-Based Oscilloscopes* DVD.

The most recent versions of the product documentation, in PDF format, can be downloaded from www.tek.com/manuals. You can find the manuals by searching on the product name.

You can find all product related documentation on the Tektronix Web site at www.tek.com/manuals. Browse www.tek.com for additional information related to applications and solutions.

Video tutorials

You can browse the Tektronix YouTube channel (www.youtube.com/user/tektronix) to find video tutorials about various topics related to your product. You can also subscribe to the Tektronix YouTube channel to keep up with new postings.

Searching for topics

For example, you can watch a video tutorial about using the WLAN Presets. To find a video on this topic, do the following. The following image shows you what the Tektronix YouTube Channel looks like.

1. Click on the search icon located just above the video you see when the page first loads.

NOTE. This icon allows you to search the Tektronix YouTube channel specifically. The search icon located at the top of the page allows you to search all of YouTube .

2. Type in the keyword “WLAN” in the search field.
3. Click the search icon to start the search.
4. Videos related to the topic will appear. Click a video to view it.

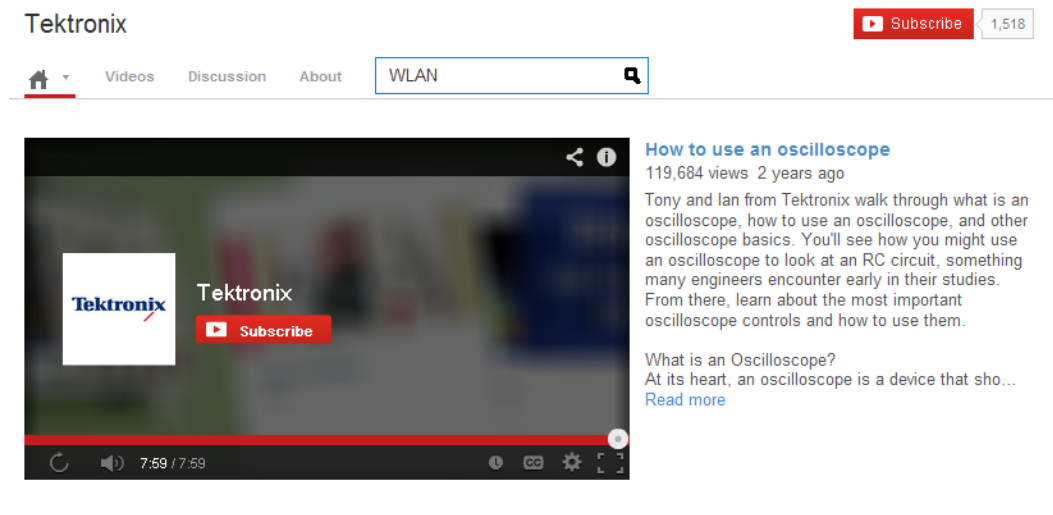

Tektronix Tutorials

Tektronix explains the basics about every day test and measurement equipment that play an important role for engineers.

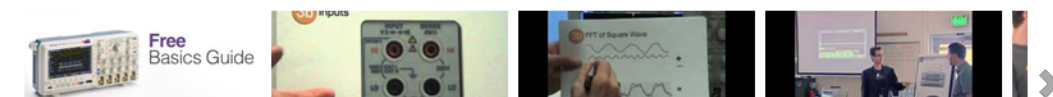

Connecting Signals and Selecting the Analysis Channel

SignalVu analyzes signals acquired by the oscilloscope. The SignalVu software analyzes one, two, or four signals at a time, so you need to specify which oscilloscope input channels to use. Math and Ref channels can also be selected.

To specify which oscilloscope channel is analyzed:

1. Select **Settings > Acquire** to display the Acquire control panel.
2. Select the desired signal type from the **Signal Input** drop-down list along the left side of the control panel. Available choices are **RF** (uses one oscilloscope channel), **IQ** (uses two channels), and **Diff IQ** (uses four channels).
3. On the **Vertical** tab, use the **Source** drop-down list(s) to select the channels to analyze.
4. Use the oscilloscope controls in the TekScope application to achieve a stable, triggered signal.

For information on the oscilloscope input signal capabilities and how to trigger on a signal, see the oscilloscope's Help. Note that SignalVu does not control triggering on the oscilloscope; you will need to use the oscilloscope triggering functions to achieve a stable, triggered signal on the oscilloscope.

Front-Panel Controls

The front-panel controls remain dedicated to oscilloscope control functions when SignalVu is running. The front-panel buttons and knobs of the oscilloscope do not have any effect on the SignalVu software settings.



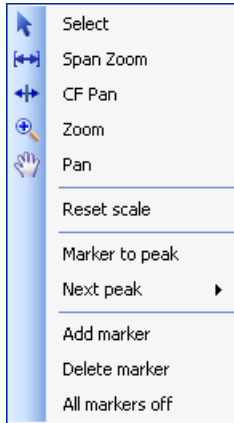

NOTE. *One button that affects the SignalVu software is the Run/Stop button. Pressing the Stop button will halt data acquisition in the SignalVu software.*

Touch-Screen Actions

You can use the touch screen to change marker settings and how waveforms are displayed by using the Touch-screen Actions menu.



To use the Touch-screen Actions menu, touch the display in a graph area and hold for one second, then remove your finger. You can also use a mouse to display the Touch-screen Action menu by clicking the right mouse button.

Icon	Menu	Description
	Select	Selects markers and adjusts their position.
	Span Zoom	Zooms the graph area about the selected point. Touch the graph display at a point of interest and drag to increase or decrease the span about the point of interest. Span Zoom adjusts the span control and can affect the acquisition bandwidth.
	CF Pan	Adjusts the Center Frequency according to horizontal movement.
	Zoom	Adjusts horizontal and vertical scale of the graph. The first direction with enough movement becomes the primary scale of adjustment. Adjustment in the secondary direction does not occur until a threshold of 30 pixels of movement is crossed. Dragging to the left or down zooms out and displays a smaller waveform (increases the scale value). Dragging to the right or up zooms in and displays a larger waveform (decreases the scale value).
	Pan	Adjusts horizontal and vertical position of the waveform. The first direction with enough movement becomes the primary direction of movement. Movement in the secondary direction does not occur until a threshold of 30 pixels of movement is crossed.
-	Reset Scale	Returns the horizontal and vertical scale and position settings to their default values.
-	Marker to peak	Moves the selected marker to the highest peak. If no marker is turned on, this control automatically adds a marker.
-	Next Peak	Moves the selected marker to the next peak. Choices are Next left, Next right, Next lower (absolute), and Next higher (absolute).
-	Add marker	Defines a new marker located at the horizontal center of the graph.
-	Delete marker	Removes the last added marker.
-	All markers off	Removes all markers.

Touch-Screen Menu for Spurious Display

The Touch-screen actions menu in the Spurious display has some minor changes compared to the standard version used in other displays.

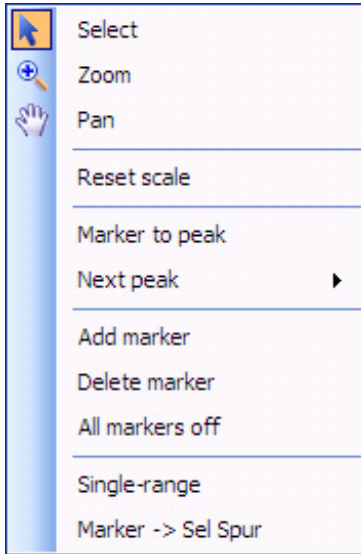

Icon	Menu	Description
-	Single-range	Changes the current multi-range display to a single range display. The displayed range is the range in which you display the touchscreen-actions menu. Selecting Single-range from the menu is equivalent to selecting Single on the Settings > Parameters tab.
-	Multi-range	Changes the current single-range display to a multi-range display. Selecting Multi-range from the menu is equivalent to selecting Multi on the Settings > Parameters tab.
-	Marker -> Sel Spur	Moves the selected marker to the selected spur.

SignalVu Markers Menu

The SignalVu Markers menu appears when you right-click (or touch and hold) on a marker. The SignalVu Markers menu enables you to assign a marker to a different trace, synchronize markers with oscilloscope, cursors and pan the trace to place the marker at the measurement frequency.

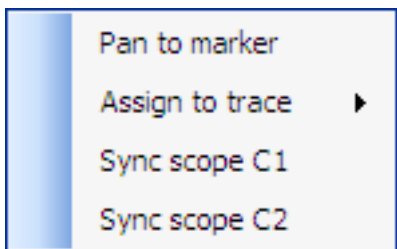

Icon	Menu	Description
-	Pan to marker	Adjusts horizontal position of the waveform to locate the selected marker at the measurement frequency.
-	Assign to trace	Assigns the selected marker to Trace 1, Trace 2, Trace 3 or the Math trace. A trace must be enabled to assign a marker to it.
-	Sync scope C1	Synchronizes the position of oscilloscope Cursor 1 with the location of the selected marker. Turns on cursors if necessary.
-	Sync scope C2	Synchronizes the position of oscilloscope Cursor 2 with the location of the selected marker. Turns on cursors if necessary.

Elements of the Display

General application window areas. The main areas of the application window are shown in the following figure.

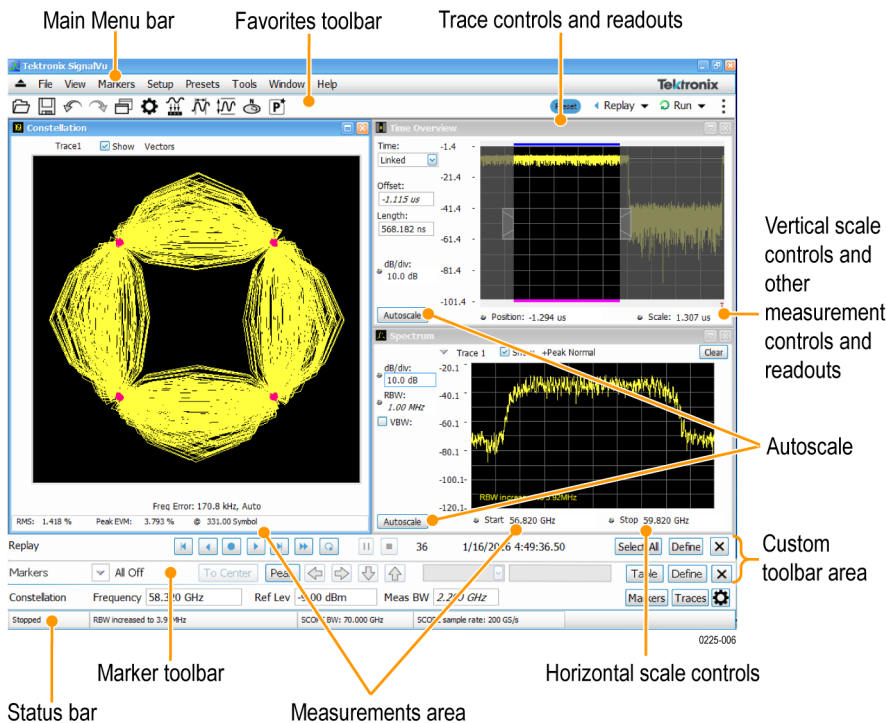

Specific elements of the application display window. Specific elements of the display are shown in the following figure. More detailed information is available in the [Menus](#) section.

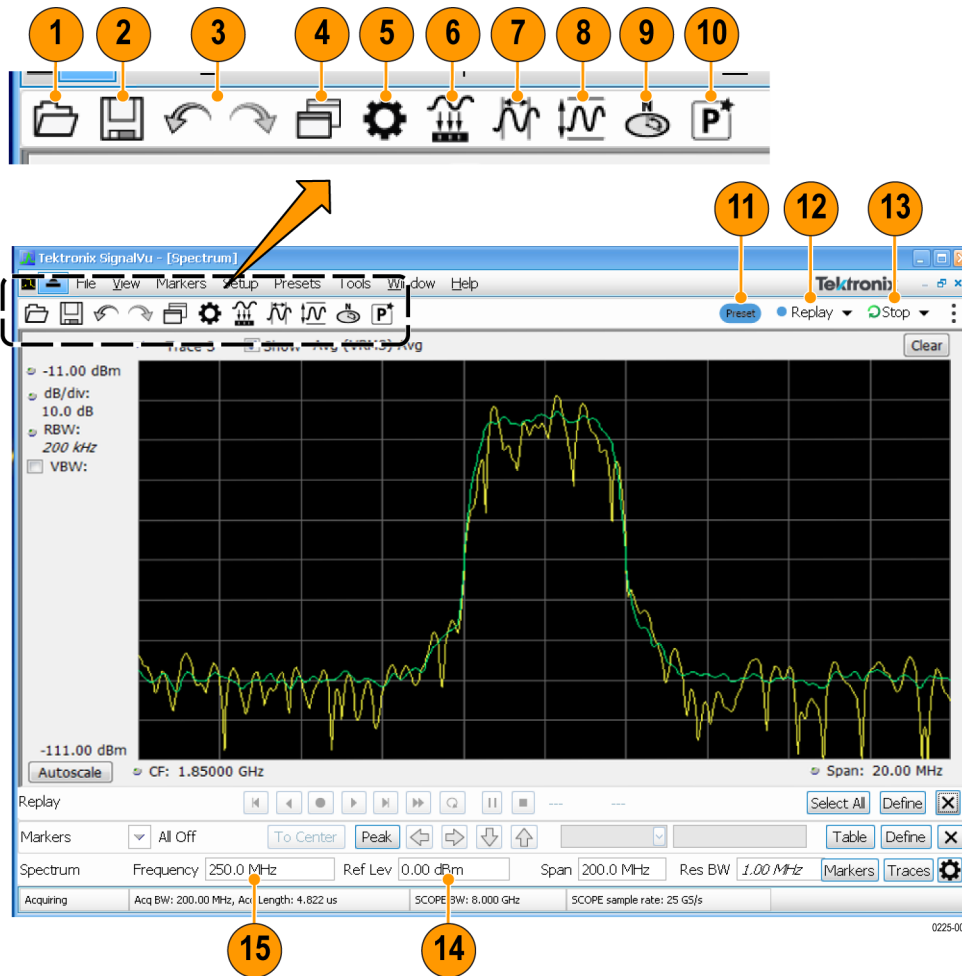

Ref number	Setting	Description
1	Recall	Displays the Open window in order to recall setup files, acquisition data files, or trace files.
2	Save	Opens the Save As dialog in order to save setup files, pictures (screen captures), acquisition data files, or export measurement settings.
3	Undo/Redo	Undoes or redoes the previous edit to a display or measurement settings, a preset, or a measurement change.
4	Displays	Opens the Select Displays dialog box so that you can select measurement displays.
5	Settings	Opens the Settings control panel for the selected display. Each display has its own control panel.
6	Acquire	Opens the Acquire control panel, which displays the Sample Rate and Record length of the recalled waveform file.
7	Analysis	Opens the Analysis control panel so that you can define the analysis settings such as frequency, analysis time, and units.

Ref number	Setting	Description
8	Amplitude	Opens the Amplitude control panel so that you can define the Reference Level, configure internal attenuation, and specify external gain/loss corrections.
9	GNSS/Antenna	Opens the GNSS/Antenna control panel so that you can configure and activate an external GNSS receiver and antenna.
10	Favorite User Presets	Click to select from a list of custom favorite User presets and load the selected preset. For more detailed information, see the Make a User preset a Favorite preset topic.
11	Preset	Recalls the Main preset.
12	Replay	Runs a new measurement cycle on the existing acquisition data record using any new settings. See the Replay menu topic for more details.
13	Run and Run/Stop toolbar	<ul style="list-style-type: none"> ■ Run menu and Run/Stop toolbar Starts and stops data acquisitions and specifies the run conditions. For example, if you select Single in the Run/Stop toolbar (or Run Single in the Run menu), a single measurement cycle is run. If you select Continuous in the Run/Stop toolbar (or Run Continuous in the Run menu), the data acquisition runs until stopped. ■ Run menu The Run menu also includes Resume and Abort. Resume restarts data acquisition, but does not reset accumulated results, such as Average or MaxHold. This allows you to stop acquisitions temporarily, then continue. Abort immediately halts the current acquisition/measurement cycle. In-process measurements and acquisitions are not allowed to complete. See the Run menu topic for more details.
14	Reference Level	Displays the reference level. To change the value, click the text and enter a number using a keyboard, or use a mouse scroll wheel.
15	Center Frequency	Displays the Center Frequency. To change the value, click the text and enter the frequency with a keyboard. For fine adjustments, you can use the mouse wheel.

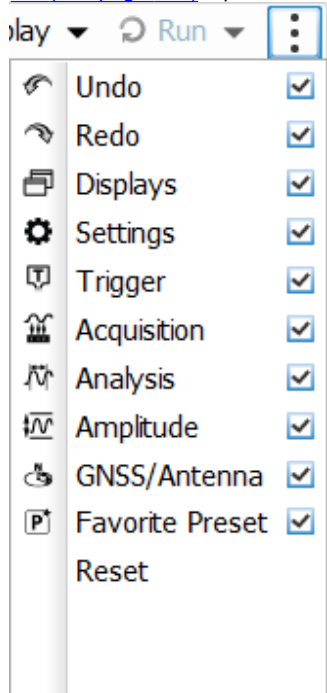
Ref number	Setting	Description
	Main menu bar	Located above the Favorites toolbar, it contains access to menus. For detailed information, see the Main Menu (see page 576) topic.
	⋮	<p>The Edit Favorites icon allows you access the below menu, which allows you to edit the contents of the Favorites bar. For more information, see the Favorites bar (see page 588) topic.</p> 

Presets

Main menu bar: Presets

SignalVu includes a set of configuration files that are tailored to specific applications. These configuration files, referred to as Application Presets, open selected displays and load settings that are optimized to address specific application requirements. You can add to the default application presets by creating your own application (user) presets. See [Creating User Presets \(see page 15\)](#). You access the application presets through the Presets menu item.

Preset Options

Select the **Presets > Preset Options** menu to open the Options control panel. This panel does the following. Once you have chosen these settings, you can access any preset or list of presets from **Presets** on the menu bar.

- **Preset type:** Select the Preset type.
- **Presets:** Select the specific preset you want to display for the selected preset type.
- **Preset action:** Selecting a preset from the Preset drop down menu results in one of two actions depending on which item you choose in the **Preset action** list: **Recall selected preset** will immediately execute a preset when it is selected from the Presets menu. **Show list** will display a list of preset subtypes from which you can then select the preset you want to recall.

If you select **Recall selected preset** from the Preset action list, click in the Presets list box on the preset you want to recall. The selected preset, indicated by a tan background highlight, is the Preset that is recalled.

Available Presets

Select **Presets** from the Main Menu bar to access the presets shown in the following table. Preset subtypes are managed in the **Presets > Preset Options (see page 13)** menu.

Presets	Description
Main	This Preset is the original factory preset used with software versions 1.0 through 3.2. This version of the factory preset is included to allow users to maintain compatibility with existing remote control software.
Standards	
WLAN (see page 179)	This preset sets the instrument to display the WLAN Summary, WLAN Constellation, and SEM displays. After you select the standards and bandwidth, the software configures these displays to apply the parameters appropriate for typical WLAN analysis tasks.
P25 (see page 309)	This preset sets the instrument to display the MCPR, Time Overview, P25 Summary, and P25 Constellation displays. After you select the standard and modulation type, the software configures these displays to apply the parameters appropriate for typical P25 analysis tasks.

Presets	Description
Bluetooth (see page 393)	This preset set the instrument to display a particular set of displays depending on which combination of standard (Low Energy or Basic Rate) and test setup (one of up to eight) you select. After you select the standard and test setup, the software configures the displays to apply the parameters appropriate for typical Bluetooth analysis tasks.
LTE (see page 353)	This preset loads a set of LTE displays and a test setup, frame structure, and channel bandwidth to perform LTE tests. The software configures these displays to apply the parameters appropriate for LTE analysis tasks.
802.11ad, 802.11ay (see page 215)	This preset loads a set of standards (Control PHY and Single carrier PHY) for 802.11ad and 802.11ay, which is supported in the DPO70000 DX series oscilloscopes, the DPO70000SX (with ATI) series oscilloscopes, and on personal computers running SignalVu-PC for offline analysis. The ATI oscilloscope supports real time data analysis at RF, without any downconverters.
Application	
Time-Frequency Analysis (see page 20)	The Time-Frequency preset configures the instrument with settings suited to analyzing signal behavior over time.
Spectrum Analysis (see page 20)	The Spectrum Analysis application preset provide you with the settings commonly used for general purpose spectrum analysis.
Modulation Analysis (see page 18)	The Modulation Analysis setup application preset provides you with the most common displays used during modulation analysis. Only present when Option SVM is installed.
Pulse Analysis (see page 19)	The Pulse Analysis application preset provides you with the most common displays used during pulse analysis, and makes changes to the default parameters to settings better optimized for pulsed signal analysis. Only present when Option SVP is installed.
Spur Search Multi Zone 9k-1GHz	The Spur Search application preset configures the instrument to show the Spurious display with the frequency range set to 9 kHz to 1 GHz.
User (Favorites)	
User Preset 1 (see page 15)	This Preset is provided as an example for you to create your own Presets. This preset displays the Spectrum, Spectrogram, Frequency vs Time, and Time Overview displays.
User Preset 2 (see page 15)	This Preset is provided as an example for you to create your own Presets. This preset displays the Spurious display configured to test for Spurious signals across four ranges.
Other user presets (see page 15)	User presets you create and save will appear in the Preset drop down menu of the User Presets window. Any User preset that you have designated as a Favorite will be marked with an *.

Recalling a Preset

NOTE. You can also click the **Preset** button on the right-hand side of the menu bar to load the Main preset.

To recall a named (User) preset:

- Select **Presets > User**. The Preset at the top of the Presets list will be recalled (if Preset action is set to Recall named preset). To change the user preset, select **Presets > Preset Options**.

Creating User Presets

You can add your own application presets to the list that appears in the User Presets dialog box. Create a Setup file and save a copy of it to **C:\SignalVu Files\User Presets**. The name you give the file will be shown in the User Presets list. For instructions on how to save a Setup file, see [Saving Data \(see page 567\)](#).

Configuring a User Preset

After you have selected a preset:

- Adjust the span to show the necessary detail.

User (Favorites) Presets

Select the **Presets > User (Favorites)** menu to open the User Presets window. The Presets drop-down list shows the three default user presets provided with the software.

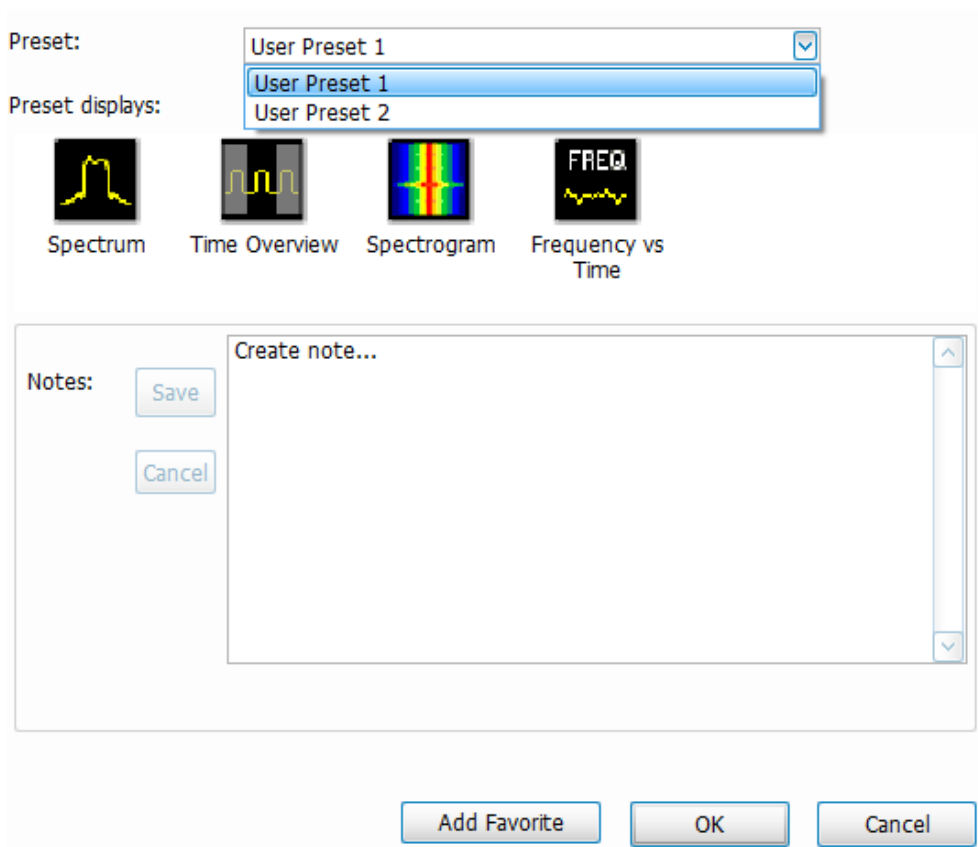

- **User Preset 1:** Sets up the Spectrum, Time Overview, Spectrogram, and Frequency vs Time displays.
- **User Preset 2:** Sets up the Spurious display.

Make a User preset

You can add your own User presets to the list that appears in the User Presets dialog box as follows:

1. Select **Save As** from the **File** menu to open the **Save As** dialog box.
2. Select to save to C:\SIGNALVU\User Presets.
3. Enter a file name. The name you give the file will appear in the User Presets dialog box list.
4. Select a .Setup file type from the **Save as type** drop-down list.
5. Click **Save**.

Make a User preset a Favorite preset. You can place one or more User presets on the Favorites bar as a Favorite preset for quick access. Do this as follows:

1. Select **Presets > User** to open the User Presets window.
2. Select the desired preset from the Presets drop-down list.
3. Click the **Add Favorite** button. An * will appear next to the selected preset. You can do this for more than one preset.

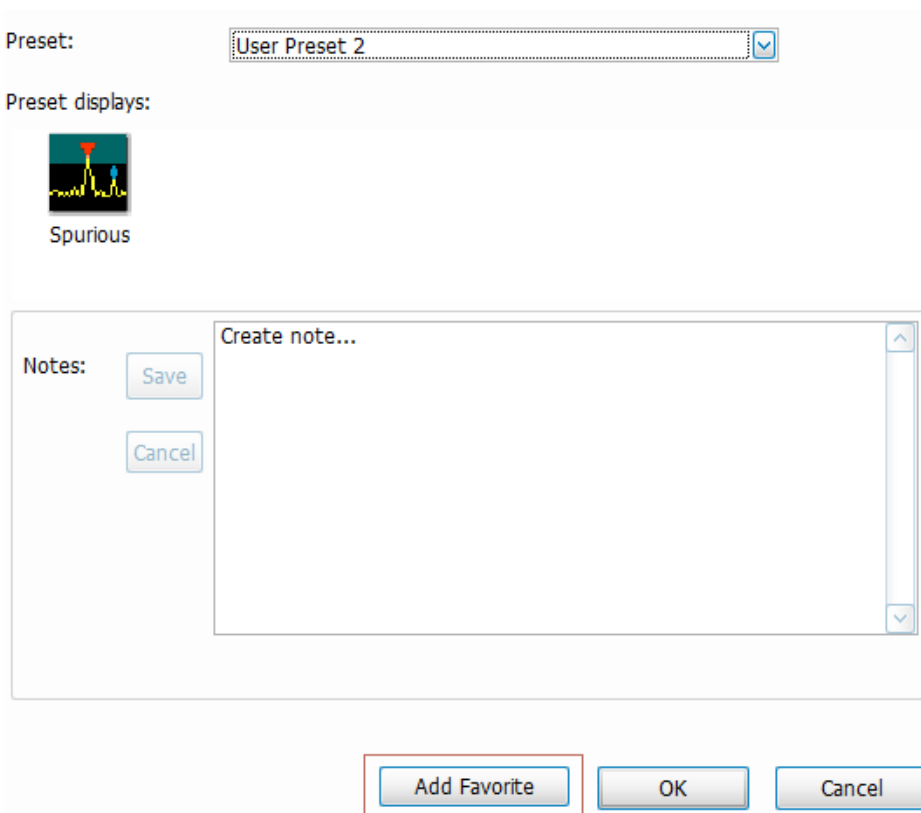

4. If desired, add a note for this preset in the Notes field and then click the **Save** button. Whenever you recall this preset, this note will appear in a separate window, as shown below.

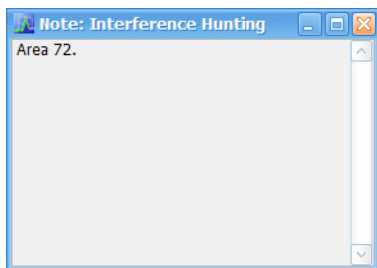

5. Click the **OK** button in the User Presets window.
6. Click on the **P*** icon on the Favorites bar and you will see the recently added Favorite preset listed.
7. When you are ready to recall a Favorite preset, click **P*** and select the preset from the list that appears.
8. To remove a Favorite preset, select it from the User Presets window and click the **Remove Favorite** button. The * should disappear from the list.

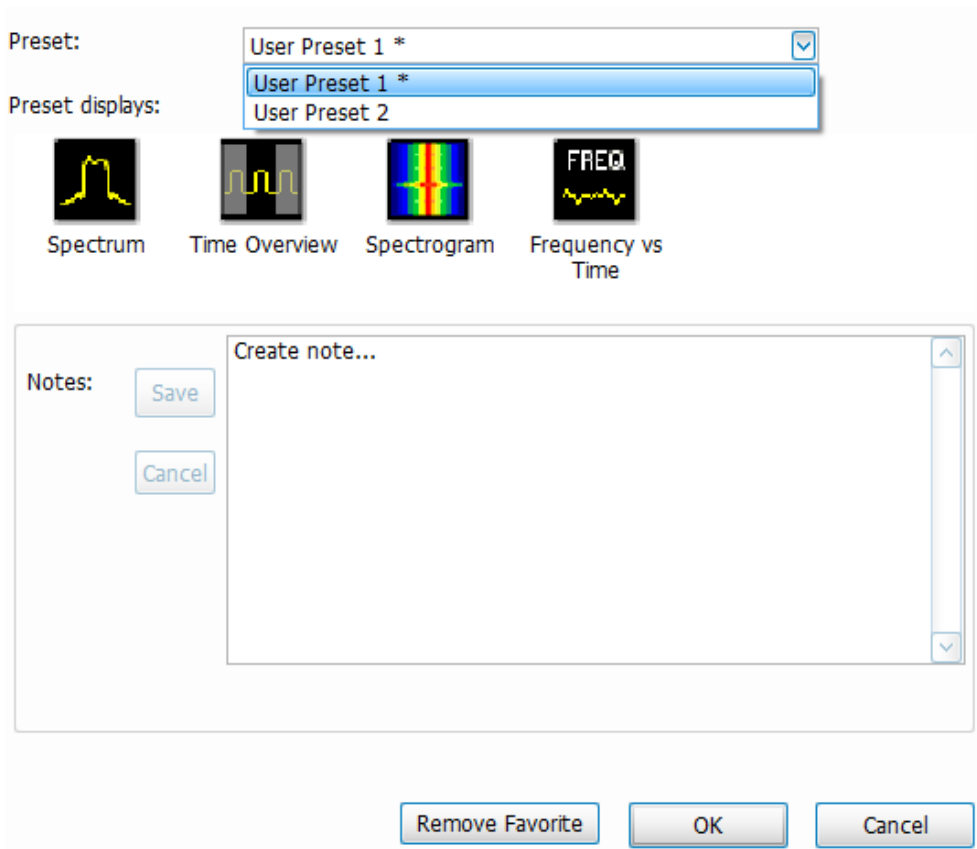

Standards Presets

- **WLAN:** The IEEE wireless LAN (WLAN) standards specify the wireless interface between two wireless clients or a wireless client and a base station. The WLAN presets allow you to access displays preconfigured for the WLAN standards and bandwidths you select.

NOTE. More information is available about WLAN standards [here](#). You can also watch a video tutorial about WLAN Presets at www.youtube.com/user/tektronix. Click [here](#) for information about searching the Tektronix YouTube channel for videos.

- **P25:** The Project 25 (P25) TIA-102 standards specify the design of interoperable digital two-way wireless communications products. The P25 presets allow you to access displays preconfigured for the P25 standards you select. You can choose either the Phase 1 (FDMA) standard or the Phase 2 (TDMA) standard.

NOTE. More information is available about P25 standards [here](#).

- **Bluetooth:** The Bluetooth standards specify short range RF signals. The Bluetooth presets allow you to access displays preconfigured for the specific Bluetooth standards you select: Basic Rate, Low Energy, and Enhanced Data Rate (EDR).

NOTE. More information is available about Bluetooth standards [here](#).

- **LTE:** The LTE standards ensure that the RF signals meet 3GPP measurements specifications. The LTE presets test setups load pre-configured displays and control setting as suggested by the selected standard to accelerate the test setup of the analyzer.

NOTE. More information is available about LTE standards and test setups [here](#).

- **802.11ad and 802.11ay:** Supports the set of standards for 802.11ad (Control PHY and Single carrier PHY) and for 802.11ay (single carrier PHY at RF up to 70 GHz in DPO70000 DX series oscilloscopes, the DPO70000SX (with ATI) series oscilloscopes, and on personal computers running SignalVu-PC for offline analysis. The ATI oscilloscope supports real time data analysis at RF, without any downconverters.

NOTE. More information is available about 802.11ad and 802.11ay standards [here](#).

Modulation Analysis

The Modulation Analysis application preset opens the following displays:

- **Signal Quality:** Shows a summary of modulation quality measurements (EVM, rho, Magnitude Error, Phase Error, and others).
- **Constellation:** Shows the I and Q information of the signal analyzed in an I vs. Q format.
- **Symbol Table:** Shows the demodulated symbols of the signal.

To use the Modulation Analysis preset (assuming the Preset action is set to Show list in the Presets tab of the Options control panel):

1. Select **Presets > Application**. Select **Modulation Analysis** and then click **OK**.
2. Set the measurement frequency.
3. Set the reference level so that the peak of your signal is about 10 dB below the top of the spectrum display.
4. Set the modulation parameters for your signal. This includes the Modulation Type, Symbol Rate, Measurement Filter, Reference Filter and Filter Parameter. All of these settings are accessed by pressing the Settings button.

For most modulated signals, the Modulation Analysis application preset should present a stable display of modulation quality. Additional displays can be added by using the Displays button, and other settings can be modified to better align with your signal requirements.

Pulse Analysis

The Pulse Analysis application preset opens the following displays:

- **Time Overview:** Shows amplitude vs. time over the analysis period.
- **Pulse Trace:** Shows the trace of the selected pulse and a readout of the selected measurement from the pulse table.
- **Pulse Table:** This shows a full report for the user-selected pulse measurements.
- **Pulse Cumulative Histogram:** Shows a histogram that support statistics over multiple acquisitions. It shows basic pulse measurements and has user definable bins for the cumulated pulses. It provides detailed information about the bins and its content.
- **Pulse Cumulative Statistics Table:** Shows a statistics table that provides information on Standard Deviation, Average, Max, and Min over different acquisitions.
- **Pulse-Ogram:** Shows a correlated Amplitude Time vs Time and frequency vs time display, where Y is pulse parameter, X is pulse duration, and Z is number of pulses. It shows you a definable number of stacked pulses in amplitude versus time (reference being the trigger time), as well as in amplitude versus frequency. This display will also show the information as an 'ogram, where the pulse number is being scanned over time.

You can make a selected pulse and measurement appear in the Pulse Trace display by highlighting it in the Pulse Table. Key pulse-related parameters that are set by the Pulse Analysis application preset are:

- **Measurement Filter:** No Filter.
- **Measurement Bandwidth:** This is set to the maximum real-time bandwidth of the instrument. Note: The label on the "Measurement Bandwidth" setting is just "Bandwidth". Like the main instrument

Preset command and the other application presets, the Pulse Analysis application preset also sets most other instrument controls to default values.

- **Analysis Period:** This is set to 2 ms to ensure a good probability of catching several pulses for typical signals.

To use the Pulse Analysis preset (assuming the Preset action is set to Show list in the Presets tab of the Options control panel):

1. Select **Presets > Application**. Select **Pulse Analysis** and then click **OK**.
2. Set the Center Frequency control to the carrier frequency of your pulsed signal.
3. Set the Reference Level to place the peak of the pulse signal approximately 0-10 dB down from the top of the Time Overview display.

You may need to trigger on the signal to get a more stable display. This is set up with the oscilloscope's controls. A rising-edge trigger works well for many pulsed signals.

4. Set the Analysis Period to cover the number of pulses in your signal that you want to analyze. To do this, click in the data entry field of the Time Overview window and set the analysis length as needed.

***TIP.** See the [Pulsed RF \(see page 271\)](#) topic for more information about pulse measurements.*

Spectrum Analysis

The Spectrum Analysis application preset opens a Spectrum display and sets several parameters. The Spectrum Analysis preset sets the analyzer as follows.

- **Spectrum Analysis :** Sets the frequency range to maximum for the analyzer, and sets the RF/IF optimization to **Minimize Sweep Time**.

To use the Spectrum Analysis preset (assuming the Preset action is set to Show list in the Presets tab of the Options control panel):

1. Select **Presets > Application**. Select **Spectrum Analysis** and then click **OK**.
2. Set the measurement frequency using the front-panel knob or keypad.
3. Adjust the span to show the necessary detail.

Time-Frequency Analysis

The Time-Frequency Analysis application preset opens the following displays:

- **Time Overview:** Shows a time-domain view of the analysis time 'window'.
- **Spectrogram:** Shows a three-dimensional view of the signal where the X-axis represents frequency, the Y-axis represents time, and color represents amplitude.

- **Frequency vs. Time:** This display's graph plots changes in frequency over time and allows you to make marker measurements of settling times, frequency hops, and other frequency transients.
- **Spectrum:** Shows a spectrum view of the signal. The only trace showing in the Spectrum graph after selecting the Time-Frequency Analysis preset is the Spectrogram trace. This is the trace from the Spectrogram display that is selected by the active marker. Stop acquisitions with the Run button because its easier to work with stable results. In the Spectrogram display, move a marker up or down to see the spectrum trace at various points in time.

The analysis period is set to 5 ms.

To use the Time-Frequency Analysis preset (assuming that Time-Frequency Analysis is the selected preset on the list of Application Presets and Preset action is set to Recall selected preset):

1. Select **Presets > Application**. Select **Time-Frequency Analysis** and then click **OK**.
2. When the preset's displays and settings have all been recalled and acquisitions are running, adjust the center frequency and span to capture the signal of interest.
3. Set the Reference Level to place the peak of the signal approximately 0-10 dB down from the top of the Spectrum graph.
4. If the signal is transient in nature, you might need to set a trigger to capture it. You will need to use the oscilloscope triggering functions to capture the signal.

When the signal has been captured, the spectrogram shows an overview of frequency and amplitude changes over time. To see frequency transients in greater detail, use the Frequency vs. Time display.

The Time-Frequency Analysis preset sets the analysis period to 5 ms. The Spectrum Span is 40 MHz. The RBW automatically selected for this Span is 300 kHz. For a 300 kHz RBW, the amount of data needed for a single spectrum transform is 7.46 μ s. A 5 ms Analysis Length yields 671 individual spectrum transforms, each one forming one trace for the Spectrogram to display as horizontal colored lines. This preset scales the Spectrogram time axis (vertical axis) to -2, which means that the Spectrogram has done two levels of time compression, resulting in one visible line for each four transforms. This results in 167 lines in the Spectrogram for each acquisition, each covering 29.84 μ s.

Setting Options

Menu Bar: Tools > Options

There are several settings you can change that are not related to measurement functions. The Option settings control panel is used to change these settings.

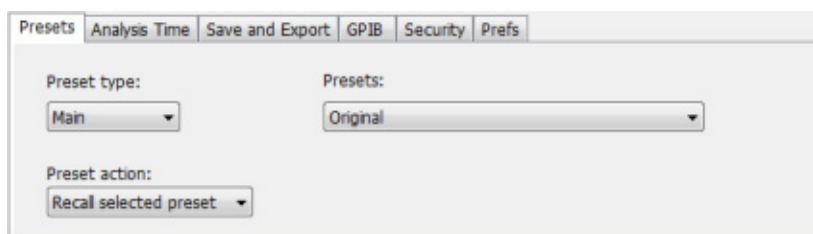

Settings tab	Description
Presets	Use this tab to configure Presets. You can specify the action to take when a preset is recalled and which preset to recall when the Preset button is selected.
Analysis Time	Use this tab to specify the method used to automatically set the analysis and spectrum offsets when the Time Zero Reference (see page 525) is set to Trigger.
Save and Export	Use this tab to specify whether or not save files are named automatically and what information is saved in acquisition data files.
GPIB	Do not use this tab to set the GPIB address for the instrument. Use the Utilities > GPIB Configuration control window in the TekScope application to set the instrument GPIB address.
Security	Selecting the Hide Sensitive readouts check box causes the instrument to replace measurement readouts with a string of asterisks.
Prefs	Use this tab to select different color schemes for the measurement graphs and specify how markers to automatically jump to the next peak (see page 515) when you drag them. When this setting is deselected, you can drag a marker to any point on the trace.

Presets

The Presets tab in the Options control panel allows you to specify actions taken when you press the Preset button. You can read more about this tab [here \(see page 13\)](#).

Analysis Time

The Analysis Time tab in the Options control panel is used to specify the method used to automatically set the analysis and spectrum offsets when the [Time Zero Reference \(see page 525\)](#) is set to Trigger. The available settings are:

- Include trigger point – Selects an algorithm that uses the measurements to determine how far in advance of the trigger to set the analysis offset. The analyzer tries to ensure that data about the trigger point is included in the analyses.
- Start at trigger point (legacy) – The method used by the instrument in prior versions, which sets the Analysis Offset to zero when possible. The analyzer tries to ensure that data following the trigger point is included in the analyses. Use this method if your measurements or procedures depend on past behavior of the Auto Analysis Offset function.

Save and Export

The Save and Export tab allows you to specify whether or not files are saved with an automatically generated name, and how much data is saved in an acquisition data file.

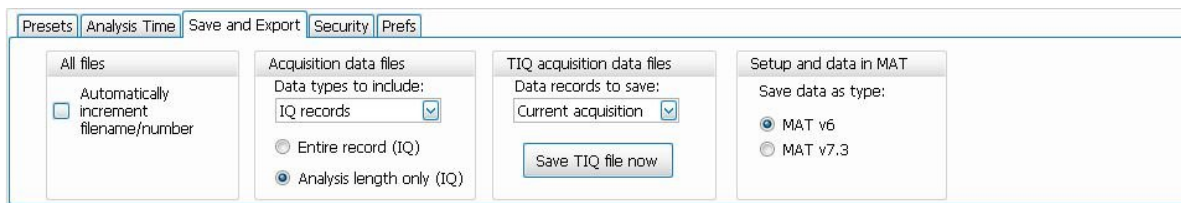

All files. The Automatically increment filename/number function can automatically name saved files by appending a number to a base file name. Use this tab to enable/disable automatic naming of files. For example, if **Automatically Increment Filename Number** is disabled, when you select Save from the File menu, you will have to enter a name for the file.

Acquisition data files. This setting specifies whether saved data files include the entire acquisition record or only the data for the analysis length (a subset of the acquisition record). You can choose from the following:

- IQ records: Includes IQ records
- DPX spectra: Includes DPX spectra
- Both: Includes both IQ records and DPX spectra

You can also select to include an entire IQ record or just the analysis length of it.

TIQ acquisition data files. Specifies which data records to save. You can choose from the following:

- Current acquisition: Saves the current acquisition.
- Current frame: If Fast Frame is enabled, saves only the current frame. The current frame is the one most recently analyzed.
- Selected frames: If Fast Frame is enabled, saves the specified frames.
- All in history: Saves all acquisition records in the history.
- Save TIQ file now: Invokes the Save As dialog box with the Save as type drop-down list set to TIQ.

Setup and data in MAT. Specifies which MATLAB data type to save. You can choose from the following:

- MAT v6 (Level 5)
- MAT v7.3 (Level 7.3)

MATLAB Level 5 file size is limited to 2 GB. If you try to save more than 2 GB in MATLAB Level 5 (v6 format), the following warning shows and prompts you to select Level 7.3 format.



Security

The Security tab enables you to hide sensitive readouts in displays with readouts, such as the OFDM Summary display.

Prefs

The Prefs tab enables you to set properties that apply to all displays.

Color scheme. The Color scheme setting provides three color schemes for the measurement graphs. The color scheme setting does not change the overall instrument application or Windows color scheme.

- Thunderstorm – This scheme displays graphs in shades of blue. This provides a less vibrant color scheme than the default setting.
- Blizzard – This scheme displays graphs with a white background to save ink when printing.
- Classic – The default setting. This scheme displays the graph area with a black background.

Markers snap to peaks when dragged. When selected, this setting causes markers to automatically jump to the [next peak \(see page 515\)](#) when you drag them. When this setting is deselected, you can drag a marker to any point on the trace.

Selecting Displays

Main menu bar: Setup > Displays

Favorites toolbar: 

Use the **Select displays** dialog to choose the displays that appear on the screen.

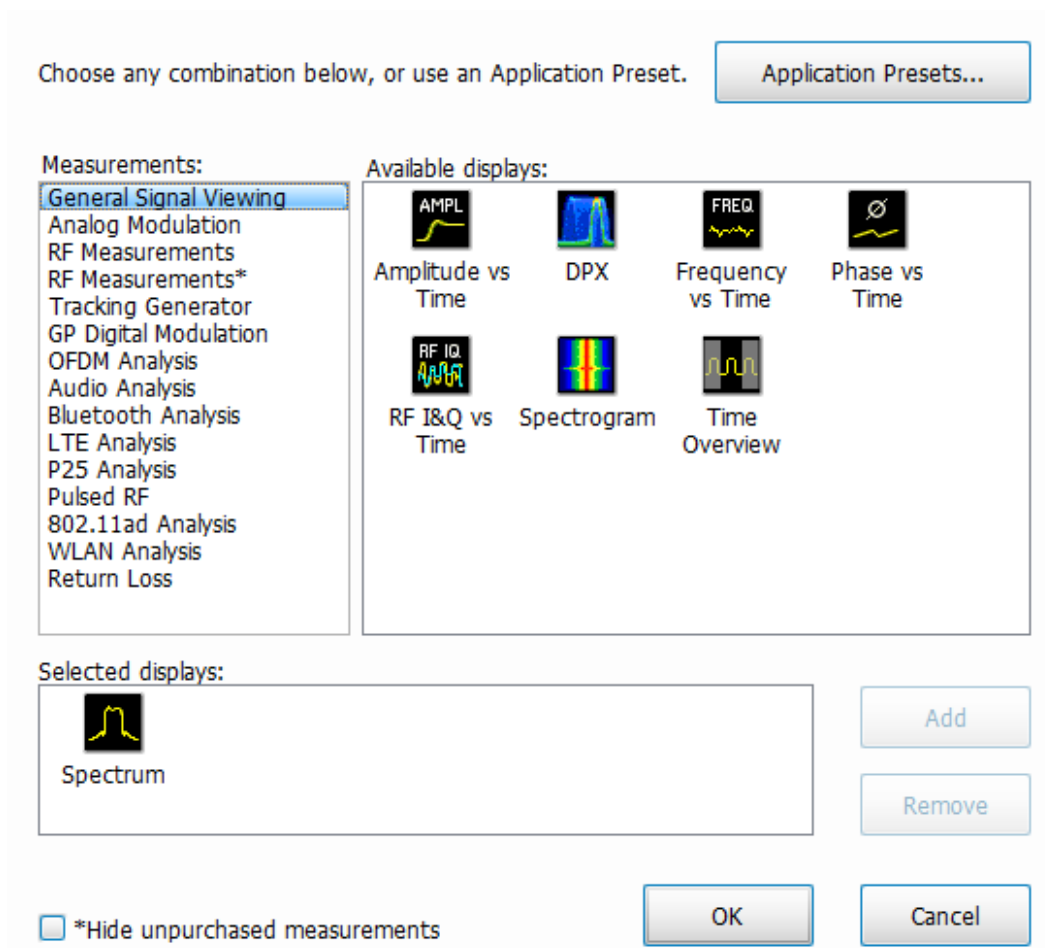

To select displays:

1. Select **Setup > Displays** or click the icon.
2. Select one of the choices under **Measurements**. The measurement chosen determines the choices available in **Available displays**.
3. Double-click the desired display in the **Available displays** box or select the desired display and click **Add**.
4. Click **OK**.

Interactions Between Displays

Different displays can require different settings, for example acquisition bandwidth, analysis length, or resolution bandwidth, to achieve optimum results. The application automatically adjusts some settings to optimize them for the selected display. The check mark indicator in the upper, left-hand corner of the display indicates the display for which the application is optimized. Depending on application settings, some displays might stop displaying results if they are not the selected display.

Available Measurements

Available automatic measurements include RF power measurements, OFDM analysis, WLAN analysis, APCO P25 analysis, Bluetooth analysis, LTE analysis, 802.11.ad and 802.11ay, audio analysis, analog modulation measurements, digital modulation measurements, and pulsed RF measurements.

See the specific measurement topic in this document for information about how to take a measurement.

Power measurements

Measurement	Description
Channel Power	The total RF power in the selected channel (located in the Chan Pwr and ACPR display).
Adjacent Channel Power Ratio (ACPR)	Measure of the signal power leaking from the main channel into adjacent channels.
Signal Strength	Measure of signal strength (channel power and peak channel power).
Multi-Carrier Power Ratio (MCPR)	The ratio of the signal power in the reference channel or group of channels to the power in adjacent channels.
Peak/Avg Ratio	Ratio of the peak power in the transmitted signal to the average power in the transmitted signal (located in the CCDF display).
CCDF	The Complementary Cumulative Distribution Function (CCDF) shows how much time a signal spends at or above a given power level relative to the average power of a measured signal.

OFDM analysis

Measurement view	Description
Channel Response	Plots the channel response (magnitude or phase) versus the subcarrier or frequency. Here, the channel refers to all sources of signal frequency response impairment up to the analyzer input, including the transmitter itself, as well as any transmission medium through which the signal travels between the transmitter and the analyzer.
Constellation	Shows the WLAN signal modulation amplitude and phase in I (horizontal) versus Q (vertical) form. For multicarrier WLAN OFDM signals, the points show all data symbol subcarriers' modulation. For single-carrier 802.11b, each point corresponds to a single modulated chip.
EVM	The normalized RMS value of the error vector between the measured signal and the ideal reference signal over the analysis length. The EVM is generally measured on symbol or chip instants and is reported in units of percent and dB. EVM is usually measured after best-fit estimates of the frequency error and a fixed phase offset have been removed. These estimates are made over the analysis length. Displays RMS and Peak values with location of Peak value.
Flatness	Ratio of the peak power in the transmitted signal to the average power in the transmitted signal
Mag Error	The RMS magnitude difference between the measured signal and the reference signal magnitude. Displays RMS and Peak values with location of Peak value.
Phase Error	The RMS phase difference between the measured signal and the ideal reference signal. Displays RMS and Peak values with location of Peak value.
Power	shows the data symbols' individual subcarrier Power values versus symbol interval (time) and subcarrier (frequency).

WLAN measurements

Measurement view	Description
Channel Response	Plots the channel response (magnitude or phase) versus the subcarrier or frequency. Here, the channel refers to all sources of signal frequency response impairment up to the analyzer input, including the transmitter itself, as well as any transmission medium through which the signal travels between the transmitter and the analyzer.
Constellation	Shows the WLAN signal modulation amplitude and phase in I (horizontal) versus Q (vertical) form. For multicarrier WLAN OFDM signals, the points show all data symbol subcarriers' modulation. For single-carrier 802.11b, each point corresponds to a single modulated chip.
EVM	The normalized RMS value of the error vector between the measured signal and the ideal reference signal over the analysis length. The EVM is generally measured on symbol or chip instants and is reported in units of percent and dB. EVM is usually measured after best-fit estimates of the frequency error and a fixed phase offset have been removed. These estimates are made over the analysis length. Displays RMS and Peak values with location of Peak value.
Flatness	Ratio of the peak power in the transmitted signal to the average power in the transmitted signal
Mag Error	The RMS magnitude difference between the measured signal and the reference signal magnitude. Displays RMS and Peak values with location of Peak value.
Phase Error	The RMS phase difference between the measured signal and the ideal reference signal. Displays RMS and Peak values with location of Peak value.
Power vs Time	The signal power amplitude versus time. For 802.11b signals, the packet Power-On and Power-Down ramp times are also measured.
Summary	Shows several measurements of WLAN signal quality.
Symbol Table	Shows decoded data values for each data symbol in the analyzed signal packet. For OFDM (non-802.11b) signals, results are presented with subcarrier (frequency) indices in the horizontal dimension and symbol (time) intervals in the vertical dimension. For 802.11b signals, the Preamble, Header, and Data (PSDU) symbol values are presented sequentially, with symbol indices in the left column.

802.11ad and 802.11ay measurements

Measurement view	Description
Constellation	Shows the 802.11ad/ay signal modulation amplitude and phase in I (horizontal) versus Q (vertical) form.
EVM vs Time	Shows the EVM plotted against time in seconds or symbols. The analysis region in which the measurement is done is indicated by a purple line in the Time Overview display to indicate the region of analysis.
Symbol Table	Shows decoded data values for each data symbol in the analyzed signal packet.
Summary	Shows several measurements of 802.11ad/ay signal quality.

Audio measurements

Measurement	Description
Audio Spectrum	Shows audio modulation characteristics. You can choose to show just the spectrum of the audio signal or show the audio spectrum of the signal and the results of distortion measurements. The Audio Spectrum display can show a table listing the frequency of a Harmonic Distortion (HD) and Non-Harmonic Distortion (NHD) and its level. The Spectrum graph indicates these harmonics and non-harmonics with special markers.

Digital Modulation measurements

Measurements for all modulation types except nFSK, C4FM, OQPSK and SOQPSK

Measurement	Description
EVM	The normalized RMS value of the error vector between the measured signal and the ideal reference signal over the analysis length. The EVM is generally measured on symbol or chip instants and is reported in units of percent and dB. EVM is usually measured after best-fit estimates of the frequency error and a fixed phase offset have been removed. These estimates are made over the analysis length. Displays RMS and Peak values with location of Peak value.
Phase Error	The RMS phase difference between the measured signal and the ideal reference signal. Displays RMS and Peak values with location of Peak value.
Mag Error	The RMS magnitude difference between the measured signal and the reference signal magnitude. Displays RMS and Peak values with location of Peak value.
MER (RMS)	The MER is defined as the ratio of I/Q signal power to I/Q noise power; the result is indicated in dB.
IQ Origin Offset	The magnitude of the DC offset of the signal measured at the symbol times. It indicates the magnitude of the carrier feed-through signal.
Frequency Error	The frequency difference between the measured carrier frequency of the signal and the user-selected center frequency of the instrument.
Gain Imbalance	The gain difference between the I and Q channels in the signal generation path. Constellations with gain imbalance show a pattern with a width that is different from height.
Quadrature Error	The orthogonal error between the I and Q channels. The error shows the phase difference between I and Q channels away from the ideal 90 degrees expected from the perfect I/Q modulation. Not valid for BPSK modulation type.
Rho	The normalized correlated power of the measured signal and the ideal reference signal. Like EVM, Rho is a measure of modulation quality. The value of Rho is less than 1 in all practical cases and is equal to 1 for a perfect signal measured in a perfect receiver.

Measurements for QPSK and SOQPSK modulation types

Measurement	Description
EVM	The normalized RMS value of the error vector between the measured signal and the ideal reference signal over the analysis length. The EVM is generally measured on symbol or chip instants and is reported in units of percent and dB. EVM is usually measured after best-fit estimates of the frequency error and a fixed phase offset have been removed. These estimates are made over the analysis length. Displays RMS and Peak values with location of Peak value.
Offset EVM	Offset EVM is like EVM except for a difference in the time alignment of the I and Q samples. For EVM, I and Q samples are collected at the same time, for every symbol decision point (twice the symbol rate for offset modulations). For Offset EVM, the I and Q symbol decision points are time-aligned before collecting the I and Q samples. In this case, one I and one Q sample is collected for each symbol (half as many samples as the same number of symbols for (non-offset) EVM).
Phase Error	The RMS phase difference between the measured signal and the ideal reference signal. Displays RMS and Peak values with location of Peak value.
Mag Error	The RMS magnitude difference between the measured signal and the reference signal magnitude. Displays RMS and Peak values with location of Peak value.
MER (RMS)	The MER is defined as the ratio of I/Q signal power to I/Q noise power; the result is indicated in dB.
IQ Origin Offset	The magnitude of the DC offset of the signal measured at the symbol times. It indicates the magnitude of the carrier feed-through signal.
Frequency Error	The frequency difference between the measured carrier frequency of the signal and the user-selected center frequency of the instrument.
Gain Imbalance	The gain difference between the I and Q channels in the signal generation path. Constellations with gain imbalance show a pattern with a width that is different from height.
Quadrature Error	The orthogonal error between the I and Q channels. The error shows the phase difference between I and Q channels away from the ideal 90 degrees expected from the perfect I/Q modulation. Not valid for BPSK modulation type.
Rho	The normalized correlated power of the measured signal and the ideal reference signal. Like EVM, Rho is a measure of modulation quality. The value of Rho is less than 1 in all practical cases and is equal to 1 for a perfect signal measured in a perfect receiver.

Measurements for nFSK modulation types

Measurement	Description
Peak FSK err	Peak value of the frequency deviation error at the symbol point.
RMS FSK Err	RMS value of the frequency deviation error at the symbol point.
Peak Mag Err	The Peak magnitude difference between the measured signal and the reference signal magnitude.
RMS Mag Err	The RMS magnitude difference between the measured signal and the reference signal magnitude.
Freq Error	The frequency difference between the measured carrier frequency of the signal and the user-selected center frequency of the instrument.
Freq Deviation	Frequency distance from the center frequency at the symbol point.
Symbol Rate Error	This compares the user-entered symbol rate to the instrument calculated symbol rate of the analyzed signal.
Symbol Rate	When in Auto-symbol rate, the instrument calculates the symbol rate of the signal and the instrument calculates the error between the user entered value and the instrument calculated value.

Measurements for C4FM modulation type

Measurement	Description
RMS Error Magnitude	RMS value of the frequency deviation error at the symbol point.
Carrier Frequency Error	Frequency difference between averaged signal frequency and the center frequency.
Deviation	Frequency distance from the center frequency at the symbol point.
Length	Number of symbols in the analysis area.

Analog Modulation measurements**Measurements for AM modulation**

Measurement	Description
+AM	Positive peak AM value.
-AM	Negative peak AM value.
Total AM	Total AM value, which is equal to the peak-peak AM value divided by 2.

Measurements for FM modulation

Measurement	Description
+Pk	Positive peak frequency deviation.
-Pk	Negative peak frequency deviation.
RMS	RMS value of the frequency deviation.
Pk-Pk/2	Peak-to-peak frequency deviation divided by 2.
Pk-Pk	Peak-to-peak frequency deviation.

Measurements for PM modulation

Measurement	Description
+Pk	Positive peak phase deviation.
-Pk	Negative peak phase deviation.
RMS	RMS value of the phase deviation.
Pk-Pk	Peak-to-peak phase deviation.

APCO P25 measurements

Measurement	Description
RF output power	Measure of RF output power when the transmitter is connected to the standard load during defined duty cycle.
Operating frequency accuracy	Measure of the ability of the transmitter to operate on its assigned frequency.
Unwanted emissions (ACPR)	Ratio of the total power of a transmitter under prescribed conditions and modulation to that of the output power that falls within a prescribed bandwidth centered on the nominal frequency of adjacent channels.
Frequency deviation	Measurement of the amount of frequency deviation that results for a Low Deviation and High Deviation test pattern.
Modulation fidelity	Measures the degree of closeness to which the modulation follows the ideal theoretical modulation determined by the rms difference between the actual deviation and the expected deviation for the transmitted symbols.
Symbol rate accuracy	Measures the ability of the transmitter to operate at the assigned symbol rate (4.8 kHz for Phase 1, 6 kHz for Phase 2).
Transmitter power and encoder attack time	Measures the time required for a transmitter to prepare and transmit information on the radio channel after changing state from standby to transmit (applies to conventional mode).
Transmitter power and encoder attack time with busy/idle operations	Measures the time required for a transmitter to prepare and transmit information on the radio channel after the receiving channel changes state from busy to idle.
Transmitter throughput delay	Measures the time it requires for audio changes in the microphone to be encoded and transmitted over the air.
Transient frequency behavior	Measures the difference of the actual transmitter frequency and assigned transmitter frequency as a function of time when the RF output power is switched on or off.
HCPM transmitter logical channel time alignment	Measures the ratio of total transmitter power under prescribed conditions and modulation to the peak power that falls in a prescribed bandwidth centered on the nominal frequency of the adjacent channel during the transmitter power ramping interval.

Bluetooth measurements

Measurement	Description
Modulation characteristics	Verifies that the modulation characteristics of the transmitted signal are correct. This measurement can only be done if the payload has the bit pattern 10101010 or 11110000.
Carrier frequency offset and drift	Verifies that the carrier frequency offset and carrier drift of the transmitted signal is within the specified limits for the Basic Rate and Low Energy standards. This test can be done only if the payload contains 10101010 bit pattern.

Measurement	Description
Output power	Verifies the maximum peak and average power emitted from the EUT. The standard recommends this test be done for a PRBS payload pattern.
In-band emission / ACPR	Verifies that the in-band spectral emission is within limits. The standard document recommends that this measurement be done with Hopping off, finding the integrated power in 1 MHz band (with RBW 100 kHz) in 80 channels starting from 2401 MHz to 2481 MHz. The integrated power values calculated in the adjacent channels are compared against recommended limits (except the three channels around transmitted frequency). This measurement is referred to as ACPR in the Basic Rate standards document.
20 dB bandwidth	Verifies if the emissions inside the operating frequency range are within limits. This measurement is done with Hopping off. The difference between frequency points at which the power level drops to 20 dB below the peak power of the emission is found as 20 dB bandwidth.
Frequency range	These measurements verify if the emissions inside the operating frequency range are within the limits.
Power density	This measurement verifies the maximum RF output power density.
Out-of-band spurious emission	This measurement can be done for FCC or ETSI masks using the Spurious display.
Relative power	Verifies the relative power in the GFSK and PSK part of the Enhanced Data Rate signal. This measurement is supported only when an Enhanced Data Rate signal is detected.

LTE measurements

Measurement	Description
Cell ID detection	The Cell ID is detected from the input LTE signal. For TDD and FDD.
Adjacent Channel Leakage Ratio (ACLR)	The Adjacent Channel integrated power is calculated and shown. The relative power compared to the reference signal is also computed. The computed power is compared against limits suggested by the selected standard and pass/fail is reported. For TDD and FDD.
Channel Power	The channel power is calculated in the channel bandwidth. For TDD and FDD.
Occupied Bandwidth	The Occupied bandwidth is calculated as bandwidth containing 99% of the total integrated power in the selected span around the selected center frequency. For TDD and FDD.
Operating Band Unwanted Emission	The power in the offset regions is calculated and presented and compared against limits set in the offset and limits table and pass/fail is reported. For TDD and FDD.
T _{OFF}	The power in off-slot region is computed and compared against selected limits. For TDD only.

Pulse measurements

Measurement	Description
Average ON Power	The average power transmitted during pulse on.
Peak Power	Maximum power during pulse on.

Measurement	Description
Average Transmitted Power	The average power transmitted, including both the time the pulse is on and the time it is off, and all transition times.
Pulse Width	The time from the rising edge to the falling edge at the -3 dB / -6 dB level (50%) of the user selected 100% level. Level is user selectable for Volts or Watts.
Rise Time	The time required for a signal to rise from 10% to 90% (or 20% to 80%) of the user selected 100% level.
Fall Time	The time required for a signal to fall from 90% to 10% (or 80% to 20%) of the user selected 100% level.
Repetition Interval	The time from a pulse rising edge to the next pulse rising edge.
Repetition Rate	The inverse of repetition interval.
Duty Factor (%)	The ratio of the width to the pulse period, expressed as a percentage.
Duty Factor (Ratio)	The ratio of the pulse width to the pulse period.
Ripple	<p>Ripple is the peak-to-peak ripple on the pulse top. It does not include any preshoot, overshoot, or undershoot. By default, the first 25% and the last 25% of the pulse top is excluded from this measurement to eliminate distortions caused by these portions of the pulse.</p> <p>If the Amplitude units selected in the Amplitude panel (affects all amplitude measurements for the analyzer) are linear, the Ripple results will be in %Volts. For log units, the Ripple results will be in %Watts. The default for the general Units control is dBm, so the Ripple results default is %Watts.</p> <p>See also Ripple (see page 612).</p>
Ripple dB	The Ripple measurement expressed in dB.
Droop	Droop is the power difference between the beginning and the end of the pulse On time. A straight-line best fit is used to represent the top of the pulse. The result is a percentage referenced to the Average ON Power.
Droop dB	The Droop measurement expressed in dB.
Overshoot	The amount by which the signal exceeds the 100% level on the pulse rising edge. Units are %Watts or %Volts.
Overshoot dB	The Overshoot measurement expressed in dB.
Pulse-ref-Phase Difference	The phase difference between the current pulse and the first pulse in the analysis window. The instantaneous phase is measured at a user-adjustable time following the rising edge of each pulse.
Pulse-ref Freq Difference	The difference between the frequency of the current pulse and frequency of the previous pulse. The instantaneous frequency is measured at a user-adjustable time following the rising edge of each pulse.
RMS Freq Error	The RMS Frequency Error measurement is the RMS average of the Freq Error vs. Time trace, computed over the Measurement Time.
Max Freq Error	The maximum frequency error is the difference between the measured carrier frequency of the signal and the user-selected center frequency of the analyzer.
RMS Phase Error	The RMS Phase Error measurement is the RMS average of the Phase vs Time trace, computed over the Measurement Time.

Measurement	Description
Max Phase Error	The phase is measured at each point during the pulse's ON time. The phase error for each point is the difference between the measured phase value and the calculated ideal phase value. After the phase error is calculated for all points in the acquisition record, the largest error in the positive direction and the largest in the negative direction are determined. Whichever of these two values has the greater absolute value is designated the Max Phase Error.
Freq Deviation	The Frequency Deviation measurement is the difference between the maximum and minimum measured values of the signal frequency during the Measurement Time.
Phase Deviation	The Phase Deviation is the difference between the maximum and minimum Phase values measured during the ON time of a pulse.
Impulse Response Amplitude	The difference in dB between the levels of the main lobe and highest side lobe.
Impulse Response Time	The difference in time between the main lobe and highest side lobe.
Absolute Frequency	The absolute pulse frequency measured at a point specified by the user. The measurement includes carrier frequency as well. The measurement point should be within the pulse width, starting from the 50% point.
Pulse-Pulse Frequency Difference	The difference between the frequency of the current pulse and frequency of the previous pulse. The instantaneous frequency is measured at a user-adjustable time following the rising edge of each pulse.
Pulse-Pulse Phase Difference	The phase difference between the selected pulse and the first pulse in the analysis window. The instantaneous phase is measured at a user-adjustable time following the rising edge of each pulse.

Overview

The displays in General Signal Viewing (Displays > Measurements > General Signal Viewing) are:

- Amplitude vs Time
- Frequency vs Time
- Phase vs Time
- RF I & Q vs Time
- Spectrogram
- Spectrum
- Time Overview

These displays provide extensive time-correlated multi-domain views that connect problems in time, frequency, phase and amplitude for enabling you to more quickly understand cause and effect when troubleshooting.

Time Overview Display

The Time Overview display shows the entire acquisition record and shows you how the spectrum time and analysis time fit within the acquisition record. This enables you to see how you can adjust the spectrum time and analysis time to measure portions of the data.

You can specify the maximum number of trace points in the Time Overview display. You can set the maximum number of trace points to 1K, 10K, 100K, 1M points or to Never decimate. If the Acquisition Length includes more than 10,000 sample points (and Max trace points is not set to Never decimate), the trace is decimated (using the +Peak method, similar to +Peak detection in a Spectrum display) to 10,000 points. This decimated trace is what is used for marker measurements.

The Time Overview window displays the Spectrum Length and Analysis Length. The Spectrum Length is the period of time within the acquisition record over which the spectrum is calculated. The Analysis Length is the period of time within the acquisition record over which all other measurements (such as Amplitude vs. Time) are made. The Spectrum Length and Analysis Length can be locked together so that the data used to produce the Spectrum display is also used for measurement displays; however, they do not have to be tied together. They are by default specified separately and used to analyze different parts of the acquisition record.

Elements of the Time Overview Display

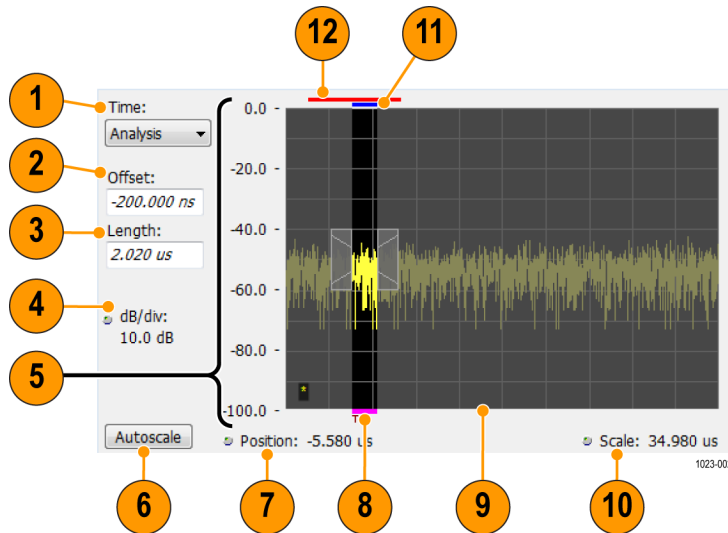

Item	Element	Description
1	Time	Select the type of time analysis to be performed. You can select Analysis, Spectrum, or Linked.
2	Offset	Sets the offset of the selected analysis time control.
3	Length	Sets the length of the selected analysis time control.
4	Position and Scale	Adjusts the vertical scale and position.
5	Scale indicators	Shows the vertical scale.
6	Autoscale button	Resets the horizontal scale to display the entire acquisition record and the vertical scale to show all trace points.
7	Horizontal offset	Adjusts the horizontal offset.
8	Results Timeline	This fuchsia line indicates the portion of the record actually used for calculating the selected result. For example: if a pulse measurement is selected, it shows the period of the specific pulse. For a constellation display, it shows the points included in the demodulation.
9	Amplitude vs. Time graph	The trace represents the entire acquisition record (at full horizontal scale). The graph indicates the Analysis Length or Spectrum Length on the graph with a darker background.
10	Horizontal Scale	Adjusts the span of the graph. By decreasing the scale, the graph essentially becomes a window that you can move over the acquisition record by adjusting the offset.
11	Spectrum Length and Offset Indicator (red line, top of graph)	This red line indicates the Spectrum Length and Offset. The longer the time, the longer the bar. Adjusting the offset shifts the bar left or right.
12	Analysis Length and Offset Indicator (blue line, top of graph below red line)	The blue line indicates the Analysis Length and Offset. The longer the time, the longer the bar. Adjusting the offset shifts the bar left or right.

NOTE. *The area with black background (not gray) in the Amplitude vs. Time Graph highlights the control selected in the Analysis Time Control drop-down list.*

[Changing the Time Overview Display Settings \(see page 39\)](#)

Time Overview Settings

Main menu bar: Setup > Settings

Favorites toolbar: 

The Setup settings for Time Overview are shown in the following table.

Settings tab	Description
Scale (see page 69)	Adjusts the vertical and horizontal scale and offset of the display.
Trace (see page 41)	Allows you to select the types of trace to display and its function.
Prefs (see page 70)	Specifies whether or not certain display elements are shown.

Navigator View

The Time Overview Navigator View places the Time Overview display across the top of the application screen. This allows you to adjust the area of interest in the Navigator View and see the results simultaneously in the other displays. For example, in the following image, adjusting the mask in the Navigator View moves the trace and markers in all of the other displays.

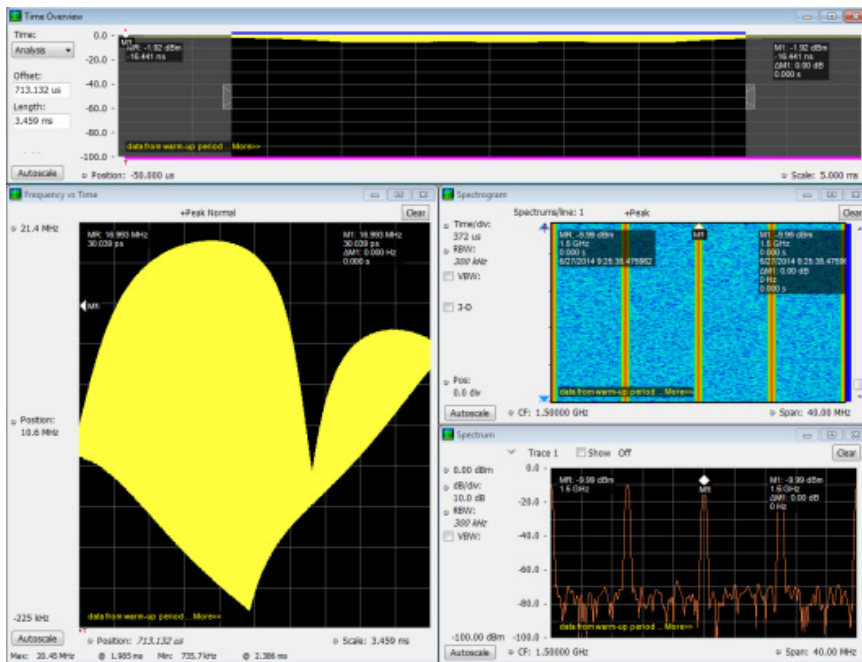

Show Navigator View

To show the Navigator View, select **View > Navigator View**. To remove the Navigator View, deselect Navigator View in the View menu.

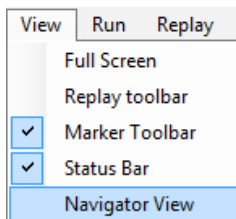

Trace Tab

The Trace Tab allows you to set the display characteristics of displayed traces.

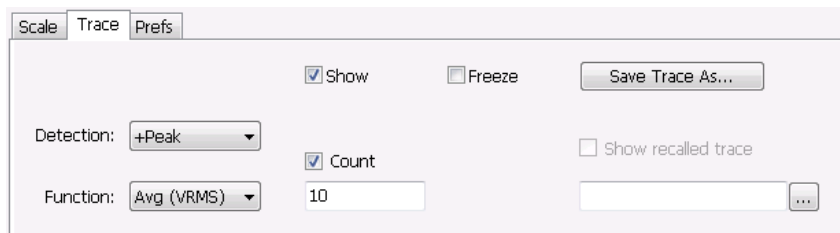

Setting	Description
Show	Shows / hides the selected trace.
Detection	Sets the Detection method used for the trace. Not available for saved traces. Available detection methods are +Peak, -Peak, +/-Peak, Avg (VRMS), and Sample. Not all detection methods are available in all displays.
Function	Selects the trace processing method. Available settings are: Normal, Average, Max Hold, and Min Hold.
(Number of Traces)	Sets the number of traces averaged to generate the displayed trace. (Present only when Function is set to Average.)
Freeze	Halts updates to the selected trace.
Save Trace As	Saves the selected trace to a file for later recall and analysis.
Show Recalled trace	Displays a saved trace instead of a live trace.

Detection

Trace Detection occurs when the trace is being decimated by the measurement. For example, if the maximum number of trace points is 100,000, and the selected analysis region is 200,000 samples, the measurement must decimate the 200,000 resulting trace points by 2 to prevent exceeding the 100,000 trace point limit. Since only one value can be selected for each trace point, an algorithm must be used to select (detect) the appropriate value to use.

The IQ samples in a data acquisition can be detected in a variety of ways. The number of IQ samples available to each trace point varies with both analysis length and trace length. For example, with Spectrum Length set to 'Auto' in the Analysis menu, the instrument analyzes just enough samples to produce one IQ sample pair per trace point. In this case, the detection method chosen has very little effect, as the +Peak, -Peak, Avg (VRMS) and Sample values are all equal. Changing the Spectrum Length causes the available detection methods to differ in value because they have a larger set of samples for the various detection methods to process.

The available detection methods (depending on the display) are:

- **+Peak** – Each point on the trace is the result of detecting the positive peak value present in the set of IQ samples available to that trace point.
- **-Peak** – Each point on the trace is the result of detecting the negative peak value present in the set of IQ samples available to that trace point.
- **+/-Peak** – Selects the highest and lowest values of all the samples contained in two consecutive acquisition intervals.
- **Avg (VRMS)** [Average V_{RMS}] – Each point on the trace is the result of determining the RMS Voltage value for all of the IQ samples available to the trace point. When displayed in either linear (Volts, Watts) or Log (dB, dBm), the correct RMS value results. When the averaging function is applied to a trace, the averaging is performed on the linear (Voltage) values, resulting in the correct average for RMS values.
- **Sample** – The result is calculated based on the first sample available in the set of IQ samples for each trace point.

Trace Processing

Traces can be processed to display in different ways. The Function setting controls trace processing.

- **Normal** - Each new trace is displayed and then replaced by the next trace. Each data point contains a single vertical value.
- **Average** - Multiple traces are averaged together to generate the displayed trace. There is one vertical value for each underlying frequency data point. Once the specified number of traces have been acquired and averaged to generate the displayed trace, each new trace takes the place of the oldest trace in the calculation. The **Number of Traces** setting specifies how many traces averaged.
- **Max Hold** - Displays the maximum value in the trace record for each display point. Each new trace display point is compared to the previous maximum value and the greater value is retained for display and subsequent comparisons.
- **Min Hold** - Displays the minimum value in the trace record for each display point. Each new trace display point is compared to the previous minimum value and the lesser value is retained for display and subsequent comparisons.

Saving Traces

To save a trace for later analysis:

1. Select the Save icon . This displays the Save As dialog box.
2. Navigate to the desired folder or use the default.
3. Type a name for the saved trace and click **Save**.

Recalling Traces

You can recall a previously saved trace for analysis or comparison to a live trace.

To select a trace for recall:

1. Select the trace into which the recalled trace will be loaded, from the Trace drop-down list.
2. Check the **Show** check box.
3. Click the ... button to display the Open dialog box.

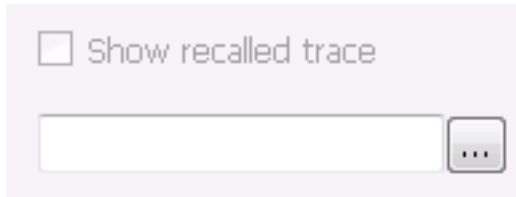

4. Navigate to the desired file and click **Open**.
5. Check the **Show Recalled Trace** check box.
6. Verify that the trace's **Show** check box is selected (either on this tab or next to the drop-down list located at the top-left corner of the graph).

Spectrum Display

To display a spectrum:

1. Click the **Displays** button or select **Setup > Displays**.
2. From the Measurements box, select **General Signal Viewing**.
3. Double-click the **Spectrum** icon in the **Available displays** box. This adds the Spectrum icon to the **Selected displays** box (and removes it from the Available displays box). Alternatively, you can click the Spectrum icon and then click the Add button to select Spectrum for display.
4. Click the **OK** button.

Elements of the Spectrum Display

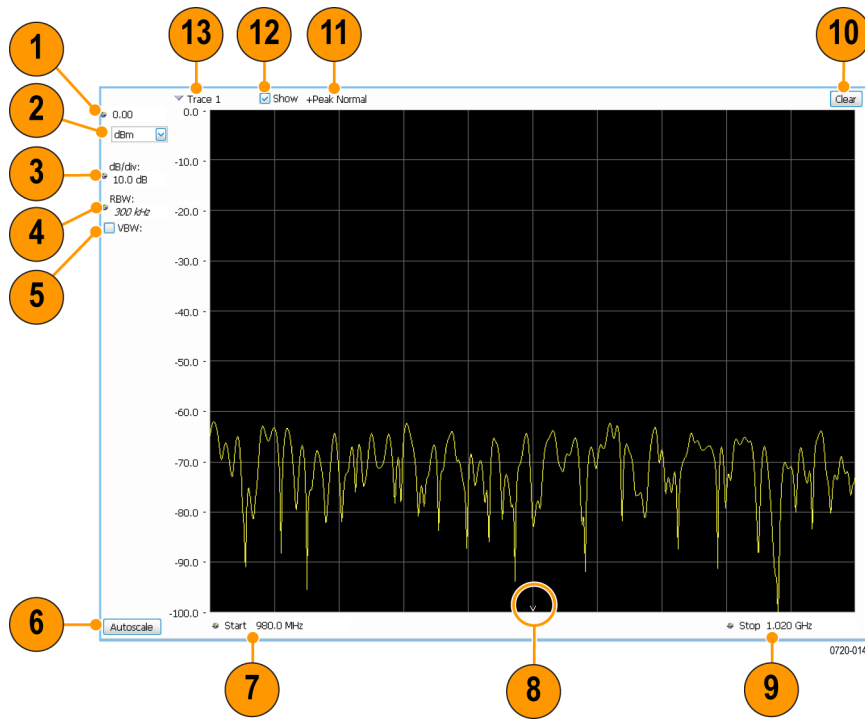

Item	Display element	Description
1	Vertical position	Sets the top of graph value. This is only a visual control for panning the graph. The Reference Level is adjusted in the Toolbar and the Amplitude control panel. By default, Vert Position = Ref Level.
2	Units	Sets the global Amplitude units for all the views in the analysis window. This will change the Amplitude selection in the Units tab of Analysis Control panel.
3	dB/div	Sets the vertical scale value. The maximum value is 20.00 dB/division.
4	RBW	Sets the resolution bandwidth. Note that when the RBW is set to Auto, its value is italicized.
5	VBW	Enables the VBW (Video Bandwidth) filter. See Setup > Settings > BW Tab (see page 67) .
6	Autoscale	Adjusts the Vertical and Horizontal scaling to display the entire trace on screen.
7	Position	Default function is CF - center frequency (equivalent to the Freq setting). If Horizontal scaling has been manually adjusted in Settings > Scale, then Offset will replace CF as the setting at the bottom-left corner of the screen.
8	CF indicator	Indicates the center frequency.
9	Span / Scale	Default function is Span - frequency difference between the left edge of the display and the right edge. If Horizontal scaling has been manually adjusted in Settings > Scale, then Scale will replace Span as the setting at the bottom-right corner of the screen.
10	Clear	Restarts multi-trace functions (Avg, Hold).
11	Function	Readout of the Detection and Function selections for the selected trace.
12	Show	Controls whether the selected Trace is visible or not. When trace is Off, the box is not checked.
13	Trace	Selects a trace. Clicking here pops up a context menu listing the available traces, whether they are enabled or not. If you select a trace that is not currently enabled, it will be made enabled.

[Changing the Spectrum Display Settings \(see page 45\)](#)

Spectrum Settings

Main menu bar: Setup > Settings

Favorites toolbar: 

The settings for the Spectrum display are shown in the following table.

Settings tab	Description
Freq & Span (see page 63)	Sets frequency and span parameters for the Spectrum Analysis display.
BW (see page 67)	Sets Resolution Bandwidth and windowing parameters.
Traces (see page 63)	Sets Trace display parameters.
Traces (Math) (see page 67)	Sets the traces used to create the Math trace.
Scale Tab (see page 46)	Sets vertical and horizontal scale and position parameters.
Prefs Tab (see page 70)	Specifies whether or not certain display elements are shown.

Scale Tab

The Scale tab allows you to change the vertical and horizontal scale settings. Changing the scale settings changes how the trace appears on the display but does not change control settings such as Measurement Frequency. In effect, these controls operate like pan and zoom controls.



Setting	Description
Vertical	
Scale	Changes the vertical scale.
Position	Vertical Position adjusts the top of graph amplitude value. This control allows you to move (“pan”) the traces up and down in the graph without changing the Reference Level.
Autoscale	Resets the Offset so that the trace appears below the top of the graph.
Horizontal	
Scale	Allows you to change the range of frequencies shown in the graph without changing the span or measurement frequency.
Position	Allows you pan the graph.
Autoscale	Resets Scale to the Span setting.
Reset Scale	Resets all settings to their default values.
Log scale	Resets the display to show the frequency axis in a logarithmic scale.

Spectrogram Display

The Spectrogram is a display with the vertical axis (time) composed of successive spectral displays, each having the amplitude represented by color or intensity. The horizontal axis represents frequency. The most recently acquired spectrum results are added to the bottom of the spectrogram. The addition of a new spectrum can occur at the fastest rate that new spectra can be plotted, or, if you choose, new spectra can be added at a timed rate. The spectrogram view is well-suited to displaying long-term trends of spectral data. The maximum number of lines that can be displayed in a spectrogram is 125,000.

The spectrogram can also be displayed in a 3-D waterfall format. In the 3-D waterfall format, the spectrogram displays the time axis along a simulated Z-axis.

NOTE. *Spectrogram data is shared with the Spectrum display.*

To display a Spectrogram:

1. Select the **Displays** button or select **Setup > Displays**. This displays the **Select Displays** dialog box.
2. From the **Measurements** box, select **General Signal Viewing**.
3. Double-click the **Spectrogram** icon in the **Available Displays** box. This adds the Spectrogram icon to the Selected displays box.
4. Click the **OK** button. This displays the spectrogram view.
5. To display a 3-D version of the spectrogram, select the 3-D checkbox.

Elements of the Spectrogram Display

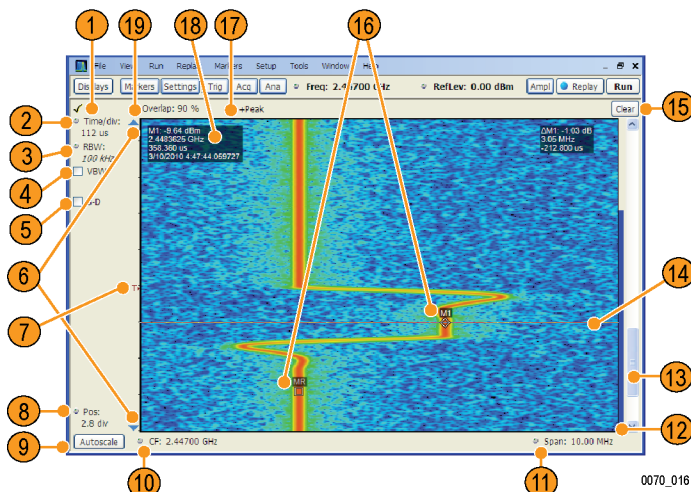

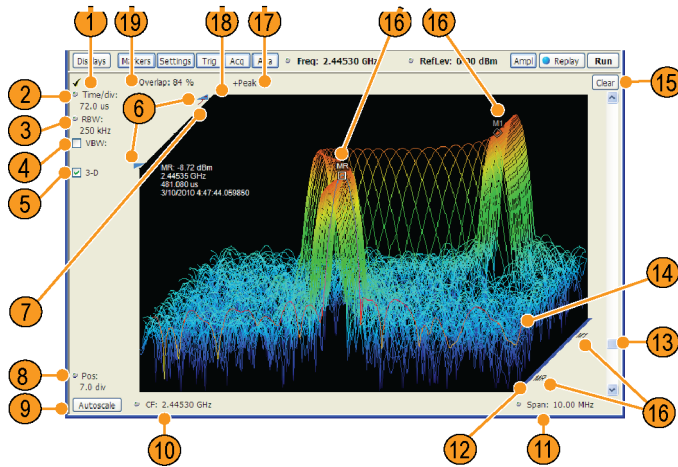

Item	Display element	Description
1	Check mark indicator	The check mark indicator in the upper, left-hand corner of the display shows when the Spectrogram display is the optimized display. NOTE. When Best for multiple windows is selected in the Amplitude control panel's RF & IF Optimization control, none of the measurement displays shows a checkmark, as there is not a single optimized measurement.
2	Time/div	Sets the length of time represented by each vertical division. Divisions are indicated by tick marks along the left edge of the graph.
3	RBW	Sets the resolution bandwidth. Note that when the RBW is set to Auto, its value is italicized.
4	VBW	Enables the VBW (Video Bandwidth) filter. See Setup > Settings > BW Tab (see page 67).
5	3-D checkbox	Enables and disables the 3-D view.
6	Selected records indicators	Shows the positions of the start and stop records selected on the Select data records tab. Drag the indicators to select which records will be played by Replay All. Note that these are not visible while acquisitions are running; the instrument must be stopped for the indicators to be visible.
7	T	Trigger indicator. This icon indicates the trigger point within the current acquisition.
8	Pos	Position indicates the bottom line visible in graph. Changing this setting scrolls the window up and down through the displayed acquisition records.
9	Autoscale	Resets Vertical and Horizontal scale and Pos to default values.
10	CF	Sets the Center Frequency.
11	Span	Sets the span of the spectrogram display.
12	Current data record indicator	A blue line indicates the current data record. When the analysis length is short, the blue line appears as a thin line much like the selected indicator line. When the analysis length is relatively long, the blue line appears more like a blue bar.
13	Position scroll bar	Changes the position of the trace in the window. Changing the position scroll bar is the same as adjusting the Pos setting.

Item	Display element	Description
14	Selected indicator	This inverse-colored line indicates the Spectrogram line that will appear in the Spectrum display when the Spectrogram trace is enabled. This line is attached to the selected marker.
15	Clear	Clears the spectrogram display; however, data records in acquisition history remain in memory and are available for replay. To clear memory, select File > Acquisition Data Info > Delete All Data .
16	Marker indicators	These icons indicate the position of markers in the spectrogram. You can move markers by dragging the desired marker indicator.
17	Detection setting	Displays the selected Detection method (see Settings > Trace (see page 50) tab).
18	Marker readout	Marker readout for the selected marker. In the Spectrogram display, the marker readout includes a date and timestamp. The time is displayed in a 24-hour format. The timestamp readout can be shown or hidden independently of the other marker readouts (see Settings > Prefs (see page 70)).
19	Time Scale status readout	Three readouts can appear here depending on settings: Time/update, Spectrums/line, and Overlap. See Time Scale Status Readout (see page 49) .

Time Scale Status Readout

Three types of readouts can appear in the display depending on settings:

- Time/update – Displays minutes:seconds when Spectrum Monitor is selected in the **Settings > Time & Freq Scale** tab in the **Vertical (Time)** section.
- Spectrums/line – Displays an integer number when vertical scale is Normal and each line contains the results from one or more frequency transforms (whether zoomed out or not).
- Overlap – Displays the overlap percentage when vertical scale is Normal and each line's transform shares some points with the transforms of lines before and after it (zoomed in). Overlap can only be done when the Analysis Length > 2x RBW frame length.

The Spectrogram can show results from one or multiple acquisitions and it can show one or multiple lines for each acquisition.

[Changing the Spectrogram Display Settings \(see page 49\)](#)

Spectrogram Settings

Main menu bar: Setup > Settings

Favorites toolbar: 

The Setup settings for the Spectrogram display are visible when Spectrogram is the selected display.

Settings tab	Description
Freq & Span (see page 63)	Sets frequency and span parameters for the Spectrogram display.
BW (see page 67)	Sets Resolution Bandwidth and windowing parameters.
Trace (see page 50)	Sets Trace display parameters.
Amplitude Scale (see page 51)	Selects between 2-D and 3-D, sets height scale, position and orientation for 3-D display. Sets color parameters for the spectrogram trace.
Time & Freq Scale (see page 51)	Sets the vertical and horizontal scale parameters for the spectrogram trace. The Spectrum Monitor controls are also on this tab.
Prefs (see page 70)	Specifies whether or not certain display elements are shown.

Trace Tab

The Spectrogram Trace tab controls let you specify the Detection method, save traces, and recall saved traces for display. The Spectrogram Trace tab does not have all the controls that other Trace tabs contain, however, it does have a unique display element, the Selected Line readout. For details on Detection, Freeze, and saving and recalling traces, see the [Traces Tab \(see page 63\)](#).

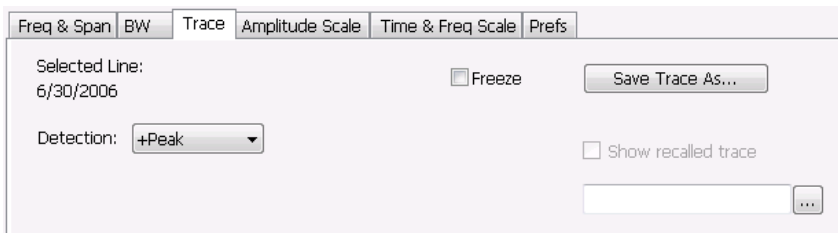

Selected Line

Displays the time at the Selected Line. If Markers are enabled, the selected line is positioned by the selected marker. If no markers are enabled, the selected line is the first line in the current analysis period.

Amplitude Scale Tab

The Amplitude Scale tab allows you to change the vertical and horizontal scale settings, enable the 3-D Waterfall display, and set the color scheme used for the spectrogram trace.

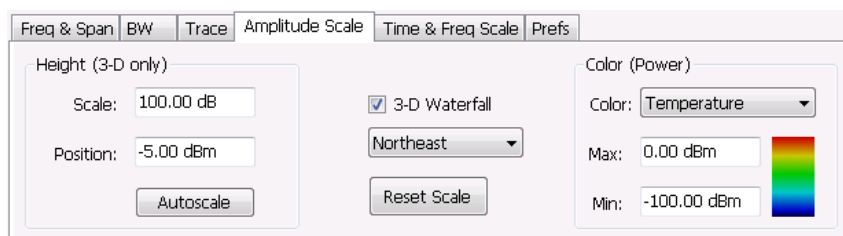

Setting	Description
Height (3-D only)	
Scale	Changes the vertical scale for trace Amplitude in the graph (not the vertical scale for Time).
Position	Specifies the level displayed at the bottom edge of the graph. (Bottom front edge in the 3-D view).
Autoscale	Adjusts the vertical position and scale of the trace lines to bring them into the visible portion of the graph.
3-D Waterfall	
Northeast	Shifts the perspective of the 3-D graph so that the oldest traces move back and to the right.
Northwest	Shifts the perspective of the 3-D graph so that the oldest traces move back and to the left.
Reset Scale	Resets the Height and Color settings to their default values.
Color (Power)	
Color	Displays a drop-down list that allows you to set the color scheme used for the spectrogram trace.
Max	Sets the maximum power level represented by the top of the color scale.
Min	Sets the minimum power level represented by the bottom of the color scale.

Time & Freq Scale Tab

The Time and Freq Scale tab allows you to change the vertical and horizontal scale settings, enable the 3-D Waterfall display, and set the color scheme used for the spectrogram trace.

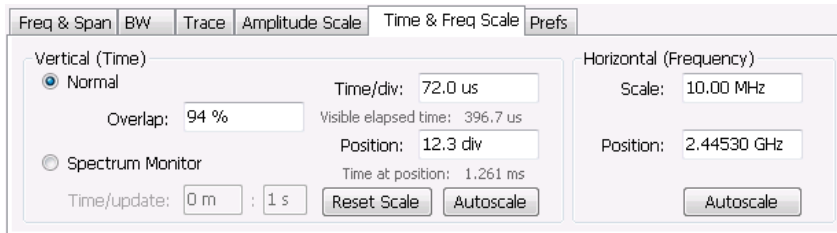

Setting	Description
Vertical (Time)	
Normal	For most Spectrogram applications. Primary time scale control is Time/div. Time scale can be zoomed in or out.
Spectrum Monitor	For long-term signal monitoring applications. In spectrum monitor mode, each line in the spectrogram represents the period of time specified by the Time/update parameter. Time scale can be zoomed out, but not zoomed in (no overlap).
Time/update	Sets the time, in minutes and seconds, represented by each line of the spectrogram. Only available in Spectrum Monitor.
Reset Scale	Resets the Time/div and Pos settings to their default values.
Autoscale	Scales the vertical (time) axis to compress all existing trace lines into the visible area of the graph. Resets the Position value to zero, placing the most recent spectrogram line at the bottom of the spectrogram display. Only Position is affected by Autoscale when Spectrum Monitor is selected.
Time/div	Sets the time displayed per division.
Visible elapsed time	Displays the length of time visible in the display. This does not represent the total time available to view.
Position	Adjusts vertical position of the trace within the graph area. Setting represents the offset, in divisions, between the bottom of the graph and the bottom (most recent) line in the results trace.
Time at position	Displays the time of the spectrogram line shown at the bottom of the graph. This time is relative to the Time Zero Reference of the current acquisition.
Horizontal (Frequency)	
Scale	Sets the frequency range of the graph without changing the Span value.
Position	Sets the frequency displayed at the center of the graph. Changing this value does not change the Freq setting.
Autoscale	Sets the frequency scale to the Spectrogram Span value.

Spectrum Monitor

Spectrum Monitor performs long term monitoring. The monitor mode compresses time into each line of the spectrogram, which enables you to monitor long periods of time (from 1 second per line up to 600 minutes per line). With extended memory (Option 53) installed in the instrument, you can capture up to 125,000 lines. With standard memory installed in the instrument, the maximum number of lines you can capture is 31,250.

During each line's collection period, spectrum transforms are computed for each acquisition taken by the instrument. As each transform completes, it is incorporated into the current spectrogram line. How each

line of the spectrogram is created in spectrum monitor mode depends on the detection setting (Settings > Trace). For example, if Detection is set to +Peak, each spectrogram line is effectively a peak hold display of all the spectral data captured since the prior line.

Amplitude Vs Time Display

The Amplitude vs. Time display plots the signal amplitude against time. The amplitude appears on the vertical axis while time is plotted along the horizontal axis.

Note that the trace(s) in the Amplitude vs. Time display can be set to a maximum of 100,000 points (however, the actual number of trace points can extend up to 1,000,000 points if Max trace points is set to Never Decimate). If the Analysis Length includes more than the selected Max trace points value, the trace is decimated (using the method specified with the Detection control) to be equal to or less than the Max trace points setting (except when Max trace points is set to Never Decimate). This decimated (or undecimated) trace is what is used for marker measurements and for results export. You can set the Max trace points on the **Settings > Prefs** tab.

To show Amplitude vs. Time display:

1. Press the **Displays** button or select **Setup > Displays**.
2. In the **Select Displays** dialog, select **General Signal Viewing** in the **Measurements** box.
3. In the **Available displays** box, double-click the **Amplitude vs. Time** icon or select the icon and click **Add**. The Amplitude vs. Time icon will appear in the **Selected displays** box and will no longer appear under Available displays.
4. Click **OK**.

Elements of the Display

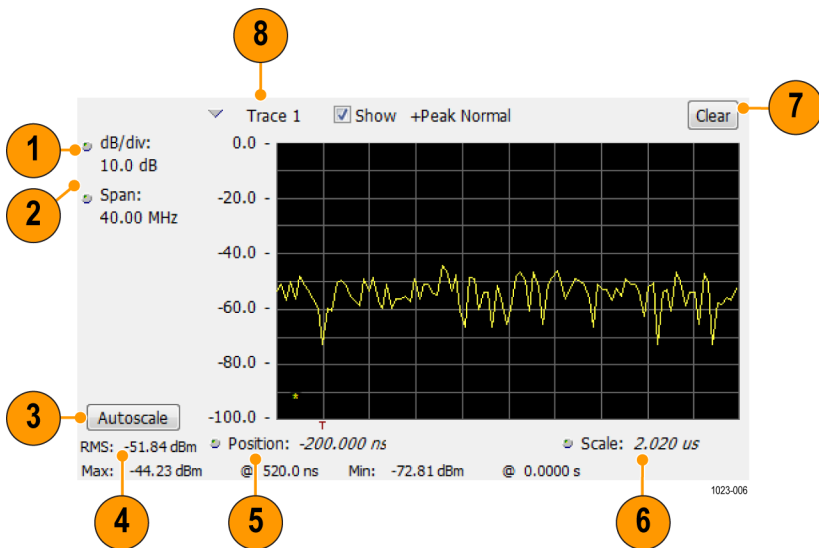

Item	Display element	Description
1	Vertical scale adjustment	Adjusts the vertical scaling.
2	Span	Adjust the bandwidth of the data to be analyzed. (Not the period of time shown in the display.)
3	Autoscale	Adjusts the vertical and horizontal settings to provide the best display.
4	Offset	Adjust the horizontal offset.
5	Max and Min readouts	Displays the maximum and minimum amplitudes, as well as when those values occur.
6	Scale	Sets the time spanned by the graph.
7	Clear button	Restarts multi-trace functions (Avg, Hold).
8	Trace function	Displays the current trace function setting (Settings > Trace tab > Function).

Reference. [Changing Amplitude vs Time Display Settings \(see page 54\)](#)

Amplitude Vs Time Settings

Main menu bar: Setup > Settings

Favorites toolbar: 

The settings for the Amplitude vs. Time display are shown in the following table.

Settings tab	Description
Freq & BW (see page 55)	Sets the Bandwidth Method used for setting the measurement bandwidth.
Traces (see page 63)	Allows you to select the type of trace to display and their functions.
Traces (Math) (see page 67)	Sets the traces used to create the Math trace.
Scale (see page 69)	Sets the vertical and horizontal scale parameters.
Prefs (see page 70)	Specifies whether certain display elements are visible.

Freq & BW Tab

The Freq & BW (Bandwidth) tab allows you to specify the bandwidth parameters used for setting measurement bandwidth. This determines what Acq BW the measurement will request.

Settings	Description
Time-domain Bandwidth filter	Time-domain BW is a filter used to process the trigger input signal before the trigger system analyzes the signal. The frequency edge trigger point must lie within the range of time domain bandwidth. This makes the range of the frequency edge trigger = Center Frequency $\pm(0.5 \times$ Time Domain Bandwidth)
Measurement BW, no filter	This control limits the bandwidth of measurements. You use the measurement bandwidth setting to improve the signal-to-noise ratio of the measurement, resulting in lower measurement uncertainty. However, if the measurement bandwidth is set too low, resulting in fewer samples per second, it can reduce the number of points within the measurement length below the 256 stable samples required, thus causing the analysis to fail.

Frequency Vs Time Display

The Frequency vs. Time Display shows how the signal frequency varies with time.

Note that the trace(s) in the Frequency vs. Time display can be set to a maximum of 100,000 points (however, the actual number of trace points can extend up to 1,000,000 points if Max trace points is set to Never Decimate). If the Analysis Length includes more than the selected Max trace points value, the trace is decimated (using the method specified with the Detection control) to be equal to or less than the Max trace points setting (except when Max trace points is set to Never Decimate). This decimated (or undecimated) trace is what is used for marker measurements and for results export. You can set the Max trace points on the **Settings > Prefs** tab.

To display the Frequency vs. Time Display:

1. Select the **Displays** button or **Setup > Displays**.
2. In the **Select Displays** dialog, select **General Signal Viewing** in the **Measurements** box.

3. In the **Available displays** box, double-click the **Frequency vs. Time** icon or select the icon and click **Add**. The Frequency vs. Time icon will appear in the **Selected displays** box and will no longer appear under Available displays.
4. Click **OK** to display the Freq vs. Time display.

Elements of the Display

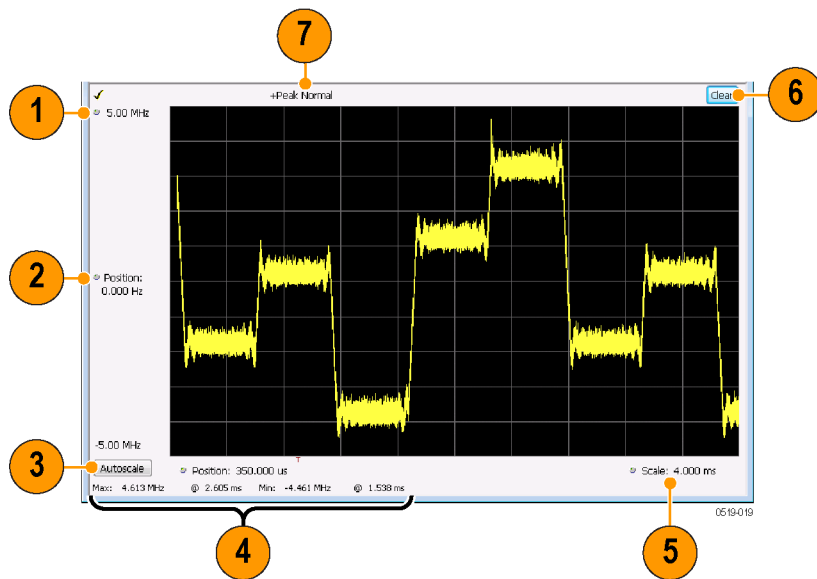

Item	Display element	Description
1	Top of graph adjustment	Use the knob to adjust the frequency range displayed on the vertical axis.
2	Offset adjustment	Adjusts the frequency shown at the center of the display.
3	Autoscale button	Adjusts the offset and range for both vertical and horizontal to provide the best display.
4	Maximum and Minimum frequency readouts	Displays the maximum and minimum values, as well as when those values occur.
5	Horizontal Scale	Sets the time spanned by the graph.
6	Clear button	Restarts Average trace.
7	Trace function	Displays the current trace function setting (Settings > Trace > Function).

[Changing Frequency vs Time Display Settings \(see page 56\)](#)

Frequency Vs Time Settings

Main menu bar: Setup > Settings

Favorites toolbar:

The Setup settings for Frequency vs. Time are shown in the following table.

Settings tab	Description
Freq & BW (see page 61)	Sets the frequency and bandwidth parameters.
Trace (see page 63)	Sets the trace display parameters.
Scale (see page 69)	Sets the Vertical and Horizontal scale and offset parameters.
Prefs (see page 70)	Specifies whether certain display elements are visible.

Phase Vs Time Display

The Phase vs. Time display plots the signal phase against time. The phase appears on the vertical axis while time is plotted along the horizontal axis.

Note that the trace(s) in the Phase vs. Time display can be set to a maximum of 100,000 points (however, the actual number of trace points can extend up to 1,000,000 points if Max trace points is set to Never Decimate). If the Analysis Length includes more than the selected Max trace points value, the trace is decimated (using the method specified with the Detection control) to be equal to or less than the Max trace points setting (except when Max trace points is set to Never Decimate). This decimated (or undecimated) trace is what is used for marker measurements and for results export. You can set the Max trace points on the **Settings > Prefs** tab.

To display Phase vs. Time:

1. Press the **Displays** button or select **Setup > Displays**.
2. In the **Select Displays** dialog, select **General Signal Viewing** in the **Measurements** box.
3. In the **Available displays** box, double-click the **Phase vs. Time** icon or select the icon and click **Add**. The Phase vs. Time icon will appear in the **Selected displays** box and will no longer appear under Available displays.
4. Click **OK** to show the Phase vs. Time display.

Elements of the Display

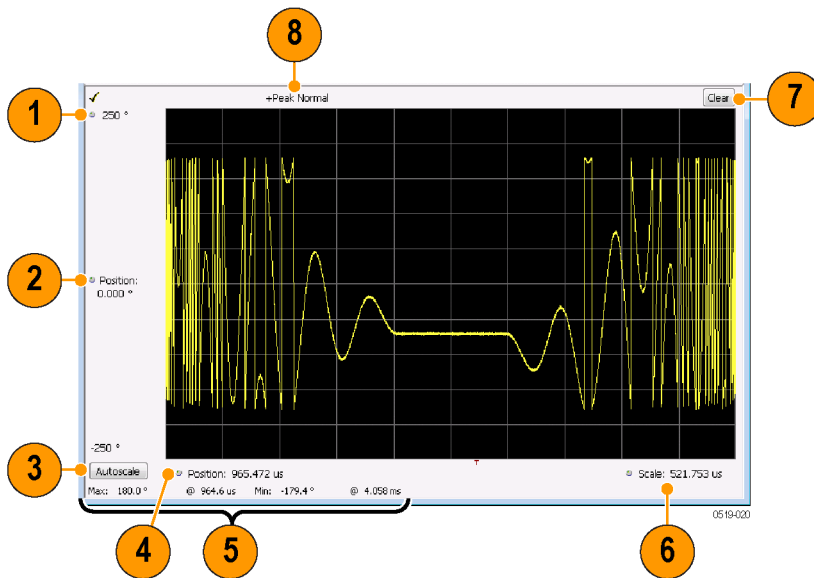

Item	Display element	Description
1	Top of graph adjustment	Adjusts the vertical scale. Use the knob to adjust the value of the top of the graph.
2	Vertical offset adjustment	Adjusts the phase error shown at the vertical center of the display.
3	Autoscale button	Adjusts the vertical and horizontal settings so that the entire trace fits in the view.
4	Horizontal Offset	Adjusts the horizontal position of the trace.
5	Max and Min readouts	Displays the maximum and minimum value of the phase error within the analysis times and the times at which they occurred.
6	Horizontal Scale	Sets the time spanned by the graph.
7	Clear button	Restarts multi-trace functions (Avg, Hold).
8	Trace function	Shows the trace function as set on the Settings > Trace tab.

[Changing the Phase vs Time Display Settings \(see page 58\)](#)

Phase Vs Time Settings

Main menu bar: Setup > Settings

Favorites toolbar: 

The settings for the Phase vs. Time display are shown in the following table.

Settings tab	Description
Freq & BW (see page 61)	Sets the frequency and bandwidth parameters.
Trace (see page 63)	Sets the trace display parameters.
Scale (see page 69)	Sets the Vertical and Horizontal scale and offset parameters.
Prefs (see page 70)	Specifies whether certain display elements are visible.

RF I & Q vs Time Display

This is a plot of the baseband In-Phase (I) and Quadrature (Q) components of a modulated carrier. The plot is in the time domain, with I and/or Q values the Y-axis.

Note that the trace(s) in the RF I & Q vs. Time display can be set to a maximum of 100,000 points (however, the actual number of trace points can extend up to 1,000,000 points if Max trace points is set to Never Decimate). If the Analysis Length includes more than the selected Max trace points value, the trace is decimated (using the method specified with the Detection control) to be equal to or less than the Max trace points setting (except when Max trace points is set to Never Decimate). This decimated (or undecimated) trace is what is used for marker measurements and for results export. You can set the Max trace points on the **Settings > Prefs** tab.

To display an RF I & Q vs. Time display:

1. Select the **Displays** button or select **Setup > Displays**. This shows the **Select Displays** dialog box.
2. From the **Measurements** box, select **General Signal Viewing**.
3. Double-click the **RF I&Q vs. Time** icon in the **Available Displays** box. This adds the RF I & Q vs. Time icon to the **Selected displays** box.
4. Click the **OK** button.

Elements of the Display

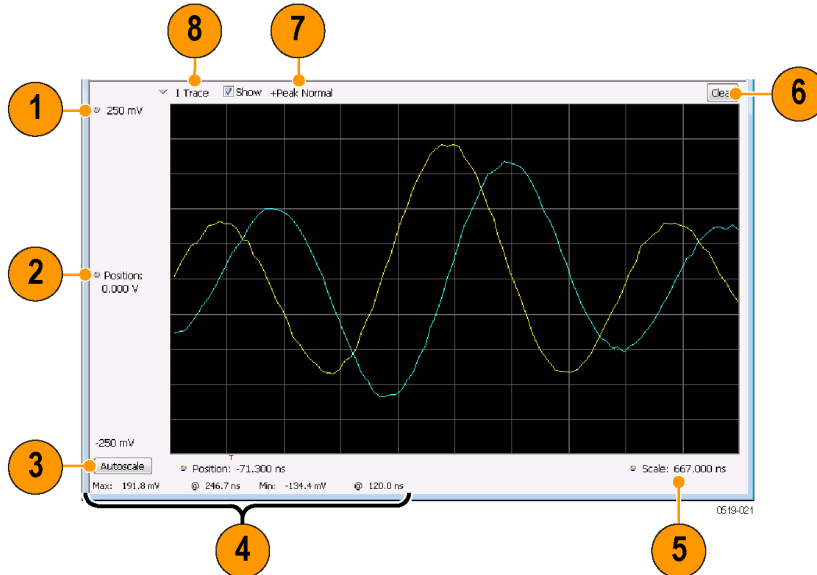

Item	Display element	Description
1	Top of Graph adjustment	Use the knob to adjust the vertical scaling.
2	Vertical offset adjustment	Adjusts the level shown at the center of the display.
3	Autoscale button	Adjusts the offset and scale for both vertical and horizontal to provide the best display.
4	Maximum and Minimum level readouts	Displays the maximum and minimum values, within the Analysis Time, as well as the times at which they occurred.
5	Scale	Sets the time spanned by the graph.
6	Clear button	Restarts multi-trace functions (Avg, Hold).
7	Trace function	Displays the current trace function setting (Settings > Trace > Function). If the traces are averaged, the number of averages is displayed.
8	Trace Control	Selects which trace is displayed (using the drop-down list) and which trace is active (click on the trace name to display a menu).

[Changing the RF I & Q vs Time Display Settings \(see page 60\)](#)

RF I & Q vs Time Settings

Main menu bar: Setup > Settings

Favorites toolbar: 

The Setup settings for RF I&Q vs. Time are shown in the following table.

Settings tab	Description
Freq & BW (see page 61)	Sets the frequency and bandwidth parameters.
Trace (see page 63)	Sets the trace display parameters.
Scale (see page 69)	Sets the Vertical and Horizontal scale and offset parameters.
Prefs (see page 70)	Specifies whether certain display elements are visible.

General Signal Viewing Shared Measurement Settings

The control panel tabs in this section are identical or very similar for each of the displays in the General Signal Viewing folder (Setup > Displays). Some tabs are shared by all the displays, some tabs are shared by only a couple of displays.

For some tabs, the control values are shared across all the General Signal Viewing displays. For other control values, each display has unique values for the controls. Details are provided for the specific tabs.

Common controls for general signal viewing displays

Settings tab	Description
Freq & Span (see page 63)	Sets the frequency and span parameters.
Trace (see page 63)	Sets the trace display parameters.
Traces – Math (see page 67)	Sets the traces used to create the Math trace.
BW (see page 67)	Sets the Bandwidth Method used for setting the measurement bandwidth.
Scale (see page 69)	Sets the Vertical and Horizontal scale and offset parameters.
Prefs (see page 70)	Specifies whether certain display elements are visible.

Freq & BW Tab — Freq vs Time, Phase vs Time, RF I & Q vs Time Display

The Freq & BW tab provides access to settings that control frequency settings for the Freq vs Time, Phase vs Time, RF I & Q vs Time display.

The screenshot shows the 'Freq & BW' tab selected. The 'Measurement BW, no filter:' field is set to 500 MHz, and the 'Link to Span' checkbox is unchecked. The 'Measurement Freq:' field is set to 1.000 GHz. A 'Set to max BW' button is visible below the frequency field.

Setting	Description
Measurement Freq	The frequency at the which measurements are made. This value is the same as the setting for Frequency in the Application bar.
Measurement BW	This control limits the bandwidth of measurements. You use the measurement bandwidth setting to improve the signal-to-noise ratio of the measurement, resulting in lower measurement uncertainty. However, if the measurement bandwidth is set too low, resulting in fewer samples per second, it can reduce the number of points within the measurement length below the 256 stable samples required, thus causing the analysis to fail.
Link to Span	When enabled, the measurement bandwidth of the RF I & Q display is determined by the span of the analyzer. When unchecked, the measurement bandwidth is specified by the user, and no additional filter is applied.
Set to max BW	Sets the measurement bandwidth to the maximum acquisition bandwidth of the instrument.

Freq & Span Tab

The Freq & Span tab provides access to settings that control frequency settings for the trace display. The control values set in this tab are shared by all the General Signal Viewing displays.

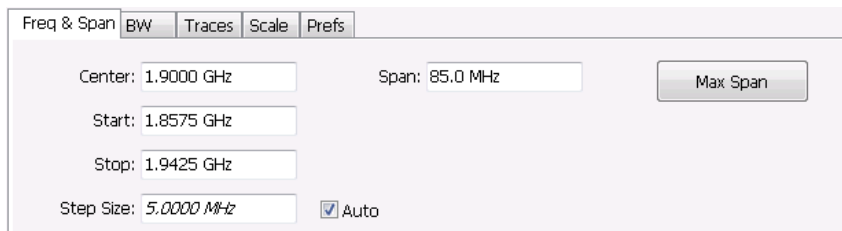

Setting	Description
Center	The frequency at the center of the selected span.
Start	The lowest frequency in the span.
Stop	The highest frequency in the span.
Span	The difference between the start and stop frequencies. This is the measurement bandwidth for the general signal viewing displays.
Step Size	Sets the increment/decrement size for Center, Start, and Stop values.
Max Span	Sets the span to the maximum value.
Auto checkbox	Sets the Step Size automatically when checked.

Center, Start, Stop, and Span frequencies are correlated

Changing the values for center frequency, start frequency, stop frequency or span will change the values for the other settings, depending on which setting you change. For example, if you change the center frequency, the start and stop frequencies will be adjusted automatically to maintain the same span.

If, however, the start and stop frequencies are changed so that they are closer than the minimum span setting, the start and stop frequencies will be adjusted to maintain the minimum span setting.

Setting changed manually	Settings changed automatically as a result	Setting not automatically changed
Start	Center, Span	Stop
Stop	Center, Span	Start
Center Frequency	Start, Stop	Span
Span	Start, Stop	Center

Traces Tab

The Traces Tab allows you to set the display characteristics of displayed traces.



Setting	Description
Trace	Selects a trace. (This setting is not present for every display.)
Show	Shows / hides the selected trace.
Detection	Sets the Detection method used for the trace. Not available for saved traces. Available detection methods are +Peak, -Peak, +/-Peak, Avg (VRMS), Sample, and CISPR Peak. Not all detection methods are available in all displays.
Function	Selects the trace processing method. Available settings are: Normal, Average, Max Hold, and Min Hold.
Count	Sets the number of traces averaged to generate the displayed trace. (Present only when Function is set to Average, Min Hold, or Max Hold.)
Freeze	Halts updates to the selected trace.
Save Trace As	Saves the selected trace to a file for later recall and analysis.
Show Recalled trace	Displays a saved trace instead of a live trace. When a trace is recalled, controls such as show, freeze, function, and detection of trace will be disabled.

Trace

Available traces for Spectrum are: Trace 1, Trace 2, Trace 3, Math, and Spectrogram. Other displays support fewer traces. Traces 1-3 are based on the input signal and enable you to display the input signal using different processing. For example, you could display Trace 1 with Function set to Normal, Trace 2 with Function set to Max Hold and Trace 3 with Function set to Min Hold.

The Math trace is the result of subtracting one trace from another.

The Spectrogram trace applies only to the Spectrum display and is available only if the Spectrogram display is shown. The Spectrogram trace shows the trace selected in the Spectrogram as a spectrum trace.

Detection

Trace Detection is used to reduce the results of a measurement to the desired number of trace points. For example, if the maximum number of trace points is 100,000, and a measurement over the selected analysis length yields 200,000 points, the measurement must decimate these 200,000 trace points by 2 to prevent exceeding the 100,000 trace point limit. Since only one value can be represented for each trace point, an algorithm must be used to select (detect) the appropriate value to use.

The results array from an analysis can be detected (or “decimated”) in a variety of ways. The number of results points produced for each trace point varies with both analysis length and trace length. For example, the frequency transform used for the Spectrum display produces just one output value for each desired trace point. In this case, the detection method chosen has no effect, as no decimation is required.

Increasing the Analysis Length (or for the Spectrum display, the Spectrum Length), causes the available detection method's output traces to differ from each other because they have a larger set of samples for the various detection methods to process.

The available detection methods (depending on the display) are:

- **+Peak** – The highest value is selected from the results to be compressed into a trace point.
- **-Peak** – The lowest value is selected from the results to be compressed into a trace point.
- **+/-Peak** – Both the highest and lowest values are selected from the results to be compressed into a trace point.
- **Avg (VRMS)** [Average V_{RMS}] – Each point on the trace is the result of determining the RMS Voltage value for all of the results values it includes. When displayed in either linear (Volts, Watts) or Log (dB, dBm), the correct RMS value results.
- **Avg (of logs)** – The detector is used to emulate legacy spectrum analyzer results and for the specification of displayed average noise level. In older swept analyzers, a voltage envelope detector is used in the process of measuring signal level, and the result is then converted to Watts and then to dBm. Averaging is then applied to the resultant traces.

For CW signals, this method results in an accurate power measurement. However, with random noise and digitally modulated carriers, errors result from this 'average of logs' method. For random noise, the average of logs methods results in power levels -2.51 dB lower than that measured with a power meter, or with a signal analyzer that measures the rms value of a signal, and performs averaging on the calculated power in Watts and not dBm or other log-power units.

This detector should be used when following a measurement procedure that specifies it, or when checking the Displayed Averaged Noise Level (DANL) of the instrument. The 'average of logs' detection and trace function is used for DANL specification to provide similar results to other spectrum/signal analyzers for comparison purposes. Use of the Average of Logs method of measurement is not recommended for digitally modulated carriers, as power measurement errors will occur.

NOTE. *The Detection setting does not affect the trace until the spectrum length is longer than the Auto setting.*

- **Sample** – The first value is selected from the set of results to be compressed into a trace point.
- **CISPR Peak** – The trace value is calculated by the methods described for peak detectors in the CISPR documents.

Trace Processing

Traces can be processed to display in different ways. The Function setting controls trace processing.

- **Normal** - Each new trace is displayed and then replaced by the next trace. Each data point contains a single vertical value.
- **Average** - Multiple traces are averaged together to generate the displayed trace, which will contain just one vertical value for each underlying frequency data point. Once the specified number of traces have been acquired and averaged to generate the displayed trace, additional traces contribute to the running average, except in Single Sequence run mode. In the case of Single Sequence, the instrument stops running after the specified number of traces have been averaged together. The **Number of Traces** setting specifies how many traces are averaged. The averaging is performed on the linear (Voltage) values, resulting in the correct RMS average).
- **Max Hold** - Displays the maximum value in the trace record for each display point. Each new trace's display point is compared to the previous maximum value and the greater value is retained for display and subsequent comparisons.
- **Min Hold** - Displays the minimum value in the trace record for each display point. Each new trace's display point is compared to the previous minimum value and the lesser value is retained for display and subsequent comparisons.

Saving Traces

To save a trace for later analysis:

1. Select the **Save Trace As** button. This displays the Save As dialog box.
2. Navigate to the desired folder or use the default.
3. Type a name for the saved trace and click **Save**.

Recalling Traces

You can recall a previously saved trace for analysis or comparison to a live trace.

To select a trace for recall:

1. Select the trace into which the recalled trace will be loaded, from the Trace drop-down list.
2. Check the **Show** check box.
3. Click the ... button to display the Open dialog box.

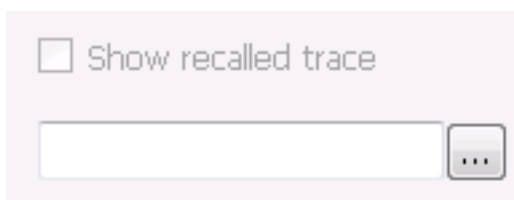

4. Navigate to the desired file and click **Open**.

5. Check the **Show Recalled Trace** check box.
6. Verify that the trace's **Show** check box is selected (either on this tab or next to the drop-down list located at the top-left corner of the graph).

Traces tab - Math Trace

This tab is not a distinct tab, it is just how the Traces tab appears when Math is selected in the Traces drop-down list.

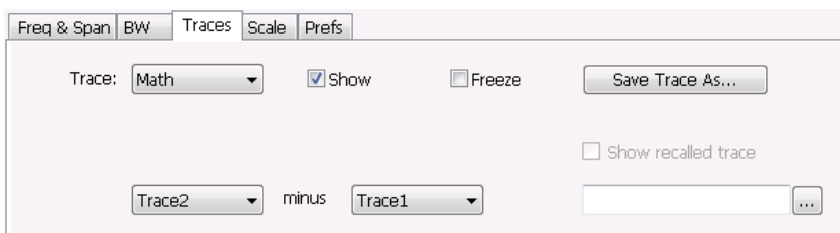

Trace 4 is a mathematically-derived trace defined as Trace A minus Trace B. You can select Trace 1, 2, or 3 to serve as either Trace A or Trace B.

Setting	Description
Trace	When set to Trace 4 (Math), this tab is displayed.
Show	Shows / hides the selected trace.
Freeze	Halts updates to the selected trace.
Save Trace As	Saves the selected trace to a file for later recall and analysis.
Trace minus Trace	Selects which traces serve as Trace A and Trace B.

BW Tab

The BW (bandwidth) tab allows you to change Resolution Bandwidth and Video Bandwidth settings, and set the windowing method used by the transform process by selecting a filter shape (not present for all displays).

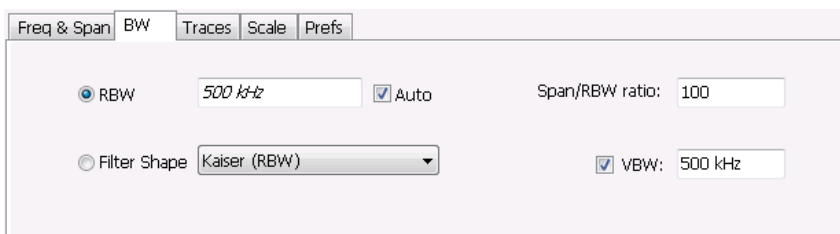

Setting	Description
RBW	Sets the Resolution Bandwidth value to be used in the spectrum analysis view. The value is italicized when Auto is selected.
Auto	When Auto is checked, the RBW is calculated as a percentage of the Span. Kaiser is selected as the windowing method. When Auto is unchecked, the RBW is set by the user. Selecting any Window other than Kaiser changes the RBW setting to manual.
Span/RBW ratio	If Auto is checked, this value is used to calculate the RBW. If Auto is unchecked, this setting is not selectable.
Filter Shape	Specifies the windowing method used for the transform (when Auto is unchecked). (Spectrum and Spectrogram displays only.)
VBW	Adjusts the VBW (Video Bandwidth) value. (Spectrum and Spectrogram displays only.)

Filter shape settings

In the analyzer, computationally efficient discrete Fourier transform algorithms such as FFT (Fast Fourier Transform) or CZT (Chirp-Z Transform) are generally employed to transform time-domain signals into frequency-domain spectra. There is an assumption inherent in the mathematics of Discrete Fourier Transforms that the data to be processed is a single period of a periodically repeating signal. The discontinuities between successive frames will generally occur when the periodic extension is made to the signal. These artificial discontinuities generate spurious responses not present in the original signal, which can make it impossible to detect small signals in the presence of nearby large ones. This phenomenon is called spectral leakage.

Applying a filter, such as Kaiser, to the signal to be transformed is an effective method to combat the spectral leakage problem. Generally the filter has a bell shape. Multiplying the transform frame by the filter function eliminates or reduces the discontinuities at the ends of the frame, however, at the expense of increased RBW.

Filter shape characteristics

The choice of filter shape depends on its frequency response characteristics such as side-lobe level, equivalent noise bandwidth and maximum amplitude error. Use the following guidelines to select the best filter shape.

Filter Shape	Characteristics
Kaiser (RBW)	Best side-lobe level, shape factor closest to the traditional Gaussian RBW.
-6dB RBW (MIL)	These filters are specified for bandwidth at their -6 dB point, as required by military EMI regulations.
CISPR	These filters comply with the requirements specified in the P-CISPR 16 -1-1 document for EMI measurements.
Blackman-Harris 4B	Good side-lobe level.
Uniform (None)	Best frequency resolution, poor side-lobe level and amplitude accuracy.
Flat-Top (CW ampl)	Best amplitude accuracy, best representation of brief events captured near the beginning or end of the time-domain data frame, poor frequency resolution.
Hanning	Good frequency resolution, high side-lobe roll-off rate.

VBW

The VBW setting enables/disables the Video Bandwidth filter. VBW is used in traditional swept analyzers to reduce the effect of noise on the displayed signal. The VBW algorithm in the analyzer emulates the VBW filters of traditional swept analyzers.

The maximum VBW value is 10 times the current RBW setting. The minimum VBW value is 1/10,000 of the RBW setting. VBW is disabled when the Filter shape is set to CISPR.

NOTE. If you are following a procedure that says to "set VBW to three times the RBW value or greater", it means that the test should be conducted with no VBW effects. In the SignalVu software, this condition is met by disabling the VBW function.

Scale Tab

The Scale tab allows you to change the vertical and horizontal scale settings. Changing the scale settings changes how the trace appears on the display but does not change control settings such as Measurement Frequency. In effect, these controls operate like pan and zoom controls.

The Scale tab values are unique to each display. Also, note that each display uses horizontal and vertical units that are appropriate for the display. For example, for the Spectrum display uses power (dBm) units and frequency (Hz) units; the Amplitude vs. Time display uses power (dBm) and time (seconds) units; and the Phase vs. Time display uses phase (degrees) and time (seconds) units.

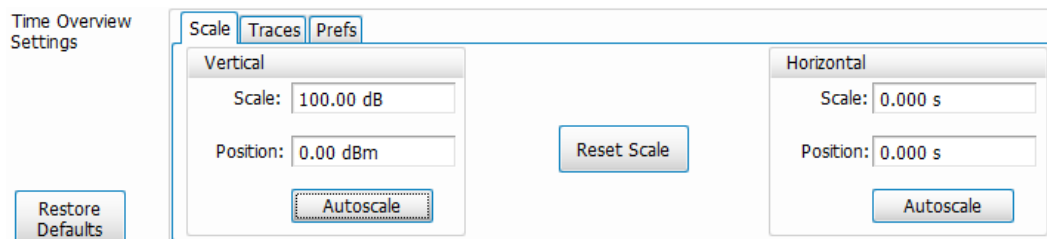

Setting	Description
Vertical	Controls the vertical position and scale of the trace display.
Scale	Changes the vertical scale.
Position	Vertical position adjusts the reference level away from top of the graph.
Autoscale	Resets the scale of the vertical axis to contain the complete trace.
Horizontal	Controls the horizontal position and scale of the trace span of the trace display and position of the trace.
Scale	Changes the range shown between the left and right sides of the graph.
Position	Changes the position of the acquisition record shown at the left edge of the graph.
Reset Scale	Resets all settings to their default values.

Prefs Tab

The Prefs tab enables you to change parameters of the measurement display. The parameters available on the Prefs tab vary depending on the selected display, but include such items as enabling/disabling marker Readout and switching the Graticule display on/off.

Each of the General Signal Viewing displays maintains its own separate values for the controls that appear on the Prefs tab. Some parameters appear with most displays while others appear with only one display.

For example, in the following image, the Show Marker readout in graph check box appears in the Prefs tab for every display. However, the Show Power Trigger level check box only appears on the Amplitude vs Time Prefs tab.

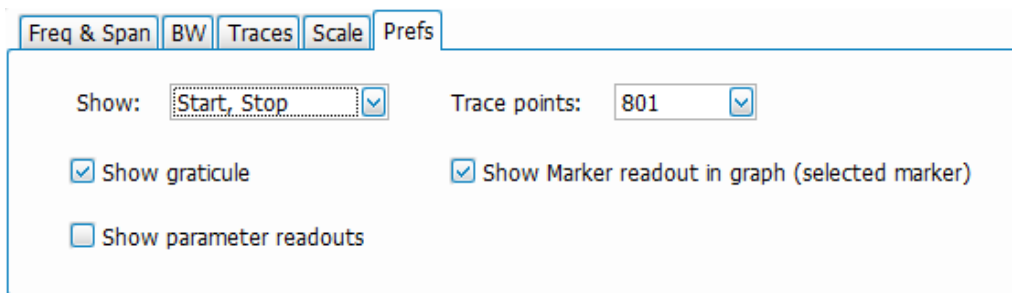

The following image shows the Prefs tab for the Time Overview display.

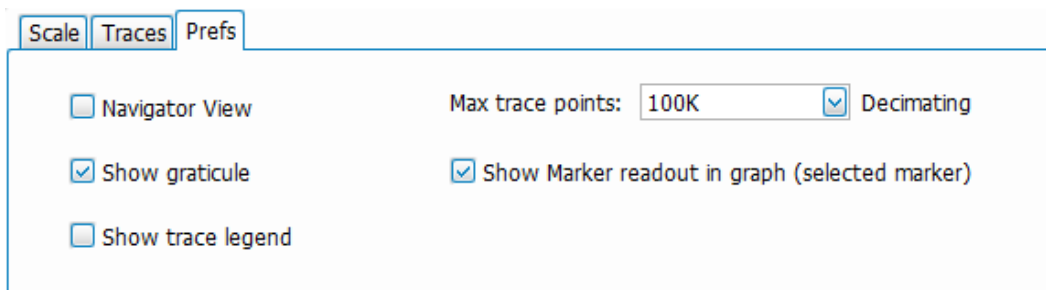

The following table explains the controls that can appear on the Prefs tab.

Setting	Description
Show	Sets the horizontal settings that appear below the graph area. You can select Start, Stop or Center, Span.
Trace points	Sets the number of trace points used for marker measurements and for results export.
Max trace points (Time Overview display only)	Sets the maximum number of trace points used for marker measurements and for results export.
Show trace legend	Enables display of a legend in the measurements area that shows the Detection method and Function setting for displayed traces. The color of the legend text matches the color of the associated trace.
Show graticule	Check to display the graticule. Uncheck to hide the graticule.
Navigator View (Time Overview display only)	Places the Time Overview display across the top of the application window, above all other active displays.
Show Marker readout in graph (selected marker)	Shows or hides the readout for the selected marker in the graph area.
Show timestamp in graph (selected line)	For spectrogram displays, this readout shows or hides the timestamp associated with the selected line or marker position.
DPX shows only trigger frames	For the DPX Spectrum display, check to show only trigger frames.
Show Power Trigger Level	Displays or hides a green line in the graph that indicates the level at which the power trigger is set. The line is not displayed if Trigger is set to Free Run.

Overview

The displays in Analog Modulation (Displays > Measurements > Analog Modulation) are:

- AM
- FM
- PM

The Analog Modulation displays provide measurements and time-domain trace displays.

AM Display

The Amplitude Modulation Display is a graph of Modulation Factor vs Time. The AM display includes three numeric readouts.

To show the AM display:

1. Select the **Displays** button or select **Setup > Displays**. This shows the **Select Displays** dialog box.
2. From the **Measurements** box, select **Analog Modulation**.
3. Double-click the **AM** icon in the **Available Displays** box. This adds the AM icon to the **Selected displays** box.
4. Click the **OK** button. This shows the AM display.

Elements of the Display

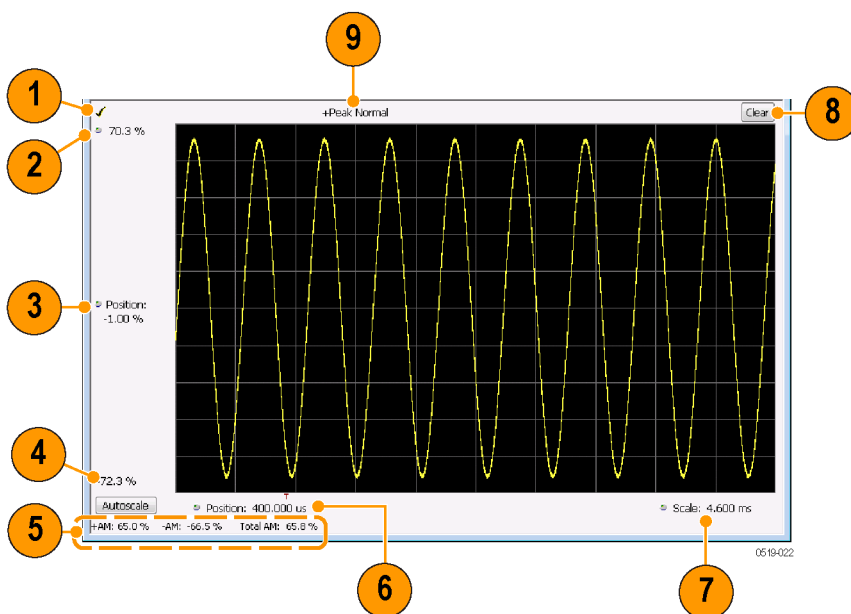

Item	Element	Description
1	Check mark indicator	The check mark indicator in the upper, left-hand corner of the display shows when the AM display is the optimized display. NOTE. When Best for multiple windows is selected in the Amplitude control panel's RF & IF Optimization control, none of the measurement displays shows a checkmark, as there is not a single optimized measurement.
2	Top of Graph	Sets the %AM indicated at the top of the graph by increasing or decreasing the vertical scale. Changing the top value affects the bottom of graph value because the graph scales about vertical center. Also, note that the top of graph setting interacts with the internal vertical scale setting (which is not user settable).
3	Position	Specifies the %AM shown at the center of the graph display.
4	Bottom Readout	Displays the value of the modulation factor shown at the bottom of graph.
5	Measurement readouts	Displays numeric values for the +AM (positive modulation factor), -AM (negative modulation factor), and Total AM.
6	Position	Specifies the horizontal position of the trace on the graph display.
7	Scale	Adjusts the horizontal range of the graph. By decreasing the scale (time across the entire graph), the graph essentially becomes a window that you can move over the trace by adjusting the position.
8	Clear	Erases the trace from the graph.
9	Trace Detection readout	Displays the Settings > Trace > Detection setting.

[Changing the AM Settings \(see page 74\)](#)

AM Settings

Main menu bar: Setup > Settings

Favorites toolbar: 

The AM Settings control panel provides access to settings that control parameters of the AM Display.

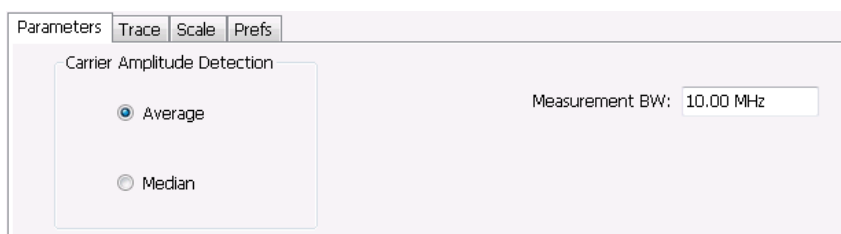

Setting	Description
Parameters (see page 75)	Sets the Carrier Amplitude Detection method. You can choose either Average or Median.
Trace (see page 76)	Sets Trace display parameters.
Scale (see page 78)	Sets vertical and horizontal scale and position parameters.
Prefs (see page 79)	Specifies whether or not certain display elements are shown. Specifies the maximum number of points shown in the display graph.

Parameters Tab

The Parameters tab enables you to specify two parameters that control the carrier amplitude detection.

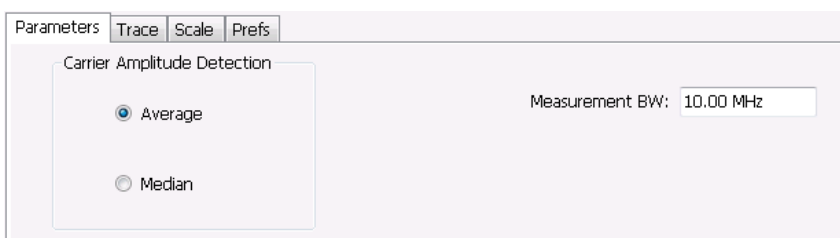

Setting	Description
Average	Selects the Average method for computing the average baseline for measurements.
Median	Selects the Median method for computing the average baseline for measurements.
Measurement BW	Specifies the bandwidth about the center frequency at which measurements are made.

AM Modulation

An amplitude modulated carrier can be described mathematically by:

$$X(t) = [A + a(t)] \cos \omega_0 t$$

A, in the above equation, represents the carrier amplitude, a(t) represents the time-varying modulation and ω_0 represents the carrier frequency.

The signal modulation envelope is given by:

$$E_M(t) = A + a(t)$$

There are several ways to express the AM modulation depth, expressed as a percentage.

Peak method

$$AM\text{ModulationDepth} = \frac{\text{Max}[A + a(t)]}{A}$$

Trough Method

$$AM\text{ModulationDepth} = \frac{\text{Min}[A + a(t)]}{A}$$

Max-Min Method

$$AMModulationDepth = \frac{Max [A + a (t)] - Min [A + a (t)]}{2A}$$

In each case, the value of the carrier amplitude, *A*, needs to be estimated from the input signal.

The instrument represents signals in a sampled form. The sampled envelope can be expressed as a function of sample index *K* and sampling period *T* as:

$$E_M [KT] = A + a [KT]$$

The instrument allows the choice of two methods for estimating the carrier amplitude:

Average Method

$$A = Average \{E_M [KT]\}$$

Median Method

$$A = Median \{E_M [KT]\}$$

In both cases, the instrument computes the average and the median over the analysis period. It should be noted that the two methods give the same result for sinusoidal modulation where the sampling frequency is much higher than the modulation frequency.

Trace Tab

The Trace Tab allows you to set the display characteristics of a trace.



Setting	Description
Show	Shows/hides the trace. If the instrument continues to run, the measurement results below the graph display continue to update even if the trace is hidden.
Detection	Sets the Detection method used for the trace. Available detection methods are +Peak, -Peak, and Avg (VRMS). Not available for saved traces.
Function	Selects the trace processing method. The only available setting is Normal.
Freeze	Halts updates to the trace.
Save Trace As	Saves the trace to a file for later recall and analysis.
Show recalled trace	Displays a saved trace instead of a live trace.

Detection

Detection refers to the method of processing the data acquisition points when creating a trace. The IQ samples in a data acquisition can be detected in a variety of ways. The number of IQ samples available to each trace point varies with both analysis length and trace length. For example, with Spectrum Length set to 'Auto' in the Analysis menu, the instrument analyzes just enough samples to produce one IQ sample pair per trace point. In this case, the detection method chosen has very little effect, as the +Peak, -Peak, and Avg (VRMS) are all equal. Changing the Spectrum Length causes the available detection methods to differ in value because they have a larger set of samples for the various detection methods to process.

The available detection methods are:

- **+Peak** – Each point on the trace is the result of detecting the positive peak value present in the set of IQ samples available to that trace point.
- **-Peak** – Each point on the trace is the result of detecting the negative peak value present in the set of IQ samples available to that trace point.
- **Avg (VRMS)** [Average V_{RMS}] – Each point on the trace is the result of determining the RMS Voltage value for all of the IQ samples available to the trace point. When displayed in either linear (Volts, Watts) or Log (dB, dBm), the correct RMS value results. When the averaging function is applied to a trace, the averaging is performed on the linear (Voltage) values, resulting in the correct average for RMS values.

Trace Processing

Traces can be processed to display in different ways. The Detection setting controls trace decimation, when needed. When the trace points each cover more than one sample data point, the vertical results values for multiple data points are combined into each trace point. Each trace point ends up with a single vertical value.

- **Average** - Each trace point is computed by averaging together the multiple results points it represents.
- **+Peak** - Each trace point represents the highest vertical value among the results it includes.
- **-Peak** - Each trace point represents the lowest vertical value among the results it includes.

Saving Traces

To save a trace for later analysis:

1. Select the **Save Trace As** button. This displays the Save As dialog box.
2. Navigate to the desired folder or use the default.
3. Type a name for the saved trace and click **Save**.

Recalling Traces

You can recall a previously saved trace for analysis or comparison to a live trace.

To select a trace for recall:

1. Click the ... button to display the Open dialog box.
2. Navigate to the desired file and click **Open**.
3. Check the **Show Recalled Trace** check box.
4. Verify that the **Show** check box is selected.

Scale Tab

The Scale tab allows you to change the vertical and horizontal scale settings. Changing the scale settings changes how the trace appears on the display but does not change control settings such as Measurement Frequency. In effect, these controls operate like pan and zoom controls.

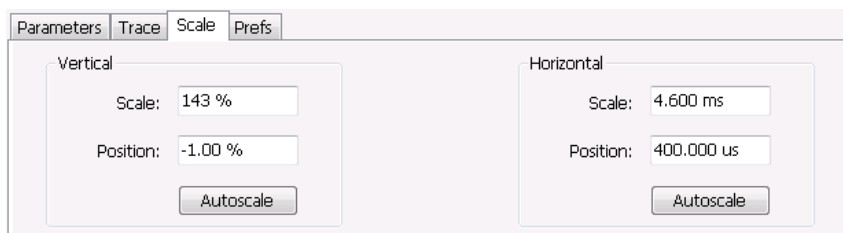

Setting	Description
Vertical	
Scale	Changes the range shown between the top and bottom of the graph.
Position	Adjusts the level shown at the center of the graph.
Autoscale	Resets the Position so that the entire trace is in the graph.
Horizontal	
Scale	Changes the range shown between the left and right sides of the graph.
Position	Adjusts the position of the acquisition record shown at the left edge of the graph.
Autoscale	Resets the Scale and Position settings to provide the optimum display.

Prefs Tab

The Prefs tab enables you to change appearance characteristics of the AM display.

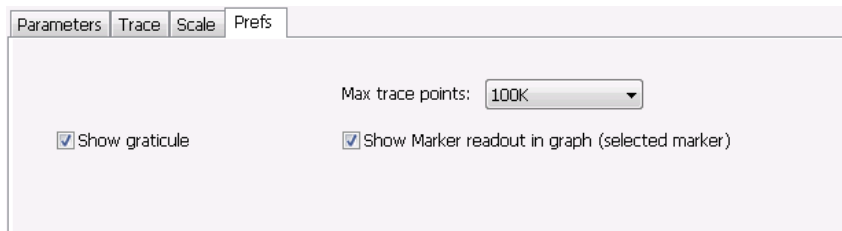

Setting	Description
Show graticule	Shows or hides the graticule.
Show Marker readout in graph (selected marker)	Shows or hides the readout for the selected marker in the graph area.
Max trace points	The trace in the AM display can be set to a maximum of 100,000 points (however, the actual number of trace points can extend up to 500,000 points if Max trace points is set to Never Decimate). If the Analysis Length includes more than the selected Max trace points value, the trace is decimated (using the method specified with the Detection control) to be equal to or less than the Max trace points setting (except when Max trace points is set to Never Decimate). This decimated (or undecimated) trace is what is used for marker measurements and for results export.

FM Display

The Frequency Modulation Display shows Frequency Deviation vs. Time. The vertical axis units are Hertz and the horizontal axis units are seconds. When taking measurements, only the first burst in the Analysis period is analyzed. No trace points are shown for data outside the first detected burst, nor are measurements made on data outside the first detected burst.

To show the FM display:

1. Select the **Displays** button or select **Setup > Displays**. This shows the **Select Displays** dialog box.
2. From the **Measurements** box, select **Analog Modulation**.
3. Double-click the **FM** icon in the **Available Displays** box. This adds the FM icon to the **Selected displays** box.
4. Click the **OK** button. This shows the FM display.

Elements of the Display

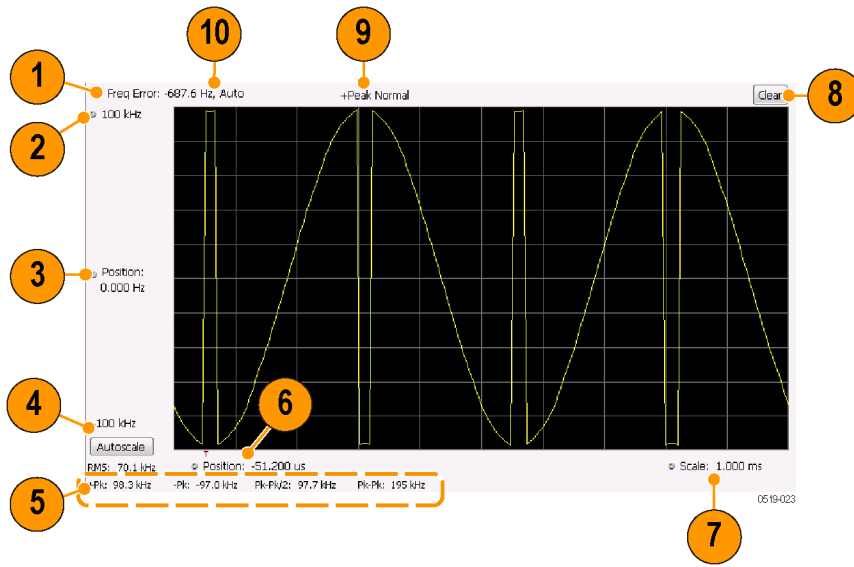

Item	Element	Description
1	Check mark indicator	The check mark indicator in the upper, left-hand corner of the display shows when the FM display is the optimized display. NOTE. When Best for multiple windows is selected in the Amplitude control panel's RF & IF Optimization control, none of the measurement displays shows a checkmark, as there is not a single optimized measurement.
2	Top of Graph control	Sets the frequency indicated at the top of the graph. Since the Position value at the vertical center of this graph remains constant as the Top of Graph value is adjusted, the Vertical Scale increases as the Top of Graph value increases, which also affects the bottom of graph readout. Vertical Scale can also be controlled from the Settings control panel's Scale tab.
3	Position	Specifies the frequency shown at the center of the graph display. Changing this value moves the trace up and down in the graph, which affects the Top of Graph and Bottom of Graph values as well.
4	Bottom of Graph Readout	Displays the frequency value at the bottom of the graph.
5	Measurement readouts	Displays numeric values for the +Pk (positive frequency deviation), -Pk (negative frequency deviation), RMS (RMS value of the deviation), Pk-Pk (peak-to-peak frequency deviation), and Pk-Pk/2 (peak-to-peak frequency deviation divided by two).
6	Position	Specifies the horizontal position of the trace on the graph display.
7	Scale	Adjusts the time range of the graph. By decreasing the scale (full-scale time over 10 divisions), the graph essentially becomes a window that you can move over the acquisition record by adjusting the horizontal position.
8	Clear	Clears the trace and numeric measurement results.
9	Trace Detection readout	Displays the Settings > Trace > Detection setting.
10	Freq Error	This readout can show Freq Error or Freq Offset. When it displays Freq Error, it shows the difference between the instrument Frequency setting and the measured value of the signal's carrier frequency. When it displays Freq Offset, it shows the frequency offset specified on the Settings > Parameters tab. If Freq Error is displayed, it also indicates that the Carrier frequency detection setting is Auto. If Freq Offset is displayed, it indicates that the Carrier frequency detection setting is manual.

[Changing the FM Settings \(see page 81\)](#)

FM Settings

Main menu bar: Setup > Settings

Favorites toolbar: 

The FM Settings control panel provides access to settings that control parameters of the FM Display.

Parameters	Trace	Scale	Prefs
Burst detect threshold:	-100 dBc		
Measurement BW:	100.0 kHz	Frequency offset:	-50.54 Hz <input checked="" type="checkbox"/> Auto
			<input type="button" value="Load from marker"/>

Setting	Description
Parameters (see page 447)	Sets the burst detection threshold, measurement bandwidth, and carrier frequency detection method.
Trace (see page 84)	Sets Trace display parameters.
Scale (see page 86)	Sets vertical and horizontal scale and position parameters.
Prefs (see page 87)	Specifies whether or not certain display elements are shown. Specifies the maximum number of points shown in the display graph.

Parameters Tab

The Parameters tab enables you to specify parameters for carrier detection.

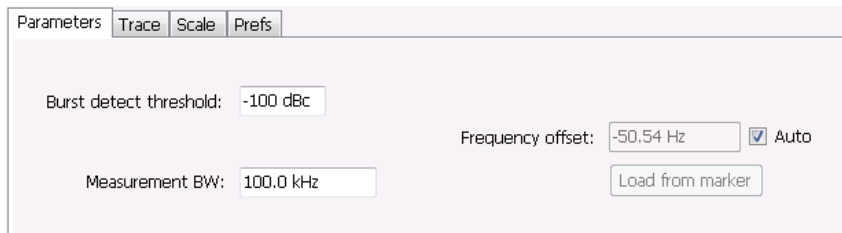

Setting	Description
Burst detect threshold	This parameter specifies the power level used to determine whether a burst is present. A valid burst is required to take measurements. The burst detected first is used for the analysis. The units for burst detect threshold are dBc, relative to the maximum acquisition sample data points level.
Measurement BW	Specifies the bandwidth about the center frequency at which measurements are made.
Frequency offset	Displays the carrier signal's offset from the instrument's measurement frequency. Auto is used to select the method for determining the carrier frequency. When Auto is selected, the instrument determines the carrier frequency by analyzing the signal. When Auto is deselected, you can set the carrier frequency offset using Frequency Offset.
Load from Marker	Pressing this button sets the frequency offset to the frequency offset of the selected marker. (Pressing this button automatically deselects Auto.)

Frequency Offset

In Auto (Auto is selected), the instrument scans the measurement bandwidth about the measurement frequency and looks for the highest-powered signal. This is defined as the carrier frequency. In Manual (Auto is deselected), the carrier frequency is specified by adding/subtracting the specified Frequency offset from the measurement frequency. Range: $-(\text{Measurement BW} \times 1.1)/2$ to $+(\text{Measurement BW} \times 1.1)/2$. If the **Load from Marker** button is pressed, the frequency offset is determined from the phase difference between the two markers on screen compared to the time between the two markers. This function is useful for removing frequency slope from the phase modulated signal.

Load from Marker

When the Auto check box is selected, the instrument scans the measurement bandwidth about the center frequency and looks for the highest-powered signal. This is defined as the carrier frequency. When the Auto check box is deselected, the carrier frequency is specified by adding/subtracting the specified Frequency offset from the center frequency. Pressing the Load from Marker button loads the marker frequency into the Frequency offset box.

Trace Tab

The Trace Tab allows you to set the display characteristics of displayed traces.



Setting	Description
Show	Shows / hides the trace. If the instrument continues to run, the measurement results below the graph display continue to update even if the trace is hidden.
Detection	Sets the Detection method used for the trace. Available detection methods are +Peak, -Peak, and Avg (VRMS). Not available for saved traces.
Function	Selects the trace processing method. The only available setting is Normal.
Freeze	Halts updates to the trace.
Save Trace As	Saves the trace to a file for later recall and analysis.
Show Recalled trace	Displays a saved trace instead of a live trace.

Detection

Detection refers to the method of processing the data acquisition points when creating a trace. The IQ samples in a data acquisition can be detected in a variety of ways. The number of IQ samples available to each trace point varies with both analysis length and trace length. For example, with Spectrum Length set to 'Auto' in the Analysis menu, the instrument analyzes just enough samples to produce one IQ sample pair per trace point. In this case, the detection method chosen has very little effect, as the +Peak, -Peak, and Avg (VRMS) are all equal. Changing the Spectrum Length causes the available detection methods to differ in value because they have a larger set of samples for the various detection methods to process.

The available detection methods are:

- **+Peak** – Each point on the trace is the result of detecting the positive peak value present in the set of IQ samples available to that trace point.
- **-Peak** – Each point on the trace is the result of detecting the negative peak value present in the set of IQ samples available to that trace point.
- **Avg (VRMS)** [Average V_{RMS}] – Each point on the trace is the result of determining the RMS Voltage value for all of the IQ samples available to the trace point. When displayed in either linear (Volts, Watts) or Log (dB, dBm), the correct RMS value results. When the averaging function is applied to a trace, the averaging is performed on the linear (Voltage) values, resulting in the correct average for RMS values.

Trace Processing

Traces can be processed to display in different ways. The Function setting controls trace processing.

- **Normal** - Each new trace is displayed and then replaced by the next trace. Each data point contains a single vertical value.
- **Average** - Each trace point is computed by averaging together the multiple results points it represents.
- **+Peak** - Each trace point represents the highest vertical value among the results it includes.
- **-Peak** - Each trace point represents the lowest vertical value among the results it includes.

Saving Traces

To save a trace for later analysis:

1. Select the **Save Trace As** button. This displays the Save As dialog box.
2. Navigate to the desired folder or use the default.
3. Type a name for the saved trace and click **Save**.

Recalling Traces

You can recall a previously saved trace for analysis or comparison to a live trace.

To select a trace for recall:

1. Click the **...** button to display the Open dialog box.
2. Navigate to the desired file and click **Open**.
3. Check the **Show Recalled Trace** check box.
4. Verify that the **Show** check box is selected.

Scale Tab

The Scale tab allows you to change the vertical and horizontal scale settings. Changing the scale settings changes how the trace appears on the display but does not change control settings such as Measurement Frequency. In effect, these controls operate like pan and zoom controls.

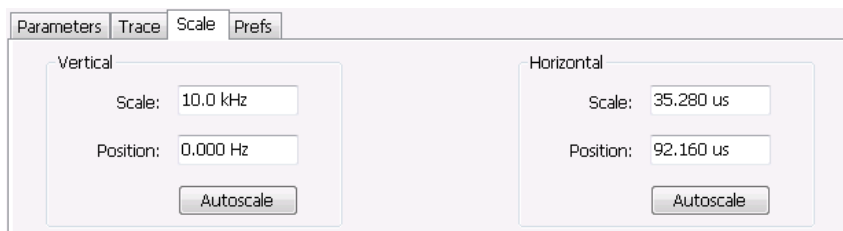

Setting	Description
Vertical	
Scale	Changes the range shown between the top and bottom of the graph.
Position	Adjusts the frequency shown at the center of the graph.
Autoscale	Resets the Position so that the entire trace fits within the graph.
Horizontal	
Scale	Changes the range shown between the left and right sides of the graph.
Position	Adjusts the position of the acquisition record shown at the left edge of the graph.
Autoscale	Resets the Scale and Position settings to provide the optimum display.

Prefs Tab

The Prefs tab enables you to change appearance characteristics of the FM display.

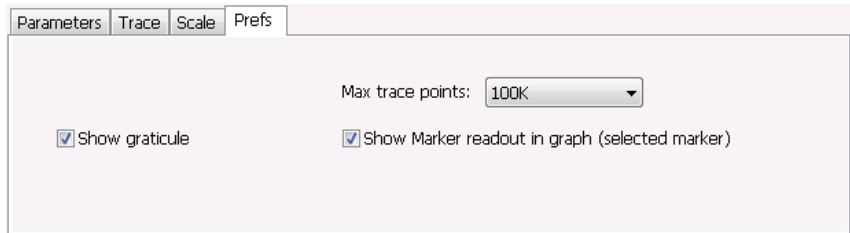

Setting	Description
Show graticule	Shows or hides the graticule.
Show Marker readout in graph (selected marker)	Shows or hides the readout for the selected marker in the graph area.
Max trace points	The trace in the FM display can be set to a maximum of 100,000 points (however, the actual number of trace points can extend up to 500,000 points if Max trace points is set to Never Decimate). If the Analysis Length includes more than the selected Max trace points value, the trace is decimated (using the method specified with the Detection control) to be equal to or less than the Max trace points setting (except when Max trace points is set to Never Decimate). This decimated (or undecimated) trace is what is used for marker measurements and for results export.

PM Display

The Phase Modulation Display shows Phase vs. Time. The vertical axis units are degrees and the horizontal axis units are seconds. When taking measurements, only the first burst in the Analysis period is analyzed. No trace points are shown for data outside the first detected burst, nor are measurements made on data outside the first detected burst.

Elements of the Display

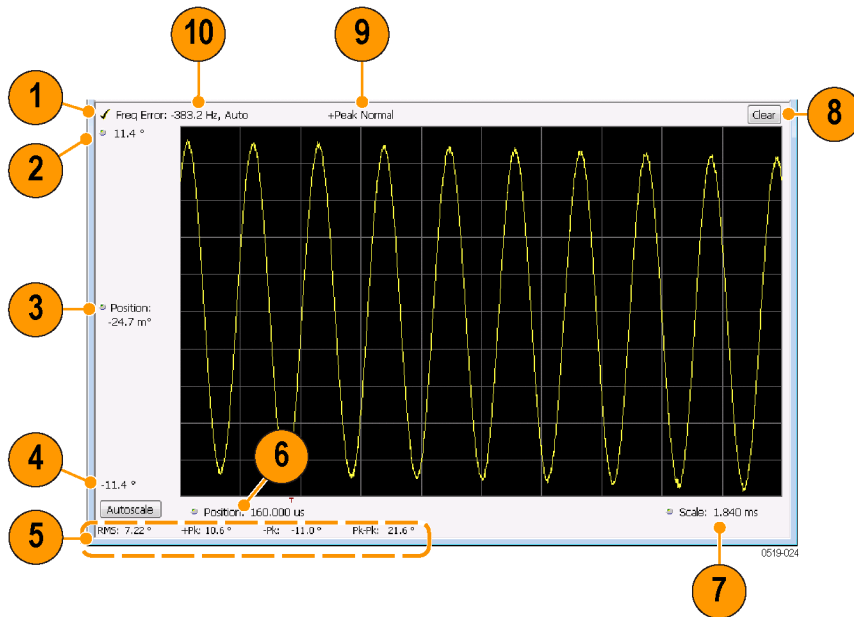

Item	Element	Description
1	Check mark indicator	The check mark indicator in the upper, left-hand corner of the display shows when the PM display is the optimized display. NOTE. When Best for multiple windows is selected in the Amplitude control panel's RF & IF Optimization control, none of the measurement displays shows a checkmark, as there is not a single optimized measurement.
2	Top of Graph control	Sets the phase value indicated at the top of the graph. Since the Position value at the vertical center of this graph remains constant as the Top of Graph value is adjusted, the Vertical Scale increases as the Top of Graph value increases, which also affects the bottom of graph readout. Vertical Scale can also be controlled from the Settings control panel's Scale tab.
3	Position	Specifies the phase shown at the center of the graph display. Changing this value moves the trace up and down in the graph, which affects the Top of Graph and Bottom of Graph values as well.
4	Bottom of Graph Readout	Displays the phase value at the bottom of the graph.
5	Measurement readouts	Displays numeric values for the +Pk (positive phase deviation), -Pk (negative phase deviation), Pk-Pk (peak-to-peak phase deviation), and RMS (RMS value of the phase deviation).
6	Position	Specifies the horizontal position of the trace on the graph display.
7	Scale	Adjusts the time range of the graph. By decreasing the scale (full-scale time over 10 divisions), the graph essentially becomes a window that you can move over the acquisition record by adjusting the horizontal position.
8	Clear	Clears the measurement results.
9	Trace Detection readout	Displays the Trace Detection setting (see Settings > Trace > Detection).
10	Freq Error	This readout can show Freq Error or Freq Offset. When it displays Freq Error, it shows the difference between the instrument Frequency setting and the measured value of the signal's carrier frequency. When it displays Freq Offset, it shows the frequency offset specified on the Settings > Parameters tab. If Freq Error is displayed, it also indicates that the Carrier frequency detection setting is Auto. If Freq Offset is displayed, it indicates that the Carrier frequency detection setting is manual.

[Changing the PM Settings \(see page 89\)](#)

PM Settings

Main menu bar: Setup > Settings

Favorites toolbar: 

The PM Settings control panel provides access to settings that control parameters of the PM Display.

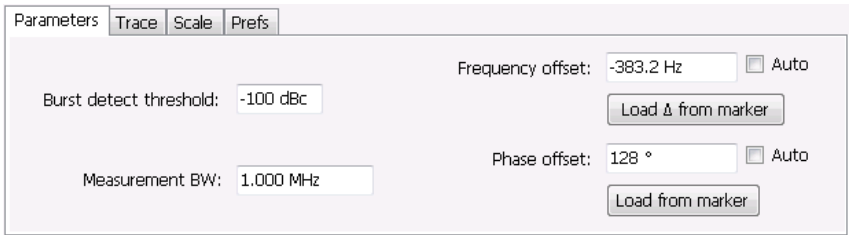

Setting	Description
Parameters (see page 90)	Sets the Carrier Frequency Detection method. You can choose either Automatic or Manual. Sets burst threshold and phase detection method.
Trace (see page 91)	Sets Trace display parameters.
Scale (see page 94)	Sets vertical and horizontal scale and position parameters.
Prefs (see page 95)	Specifies whether or not certain display elements are shown. Specifies the maximum number of points shown in the display graph.

Parameters Tab

The Parameters tab enables you to specify parameters that control the carrier frequency and phase detection.

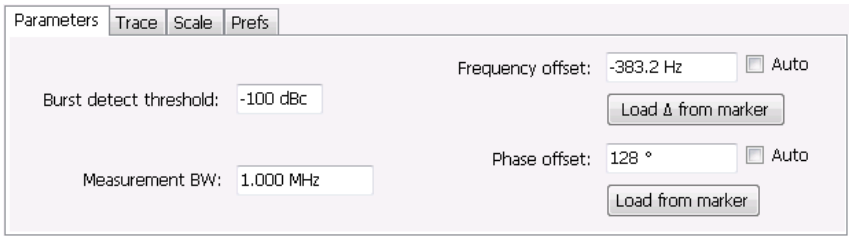

Setting	Description
Burst detect threshold	Specifies the power level used to determine whether a burst is present. A valid burst is required to take measurements. The burst detected first is used for the analysis. The units for burst detect threshold are dBc, relative to the maximum acquisition sample data points level.
Measurement BW	Specifies the bandwidth about the center frequency at which measurements are made.
Frequency offset	Displays the carrier signal's frequency offset from the instrument's Measurement Frequency. Auto is used to select the method for determining the carrier frequency. When Auto is selected, the instrument determines the carrier frequency by analyzing the signal. When Auto is deselected, you can set the carrier frequency offset using Frequency Offset.
Load Δ from Marker	Pressing this button disables the Auto Frequency Offset function and sets the Frequency offset to the frequency offset calculated from the difference between MR (the marker reference) and the selected marker (or M1 if MR is currently the selected marker).
Phase offset	Displays the phase offset. When Auto is selected, the instrument determines the phase offset. When Auto is deselected, the user sets the phase offset with this control.
Load from marker	Pressing this button sets the phase offset to the phase offset of the selected marker. (Pressing this button automatically deselects Auto.)

Frequency Offset

In Auto (Auto is selected), the instrument scans the measurement bandwidth about the Measurement Frequency and looks for the highest-powered signal. This is defined as the carrier frequency. In Manual (Auto is deselected), the carrier frequency is specified by adding/subtracting the specified Frequency offset from the Measurement Frequency. Range: $-(\text{Measurement BW} * 1.1) / 2$ to $+(\text{Measurement BW} * 1.1) / 2$. If the **Load Δ from marker** button is pressed, the frequency offset is determined from the phase difference between the two markers on screen compared to the time between the two markers. This function is useful for removing frequency slope from the phase modulated signal.

Phase Offset

In Auto (Auto is selected), the instrument sets the phase offset to fit the waveform to the screen centering 0° phase on the vertical axis. The actual phase offset is indicated on the Phase Offset readout. In Manual (Auto is deselected), the instrument sets the phase offset using the value specified in Phase offset. For example, when Phase offset is set to 10° , the waveform shifts upward by 10° on screen. Selecting **Load from marker** sets the phase offset to the value of the selected marker. Range: -180 to $+180^\circ$.

Trace Tab

The Traces Tab allows you to set the display characteristics of displayed traces.



Setting	Description
Show	Shows / hides the trace. If the instrument continues to run, the measurement results below the graph display continue to update even if the trace is hidden.
Detection	Sets the Detection method used for the trace. Available detection methods are +Peak, -Peak, and Avg (VRMS). Not available for saved traces.
Function	Selects the trace processing method. The only available setting is Normal.
Freeze	Halts updates to the trace.
Save Trace As	Saves the trace to a file for later recall and analysis.
Show Recalled trace	Displays a saved trace instead of a live trace.

Detection

Detection refers to the method of processing the data acquisition points when creating a trace. The IQ samples in a data acquisition can be detected in a variety of ways. The number of IQ samples available to each trace point varies with both analysis length and trace length. For example, with Spectrum Length set to 'Auto' in the Analysis menu, the instrument analyzes just enough samples to produce one IQ sample pair per trace point. In this case, the detection method chosen has very little effect, as the +Peak, -Peak, and Avg (VRMS) are all equal. Changing the Spectrum Length causes the available detection methods to differ in value because they have a larger set of samples for the various detection methods to process.

The available detection methods are:

- **+Peak** – Each point on the trace is the result of detecting the positive peak value present in the set of IQ samples available to that trace point.
- **-Peak** – Each point on the trace is the result of detecting the negative peak value present in the set of IQ samples available to that trace point.
- **Avg (VRMS)** [Average V_{RMS}] – Each point on the trace is the result of determining the RMS Voltage value for all of the IQ samples available to the trace point. When displayed in either linear (Volts, Watts) or Log (dB, dBm), the correct RMS value results. When the averaging function is applied to a trace, the averaging is performed on the linear (Voltage) values, resulting in the correct average for RMS values.

Trace Processing

Traces can be processed to display in different ways. The Function setting controls trace processing.

- **Normal** - Each new trace is displayed and then replaced by the next trace. Each data point contains a single vertical value.
- **Average** - Each trace point is computed by averaging together the multiple results points it represents.
- **+Peak** - Each trace point is represents the highest vertical value among the results it includes.
- **-Peak** - Each trace point is represents the lowest vertical value among the results it includes.

Saving Traces

To save a trace for later analysis:

1. Select the **Save Trace As** button. This displays the Save As dialog box.
2. Navigate to the desired folder or use the default.
3. Type a name for the saved trace and click **Save**.

Recalling Traces

You can recall a previously saved trace for analysis or comparison to a live trace.

To select a trace for recall:

1. Click the ... button to display the Open dialog box.
2. Navigate to the desired file and click **Open**.
3. Check the **Show Recalled Trace** check box.
4. Verify that the **Show** check box is selected.

Scale Tab

The Scale tab allows you to change the vertical and horizontal scale settings. Changing the scale settings changes how the trace appears on the display but does not change control settings such as Measurement Frequency. In effect, these controls operate like pan and zoom controls.

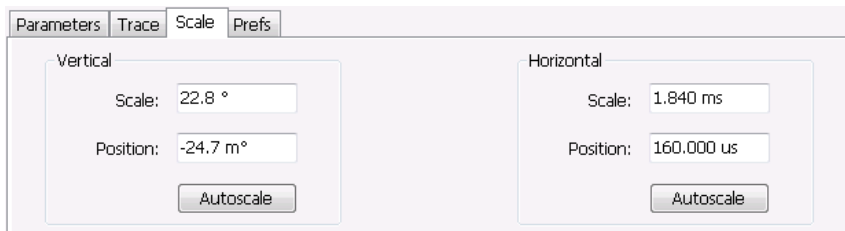

Setting	Description
Vertical	
Scale	Changes the range shown between the top and bottom of the graph.
Position	Adjusts the phase shown at the center of the graph.
Autoscale	Resets the Position so that the entire trace in the graph.
Horizontal	
Scale	Changes the range shown between the left and right sides of the graph.
Position	Adjusts the phase shown at the left edge of the graph.
Autoscale	Resets the Scale and Position settings to show the entire trace within the graph.

Prefs Tab

The Prefs tab enables you to change appearance characteristics of the PM display.

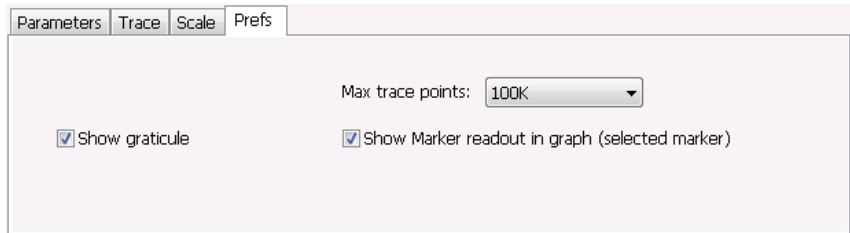

Setting	Description
Show graticule	Shows or hides the graticule.
Show Marker readout in graph (selected marker)	Shows or hides the readout for the selected marker in the graph area.
Max trace points	The trace in the PM display can be set to a maximum of 100,000 points (however, the actual number of trace points can extend up to 500,000 points if Max trace points is set to Never Decimate). If the Analysis Length includes more than the selected Max trace points value, the trace is decimated (using the method specified with the Detection control) to be equal to or less than the Max trace points setting (except when Max trace points is set to Never Decimate). This decimated (or undecimated) trace is what is used for marker measurements and for results export.

Overview

The displays in RF Measurements (Displays > Measurements > RF Measurements) are:

- CCDF
- Channel Power and ACPR
- Frequency and Phase Settling Time (Option SVT)
- MCPR
- Occupied Bandwidth
- SEM (Spectrum Emission Mask)
- Spurious

The RF Measurements power measurements and signal statistics help you characterize components and systems.

Power Measurements

Measurement	Description
Channel Power	The total RF power in the selected channel (located in the ACPR display).
Adjacent Channel Power Ratio	Measure of the signal power leaking from the main channel into adjacent channels.
Multi-Carrier Power Ratio	The ratio of the signal power in the reference channel or group of channels to the power in adjacent channels.
Peak/Avg Ratio	Ratio of the peak power in the transmitted signal to the average power in the transmitted signal (located in the CCDF display).
CCDF	The <i>Complementary Cumulative Distribution Function</i> (CCDF). CCDF shows how much time a signal spends at or above a given power level relative to the average power of a measured signal.

Channel Power and ACPR (Adjacent Channel Power Ratio) Display

Use the **Channel Power and ACPR** measurement to measure channel power by itself, or adjacent channel leakage ratio with one main channel.

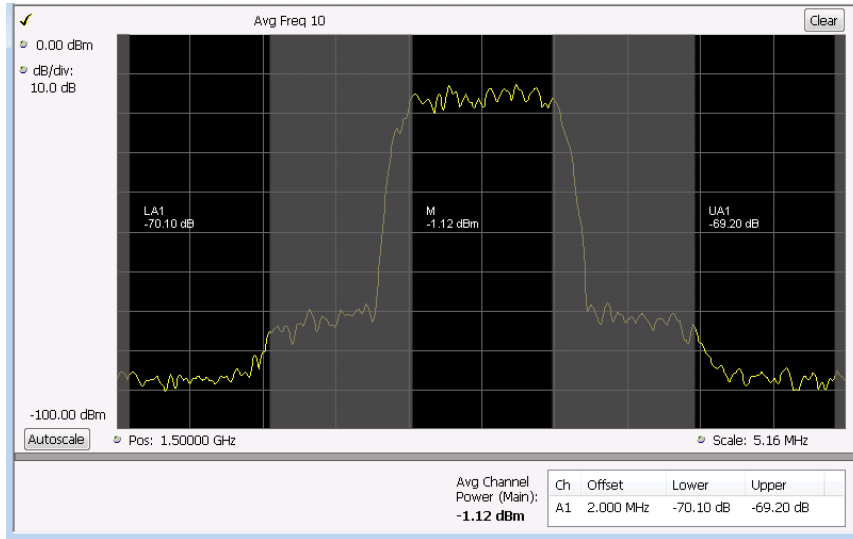

Measuring Adjacent Channel Power Ratio

1. Select the **Displays** button.
2. Select **RF Measurements** from the **Measurements** box.
3. Double-click **Chan Power and ACPR** in the Available displays box. Click **OK** to complete your selection.
4. Select **Settings** to display the Settings control panel for Chan Power and ACPR (the tab displayed will be the tab displayed the last time the Settings panel was opened).

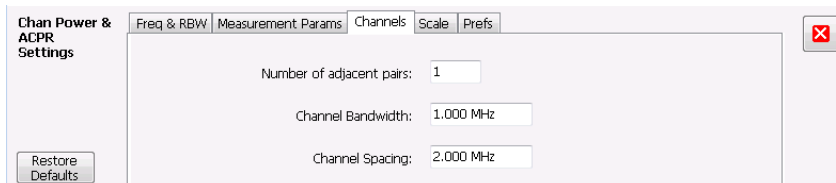

5. Select the **Freq & RBW** tab and adjust the frequency to that of your main channel. You can also change the frequency from the Status bar found at the bottom left side of the display.
6. To set the number of adjacent channels, select the **Channels** tab. Enter the number of channels in the **Number of adjacent pairs** value box. If zero is entered for the number of adjacent pairs, the resultant measurement will be channel power only.

NOTE. As you add adjacent channels, the span of the display is adjusted so that all the channels can be seen. Use the horizontal scale and offset to zoom the display in on any portion of the trace.

7. To set the spacing between channel centers, enter the required value in the **Channel Spacing** value box.

8. To set the channel bandwidth, enter the required value in the **Channel Bandwidth** value box.
9. After you have configured the channel settings, click the close button in the Settings panel or press **Settings** again to remove the Settings panel.
10. Press the **Run** button to take the measurements.

Viewing Results

Measurement results are displayed in a table below the graph and within the graph itself (which can be enabled/disabled in the Settings > Prefs tab). To see all measurements, you might need to scroll the table. The size of the results table can be changed by dragging the horizontal divider bar between the graph and table areas.

Channel Power (Main): -1.94 dBm	Ch	Offset	Lower	Upper
	A1	2.000 MHz	-65.69 dB	-64.82 dB

Heading	Description
Channel	Identifies the displayed channels. A1 means the first adjacent channel. A2 means second adjacent channel. Adjacent channels are numbered according to their offset from the Main channel. The closest channel is numbered 1. The next closest channel is numbered 2; and so forth.
Lower	The power measured for the lower adjacent channel. Adjacent channel power measurements are displayed in dB relative to the Main channel.
Upper	The power measured for the upper adjacent channel. Adjacent channels power measurements are displayed in dB relative to the Main channel.
Avg Channel Power (Main)	The power measured for the Main channel. The detection type used for measuring channel power and adjacent channel powers is Average. This means that the average of the linear (pre-log) samples is used to determine the power. The Main channel power is displayed in dBm.

[Setting Channel Power and ACPR Settings Parameters \(see page 100\)](#)

RF Channel Power Measurement

The RF channel power gives an indication of the total average (and other measures) RF power in a given channel.

For some communications systems, there is an “out-of-service” total power measurement defined in the specifications that calls for a specified constant modulation. In this case, the output power should be relatively constant. For many measurements, this may not be the case, and the Power Measurement results will vary as the signal varies.

Average power is the square root of the sum of the squares of the voltage samples over the measurement time.

The defined “channel” width for the Power Measurement defines the bandwidth and shape of the filter used to remove any RF power on frequencies outside of the channel bandwidth.

Channel Power

The total RF power in the selected frequency band. The detection type used for measuring channel power is Average. This means that the average of the linear (pre-log) samples is used to determine the channel power. To measure channel power, use the ACLR measurement, and set the number of adjacent channels to zero. This results in only the channel power being measured.

Average Channel Power

The total RF power in the selected channel (located in the ACPR display).

Adjacent Channel Leakage Power Ratio

Adjacent Channel Leakage power Ratio (ACLR) is the ratio of the mean power centered on the assigned channel frequency to the mean power centered on an adjacent channel frequency. In the 3GPP specification, both the main channel and adjacent channels are required to be filtered with RRC (Root Raised Cosine) filters.

Adjacent Channel Power

Measure of the signal power leaking into nearby channels.

Channel Power and ACPR Settings

Main menu bar: Setup > Settings

Favorites toolbar: 

The settings for the Channel Power and ACPR display are shown in the following table.

Freq & RBW | Measurement Params | Channels | Scale | Prefs
 Meas Freq: 1.50000 GHz RBW: 30.000 kHz Auto
 Step: 2.0000 MHz Auto VBW:

Settings tab	Description
Freq & RBW (see page 116)	Specify the frequency and resolution bandwidth used for the ACPR measurement.
Measurement Params (see page 117)	Specify several parameters that control the measurement, such as channel filter, chip rate, averaging, and correcting for noise floor.
Channels (ACPR) (see page 101)	This tab specifies the BW and offset parameters of the Channels for the selected ACPR measurement.
Scale (see page 177)	Specifies the vertical and horizontal scale settings.
Prefs (see page 110)	Specifies whether certain display elements are visible.

Restore defaults. Sets parameters for a 1-channel WCDMA measurement.

Channels Tab for ACPR

The Channels tab is where you specify parameters for the channels measured in the ACPR display.

Freq & RBW | Measurement Params | Channels | Scale | Prefs
 Number of adjacent pairs: 1
 Channel Bandwidth: 1.000 MHz
 Channel Spacing: 2.000 MHz

Setting	Description
Number of adjacent pairs	Specifies the number of adjacent channel pairs. Range: 1 - 50; Resolution 1.
Channel Bandwidth	Specifies the frequency width of each channel (all channels share the same value).
Channel Spacing	Specifies the difference in frequency between the centers of each channel.

The following figure illustrates the settings controlled from the Channels tab.

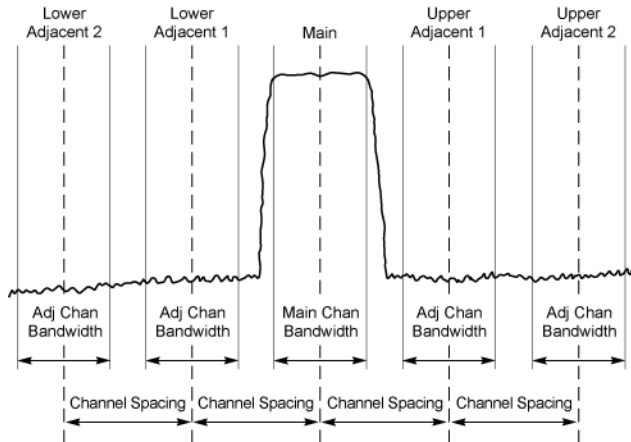

Changing the Number of Adjacent Pairs

1. Select **Number of adjacent pairs** number entry box.
2. Enter a value for the number of adjacent pairs using the knob or the keypad.

NOTE. As you change the value for the number of adjacent pairs, the analyzer will update the spectrum display to identify the adjacent channels.

3. Select the Close box when you have finished making changes.

Changing the Channel Bandwidth

1. Select the **Channel Bandwidth** number entry box.
2. Enter a value for the number of adjacent pairs using the knob or the keypad.

NOTE. As you change the value for the number of adjacent pairs, the analyzer will update the display to indicate the channel bandwidth.

3. Select the Close box when you have finished making changes.

Channel Spacing

1. Select **Channel Spacing** number entry box.
2. Enter a value for the difference in center frequency between channels using the knob or the keypad.

NOTE. As you change the value for the number of adjacent pairs, the analyzer will update the display to indicate the channel bandwidth.

3. Select **Close** when you have finished making changes.

Signal Strength Display

Use the **Signal Strength** display to measure signal strength (channel power and peak channel power).

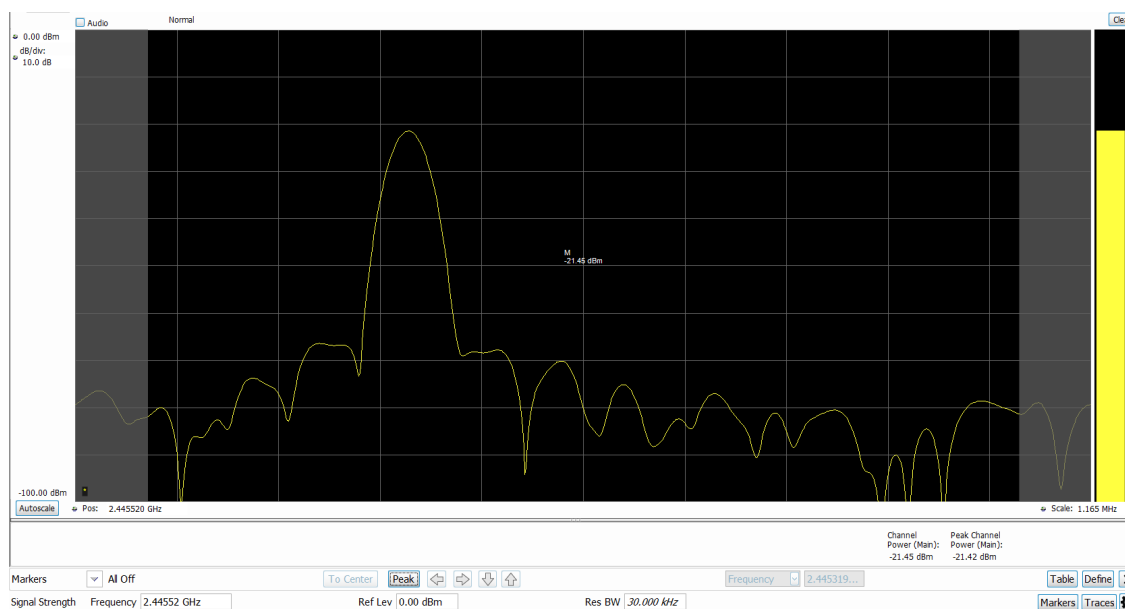

Measuring channel power and field strength

1. Select the **Displays** button.
2. Select **RF Measurements** from the **Measurements** box.
3. Double-click **Signal Strength** in the Available displays box. Click **OK** to complete your selection.
4. Tune the analyzer to the channel. To do this, you can enter the frequency directly into the Frequency field on the Basic Toolbar (see the bottom of the above image), or you can use the **Select Channel** button on the Channel Navigation toolbar.
5. Press the **Run** button to take the measurements. If you are using a data acquisition file, click **Replay**.
6. If you are measuring a signal with a directional antenna, select the **Audio** check box located above the graph, on the left side.

When Audio is checked, the analyzer sounds a tone that varies in frequency with the channel power. If you change the direction of the antenna and the channel power drops, the frequency of the audio tone will also drop. If the channel power increases, the audio tone frequency will also increase.

As channel power changes, the vertical channel power bar graph located on the far right side of the measurement display will rise and fall with the channel power.

Viewing Results

Measurement results are displayed below the graph and within the graph itself (the latter of which can be enabled/disabled in the Signal Strength Settings > Prefs tab).

Channel Power (Main):	Peak Channel Power (Main):
-10.00 dBm	14.09 dBm

Results for Signal Strength measurement

Heading	Description
Channel Power (Main)	The integrated power measured for the Main channel.
Peak Channel Power (Main)	The maximum integrated power measured for the Main channel.

[Signal Strength Settings \(see page 104\)](#)

Signal Strength Settings

Menu Bar: Setup > Settings

Basic Control Toolbar: 

The settings for the Signal Strength display are shown in the following table.

Freq & RBW	Measurement Params	Channels	Scale	Prefs
Meas Freq: 1.50000 GHz	RBW: 30.000 kHz	<input checked="" type="checkbox"/> Auto		
Step: 2.0000 MHz	<input checked="" type="checkbox"/> Auto	<input type="checkbox"/> VBW:		

Settings tab	Description
Freq & RBW (see page 106)	Specify the frequency and resolution bandwidth used for the signal strength measurements.
Measurement Params (see page 106)	Specify several parameters that control the measurement, averaging. External amplitude corrections, and display units.
Channels (see page 108)	This tab specifies the BW
Scale (see page 109)	Specifies the vertical and horizontal scale settings.
Prefs (see page 110)	Specifies trace points, trace detection, and visible display elements (graticule, marker readouts, etc) for the Signal Strength measurement display.

Freq & RBW Tab for Signal Strength display

The Freq & RBW tab specifies frequency parameters for the signal strength measurements.

The screenshot shows the 'Freq & RBW' tab with the following settings:

- Meas Freq: 1.00000 GHz
- Step: 2.0000 MHz
- RBW: 30.000 kHz
- VBW: VBW
- Auto checkboxes: Auto (for RBW), Auto (for Step)

Setting	Description
Meas Freq	Specifies the center/measurement frequency.
Step	The Step control sets the increment/decrement size for the adjustment of the center frequency. If Auto is enabled, the analyzer will adjust the Step size as required.
RBW	Select Auto or Manual. Adjusts the RBW for the entire measurement. This setting is Independent of the Spectrum view's RBW setting.
VBW	Adjusts the VBW (Video Bandwidth) value. VBW Maximum = 10 times the current RBW value. VBW Minimum = 1/10,000 RBW setting.

NOTE. While the center frequency and step settings on this control tab are shared between ACPR, MCPR and Occupied Bandwidth, the RBW setting is not shared. The RBW setting is unique for each measurement.

VBW

The VBW setting enables/disables the Video Bandwidth filter. VBW is used in traditional swept analyzers to reduce the effect of noise on the displayed signal. The VBW algorithm in the analyzer emulates the VBW filters of traditional swept analyzers.

The maximum VBW value is 10 times the current RBW setting. The minimum VBW value is 1/10,000 of the RBW setting.

NOTE. If you are following a procedure that says to "set VBW to three times the RBW value or greater", it means that the test should be conducted with no VBW effects. In the application, this condition is met by disabling the VBW function.

Measurement Params Tab for Signal Strength display

The Measurement Params tab is where you set parameters that control the Signal Strength measurement.

Parameter	Description
Average	Enables/disables measurement averaging. Averaging can be enabled in either the Frequency Domain or Time Domain.
Frequency domain	This setting takes the average linear value of the traces (so that rms values are preserved). The number of averages is user-defined. Frequency domain averaging is available in spans larger (or smaller) than the maximum real time bandwidth. This is the mode to use unless you need to extract maximum dynamic range from an ACPR measurement.
Time domain	This setting takes the average linear value of the traces. It is useful if you need to extract maximum dynamic range from an ACPR measurement. The number of traces is user defined. But, the signals must be triggered and repeating. That is, the signal needs to be exactly the same for each acquisition. When this condition is met, each waveform contains the same signal, but the random noise changes from acquisition to acquisition and the average value of the random noise is lowered, while the signal value remains constant. Time domain averaging is not available in spans wider than the maximum real-time bandwidth.
Off	This setting turns averaging off.
Number	Specifies the number of acquisitions to be averaged when Averaging is set to Frequency Domain. Specifies the number of successive capture records that are averaged when Averaging is set to Time Domain.
Amplitude Units	Opens the Amplitude Units (see page 530) dialog box.
Ext Corrections	Opens the External Gain/Loss Correction (see page 537) dialog box.

Correct for Noise Floor

When this setting is enabled, the instrument applies a correction to the ACPR or MCPR measurement to reduce the effect of instrument noise on the results. It generates this correction by taking a preliminary acquisition to measure the instrument noise floor. Once this is done, the measurement proceeds, applying the correction to each result. When any relevant settings (reference level, attenuator, frequency, or span) are changed, the instrument performs a new noise measurement and correction.

The noise correction signal is created by switching off the input to the RTSA and performing acquisitions of the instrument internal noise. A minimum of 100 acquisitions are averaged to create the noise reference signal. It is possible to increase the number of acquisitions for creation of the noise reference signal. When frequency domain averaging is enabled and the number of averages exceeds 100, the number of frequency domain averages becomes the total number of acquisitions to determine the instrument internal noise. Noise is measured for each channel defined by the measurement. The noise reference from each channel is subtracted from the incoming signal power for each channel to create the corrected result. All calculations are performed in Watts, and then converted to the desired units.

The amount of noise correction is limited to 12 dB to avoid the possibility of a negative power measurement. This is a rare condition that could occur if the subtraction of the reference power from the channel power results in a negative value (or 'infinite' dBm).

The measured values differ from the displayed trace in two ways. First, any filtering applied to the channels is not displayed on the trace. Second, the single value of measured noise for a channel is subtracted from each trace point in the channel, rather than offsetting the entire channel by a single amount. This produces a smooth trace with no discontinuities at the channel edges.

Channels Tab for Signal Strength display

The Channels tab is where you specify the channel bandwidth measured in the Signal Strength display.

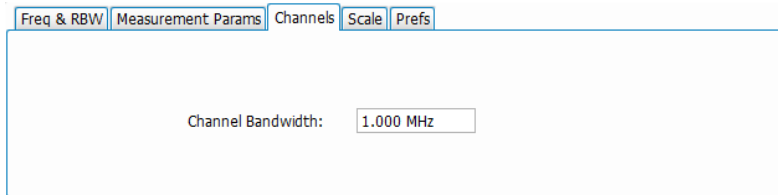

Changing the Channel Bandwidth

1. Select the **Channel Bandwidth** number entry box.
2. Enter a value for the channel bandwidth.
3. Select the Close box when you have finished making changes.

Scale Tab for Signal Strength display

The Scale tab allows you to change the vertical and horizontal scale settings. Changing the scale settings changes how the trace appears on the display but does not change control settings such as Center Frequency.

Setting	Description
Vertical	Controls the vertical position and scale of the trace display.
Scale	Changes the vertical scale units. This is only accessible when the vertical units are set to dBm.
Autoscale	Automatically scales the vertical axis to contain the complete trace.
Horizontal	Controls the span of the trace display and position of the trace.
Scale	Allows you to, in effect, change the span.
Autoscale	Automatically scales the horizontal axis to optimize the display of the trace.
Reset scale	Resets all settings to their default values.

Prefs Tab

The Prefs tab enables you to change parameters of the measurement display. The parameters include enabling/disabling Marker Readout, switching the Graticule display on/off, and trace points and detection.

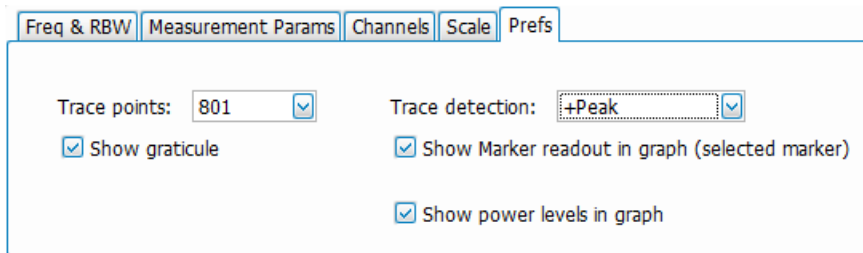

Setting	Description
Trace Points	Sets the number of trace points computed for each line. These are the points used for marker measurements and for results export.
Show graticule	Shows or hides the graticule.
Trace Detection	<p>+Peak: Shows the peak power in a bin (of chosen RBW) if there are multiple points to choose from within a bin.</p> <p>Avg (VRMS): Shows the average power in a bin (of chosen RBW) if there are multiple points to choose from within a bin.</p>
Show Marker readout in graph (selected marker)	Shows or hides the readout for the selected marker in the graph area.

MCPR (Multiple Carrier Power Ratio) Display

Use the MCPR measurement to measure adjacent channel power ratio for multiple main channels or when adjacent channel pairs have different offsets and/or bandwidths. The MCPR display show the Reference Power and the ratio of each adjacent channel to the Reference Power. You can select whether the Reference Power is the total of all active channels or a single channel.

Measuring Multiple Carrier Power Ratio

1. Press the front-panel **Displays** button.
2. From the **Select Displays** window, select **RF Measurements** or **P25 Analysis** from the Measurements box.
3. Double-click the **MCPR** icon in the **Available displays** box. Click **OK** to complete your selection.
4. Press the **Settings** button. This displays the control panel for MCPR (the tab displayed will be the tab displayed the last time the Settings panel was opened).

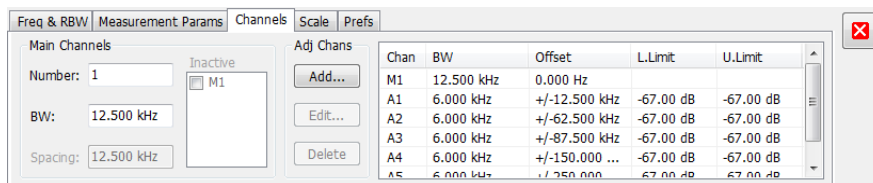

5. Select the **Freq & RBW** tab and adjust the frequency to that of the main channel. You can also adjust the frequency on the Status bar using the Frequency field on the bottom left of the display.
6. Click on the **Channels** tab. To set the number of Main channels, enter the number of Main channels in the **Number** text entry box under **Main Channels**.

NOTE. As you add channels, the span of the display will be adjusted so that all the channels can be seen.

7. To set the bandwidth of all main channels, enter a value in the **BW** value box.
8. To set the spacing between the main channels, enter a value in the **Spacing** value box.
9. To prevent a main channel power level from being included in the Power Reference (Total) calculation, select the channel to be excluded in the **Inactive** box.
10. To add adjacent channels, click the **Add** button under **Adj Chans**.

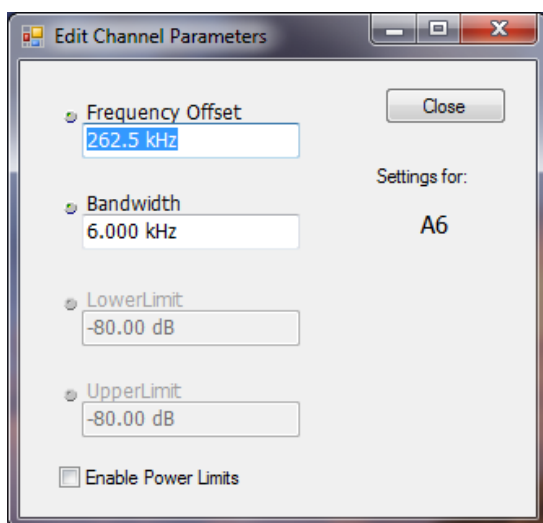

11. To edit Frequency Offset or Bandwidth, click within the value box and use the front-panel knob or your keyboard to set the value. Click **Close** to save your changes.

NOTE. Frequency Offset is the difference between the center frequency of the selected channel and the Measurement Frequency. All channels (Main or Adjacent) are specified by their offset from the Measurement Frequency.

12. To enable and define power limits, check the **Enable Power Limits** box and enter the desired Upper and Lower limits. You can read more about power limits [here \(see page 113\)](#).

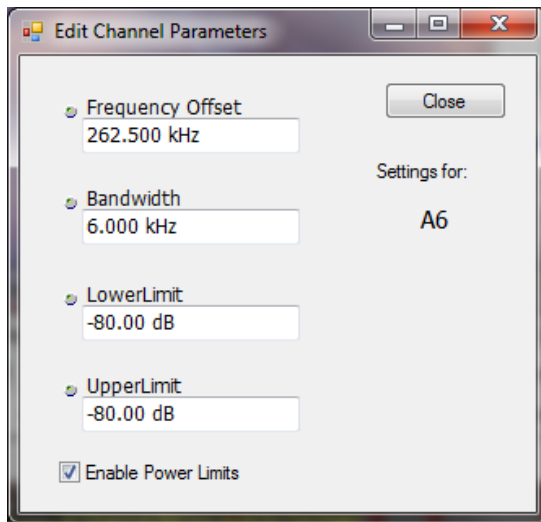

13. After you have configured the Main and Adjacent channels, click the close button in the Settings panel or the **Settings** button to remove the settings panel.
14. Click the Run button to take the measurements.

Click the Run button to take the measurements. Click the Replay button if you are using a recalled acquisition data file.

Viewing Results

MCPR measurement results are displayed both in the spectrum graph and in a table below the spectrum display. Individual Main channel power measurements appear in the graph under their channel identifiers. Individual adjacent channel power ratios also appear in the graph under the adjacent channel identifier.

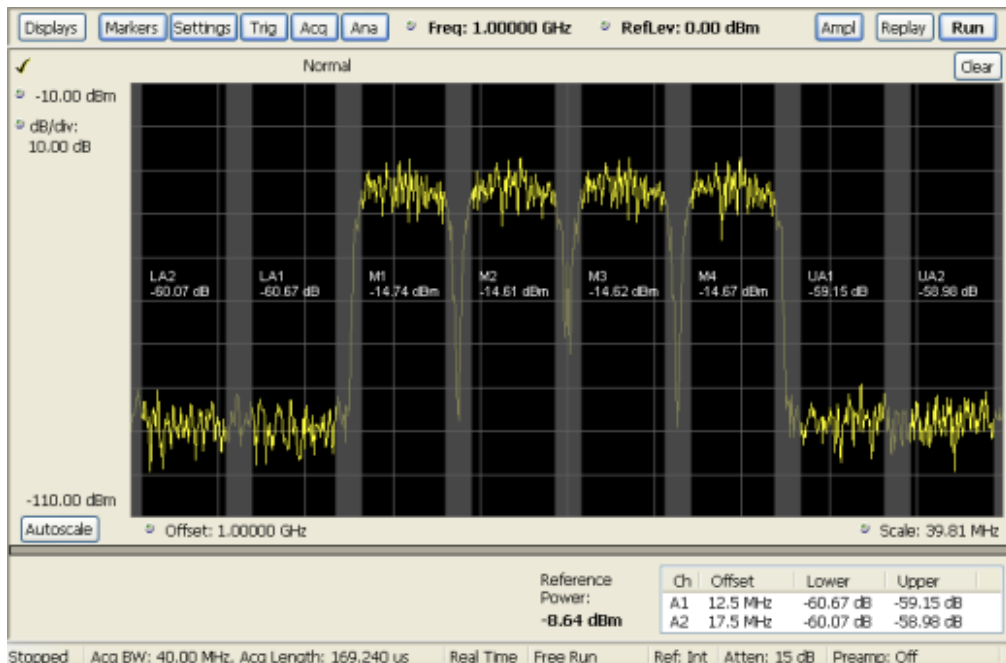

The following table details the entries in the results table.

Heading	Description
Ch	Identifies the adjacent channels. Adjacent channels are numbered according to their offset from the Main channel. The closest channel is numbered 1. The next closest channel is numbered 2; and so forth. The prefix "L" means lower; "U" means upper.
Offset	The offset is the difference in frequency between the Measurement Frequency and the center frequency of the channel.
Lower	Displays the ratio of the lower adjacent channel power to the Power Reference.
Upper	Displays the ratio of the upper adjacent channel power to the Power Reference.
L. Limit	Displays the lower power limit.
U. Limit	Displays the upper power limit.
Power Reference	Depending on the selected Power Ref, this readout displays either the power of the selected main channel or the total power in the active main channels.

Depending on the number of adjacent channels, to see all the measurements, you might need to drag the divider bar between the main display and the results table at the bottom of the window to change the height of the results table.

[Setting MCPR Measurement Parameters \(see page 117\)](#)

Setting Power Limits

When power limits are enabled (**Settings > Channels > Add** or **Settings > Channels > Edit**), the comparison of the actual results of an adjacent channel is done against the limits. If there is a failure, the Lower and Upper power cells in the MCPR table will be red and the failure segments of the trace display

will be red. The words **Fail** in red will also appear in the top left corner of the display (even if one adjacent band fails). See the following image for an example.

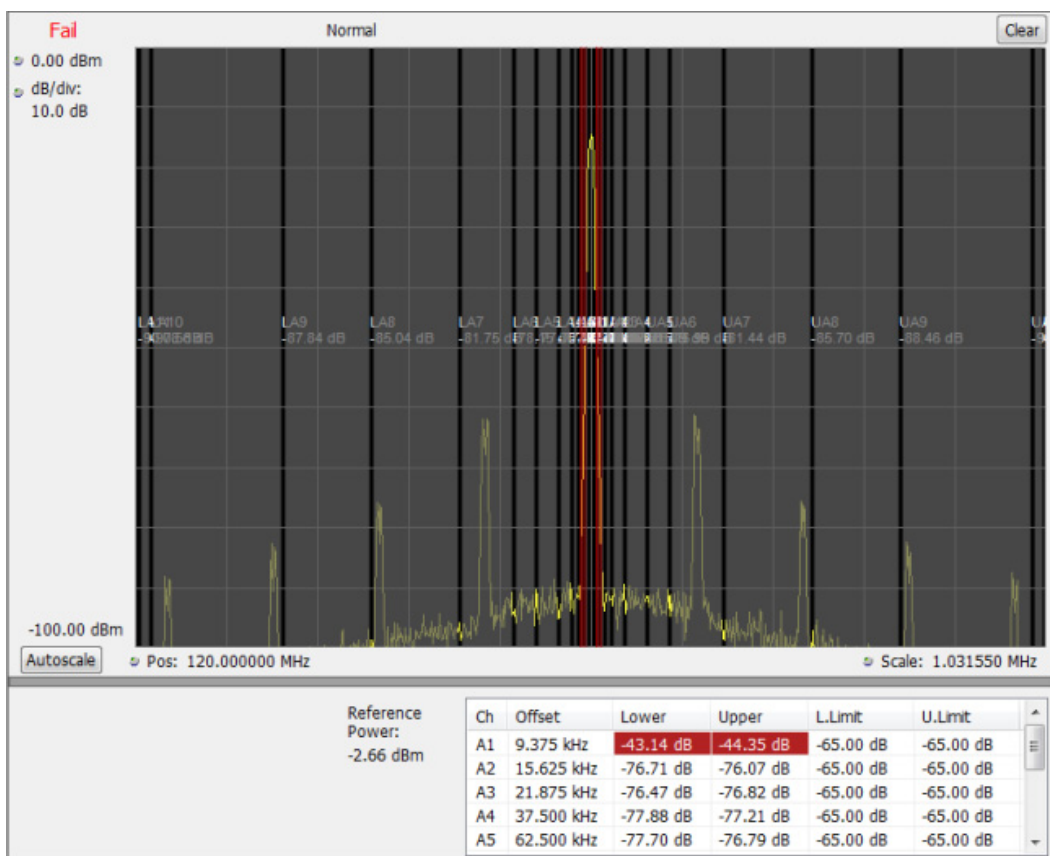

Multiple Carrier Power Ratio

The ratio of the signal power in an adjacent channel to the power in one or more main channels.

MCPR Settings

Main menu bar: Setup > Settings

Favorites toolbar: 

The Setup control panel tabs for MCPR (Multiple Carrier Power Ratio) are:

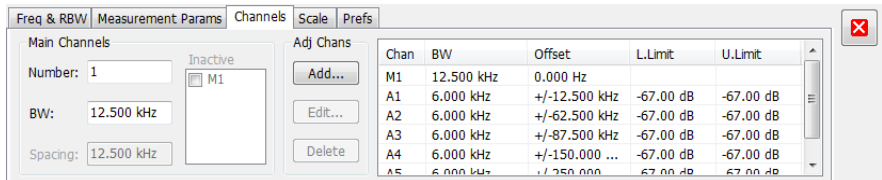

Settings tab	Description
Freq & RBW (see page 116)	Specify the frequency and resolution bandwidth used for the MCPR measurements.
Measurement Params (see page 117)	Specifies parameters controlling how the MCPR measurement is made.
Channels (see page 119)	Specifies the parameters of the channels to be measured.
Scale (see page 177)	Specifies the vertical and horizontal scale and offset values.
Prefs (see page 110)	Specifies whether or not certain display elements are shown.

Restore defaults. Sets parameters for a 4-carrier WCDMA measurement.

Freq & RBW Tab for ACPR and MCPR Displays

The Freq & RBW tab specifies frequency parameters for the Channel Power & ACPR measurements and MCPR measurement.

The screenshot shows the 'Freq & RBW' control tab with the following settings:

- Meas Freq: 1.00000 GHz
- Step: 2.0000 MHz
- RBW: 30.000 kHz
- VBW: (disabled)

Setting	Description
Meas Freq	Specifies the center/measurement frequency.
Step	The Step control sets the increment/decrement size for the adjustment of the center frequency. If Auto is enabled, the analyzer will adjust the Step size as required.
RBW	Select Auto or Manual. Adjusts the RBW for the entire measurement. This setting is Independent of the Spectrum view's RBW setting.
VBW	Adjusts the VBW (Video Bandwidth) value. VBW Maximum = 10 times the current RBW value. VBW Minimum = 1/10,000 RBW setting.

NOTE. While the center frequency and step settings on this control tab are shared between ACPR, MCPR and Occupied Bandwidth, the RBW setting is not shared. The RBW setting is unique for each measurement.

VBW

The VBW setting enables/disables the Video Bandwidth filter. VBW is used in traditional swept analyzers to reduce the effect of noise on the displayed signal. The VBW algorithm in the analyzer emulates the VBW filters of traditional swept analyzers.

The maximum VBW value is 10 times the current RBW setting. The minimum VBW value is 1/10,000 of the RBW setting.

NOTE. If you are following a procedure that says to "set VBW to three times the RBW value or greater", it means that the test should be conducted with no VBW effects. In the SignalVu software, this condition is met by disabling the VBW function.

Measurement Params for ACPR and MCPR Displays

The Measurement Params tab is where you set parameters that control the ACPR and MCPR measurements.

Freq & RBW	Measurement Params	Channels	Scale	Prefs
Requires triggered synchronous signal				
Average:	Time Domain	Number: 10	Channel Filter:	Root-raised Cosine
<input type="checkbox"/> Correct for Noise Floor				
Power Reference:	Total (active channels)	Filter Parameter:	0.22	
		Symbol/Chip Rate:	3.84 MHz	

Freq & RBW	Measurement Params	Channels	Scale	Prefs
Average:	Frequency Domain	Number: 10	Channel Filter:	Root-raised Cosine
<input type="checkbox"/> Correct for Noise Floor				
Power Reference:	Total (active channels)	Filter Parameter:	0.22	
		Symbol/Chip Rate:	3.84 MHz	

Parameter	Description
Average	Enables/disables measurement averaging. Averaging can be enabled in either the Frequency Domain or Time Domain.
Frequency-domain	This setting takes the average linear value of the traces (so that rms values are preserved). The number of averages is user-defined. Frequency domain averaging is available in spans larger (or smaller) than the maximum real time bandwidth. This is the mode to use unless you need to extract maximum dynamic range from an ACPR measurement.
Time-domain	This setting takes the average linear value of the traces. It is useful if you need to extract maximum dynamic range from an ACPR measurement. The number of traces is user defined. But, the signals must be triggered and repeating. That is, the signal needs to be exactly the same for each acquisition. When this condition is met, each waveform contains the same signal, but the random noise changes from acquisition to acquisition and the average value of the random noise is lowered, while the signal value remains constant. Time domain averaging is not available in spans wider than the maximum real-time bandwidth.
Number	Specifies the number of acquisitions to be averaged when Averaging is set to Frequency Domain. Specifies the number of successive capture records that are averaged when Averaging is set to Time Domain.
Correct for Noise Floor	Enables/disables the Noise Floor Correction function.
Power Reference	Specifies power against which the results are compared. Choices available are each of the existing main channels and "Total (active channels)". Only present when MCPR is the selected display.
Channel Filter	Specify the channel filter used. Select between None (default) and Root-raised Cosine.
Filter Parameter	Value entry box for the Root-raised Cosine filter Adjacent Channel Filter. Present only when the Channel Filter is set to Root-raised Cosine.
Symbol/Chip Rate	Value entry box for the Root-raised Cosine chip rate. Present only when the Channel Filter is set to Root-raised Cosine.

Correct for Noise Floor

When this setting is enabled, the instrument applies a correction to the ACPR or MCPR measurement to reduce the effect of instrument noise on the results. It generates this correction by taking a preliminary acquisition to measure the instrument noise floor. Once this is done, the measurement proceeds, applying the correction to each result. When any relevant settings (reference level, attenuator, frequency, or span) are changed, the instrument performs a new noise measurement and correction.

The noise correction signal is created by switching off the input to the RTSA and performing acquisitions of the instrument internal noise. A minimum of 100 acquisitions are averaged to create the noise reference signal. It is possible to increase the number of acquisitions for creation of the noise reference signal. When frequency domain averaging is enabled and the number of averages exceeds 100, the number of frequency domain averages becomes the total number of acquisitions to determine the instrument internal noise. Noise is measured for each channel defined by the measurement. The noise reference from each channel is subtracted from the incoming signal power for each channel to create the corrected result. All calculations are performed in Watts, and then converted to the desired units.

The amount of noise correction is limited to 12 dB to avoid the possibility of a negative power measurement. This is a rare condition that could occur if the subtraction of the reference power from the channel power results in a negative value (or 'infinite' dBm).

The measured values differ from the displayed trace in two ways. First, any filtering applied to the channels is not displayed on the trace. Second, the single value of measured noise for a channel is subtracted from each trace point in the channel, rather than offsetting the entire channel by a single amount. This produces a smooth trace with no discontinuities at the channel edges.

Channels Tab for MCPR

Main menu bar: Setup > Settings > Channels

Favorites toolbar: 

The Channels tab is where you specify the parameters for the channels measured in the MCPR display.

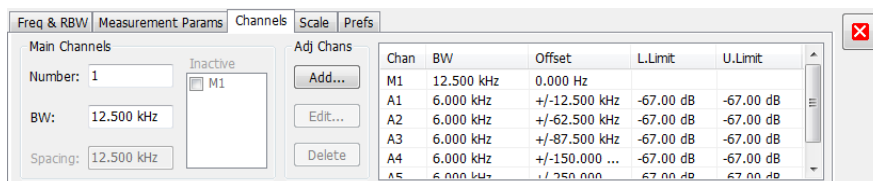

Setting	Description
Main Channels	
Number	Sets the number of Main channels.
BW	Sets the bandwidth of the Main channels.
Spacing	Sets the frequency difference between the centers of the Main channels.
Inactive	Selected channels are ignored by the measurement routine.
Adj Chans	
Add	Opens the Edit Channel Parameters dialog, which you use to specify the parameters of a new pair of adjacent channels. You can add up to 50 adjacent channel pairs.
Edit	Opens the Edit Channel Parameters dialog box. (You must first select a channel to enable the Edit button.)
Delete	Deletes the selected main channel or adjacent channel pair.
Channel Definition table	A table of the parameters for every channel. Offset is the frequency difference between the Center Frequency and center of the selected channel. Nothing in the table is editable directly. You can set the upper and lower limits by clicking on the Add button.

The following figure illustrates the settings controlled from the Channels tab.

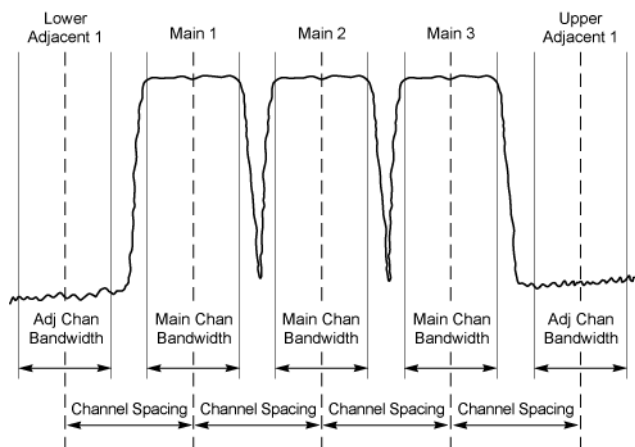

Editing Channel Parameters

To edit the offset or bandwidth of a Main channel:

1. Select the value in the **BW** or **Spacing** number entry boxes.
2. Adjust the value as required. All the Main channels share the same BW and Spacing.
3. Select the appropriate check box to make a channel Inactive, as appropriate.
4. Click the Close button when you have finished making changes.

To edit the offset or bandwidth of an Adjacent channel:

1. Select the channel to be edited in the channel definition table.
2. Select **Edit**. This displays the **Edit Channel Parameters** dialog box.
3. Adjust the values for the **Frequency Offset**, **Bandwidth**, and upper and lower **Limits**, as required.
4. Click the Close button when you have finished making changes.

Adding Channels

To add a main channel:

1. Select the **Number** entry box.
2. Use the knob to enter a value for the desired number of Main channels.
3. Click the Close button when you have finished making changes.

To add an adjacent channel pair:

1. Select **Add**. This displays the **Edit Channel Parameters** dialog box.
2. Use the knob to enter values for the **Frequency Offset**, **Bandwidth**, and upper and lower **Limits**, as required. The Frequency Offset is measured from the Meas Frequency of the Main channels.
3. Click the Close button when you have finished making changes.

Deleting Channels

To delete a main channel:

1. Select the **Number** entry box.
2. Use the knob to reduce the number of channels or enter a new value using the front-panel keypad.
3. Click the Close button when you have finished making changes.

To delete an adjacent channel:

1. Select the channel to be deleted in the channel definition table.
2. Select **Delete**. This removes the selected channel from the channel table.
3. Click the Close button when you have finished making changes.

Occupied BW & x dB BW Display

The Occupied BW display shows the bandwidth within which 99% (a user-defined value, the default is 99%) of the power transmitted within the measurement bandwidth falls.

To show the Occupied BW display:

1. Press the **Displays** button or select **Setup > Displays**.
2. In the **Select Displays** dialog, select **RF Measurements** in the **Measurements** box.
3. In the **Available displays** box, double-click the **Occupied Bandwidth** icon or select the icon and click **Add**. The Occupied Bandwidth icon will appear in the **Selected displays** box and will no longer appear under Available displays.
4. Click **OK** to display the Occupied Bandwidth.

Elements of the Display

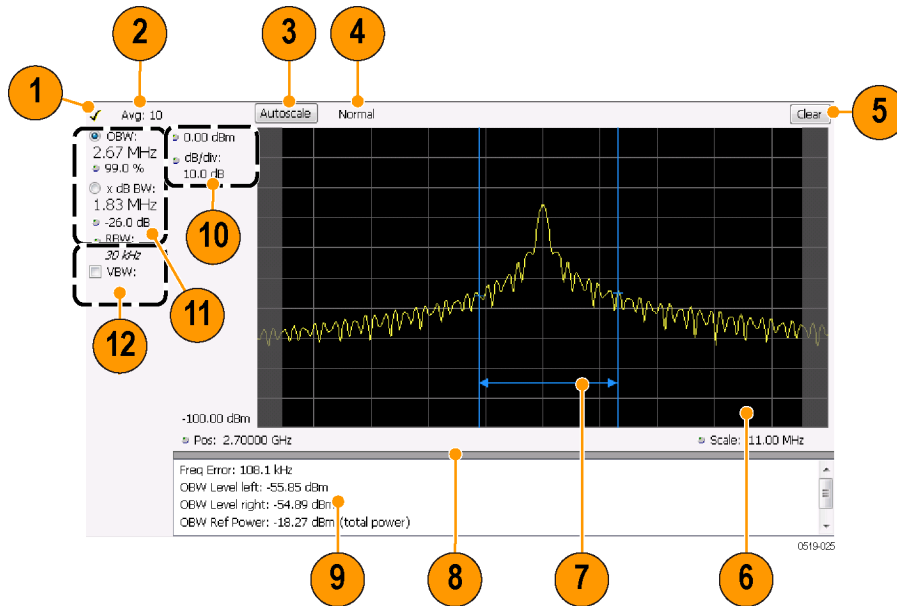

Item	Display element	Description
1	Check mark indicator	The check mark indicator denotes the display for which the acquisition hardware is optimized. This indicator appears only when the display is the selected display. NOTE. When Best for multiple windows is selected in the Amplitude control panel's RF & IF Optimization control, none of the measurement displays shows a checkmark, as there is not a single optimized measurement.
2	Averaging readout	Appears when averaging is enabled (Settings > Parameters tab > Average results). Displays "Avg: n of m" while averaging the results and "Avg: m" once the requested number of results have been averaged.
3	Autoscale	Adjusts the vertical and horizontal settings so that the entire trace fits in the graph.
4	Trace function readout	Displays either Normal or MaxHold to indicate trace function.
5	Clear	Resets count for Average and MaxHold functions. Enabled only when Averaging or MaxHold is enabled. Pressing Clear will clear the trace and, if acquisition is running, restart the averaging or hold process.
6	Graph	Displays the input signal. Shaded areas indicate the measurement bandwidth (Settings > Parameters tab > Measurement BW).
7	Blue lines	The blue lines indicate where the selected results (selected in the Main results area) are being measured on the trace.
8	Grid divider	Determines the portion of the display allocated to the graph and detailed results area. You can move the grid divider all the way to the top or bottom and any position in between.
9	Detailed results area	Displays additional measurements results.
10	Position and dB/div Units (not shown)	Position sets the top of graph value. The dB/div setting is the vertical scale value. Sets the global amplitude units for all the views in the analysis window. This will change the amplitude selection in the Units tab of the Amplitude control panel.
11	Main results area	Displays results for Occupied Bandwidth (OBW) and x dB bandwidth. Use the two radio buttons to select which of the two results are illustrated in the graph with the blue lines and arrows. There are also controls for adjusting OBW % Power, x dB BW, and RBW.
12	VBW	Enables the VBW (Video Bandwidth) filter. Displays current VBW filter setting. See Setup > Settings > Freq & RBW tab (see page 116) .

Detailed Results Readouts

Measurement	Description
Freq Error	The frequency difference between the measured carrier frequency of the signal and the user-selected center frequency of the analyzer.
OBW Level left	The signal level at the left edge of the occupied bandwidth.
OBW Level right	The signal level at the right edge of the occupied bandwidth.
OBW Ref Power	The total power measured within the measurement bandwidth.
x dB BW Ref Power	The peak power measured within the measurement bandwidth.

[Changing the Occupied Bandwidth Settings \(see page 124\)](#)

Occupied Bandwidth

Bandwidth within which some defined percentage of the power transmitted on a single channel lies.

Occupied BW & x dB BW Settings

Main menu bar: Setup > Settings

Favorites toolbar: 

The control panel tabs for the Occupied Bandwidth display are shown in the following table.

Settings tab	Description
Freq & RBW (see page 173)	Allows you to specify the Center Frequency, Step size and RBW.
Parameters (see page 125)	Allows you to specify the Occupied BW % Power, x dB level, Measurement BW, enable averaging and the Max Hold function.
Scale (see page 177)	Allows you to set the vertical and horizontal scale parameters.
Prefs (see page 110)	The Prefs tab enables you to set characteristics of the measurement display.

Parameters Tab

The Parameters tab enables you to specify parameters that control the Occupied BW measurement.

The screenshot shows the 'Parameters' tab of the software interface. It contains several input fields and checkboxes:

- Occupied BW % Power: 99.0 %
- x dB level: -26.0 dB
- Measurement BW: 10.00 MHz
- Max Hold spectral data:
- Average results:
- Count: 10

Setting	Description
Occupied BW % Power	Specifies the proportion of power within the occupied bandwidth (referenced against the total power in the measurement bandwidth).
x dB level	x dB level defines the x dB BW level search threshold.
Measurement BW	Specifies the frequency range used by the measurement.
Max Hold spectral data	Enables the Max Hold function.
Average results	Enables/disables results averaging. Note that this is not an averaging of the trace, but an averaging of the results.
Count	Specifies the number of results averaged to calculate the Occupied BW. Range: 2 to 10,000.

x dB Level

The x dB level determines the x dB BW. The instrument analyzes the spectrum trace to locate the frequencies at which the level is x dB down from the peak level calculated over the measurement bandwidth. The frequency difference between the upper and lower crossing thresholds is the x dB BW.

Range: -80.0 to -1.0 dB; Resolution: 0.1%; Inc/dec small: 0.1%, large: 1%; Default: -26 dB

Max Hold Spectral Data

Max Hold displays the maximum value in the acquisition record for each display point. Each new trace display point is compared to the previous maximum value and the greater value is retained for display and subsequent comparisons.

Spurious display

To show the Spurious display:

1. Click the **Displays** button or select **Setup > Displays**.
2. From the Measurements box, select **RF Measurements**.

3. Double-click the **Spurious** icon in the **Available displays** box. This adds the Spurious icon to the **Selected displays** box (and removes it from the Available displays box). Alternatively, you can click the Spurious icon and then click the Add button to select Spurious for display.
4. Click the **OK** button.



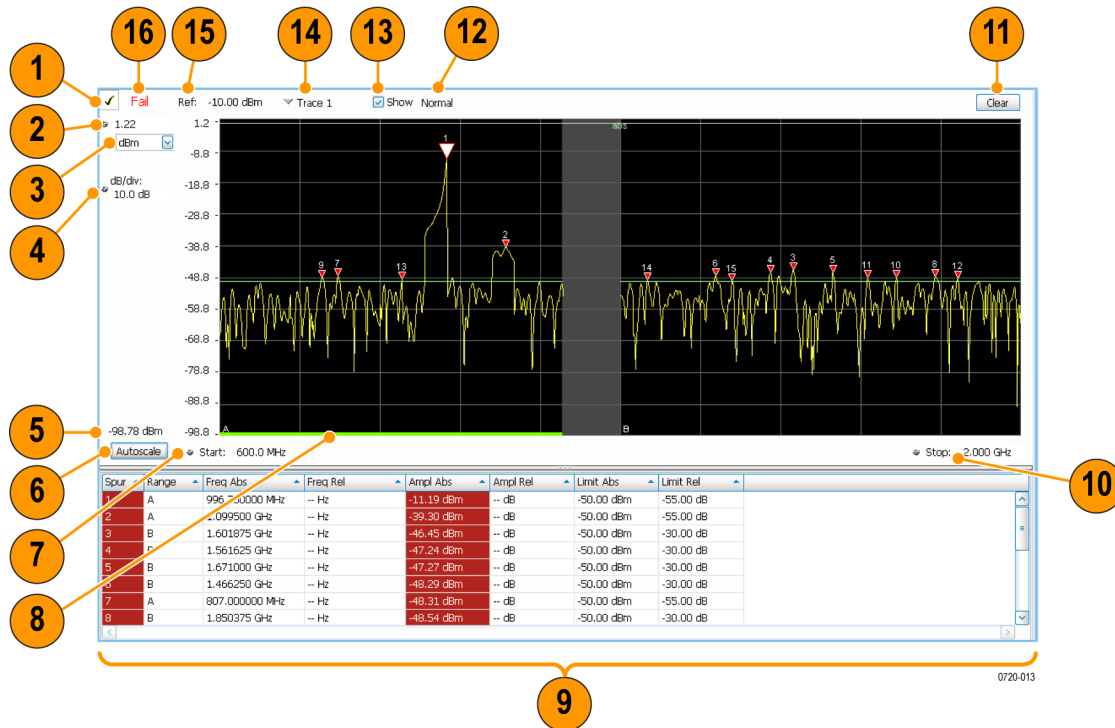



Elements of the Spurious Display

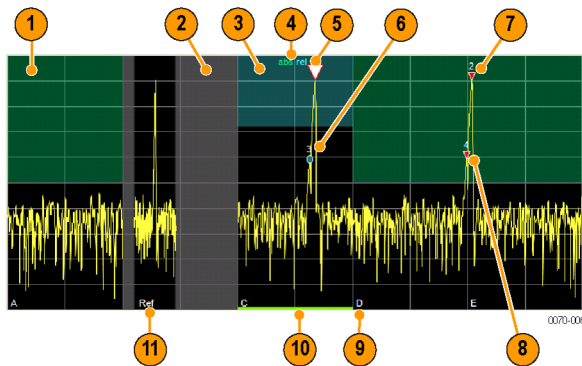

Item	Display element	Description
1	Check mark indicator	Indicates the display for which the acquisition hardware is optimized. NOTE. When Best for multiple windows is selected in the Amplitude control panel's RF & IF Optimization control, none of the measurement displays shows a checkmark, as there is not a single optimized measurement.
2	Vert Position	Sets the top of graph value. This is only a visual control for panning the graph. The Reference Level is adjusted in the Toolbar and the Ampl control panel. By default, Vert Position = Ref Level.
3	Units	Sets the global Amplitude units for all the views in the analysis window. This will change the Amplitude selection in the Units tab of Analysis Control panel.
4	dB/ div	Sets the vertical scale value. The maximum value is 20.00 dB/division.
5	Bottom-of-graph readout	Indicates the amplitude at the bottom of the graph. This value changes with the dB/div and Vertical Position settings.
6	Autoscale	Adjusts the Vertical and Horizontal scaling to display the entire trace on screen. Selects Multi-range display mode.
7	Start	Adjusts the graph start frequency. This setting affects only visual scaling, not measurement parameters.
8	Green bar	Indicates the range that is selected on the Settings > Ranges and Settings > Limits tabs.
9	Spur table	Displays spur measurements. See the following table for details.
10	Stop	Adjusts the graph stop frequency. This setting affects only visual scaling, not measurement parameters.
11	Clear	Restarts multi-trace functions (Average, Max Hold).
12	Trace function	Indicates the trace processing method. If Average or Max Hold is selected, this readout displays the number of traces being processed (averaged or compared for the Max Hold value).
13	Show	Controls whether the selected trace is visible or not. When trace is Off, the box is not checked.
14	Trace	Selects a trace. Clicking here pops up a context menu listing the available traces, whether they are enabled or not. If you select a trace that is not currently enabled, it will be made enabled.
15	Ref:	If enabled, displays the power reference level.
16	Pass / Fail readout	Indicates whether one or more spurs have exceeded a limit specified on the Settings > Limits tab.

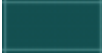
Elements of the Spurious Graph Display



Item	Display element	Description
1		The green line or shading indicates an Abs (absolute) limit. The absolute limit is enabled when the mask is set to Abs, Abs & Rel, or Abs OR Rel. Note that absolute and relative amplitude masks can overlap.
2		The gray-shaded area indicates a portion of the spectrum where no measurements are being taken.
3		The cyan line or shading indicates a Relative limit. The relative limit is enabled when the mask is set to Rel, Abs & Rel, or Abs OR Rel. Note that absolute and relative amplitude masks can overlap.
4	abs rel	Reminder that green-shaded areas highlight absolute limits and cyan-shaded areas highlight relative limits.
5		This indicates the selected spur, when it is in violation of the limits. In Run mode, this is the peak spur violation. The selected marker is highlighted in the Spur table below the graph with a blue background.
6		A spur marker. Indicates a spur that does not exceed the mask settings. See the Settings > Ranges and Limits tab (see page 133) .
7		A violation marker. Indicates a spur that exceeds the mask settings. See the Settings > Ranges and Limits tab (see page 133) .
--		Indicates the selected spur when it is not in violation of the limits. The selected marker is highlighted in the Spur table below the graph with a blue background.
8	1, 2, 3...	A Spur number. The number indicates the row in the spur table that corresponds to the spur. The instrument can display up to 999 spurs.
9	A, B, C, D...	Identifies the enabled ranges.
10	Green bar	Indicates the range selected on the Settings > Ranges and Limits (see page 133) tab.
11	Ref	Indicates the location of the power reference. See Settings > Reference (see page 131) .

Elements of the Spur Table

Spur	Range	Freq Abs	Freq Rel	Ampl Abs	Ampl Rel	Limit Abs	Limit Rel
1	B	1.751145 GHz	– Hz	-5.91 dBm	4.09 dB	-15.00 dBm	-15.00 dB
2	E	2.053875 GHz	– Hz	-8.99 dBm	1.01 dB	-15.00 dBm	-10.00 dB
3	D	1.903950 GHz	– Hz	-10.48 dBm	-0.48 dB	-50.00 dBm	-57.00 dB
4	A	1.748826 GHz	– Hz	-39.57 dBm	-29.57 dB	-57.00 dBm	-30.00 dB
5	D	1.899062 GHz	– Hz	-40.31 dBm	-30.31 dB	-50.00 dBm	-57.00 dB

Column	Description
Spur	A number that identifies a spur in the graph area. The instrument can display a maximum of 999 spurs.
Range	The letter representing the frequency range where the spur is located.
Freq Abs	The absolute frequency at which the spur occurs.
Freq Rel	The relative frequency at which the spur occurs. The relative frequency is the difference between the absolute frequency (absolute) and the carrier frequency.
Ampl Abs	The absolute amplitude of the spur.
Ampl Rel	The relative amplitude at which the spur occurs. The relative amplitude is the difference between the absolute amplitude and the carrier amplitude. See the Settings > Limits tab .
Lim Abs	The value of the absolute amplitude limit at the spur frequency. This value can vary even with small spur frequency changes if the start and stop limit values are different. See the Settings > Ranges and Limits tab (see page 133) .
Lim Rel	The relative amplitude limit at which the spur occurs. This value can vary even with small spur frequency changes if the start and stop relative amplitude limit values are different. See the Settings > Ranges and Limits tab (see page 133) .
Blue background	The cell in the Spur column with a blue background identifies the selected spur.
Red background	Cells in the Spur column with a red background identify violations. Cells in the results area with a red background identify the measurement that exceeded a limit.

Rearranging the Columns in the Spur Table

You can rearrange the order of the columns in the Spur Table. To move a column, click on the column heading and drag it to the desired position.

Sorting the Rows in the Spur Table

You can sort the rows in the Spur table by clicking on the column heading. For example, if you click on the Freq Abs heading, the results in the Spur table will be sorted by frequency. If you click on Range, the rows will be sorted by range. Clicking a second time on the same heading reverses the order.

[Changing the Spurious Display Settings \(see page 130\)](#)

Spurious display settings

Main menu bar: Setup > Settings

Favorites toolbar: 

The control panel tabs for the Spurious display are shown in the following table.

Settings tab	Description
Parameters (see page 131)	Specifies whether the graph displays one range or multiple ranges. Specifies whether all spurs are shown or only spurs over specified limits.
Reference (see page 131)	Specifies the Power Reference level.
Ranges (see page 133)	Specifies start and stop frequencies of ranges and which ranges to take measurements in. Sets parameters that define a spur. Review, save and load the Range table from this tab.
Limits (see page 133)	Specifies Pass/Fail limit parameters.
Traces (see page 174)	Specifies the trace Function.
Scale (see page 177)	Specifies the vertical and horizontal scale settings.
Prefs (see page 110)	Specifies the appearance features of the graph area.

Restore defaults. Sets the Spurious parameters to their default values.

Parameters Tab

The Parameters tab enables you to specify settings that control the Spurious measurement.

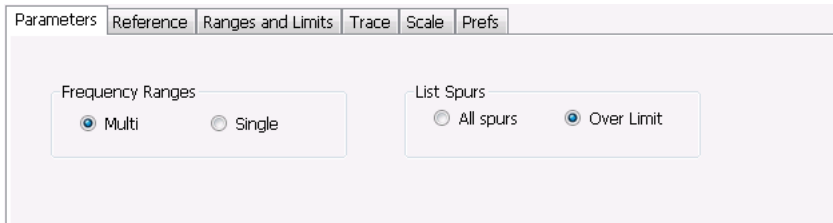

Setting	Description
Frequency Ranges	
Multi	Enables the instrument to display all enabled ranges in the graph.
Single	Limits the graph to the display of only one range. The displayed range is set to the range that contains the selected spur.
List Spurs	
All spurs	Displays any spur that exceeds the Threshold and Excursion values set on the Ranges tab.
Over Limit	Displays only spurs that exceed both the Threshold and Excursion values set on the Ranges tab and the limits specified on the Limits tab.

Reference Tab

The Reference tab enables you to specify the Power Reference parameter. The Power reference parameter is used to calculate relative values in the Spur table and to calculate relative amplitude limits.

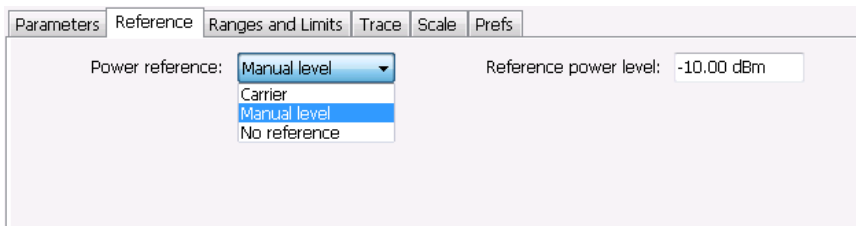

Setting	Description
Power Reference	Specifies the power reference level used for relative values and limits.
No reference	Power level readings are calculated only for absolute values, no relative values are calculated.
Manual level	The reference level for relative measurements is specified by the Reference power level setting.
Carrier	The reference level for relative measurements is based on the power level calculated at the specified carrier frequency.

Setting the Power Reference Level to No Reference

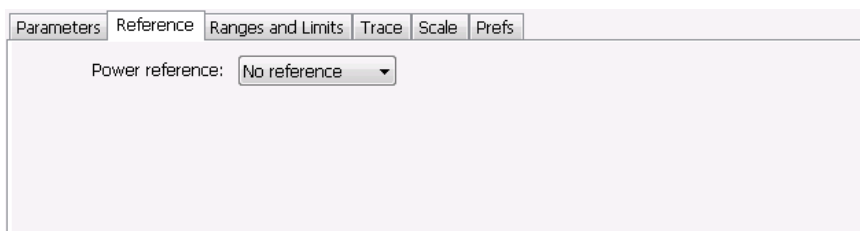

To set the power reference to No Reference:

- Select **No reference** from the **Power reference** drop-down list.

Setting the Power Reference Level to Manual Level

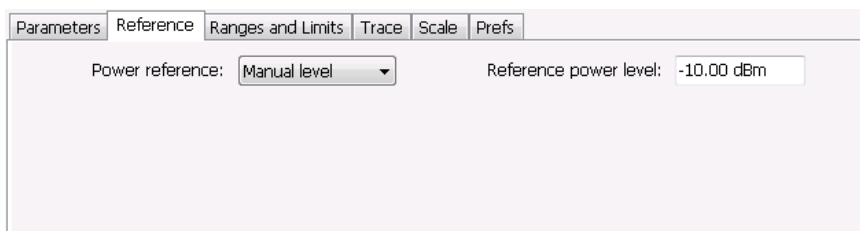

To set the power reference to manual level:

1. Select **Manual level** from the **Power reference** drop-down list. This displays the **Reference power level** entry box.
2. Specify the desired power level in the **Reference power level** entry box.

Setting the Power Reference Level to Carrier

To set the power reference to Carrier:

1. Select **Carrier** from the **Power reference** drop-down list.
2. To set the Carrier frequency, specify the necessary values in the **Frequency** and **Channel width** entry boxes .
3. Specify the **Threshold** level.
4. Specify the **Integration BW**. The Integration BW is the bandwidth over which the carrier is measured.
5. If necessary, specify the Resolution Bandwidth by changing the value in the **Res BW** entry box. Auto is the recommended setting.
6. Set the **Detection** method. Select **+Peak**, **Avg (VRMS)**, or **Avg (of logs)**.

NOTE. *If the power level measured over the Integration BW about the carrier frequency is below the threshold level, the instrument concludes that no carrier is present and no relative measurements will be taken. Absolute measurements will still be taken.*

Ranges and Limits Tab

Use the Ranges and Limits tab to specify the parameters that control the Spurious measurement. From the Ranges and Limits tab, you specify the start and stop frequencies for ranges, whether or not a range is enabled, the parameters that specify what constitutes a spur, measurement filter shape and bandwidth, and the detection method used for processing signals, as well as the pass/fail parameters for limit testing.

	On	Start (Hz)	Stop (Hz)	Filter Shape	BW (Hz)	Auto	Detector	VBW (Hz)	VBW On
A	X	1.492500G	1.507500G	RBW	100.000k	X	+Peak	100k	
B	X	1.512500G	1.537500G	RBW	200.000k	X	+Peak	200k	
C		0.000000	0.000000	RBW	1.000M	X	+Peak	1M	
D		0.000000	0.000000	RBW	1.000M	X	+Peak	1M	
E		0.000000	0.000000	RBW	1.000M	X	+Peak	1M	

Setting	Description
Expand	Displays the Ranges and Limits Table in a new, resizable window.
Reset layout	You can reorder columns in the Ranges and Limits Table by dragging the columns to a new position. Clicking Reset Layout returns the column order to the factory default order.
Load	Click to load a saved Ranges and Limits table from a file. The default directory is the last folder to which you saved an Acq data export (.CSV) file.
Save	Click to save the current Ranges and Limits table to a file. The default directory is the last folder to which you saved an Acq data export (.CSV) file.

To specify the ranges and limits for the Spurious measurement:

- Edit the values in the Ranges and Limits table.

You can edit the Ranges and Limits table in two ways:

- Edit values directly from the Ranges and Limits tab. You will need to scroll the table to access all settings.
- Click the **Expand** button. This displays the Ranges and Limits Table in a new window that can be sized to the full screen.

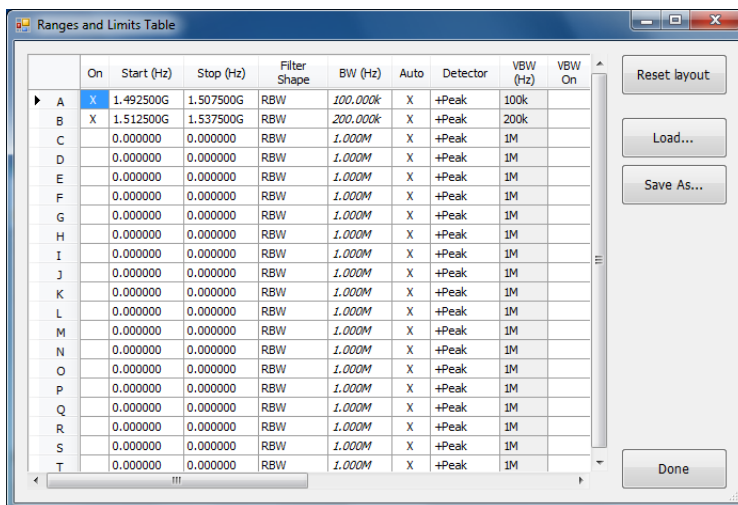

The following table describes the parameters that are set in the Ranges and Limits Table.

Ranges and Limits Table Settings

Setting	Description
On	Specifies whether or not measurements are taken in the specified range.
Start (Hz)	Readout of the start frequency for the selected range.
Stop (Hz)	Readout of the stop frequency for the selected range.
Filter shape	Specifies the filter shape used for the Spurious measurement.
BW (Hz)	Specifies the bandwidth used for the selected filter shape.
Auto	Sets the BW automatically. If CISPR is selected for Filter shape, this control is disabled.

Setting	Description
Detector	For CISPR detectors, this selection enables calculation as per the methods described in the CISPR documents. Supported CISPR detectors include CISPR Pk. For non-CISPR detectors, this selection indicates the processing method used for compressing excess intermediate data into the desired number of trace points.
VBW (Hz)	Adjusts the VBW (Video Bandwidth) value. VBW Maximum: 10 times RBW current value; VBW Minimum: 1/10,000 RBW setting. Disabled when Filter shape is set to CISPR.
VBW On	Specifies whether the VBW filter is applied.
Thrshld (dBm)	Threshold specifies the level that must be exceeded for a signal peak to be recognized as a spur. A signal peak must also exceed the Excursion setting to be considered a spur.
Excrsn (dB)	Excursion specifies the peak to peak magnitude that must be exceeded for a signal peak to be recognized as a spur. A signal transition must also exceed the Threshold setting to be considered a spur.
Mask	Selects the type of limits used for Pass/Fail testing. Spurs that exceed the mask settings are considered violations. The available choices are shown below.
Abs	Spurs that exceed the Absolute limits settings are identified as violations.
Rel	Spurs that exceed the Relative limits settings are identified as violations.
Abs & Rel	Spurs that exceed both the Absolute and Relative limits settings are identified as violations.
Abs OR Rel	Spurs that exceed either the Absolute or Relative limits settings are identified as violations.
Off	Turns off limit testing for the selecting range. Measurements are still taken in the range, but violations are not flagged. Signal peaks that exceed the Threshold and Excursions values will still be identified as spurs.
(Abs Start and Abs Stop)	Absolute amplitude limits are not based on the measured carrier amplitude or manual reference. Start and stop values can be different.
Abs Start (dBm)	Abs Start specifies the limit at the start frequency of the range.
Abs Stop (dBm)	Abs Stop specifies the limit at the stop frequency of the range.
Abs Same	Sets the limit at the start and stop frequencies to the value set for the start frequency.
(Rel Start and Rel Stop)	Relative amplitude limits are calculated from the Power Reference. If the Power Reference is set to the Carrier level, the relative amplitude limits will change with the carrier level. Start and stop values can be different.
Rel Start (dB)	Specifies the limit at the start frequency of the range.
Rel Stop (dB)	Specifies the limit at the stop frequency of the range.
Rel Same	Sets the limit at the stop frequency to the value set for the start frequency.
Save As	Click to save the current Ranges and Limits table to a file.
Load	Click to load a saved Ranges and Limits table from a file.
Done	Save changes and close the Ranges and Limits Table window.

Changing the Range Start and Stop Frequencies

To change the range start and stop frequencies, edit the Start and Stop frequencies in the Ranges and Limits Table:

1. Click the **Expand** button on the **Settings > Range and Limits** tab. This displays the Ranges and Limits Table.
2. Click the **On** box for a range to take measurements in the range.
3. Click on the Start or Stop frequency setting to change it. Type in a number for the frequency and a letter as a multiplier. You can use k, m, or g to set the frequency multiplier.
4. Click **Done** to save your changes.

Specifying Spur Requirements

A spur is a signal peak that exceeds both the Threshold and Excursion settings in the Ranges and Limits table. The Threshold and Excursion settings are absolute values; they are not calculated relative to a reference. The Threshold and Excursion settings are specific to the selected range. If you want to use different settings for spurs in different ranges, you have to set the values separately for each range. The Excursion control is used to avoid interpreting a single spur as multiple narrower spurs by requiring the amplitude to drop by the Excursion amount between spurs. Raising the Threshold value means that fewer, larger signals will be identified as spurs.

To specify the spur requirements for a range:

1. Click the **Expand** button on the **Range and Limits** tab. This displays the Ranges and Limits Table.
2. Select the **Range** (A–T) for which you want to specify the spur requirements.
3. Set the **Thrshld** value.
4. Set the **Excrsn** value.

Setting Limits

Use the Limits settings in the Ranges and Limits Table to specify the pass/fail parameters for the Spurious measurement. When the Mask setting is set to any value except off, the instrument identifies any signal peak that exceeds the specified limits as a violation and displays Fail on the screen. If no signal peak exceeds the limits, the instrument displays Pass on the screen.

Performing Pass/Fail Limit Testing

To set limits:

1. Click the **Expand** button on the **Range and Limits** tab. This displays the Ranges and Limits Table.
2. Adjust the Start and Stop frequencies as required for each range you want to test.
3. For ranges that you wish to test, verify that the **On** box is checked.
4. For each range you wish to test, select the desired **Mask** type from the drop-down list.
5. Set the limits as desired in the **Abs Start**, **Abs Stop**, **Rel Start**, and **Rel Stop** boxes. The values you can edit depend on the mask type you select.
6. Verify that the **Thrshld** and **Excrsn** values are set as required. These are the values that define a spur.

7. Click **Done** to save your changes and close the Range and Limits Table window.
8. Click **Run** to begin testing.

CCDF Display

The CCDF (Complementary Cumulative Distribution Function) is a statistical characterization that plots power level on the x-axis and probability on the y-axis of a graph. Each point on the CCDF curve shows what percentage of time a signal spends at or above a given power level. The power level is expressed in dB relative to the average signal power level. The CCDF Display also shows the Average power level and the Peak/Average ratio.

To show the CCDF display:

1. Press the **Displays** button or select **Setup > Displays**. This shows the **Select Displays** dialog box.
2. From the **Measurements** box, select **RF Measurements**.
3. Double-click the **CCDF** icon in the **Available Displays** box. This adds the CCDF icon to the **Selected displays** box.
4. Click the **OK** button.

Elements of the CCDF Display

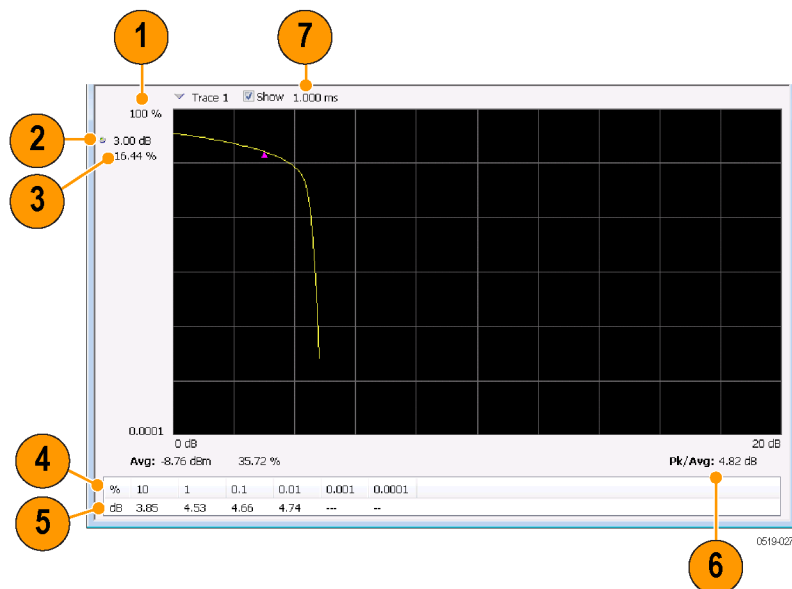

Item	Display element	Description
1	100%	The top of the graph represents the 100% probability that the signal will be at or above the average signal level.
2	Power level select	Adjust to display the value of the CCDF curve at a specific power level. The selected power level is indicated by a small triangle on the CCDF curve.
3	CCDF value	Readout of the value of the CCDF curve at the selected power level.
4	Avg	Readout of the Average power level and the CCDF value at the Average power level.
5	Readout Table	Readout of the CCDF curve at six points.
6	Pk / Avg	Readout of the Peak to Average power ratio.
7	Measurement time	Readout of the length of time used for the measurement. Displays --- s when the Measurement time is set to continuous.

[Changing the CCDF Display Settings \(see page 138\)](#)

CCDF Settings

Main menu bar: Setup > Settings

Favorites toolbar: 

The control panel tabs for the CCDF Display are shown in the following table.

Settings tab	Description
Parameters (see page 140)	Specifies the time to be measured.
Traces (see page 174)	Select the trace to be measured and select reference trace for display.
Scale (see page 139)	Specifies the vertical and horizontal scale settings.
Prefs (see page 110)	Specifies whether or not certain display elements are shown.

Restore defaults. Sets the CCDF parameters to their default values.

Scale Tab

The Scale tab for the CCDF display allows you to change the start and stop points for the horizontal trace. Changing the scale settings changes how the trace appears on the display but does not change control settings such as Center Frequency.

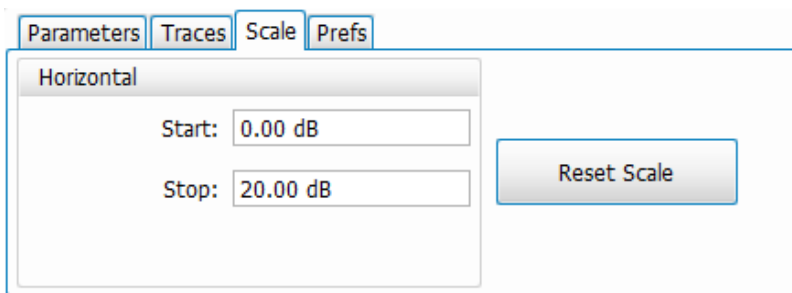

Setting	Description
Rest Scale	Resets all settings to their default values.
Horizontal	Controls the span of the trace display and position of the trace.
Start	Sets the starting range of the trace.
Stop	Sets the end range of the trace.

Parameters Tab

The Parameters tab enables you to specify several parameters that control signal acquisition for the CCDF Display.

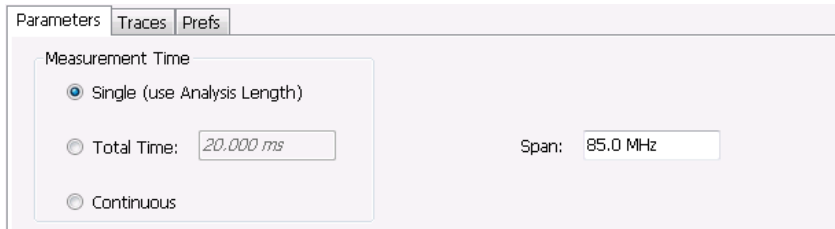

Setting	Description
Single	When Single is selected, the CCDF measurement is based on the Analysis Time parameters set on Analysis control panel (Setup > Analysis > Analysis Time), shared by all displays. In Single, CCDF is time-correlated with the other open displays.
Total Time	When Total Time is selected, you can adjust its value. The value set here changes the Analysis Length (and Acquisition Length, if needed) to 20 msec. If the Total Time value is longer than the Analysis Length, CCDF uses multiple acquisitions to collect signal data.
Continuous	When Continuous is selected, the CCDF measurement combines each new record (Actual Analysis Length) into the existing result. It does not erase and start over until user presses STOP or CLEAR.
Span	Specifies the range of frequencies used for analysis.

Single

To have statistically meaningful results, CCDF works best when calculated on at least 1 ms of data. Depending on the Analysis Time setting, the CCDF display may present error messages:

- If the Actual Analysis Time is greater than 1 ms, the CCDF Display will calculate the trace without any problems.
- If the Actual Analysis time is less than 1 ms, the CCDF Display will measure the data as best it can, but if it receives fewer than 20 samples, the CCDF display will clear the trace and report "Not enough samples".

Total Time

Setting the Measurement Time to Total Time changes the Analysis Length (and Acquisition Length, if needed) to 20 msec. This can impact other measurements. For instance, the OBW measurement would change because it would get more analysis length than it normally needs, so switching in/out of the CCDF Total Time selection noticeably affects OBW results. This happens to a lesser amount when Measurement Time is set to Single or Continuous. This is because each sets Analysis Length to 1 msec. These different Analysis Lengths may affect other measurements, too.

Settling Time Measurement Overview

The Settling Time measurement (Option SVT) is used to measure frequency and phase settling time of frequency-agile oscillators and subsystems. Automated measurements can reduce user-to-user measurement variations, improve repeatability and measurement confidence, and save time in gathering results.

Measurement Definitions

Settling time. The time measured from a reference point to when the signal of interest settles to within user-defined tolerance.

Settled frequency. The final reference frequency, determined automatically or manually. The tolerance band is centered about this settled frequency.

Settled phase. The final reference phase, determined automatically or manually. The tolerance band is centered about this settled phase.

Mask Testing

Mask testing is a tool to automatically determine the pass/fail state of the Device-Under-Test. The mask is defined over three or fewer user-defined time zones, with an independent limit band for each time zone. If the mask is violated, the area of violation is highlighted in red on screen, and a Fail message is displayed. The pass/fail status of the mask test can be queried over GPIB for rapid results. To configure Mask testing, see the [Mask tab \(see page 157\)](#).

The instrument's Search function can watch the Settling Time measurement for either pass or fail results, and perform actions such as stopping or saving data when the defined condition occurs. See [Mask Test Limits Settings \(see page 519\)](#) for details on configuring Mask Test.

Frequency Settling Time Theory of Operation

The following paragraphs describe how a frequency and phase settling measurement is made.

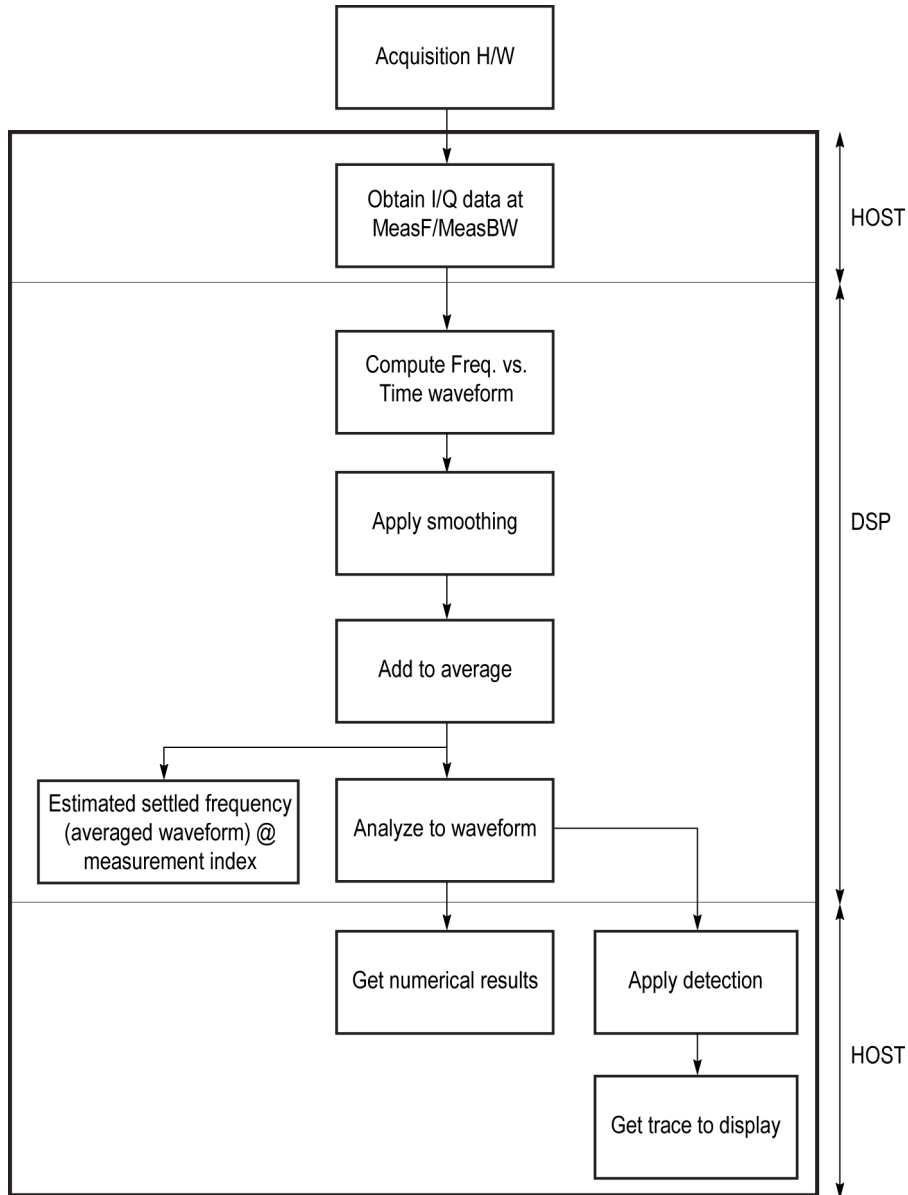

Frequency settling time flow diagram

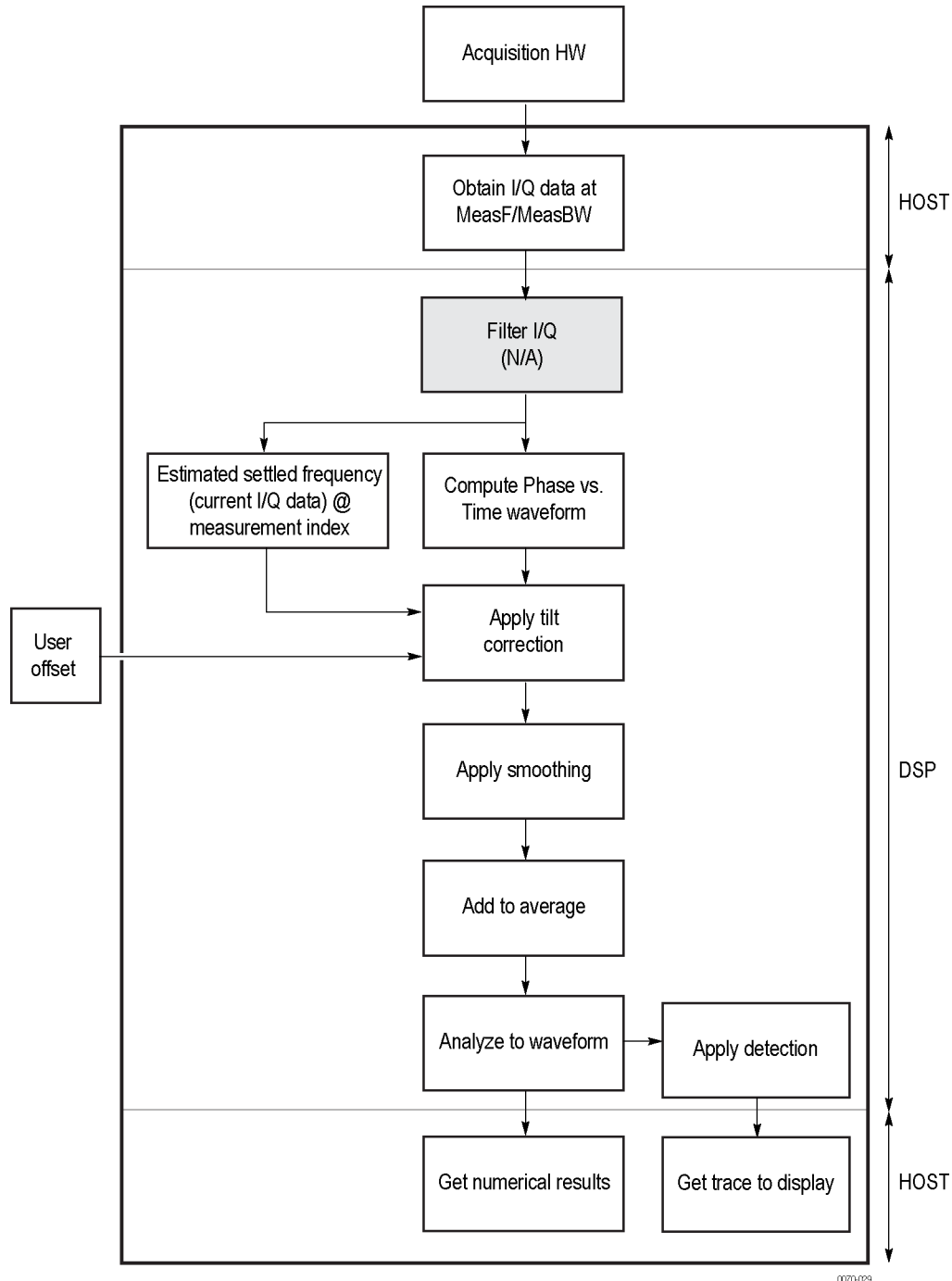

Phase settling time flow diagram

Acquisition hardware collects I and Q samples at the measurement frequency. Sample Rate is based on the measurement bandwidth setting.

The instantaneous phase is computed as:

$$Ph_{(n)} = \text{atan} \left(\frac{Q_{(n)}}{I_{(n)}} \right)$$

The instantaneous frequency is the derivative of the phase:

$$Fr_{(n)} = (Ph_{(n-1)} - Ph_{(n+1)}) \times \left(\frac{F_{\text{sampling}}}{(2 \times 2PI)} \right)$$

Data smoothing is applied (if selected by the user). This filtering method uses $\pm n$ adjacent samples to produce an average value that is used to replace the values of the original $2n$ samples. An example is shown below.

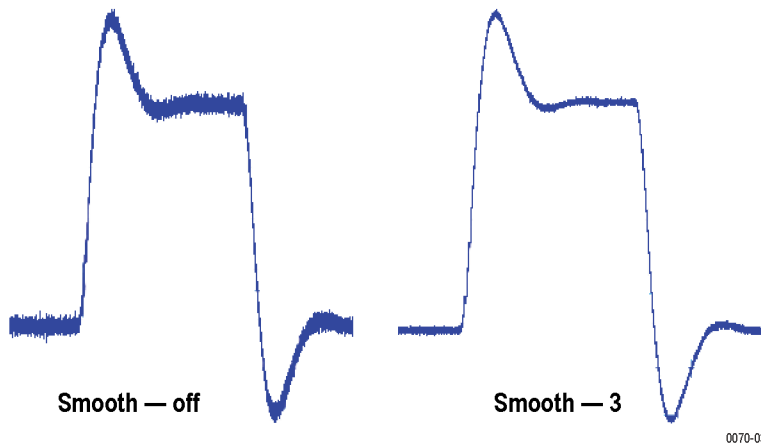

If averaging is turned on, the smoothed data array is averaged with data arrays of previous acquisitions on a point-by-point basis. Smoothing has the advantage of reducing noise-like variations in the measurement, but carries the risk of masking real measurement data. The amount of smoothing applied must be determined by evaluating the waveform you see for artifacts that result from the process.

Next, Settled Frequency is calculated. Settled frequency is the average frequency determined by looking back in time from the point set by the Measurement Length control over a minimum of 256 samples. This value is used to determine the frequency level about which to center the Tolerance range. The measurement then searches backward through the data until it finds the first point that exceeds the tolerance range. A maximum of 20 million acquisition data samples can be processed by the measurement.

Settling Time is measured as the time from the start reference to the point where the frequency remains within the tolerance band. The start reference can be any of three points:

- The trigger point
- The beginning of the analysis period. This result can only be computed when the instrument can find a previous settled state within the measurement period
- The point at the end of the previous frequency hop where the frequency first leaves the tolerance band. This result can only be computed when the instrument can find a previous settled state within the measurement period.

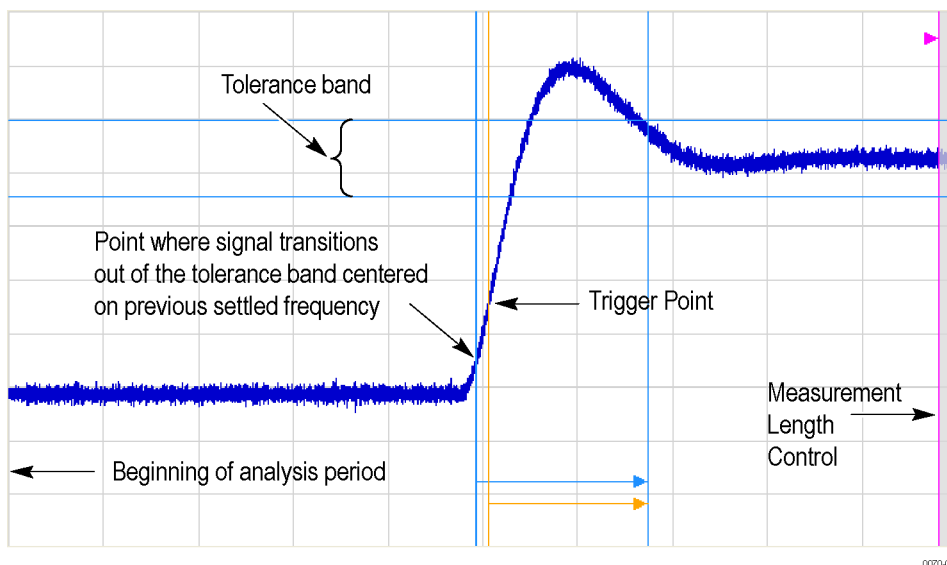

Settling time start reference points

All measurements are now complete and the numeric settling time values can be sent to the display. However, no result traces have been produced yet. Detection is used to reduce the measured points (which can number up to 10 million) to a number more easily processed by the display processor. +/- Peak detection is always used, preserving the maximum positive and negative excursions for display. Reducing the number of points in the result reduces the time resolution of the markers. If averaging is on, the measurement results are computed on the average of the undecimated results.

Phase Settling Time Overview

Phase settling time is determined, as described previously, with the addition of tilt correction.

The instrument estimates tilt (or slope of the phase) using linear least square fitting over (at least) 256 samples of the phase vs. time waveform, looking backwards from the point set by the Measurement Length. The instrument adjusts the phase waveform so that its phase is of zero value at the point set by the Measurement Length.

Settling Time Displays

The Frequency Settling Time measurement is used to measure the frequency settling time of frequency-agile oscillators and subsystems. The Phase Settling Time measurement is used to measure the phase settling time of phase-agile oscillators and subsystems. Automated measurements can reduce user-to-user measurement variations, improving repeatability and measurement confidence and saving time in gathering results. To measure phase settling, a phase reference is required. This means that the measurement tool must be frequency-referenced to the device under test, or must act as the frequency reference to the device under test. To lock the reference to an external source, go to Setup > Configure In/Out > Frequency Reference and choose **External**. Values from 1 MHz to 25 MHz in 1 MHz steps can be used as an external reference.

To show a Settling Time display:

1. Click the **Displays** button or select **Setup > Displays**.
2. From the Measurements box, select **RF Measurements**.
3. Double-click the **Freq Settling** icon or the **Phase Settling** icon in the **Available displays** box. This adds the selected display to the **Selected displays** box (and removes it from the Available displays box).
4. Click the **OK** button.

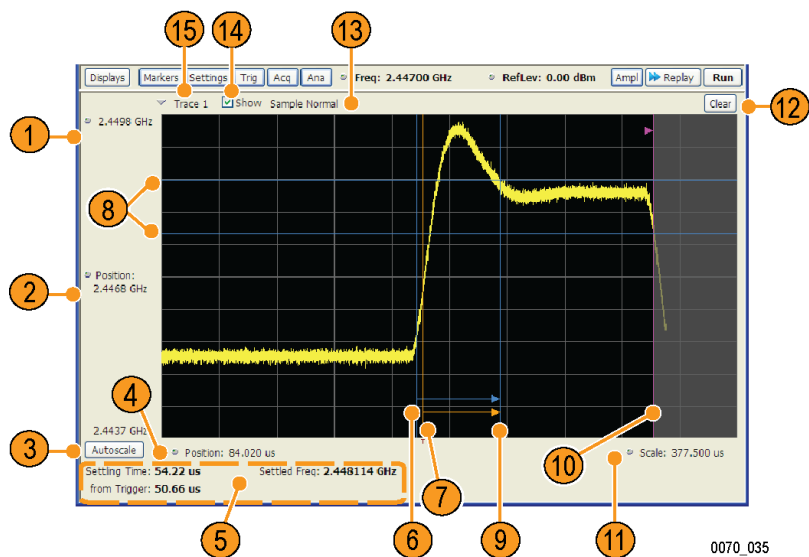

Frequency settling time display

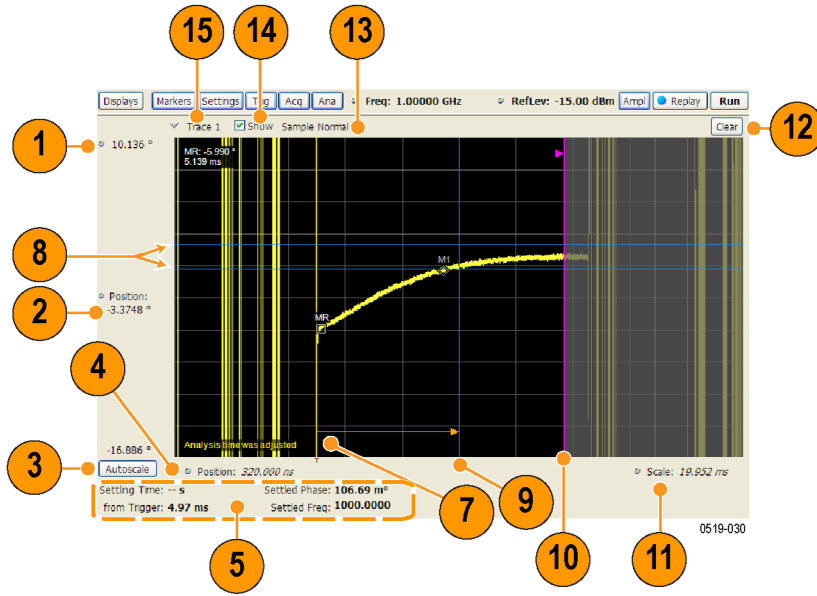

Phase settling time display

Elements of the Display

Item	Display element	Description
1	Top of graph	Sets the frequency/phase that appears at the top of the graph. However, note that the top of graph setting, vertical scale setting (Settings > Scale tab), and Vertical Position settings interact. Adjusting this value changes the frequency/phase at the top of the graph by adjusting the scale setting. Phase Settling Time: Sets
2	Vertical Position	Sets the frequency/phase value at the vertical center of the graph.
3	Autoscale	Adjusts the Vertical and Horizontal scaling to display the entire trace on screen.
4	Horizontal Position	Sets the horizontal position of the trace on the graph.
5	Measurement readouts	Displays measurement results. See <i>Measurement Readout Text Color</i> below.
6	Signal transition start indicator	A blue vertical line that indicates the starting point of the Settling Time measurement that is based on the signal transition away from the previous settled state, if a previous settled state is found within the measurement period.
7	Trigger point indicator	An orange line and "T" (which appears below the graph) that indicates the location of the trigger point in time.
8	+/- Tolerance indicators	A pair of blue horizontal lines that show the tolerance range.
9	Settled time indicator	A blue vertical bar that shows the point on the trace at which the measurement has determined the signal frequency or phase to be settled.
10	Measurement length indicator	A magenta vertical line that specifies the end of the allowed measurement period. This is a control, not a result.
11	Scale	Adjusts the horizontal (time) scale of the graph.
12	Clear	Restarts multi-trace functions (Avg, Hold) and erases the trace.
13	Function	Displays the Detection and Function selections for the selected trace. (Detection is always +/-Peak for Settling Time measurements.)
14	Show	Controls whether the selected Trace is visible or not. When trace is Off, the box is not checked.
15	Trace	Selects a trace. Touching here displays a menu that shows the available traces and whether they are enabled or not. If you select a trace that is not currently enabled, it will be enabled.

Measurement Readout Text Color

The measurement readouts can appear in either black text or red text. Measurement results that appear in black text indicate:

- the signal is settled AND
- the signal is settled longer than the minimum settled duration AND
- the settling time is valid OR the settling time from trigger is valid

If any of the conditions listed are not met, the measurement results text is red.

Elements of the Frequency Settling Time Graph

The following illustration shows the various indicators that appear in the Frequency Settling Time graph.

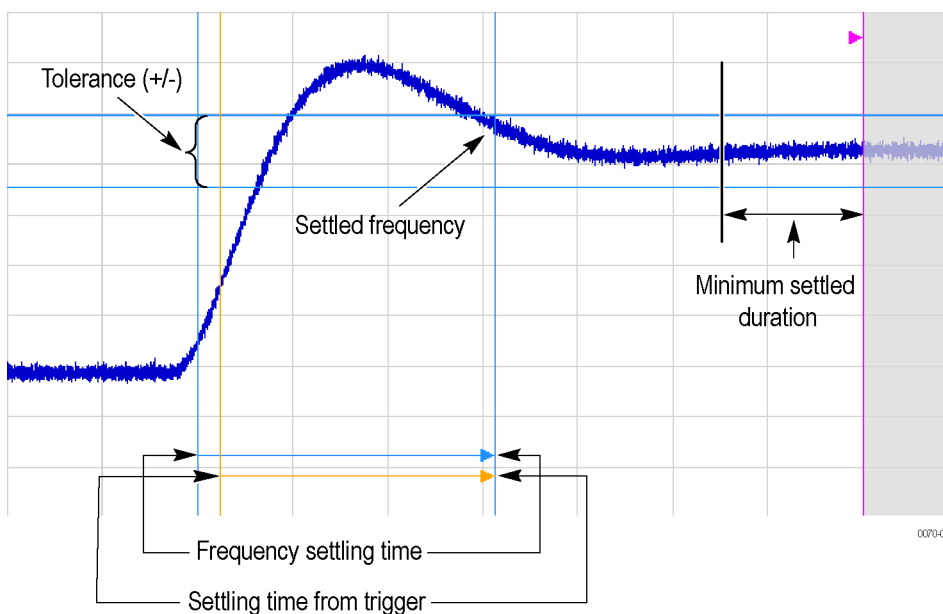

NOTE. The blue vertical bar that indicates the end of the previous settled state may not always appear. For frequency settling time, this can happen because the starting frequency is outside the measurement bandwidth.

Elements of the Phase Settling Time Graph

The following illustration shows the various indicators that appear in the Phase Settling Time graph. For most phase settling time measurements, there is not a previous settled state within the measurement period, making it impossible to measure the settling time from the previous settled value. However, the settling time from trigger is typically available.

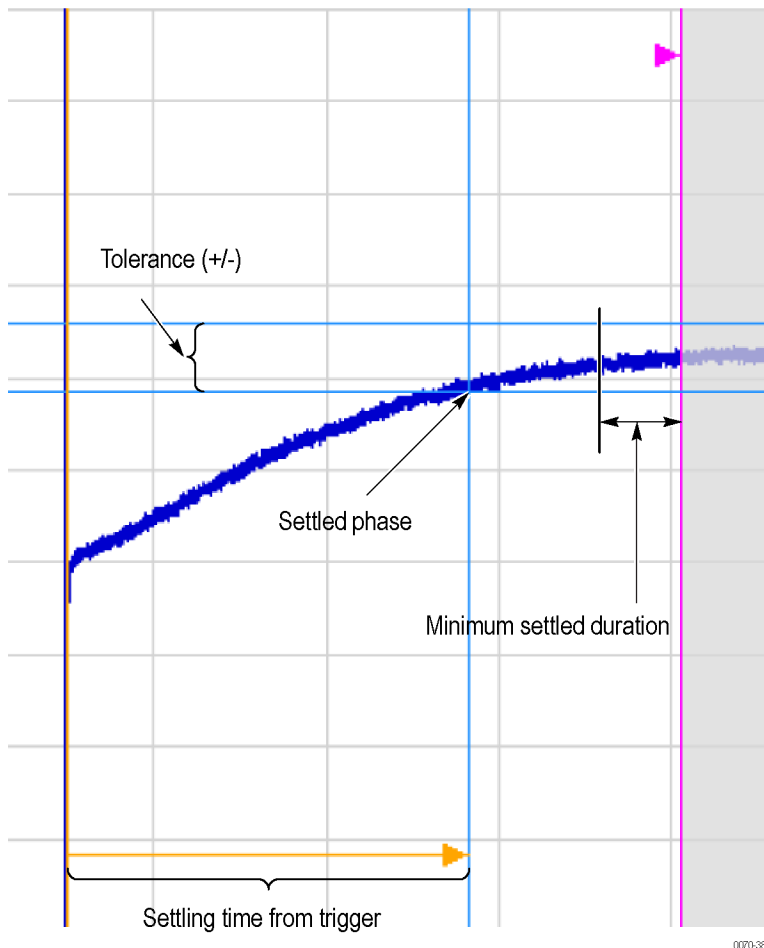

NOTE. The blue vertical bar indicating the measurement start time may not appear. Zero phase is referenced to the measured hop, as the phase will not typically have a settled value during the previous hop.

Measuring Settling Time

1. Select the **Displays** button.
2. Select **RF Measurements** from the **Measurements** box.
3. Double-click the **Freq Settling** icon or **Phase Settling** icon in the Available displays box. Click **OK** to complete your selection.
4. Select **General Signal Viewing** from the **Measurements** box.
5. Double-click the **Time Overview** icon in the Available displays box. Click **OK** to complete your selection.
6. Press the front-panel **Freq** button and use the front-panel keypad or knob to adjust the frequency to that of the signal you want to measure.

7. Select the Trig button.
8. In the Trigger control panel, select Triggered. Configure the trigger settings as needed to achieve a triggered signal.

For the next step in measuring settling time, you must set the starting point of the measurement. To do this, you will use the Time Overview display.

9. Select the Time Overview display.
10. At the left edge of the graph, drag across the graph to adjust the analysis offset. Adjust the Analysis Offset to locate the start of the settling time measurement just ahead of the signal transition where you want to measure the settling time. Any portion of the signal in the gray area will be excluded from the settling time measurement.

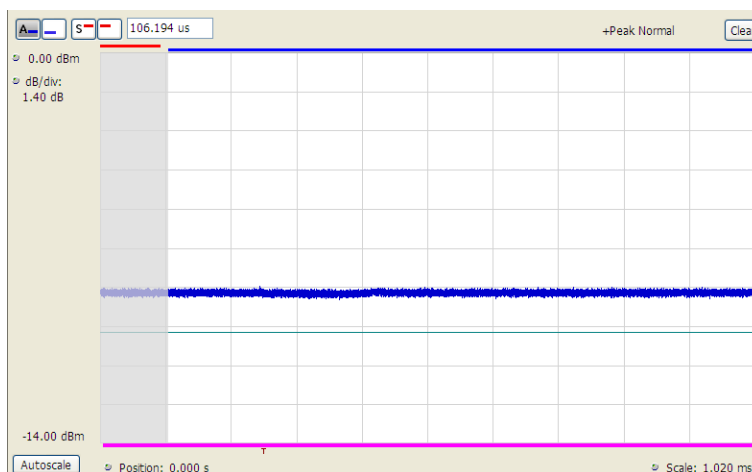

Setting the starting point of the settling time measurement

Even if the signal transition is difficult to see on the Time Overview display, you can set the starting point based on the location of the Trigger indicator below the graph. Or open the Frequency vs. Time graph to see the frequency transition.

11. Click in the Settling Time display to select it.
12. Select the **Settings** button to display the **Settling Time Settings** control panel.
13. On the **Define** tab, adjust the [Meas BW \(see page 154\)](#) to improve the signal-to-noise ratio as appropriate. Make sure the bandwidth covers the settled frequency, particularly when the instrument Measurement Frequency is not locked to the spectrum Center Frequency (Analysis control panel > Frequency tab).
14. Set the [Target reference \(see page 155\)](#) to Auto or Meas freq as appropriate. If you select Meas freq, also set Offset to fine-tune the measurement frequency if necessary.
15. Set the [Tolerance \(see page 155\)](#) as required for your measurement.

If your signal must be settled for a period of time before it is considered settled, you can specify a minimum settled duration for the settling time measurement.

16. Select the Time Params tab. Adjust the [Min settled duration \(see page 156\)](#) as required.

To get the measurement made in the correct location on the signal, you must adjust the measurement length. You do this by dragging the magenta line in the Settling Time graph.

17. Drag the measurement length indicator (magenta line) to the correct location on the signal. Choose a point at which the signal appears to be well settled. The measurement will then find the exact time at which the signal actually settled to within the specified tolerance.

Note the difference in the settling time in the two illustrations that follow. In both examples, the Target reference is set to Auto. The only difference is the measurement length, as shown by the magenta line.

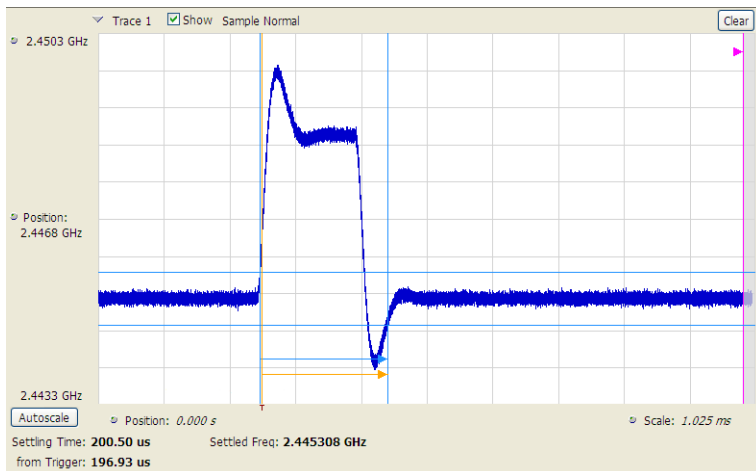

Frequency settling time display before setting the measurement length

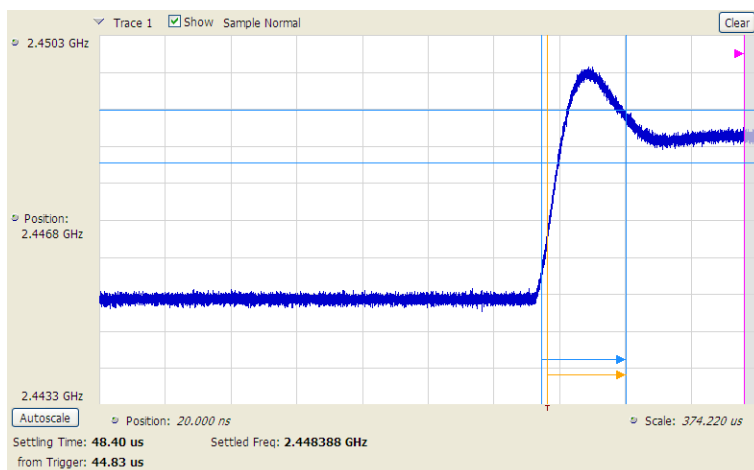

Frequency settling time display after setting the measurement length

Settling Time Settings

Main menu bar: Setup > Settings

Favorites toolbar: 

The settings for the Frequency and Phase Settling Time displays are shown in the following table.

Settings tab	Description
Define (see page 154)	Sets the measurement parameters that characterize the settling time measurement.
Time Params (see page 156)	Sets measurement end-time and minimum settled duration parameters.
Mask (see page 157)	Enable or disables mask testing and sets the parameters that specify the three zones used for mask testing.
Trace (see page 157)	Specifies trace display characteristics and which traces are displayed.
Scale (see page 160)	Sets vertical and horizontal scale and position parameters.
Prefs (see page 110)	Specifies whether or not to show certain display elements, the maximum number of points in the exported trace, and the displayed precision of the settling time measurement.

Settling Time Displays Shared Measurement Settings

The control panel tabs in this section are shared by the Frequency and Phase Settling Time displays. These control panel tabs are not shared with other RF Measurement displays. With few exceptions, each display shares values for each of the controls on these tabs. For example, Vertical Scale values are independent for each of the displays (degrees for Phase Settling Time and Hertz for Frequency Settling Time).

Common controls for settling time measurement displays

Settings tab	Description
Define (see page 154)	Specifies the parameters that characterize the settling time measurement.
Time Params (see page 156)	Specifies the Measurement length and minimum settled duration for the settling time measurement.
Mask (see page 157)	Specifies the parameters used for Mask testing.
Trace (see page 157)	Specify which traces to show and how they are computed.
Scale (see page 160)	Specifies the vertical and horizontal scale settings.
Prefs (see page 161)	Specifies display parameters of the Settling Time displays.

Define Tab for Settling Time Displays

The Define tab for the Frequency Settling Time measurement controls several parameters that affect how the measurement is made.

The screenshot shows the 'Define' tab interface with the following controls:

- Meas Freq:** 2.44700 GHz
- Target reference:** Auto (dropdown menu)
- Offset:** 0.0000 Hz
- Meas BW:** 40.00 MHz (with 'actual: 40.00 MHz' displayed below)
- Tolerance (+/-):** 500.0 kHz

Meas Freq

Select the frequency of the signal to be measured. Measurement Frequency can be selected as the target frequency (see *Target Reference*).

NOTE. *If Lock Center Frequency of Spectrum Display to Measurement Frequency is unchecked, then Measurement Frequency is independent of Center Frequency) Range: Entire input frequency of the instrument*

Meas BW

This control limits the bandwidth of the Settling Time measurement. You use the measurement bandwidth setting to improve the signal-to-noise ratio of the measurement, resulting in lower measurement uncertainty. However, if the measurement bandwidth is set too low, resulting in fewer samples per second, it can reduce the number of points within the measurement length below the 256 stable samples required, thus causing the analysis to fail. The measurement bandwidth depends on the oscilloscope on which the recalled file was acquired. To see the effect of measurement bandwidth on measurement uncertainty, see the *RSA6100B Series Specifications and Performance Verification Reference*, Tektronix part number 077-0647-XX. This manual can be downloaded from www.tek.com/manuals.

Target Reference

The target reference is a calculated or user-specified value of final settled frequency within the measurement period. When set to **Auto**, the instrument determines this value by averaging at least the last 256 samples at the end of the measurement period. When set to **Meas freq**, the Target Reference is set to the Measurement Frequency of the instrument. You can enter a manual offset from the target frequency to fine-tune the Target Reference when **Meas freq** is selected.

Tolerance(+/-)

The Tolerance is the frequency or phase range within which the signal must remain to be considered settled. This is set as a \pm value by the user. In the frequency settling time measurement, the tolerance band is centered about the target value. In the phase settling time measurement, the tolerance band is centered about the settled phase value.

The target frequency depends on the Target reference value setting:

- If Target Reference is set to **AUTO**, then the target value is the settled value (the frequency at which the signal is considered settled).
- If Target Reference is set to **MeasFreq**, then the Target value = **Meas Frequency** + **Offset**.

Offset

Offset is used for fine-tuning the Target Reference when **Meas freq** is selected. The value for Offset is entered manually.

Time Params Tab for Settling Time Displays

The Time Params tab is used to set the Measurement length and minimum settled duration parameters.

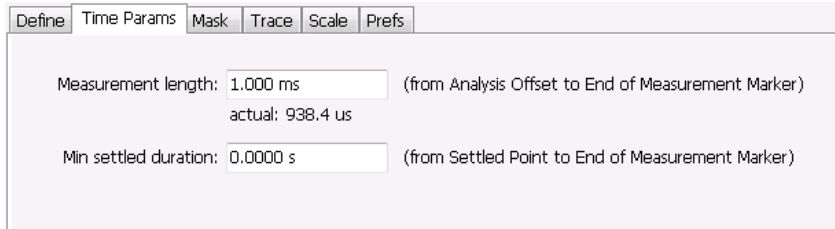

Measurement Length

Measurement length locates the end of the measurement period for settling time. This value is set independently of the analysis period for other measurements in the analyzer. This allows other measurements to display multiple frequency hops during an analysis, while focusing the settling time analysis on a single hop. You can set the measurement length either by entering a value in the entry box, or by dragging the magenta bar to the desired location in the graph. Traces and the display to the right of the measurement time are shown in grey to indicate that this section of the waveform is not being used in the measurement. If your signal does not settle to within your tolerance band, make sure that the measurement time ends during the settled portion of the waveform. The beginning of the settling time measurement is set with the analysis offset control, the same as other measurements in the instrument. Use analysis offset to exclude earlier hops from the measurement. See [Analysis Time \(see page 525\)](#) for setting the analysis offset control.

If there is more than one phase or frequency hop in the signal to be analyzed, use the Measurement Length control to instruct the analyzer which hop to measure. First, adjust the main Analysis Offset control to a point in time slightly earlier than the transition you wish to measure. Do this in the Time Overview display or the Analysis Settings control panel. Then adjust the Measurement Length so the end of the Settling Time measurement falls within the apparent settled period after the signal transition. The reason it is important for the user to set this control is that the Settling Time measurements start at this point and look backwards in time (towards the signal transition) to find the latest trace point that is not inside the tolerance band.

NOTE. *If your signal does not settle to within your tolerance bands, make sure that the measurement time ends during the settled portion of the waveform.*

Min Settled Duration

The minimum settled duration is the amount of time the signal must remain within the tolerance band to be considered settled. Some user specifications require that the signal be settled for a minimum period. If this is not required in your application, set this value to the default of 0 seconds.

Mask Tab for Settling Time Displays

The Mask tab is used to specify the parameters used for Mask testing.

	Time	Limit (+/-)
Start 1:	0.0000 s	500.0 kHz
Start 2:	100.0 us	500.0 kHz
Start 3:	1.000 ms	500.0 kHz
Stop:	13.18 ms	

Enable Mask Test

Enables or disables mask testing.

Start 1, 2, 3

Sets the starting point for the time zone of interest. If you don't want to use all three zones, set the Start Time for the unneeded zones to a time after the end of the Measurement Length.

Stop

Sets the end point for the final time zone of interest.

Limit (+/-)

Sets the mask violation limits for each time zone.

Mask Time Reference

When mask testing is enabled, the Mask time reference selection specifies the starting point of the mask. You can choose to start the mask test at the trigger point or at the point on the trace where the signal began its transition from its previous settled frequency or phase level to the level you intend to measure.

This capability is useful because some applications do not have a trigger signal available. For those situations where a trigger signal is available, the specification for the device-under-test may require that measurements be referenced to that signal.

Trace Tab for Settling Time Displays

The Traces Tab allows you to set the display characteristics of displayed traces.

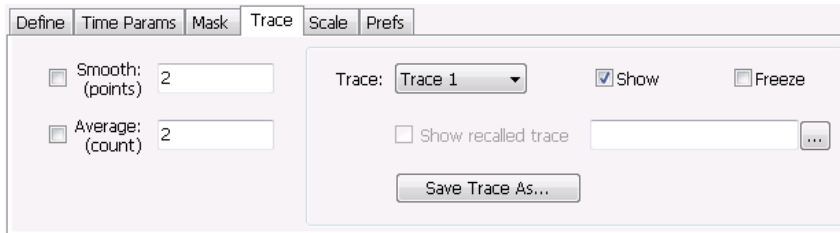

Smooth

Smooth is a low-pass filter function that uses n points in the trace to determine the smoothed value. For example, in the case of $n=3$, 3 consecutive points are averaged to determine the result of the smoothed output. This is very useful for single-shot signals that contain significant noise where multiple trace averages cannot be used. However, smoothing does have limits, and the user should visually determine whether smoothing is removing noise from the measurement, or if it is affecting the signal. The following illustration shows the effect smoothing has on the displayed trace.

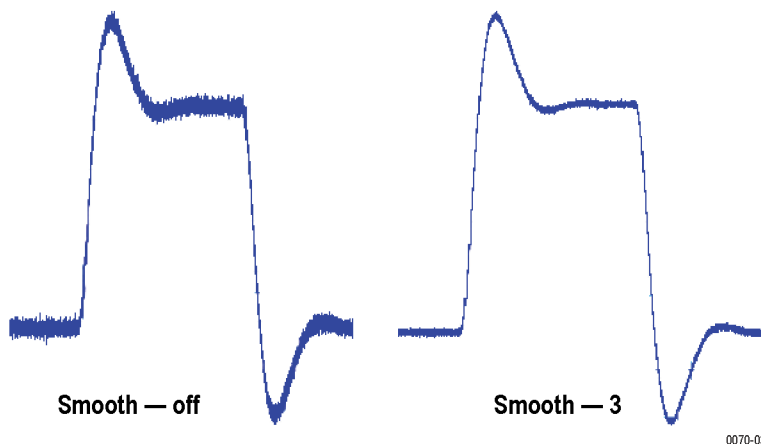

The range for the Smooth function is 2–1000. The setting resolution is 1. arrow keys increment it in steps of 1, 2, 5, 10. When smoothing is enabled, it applies to both traces. Smooth is turned off by default.

Average

This sets the number of acquisitions to be averaged together to produce the result. Averaging reduces random variations but maintains the correct waveshape for repeating signal aberrations. To use averaging, the signal must be repetitive. For example, the tuning direction must always be same for each measurement to be averaged. Signals that vary in tuning direction will tend to average positive-going effects with negative-going effects and the settling time characteristics will cancel out.

The range for the Average function is 2–10000. The setting resolution is 1. arrow keys increment it in steps of 1, 2, 5, 10. When smoothing is enabled, it applies to both traces. Smooth is turned off by default.

Trace

Selects a trace for display. Choices are Trace 1 and 2. Either trace can be a recalled trace.

Saving Traces

To save a trace for later analysis:

1. Select the **Save Trace As** button. This displays the Save As dialog box.
2. Navigate to the desired folder or use the default.
3. Type a name for the saved trace and click **Save**.

Recalling Traces

You can recall a previously saved trace for analysis or comparison to a live trace.

To select a trace for recall:

1. Select the trace into which the recalled trace will be loaded, from the Trace drop-down list.
2. Check the **Show** check box.
3. Click the ... button to display the Open dialog box.

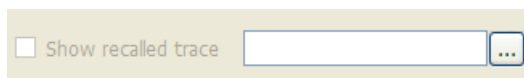

4. Navigate to the desired file and click **Open**.
5. Check the **Show Recalled Trace** check box.
6. Verify that the trace's **Show** check box is selected (either on this tab or next to the drop-down list located at the top-left corner of the graph).

Scale Tab for Settling Time Displays

The Scale tab allows you to change the vertical and horizontal scale settings. Changing the scale settings changes how the trace appears on the display but does not change control settings such as Measurement Frequency. In effect, these controls operate like pan and zoom controls.

The screenshot shows the 'Scale' tab in a software interface. It has two main sections: 'Vertical' and 'Horizontal'.
 In the 'Vertical' section:
 - 'Scale' is set to 7.0000 MHz.
 - 'Position' is set to -200.00 kHz.
 - There is a checked checkbox for 'Relative Freq' and an 'Autoscale' button.
 In the 'Horizontal' section:
 - 'Scale' is set to 1.020 ms.
 - 'Position' is set to 81.602 us.
 - There is a checked checkbox for 'Auto' and an 'Autoscale' button.

Setting	Description
Vertical	
Scale	Changes the vertical scale or span of the graph.
Position	Sets the frequency (or phase) at the vertical center of the graph.
Relative Freq	Sets the vertical (position) display readouts to show frequency values relative to the center frequency or as absolute values.
Autoscale	Resets the Scale and Position to center the trace in the graph.
Horizontal	
Scale	Sets the range of time shown in the graph.
Position	Allows you to pan the graph left and right.
Autoscale	Resets Scale and Position to the automatically determined settings.

Prefs Tab for Settling Time Displays

The Prefs tab allows you to change display parameters of the Settling Time displays.

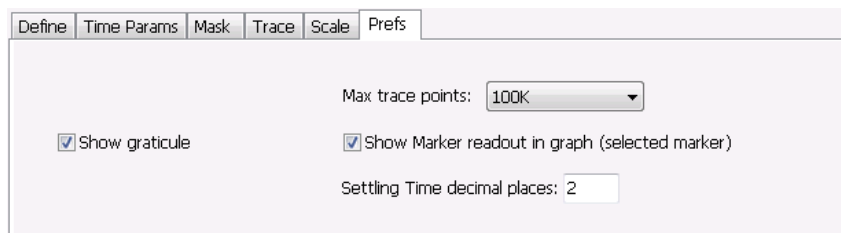

The following table explains the controls that can appear on the Prefs tab.

Setting	Description
Max trace points	Sets the number of trace points used for marker measurements and for results export.
Show graticule	Select to display or hide the graticule.
Show Marker readout in graph (selected marker)	Shows or hides the readout for the selected marker in the graph area.
Settling Time decimal places	Specifies the precision of the settling time measurement readout that appears below the graph. This setting does not affect the precision of internal calculations.

SEM Display

The SEM (Spectrum Emission Mask) display measures out-of-band emissions immediately outside the channel bandwidth that result from the modulation process and non-linearity in the transmitter. The Spectrum Emission Mask display allows you to define up to six pair of masks, or offsets, that specify the limits for out-of-band emissions and performs a pass/fail tests of the signal against the defined offsets and limits.

To show the Spectrum Emission Mask display:

1. Select **Displays** or select **Setup > Displays**.
2. In the **Select Displays** dialog, select **RF Measurements** or **WLAN Analysis** in the Measurements box.
3. In the Available displays box, double-click the **SEM** icon or select the icon and click **Add**. The SEM icon will appear in the Selected displays box and will no longer appear under Available displays.
4. Click **OK** to show the Spectrum Emission Mask display.

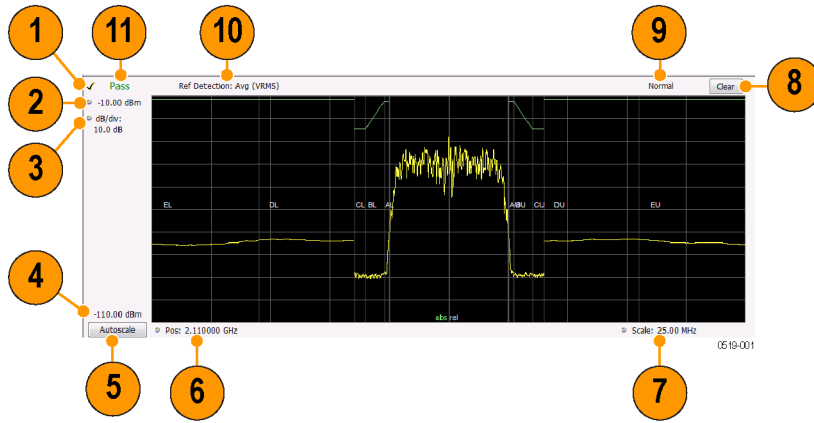

Elements of the Display

Item	Display element	Description
1	Check mark indicator	Indicates the display for which the acquisition hardware is optimized. NOTE. When Best for multiple windows is selected in the Amplitude control panel's RF & IF Optimization control, none of the measurement displays shows a checkmark, as there is not a single optimized measurement.
2	Top-of-graph setting	Sets the level that appears at the top of the graph.
(not shown)	Units	Sets the global amplitude units for all the views in the analysis window. This will change the amplitude selection in the Units tab of the Amplitude control panel.
3	dB/div	Sets the vertical scale value. The maximum value is 20.00 dB/division.
4	Bottom-of-graph readout	Indicates the amplitude at the bottom of the graph. This value changes with the dB/div and Vertical Position settings.
5	Autoscale	Properly offsets the peak of the display from the top of the screen. If the screen has been enlarged through a manual vertical (dB/div) setting entry, the view is not vertically rescaled when Autoscale is used.
6	CF / Pos	Default function is CF - center frequency (equivalent to the Measurement Freq setting). If Horizontal scaling has been manually adjusted in Setup > Settings > Scale, then Pos replaces CF as the setting at the bottom-left corner of the screen. Adjusting Pos shifts the trace left or right in the graph, but does not change the measurement frequency.
7	Span / Scale	Default function is Span - frequency difference between the left edge of the display and the right edge. If Horizontal scaling has been manually adjusted in Settings > Scale, then Scale will replace Span as the setting at the bottom-right corner of the screen.
8	Clear	Erases the current results from the display.
9	Function readout	Readout of the Function selection for the Reference channel (Setup > Processing > Function). Spurious
10	Detection readout	Readout of the Detection selection for the Reference channel (Setup > Processing > Detection).
11	Pass / Fail readout	Readout indicating whether any part of the trace has exceeded the any of the limits defined in the Offsets & Limits table (Setup > Settings > Offsets & Limits Table).

Pass / Fail Readout

This readout displays either **Pass** or **Fail XX%**. When the signal exceeds the mask in any offset, it is considered a mask violation, and results in **Fail XX%** being displayed. If there are no mask violations, **Pass** is displayed.

How the fail percentage is determined. Each offset has two sides, one lower and one upper. For example, Offset A has two sides: AL (lower side) and AU (upper side). In the SEM display, there is a maximum of six offsets (A-F) and each offset can have a maximum of two sides (if Both is selected for Side in the Offsets & Limits table). This results in a total of six offsets multiplied by two sides per offset, which results in 12 offsets. Mask violations can occur in any of these offsets. The failure percentage is calculated as follows:

Fail percentage = Number of offsets with mask violations x 100 / Total number of enabled offsets

For example: Assume there are three enabled offsets: A, B, C, and all these offsets have both lower and upper sides. Thus, the total number of enabled offsets is equal to six. Suppose there are mask violations in the offsets AL and CU, then the number of offsets having mask violations is equal to 2. Therefore, Fail percentage = $2 * 100 / 6 = 33\%$.

Results Display

The Results Display shows the measurement results for the SEM display.

Ref: Total Power	Row	Offset	Start Freq	Stop Freq	Peak Abs (dBm)	Margin Abs (dB)	Peak Rel (dBc)	Margin Rel (dB)	@Freq	Integ Abs (dBm)
-16.93 dBm	1	EL	-12.500 MHz	-8.000 MHz	-73.83	-82.33	-91.81	--	-8.010000 MHz	-68.44
	2	DL	-8.000 MHz	-4.000 MHz	-73.17	-61.67	-91.16	--	-7.460000 MHz	-67.61
	3	CL	-4.000 MHz	-3.515 MHz	-67.63	-63.13	-105.62	--	-3.965444 MHz	-77.11
	4	BL	-3.515 MHz	-2.715 MHz	-67.77	-75.17	-105.76	--	-2.722000 MHz	-75.14
	5	AL	-2.715 MHz	-2.515 MHz	-70.18	-57.68	-88.16	--	-2.515000 MHz	-70.74
	6	AU	2.515 MHz	2.715 MHz	-70.73	-58.23	-87.67	--	2.515000 MHz	-70.54
	7	BU	2.715 MHz	3.515 MHz	-67.66	-67.24	-104.59	--	3.243000 MHz	-74.72
	8	CU	3.515 MHz	4.000 MHz	-68.01	-63.51	-106	--	3.976356 MHz	-77.04

Readout

Description

Ref:	A two-part readout to the left of the table that displays information about the Reference Channel. The first part of the readout displays the Measurement Type selected on the Parameters tab. The second part of the readout displays the measurement result for the Reference channel.
Row	A sequence number for ordering the offsets. Click to organize by row number, resort rows from high to low or low to high.
Offset	The Offset name. A combination of the offset (A-F) and the location (U for upper and L for Lower).
Start Freq	The start frequency of the offset (relative to the Measurement Freq).
Stop Freq	The stop frequency of the offset (relative to the Measurement Freq).
Peak Abs	Absolute power peak power at worst case margin of the offset
Margin Abs	The worst case difference between the trace and the absolute limit line. Note that an offset can have different start and stop levels, thus, the margin can vary if the offset start and stop levels are different.
Peak Rel	Relative peak power of worst case margin of the offset. Relative with respect to the reference power level.
Margin Rel	The worst-case difference between the trace and the relative limit line. Because an offset can have different start and stop levels, the margin can vary if the offset start and stop levels are different.
@Freq	The frequency at which the worst margin occurs.
Integ Abs	The absolute integrated power of the offset.
Integ Rel	The relative integrated power of the offset (with respect to the reference power).

Reordering results in the results table. You can sort the results in the Results table by clicking the column heading containing the values you want to sort on. You can sort results for the following columns: Row, Offset, Start Frequency, Stop Frequency, Peak Abs, and Peak Rel.

Rearranging columns in the results table. You can rearrange the order of the columns and their size. To rearrange columns, select the column heading you want to move and drag it to the new position; the new location is indicated by a dark blue bar that appears between column headings.

You can resize the columns by selecting the divider between columns and dragging it to a new position.

Spectrum Emission Mask Settings

Main menu bar: Setup > Settings

Favorites toolbar: 

The settings for the Spectrum Emission Mask display are visible when SEM is the selected display. To display the SEM Settings, select **Setup > Settings**.

Settings tab	Description
Parameters Tab (see page 166)	Specifies several characteristics that control how the measurement is made.
Processing Tab (see page 167)	Specifies settings for detection on the Reference channel and the offsets. Specifies the function setting.
Ref Channel Tab (see page 168)	Specifies how the measurements on the reference channel are performed.
Offsets & Limits Table (see page 168)	Specifies characteristics of offsets and mask limits.
Scale Tab (see page 171)	Specifies the vertical and horizontal scale settings.
Prefs Tab (see page 172)	Specifies the appearance features of the graph area and the maximum trace points.

Parameters Tab - SEM

The Parameters tab specifies several characteristics that control how the Spectrum Emission Mask measurements are made.

The screenshot shows the 'Parameters' tab in the software interface. It contains several settings:

- Meas Freq:** 1.500000 GHz
- Step:** 1.000000 MHz, with an for 'Auto'.
- Measurement Type:** Total Power
- Offset definition:** Ref Edge to OS center
- Filter shape:** Gaussian

Setting	Description
Meas Freq	Specify the frequency of the signal to be measured.
Step	Sets the increment size when changing the Frequency using the knob or mouse wheel.
Auto	When Auto is enabled, the step size is adjusted automatically based on the span setting.
Real-Time	When Real-Time mode is enabled, the entire SEM span is measured using a real-time/contiguous acquisition. Not all described parameters are available in Real-Time mode.
Measurement Type	Specifies the type of measurement for the reference channel; used as a reference for the offsets.
Total Power	Sets the reference to the integrated power of the reference channel within the reference's integration bandwidth.
PSD	Sets the reference to the mean of the power spectral density (dBm/Hz) of the reference channel. The trace and the absolute and relative limits line are also in dBm/Hz
Peak	Sets the reference to the Peak power of the reference channel.
Offset definition	Defines the relative position of the start/stop frequency of an offset. Choose the offset definition based on the standard.
Ref center to OS center	Specifies that the start/stop frequencies are defined from the center frequency of the reference channel to the center of the filter BW.
Ref center to OS edge	Specifies that the start/stop frequencies are defined from the center frequency of the reference channel to the center of the (inner) edge of the filter BW of the offset.
Ref Edge to OS center	Specifies that the start/stop frequencies are defined from the edge of the reference channel to the center of the filter BW of the offset.
Ref Edge to OS edge	Specifies that the start/stop frequencies are defined from the edge of the reference channel to the (inner) edge of the filter BW of the offset.
Filter Shape	Specifies the shape of the filter determined by the window that is applied to the data record, in the spectrum analysis, to reduce spectral leakage. 3GPP specifies a Gaussian window shape be applied to the reference channel measurements.
Gaussian	This filter shape provides optimal localization in the frequency domain.
Rectangular	This filter shape provides the best frequency, worst magnitude resolution. This is essentially the same as no window.

Processing Tab - SEM

The Processing tab controls the Detection settings for the Reference Channel and Offsets, as well as selecting the Function.

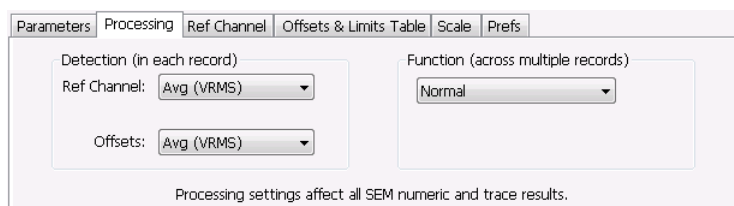

Settings tab	Description
Detection (in each sweep)	
Ref Channel	Specifies the Detection method used for the Reference Channel. Detection is used to produce the desired measurement result (peak or average) and to reduce the results of a measurement to the desired number of trace points.
Avg (VRMS)	For each sweep, each point of the trace is the result of determining the RMS voltage value for the last 'n counts' of the collected traces for the same point. When 'n count' has not been reached, partial averaging results are displayed.
+Peak	Selects the +Peak detection method. With this method, the highest value is selected from the results to be compressed into a trace point.
Offsets	Specifies the detection method used for the offsets.
Avg (VRMS)	Selects the Average Vrms detection method. With this method, each point on the trace in each offset is the result of determining the RMS Voltage value for all of the results values it includes.
+Peak	Selects the +Peak detection method. With this method, the highest value in each offset is selected from the results to be compressed into a trace point.
Function (across multiple sweeps)	
Function	Selects the trace processing method. Available settings are: Normal, Avg (VRMS), and Hold.
Normal	When a new trace has been computed, it replaces the previous trace.
Max Hold	With each sweep, each trace point in the new trace is compared to the point's value in the old trace and the greater value is retained for display and subsequent comparisons.
Avg (VRMS)	For each sweep, each point on the trace is the result of determining the RMS Voltage value for all of the collected traces' values for the same point.

Ref Channel Tab

The Ref Channel tab controls how the measurement of the Reference channel is performed.

The screenshot shows the 'Ref Channel' tab with the following settings:

- Power Reference: Auto
- Channel width:
- Channel Filter:
- RBW:
- Integration BW:
- Filter param:
- VBW:
- Chip rate:

Settings tab	Description
Power Reference	The value used to calculate relative measurements.
Auto	When Auto is unchecked, you can enter a value for the reference power, and the measured reference power is not used or displayed
RBW	Sets the RBW for the Reference Channel.
VBW	Enables/disables the Video Bandwidth filter. VBW is used in traditional swept analyzers to reduce the effect of noise on the displayed signal. The VBW algorithm in the analyzer emulates the VBW filters of traditional swept analyzers. When the checkbox next to VBW is not checked, the VBW filter is not applied. SEM standards specify what value of VBW should be applied, if any.
Channel width	Specifies the width of the reference channel.
Integration BW	Specifies the integration bandwidth used to compute the total power in the reference channel.
Channel Filter	Specifies the measurement filter used in the Reference Channel. Choices are None and Root-raised Cosine.
Filter param	Specifies the alpha value (or roll-off factor) of the Root-raised cosine filter. Present only when Channel Filter is set to Root-raised Cosine.
Chip rate	Specifies the chip rate used for the Root-raised Cosine filter. Present only when Channel Filter is set to Root-raised Cosine.

Offsets & Limits Table Tab - SEM

The Offsets & Limits Table tab is used to specify parameters that define Offsets and masks.

	On	Start (Hz)	Stop (Hz)	Side	RBW (Hz)	n (RBWs)	Filter BW (n x RBW)	VBW (Hz)	VBW On	Mask
▶ A	<input checked="" type="checkbox"/>	9.000000M	11.000000M	Both	100.000k	1	100.000k	30.000k	<input checked="" type="checkbox"/>	Rel
B	<input checked="" type="checkbox"/>	11.000000M	20.000000M	Both	100.000k	1	100.000k	30.000k	<input checked="" type="checkbox"/>	Rel
C	<input checked="" type="checkbox"/>	20.000000M	30.000000M	Both	100.000k	1	100.000k	30.000k	<input checked="" type="checkbox"/>	Rel
D	<input checked="" type="checkbox"/>	30.000000M	50.000000M	Both	100.000k	1	100.000k	30.000k	<input checked="" type="checkbox"/>	Rel
E	<input checked="" type="checkbox"/>	50.000000M	100.000000M	Both	100.000k	1	100.000k	30.000k	<input checked="" type="checkbox"/>	Rel
F	<input checked="" type="checkbox"/>	100.000000M	150.000000M	Both	100.000k	1	100.000k	30.000k	<input checked="" type="checkbox"/>	Rel

Expanded display of Offsets & Limits Table

Setting	Description
Buttons	
Expand	Displays the Offsets & Limits Table in a new, resizable window.
Reset Layout	You can reorder columns in the Offsets & Limits Table by dragging the columns to a new position. Clicking Reset Layout returns the column order to the factory default order.
Load	Click to load a saved Offsets & Limits table from a file.
Save As	Click to save the current Offsets & Limits table to a file.
Done	When the table is expanded, click Done when you have finished editing the table to save your changes and close the expanded table display.
Table columns	
On	Specifies whether or not measurements are taken in the specified offset.
Start (Hz)	Start Frequency of the selected offset.
Stop (Hz)	Stop Frequency of the selected offset.
Side	Specifies whether the specified range appears on both side of the carrier frequency or just one side (left or right).
RBW (Hz)	Specifies the RBW for the selected range.
n (RBWS)	An integer value that specifies how many times to multiply the RBW to set the Filter bandwidth.
Filter BW (n x RBW)	Displays the Filter BW. Filter BW is the equivalent BW of each point in the offset. When $n > 1$, an integration technique is used to achieve the Filter BW using narrower RBWs. For most SEM measurements, this value is set to 1. The 3GPP standard suggests n greater than 1.
VBW (Hz)	Adjusts the VBW (Video Bandwidth) value. VBW Maximum: RBW current value; VBW Minimum: 1/10,000 RBW setting.
VBW On	Specifies whether the VBW filter is applied.
Mask	Select the type of limits used for Pass/Fail testing. Signal excursions that exceed the mask settings are considered violations. The available choices are shown below.
Abs Start (dBm)	Specifies the mask level at the inner edge of the selected offset.
Abs Stop (dBm)	Specifies the mask level at the outer edge of the selected offset.
Abs Same	Specifies whether the value for the inner and outer edges of the offset must be the same value. When enabled, the Abs Stop cell is grayed-out and set to the value of the Abs Start cell.
Rel Start (dBm)	Specifies the mask level for the Relative mask at the inner edge of the selected offset.
Rel Stop (dBm)	Specifies the mask level for the Relative mask at the outer edge of the selected offset.
Rel Same	Specifies whether the inner and outer edges of the offset must be the same value. When enabled, the Rel Stop cell is grayed-out and its value is set to the value of the Rel Start cell.

Scale Tab - SEM

Use the Scale tab to change the vertical and horizontal scale settings. Changing the scale settings changes how the trace appears on the display. In effect, these controls operate like pan and zoom controls.



Setting	Description
Vertical	Controls the vertical position and scale of the trace display.
Scale	Changes the vertical scale units.
Position	Adjusts the reference level away from top of the graph.
Autoscale	Resets the scale of the vertical axis to contain the complete trace.
Horizontal	Controls the span of the trace display and position of the trace.
Scale	Specifies the frequency range displayed in the graph
Position	Specifies the frequency shown at the center of the graph.
Autoscale	Resets the scale of the horizontal axis to optimize the display of the trace.
Reset Scale	Resets all settings to their default values.

Prefs Tab - SEM

The Prefs tab enables you to change parameters of the measurement display. The parameters available on the Prefs tab vary depending on the selected display, but include such items as enabling/disabling Marker Readout and switching the Graticule display on/off. Some parameters appear with most displays while others appear with only one display.

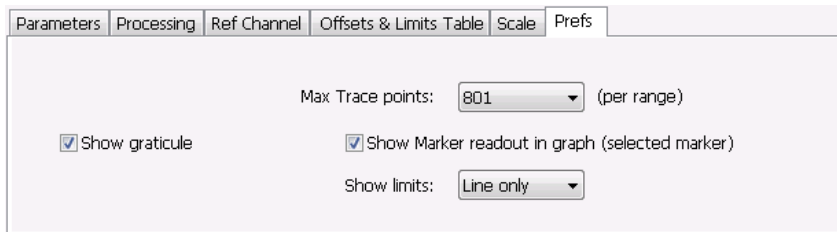

Setting	Description
Show graticule	Controls the vertical position and scale of the trace display.
Max Trace points (per range)	When the spectrum analysis produces more than the selected maximum number of points, the method specified in Detection control is used to decimate the result. This setting applies to both the Reference channel and offsets.
Show Marker readout in graph	Adjusts the reference level away from top of the graph.
Show limits	Controls the appearance of mask limits in the graph.
Shaded	Shows limits using a shaded area. Green shading is used to identify Absolute limits. Blue shading is used to indicate Relative limits.
Line only	Shows limits using only a line. A green line is used to identify Absolute limits. A blue line is used to indicate Relative limits.
None	No lines or shading are used to indicate limits in the graph. Violations of the mask are still identified by red shading.

RF Measurements Shared Measurement Settings

The control panel tabs in this section are shared by multiple displays in the RF Measurement folder (Setup > Displays). With few exceptions, each display maintains separate values for each of the controls on these tabs. For example, Scale values are independent for each of the displays.

Common controls for RF measurement displays

Settings tab	Description
Freq & RBW (see page 173)	Allows you to specify the Center Frequency, Step size and RBW.
Traces (see page 174)	Specifies trace parameters such as detection method and whether smoothing is enabled. Traces can also be saved and loaded for reference from this tab.
Scale (see page 177)	Specify vertical and horizontal scale settings.
Prefs (see page 110)	Specify appearance features of the graph area.

Freq & RBW Tab

The Freq & RBW tab specifies frequency parameters for some of the RF Measurements displays.

The screenshot shows the 'Freq & RBW' tab selected in a software interface. The settings are as follows:

- Meas Freq: 1.00000 GHz
- Step: 2.0000 MHz
- RBW: 30.000 kHz
- Auto:
- VBW:

Setting	Description
Meas Freq	Specifies the measurement frequency.
Step	The Step control sets the increment/decrement size for the adjustment of the center frequency. If Auto is enabled, the analyzer will adjust the Step size as required.
RBW	Select Auto or Manual. Adjusts the RBW for the entire measurement. This setting is Independent of the Spectrum view's RBW setting.
VBW	Adjusts the VBW (Video Bandwidth) value.

NOTE. While the measurement frequency and step settings on this control tab are shared between ACPR, MCPR and Occupied Bandwidth, the RBW setting is not shared. The RBW setting is unique for each measurement.

VBW

The VBW setting enables/disables the Video Bandwidth filter. VBW is used in traditional swept analyzers to reduce the effect of noise on the displayed signal. The VBW algorithm in the analyzer emulates the VBW filters of traditional swept analyzers.

The maximum VBW value is 10 times the current RBW setting. The minimum VBW value is 1/10,000 of the RBW setting.

NOTE. If you are following a procedure that says to "set VBW to three times the RBW value or greater", it means that the test should be conducted with no VBW effects. In the SignalVu software, this condition is met by disabling the VBW function.

Traces Tab

The Traces tab enables you to select traces for display. You can choose to display live traces and/or recalled traces. The [Trace tab \(see page 157\)](#) for Settling Time displays is described in the Settling Time controls section.

NOTE. Not all RF Measurements support multiple traces and/or save and recall of traces.

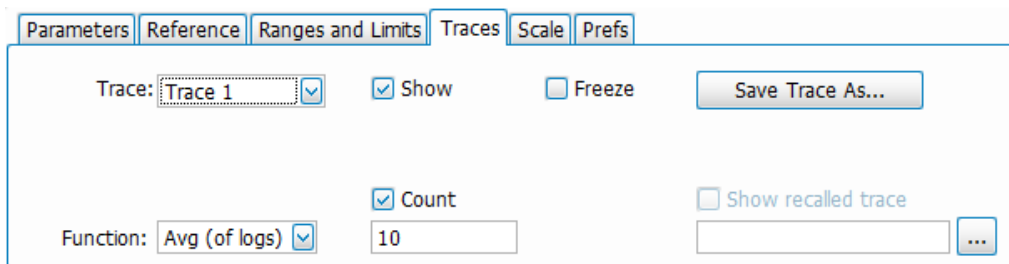

Setting	Description
Trace	Selects a trace for display. CCDF display: Choices are Trace 1, 2, and Gaussian. Trace 1 and 2 can be recalled. Spurious display: Choices are Trace 1, 2, 3, 4, and Math trace. All traces can be recalled. Math trace is computed for all ranges.
Show	Shows / hides the selected trace.
Freeze	Halts updates to the selected trace.
Save Trace As	Saves the selected trace to a file for later recall and analysis.
Show recalled trace	Used to select a saved trace for display. When a trace is recalled, controls such as show, freeze, and function will be disabled.
Function	Selects the trace processing method (Spurious display only). Possible settings are: Normal, Average (VRMS), Avg (of logs), and Max Hold.

Trace processing (Function)

The trace can be processed to display in different ways. The Function setting controls trace processing.

- **Max Hold** - Displays the maximum value in the trace record for each display point. Each new trace display point is compared to the previous maximum value and the greater value is retained for display and subsequent comparisons.
- **Normal** - Displays the trace record for each display point without additional processing.

- **Avg (VRMS)** [Average V_{RMS}] – Multiple traces are averaged together to generate the displayed trace, which will contain just one vertical value for each underlying frequency data point. Once the specified number of traces have been acquired and averaged to generate the displayed trace, additional traces contribute to the running average, except in Single Sequence run mode. In the case of Single Sequence, the instrument stops running after the specified number of traces have been averaged together. The Number of Traces setting specifies how many traces are averaged. The averaging is performed on the linear (Voltage) values, resulting in the correct RMS average).
- **Avg (of logs)** – This is a trace function used to emulate legacy spectrum analyzer results and for the specification of displayed average noise level. In older swept analyzers, a voltage envelope detector is used in the process of measuring signal level, and the result is then converted to Watts and then to dBm. Averaging is then applied to the resultant traces.

For CW signals, this method results in an accurate power measurement. However, with random noise and digitally modulated carriers, errors result from this 'average of logs' method. For random noise, the average of logs methods results in power levels -2.51 dB lower than that measured with a power meter, or with a spectrum analyzer that measures the rms value of a signal, and performs averaging on the calculated power in Watts and not dBm or other log-power units.

This detector should be used when following a measurement procedure that specifies it, or when checking the Displayed Averaged Noise Level (DANL) of the instrument. The 'average of logs' detection and trace function is used for DANL specification to provide similar results to other spectrum/signal analyzers for comparison purposes. Use of the Average of Logs method of measurement is not recommended for digitally modulated carriers, as power measurement errors will occur.

NOTE. *The Detection setting does not affect the trace until the spectrum length is longer than the Auto setting.*

Saving Traces

To save a trace for later analysis:

1. Select the **Save Trace As** button. This displays the Save As dialog box.
2. Navigate to the desired folder or use the default.
3. Type a name for the saved trace and click **Save**.

Recalling Traces

You can recall a previously saved trace for analysis or comparison to a live trace.

To select a trace for recall:

1. Select the trace into which the recalled trace will be loaded, from the Trace drop-down list.
2. Check the **Show** check box.
3. Click the ... button to display the Open dialog box.

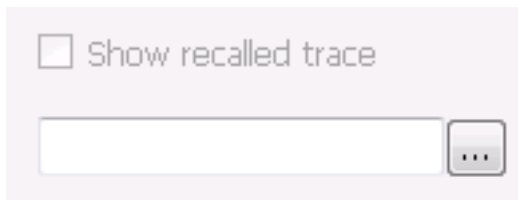

1. Navigate to the desired file and click **Open**.
2. Check the **Show Recalled Trace** check box.
3. Verify that the trace's **Show** check box is selected (either on this tab or next to the drop-down list located at the top-left corner of the graph).

Gaussian Trace (applies only to CCDF)

The Gaussian trace is a reference trace that you can compare your trace against. Because the Gaussian trace is for reference, there are no settings for the trace other than whether or not it is shown.

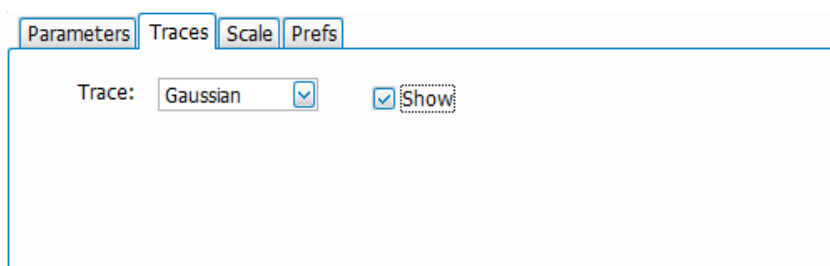

Scale Tab

The Scale tab allows you to change the vertical and horizontal scale settings. Changing the scale settings changes how the trace appears on the display but does not change control settings such as Center Frequency. Parameters on this tab may vary depending on the selected display.

Setting	Description
Vertical	Controls the vertical position and scale of the trace display.
Scale	Changes the vertical scale units. This is only accessible when the vertical units are set to dBm.
Position	Adjusts the level shown at the center of the graph.
Autoscale	Resets the scale of the vertical axis to contain the complete trace.
Rest Scale	Resets all settings to their default values.
Horizontal	Controls the span of the trace display and position of the trace.
Scale (Start)	Allows you to, in effect, change the span.
Position (Stop)	Adjusts the position of the acquisition record shown at the left edge of the graph.
Autoscale	Resets the scale of the horizontal axis to contain the complete trace.
Log (Spurious only)	Resets the display to show the frequency axis in a logarithmic scale.

Prefs Tab

The Prefs tab enables you to change parameters of the measurement display. The parameters available on the Prefs tab vary depending on the selected display, but include such items as enabling/disabling Marker Readout and switching the Graticule display on/off. Some parameters appear with most displays while others appear with only one display.

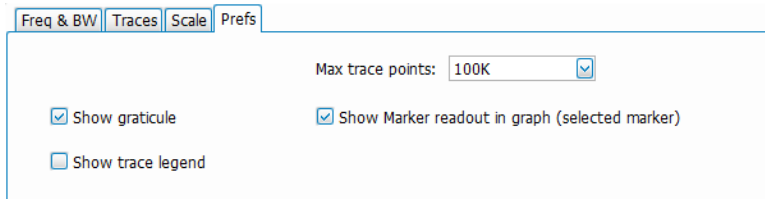

Setting	Description
Show graticule	Shows or hides the graticule.
Show Marker readout in graph (selected marker)	Shows or hides the readout for the selected marker in the graph area.
Max trace points	In general, time-domain traces can include up to 100K points and frequency-domain traces can include up to 10K points. When the analysis produces a results array longer than the selected trace length, the trace is decimated (using the method specified with the Detection control) to be equal to or less than the Max trace points setting (except when Max trace points is set to Never Decimate). This decimated (or undecimated) trace is what is used for marker measurements and for results export.
Settling Time decimal places (Frequency and Phase Settling Time displays only)	Specifies the number of decimal places shown in the results readout below the graph. This setting does not affect the precision of internal calculations.
Show trace legend (CCDF (Complementary Cumulative Distribution Function) display only)	Displays or hides the trace legend.

WLAN Overview

The WLAN Analysis option allows you to evaluate WLAN signals, performing standards based transmitter measurements in the time, frequency, and modulation domains. WLAN measurements can be made on signals defined by 802.11a/b/g/j/n/p (standard IEEE 802.11-2012) and 802.11ac (draft IEEE P802.11ac-D4.0 or later). User controls allow you to modify signal parameters for analysis of signals. The analysis results give multiple views of WLAN signal characteristics to allow the diagnosis of signal imperfections and impairments quickly and easily. Display controls allow you to selectively display the analysis results to help locate trouble-spots in the signal.

WLAN Standards

The following options support the given standards:

- **Option SV23:** Supports IEEE 802.11a, g, j, and p OFDM signals and 802.11b DSSS/CCK signals
- **Option SV24:** Supports IEEE 802.11n signals with bandwidths of 20 MHz and 40 MHz
- **Option SV25:** Supports IEEE 802.11ac signals with bandwidths of 20, 40, 80, and 160 MHz

WLAN Standards Presets

The **Standards Presets** button located on the WLAN Settings Control Panel allows you to recall preconfigured displays for the standards and bandwidths that you select. You can also access these presets from **Presets** on the display menu bar. You can read more information about the [Standards Presets \(see page 13\)](#).

The following table shows the center frequency and displays that are automatically loaded for each of the listed standards and bandwidths. SEM masks are also loaded and are explained [here \(see page 311\)](#).

Table 1: WLAN presets standards, bandwidths, center frequencies, and displays

Standard	Bandwidth (MHz)	Center frequency (GHz)	Displays loaded
802.11a	20	5.18	SEM, Time Overview, WLAN Constellation, WLAN Summary
802.11g	20	2.412	
802.11j	10	5.18	
	20		
802.11p	5	5.8	
	10		
	20		
802.11n	20	2.412	
	40		
802.11ac	20	5.18	
	40	5.19	
	80	5.21	
	160	5.25	
802.11b		2.412	

SEM mask parameters. The SEM wireless standard masks that are applied to the WLAN signal depend on the standard you select when you configure the preset. Once you select a standard and bandwidth, the application will automatically load the mask that best fits the signal for which the standard applies. All mask parameters are derived from IEEE standards and loaded for you. This provides you the assurance that you are evaluating the signal with the most appropriate mask.

WLAN Displays

The displays in WLAN Analysis (Setup > Displays > Measurements) are:

- [SEM \(see page 161\)](#)
- [WLAN Channel Response \(see page 181\)](#)
- [WLAN Constellation \(see page 184\)](#)
- [WLAN EVM \(see page 186\)](#)
- [WLAN Magnitude Error \(see page 188\)](#)
- [WLAN Phase Error \(see page 190\)](#)
- [WLAN Power versus Time \(see page 192\)](#)
- [WLAN Spectral Flatness \(see page 195\)](#)

- [WLAN Summary \(see page 197\)](#)
- [WLAN Symbol Table \(see page 202\)](#)

WLAN Channel Response Display

The WLAN Channel Response display plots the channel response (magnitude and phase) versus the subcarrier or frequency. Here, the channel refers to all sources of signal frequency response impairment up to the analyzer input, including the transmitter itself, as well as any transmission medium through which the signal travels between the transmitter and the analyzer.

NOTE. *WLAN Channel Response is only available for OFDM (non-802.11b) signals.*

To show the WLAN Channel Response display:

1. Recall an appropriate acquisition data file.
2. Press the **Displays** button or select **Setup > Displays**.
3. In the **Select Displays** dialog, select **WLAN Analysis** in the **Measurements** box.
4. In the Available displays box, double-click the **WLAN Chan Response** icon or select the icon and click **Add**. The WLAN Chan Response icon will appear in the **Selected displays** box and will no longer appear under Available displays.
5. Click **OK** to show the WLAN Chan Response display.
6. Set the Frequency appropriate for the signal.
7. Select **Setup > Settings** to display the control panel.
8. Select the Modulation Params tab. Set the Standard, Guard Interval, Subcarrier Spacing, and Bandwidth controls as appropriate for the input signal.

Elements of the Display

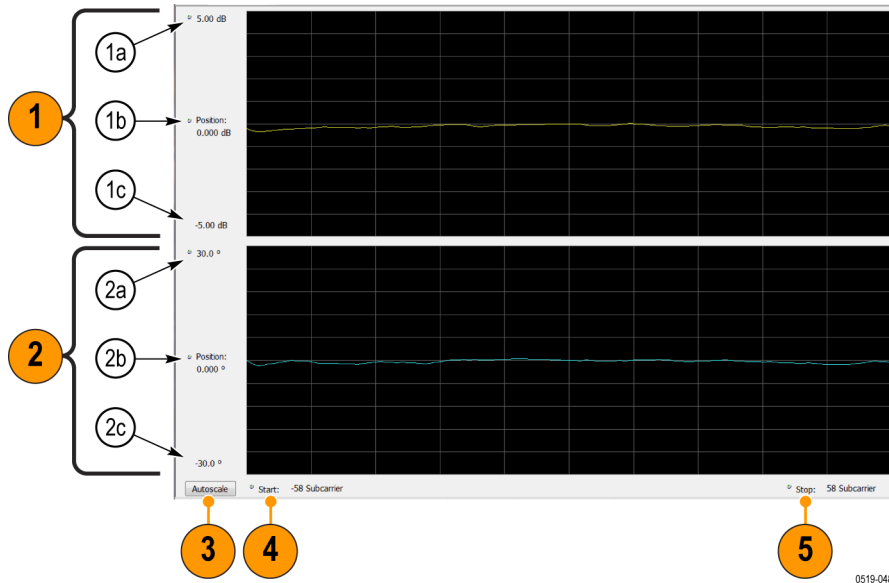

Item	Display element	Description
1	Magnitude graph (top graph)	
1a	Top of graph	Sets the level that appears at the top of the magnitude graph. This is only a visual control for panning the graph. The Reference Level is adjusted in the Toolbar and the Ampl control panel. By default, Vert Position = Ref Level.
1b	Position (dB)	Sets the vertical position value. The maximum value is 20.00 dB. The readout indicates the subcarrier (for non-b standards only) or frequency shown at the bottom of the display.
1c	Bottom of graph readout	Indicates the magnitude at the bottom of the top graph. This value changes with the dB and vertical Position settings.
2	Phase graph (bottom graph)	
2a	Top of graph	Sets the phase value indicated at the top of the graph. Since the Position value at the vertical center of this graph remains constant as the Top of Graph value is adjusted, the Vertical Scale increases as the Top of Graph value increases, which also affects the bottom of graph readout.
2b	Position (°)	Specifies the phase shown at the center of the graph display. Changing this value moves the trace up and down in the graph, which affects the Top of Graph and Bottom of Graph values as well.
2c	Bottom of bottom graph readout	Indicates the phase at the bottom of the bottom graph. This value changes with the Position setting.
3	Autoscale	Adjusts the Vertical and Horizontal scaling to optimize the trace display on screen.
4	Start (Position)	Shifts the trace left or right in the graph. The readout indicates the subcarrier (for non-b standards only) or frequency shown at the left edge of the display.
5	Stop (Scale)	Specifies the number of subcarriers (for non-b standards only) shown in the graph.

WLAN Channel Response Settings

The WLAN Channel Response Settings control panel provides access to settings that control parameters of the Channel Response Display.

Settings tab	Description
Modulation Params (see page 205)	Specifies the input signal standard and additional user-settable signal parameters.
Analysis Params (see page 206)	Specifies parameters used by the instrument to analyze the input signal.
Data Range Tab (see page 208)	Specifies which symbols and subcarriers of the signal to display.
Analysis Time Tab (see page 209)	Specifies parameters that define the portion of the acquisition record that is used for analysis. Also allows you to specify the time units (Symbols or Seconds) for WLAN Analysis displays.

Settings tab	Description
Traces Tab (see page 210)	Enables you to select from magnitude or phase trace, save a trace, and recall an trace
Scale Tab (see page 211)	Specifies the Zoom scale, and vertical and horizontal positions of the display.
Prefs Tab (see page 214)	Specifies the units of the display and whether elements of the graphs are displayed.

WLAN Constellation Display

The WLAN Constellation Display shows the WLAN signal modulation amplitude and phase in I (horizontal) versus Q (vertical) form. For multicarrier WLAN OFDM signals, the points show all data symbol subcarriers' modulation. For single-carrier 802.11b, each point corresponds to a single modulated chip.

To show the WLAN Constellation display:

1. Recall an appropriate acquisition data file.
2. Press the **Displays** button or select **Setup > Displays**.
3. In the **Select Displays** dialog, select **WLAN Constellation** in the **Measurements** box.
4. In the Available displays box, double-click the **WLAN Constellation** icon or select the icon and click **Add**. The WLAN Constellation icon will appear in the **Selected displays** box and will no longer appear under Available displays.
5. Click **OK** to show the WLAN Constellation display.
6. Set the **Frequency** appropriate for the signal.
7. Select **Setup > Settings** to display the control panel.
8. Select the **Modulation Params** tab. Set the Standard, Guard Interval, Channel Bandwidth, and Subcarrier Spacing controls as appropriate for the input signal.

Elements of the Display

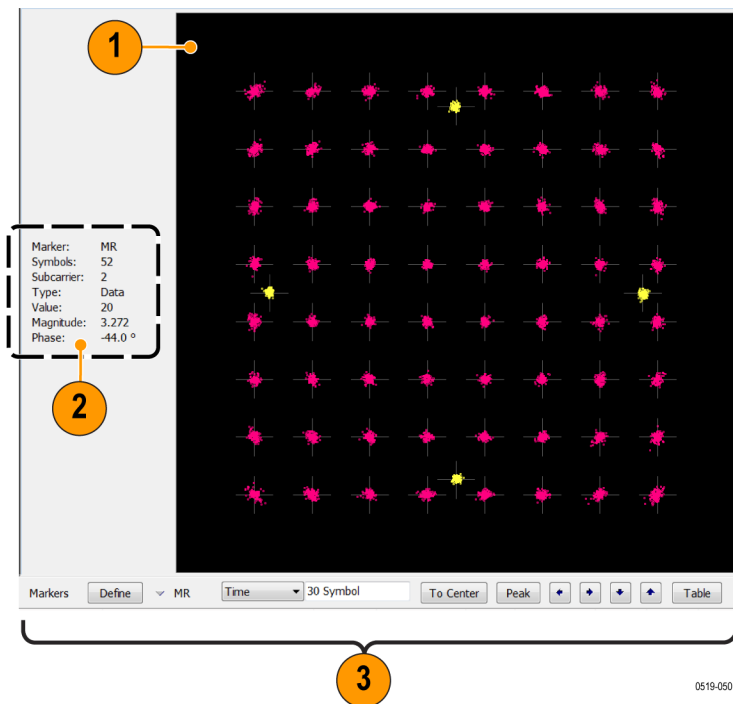

Item	Display element	Description
1	Plot	Constellation graph.
2	Marker readout	If markers are enabled, the marker readout shows the selected Marker, Symbol, Subcarrier, Type, Value, Magnitude, and Phase for the symbol at the marker location. Located to the left of the constellation plot or below it, depending on the size of the window.
3	Marker controls	Define and position markers.

WLAN Constellation Settings

Main menu bar: Setup > Settings

Favorites toolbar: 

The WLAN Constellation Settings control panel provides access to settings that control parameters of the Constellation Display.

Settings tab	Description
Modulation Params (see page 205)	Specifies the input signal standard and additional user-settable signal parameters.
Analysis Params (see page 206)	Specifies parameters used by the instrument to analyze the input signal.
Data Range (see page 208)	Specifies which symbols and subcarriers of the signal to display.
Analysis Time Tab (see page 209)	Specifies parameters that define the portion of the acquisition record that is used for analysis. Also allows you to specify the Units (Symbols or Seconds) for WLAN Analysis displays.
Trace Tab (see page 210)	Enables you to freeze the display or hide the measurement or average trace.
Scale Tab (see page 211)	Specifies the Zoom scale, and vertical and horizontal positions of the display.
Prefs Tab (see page 214)	Specifies the units of the display and whether elements of the graphs are displayed.

WLAN EVM Display

The WLAN EVM display shows the data symbols' individual subcarrier Error Vector Magnitude values versus symbol interval (time) and subcarrier (frequency).

NOTE. For 802.11b analysis, the subcarrier graph is not displayed.

To show the WLAN EVM display:

1. Recall an appropriate acquisition data file.
2. Press the **Displays** button or select **Setup > Displays**.
3. In the **Select Displays** dialog, select **WLAN EVM** in the **Measurements** box.
4. In the Available displays box, double-click the **WLAN EVM** icon or select the icon and click **Add**. The WLAN EVM icon will appear in the **Selected displays** box and will no longer appear under Available displays.
5. Click **OK** to show the WLAN EVM display.
6. Set the **Frequency** appropriate for the signal.
7. Select **Setup > Settings** to display the control panel.
8. Select the **Modulation Params** tab. Set the Standard as appropriate. Set the Standard, Guard Interval, Channel Bandwidth, and Subcarrier Spacing controls as appropriate for the input signal.

Elements of the Display

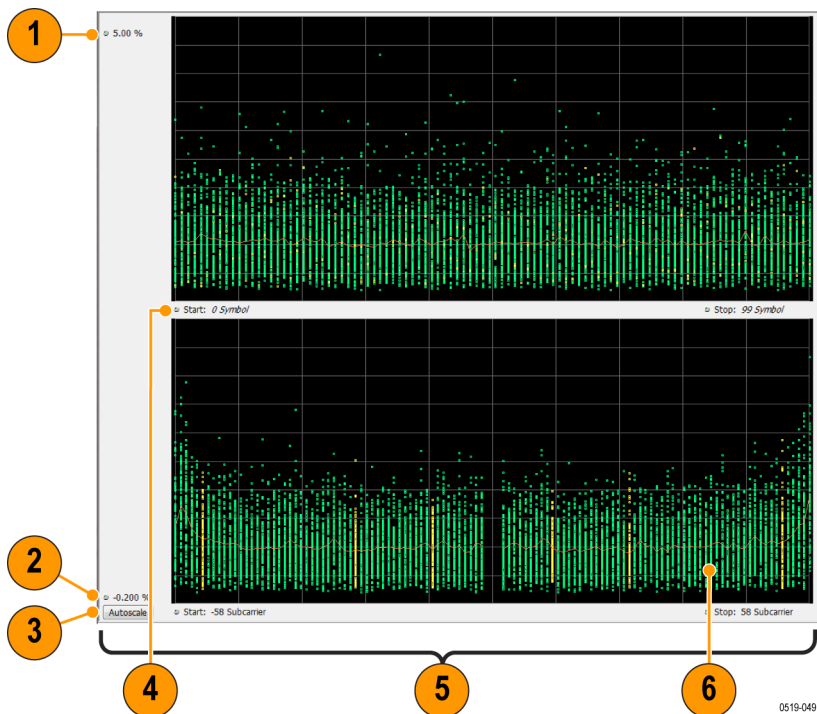

Item	Display element	Description
1	Top of graph	Sets the EVM value that appears at the top of the graph. This is only a visual control for panning the graph.
2	Bottom of graph	Sets the EVM value that appears at the bottom of the graph. This is only a visual control for panning the graph.
3	Autoscale	Adjusts the vertical and horizontal settings to provide the best display.
4	Start (Position)	Specifies the horizontal position of the trace on the graph display.
5	Stop (Scale)	Adjusts the horizontal range of the graph. By decreasing the scale, the graph essentially becomes a window that you can move over the analysis results by adjusting the position.

WLAN EVM Settings

Main menu bar: Setup > Settings

Favorites toolbar: 

The settings for the WLAN EVM display are shown in the following table.

Settings tab	Description
Modulation Params (see page 205)	Specifies the type of modulation used for the input signal and other parameters.
Analysis Params (see page 206)	Specifies parameters used by the instrument to analyze the input signal.
Data Range (see page 208)	Specifies which symbols and subcarriers of the signal to display.
Analysis Time (see page 209)	Specifies parameters that define the portion of the acquisition record that is used for analysis. Also allows you to specify the Units (Symbols or Seconds) for WLAN Analysis displays.
Trace (see page 210)	Enables you to freeze the display or hide the measurement or average trace.
Scale (see page 211)	Specifies the vertical, subcarrier (for non-b standards only) and symbols scale and position settings.
Prefs (see page 214)	Specifies the units of the display and whether elements of the graphs are displayed.

WLAN Magnitude Error Display

The WLAN Magnitude Error display shows the data symbols' individual subcarrier Magnitude Error values versus symbol interval (time) and subcarrier (frequency).

NOTE. For 802.11b analysis, the subcarrier graph is not displayed.

To show the WLAN Magnitude Error display:

1. Recall an appropriate acquisition data file.
2. Press the **Displays** button or select **Setup > Displays**.
3. In the **Select Displays** dialog, select **WLAN Analysis** in the **Measurements** box.
4. In the Available displays box, double-click the **WLAN Mag Error** icon or select the icon and click **Add**. The WLAN Mag Error icon will appear in the **Selected displays** box and will no longer appear under Available displays.
5. Click **OK** to show the WLAN Mag Error display.
6. Set the **Frequency** appropriate for the signal.
7. Select **Setup > Settings** to display the control panel.
8. Select the **Modulation Params** tab. Set the Standard, Guard Interval and Spacing and Bandwidth controls as appropriate for the input signal.

Elements of the Display

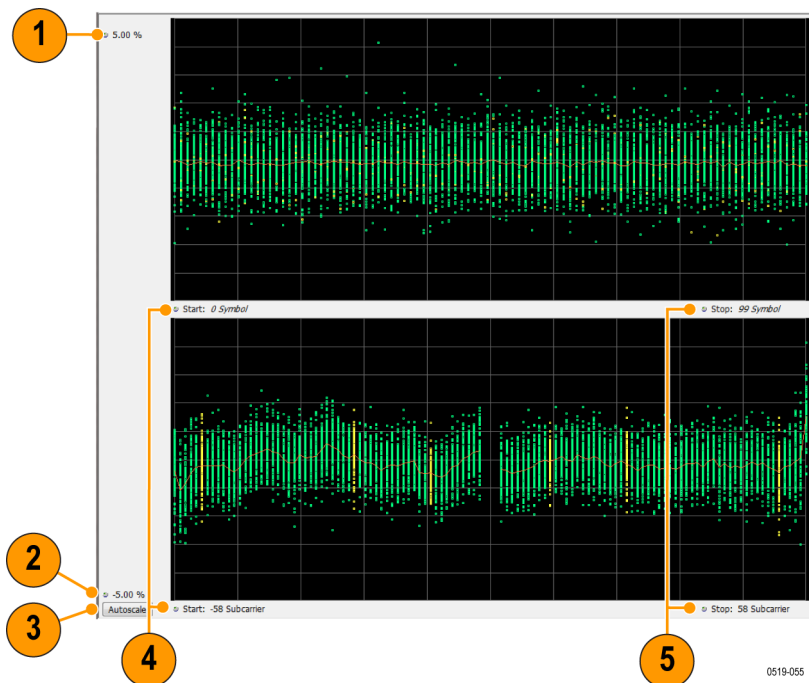

Item	Display element	Description
1	Top of graph	Sets the Magnitude Error value that appears at the top of the graph. This is only a visual control for panning the graph.
2	Bottom of graph	Sets the Magnitude Error value that appears at the bottom of the graph. This is only a visual control for panning the graph.
3	Autoscale	Adjusts the vertical and horizontal settings to provide the best display.
4	Pos	Specifies the horizontal position of the trace on the graph display.
5	Scale	Adjusts the horizontal range of the graph. By decreasing the scale, the graph essentially becomes a window that you can move over the analysis results by adjusting the position.

WLAN Magnitude Error Settings

Main menu bar: Setup > Settings

Favorites toolbar: 

The settings for the WLAN Mag Error display are shown in the following table.

Settings tab	Description
Modulation Params (see page 205)	Specifies the type of modulation used for the input signal and other parameters.
Analysis Params (see page 206)	Specifies parameters used by the instrument to analyze the input signal.
Data Range (see page 208)	Specifies which symbols and subcarriers of the signal to display.
Analysis Time Tab (see page 209)	Specifies parameters that define the portion of the acquisition record that is used for analysis. Also allows you to specify the Units (Symbols or Seconds) for WLAN Analysis displays.
Trace (see page 210)	Enables you to display or hide the measurement or average trace.
Scale Tab (see page 211)	Specifies the vertical, subcarrier (for non-b standards only), and symbols scale and position settings.
Prefs Tab (see page 214)	Specifies the units of the display and whether elements of the graphs are displayed.

WLAN Phase Error Display

The WLAN Phase Error display shows the data symbols' individual subcarrier Phase Error values versus symbol interval (time) and subcarrier (frequency).

NOTE. For 802.11b analysis, the subcarrier graph is not displayed.

To show the WLAN Phase Error display:

1. Recall an appropriate acquisition data file.
2. Press the **Displays** button or select **Setup > Displays**.
3. In the **Select Displays** dialog, select **WLAN Analysis** in the **Measurements** box.
4. In the Available displays box, double-click the **WLAN Phase Error** icon or select the icon and click **Add**. The WLAN Phase Error icon will appear in the **Selected displays** box and will no longer appear under Available displays.
5. Click **OK** to show the WLAN Phase Error display.
6. Set the **Frequency** appropriate for the signal.
7. Select **Setup > Settings** to display the control panel.
8. Select the **Modulation Params** tab. Set the Standard, Guard Interval and Spacing and Bandwidth controls as appropriate for the input signal.

Elements of the Display

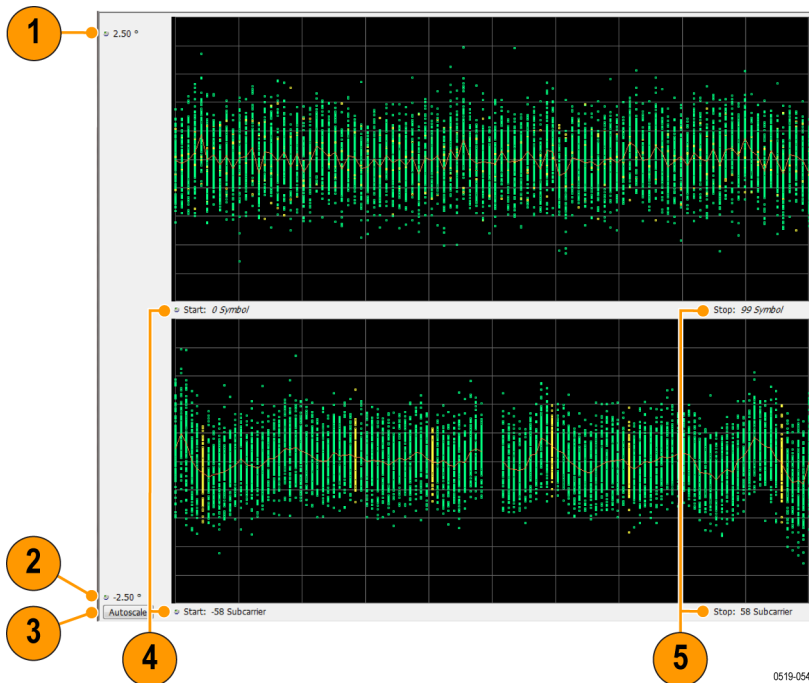

Item	Display element	Description
1	Top of graph	Sets the Phase Error value that appears at the top of the graph. This is only a visual control for panning the graph.
2	Bottom of graph	Sets the Phase Error value that appears at the bottom of the graph. This is only a visual control for panning the graph.
3	Autoscale	Adjusts the vertical and horizontal settings to provide the best display.
4	Pos	Specifies the horizontal position of the trace on the graph display.
5	Scale	Adjusts the horizontal range of the graph. By decreasing the scale, the graph essentially becomes a window that you can move over the analysis results by adjusting the position.

WLAN Phase Error Settings

Main menu bar: Setup > Settings

Favorites toolbar: 

The settings for the WLAN Phase Error display are shown in the following table.

Settings tab	Description
Modulation Params (see page 205)	Specifies the type of modulation used for the input signal and other parameters.
Analysis Params (see page 206)	Specifies parameters used by the instrument to analyze the input signal.
Data Range (see page 208)	Specifies which symbols and subcarriers of the signal to display.
Analysis Time Tab (see page 209)	Specifies parameters that define the portion of the acquisition record that is used for analysis. Also allows you to specify the Units (Symbols or Seconds) for WLAN Analysis displays.
Trace (see page 210)	Enables you to display or hide the measurement or average trace.
Scale Tab (see page 211)	Specifies the vertical, subcarrier (for non-b standards only), and symbols scale and position settings.
Prefs Tab (see page 214)	Specifies the units of the display and whether elements of the graphs are displayed.

WLAN Power vs Time Display

The WLAN Power vs Time display shows the signal power amplitude versus time. For 802.11b signals, the packet Power-On and Power-Down ramp times are also measured.

To show the WLAN Power vs Time display:

1. Recall an appropriate acquisition data file.
2. Press the **Displays** button or select **Setup > Displays**.
3. In the **Select Displays** dialog, select **WLAN Analysis** in the **Measurements** box.
4. In the Available displays box, double-click the **WLAN Power vs Time** icon or select the icon and click **Add**. The WLAN Power vs Time icon will appear in the **Selected displays** box and will no longer appear under Available displays.
5. Click **OK** to show the WLAN Power vs Time display.
6. Set the **Frequency** appropriate for the signal.
7. Select **Setup > Settings** to display the control panel.
8. Select the **Modulation Params** tab. Set the Standard, Guard Interval and Spacing and Bandwidth controls as appropriate for the input signal.

Elements of the Display

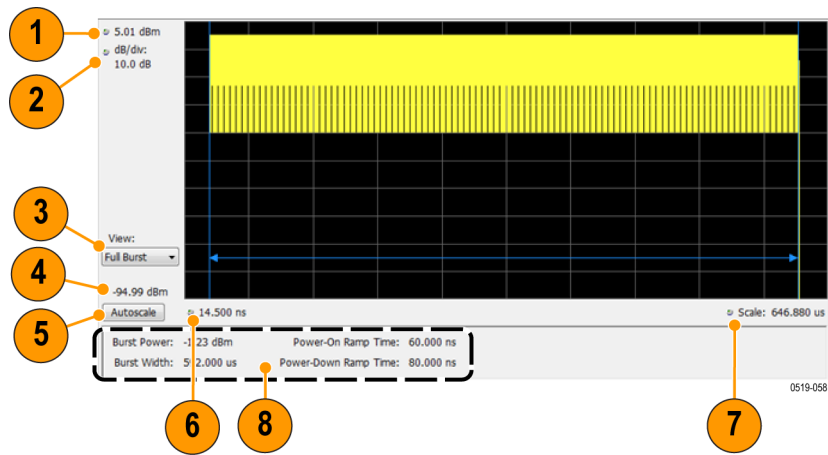

Item	Display element	Description
1	Top of graph, first setting	Sets the Power level that appears at the top of the graph, in dBm. This is only a visual control for panning the graph.
(not shown)	Units	Sets the global amplitude units for all the views in the analysis window. This will change the amplitude selection in the Units tab of the Amplitude control panel.
2	Top of graph, second setting	Sets the vertical Scale of the graphs, in dB/div. This is only a visual control for panning the graph.
3	View	<p>Selects the specific view of the packet burst within the display:</p> <ul style="list-style-type: none"> - Full Burst displays the entire packet, with vertical lines indicating length of the packet - Rising Edge zooms the display into the interval around the packet rising edge, with vertical lines indicating the 10% to 90% Power-On Ramp time - Falling Edge zooms the display into the interval around the packet falling edge, with vertical lines indicating the 90% to 10% Power-Down Ramp time
4	Bottom of graph readout	Shows the Power level at the bottom of the graph in dBm.
5	Autoscale	Adjusts the vertical and horizontal settings to provide the best display.
6	Bottom of graph, left side	Sets the starting time of the graph in seconds
7	Bottom of graph, right side	Sets the scale (width) of the graph in seconds
8	Table below graph	<ul style="list-style-type: none"> - Burst Power: Average power of the burst packet, in dBm - Burst Width: Measured time width of the burst packet from Power-On to Power-Down (or end of waveform, if that occurs before Power-Down), in seconds <p>NOTE. <i>Power-On Ramp Time and Power-Down Ramp Time values are only available for 802.11b analysis.</i></p> <ul style="list-style-type: none"> - Power-On Ramp Time: Time interval for signal level to increase from 10% to 90% of maximum packet power, in seconds - Power-Down Ramp Time: Time interval for signal level to decrease from 90% to 10% of maximum packet power, in seconds. This value is not available if the analysis record does not include the packet power-down portion.

WLAN Power vs Time Settings

Main menu bar: Setup > Settings

Favorites toolbar: 

The settings for the WLAN Power vs Time display are shown in the following table.

Settings tab	Description
Modulation Params (see page 205)	Specifies the type of modulation used for the input signal and other parameters.
Analysis Params (see page 206)	Specifies parameters used by the instrument to analyze the input signal.
Data Range (see page 208)	Specifies which symbols and subcarriers of the signal to display.
Analysis Time (see page 209)	Specifies parameters that define the portion of the acquisition record that is used for analysis. Also allows you to specify the Units (Symbols or Seconds) for WLAN Analysis displays.
Scale (see page 211)	Specifies the vertical, subcarrier (for non-b standards only), and symbols scale and position settings.
Prefs (see page 214)	Specifies the units of the display and whether elements of the graphs are displayed.

WLAN Spectral Flatness Display

The WLAN Spectral Flatness display shows the average power levels of subcarriers across the signal bandwidth and indicates if they remain within the limits defined for a particular standard.

The averaged subcarrier level is shown as a line on the display, while the individual subcarrier levels are shown as points. The Pass or Fail result indicates whether the average line remains between the upper and lower limit mask boundaries.

NOTE. *WLAN Spectral Flatness is only available for OFDM (non-802.11b) signals.*

To show the WLAN Spectral Flatness display:

1. Recall an appropriate acquisition data file.
2. Press the **Displays** button or select **Setup > Displays**.
3. In the **Select Displays** dialog, select **WLAN Analysis** in the **Measurements** box.
4. In the Available displays box, double-click the **WLAN Flatness** icon or select the icon and click **Add**. The WLAN Flatness icon will appear in the **Selected displays** box and will no longer appear under Available displays.
5. Click **OK** to show the WLAN Flatness display.
6. Set the **Frequency** appropriate for the signal.
7. Select **Setup > Settings** to display the control panel.
8. Select the **Modulation Params** tab. Set the Standard, Guard Interval, Subcarrier Spacing, and Channel Bandwidth controls as appropriate for the input signal.

Elements of the Display

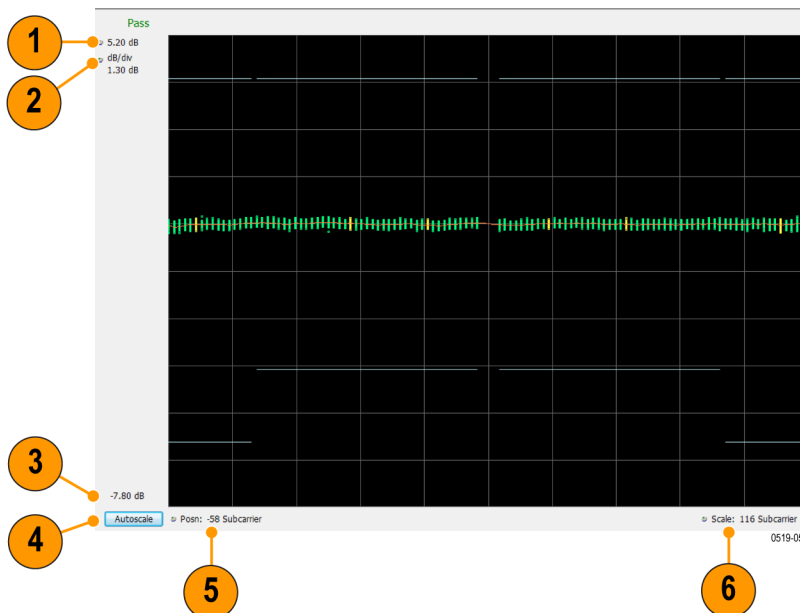

Item	Display element	Description
1	Top of graph, first setting	Sets the Flatness value that appears at the top of the graph in dB. This is only a visual control for panning the graph.
2	Top of graph, second setting	Sets the lower range of the Flatness value that appears at the top of the graph in dB/div. This is only a visual control for panning the graph.
3	Bottom of graph	Shows the Flatness value set at the bottom of the graph.
4	Autoscale	Adjusts the vertical and horizontal settings to provide the best display.
5	Posn	Specifies the horizontal position of the trace on the graph display.
6	Scale	Adjusts the horizontal range of the graph. By decreasing the scale, the graph essentially becomes a window that you can move over the analysis results by adjusting the position.

WLAN Spectral Flatness Settings

Main menu bar: Setup > Settings

Favorites toolbar: 

The settings for the WLAN Spectral Flatness display are shown in the following table.

Settings tab	Description
Modulation Params (see page 205)	Specifies the type of modulation used for the input signal and other parameters.
Analysis Params (see page 206)	Specifies parameters used by the instrument to analyze the input signal.
Data Range (see page 208)	Specifies which symbols and subcarriers of the signal to display.
Analysis Time Tab (see page 209)	Specifies parameters that define the portion of the acquisition record that is used for analysis. NOTE. <i>The Units control on this tab only affects the Analysis Length (AFAIK). Use the Units control in the Prefs tab to affect the displays.</i>
Trace (see page 210)	Enables you to display or hide the measurement or average trace.
Scale Tab (see page 211)	Specifies the vertical, subcarrier (for non-b standards only), and symbols scale and position settings.
Prefs Tab (see page 214)	Specifies the units of the display and whether elements of the graphs are displayed.

WLAN Summary Display

The WLAN Summary display shows several measurements of WLAN signal quality. The summary display and its contents will vary by standard selected. Not all of the display contents are provided in this section.

To show the WLAN Summary display:

1. Recall an appropriate acquisition data file.
2. Press the **Displays** button or select **Setup > Displays**.
3. In the **Select Displays** dialog, select **WLAN Analysis** in the **Measurements** box.
4. In the Available displays box, double-click the **WLAN Summary** icon or select the icon and click **Add**. The WLAN Summary icon will appear in the **Selected displays** box and will no longer appear under Available displays.
5. Click **OK** to show the WLAN Summary display.
6. Set the **Frequency** appropriate for the signal.
7. Select **Setup > Settings** to display the control panel.
8. Select the **Modulation Params** tab. Set the Standard, Guard Interval and Spacing and Bandwidth controls as appropriate for the input signal.

WLAN Summary Display for 802.11a/g/j/p/n/ac Signals

Standard: 802.11n	Bandwidth: 40 MHz	Guard Interval: Auto from SIG	<input type="button" value="Clear"/>
--------------------------	--------------------------	--------------------------------------	--------------------------------------

Burst Power: -0.01 dBm	Peak-to-Average: 9.80 dB	L-SIG Data		Parity: Pass
Burst Index: 1	IQ Origin Offset: -82.25 dB	Rate 13	Reserved 0	
Frequency Error: -140.27 mHz	Common Pilot Error: 0.337 %	Length 312	Parity 1	
Symbol Clk Error: -0.070 ppm		Tail 0		

EVM			
	All	Pilots	Data
RMS	-39.91 dB	-40.40 dB	-39.89 dB
Peak	-27.33 dB	-31.09 dB	-27.33 dB
Pk@Sym/Sub	32 / 58	85 / 53	32 / 58
Avg RMS	-39.91 dB		
1 of 1 Bursts			
Max RMS	-39.91 dB		

HT-SIG Data			
		CRC: Pass	
MCS	0	CBW	1
Length	672	Smoothing	0
Not Sound	0	Reserved	1
Aggregation	0	STBC	0
FEC Coding	0	Short GI	0
Ness	0	CRC	1
Tail	0		

Packet Format: HT_MF	Data Modulation: BPSK
	Guard Interval: 1/4

	Symbols	EVM	Avg Power
L-STF	2	-44.57 dB	0.00 dBm
L-LTF	2	-40.02 dB	-0.01 dBm
L-SIG	1	-40.43 dB	-0.26 dBm
HT-SIG	2	-40.34 dB	-0.47 dBm
HT-STF	1	-44.08 dB	-0.01 dBm
HT-LTF	1	-42.43 dB	0.00 dBm
Data	100	-39.91 dB	0.01 dBm

Elements of the Display for 802.11a/g/j/p/n/ac Signals

Measurement	Description
Standard	Display of the standard selected on the Setup > Settings > Modulation Params tab.
Bandwidth	Display of the channel bandwidth selected on Setup > Settings > Modulation Parameters tab.
Burst Power	The average power of all symbols in the packet, including Preamble and Data segments.
Peak-to-Average	The ratio of the highest instantaneous signal power level to the average signal power.
Burst Index	The index of the analyzed packet within the analysis record.
IQ Origin Offset	The average magnitude of the DC subcarrier level relative to total signal power. It indicates the level of carrier feedthrough detected at the center (DC) subcarrier.
Frequency Error	The frequency difference between the measured carrier frequency of the signal and the measurement frequency setting.
Common Pilot Error	The RMS magnitude error of the pilots over all data symbols.
Symbol Clk Error	The symbol clock error in parts per million.
EVM	<p>The RMS and Peak values of the normalized subcarrier Error Vector Magnitude values. The normalized subcarrier EVM values are calculated as the difference between the detected received signal subcarrier constellation points and ideal reference points estimated by the instrument from the received signal. Values are reported in units of percent or dB. Peak values include the symbol and subcarrier location.</p> <p>RMS and Peak values are displayed for groupings of all subcarriers, Pilots only and Data only. Results are calculated over all Data symbols in the packet.</p> <p>Average RMS and Peak RMS values are accumulated over multiple packet analysis cycles. The Clear button on the display resets these values by clearing the result memory.</p>
Packet Format	Displays the packet format: AG, HT_MF, HT_GF, VHT.
Data Modulation	Displays the modulation used in the Data symbols: BPSK, QPSK, 16QAM, 64QAM, 256QAM.
Guard Interval	Displays the Guard Interval used by the Data symbols: 1/4, 1/8.
Symbols, EVM, Avg Power	Displays the type and number of symbols, EVM-RMS and average power of the Preamble and Data portions of the packet.
SIG Data L-SIG Data HT-SIG Data VHT-SIG Data	Displays the decimal values of the received packet SIGNAL, HT-SIGNAL and VHT-SIGNAL symbols' fields. The Pass/Fail result in each heading line indicates whether the calculated Parity or CRC value matches the received Parity or CRC value of the corresponding SIGNAL symbol grouping.

WLAN Summary Display for 802.11b Signals

Standard: 802.11b

Burst Power:	-1.22 dBm	Peak-to-Average:	1.50 dB
Burst Index:	1	IQ Origin Offset:	-39.12 dB
Frequency Error:	-2.34 Hz		

Packet Format: Auto Detect Clear

Header Data		CRC: Pass	
Signal	20	Service	0
Length	400	CRC	17735

EVM

	All	1k Chips
RMS	-39.12 dB	-39.02 dB
Peak	-30.29 dB	-30.32 dB
Pk @ Chip	2992	66
Avg RMS	-39.12 dB	
1 of 1 Bursts		
Max RMS	-39.12 dB	

Packet Format: DSSS 2M **Data Modulation:** DSSS 2M

	Chips	EVM	Avg Power
Preamble:	1584	-38.96 dB	-1.72 dBm
Header:	528	-39.06 dB	-1.23 dBm
Data:	4400	-39.19 dB	-1.23 dBm

Elements of the Display for 802.11b Signals

Measurement	Description
Standard	Display of the standard selected on the Setup > Settings > Modulation Parameters tab.
Burst Power	The average power of the entire packet.
Peak-to-Average	The ratio of the highest instantaneous packet signal power level to the average signal power.
Burst Index	The index of the analyzed packet within the analysis record.
IQ Origin Offset	The amount of power at the signal carrier frequency relative to the total power of the signal.
Frequency Error	The frequency difference between the measured carrier frequency of the signal and the measurement frequency setting.
EVM	<p>The RMS and Peak values of the normalized Error Vector Magnitudes taken at signal chip intervals. The normalized EVM values are calculated as the difference between the detected received signal constellation points and ideal reference points estimated by the instrument from the received signal. Values are reported in units of percent or dB. Peak values indicate the associated chip locations.</p> <p>RMS and Peak values are displayed for groupings of All chips, and the first 1000 (1k) chips.</p> <p>Average RMS and Peak RMS values are accumulated over multiple packet analysis cycles. The Clear button on the display resets these values by clearing the result memory.</p>
Packet Format	Displays the packet format: DSSS 1M, DSSS 2M, CCK 5.5M or CCK 11M.
Data Modulation	Displays the modulation used in the PSDU/Data packet segment.
Chips, EVM, Avg Power	Displays the number of chips, EVM-RMS and average power of the Preamble, Header and Data portions of the packet.
Header Data	Displays the decimal values of the received packet Header's Signal, Service, Length, and CRC fields. The CRC Pass/Fail result indicates if the received CRC value is equal to the CRC value computed from the received Signal, Service and Length values.

WLAN Summary Settings

Main menu bar: Setup > Settings

Favorites toolbar: 

The settings for the WLAN Summary display are shown in the following table.

Settings tab	Description
Modulation Params (see page 205)	Specifies the type of modulation used for the input signal and other parameters.
Analysis Params (see page 206)	Specifies parameters used by the instrument to analyze the input signal.
Data Range (see page 208)	Specifies which symbols and subcarriers of the signal to display.
Analysis Time (see page 209)	Specifies parameters that define the portion of the acquisition record that is used for analysis. Also allows you to specify the Units (Symbols or Seconds) for WLAN Analysis displays.
EVM (see page 213)	Specifies the EVM units (dB or %) and Max Bursts to Avg. The EVM is generally measured on symbol or chip instants and is usually measured after best-fit estimates of the frequency error and a fixed phase offset have been removed.
Prefs (see page 214)	Specifies the units of the display and whether elements of the graphs are displayed.

WLAN Symbol Table Display

The WLAN Symbol Table display shows decoded data values for each data symbol in the analyzed signal packet. For OFDM signals (all standards except 802.11b), results are presented with subcarrier (frequency) indices in the horizontal dimension and symbol (time) intervals in the vertical dimension. For 802.11b signals, the Preamble, Header, and Data (PSDU) symbol values are presented sequentially, with symbol indices in the left column.

To show the WLAN Symbol Table display:

1. Recall an appropriate acquisition data file.
2. Press the **Displays** button or select **Setup > Displays**.
3. In the **Select Displays** dialog, select **WLAN Analysis** in the **Measurements** box.
4. In the Available displays box, double-click the **WLAN Symb Table** icon or select the icon and click **Add**. The WLAN Symbol icon will appear in the **Selected displays** box and will no longer appear under Available displays.
5. Click **OK** to show the WLAN Symbol Table display.
6. Set the **Frequency** appropriate for the signal.
7. Select **Setup > Settings** to display the control panel.
8. Select the **Modulation Params** tab. Set the Standard, Guard Interval and Spacing and Bandwidth controls as appropriate for the input signal.

WLAN Symbol Table for OFDM signals

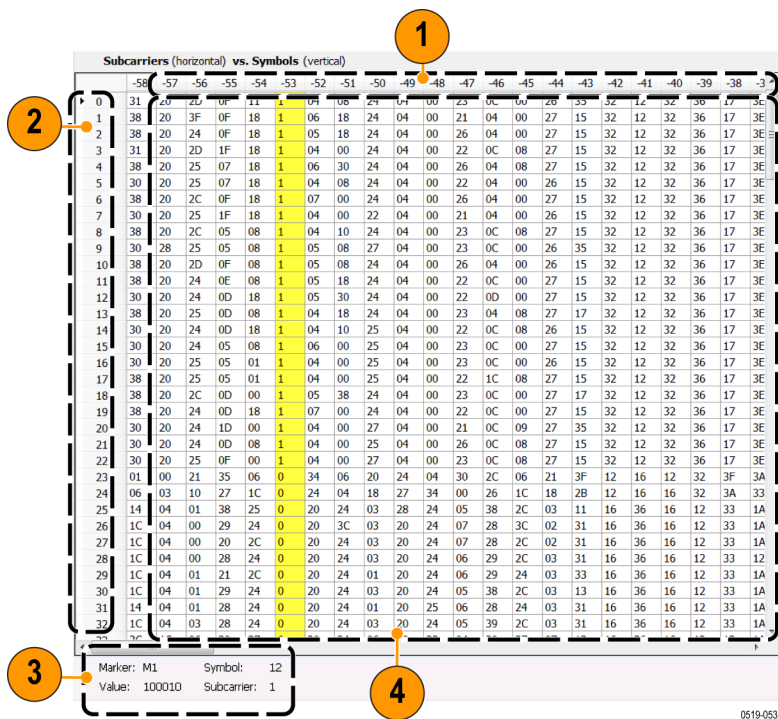

Item	Description
1	Subcarrier identifiers (OFDM only). Yellow column indicates Pilot subcarrier locations.
2	Symbol identifiers.
3	Subcarrier data values.
4	Marker readout when markers are enabled.

WLAN Symbol Table for 802.11b signals

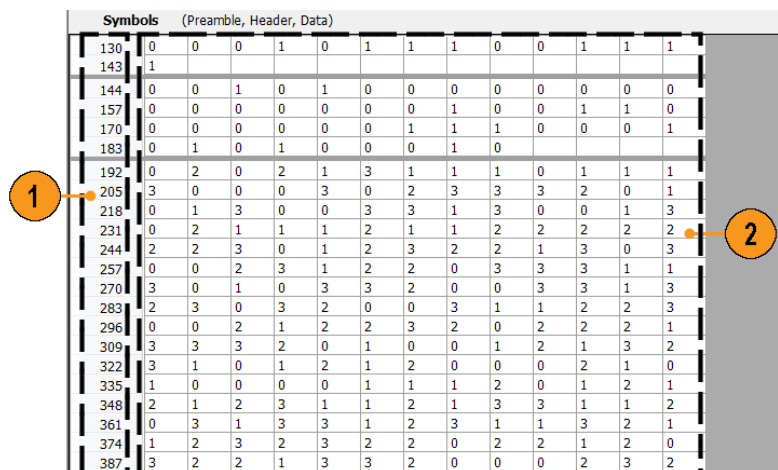

Item	Description
1	Symbol number index (from beginning of packet or segment) of first Symbol data value on the line.
2	Symbol values, with the value in column 2 of each row corresponding to the symbol number index in column 1, and then the symbol value in column 3 corresponding to the next symbol number index, etc., to the end of each row. For example: The symbol number index 130 = 0 in column 2. The symbol number index for column 3 is 131, which equals 0. The symbol number index for column 4 is 132, which equals 1. This pattern continues to the end of the row.

WLAN Symbol Table Settings

Main menu bar: Setup > Settings

Favorites toolbar: 

The settings for the WLAN Symbol Table display are shown in the following table.

Settings tab	Description
Modulation Params (see page 205)	Specifies the type of modulation used for the input signal and other parameters.
Analysis Params (see page 206)	Specifies parameters used by the instrument to analyze the input signal.
Data Range (see page 208)	Specifies which symbols and subcarriers of the signal to display.
Analysis Time (see page 209)	Specifies parameters that define the portion of the acquisition record that is used for analysis. Also allows you to specify the Units (Symbols or Seconds) for WLAN Analysis displays.
Prefs (see page 214)	Specifies the units of the display and whether elements of the graphs are displayed.

WLAN Analysis Shared Measurement Settings

Main menu bar: Setup > Settings

Favorites toolbar: 

The control panel tabs in this section are shared between the displays in the WLAN Analysis folder (Setup > Displays). Some tabs are shared by all the displays, some tabs are shared by only a subset of displays. The settings available on some tabs change depending on the selected display.

Common controls for WLAN analysis displays

Settings tab	Description
Modulation Params (see page 205)	Specifies the type of modulation used for the input signal and other parameters.
Analysis Params (see page 206)	Specifies parameters used by the instrument to analyze the input signal.
Data Range (see page 208)	Specifies which symbols and subcarriers of the signal to display.
Analysis Time (see page 209)	Specifies parameters that define the portion of the acquisition record that is used for analysis. Also allows you to specify the Units (Symbols or Seconds) for WLAN Analysis displays.
Trace (see page 210)	Enables you to display or hide the measurement or average trace.
Scale (see page 211)	Specifies the vertical, subcarrier (for non-b standards only), and symbols scale and position settings.
EVM (see page 213)	Specifies the EVM units and max burst averages.
Prefs (see page 214)	Specifies the units of the display and whether elements of the graphs are displayed.

Modulation Params Tab - WLAN

The Modulation Params tab specifies the type of modulation used by the input signal and other parameters that define the signal format.

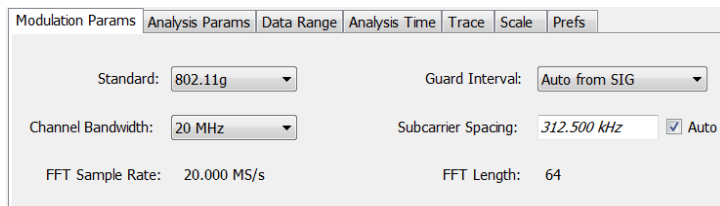

Settings	Description
Standard	Specifies the standard used for the input signal. Choices are 802.11a/b/g/j/n/p/ac.
Guard Interval	Specifies the guard interval used in the input signal. You can select the following: <ul style="list-style-type: none"> - Auto from SIG uses the Guard Interval value extracted from the signal - 1/8 allows setting the value manually - 1/4 allows setting the value manually
Channel Bandwidth	Specifies the nominal channel bandwidth. This setting affects the Subcarrier Spacing value when the Subcarrier Spacing Auto box is checked.
Subcarrier Spacing	Specifies the spacing between subcarriers. When Auto is selected, this setting is automatically calculated according to the Channel Bandwidth value. If Auto is unchecked, a custom subcarrier spacing value can be entered for nonstandard signal definition.
FFT Sample Rate	Indicates the FFT sample rate, based on the bandwidth or subcarrier setting.
FFT Length	Indicates the fixed FFT length.

Analysis Params Tab - WLAN

The Analysis Params tab contains parameters that control the analysis of the input signal.

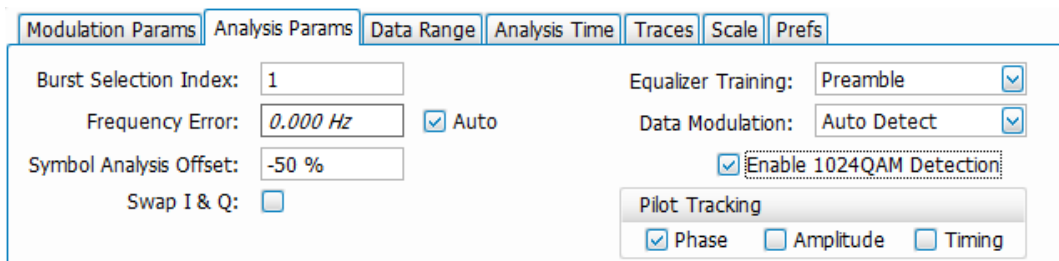

Settings	Description
Burst Selection Index	Allows specifying the burst you want to measure when multiple bursts are present in an acquisition. Index number of the first burst is 1, second burst is 2, etc.
Frequency Error	When the Auto box is checked, the analysis determines the Frequency Error and the measured Frequency Error is displayed. When the Auto box is unchecked, the entered value is used by the analysis as a fixed frequency offset. This is useful when the exact frequency offset of the signal is known.
Symbol Analysis Offset	Specifies the analysis offset in the symbol interval. This value is a percentage of the Guard Interval. The allowable range is -100% to 0%. -100% positions the FFT to start at the beginning of the Guard Interval, 0% positions it to start at the end of the Guard Interval. Default value is -50% which usually gives the best measurement results.
Swap I & Q	Select the checkbox to swap the I and Q components of a signal. This compensates the input signal for spectral inversion.
Equalizer Training	Specifies the method used to estimate channel frequency response and equalization. This control can be used to diagnose changes in frequency response over the signal packet.
Preamble	The instrument uses only the Preamble to estimate channel frequency response. This response is then used to equalize the entire signal packet.
Preamble + Data	The instrument makes an initial channel frequency response estimate from the Preamble. It then estimates the channel response for each data symbol using the decoded data content to derive equalization for each symbol individually. This allows compensation for time-varying channel response over the packet.
Data Modulation	Allows choice of automatic or manual method of data symbol modulation identification, as follows: <ul style="list-style-type: none"> – Auto Detect estimates the modulation from the data symbol IQ content. – Auto from SIG sets the modulation as indicated by the embedded SIG preamble symbol format data. – Manual allows specifying the modulation type regardless of the signal content.
Enable 1024QAM detection	Check box to enable auto-detection of 1024QAM.
Pilot tracking	Specifies if pilot subcarriers should be used to correct amplitude, phase, and symbol timing variations over the packet. The choices available are Phase, Amplitude, and Timing. The default setting is Phase correction enabled, Amplitude and Timing correction disabled..
Subcarrier derotation	Allows some displays to show subcarriers with or without Gamma subcarrier phase rotation removed. Gamma phase rotation is applied to 802.11n and 802.11ac subcarriers in defined subranges depending on the selected Channel Bandwidth >40 MHz. Only Constellation and Symbol Table results are affected by this control. <p>When the box is unchecked, the rotation is not removed, which provides a direct view of the physical modulation on the channel.</p> <p>When the box is checked, the rotation is removed, allowing easier decoding of the underlying data content.</p>

Data Range Tab - WLAN

The Data Range tab enables you to control how much signal is analyzed, as well as specify the range of results that are displayed for the WLAN Constellation, EVM, Flatness, Magnitude Error, Phase Error, and Symbol Table graphs. The tab contents vary by standard.

Data Range tab for non-b standards.

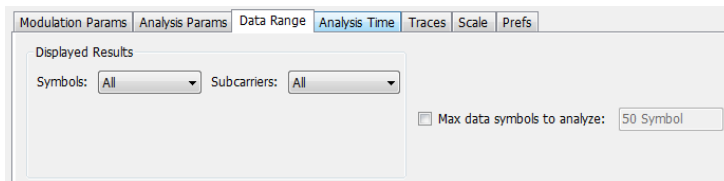

Settings	Description
Symbols	Specifies which symbols are displayed in the graphs.
All	Select All to display all symbols.
Range	Select Range to specify a subset of symbols for display.
Start	Specifies the first symbol to include in the display.
Stop	Specifies the last symbol to include in the display.
Single	Select Single to display a single symbol.
Index	Use Index to specify the symbol you want to display.
Subcarriers	Specifies which subcarriers are displayed.
All	Select All to display all subcarriers in the signal.
Pilots	Select Pilot to display only pilot subcarriers.
Data	Select Data to display only data subcarriers.
Single	Specifies a specific subcarrier for display.
Index	Specifies the specific subcarrier to be displayed.
Range	Specifies a range of subcarriers to be displayed.
Start	Specifies the start value of the range to be displayed.
Stop	Specifies the ending value of the range to be displayed.
Max symbols to analyze	Specifies how many symbols are analyzed. You can use this setting to speed analysis by limiting the number of symbols being analyzed.

Data Range tab for 802.11b standards.

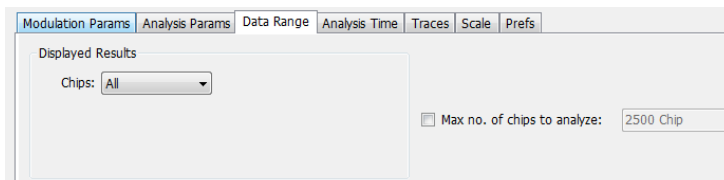

Settings	Description
Chips	Specifies which symbols are displayed in the graphs.
All	Select All to display all chips.
Preamble Only	Select to include only the Preamble in the display.
Header Only	Select to include only the Header in the display.
Data Only	Select to include only the Data in the display.
Max number of chips to analyze	Specifies how many chips are analyzed. You can use this setting to speed analysis by limiting the number of chips being analyzed. Check this box and then enter the maximum number of chips to analyze.

Analysis Time Tab - WLAN

The Analysis Time tab contains parameters that define how the signal is analyzed in the WLAN Analysis displays.

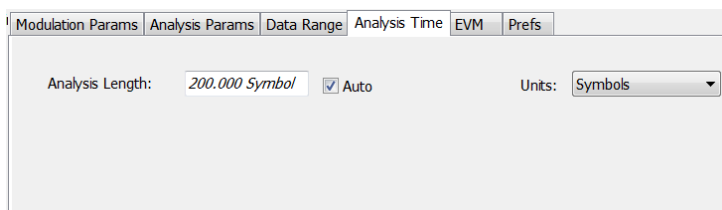

Settings	Description
Analysis Length	Specifies the length of the analysis period to use in measurements. Length is specified in either symbols or seconds, depending on the Units setting. Use this to specify how long a period of time is analyzed. – Range: minimum value depends on modulation type – Resolution: 1 symbol
Auto	When enabled, causes the instrument to set the Analysis Length value based on the requirements of the selected display.
Units	Specifies the units of the Analysis Length in either Symbols or Seconds.

Trace Tab - WLAN

The Trace tab allows you to set the trace display characteristics of the selected display. This tab is not available for all WLAN displays.

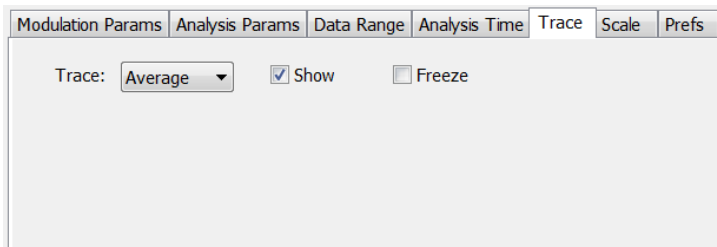

Settings	Description
Trace	Use this drop-down list to select whether or not the Average trace or the measurement trace is displayed. The measurement trace depends on the selected display.
Show Symbols	Select or deselect this checkbox to show or hide symbols.
Freeze	Selecting Freeze halts updates to the symbols.

Traces Tab - WLAN Channel Response

The Traces tab allows you to set the trace display characteristics of the WLAN Channel Reponse display.

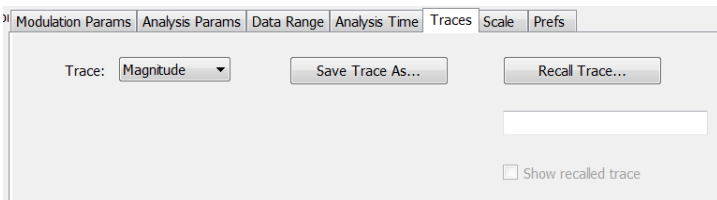

Settings	Description
Trace	Selects the Magnitude or Phase trace for saving or recalling.
Save Trace As . . .	Select to save a trace.
Recall Trace . . .	Select to recall a trace.

Scale Tab - WLAN

The Scale tab allows you to change the scale settings that control how the trace appears on the display but does not change control settings such as Measurement Frequency. There are four versions of the Scale tab for WLAN displays. One version is used for the Constellation display, one for the Spectral Flatness display, one for the Power vs Time display, and one for the EVM, Magnitude Error, Phase Error, and Channel Response displays.

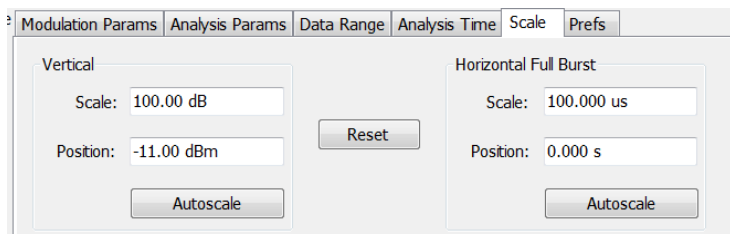

Scale tab for the WLAN Power vs Time display

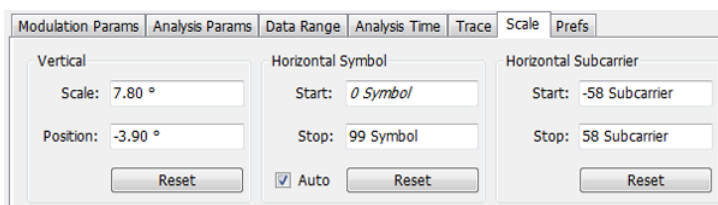

Scale tab for WLAN EVM, Magnitude Error, Phase Error, and Channel Response displays

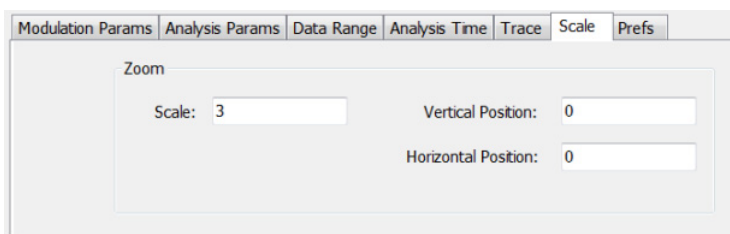

Scale tab for WLAN Constellation display

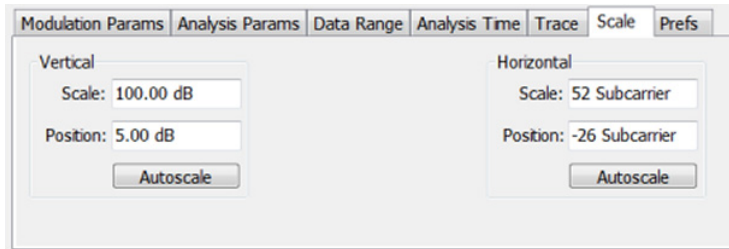

Scale tab for WLAN Spectral Flatness display

Settings	Description
Vertical	Controls the vertical position and scale of the trace display.
Scale	Changes the vertical scale of the graph.
Position	Adjusts the reference level away from top of the graph.
Autoscale	Resets the scale of the vertical axis to contain the complete trace.
Subcarrier	Controls the scale of the subcarrier graph and position of the trace.
Scale	Specifies how many subcarriers are displayed horizontally.
Position	Specifies the subcarrier that appears at the left edge of the subcarrier graph.
Autoscale	Resets the scale of the horizontal axis to contain the complete trace.
Symbols	Controls the scale of the Symbols graph.
Scale	Specifies the number of symbols that appear in the symbols graph.
Position	Specifies the symbol that appears at the left edge of the Symbols graph.
Autoscale	Resets the scale and position settings to optimize the display.
Auto	When Auto is checked, the scale and position values for the Symbols graph are automatically adjusted to maintain the optimal display.
Zoom	Sets the Constellation display size and position.
Scale	Sets the magnification value for the Constellation display.
Vertical Position	Sets the vertical location of the Constellation display within the graph. Range is -3.7 to +3.7.
Horizontal Position	Sets the horizontal location of the Constellation display within the graph. Range is -3.7 to +3.7.

EVM Tab - WLAN

The EVM Tab enables you to choose between dB and percent for the EVM units and to select to set the maximum bursts to average. The EVM Tab is only available for the WLAN Summary display.

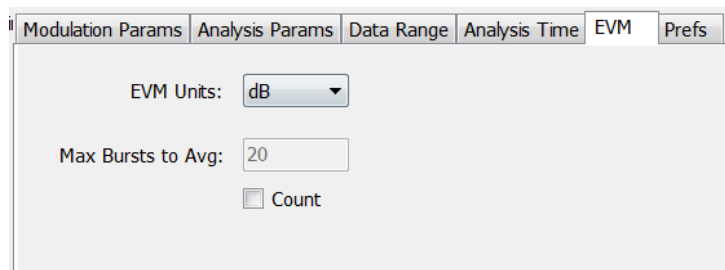

The screenshot shows a software interface with several tabs: Modulation Params, Analysis Params, Data Range, Analysis Time, EVM, and Prefs. The EVM tab is active and contains the following settings:

- EVM Units: dB (selected from a dropdown menu)
- Max Bursts to Avg: 20 (text input field)
- Count: (checkbox, currently unchecked)

Settings	Description
EVM units	Specifies whether the displayed EVM units are dB or percent.
Max Bursts to Avg	Specifies the maximum number of bursts to average when Count is selected.
Count	Enables the Max Bursts to Avg function.

Prefs Tab - WLAN

The Prefs tab enables you to change appearance characteristics of the WLAN Analysis displays. Not all settings on the Prefs tab shown below appear for every WLAN display.

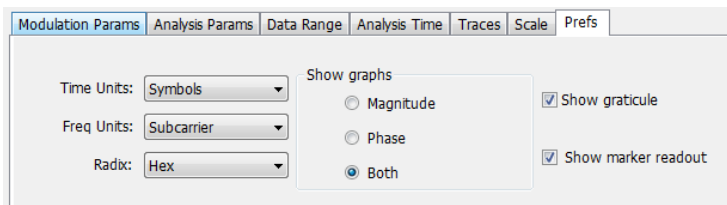

Settings	Description
Time units	Specifies whether the displayed time units are seconds or symbols.
Freq units	Specifies whether the displayed frequency units are frequency (Hz) or subcarrier channel.
Radix	Specifies whether symbol values are displayed in binary or hex format (for example, in the Symbol Table or markers readouts).
Show graphs	Specifies which graphs are displayed. Select from Symbols, Subcarriers or Both, Magnitude, Phase, or Both. Disabled (no masks), Shaded Region, or Line Only. These selections are only available for OFDM signals.
Show graticule	Specifies to show the graticule on the display when checked.
Show marker readout	Specifies to show the marker readout when checked.

Overview of 802.11ad and 802.11ay

The optional Tektronix 802.11ad and 802.11ay solution provides repeatable signal quality measurements (such as EVM) for the 802.11ad single carrier PHY, 802.11ad control PHY, and 802.11ay single carrier at RF (up to 70 GHz).

The IEEE 802.11ad standard was approved in December 2012 and amended in December 2016. The IEEE 802.11ay is an evolving standard that is in draft stage and planned for approval in March 2020. These standards allow wireless communication of devices at multi-gigabit speeds and enable high performance wireless data, display, and audio applications that supplement the capabilities of previous wireless LAN devices. They operate in the 60 GHz band and deliver data transfer rates up to 20 Gbit/s, while maintaining compatibility with existing Wi-Fi devices. The 60 GHz signal cannot typically penetrate walls, but can propagate off reflections from walls, ceilings, floors, and objects using beamforming built into an 802.11ad system. When roaming away from the main room, the protocol can switch to make use of the other 802.11 lower bands at a much lower rate, but which can propagate through walls.

ITU-T mandates the use of the following four channels at the 60 GHz band for 802.11ad.

Channel	Center (GHz)	Min (GHz)	Max (GHz)	BW (GHz)
1	58.32	57.24	59.4	2.16
2	60.48	59.4	61.56	2.16
3	62.64	61.56	63.72	2.16
4	64.8	63.72	65.88	2.16

ITU-T mandates the use of the following channels at the 60 GHz band for 802.11ay.

2.16 GHz BW channels

Channel	Center (GHz)	Min (GHz)	Max (GHz)
1	58.32	57.24	59.40
2	60.48	59.4	61.56
3	62.64	61.56	63.72
4	64.80	63.72	65.88
5	66.96	65.88	68.04
6	69.12	68.04	70.2

4.32 GHz BW channels

Channel	Center (GHz)	Min (GHz)	Max (GHz)
7/8	59.40	57.24	61.56
9/10	61.56	59.4	63.72
11/12	63.72	61.56	65.88

Channel	Center (GHz)	Min (GHz)	Max (GHz)
13/14	65.88	63.72	68.04
15/16	68.04	65.88	70.2

802.11ay 4.32 GHz BW Packet Measurements

For a 802.11ay 4.32 GHz BW packet, the results of analysis are shown for 3 regions separately: EDMG, PreEDMG1, and PreEDMG2. This is because of the different chip rate of these regions and to allow you to perform detailed analysis of any specific region with marker support. The region can be selected from the Modulation Params drop-down list. A replay or run will be required to see the updated results after changing the selection in drop-down. Also, when a non-EDMG duplicate mode is detected, the lower band (2G-U) or upper band (2G-L) can be selected from the drop-down.

802.11ad/11ay Standards Preset

Select **Presets > Standards** in the menu to open the 802.11ad/11ay preset. You can then select to recall preconfigured displays for Single Carrier or Control PHY standards with an EVM or SEM test setup. The preset displays are Spectrum, Time Overview, 802.11ad/11ay Summary, 802.11ad/11ay Constellation for EVM test setup, and SEM and Time Overview for SEM test setup. The preset sets the measurement filter to Root Raised Cosine, the filter parameter to 0.25, and the default data length to Analyze as *1000* for Single Carrier and *512* for Control PHY. You can read more about [Standards Presets \(see page 13\)](#).

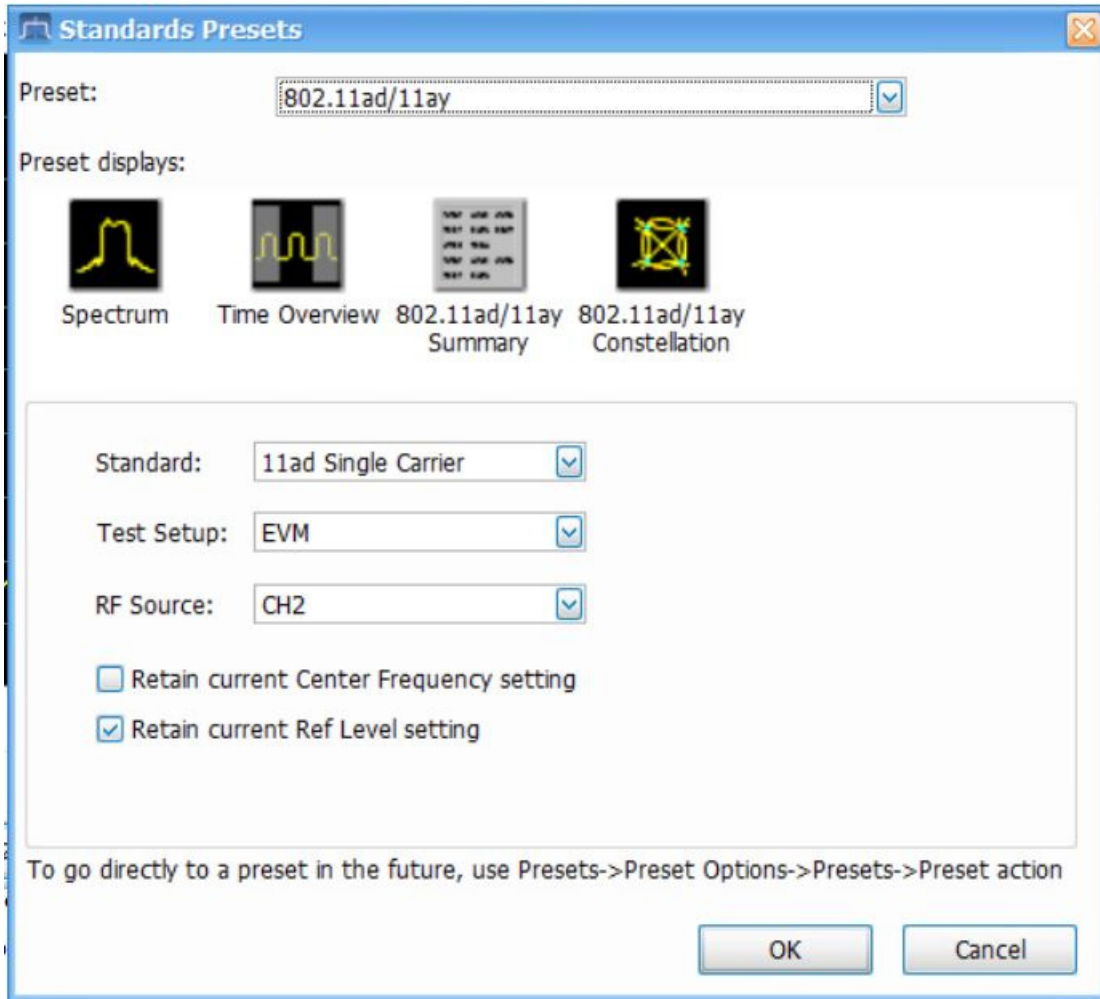

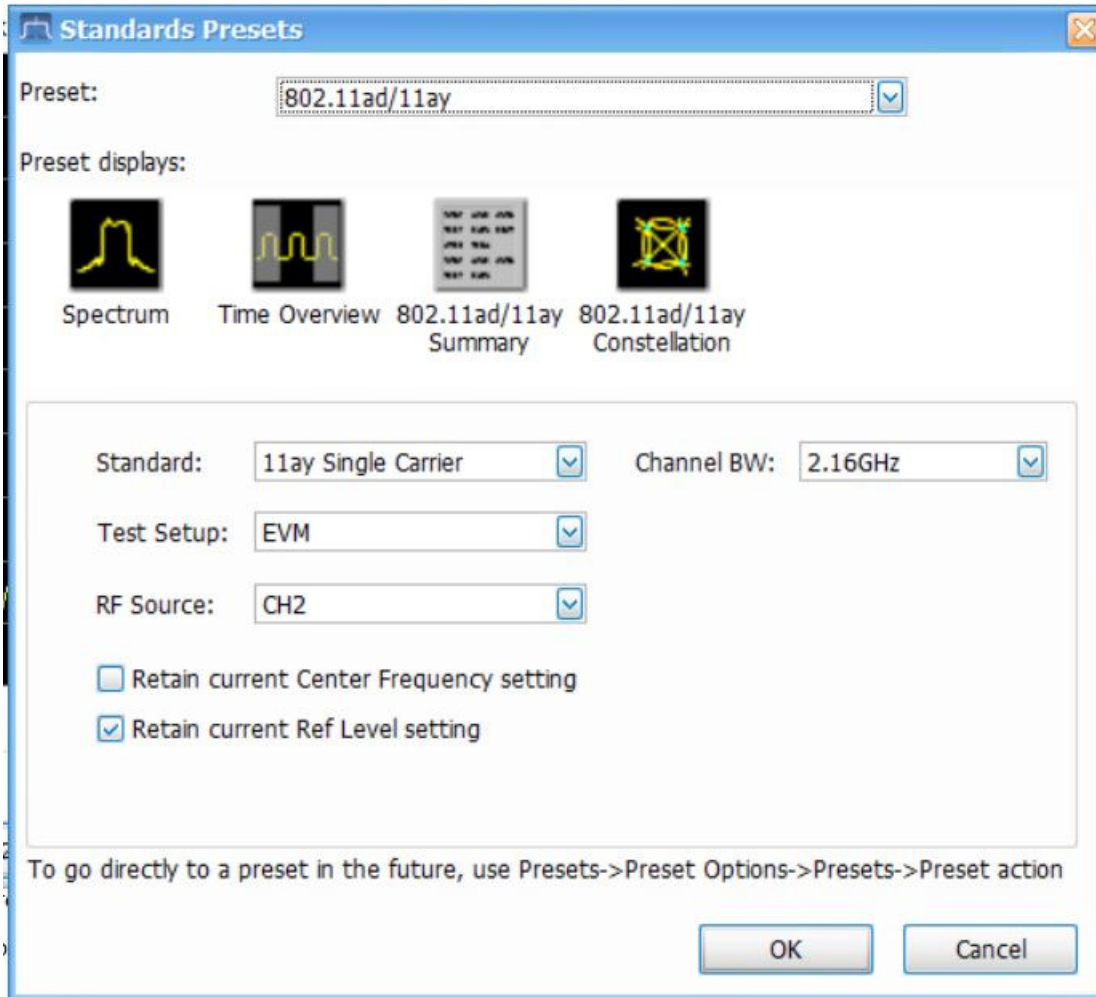

NOTE. The default resolution bandwidth for the SEM display is 1 MHz.

Settings	Description
Standard	Allows you to choose between Single Carrier and Control PHY.
Test Setup	Allows you to choose between EVM and SEM.
RF Source	Allows you to choose between Channel 1 or Channel 2. If you choose Channel 1, the center frequency is set to 10 GHz (IF). If you choose Channel 2, then the center frequency is set to 60.48 GHz (RF). However, if the Retain Current Center Frequency setting is enabled, the previously selected center frequency is retained. In case of a DX series oscilloscope, if you decide to connect the signal to Channel 3 or Channel 4, then you have to select this manually in the Acquisition Control Pane > Vertical tab > RF Source.
Channel BW	Allows you to select the channel bandwidth.
Retain current center frequency setting	Allows you to retain the previous center frequency. It is disabled by default. To enable or disable this setting, select the checkbox.
Retain current reference level setting	Allows you to retain the previous reference level. It is enabled by default. To enable or disable this setting, select the checkbox.

802.11ad/11ay topics in this Help

The following information about the 802.11ad/11ay Analysis option is available:

- [802.11ad/11ay measurements](#)
- [802.11ad/11ay displays](#)
- [802.11ad/11ay measurement control settings](#)

802.11ad/11ay measurements

The 802.11ad/11ay option supports analysis of 802.11ad Control PHY, 802.11ad Single Carrier PHY, and 802.11ay Single Carrier PHY standards. Information about the 802.11ad packet is given in Section 20 of the 802.11ad-2016 standard. Information about the 802.11ay packet is given in the draft versions of the 802.11ay standard.

These measurements are only supported for Windows oscilloscopes of bandwidth > 3 GHz. ATI oscilloscopes support real time data analysis at RF, without any downconverters. The 802.11ad/11ay option allows you to do the following:

- Automatically detect the packet start, if it is included in the analysis region
- Synchronize to preamble start using the Golay codes in STF (Short training field) region
- Demodulate Preamble, Header, and Payload regions separately and measure EVM in each of these sections.

The input data is filtered with a RRC filter, corrected for frequency, phase and symbol timing errors, IQ DC offset errors and Equalization is done based on Channel estimated using the Channel Estimation Field (CEF) data.

- Decode packet information in header (like MCS, length etc.)

- Measure the following:
 - EVM
 - RF power and Received Power Indicator (RCPI)
 - Estimated SNR
 - Frequency error
 - IQ DC origin offset
 - IQ Gain imbalance is calculated with the equation

$$\text{Gain Error in dB} = 20 \log \left[\frac{(1 + \epsilon_A)}{(1 - \epsilon_A)} \right]$$
 Where, $2\epsilon_A$ is the amplitude difference between the signal paths.
 - IQ phase imbalance or quadrature error
 - Signal quality
- Perform Transmit Mask measurement with the set up file given under Example Files. The Mask (Offset frequencies and Start and Stop limits) is developed as per standard recommendations. After loading set up file, you can set the Center Frequency manually to that of the signal.

The following features are also available:

- Analyze EVM result with and without equalization.
- Analyze EVM result with and without IQ DC offset correction.
- View the constellation color coded for the preamble, header, guard, and payload regions. You can also view the pi/2 rotated constellation against the final de-rotated constellation.
- View the demodulated symbols in tabular form with different color codes and with an option to traverse to the start of each region.
- View the EVM spread across the analyzed packet with color codes differentiating regions.
- View of scalar results in the Summary display.
- EVM numbers can be seen in percentage or in dB.
- EVM and Frequency Error limits for the transmitter can be set in the Limits tab of the Settings control panel. If the measured EVM is greater than the limits, or if the measured Frequency Error is greater than the limit, then a FAIL status will appear against the respective measurement.
- Save the Channel Impulse response coefficients as a .txt or .csv file.

802.11ad/11ay displays

The displays in 802.11ad/11ay Analysis (Setup > Displays > Measurements) are:

- [802.11ad/11ay Constellation display \(see page 221\)](#)
- [802.11ad/11ay EVM vs Time display \(see page 224\)](#)

- [802.11ad/11ay Symbol Table display \(see page 227\)](#)
- [802.11ad/11ay Summary display \(see page 229\)](#)

802.11ad/11ay Constellation Display

This display shows a digitally-modulated signal in constellation form.

To show the 802.11ad/11ay Constellation display:

1. Recall an appropriate acquisition data file.
2. Press the **Displays** button or select **Setup > Displays**.
3. In the **Select Displays** dialog, select **802.11ad/11ay Analysis** in the **Measurements** box.
4. In the Available displays box, double-click the **802.11ad/11ay Constellation** icon or select the icon and click **Add**. The 802.11ad/11ay Constellation icon will appear in the **Selected displays** box and will no longer appear under Available displays.
5. Click **OK** to show the 802.11ad/11ay Constellation display.
6. Press the **Replay/Run** button to take measurements on the acquired data.

Elements of the display

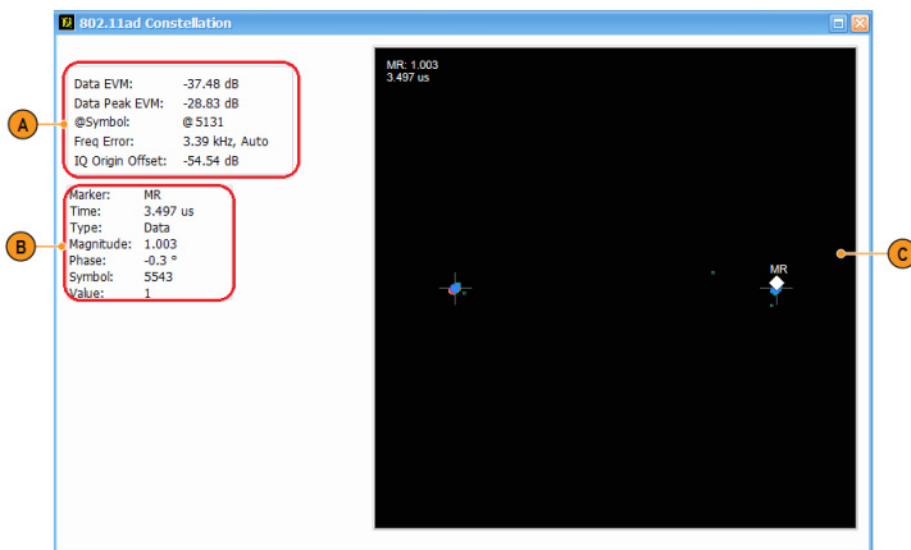

Item	Display element	Description
A	Scalar results	Gives results of Data EVM (Average EVM over the data region and the Peak Error in the data region), Freq Error, and IQ Origin Offset.
B	Marker readout	Specifies the Marker readout values.
C	Graph	Displays the input signal.

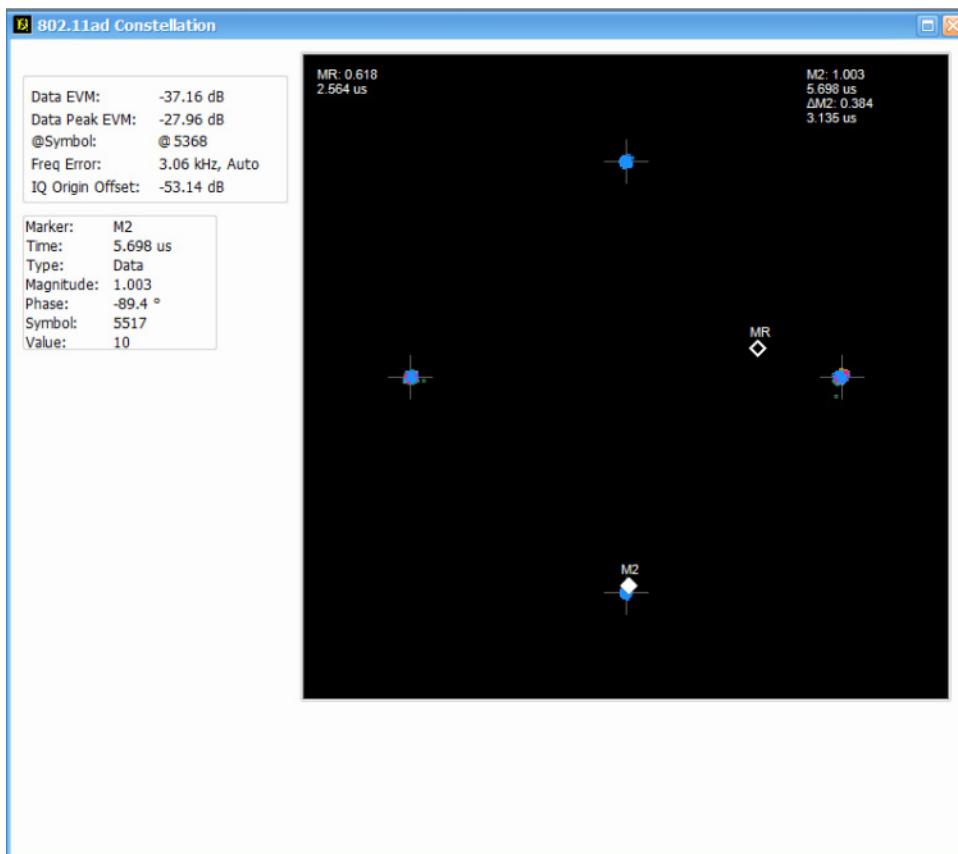

The above image shows an 802.11ad signal with QPSK data region

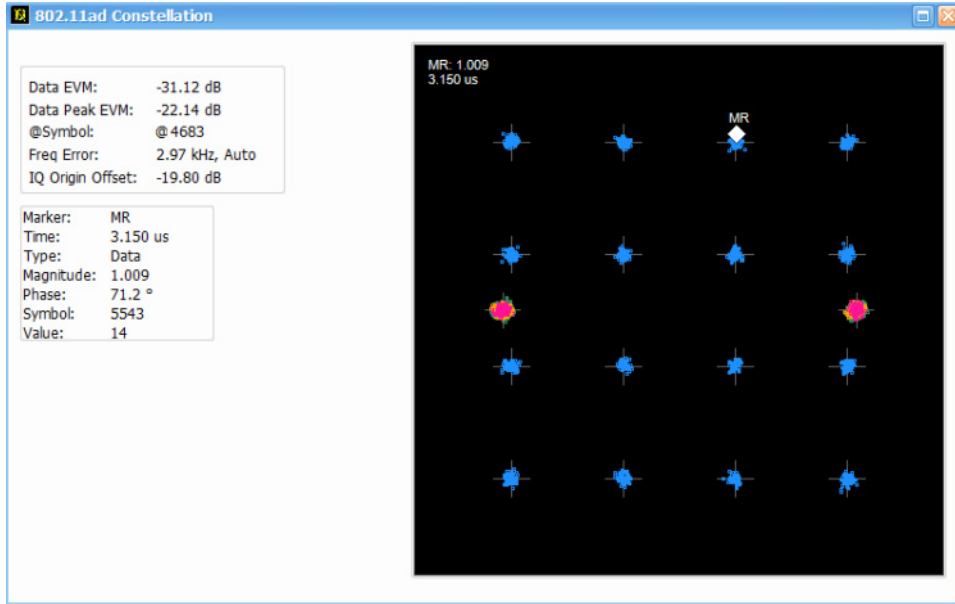

The above image shows an 802.11ad signal with 16QAM data region

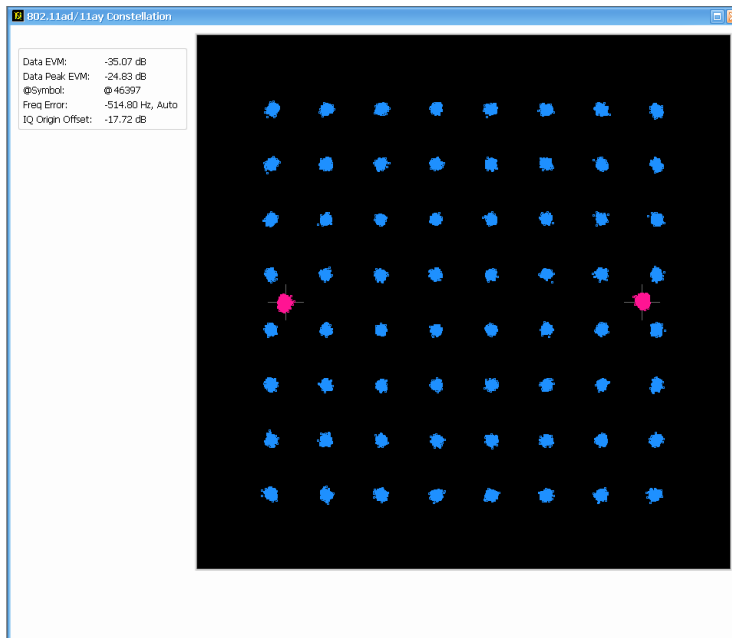

The above image shows an 802.11ad signal with 64QAM data region

Constellation display settings

Settings tab	Description
Modulation Params (see page 233)	Specifies the input signal standard, measurement filters and filter parameters.
Analysis Params (see page 234)	Specifies parameters used by the instrument and software to analyze the input signal.
Advanced Params (see page 235)	Specifies additional parameters used by the instrument and software to analyze the input signal.
Analysis Time (see page 236)	Specifies parameters that define the portion of the acquisition record that is used for analysis. Also allows you to specify the Units (Symbols or Seconds) and Time Zero Reference (Trigger or Acquisition Start) for 802.11ad/11ay Analysis displays.
EVM (see page 238)	Specifies the EVM units, start and length of data symbols to be analyzed for EVM, and the number of acquisitions used for averaging. For Control PHY, the Start and Length of data symbols is specified in terms of de-spread symbols and also the number of Bursts to Avg by enabling the count.
Traces (see page 242)	Specifies the trace type and the result content. Select either rotated or de-rotated constellation. De-rotated constellation is shown by default.
Prefs (see page 240)	Specifies the radix of the data symbols and the option to see the marker readout.
Scale (see page 239)	Defines the vertical and horizontal axes.

802.11ad/11ay EVM vs Time

This display shows the EVM plotted against time in seconds or symbols. The analysis region in which EVM measurement done is indicated by a purple line in the Time Overview to indicate the region of analysis.

To show the 802.11ad/11ay EVM vs Time Display:

1. Press the **Displays** button or select **Setup > Displays**.
2. In the **Select Displays** dialog, select **802.11ad/11ay Analysis** in the **Measurements** box.
3. In the Available displays box, double-click the **802.11ad/11ay EVM vs Time** icon or select the icon and click **Add**. The 802.11ad/11ay EVM vs Time icon will appear in the **Selected displays** box and will no longer appear under Available displays.
4. Click **OK** to show the 802.11ad/11ay EVM vs Time display.
5. Press **Replay/Run** button to take measurements on the acquired data.

Elements of the display

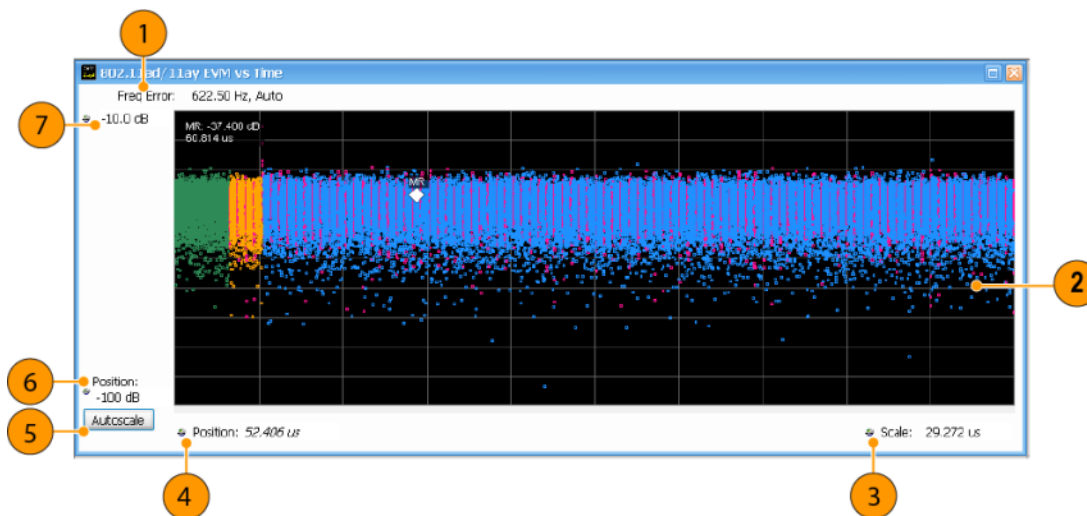

Item	Display element	Description
1	Freq error	Displays the frequency error which has been corrected after which the EVM is calculated. The displayed frequency error is followed by either Auto or Manual. This indicates the error calculation mode which is set under Settings >Analysis Params.
2	Graph	Displays the input signal. Different color codes are used in the 802.11ad EVM vs Time to indicate different regions of the packet. Check legend at the bottom of the symbol table for color codes
3	Scale	Adjusts the span of the graph in seconds or symbols.
4	Position	Displays the horizontal position of the trace on the graph display.
5	Autoscale	Adjusts the vertical and horizontal settings to provide the best display.
6	Position	The error at the bottom of the graph in dB or percent.
7	Top of graph	The error at the top of the graph in dB or percent.

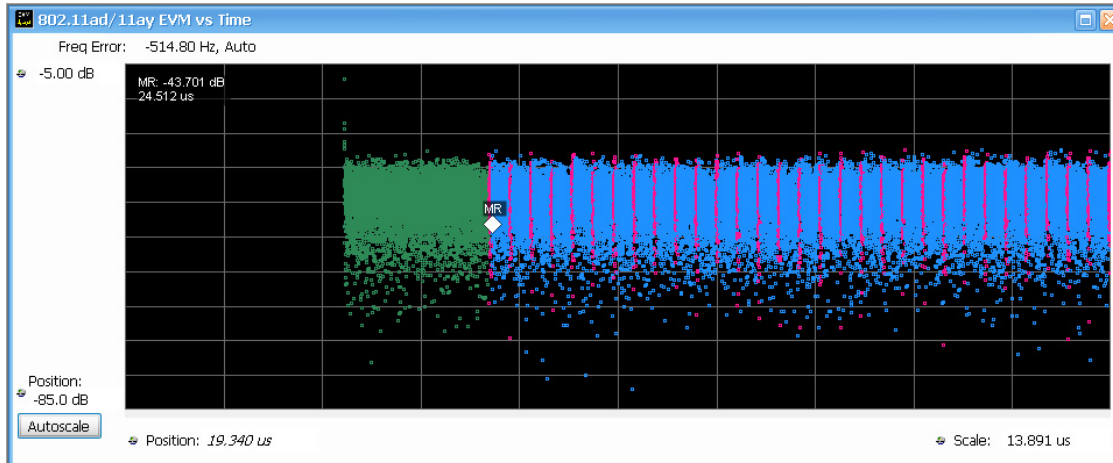

The above image shows a 802.11ay 4.32 GHz pre-EDMG region. The initial empty portion is for the pre-EDMG region.

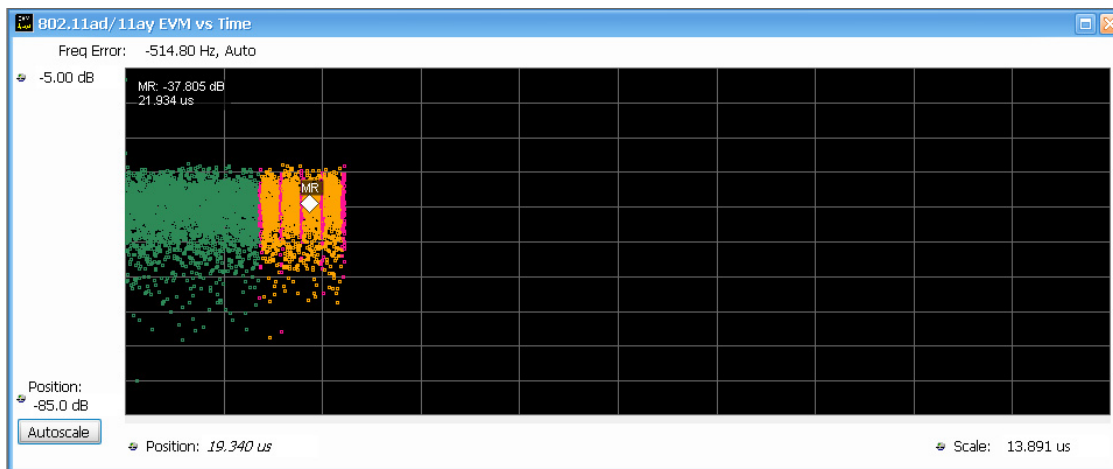

The above image shows a 802.11ay 4.32 GHz EDMG1 region. The trailing empty portion is for the EDMG region.

EVM vs Time display settings

Settings tab	Description
Modulation Params (see page 233)	Specifies the input signal standard, measurement filters, and filter parameters.
Analysis Params (see page 234)	Specifies parameters used by the instrument to analyze the input signal.
Advanced Params (see page 235)	Specifies parameters used by the instrument to analyze the input signal, with options to enable the Equalizer and IQ DC Offset correction.
Analysis Time (see page 236)	Specifies parameters that define the portion of the acquisition record that is used for analysis. Also allows you to specify the Units (Symbols or Seconds) and Time Zero Reference (Trigger or Acquisition Start) for 802.11ad/11ay Analysis displays.
EVM (see page 238)	Specifies the number of data symbols to be analyzed for EVM. For Control PHY, the Start and Length of data symbols is specified in terms of de-spread symbols.
Prefs (see page 240)	Specifies the radix of the marker readout and whether elements of the graphs are displayed.
Scale (see page 239)	Defines the vertical and horizontal axes.

802.11ad/11ay Symbol Table Display

This display shows a digitally-modulated signal. It is similar to the Constellation display except that a text table is used to display data bits as symbols rather than a graph.

1. Press the **Displays** button or select **Setup > Displays**.
2. In the **Select Displays** dialog, select **802.11ad/11ay Analysis** in the **Measurements** box.
3. In the Available displays box, double-click the **802.11ad/11ay Symbol Table** icon or select the icon and click **Add**. The 802.11ad/11ay Symbol Table icon will appear in the **Selected displays** box and will no longer appear under Available displays.
4. Click **OK** to show the 802.11ad/11ay Symbol Table display.
5. Press **Replay/Run** button to take measurements on the acquired data.

Elements of the display

Symbol Index	Bit 1	Bit 2	Bit 3	Bit 4	Bit 5	Bit 6	Bit 7	Bit 8	Bit 9	Bit 10	Bit 11	Bit 12	Bit 13	Bit 14	Bit 15
0	+1	+1	-1	-1	-1	-1	-1	-1	+1	-1	+1	+1	-1	-1	+1
16	+1	+1	-1	-1	+1	+1	+1	+1	-1	+1	-1	+1	-1	+1	-1
32	-1	-1	+1	+1	+1	+1	+1	+1	-1	+1	-1	-1	+1	+1	-1
48	+1	+1	-1	-1	+1	+1	+1	+1	-1	+1	-1	+1	-1	+1	-1
64	+1	+1	-1	-1	-1	-1	-1	-1	+1	-1	+1	+1	-1	-1	+1
80	+1	+1	-1	-1	+1	+1	+1	+1	-1	+1	-1	+1	-1	+1	-1
96	+1	+1	-1	-1	-1	-1	-1	-1	+1	-1	+1	+1	-1	-1	+1
112	-1	-1	+1	+1	-1	-1	-1	-1	+1	-1	+1	-1	+1	-1	+1
128	+1	+1	-1	-1	-1	-1	-1	-1	+1	-1	+1	+1	-1	-1	+1
144	+1	+1	-1	-1	+1	+1	+1	+1	-1	+1	-1	+1	-1	+1	-1
160	-1	-1	+1	+1	+1	+1	+1	+1	-1	+1	-1	-1	+1	+1	-1
176	+1	+1	-1	-1	+1	+1	+1	+1	-1	+1	-1	+1	-1	+1	-1
192	+1	+1	-1	-1	-1	-1	-1	-1	+1	-1	+1	+1	-1	-1	+1
208	+1	+1	-1	-1	+1	+1	+1	+1	-1	+1	-1	+1	-1	+1	-1
224	+1	+1	-1	-1	-1	-1	-1	-1	+1	-1	+1	+1	-1	-1	+1
240	-1	-1	+1	+1	-1	-1	-1	-1	+1	-1	+1	-1	+1	-1	+1
256	+1	+1	-1	-1	-1	-1	-1	-1	+1	-1	+1	+1	-1	-1	+1
272	+1	+1	-1	-1	+1	+1	+1	+1	-1	+1	-1	+1	-1	+1	-1
288	-1	-1	+1	+1	+1	+1	+1	+1	-1	+1	-1	-1	+1	+1	-1
304	+1	+1	-1	-1	+1	+1	+1	+1	-1	+1	-1	+1	-1	+1	-1
320	+1	+1	-1	-1	-1	-1	-1	-1	+1	-1	+1	+1	-1	-1	+1
336	+1	+1	-1	-1	+1	+1	+1	+1	-1	+1	-1	+1	-1	+1	-1
352	+1	+1	-1	-1	-1	-1	-1	-1	+1	-1	+1	+1	-1	-1	+1
368	-1	-1	+1	+1	-1	-1	-1	-1	+1	-1	+1	-1	-1	-1	+1
384	+1	+1	-1	-1	-1	-1	-1	-1	+1	-1	+1	+1	-1	-1	+1
400	+1	+1	-1	-1	+1	+1	+1	+1	-1	+1	-1	+1	-1	+1	-1
416	-1	-1	+1	+1	+1	+1	+1	+1	-1	+1	-1	-1	+1	+1	-1
432	+1	+1	-1	-1	+1	+1	+1	+1	-1	+1	-1	+1	-1	+1	-1
448	+1	+1	-1	-1	-1	-1	-1	-1	+1	-1	+1	+1	-1	-1	+1
464	+1	+1	-1	-1	+1	+1	+1	+1	-1	+1	-1	+1	-1	+1	-1
480	+1	+1	-1	-1	-1	-1	-1	-1	+1	-1	+1	+1	-1	-1	+1
496	-1	-1	+1	+1	-1	-1	-1	-1	+1	-1	+1	-1	+1	-1	+1
512	+1	+1	-1	-1	-1	-1	-1	-1	+1	-1	+1	-1	-1	-1	+1
528	+1	+1	-1	-1	+1	+1	+1	+1	-1	+1	-1	+1	-1	+1	-1

Navigate To: Preamble (pi/2-BPSK) Header (pi/2-BPSK) Data (pi/2-16QAM) Guard (pi/2-BPSK)

Marker: MR Time: 3.057 us Symbol: 5543 Value: 3

Different Color codes are used in the table to indicate different regions of the packet. The legend at the bottom of the table indicates which color represents which packet component. The bit colors in the table match the packet colors. The packet will have the following regions:

- Preamble (pi/2-BPSK)
- Header (pi/2-BPSK)
- Data (pi/2 BPSK, pi/2 QPSK, pi/2 16QAM, or pi/2 64QAM)
- Guard (pi/2-BPSK)

Using markers

Markers are indicators in the display that you can position on a trace to measure values such as frequency, power, and time. A Marker always displays its position and, if the Delta readout is enabled, will display the difference between its position and that of the Marker Reference. Within the Symbol Table, colored cells indicate the location of markers. The selected Marker is highlighted with a light green background. All other markers are highlighted with a light gray background. In the Symbol Table, the marker readout below the table shows the marker location in time, symbol numbers and symbol value.

Symbol Table display settings

Settings tab	Description
Modulation Params (see page 233)	Specifies the type of modulation used for the input signal and other parameters.
Analysis Params (see page 234)	Specifies parameters used by the instrument to analyze the input signal.
Advanced Params (see page 235)	Specifies additional parameters used by the instrument to analyze the input signal.
Analysis Time (see page 236)	Specifies parameters that define the portion of the acquisition record that is used for analysis. Also allows you to specify the Units (Symbols or Seconds) and Time Zero Reference (Trigger or Acquisition Start) for 802.11ad/11ay Analysis displays.
Prefs (see page 240)	Specifies the radix of the symbols and the option to see the marker readout.

802.11ad/11ay Summary Display

The 802.11ad/11ay Summary display shows a summary of all scalar measurements done on the acquired test pattern. Pass/Fail information is also provided in this display for all enabled scalar measurements. You can set limits and choose which measurement to compare for Pass/Fail from the Limits tab in the 802.11ad/11ay Summary Settings control panel. The default limits come from the performance recommendation limits given by the Standards document. The default limits can be reloaded by selecting the 802.11ad/11ay as the preset in the Standards Preset window.

1. Press the **Displays** button or select **Setup > Displays**.
2. In the **Select Displays** dialog, select **802.11ad/11ay Analysis** in the **Measurements** box.
3. In the Available displays box, double-click the **802.11ad/11ay Summary** icon or select the icon and click **Add**. The 802.11ad/11ay Summary icon will appear in the **Selected displays** box and will no longer appear under Available displays.
4. Click **OK** to show the 802.11ad/11ay Summary display.
5. Press **Replay/Run** button to take measurements on the acquired data.

Elements of the display

The results presented in the display include scalar results of modulation characteristics, shown in the following areas of the display: EVM - Packet, Average results over multiple Acquisitions (One Bust per Acquisition), and Packet Information. These scalar results are averaged over the previously acquired packets. The packet number to be analyzed is set in the EVM tab of the Settings control panel.

802.11ad/11ay Summary

Standard: 11ay Single Carrier **Data Modulation:** (pi/2-16QAM) Clear

RF Power: -18.51 dBm RCPI: 183 Frequency Error: 0.01 ppm PASS 622.5 Hz Estimated SNR: 37.83 dB IQ Origin Offset: -25.66 dB IQ Gain Imbalance: 0.00 dB IQ Quadrature Error: 0.02 ° Signal Quality (rho): 0.9998	Packet Information Channel Aggregation: 0 EDMG MCS (decimal): 12 PSDU Length (decimal): 10000 Bandwidth Bitmap: 10000000 LDPC CW Length: 0 EDMG TRN Length (decimal): 0 Spatial Streams (decimal): 0 Primary Channel Num: 0 Beamformed: 0 STBC Applied: 0 CRC: 1000110100111001 Scrambler Initialization: 0101100 Last RSSI: 0111 Compressed BW (decimal): 0
--	---

EVM - Packet			
	EVM	Peak EVM	@Symbol
STF (2176)	-37.33 dB	-27.95 dB	937
CEF (1152)	-37.62 dB	-27.44 dB	2176
Header (896)	-37.43 dB	-25.28 dB	5375
Guard (6080)	-36.50 dB	-14.89 dB	5376
Data (40320)	-37.73 dB	-25.21 dB	46485

Average results over multiple Acquisitions (One Burst per Acquisition)	
Avg Data EVM:	-37.73 dB
Max Data EVM:	-37.73 dB
1-Sigma Data EVM:	0.0000 dB
Avg Frequency Error:	0.01 ppm PASS
Max Frequency Error:	0.01 ppm

1 of 99 Bursts

The above image shows an 802.11ad Single Carrier signal with pi/2 16QAM data modulation

Display element	Description
Standard	Display of the standard selected on the Setup > Settings > Standard Params tab.
Data Modulation	Indicates data modulation. Data modulation types are as follows: Single Carrier: pi/2 BPSK, pi/2 QPSK, pi/2 16QAM, pi/2 64QAM Control PHY: pi/2 DBPSK
Clear	Click to reset the scale measurements.
RF Power	Measures the RF power in the signal.
RCPI	Calculates the Received Channel Power Indicator from RF power.
Frequency error	The frequency difference between the measured carrier frequency of the signal and the measurement frequency setting in ppm and Hz.
Estimated SNR	Measures the estimated SNR in the measurement setup.
IQ Origin Offset	The average magnitude of the DC subcarrier level relative to total signal power. It indicates the level of carrier feedthrough detected at the center (DC) carrier.
IQ Gain Imbalance	Measures the Gain mismatch of the signal (sinusoid) in dB. It indicates the mismatch between I and Q signal paths.

Display element	Description
IQ Quadrature Error	Measures the phase part of the imbalance in degrees. It indicates the mismatch between I and Q signal paths.
Signal Quality	Measure the signal quality of the packet based on the preamble region.
EVM – Packet	<p>Gives EVM results for each packet region. The number of symbols analyzed in each region is given alongside the packet region labels.</p> <p>802.11ad Single Carrier: STF, CEF, Header, Guard, and Data</p> <p>802.11ad Control PHY: STF, CEF and Data + Header in despread symbols</p> <p>802.11ay Single Carrier 2.16 GHz BW: LSTF, LCEF, L Header, EDMG Header-A, EDMG STF, EDMG CEF Guard and Data</p> <p>802.11ay Single Carrier 4.32 GHz BW: LSTF, LCEF, L Header, EDMG Header-A, EDMG STF, EDMG CEF Guard and Data</p>
EVM	Gives Average EVM in the region of the packet.
Peak EVM	Gives the Peak error/EVM in the corresponding region of the packet.
@ Symbol	Gives the symbol index at which the peak error occurred out of the entire set of symbols in the packet (it is not an index just within the region). The symbol index shown here can be used to place a marker in the Symbol Table or EVM vs Time displays to observe the exact symbol position at which the peak error occurred.
Average results over multiple acquisitions (one burst per acquisition) Avg Data EVM Max Data EVM 1-sigma Data EVM Avg Frequency Error Max Frequency Error	<p>Gives data EVM and Frequency error results over multiple acquisitions. Gives both the Average and Max over multiple acquisitions. Also shows how many acquisitions have been used for these results below. For Data EVM, the 1-sigma variation is shown in addition to average. When the EVM unit is in %, this value is equivalent to the standard deviation statistic. When the EVM unit is in dB, this value is the standard deviation after converting EVM values to dB scale. The number of acquisitions to be used for these measurements can be selected from the EVM tab of the Settings Control panel using the Max Bursts to Avg selection.</p>
Packet Information	<p>The packet header information includes the Scrambler initialization, MCS, Length, Packet type, Training Length, Turnaround and HCS. MCS, Length and Training length are shown in decimal.</p> <p>PDDU, Aggregation, Beam Tracking Request, and Last RSSI are shown only for 802.11ad Single Carrier.</p> <p>For 802.11ay Single Carrier, EDMG MCS, BW Bitmap, Channel Aggregation, PSDU Length are shown. The Guard Length type info can be derived from the Last RSSI bits. The 2 MSB bits of Last RSSI bit convey the Guard type information (00 – Short, 01 – Normal, 10 – Long).</p>

Summary Table display settings

Settings tab	Description
Modulation Params (see page 233)	Specifies the input signal standard and other signal parameters.
Analysis Params (see page 234)	Specifies parameters used by the instrument to analyze the input signal.
Advanced Params (see page 235)	Specifies additional parameters used by the instrument to analyze the input signal.
Analysis Time (see page 236)	Specifies parameters that define the portion of the acquisition record that is used for analysis. Also allows you to specify the Units (Symbols or Seconds) and Time Zero Reference (Trigger or Acquisition Start) for 802.11ad/11ay Analysis displays.
EVM (see page 238)	Specifies the EVM units and number of data symbols to be analyzed for EVM. For Control PHY, the Start and Length of data symbols is specified in terms of de-spread symbols and also the number of Bursts to Avg by enabling the count.
Limits (see page 243)	Load and define 802.11ad measurement limits for Pass/Fail comparison. You can save defined limits as a .csv file and also load previously saved .csv files.

802.11ad/11ay Control Panel Settings

Favorites Toolbar:

The control panel tabs in this section are shared between the displays in the 802.11ad/11ay Analysis folder (Setup > Displays). Some tabs are shared by all the displays, some tabs are shared by only a couple of displays. The settings available on some tabs change depending on the selected display.

Settings tab	Description
Modulation Params (see page 233)	Specifies the type of modulation used for the input signal and other parameters.
Analysis Params (see page 234)	Specifies parameters used by the instrument to analyze the input signal.
Advanced Params (see page 235)	Specifies parameters used by the instrument to analyze the input signal.
Analysis Time (see page 236)	Specifies parameters that define the portion of the acquisition record that is used for analysis. Also allows you to specify the Units (Symbols or Seconds) and Time Zero Reference (Trigger or Acquisition Start) for 802.11ad/11ay Analysis displays.
EVM (see page 238)	Specifies the EVM units and number of data symbols to be analyzed for EVM.
Limits (see page 243)	Load and define 802.11ad/11ay measurement limits for Pass/Fail comparison. You can save defined limits as a .csv file and also load previously saved .csv files.
Traces (see page 242)	Specifies the trace type and the result content. Select either rotated or de-rotated constellation. De-rotated constellation is shown by default.
Prefs (see page 240)	Specifies the radix of the symbols, the option to see the marker readout, and whether elements of the graphs are displayed.
Scale (see page 239)	Defines the vertical and horizontal axes.

Modulation Params tab – 802.11ad/11ay

The Modulation Params tab specifies the type of modulation used by the input signal and other parameters that define the signal format. This tab is available for the 802.11ad/11ay EVM vs Time, Constellation, Symbol Table, and Summary displays.

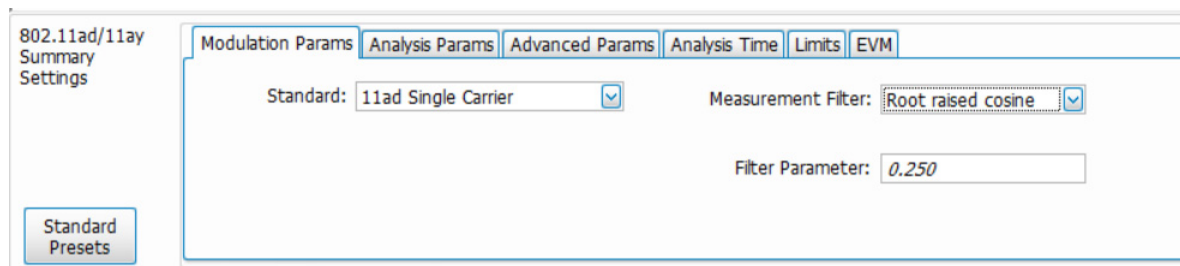

Settings	Description
Standard	Specifies the standard used for the input signal. Choices are 802.11ad Control PHY, 802.11ad Single Carrier, and 802.11ay Single Carrier.
Measurement filter	Specify whether a filter is used to limit the bandwidth of the input signal. Options are None and Root Raised Cosine.
Filter parameter	Enter a value used for defining the alpha parameter for Root Raised Cosine filter. (Not present when Measurement filter is None.)
Channel BW	Specifies whether channel bandwidth configuration for 802.11ay is 2.16 GHz or 4.32 GHz. Option visible only for 802.11ay Single Carrier modulation.
Region	Specifies the region to show in the Constellation, EVM and Symbol Table Displays when 11ay Single Carrier 4.32GHz Channel BW is chosen. Options are preEDMG1, preEDMG2 and EDMG. Replay is required if this option is changed.
Band	When a non EDMG duplicate mode is detected, a lower band (2G-L) or upper band (2G-U) can be selected using the drop-down list.

Analysis Params tab – 802.11ad/11ay

This tab contains parameters to control the analysis of the input signal. This tab is available for the 802.11ad/11ay EVM vs Time, Constellation, Symbol Table, and Summary displays.

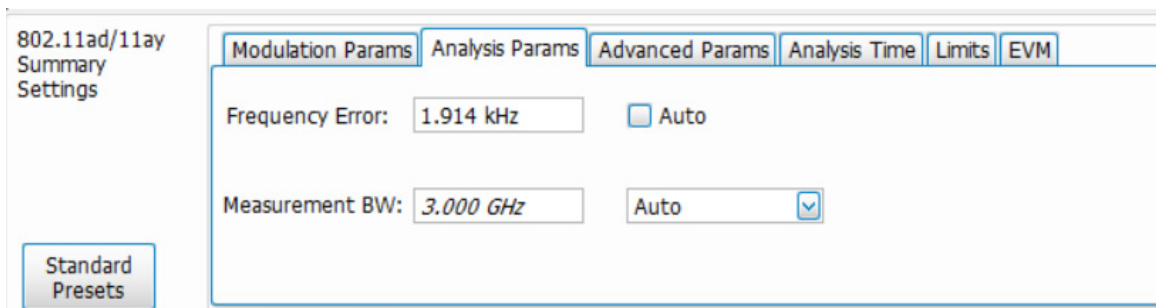

Settings	Description
Frequency Error	When Auto is checked, the analysis determines the Frequency Error and the measured Frequency Error is displayed. When unchecked, the entered value is used by the analysis as fixed frequency offset. This is useful when the exact frequency offset of the signal is known.
Measurement BW	Specifies the bandwidth about the center frequency at which measurements are made. Select Manual, Auto, or Link to Span.

Advanced Params tab – 802.11ad/11ay

This tab specifies additional parameters that control the demodulation of the signal. This tab is available for the 802.11ad/11ay EVM vs Time, Constellation, Symbol Table, and Summary displays. Not all settings appear for every display.

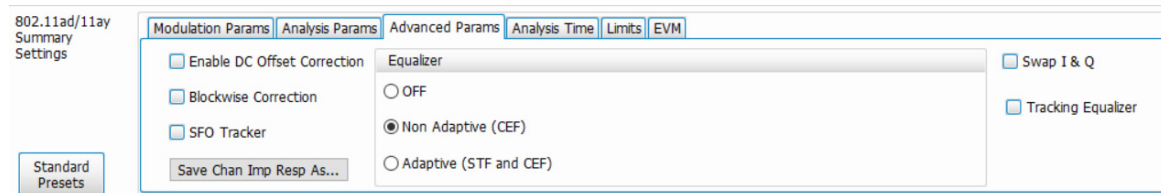

Settings	Description
Enable DC Offset Correction	Enables DC offset correction before EVM results are calculated.
Blockwise Correction	Enables impairments correction in a blockwise approach. This selection allows you to see if impairments like frequency error vary within the packet. Disabled by default.
SFO Tracker	Enables tracking and correction of Symbol Timing (Tc) errors and offsets. When disabled, the symbol timing offset is computed based on STF region (EDMG STF region in 802.11ay 4.23 GHz) and corrected for the entire packet. When enabled, it estimates and corrects for Symbol Timing errors for each data block and preamble/header regions. This option should be enabled when the reference clock of the oscilloscope is not synchronized to the transmitter.
Tracking Equalizer	In addition to the Preamble based equalizer, the Tracking Equalizer helps to correct for residual channel errors across each data block in the packet. The Tracking Equalizer coefficients are updated for each data block based on the initial set of data symbols, and applied for the full data/guard block. The coefficients are updated according to a Least Mean Square algorithm.
Save Chan Imp Resp As...	<p>Opens a file dialogue box that allows you to save the Estimated Channel Impulse response (128 coefficients). You can save it as a .txt or .csv file.</p> <p>The saved file will have two columns. The first and the second columns give the 128 real and imaginary coefficients, respectively.</p> <p>The generated coefficients are that of the last analyzed acquisition.</p> <p>The impulse response will show an early and a late multipath propagation.</p> <p>When channel response coefficients are plotted, the horizontal axis represents symbols.</p>
OFF	The EVM measurement is done with the equalizer switched off.
Non Adaptive (CEF)	The EVM measurement is done with an equalizer that is non-adaptive and the equalization is done based on the data in Channel Estimation Field (CEF).
Adaptive (STF and CEF)	The EVM measurement is done with the equalizer that adapts its coefficients from acquisition to acquisition. Equalization in this case is done based on the data in the Short Training Field (STF) and Channel Estimation Field (CEF) regions.
Mode	Specifies whether the equalizer is in learning (Train) mode or analysis (Hold) mode.
Convergence	Specifies the update rate.
Taps/Symbol	The number of filter coefficients per symbol used by the filter
Taps	The number of filter coefficients. Range: 3 to 100 (you can set a higher number, but 100 is the practical limit).
Length	Specifies the number of symbols analyzed (or filter length).
Reset Equalization	Resets the equalizer. You can read more about how to use the equalizer in the topic here (see page 490) .
Swap I & Q	Enables swapping of I & Q when there are multiple up converter stages.

Analysis Time tab – 802.11ad/11ay

This tab contains parameters that define how the signal is analyzed in the 802.11ad/11ay EVM vs Time, Constellation, Symbol Table, and Summary displays.

Settings	Description
Analysis Offset	Specifies the location of the first time sample to use in measurements.
Auto	When enabled, causes the instrument to set the Analysis Offset value based on the requirements of the selected display.
Analysis Length	Specifies the length of the analysis period to use in measurements. Length is specified in either symbols or seconds, depending on the Units.
Auto	When enabled, causes the instrument to set the Analysis Length value based on the requirements of the selected display.
Actual	This readout displays the analysis length (time or symbols) used by the analyzer. This value may not match the Analysis Length requested in manual mode.
Time Zero Reference	Specifies the zero point for the analysis time.
Units	Specifies the units of the analysis length to either Symbols or Seconds.

Analysis offset

Use analysis offset to specify where measurements begin. Be aware that you cannot set the Analysis Offset outside the range of time covered by the current acquisition data (all time values are relative to the Time Zero Reference).

You can set the Analysis Length so that the requested analysis period falls partly or entirely outside the current range of acquisition data settings. When the next acquisition is taken, its Acquisition Length will be increased to cover the new Analysis Length, as long as the Sampling controls are set to Auto. If the Sampling parameters are set to manual, or if the instrument is analyzing saved data, the actual analysis length will be constrained by the available data length, but in most cases, measurements are able to be made anyway. The instrument will display a notification when measurement results are computed from less data than requested. Range: 0 to [(end of acquisition) - Analysis Length]. Resolution: 1 effective sample (or symbol).

Analysis length

Use the analysis length to specify how long a period of time is analyzed. As you adjust this value, the actual amount of time for Analysis Length, in Symbol or Seconds units, is shown below the control in the "Actual" readout. This setting is not available when Auto is checked. Range: minimum value depends on modulation type. Resolution: 1 symbol.

Time zero reference

All time values are measured from this point (such as marker position or horizontal position (in Y vs Time displays). Choices are: Acquisition Start or Trigger.

Acquisition Start sets the analyzer to measure the offset from the starting point of the acquisition.

Trigger sets the analyzer to measure the offset from the trigger point of the acquisition.

EVM tab – 802.11ad/11ay

This tab enables you to set the EVM Units, Data Start, and Data Length. Not all settings appear for every display.

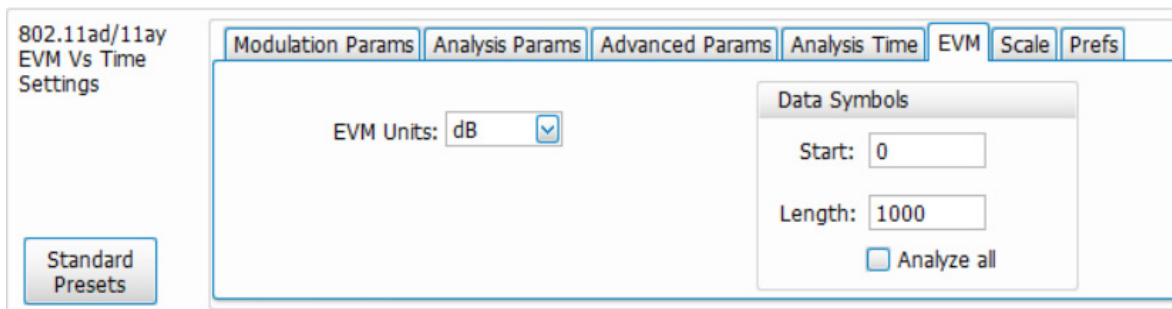

The above image is the EVM tab for the 802.11ad/11ay EVM vs Time and Constellation displays for 802.11ad Single Carrier and 802.11ay Single Carrier

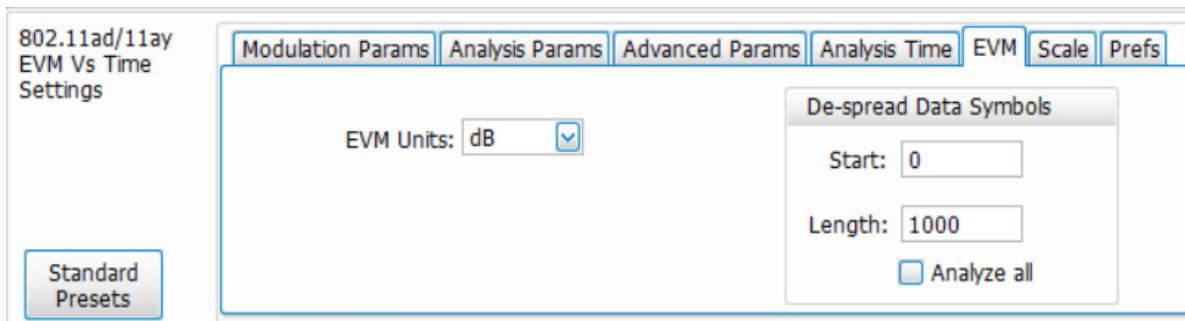

The above image is the EVM tab for the 802.11ad/11ay EVM vs Time and Constellation displays for 802.11ad Control PHY

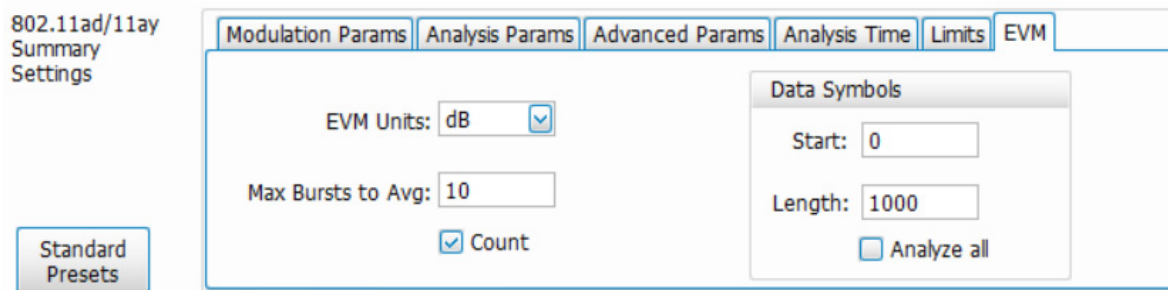

The above image is the EVM tab for the 802.11ad/11ay Summary display for 802.11ad Single Carrier

Settings	Description
EVM Units	Specifies whether the displayed EVM units are dB or percent.
Max Bursts to Avg	Specifies the maximum number of acquisitions to average when Count is selected.
Count	Enables the Avg function. Multiple acquisitions are averaged when this is enabled.
Data Symbols (for Single Carrier)	
De-spread Data Symbols (for Control PHY)	
Start	Specified the EVM measurement start data symbol.
Length	Specifies the length in terms of Data Symbols to analyze the EVM in data region starting from Start.
Analyze all	Check to analyze all data symbols in the packet. When checked, Start and Length options will be disabled. However, Length will be automatically updated to the number of data symbols analyzed when this option is selected.

Scale tab – 802.11ad/11ay

This tab allows you to change the scale settings that control how the trace appears on the display but does not change control settings such as Measurement Frequency. There are two versions of the Scale tab for 802.11ad/11ay displays. One version is used for Constellation display, and one for EVM vs Time. Not all settings appear for every display.

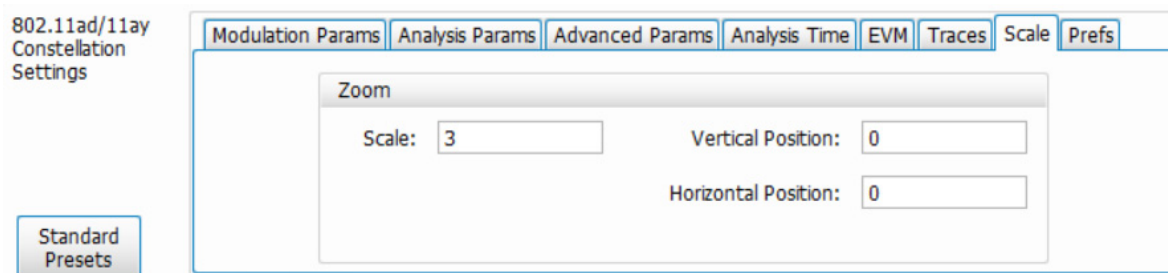

The above image is the Scale tab for the 802.11ad/11ay Constellation display

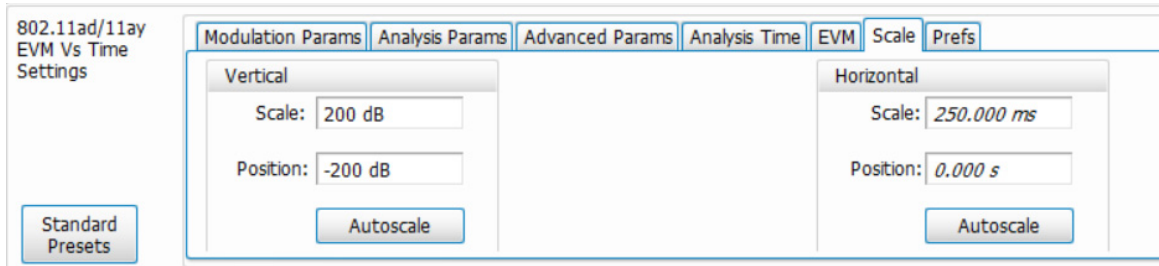

The above image is the Scale tab for the 802.11ad/11ay EVM vs Time display

Settings	Description
Vertical	
Scale	Changes the vertical scale.
Position	Adjusts the reference level away from top of the graph.
Autoscale	Resets the scale of the vertical axis to contain the complete trace.
Horizontal	
Scale	Changes the horizontal scale.
Position	Adjusts the reference level away from top of the graph.
Autoscale	Resets the scale of the vertical axis to contain the complete trace.
Zoom	
Scale	Sets the magnification value for the Constellation display.
Vertical position	Sets the vertical location of the Constellation display within the graph.
Horizontal position	Sets the horizontal location of the Constellation display within the graph.

Prefs tab – 802.11ad/11ay

This tab enables you to change appearance characteristics of the 802.11ad/11ay Analysis displays. Not all settings appear for every display.

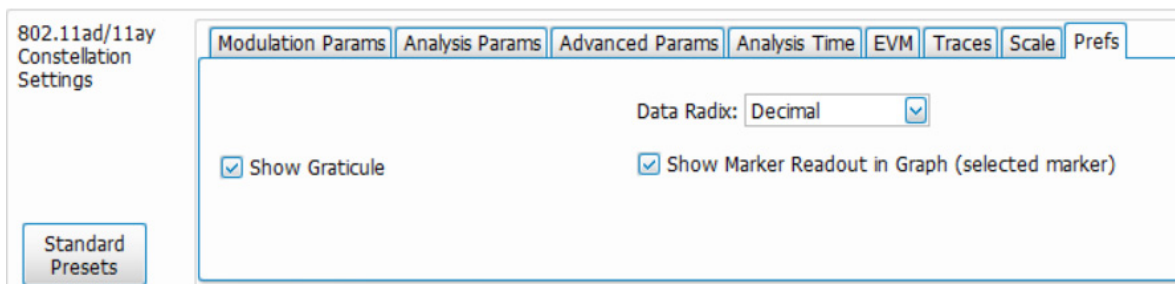

The above image is the Prefs tab for the 802.11ad/11ay Constellation display

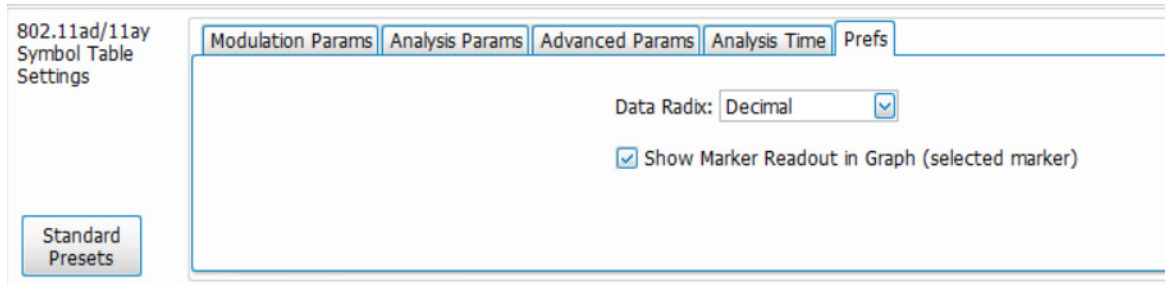

The above image is the Prefs tab for the 802.11ad/11ay Symbol Table display

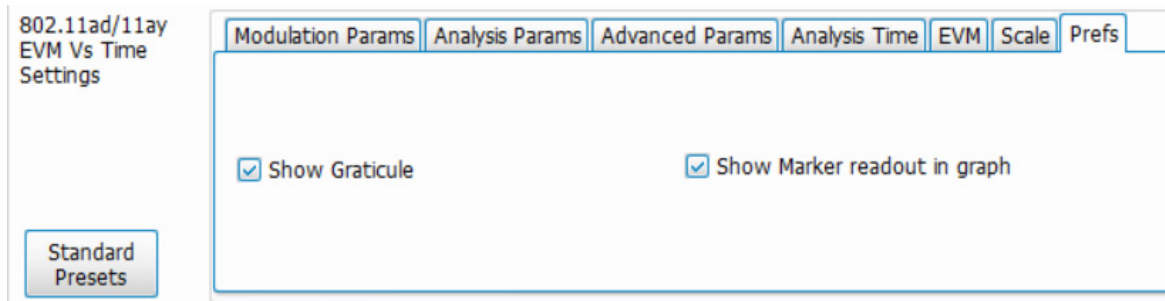

The above image is the Prefs tab for the 802.11ad/11ay EVM vs Time display

Settings	Description
Data radix	Specifies whether symbol values are displayed in binary or decimal format (for example, in the Symbol Table or markers readouts).
Show graticule	Specifies to show the graticule on the display when checked.
Show Marker readout in graph (selected marker)	Specifies to show the marker readout when checked.

Traces tab – 802.11ad/11ay

This tab allows you to set the trace display characteristics of the selected display.

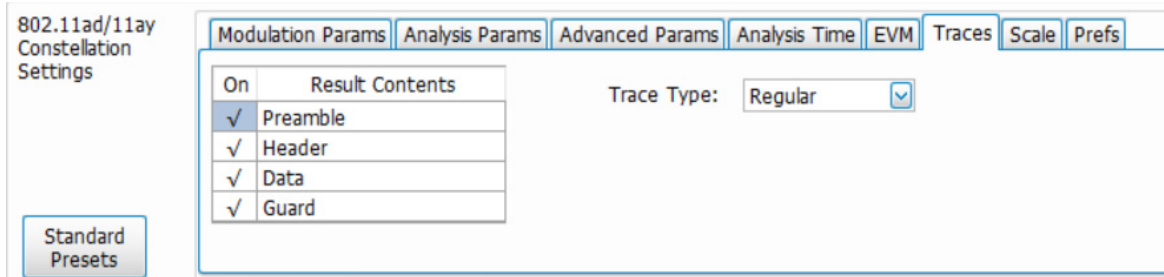

Settings	Description
Trace Type	Specifies the trace type is regular or pi/2 rotated.
Result Contents	Selects which regions of the packet to show in constellation display. You can choose from Preamble, Header, Guard, and Data for Single Carrier. You can choose from Preamble, Header, and Data for Control PHY.

Limits tab – 802.11ad/11ay

This tab allows you to load an existing limits table, save a limits table, or edit limits values. By default, FreqErrorLimit is turned on and EVMLimit is turned off. This tab is available for the 802.11ad/11ay Summary display only.

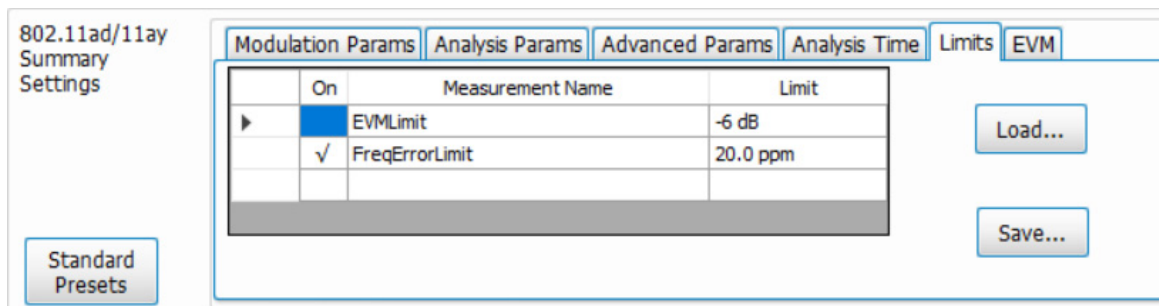

Settings	Description
On	Click on a cell in the On column next to the measurement name to specify whether or not measurements are selected for limit comparison to indicate Pass or Fail. EVMLimit is off by default and FreqErrorLimit is on by default.
Measurement Name	Specifies the name of the measurement related to the limit (not editable).
Limit	Specifies the value of the limit to the related measurement. When the cell is selected, the value is shown along with the units. This is editable.
Load	Click to load a saved Limits table from a .csv file.
Save	Click to save the current Limits table to a .csv file.

Edit Limits

To directly edit measurement limits in the table, click on the value in the Limit column that you want to change.

Overview

The OFDM Analysis option provides measurements for OFDM signals specified by 802.11a/g/j (Wifi) and 802.16 (2004) (commonly known as Fixed WiMAX) standards. User controls allow you to modify signal parameters for analysis of non-standard signals. The analysis results give multiple views of OFDM signal characteristics to allow diagnosing signal imperfections and impairments quickly and easily. Display controls provide the ability to selectively display the analysis results to help locate trouble-spots in the signal.

The displays in OFDM Measurements (Displays > Measurements > OFDM Measurements) are:

- [OFDM Channel Response \(see page 245\)](#)
- [OFDM Constellation \(see page 248\)](#)
- [OFDM EVM \(see page 249\)](#)
- [OFDM Spectral Flatness \(see page 251\)](#)
- [OFDM Mag Error \(see page 253\)](#)
- [OFDM Phase Error \(see page 255\)](#)
- [OFDM Power \(see page 257\)](#)
- [OFDM Summary \(see page 259\)](#)
- [OFDM Symbol Table \(see page 261\)](#)

OFDM Channel Response Display

The OFDM Channel Response display plots the channel response (magnitude or phase) versus the subcarrier or frequency. Here, the channel refers to all sources of signal frequency response impairment up to the analyzer input, including the transmitter itself, as well as any transmission medium through which the signal travels between the transmitter and the analyzer.

To show the OFDM Channel Response display:

1. Recall an appropriate acquisition data file.
2. Press the **Displays** button or select **Setup > Displays**.
3. In the **Select Displays** dialog, select **OFDM Analysis** in the **Measurements** box.
4. In the Available displays box, double-click the **OFDM Chan Response** icon or select the icon and click **Add**. The OFDM Chan Response icon will appear in the **Selected displays** box and will no longer appear under Available displays.
5. Click **OK** to show the OFDM Chan Response display.
6. Set the Frequency appropriate for the signal.

7. Select **Setup > Settings** to display the control panel.
8. Select the Modulation Params tab. Set the Standard, Guard Interval and Spacing and Bandwidth controls as appropriate for the input signal.

Elements of the Display

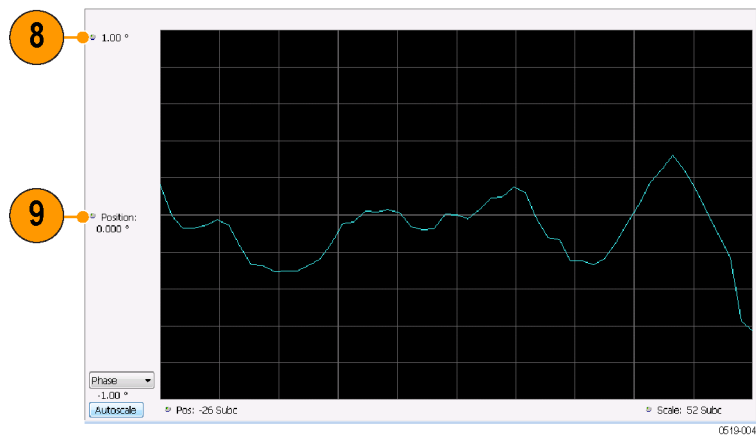
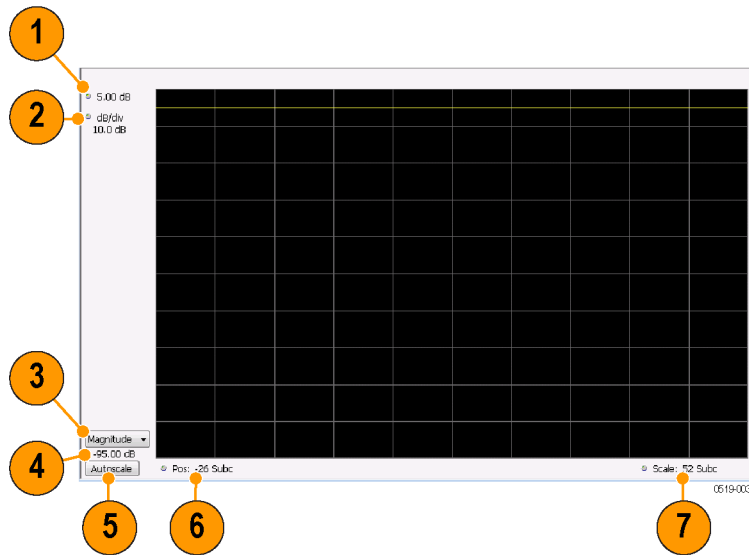

Item	Display element	Description
1	Top-of-graph (magnitude)	Sets the level that appears at the top of the magnitude graph. This is only a visual control for panning the graph. The Reference Level is adjusted in the Toolbar and the Ampl control panel. By default, Vert Position = Ref Level.
2	dB/div (magnitude)	Sets the vertical scale value. The maximum value is 20.00 dB/division.
3	Display selector	Selects the display type. Channel Response Magnitude or Phase can be displayed as a Magnitude or Phase graph.
4	Bottom-of-graph readout (magnitude)	Indicates the amplitude at the bottom of the graph. This value changes with the dB/div and Vertical Position settings.
5	Autoscale	Adjusts the Vertical and Horizontal scaling to display the optimize the trace display on screen.
6	Pos	Shifts the trace left or right in the graph. The readout indicates the subcarrier or frequency shown at the left edge of the display.
7	Scale	Specifies the number of subcarriers shown in the graph.
8	Top-of-graph (phase)	Sets the phase value indicated at the top of the graph. Since the Position value at the vertical center of this graph remains constant as the Top of Graph value is adjusted, the Vertical Scale increases as the Top of Graph value increases, which also affects the bottom of graph readout.
9	Position (phase)	Specifies the phase shown at the center of the graph display. Changing this value moves the trace up and down in the graph, which affects the Top of Graph and Bottom of Graph values as well.
10	Bottom-of-graph (phase)	Indicates the phase at the bottom of the graph. This value changes with the Position setting.

OFDM Channel Response Settings

The OFDM Channel Response Settings control panel provides access to settings that control parameters of the Channel Response Display.

Settings tab	Description
Modulation Params (see page 263)	Specifies the input signal standard and additional user-settable signal parameters.
Advanced Params (see page 264)	Specifies parameters used by the instrument to analyze the input signal.
Data Range Tab (see page 265)	Specifies which symbols and subcarriers of the signal to display.
Analysis Time Tab (see page 265)	Specifies parameters that define the portion of the acquisition record that is used for analysis. Also allows you to specify the time units (Symbols or Seconds) for OFDM Analysis displays.
Prefs Tab (see page 269)	Specifies the units of the display and whether elements of the graphs are displayed.

OFDM Constellation Display

Display shows the OFDM signal subcarriers' amplitude and phase in IQ constellation form.

To show the OFDM Constellation display:

1. Recall an appropriate acquisition data file.
2. Press the **Displays** button or select **Setup > Displays**.
3. In the **Select Displays** dialog, select **OFDM Constellation** in the **Measurements** box.
4. In the Available displays box, double-click the **OFDM Constellation** icon or select the icon and click **Add**. The OFDM Constellation icon will appear in the **Selected displays** box and will no longer appear under Available displays.
5. Click **OK** to show the OFDM Constellation display.
6. Set the **Frequency** appropriate for the signal.
7. Select **Setup > Settings** to display the control panel.
8. Select the **Modulation Params** tab. Set the Standard, Guard Interval and Spacing and Bandwidth controls as appropriate for the input signal.

Elements of the Display

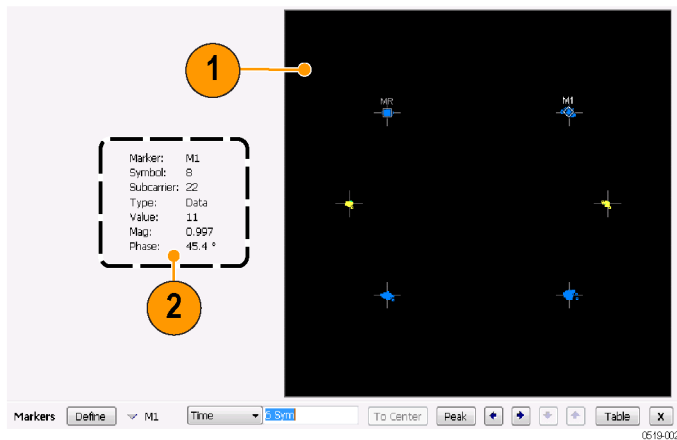

Item	Display element	Description
1	Plot	Constellation graph.
2	Marker Readout	If markers are enabled, the marker readout shows the selected Marker, Symbol, Subcarrier, Type, Value, Magnitude, and Phase for the symbol at the marker location. Located to the left of the constellation plot or below it, depending on the size of the window.

OFDM Constellation Settings

Main menu bar: Setup > Settings

Favorites toolbar: 

The OFDM Constellation Settings control panel provides access to settings that control parameters of the Constellation Display.

Settings tab	Description
Modulation Params (see page 263)	Specifies the input signal standard and additional user-settable signal parameters.
Advanced Params (see page 264)	Specifies parameters used by the instrument to analyze the input signal.
Data Range (see page 265)	Specifies which symbols and subcarriers of the signal to display.
Analysis Time Tab (see page 265)	Specifies parameters that define the portion of the acquisition record that is used for analysis. Also allows you to specify the Units (Symbols or Seconds) for OFDM Analysis displays.
Trace (see page 267)	Enables you to freeze the display or hide the measurement or average trace.
Scale Tab (see page 267)	Specifies the Zoom scale, and vertical and horizontal positions of the display.
Prefs Tab (see page 269)	Specifies the units of the display and whether elements of the graphs are displayed.

OFDM EVM Display

The OFDM EVM display shows the data symbols' individual subcarrier Error Vector Magnitude values versus symbol interval (time) and subcarrier (frequency).

To show the OFDM EVM display:

1. Recall an appropriate acquisition data file.
2. Press the **Displays** button or select **Setup > Displays**.
3. In the **Select Displays** dialog, select **OFDM EVM** in the **Measurements** box.
4. In the Available displays box, double-click the **OFDM EVM** icon or select the icon and click **Add**. The OFDM EVM icon will appear in the **Selected displays** box and will no longer appear under Available displays.

5. Click **OK** to show the OFDM EVM display.
6. Set the **Frequency** appropriate for the signal.
7. Select **Setup > Settings** to display the control panel.
8. Select the **Modulation Params** tab. Set the Standard as appropriate. Set the Standard, Guard Interval and Spacing and Bandwidth controls as appropriate for the input signal.

Elements of the Display

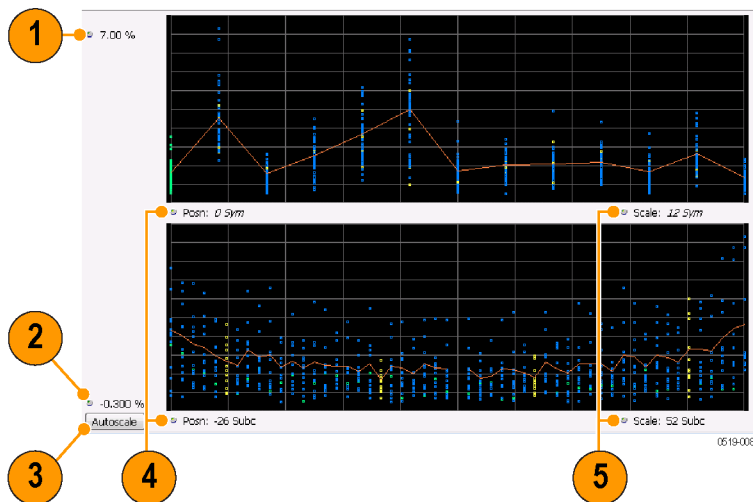

NOTE. *There is no carrier assigned to DC.*

Item	Display element	Description
1	Top of graph	Sets the EVM value that appears at the top of the graph. This is only a visual control for panning the graph.
2	Bottom of graph	Sets the EVM value that appears at the bottom of the graph. This is only a visual control for panning the graph.
3	Autoscale	Adjusts the vertical and horizontal settings to provide the best display.
4	Pos	Specifies the horizontal position of the trace on the graph display.
5	Scale	Adjusts the horizontal range of the graph. By decreasing the scale, the graph essentially becomes a window that you can move over the analysis results by adjusting the position.

OFDM EVM Settings

Main menu bar: Setup > Settings

Favorites toolbar:

The settings for the OFDM EVM display are shown in the following table.

Settings tab	Description
Modulation Params (see page 263)	Specifies the type of modulation used for the input signal and other parameters.
Advanced Params (see page 264)	Specifies parameters used by the instrument to analyze the input signal.
Data Range (see page 265)	Specifies which symbols and subcarriers of the signal to display.
Analysis Time (see page 265)	Specifies parameters that define the portion of the acquisition record that is used for analysis. Also allows you to specify the Units (Symbols or Seconds) for OFDM Analysis displays.
Trace (see page 267)	Enables you to freeze the display or hide the measurement or average trace.
Scale (see page 267)	Specifies the vertical, subcarrier, and symbols scale and position settings.
Prefs (see page 269)	Specifies the units of the display and whether elements of the graphs are displayed.

OFDM Spectral Flatness Display

The OFDM Spectral Flatness display shows the average power levels of subcarriers across the signal bandwidth and indicates if they remain within the limits defined for a particular standard.

The averaged subcarrier level is shown as a line on the display, while the individual subcarrier levels are shown as points. The Pass or Fail result indicates whether the average line remains between the upper and lower limit mask boundaries.

To show the OFDM Spectral Flatness display:

1. Recall an appropriate acquisition data file.
2. Press the **Displays** button or select **Setup > Displays**.
3. In the **Select Displays** dialog, select **OFDM Analysis** in the **Measurements** box.
4. In the Available displays box, double-click the **OFDM Flatness** icon or select the icon and click **Add**. The OFDM Flatness icon will appear in the **Selected displays** box and will no longer appear under Available displays.
5. Click **OK** to show the OFDM Flatness display.
6. Set the **Frequency** appropriate for the signal.
7. Select **Setup > Settings** to display the control panel.
8. Select the **Modulation Params** tab. Set the Standard, Guard Interval, Subcarrier Spacing and Channel Bandwidth controls as appropriate for the input signal.

Elements of the Display

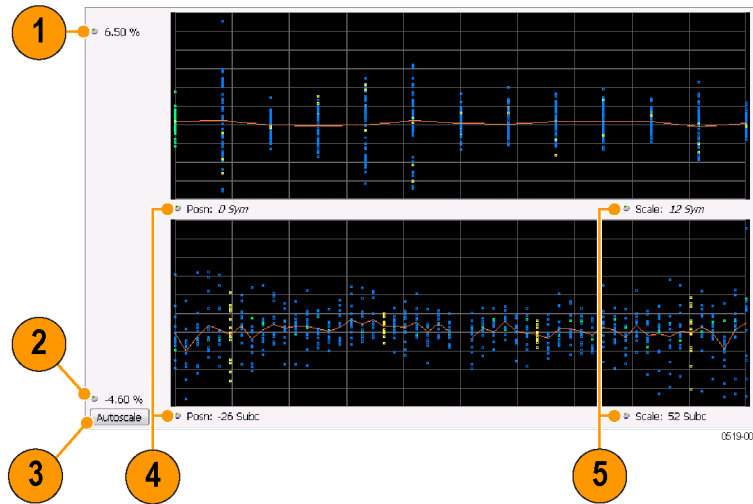

Item	Display element	Description
1	Top of graph	Sets the Flatness value that appears at the bottom of the graph in dB. This is only a visual control for panning the graph.
2	Bottom of graph	Shows the Flatness value set at the top of the graph.
3	Autoscale	Adjusts the vertical and horizontal settings to provide the best display.
4	Pos	Specifies the horizontal position of the trace on the graph display.
5	Scale	Adjusts the horizontal range of the graph. By decreasing the scale, the graph essentially becomes a window that you can move over the analysis results by adjusting the position.

OFDM Spectral Flatness Settings

Main menu bar: Setup > Settings

Favorites toolbar: 

The settings for the OFDM Spectral Flatness display are shown in the following table.

Settings tab	Description
Modulation Params (see page 263)	Specifies the type of modulation used for the input signal and other parameters.
Advanced Params (see page 264)	Specifies parameters used by the instrument to analyze the input signal.
Data Range (see page 265)	Specifies which symbols and subcarriers of the signal to display.
Analysis Time Tab (see page 265)	Specifies parameters that define the portion of the acquisition record that is used for analysis. Also allows you to specify the Units (Symbols or Seconds) for WLAN Analysis displays.
Trace (see page 267)	Enables you to display or hide the measurement or average trace.
Scale Tab (see page 267)	Specifies the vertical, subcarrier, and symbols scale and position settings.
Prefs Tab (see page 269)	Specifies the units of the display and whether elements of the graphs are displayed.

OFDM Magnitude Error Display

The OFDM Mag Error display shows the data symbols' individual subcarrier Magnitude Error values versus symbol interval (time) and subcarrier (frequency).

To show the OFDM Magnitude Error display:

1. Recall an appropriate acquisition data file.
2. Press the **Displays** button or select **Setup > Displays**.
3. In the **Select Displays** dialog, select **OFDM Analysis** in the **Measurements** box.
4. In the Available displays box, double-click the **OFDM Mag Error** icon or select the icon and click **Add**. The OFDM Mag Error icon will appear in the **Selected displays** box and will no longer appear under Available displays.
5. Click **OK** to show the OFDM Mag Error display.
6. Set the **Frequency** appropriate for the signal.
7. Select **Setup > Settings** to display the control panel.
8. Select the **Modulation Params** tab. Set the Standard, Guard Interval and Spacing and Bandwidth controls as appropriate for the input signal.

Elements of the Display

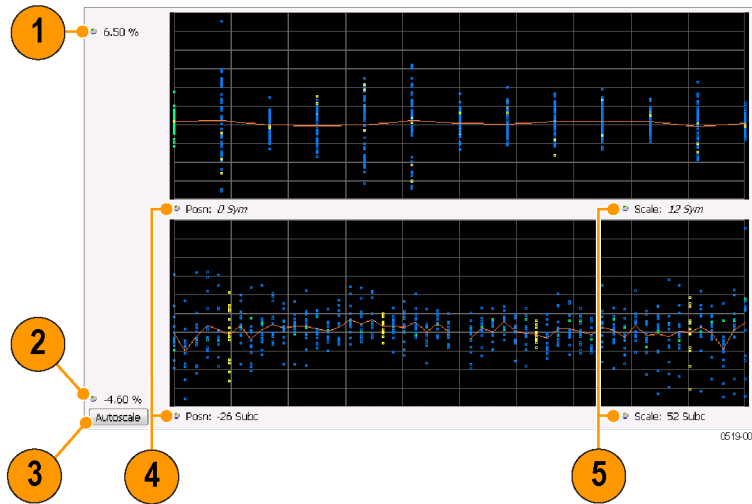

Item	Display element	Description
1	Top of graph	Sets the Magnitude Error value that appears at the top of the graph. This is only a visual control for panning the graph.
2	Bottom of graph	Sets the Magnitude Error value that appears at the bottom of the graph. This is only a visual control for panning the graph.
3	Autoscale	Adjusts the vertical and horizontal settings to provide the best display.
4	Pos	Specifies the horizontal position of the trace on the graph display.
5	Scale	Adjusts the horizontal range of the graph. By decreasing the scale, the graph essentially becomes a window that you can move over the analysis results by adjusting the position.

OFDM Magnitude Error Settings

Main menu bar: Setup > Settings

Favorites toolbar: 

The settings for the OFDM Mag Error display are shown in the following table.

Settings tab	Description
Modulation Params (see page 263)	Specifies the type of modulation used for the input signal and other parameters.
Advanced Params (see page 264)	Specifies parameters used by the instrument to analyze the input signal.
Data Range (see page 265)	Specifies which symbols and subcarriers of the signal to display.
Analysis Time Tab (see page 265)	Specifies parameters that define the portion of the acquisition record that is used for analysis. Also allows you to specify the Units (Symbols or Seconds) for OFDM Analysis displays.
Trace (see page 267)	Enables you to display or hide the measurement or average trace.
Scale Tab (see page 267)	Specifies the vertical, subcarrier, and symbols scale and position settings.
Prefs Tab (see page 269)	Specifies the units of the display and whether elements of the graphs are displayed.

OFDM Phase Error Display

The OFDM Phase Error display shows the data symbols' individual subcarrier Phase Error values versus symbol interval (time) and subcarrier (frequency).

To show the OFDM Phase Error display:

1. Recall an appropriate acquisition data file.
2. Press the **Displays** button or select **Setup > Displays**.
3. In the **Select Displays** dialog, select **OFDM Analysis** in the **Measurements** box.
4. In the Available displays box, double-click the **OFDM Phase Error** icon or select the icon and click **Add**. The OFDM Phase Error icon will appear in the **Selected displays** box and will no longer appear under Available displays.
5. Click **OK** to show the OFDM Phase Error display.
6. Set the **Frequency** appropriate for the signal.
7. Select **Setup > Settings** to display the control panel.
8. Select the **Modulation Params** tab. Set the Standard, Guard Interval and Spacing and Bandwidth controls as appropriate for the input signal.

Elements of the Display

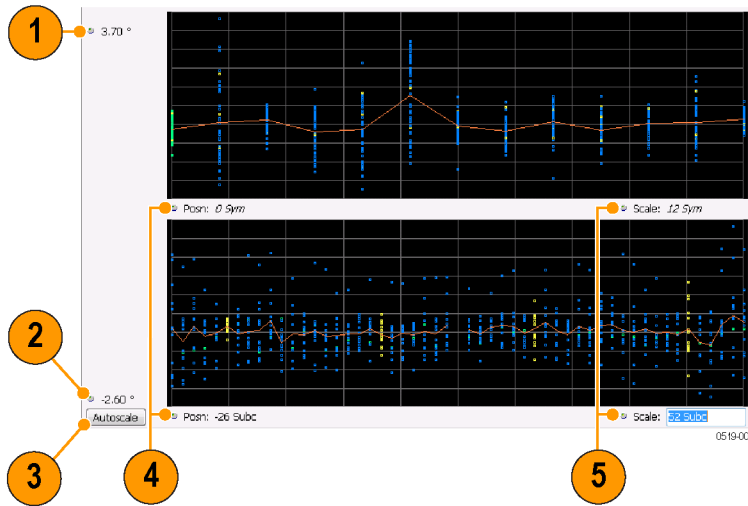

Item	Display element	Description
1	Top of graph	Sets the Phase Error value that appears at the top of the graph. This is only a visual control for panning the graph.
2	Bottom of graph	Sets the Phase Error value that appears at the bottom of the graph. This is only a visual control for panning the graph.
3	Autoscale	Adjusts the vertical and horizontal settings to provide the best display.
4	Pos	Specifies the horizontal position of the trace on the graph display.
5	Scale	Adjusts the horizontal range of the graph. By decreasing the scale, the graph essentially becomes a window that you can move over the analysis results by adjusting the position.

OFDM Phase Error Settings

Main menu bar: Setup > Settings

Favorites toolbar: 

The settings for the OFDM Phase Error display are shown in the following table.

Settings tab	Description
Modulation Params (see page 263)	Specifies the type of modulation used for the input signal and other parameters.
Advanced Params (see page 264)	Specifies parameters used by the instrument to analyze the input signal.
Data Range (see page 265)	Specifies which symbols and subcarriers of the signal to display.
Analysis Time Tab (see page 265)	Specifies parameters that define the portion of the acquisition record that is used for analysis. Also allows you to specify the Units (Symbols or Seconds) for OFDM Analysis displays.
Trace (see page 267)	Enables you to display or hide the measurement or average trace.
Scale Tab (see page 267)	Specifies the vertical, subcarrier, and symbols scale and position settings.
Prefs Tab (see page 269)	Specifies the units of the display and whether elements of the graphs are displayed.

OFDM Power Display

The OFDM Power display shows the data symbols' individual subcarrier Power values versus symbol interval (time) and subcarrier (frequency).

To show the OFDM Power display:

1. Recall an appropriate acquisition data file.
2. Press the **Displays** button or select **Setup > Displays**.
3. In the **Select Displays** dialog, select **OFDM Analysis** in the **Measurements** box.
4. In the Available displays box, double-click the **OFDM Power** icon or select the icon and click **Add**. The OFDM Power icon will appear in the **Selected displays** box and will no longer appear under Available displays.
5. Click **OK** to show the OFDM Power display.
6. Set the **Frequency** appropriate for the signal.
7. Select **Setup > Settings** to display the control panel.
8. Select the **Modulation Params** tab. Set the Standard, Guard Interval and Spacing and Bandwidth controls as appropriate for the input signal.

Elements of the Display

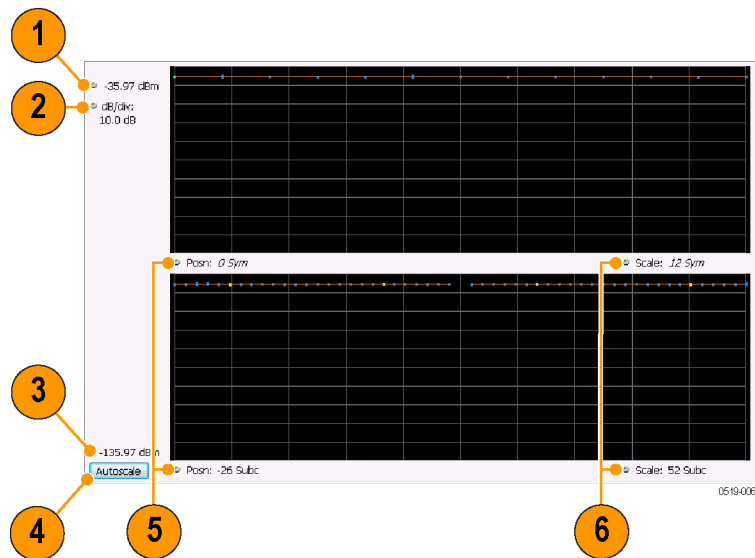

Item	Display element	Description
1	Vertical Position	Sets the top of graph value. This is only a visual control for panning the graph. The Reference Level is adjusted in the Toolbar and the Ampl control panel. By default, Vert Position = Ref Level.
2	dB/div	Sets the vertical scale value. The maximum value is 20.00 dB/division.
(not shown)	Units	Sets the global amplitude units for all the views in the analysis window. This will change the amplitude selection in the Units tab of the Amplitude control panel.
2	Bottom of graph readout	Indicates the amplitude at the bottom of the graph. This value changes with the dB/div and Vertical Position settings.
3	Autoscale	Adjusts the vertical and horizontal settings to provide the best display.
4	Pos	Specifies the horizontal position of the trace on the graph display.
5	Scale	Adjusts the horizontal range of the graph. By decreasing the scale, the graph essentially becomes a window that you can move over the analysis results by adjusting the position.

OFDM Power Settings

Main menu bar: Setup > Settings

Favorites toolbar: 

The settings for the OFDM Power display are shown in the following table.

Settings tab	Description
Modulation Params (see page 263)	Specifies the type of modulation used for the input signal and other parameters.
Advanced Params (see page 264)	Specifies parameters used by the instrument to analyze the input signal.
Data Range (see page 265)	Specifies which symbols and subcarriers of the signal to display.
Analysis Time (see page 265)	Specifies parameters that define the portion of the acquisition record that is used for analysis. Also allows you to specify the Units (Symbols or Seconds) for OFDM Analysis displays.
Trace (see page 267)	Enables you to display or hide the measurement or average trace.
Scale (see page 267)	Specifies the vertical, subcarrier, and symbols scale and position settings.
Prefs (see page 269)	Specifies the units of the display and whether elements of the graphs are displayed.

OFDM Summary Display

The OFDM Summary display shows several measurements of OFDM signal quality.

To show the OFDM Summary display:

1. Recall an appropriate acquisition data file.
2. Press the **Displays** button or select **Setup > Displays**.
3. In the **Select Displays** dialog, select **OFDM Analysis** in the **Measurements** box.
4. In the Available displays box, double-click the **OFDM Summary** icon or select the icon and click **Add**. The OFDM Summary icon will appear in the **Selected displays** box and will no longer appear under Available displays.
5. Click **OK** to show the OFDM Summary display.
6. Set the **Frequency** appropriate for the signal.
7. Select **Setup > Settings** to display the control panel.
8. Select the **Modulation Params** tab. Set the Standard, Guard Interval and Spacing and Bandwidth controls as appropriate for the input signal.

Elements of the Display

Frequency: 5.90000 GHz RefLvl: 0.00 dBm Preset Replay Run

802.11a/g/j Symbols: 13

Frequency Error: 1.75 Hz Symbol Clk Error: -0.502 ppm

IQ Origin Offset: -74.31 dB CPE: 1.509 %

Average Power: -24.31 dBm Peak-to-Average: 9.53 dB

Subcarriers:	All	Pilots	Data
RMS EVM:	-35.17 dB	-36.43 dB	-35.08 dB
	1.744 %	1.509 %	1.763 %
Peak EVM:	-23.75 dB	-27.80 dB	-23.75 dB
	6.492 %	4.074 %	6.492 %
at symbol:	1	5	1
at subcarrier:	26	21	26

Measurement	Description
Standard	Display of the standard selected on the Setup > Settings > Modulation Params tab.
Frequency Error	The frequency difference between the measured carrier frequency of the signal and the measurement frequency setting.
IQ Origin Offset	The average magnitude of the DC subcarrier level relative to total signal power. It indicates the level of carrier feedthrough detected at the center (DC) subcarrier.
Average Power	The average power of all symbols in the analysis. Calculated over only the data symbols in the packet.
Symbols	How many symbols were analyzed.
Symbol Clk Error	The symbol clock error in parts per million.
CPE	CPE, Common Pilot Error, is the RMS magnitude error of the pilots over all analyzed symbols.
Peak-to-Average	The ratio of the highest instantaneous signal power level to the average signal power. Calculated over only the data symbols in the packet.
EVM	The RMS and Peak values of the normalized subcarrier Error Vector Magnitude values. The normalized subcarrier EVM values are calculated as the difference between the detected received signal subcarrier constellation points and ideal reference points estimated by the instrument from the received signal. Values are reported in units of percent and dB. Peak values include the symbol and subcarrier location. RMS and Peak values are displayed for groupings of all subcarriers, Pilots only and Data only. Results are calculated over the entire signal packet analyzed, covering the number of Symbols indicated in the Summary display.

OFDM Summary Settings

Main menu bar: Setup > Settings

Favorites toolbar: 

The settings for the OFDM Summary display are shown in the following table.

Settings tab	Description
Modulation Params (see page 263)	Specifies the type of modulation used for the input signal and other parameters.
Advanced Params (see page 264)	Specifies parameters used by the instrument to analyze the input signal.
Data Range (see page 265)	Specifies which symbols and subcarriers of the signal to display.
Analysis Time (see page 265)	Specifies parameters that define the portion of the acquisition record that is used for analysis. Also allows you to specify the Units (Symbols or Seconds) for OFDM Analysis displays.
Prefs (see page 269)	Specifies the units of the display and whether elements of the graphs are displayed.

OFDM Symbol Table Display

The OFDM Symbol Table display shows decoded data bits for each subcarrier in each symbol in the analyzed signal packet. Results are presented with subcarrier (frequency) indices in the horizontal dimension and symbol (time) intervals in the vertical dimension.

To show the OFDM Symbol Table display:

1. Recall an appropriate acquisition data file.
2. Press the **Displays** button or select **Setup > Displays**.
3. In the **Select Displays** dialog, select **OFDM Analysis** in the **Measurements** box.
4. In the Available displays box, double-click the **OFDM Symb Table** icon or select the icon and click **Add**. The OFDM Symbol icon will appear in the **Selected displays** box and will no longer appear under Available displays.
5. Click **OK** to show the OFDM Symbol Table display.
6. Set the **Frequency** appropriate for the signal.
7. Select **Setup > Settings** to display the control panel.
8. Select the **Modulation Params** tab. Set the Standard, Guard Interval and Spacing and Bandwidth controls as appropriate for the input signal.

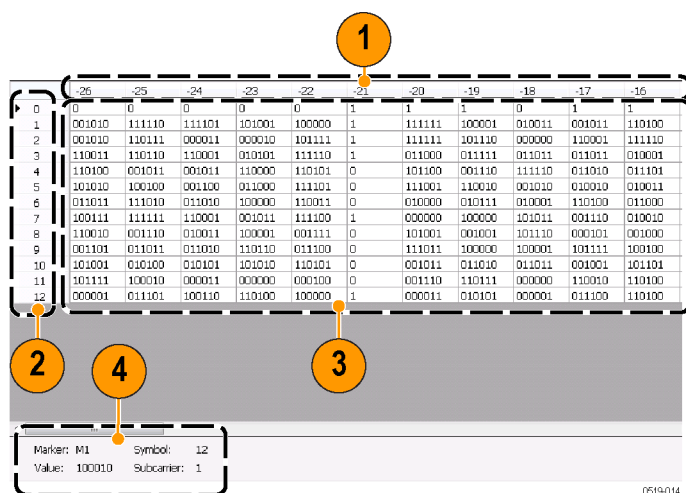

Item	Description
1	Subcarrier identifiers.
2	Symbol identifiers.

(cont.)

Item	Description
3	Subcarrier data values.
4	Marker readout when markers are enabled.

OFDM Symbol Table Settings

Main menu bar: Setup > Settings

Favorites toolbar: 

The settings for the OFDM Symbol Table display are shown in the following table.

Settings tab	Description
Modulation Params (see page 263)	Specifies the type of modulation used for the input signal and other parameters.
Advanced Params (see page 264)	Specifies parameters used by the instrument to analyze the input signal.
Data Range (see page 265)	Specifies which symbols and subcarriers of the signal to display.
Analysis Time (see page 265)	Specifies parameters that define the portion of the acquisition record that is used for analysis. Also allows you to specify the Units (Symbols or Seconds) for OFDM Analysis displays.
Prefs (see page 269)	Specifies the units of the display and whether elements of the graphs are displayed.

OFDM Analysis Shared Measurement Settings

Main menu bar: Setup > Settings

Favorites toolbar: 

The control panel tabs in this section are shared between the displays in the OFDM Analysis folder (Setup > Displays). Some tabs are shared by all the displays, some tabs are shared by only a couple of displays. The settings available on some tabs change depending on the selected display.

Common controls for OFDM analysis displays

Settings tab	Description
Modulation Params (see page 263)	Specifies the type of modulation used for the input signal and other parameters.
Advanced Params (see page 264)	Specifies parameters used by the instrument to analyze the input signal.
Data Range (see page 265)	Specifies which symbols and subcarriers of the signal to display.
Analysis Time (see page 265)	Specifies parameters that define the portion of the acquisition record that is used for analysis. Also allows you to specify the Units (Symbols or Seconds) for OFDM Analysis displays.
Trace (see page 267)	Enables you to display or hide the measurement or average trace.
Scale (see page 267)	Specifies the vertical, subcarrier, and symbols scale and position settings.
Prefs (see page 269)	Specifies the units of the display and whether elements of the graphs are displayed.

Modulation Params Tab - OFDM

The Modulation Params tab specifies the type of modulation used by the input signal and other parameters that control the demodulation of the input signal.

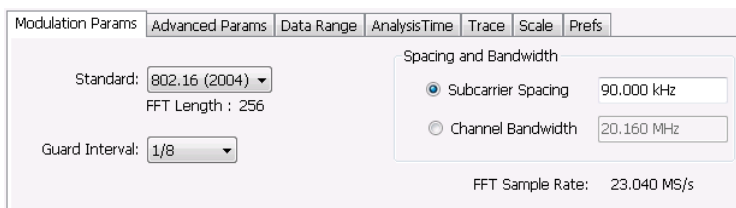

Settings	Description
Standard	Specifies the standard used for the input signal. Choices are 802.11a/g/j and 802.16 (2004).
Guard Interval	Specifies the guard interval used in the input signal. Choices are 1/4, 1/8, 1/16, 1/32, and User. When you select User, you can enter a percentage value to specify the size of the guard interval as a percentage of the useful symbol interval. The Guard Interval range is 0–100%.
Spacing and Bandwidth	Specifies the spacing between subcarriers and the nominal channel bandwidth. Only one of these settings can be set at a time, the other setting is automatically calculated.
Sample Rate	Indicates the FFT sample rate, based on the bandwidth or subcarrier setting.

Advanced Params Tab - OFDM

The Advanced Params tab contains parameters that control the analysis of the input signal.

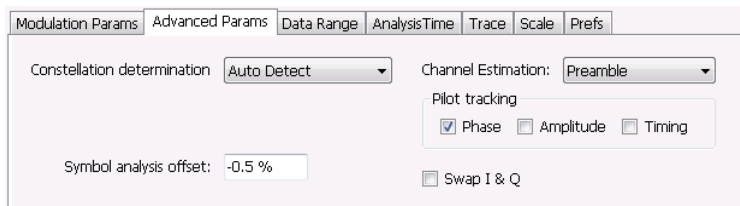

Settings	Description
Constellation determination	Specifies the method used to detect the constellation. Auto Detect analyzes the signal to determine the appropriate constellation, Manual allows you to specify the constellation type. Manual choices are: BPSK, QPSK, 16QAM, and 64QAM.
Symbol analysis offset	Specifies the analysis offset in the symbol interval. This value is a percentage of the Guard Interval. The allowable range is -100% to 0%. -100% positions the FFT to start at the beginning of the Guard Interval, 0% positions it to start at the end of the Guard Interval. Default value is -50% which usually gives the best measurement results.
Channel Estimation	Specifies the method used to estimate channel frequency response and equalization. This control can be used to diagnose changes in frequency response over the signal packet.
Preamble	When you select Preamble, the instrument uses only the Preamble to estimate channel frequency response. This response is then used to equalize the entire signal packet.
Preamble + Data	When you select Preamble + Data, the instrument makes an initial channel frequency response estimate from the Preamble. Then estimates the channel response for each data symbol using the decoded data content to derive equalization for each symbol individually. This allows compensation for time-varying channel response over the packet.
Pilot tracking	Specifies if pilot subcarriers should be used to correct amplitude, phase, and symbol timing variations over the packet. The choices available are Phase, Amplitude, and Timing. The default setting is Phase.
Swap I & Q	Select the checkbox to swap the I and Q components of a signal. This compensates the input signal for spectral inversion.

Data Range Tab - OFDM

The Data Range tab enables you to control how much signal is analyzed, as well as specify the range of results that are displayed in the Constellation, EVM, Magnitude Error, Phase Error, Power and Symbol Table graphs.

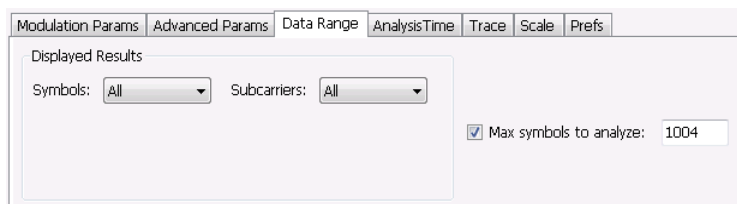

Settings	Description
Symbols	Specifies which symbols are displayed in the graphs.
All	Select All to display all symbols.
Range	Select Range to specify a subset of symbols for display.
Start	Specifies the first symbol to include in the display.
Number	Specifies how many symbols to display in the graphs.
Single	Select Single to display a single symbol.
Index	Use Index to specify the symbol you want to display.
Subcarriers	Specifies which subcarriers are displayed.
All	Select All to display all subcarriers in the signal.
Pilots Only	Select Pilot to display only pilot subcarriers.
Data Only	Select Data to display only data subcarriers.
Single	Specifies a specific subcarrier for display.
Index	Specifies the specific subcarrier to be displayed.
Range	Specifies a range to subcarriers to be displayed.
Start	Specifies the start value of the range to be displayed.
Stop	Specifies the ending value of the range to be displayed.
Max symbols to analyze	Specifies how many symbols are analyzed. You can use this setting to speed analysis by limiting the number of symbols being analyzed.

Analysis Time Tab - OFDM

The Analysis Time tab contains parameters that define how the signal is analyzed in the OFDM Analysis displays.

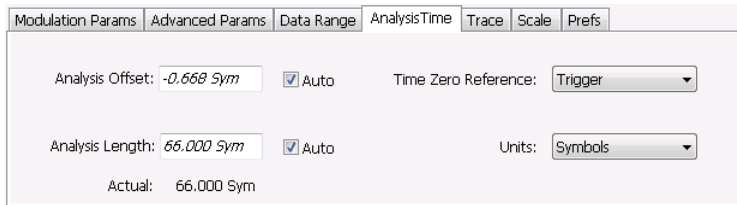

Settings	Description
Analysis Offset	Specifies the location of the first time sample to use in measurements.
Auto	When enabled, causes the instrument to set the Analysis Offset value based on the requirements of the selected display.
Analysis Length	Specifies the length of the analysis period to use in measurements. Length is specified in either symbols or seconds, depending on the Units setting.
Auto	When enabled, causes the instrument to set the Analysis Length value based on the requirements of the selected display.
Actual	This is a displayed value, not a setting. It is the Analysis Length (time or symbols) being used by the analyzer, this value may not match the Analysis Length requested (in manual mode).
Time Zero Reference	Specifies the zero point for the analysis time.
Units	Specifies the units of the Analysis Length to either Symbols or Seconds.

Analysis Offset

Use analysis offset to specify where measurements begin. Be aware that you cannot set the Analysis Offset outside the range of time covered by the current acquisition data. (all time values are relative to the Time Zero Reference).

You can set the Analysis Length so that the requested analysis period falls partly or entirely outside the current range of acquisition data settings. When the next acquisition is taken, its Acquisition Length will be increased to cover the new Analysis Length, as long as the Sampling controls are set to Auto. If the Sampling parameters are set to manual, or if the instrument is analyzing saved data, the actual analysis length will be constrained by the available data length, but in most cases, measurements are able to be made anyway. The instrument will display a notification when measurement results are computed from less data than requested. Range: 0 to [(end of acquisition) - Analysis Length]. Resolution: 1 effective sample (or symbol).

Analysis Length

Use the analysis length to specify how long a period of time is analyzed. As you adjust this value, the actual amount of time for Analysis Length, in Symbol or Seconds units, is shown below the control in the "Actual" readout. This setting is not available when Auto is checked. Range: minimum value depends on modulation type. Resolution: 1 symbol.

Time Zero Reference

All time values are measured from this point (such as marker position or horizontal position (in Y vs Time displays)). Choices are: Acquisition Start or Trigger.

Parameter	Description
Acquisition Start	Offset is measured from the point at which acquisition begins.
Trigger	Offset is measured from the trigger point.

Trace Tab - OFDM

The Trace tab allows you to set the trace display characteristics of the selected display. This tab is not available for all OFDM displays.

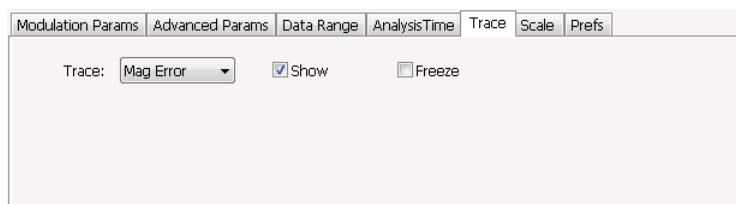

Settings	Description
Trace	Use this drop-down list to select whether or not the Average trace or the measurement trace is displayed. The measurement trace depends on the selected display.
Show	Select or deselect this checkbox to show or hide the trace selected in the Trace drop-down list.
Freeze	Selecting Freeze halts updates to the trace.

Scale Tab - OFDM

The Scale tab allows you to change the scale settings that control how the trace appears on the display but does not change control settings such as Measurement Frequency. There are two versions of the Scale tab for OFDM displays. One version is used only for the Constellation display and the other version is used for the OFDM EVM, OFDM Magnitude Error, OFDM Phase Error, and OFDM Power displays.

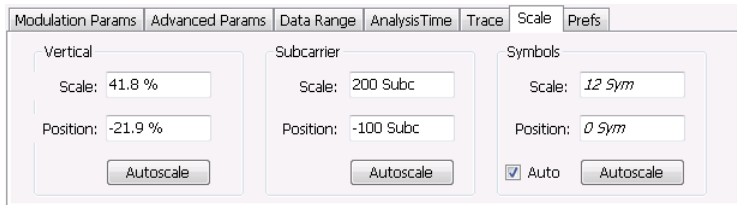

Scale tab for OFDM EVM, OFDM Mag Error, OFDM Phase Error, and OFDM Power displays

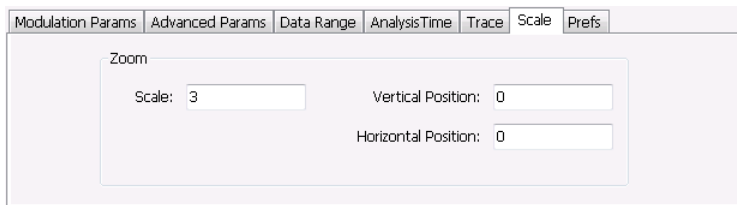

Scale tab for OFDM Constellation display

Settings	Description
Vertical	Controls the vertical position and scale of the trace display.
Scale	Changes the vertical scale of the graph.
Position	Adjusts the reference level away from top of the graph.
Autoscale	Resets the scale of the vertical axis to contain the complete trace.
Subcarrier	Controls the scale of the subcarrier graph and position of the trace.
Scale	Specifies how many subcarriers are displayed horizontally.
Position	Specifies the subcarrier that appears at the left edge of the subcarrier graph.
Autoscale	Resets the scale of the horizontal axis to contain the complete trace.
Symbols	Controls the scale of the Symbols graph.
Scale	Specifies the number of symbols that appear in the symbols graph.
Position	Specifies the symbol that appears at the left edge of the Symbols graph.
Autoscale	Resets the scale and position settings to optimize the display.
Auto	When Auto is checked, the scale and position values for the Symbols graph are automatically adjusted to maintain the optimal display.
Zoom	Sets the Constellation display size and position.
Scale	Sets the magnification value for the Constellation display.
Vertical Position	Sets the vertical location of the Constellation display within the graph. Range is -3.7 to +3.7.
Horizontal Position	Sets the horizontal location of the Constellation display within the graph. Range is -3.7 to +3.7.

Prefs Tab - OFDM

The Prefs tab enables you to change appearance characteristics of the OFDM Analysis displays. Not all settings on the Prefs tab shown below appear for every OFDM display.

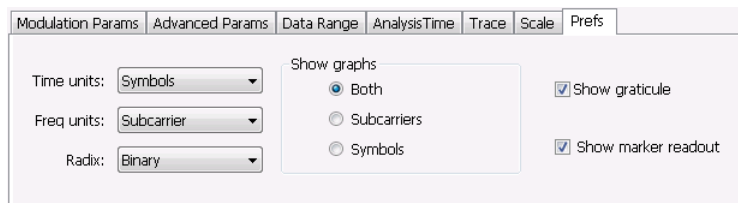

Settings	Description
Time units	Specifies whether the displayed time units are seconds or symbols.
Freq units	Specifies whether the displayed frequency units are frequency (Hz) or subcarrier channel.
Radix	Specifies whether symbol values are displayed in binary or hex format (for example, in the Symbol Table or markers readouts).
Show graphs	Specifies which graph types are displayed.
Both	Displays both the Subcarrier and Symbol graphs.
Subcarriers	Displays only the subcarrier graph.
Symbols	Displays only the symbol graph.
Show graticule	Displays or hides the graticule in the graphs.
Show marker readout	Displays or hides the marker readouts in the graphs.

Overview

The Pulsed RF option (SVP) allows you to take measurements that provide deep insight into pulse train behavior. You can define and analyze unique pulse characteristics in the time and frequency domains and gain additional insight into the performance of Radar or EW subsystems. The Pulse Cumulative Histogram and Pulse Cumulative Statistics Table accumulate results over multiple acquisitions. The remaining Pulse displays show results for the current acquisition. You can use cross-correlated markers to pinpoint events in one display and debug in other displays.

The displays in Pulsed RF (Setup > Displays > Pulsed RF) are:

- [Cumulative Histogram](#)
- [Cumulative Statistics](#)
- [Pulse-Ogram™](#)
- [Pulse Statistics](#)
- [Pulse Table](#)
- [Pulse Trace](#)

Pulse Measurements

The analyzer takes the following pulse measurements.

Measurement	Description
Average ON Power	The average power transmitted during pulse on.
Peak Power	Maximum power during pulse on.
Average Transmitted Power	The average power transmitted, including both the time the pulse is on and the time it is off, and all transition times.
Pulse Width	The time from the rising edge to the falling edge at the -3 dB / -6 dB level (50%) of the user selected 100% level. Level is user selectable for Volts or Watts.
Rise Time	The time required for a signal to rise from 10% to 90% (or 20% to 80%) of the user selected 100% level.
Fall Time	The time required for a signal to fall from 90% to 10% (or 80% to 20%) of the user selected 100% level.
Repetition Interval	The time from a pulse rising edge to the next pulse rising edge.
Repetition Rate	The inverse of repetition interval.
Duty Factor (%)	The ratio of the width to the pulse period, expressed as a percentage.
Duty Factor (Ratio)	The ratio of the pulse width to the pulse period.

Measurement	Description
Ripple	<p>Ripple is the peak-to-peak ripple on the pulse top. It does not include any preshoot, overshoot, or undershoot. By default, the first 25% and the last 25% of the pulse top is excluded from this measurement to eliminate distortions caused by these portions of the pulse.</p> <p>If the Amplitude units selected in the Amplitude panel (affects all amplitude measurements for the analyzer) are linear, the Ripple results will be in %Volts. For log units, the Ripple results will be in %Watts. The default for the general Units control is dBm, so the Ripple results default is %Watts.</p> <p>See also Ripple (see page 612).</p>
Ripple dB	The Ripple measurement expressed in dB.
Droop	Droop is the power difference between the beginning and the end of the pulse on time. A straight-line best fit is used to represent the top of the pulse. The result is a percentage referenced to the Average ON Power.
Droop dB	The Droop measurement expressed in dB.
Overshoot	The amount by which the signal exceeds the 100% level on the pulse rising edge. Units are %Watts or %Volts.
Overshoot dB	The Overshoot measurement expressed in dB.
Pulse-ref-Phase Difference	The phase difference between the current pulse and the first pulse in the analysis window. The instantaneous phase is measured at a user-adjustable time following the rising edge of each pulse.
Phase Difference	The time interval by which one wave leads or lags another.
Pulse-ref Freq Difference	The difference between the frequency of the current pulse and frequency of the previous pulse. The instantaneous frequency is measured at a user-adjustable time following the rising edge of each pulse.
RMS Freq Error	The RMS Frequency Error measurement is the RMS average of the Freq Error vs. Time trace, computed over the Measurement Time.
Max Freq Error	The maximum frequency error is the difference between the measured carrier frequency of the signal and the user-selected center frequency of the analyzer.
RMS Phase Error	The RMS Phase Error measurement is the RMS average of the Phase vs Time trace, computed over the Measurement Time.
Max Phase Error	The phase is measured at each point during the pulse on time. The phase error for each point is the difference between the measured phase value and the calculated ideal phase value. After the phase error is calculated for all points in the acquisition record, the largest error in the positive direction and the largest in the negative direction are determined. Whichever of these two values has the greater absolute value is designated the Max Phase Error.
Freq Deviation	The Frequency Deviation measurement is the difference between the maximum and minimum measured values of the signal frequency during the Measurement Time.
Phase Deviation	The Phase Deviation is the difference between the maximum and minimum Phase values measured during the on time of a pulse.
Impulse Response Amplitude	The difference in dB between the levels of the main lobe and highest side lobe.
Impulse Response Time	The difference in time between the main lobe and highest side lobe.
Time	This is the time in seconds relative to the time reference point in the first acquisition record in the data set.

Measurement	Description
Absolute Frequency	The absolute pulse frequency measured at a point specified by the user. The measurement includes carrier frequency as well. The measurement point should be within the pulse width, starting from the 50% point.
Pulse-Pulse Frequency Difference	The difference between the frequency of the current pulse and frequency of the previous pulse. The instantaneous frequency is measured at a user-adjustable time following the rising edge of each pulse.
Pulse-Pulse Phase Difference	The phase difference between the selected pulse and the first pulse in the analysis window. The instantaneous phase is measured at a user-adjustable time following the rising edge of each pulse.
Delta Frequency (Non-chirped pulse)	<p>The Delta Frequency measurement is the difference from the measurement frequency to each pulse frequency. Pulse frequency is calculated across the time defined by the Frequency Domain Linearity setting in the Define tab.</p> <p>The measurement is available for modulation types CW (Constant Phase), CW (Changing phase), and Other (manual) setting in the Freq Estimation tab.</p> <p>The measurement is not specified for chirp or other signals and no answer is returned when frequency estimation is set to Chirp.</p> <p>If frequency estimation is set to Other, then Frequency Offset must be set to 0 Hz and the Range can be set to $\pm 40\%$ of the acquisition bandwidth.</p> <p>A least-square fit of slope of phase vs. time over the measurement period is used for the measurement of the individual pulse frequency. Frequency difference is calculated as the difference between the reference frequency and the calculated frequency of the pulse.</p>

Cumulative Histogram Display

This histogram display shows the numerical distribution of the various pulse measurement results accumulated over multiple frames (in Fast Frame mode) and acquisitions. You can see the pulse count in a chosen bin by choosing the bin number or the X value (of the chosen result). Pulses that do not lie within the chosen Min/Max are shown as outliers.

To show the Cumulative Histogram display:

1. Recall an appropriate acquisition data file.
2. Press the **Displays** button or select **Setup > Displays**.
3. In the **Select Displays** dialog, select **Pulse Analysis** in the **Measurements** box.
4. In the Available displays box, double-click the **Cumulative Histogram** icon or select the icon and click **Add**. The icon will appear in the **Selected displays** box and will no longer appear under Available displays.
5. Click **OK** to show the Cumulative Histogram display.
6. Press the **Replay/Run** button to take measurements on the acquired data.

Elements of the display

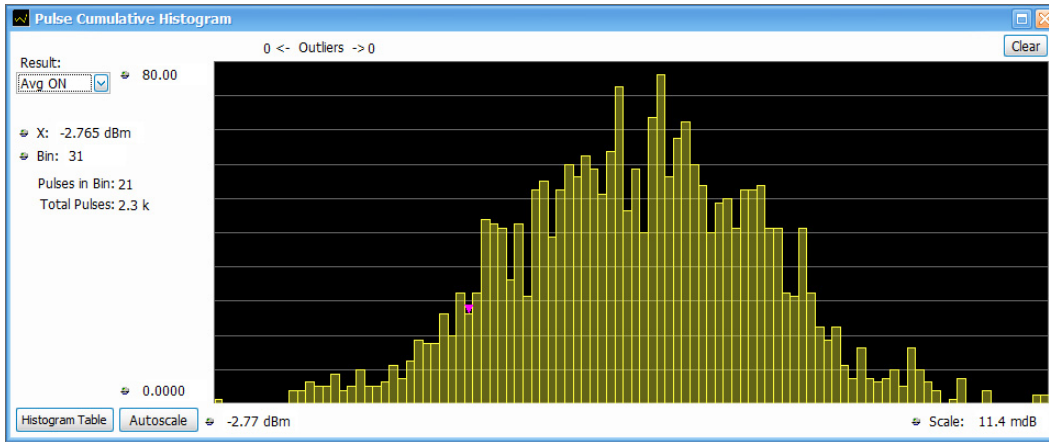

Item	Display element	Description
1	Result	Drop down list of measurements. The results of the selected measurement in this Cumulative Histogram display will also show in the Pulse Statistics display and be highlighted in the Pulse Table display. All results will be available for view when Auto mode is enabled in the Histogram Settings button (see page 276) window. Only selected results will be available for view when Manual mode is enabled in the Histogram Settings window.
2	X	A value of the selected result where the pulse indicator is positioned. Changing X will automatically change the bin number to the one that contains the X value.
3	Bin	Bin number where the indicator is positioned. Changing this number will change the value of X to the middle of the selected bin.
4	Pulses in Bin	Number of pulses in the selected bin.
5	Total Pulses	Total number of pulses analyzed in the current acquisition.
6	Vertical	Sets the vertical range.
7	Autoscale	Sets the axes to values for clear visibility of trace points.
8	Horizontal offset and scale	Controls that specify the offset and scale on the horizontal axis.
9	Clear button	Clears results from the display and starts a new measurement.
10	Outliers	Number of pulses that have measurement values outside of the maximum and minimum values indicates the outliers below the lower limit and those exceeding the upper limit.
11	Histogram Table button	Contains the Bin number, Bin Range, and Pulses in bin for the chosen measurement.

Bin Number	Bin Range	Pulses in Bin
1	196.00 MHz - 198.42 MHz	2
2	198.42 MHz - 200.84 MHz	1
3	200.84 MHz - 203.26 MHz	0
4	203.26 MHz - 205.68 MHz	0
5	205.68 MHz - 208.10 MHz	0
6	208.10 MHz - 210.52 MHz	0
7	210.52 MHz - 212.94 MHz	1
8	212.94 MHz - 215.36 MHz	0
9	215.36 MHz - 217.77 MHz	0
10	217.77 MHz - 220.19 MHz	0
11	220.19 MHz - 222.61 MHz	0
12	222.61 MHz - 225.03 MHz	0
13	225.03 MHz - 227.45 MHz	0
14	227.45 MHz - 229.87 MHz	0
15	229.87 MHz - 232.29 MHz	0

Cumulative Histogram display settings

Main menu: Setup > Settings

Favorites Toolbar: 

The Settings control panel tabs for the Cumulative Histogram display are shown in the following table.

Settings tab	Description
Params	Specifies several parameters that control how pulses are counted and defined.
Define	Specifies parameters that control where measurements are taken on a pulse.
Levels	Specifies parameters that control the method and levels used to calculate some pulse values.
Freq Estimation	Specifies the reference used for computing frequency error.
Scale	Specifies the vertical and horizontal scale settings.
Prefs	Specifies whether or not certain display elements are shown.

Histogram Settings button

This button is located on the Pulse Cumulative Histogram Settings control panel. Click this button to open a window where you can select which measurement results will be available in the Result drop down menu. You can select to use Auto or Manual mode.

Manual mode for histogram settings. In **Manual** mode, the histogram computation is done for the selected measurement results. You set the maximum and minimum values. The **Bin** field represents the total number of bins used in the histogram.

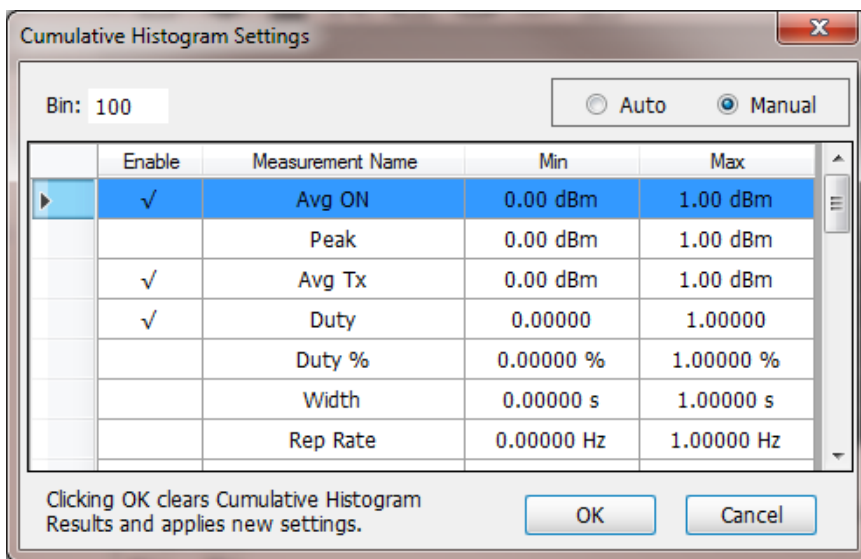

Auto mode for histogram settings. In **Auto** mode, the histogram computation is done for all measurement results. Minimum and maximum limits are chosen automatically based on the first 10,000 pulses. The **Bin** field represents the total number of bins used in the histogram.

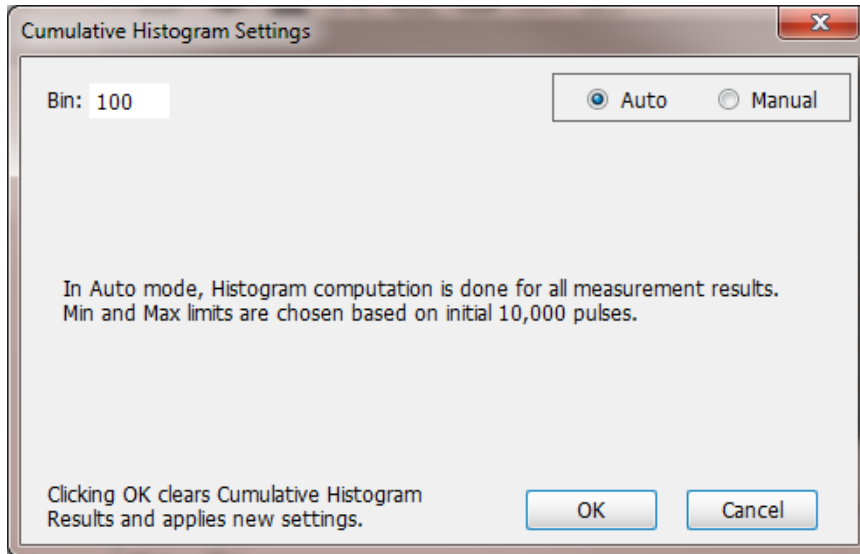

Restore Defaults button

This button is located on the Pulse Cumulative Histogram Settings control panel. Click this button to set the Cumulative Histogram parameters to their default values.

Cumulative Statistics Table display

This display is a statistics table that provides information on Pulse Count, Max, Max TimeStamp, Min, Min TimeStamp, Peak to Peak, Average, and Standard Deviation over different acquisitions.

1. Press the **Displays** button or select **Setup > Displays**.
2. In the **Select Displays** dialog, select **Pulsed RF** in the **Measurements** box.
3. In the Available displays box, double-click the **Cumulative Statistics** icon or select the icon and click **Add**. The icon will appear in the **Selected displays** box and will no longer appear under Available displays.
4. Click **OK** to show the Cumulative Statistics display.
5. Press **Replay/Run** button to take measurements on the acquired data.

Elements of the display

Statistics	Avg ON	Width	Rep Int
Pulse Count	16	16	15
Max	-1.36 dBm	100.00345 ns	4.90990 us
<i>Max TimeStamp</i>	<i>8/27/2008 7:20:52.87</i>	<i>8/27/2008 7:20:52.87</i>	<i>8/27/2008 7:20:52.87</i>
Min	-1.41 dBm	99.37347 ns	2.90983 us
<i>Min TimeStamp</i>	<i>8/27/2008 7:20:52.87</i>	<i>8/27/2008 7:20:52.87</i>	<i>8/27/2008 7:20:52.87</i>
Peak to Peak	-46.74 dBm	629.97429 ps	2.00008 us
Avg	-1.38 dBm	99.63989 ns	3.31002 us
Std Dev	-55.91 dBm	168.95610 ps	799.79884 ns

Display element	Description
Measurement	The row across the top of the table shows the selected measurement. You can right click on this row to access this menu to edit the table:

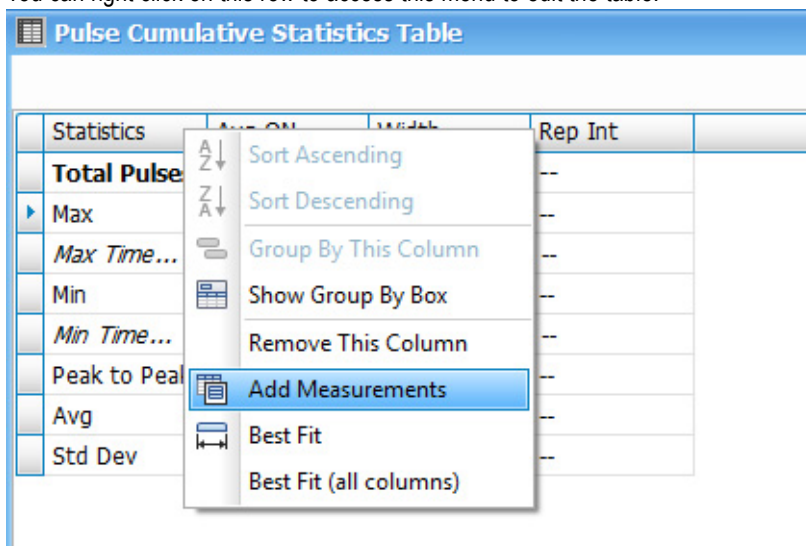

Select Add Measurements to open this window to select measurements:

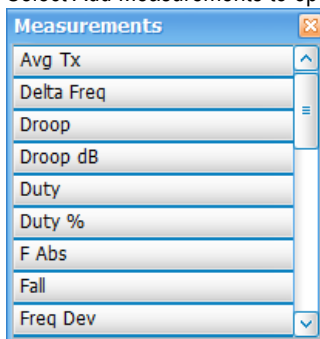

Maximum	Maximum value of the measurement across acquisitions with a time stamp.
Maximum TimeStamp	This time stamp denotes the time the maximum value of the measurement occurred across acquisitions.
Minimum	Minimum value of the measurement across acquisitions with a time stamp.
Minimum TimeStamp	This time stamp denotes the time the minimum value of the measurement occurred across acquisitions.
Average	Average value of the measurement values accumulated over multiple acquisitions until the current acquisition.
Peak to peak	This is the difference between Maximum and Minimum value of the measurement
Standard deviation	Standard deviation of the measurement that has a population equal to the Pulse Count value.
Clear button	Clear the results and starts a new measurement.

NOTE. When analysis is done on only one pulse, the Standard Deviation is zero. Log10 (0) is not defined and thus is represented by a “-” when the unit is dB.

Cumulative Statistics Table display settings

Main menu: Setup > Settings

Favorites Toolbar: 

The Settings control panel tabs for the Cumulative Statistics Table display are shown in the following table.

Settings tab	Description
Measurements	Specifies which measurements to show in the table. Click the box(es) next to the measurement(s) you want to show. You can also click the Select All and Clear All buttons.
Params	Specifies how pulses are counted and defined.
Define	Specifies parameters that control where measurements are taken on a pulse.
Levels	Specifies parameters that control the method and levels used to calculate some pulse values.
Freq Estimation	Specifies the reference used for computing frequency error.
Prefs (see page 306)	Specifies whether or not certain display elements are shown.

Restore defaults button

This button is located on the Cumulative Statistics Table Settings control panel. Sets the Cumulative Statistics Table parameters to their default values.

Pulse-Ogram display

The Pulse-Ogram™ display shows a stacked view of radar pulses when the analyzer is using fast-frame mode. The fast-frame captures IQ samples around a pulse when triggered. Each fast frame is configured to capture few IQ samples before rise-time, and after fall-time of a single pulse, and a timestamp associated with that pulse. With this information, the different fast-frame captures are stacked one after the other and displayed as Time v/s Time, and the corresponding spectrum information as Frequency v/s Time. The stacking allows for overlap of adjacent frames. The user can also select the range of frames for viewing in the display. This enables the user to study various aspects of pulse such as pulse width, reflections, rise-time, fall-time, etc.

Marker correlation in Pulse-Ogram

At the end of an acquisition, the TOV and Spectrum show the last frame acquired. When we place a marker in Pulse-Ogram, the marker would not move in TOV and Spectrum unless you bring the marker to

the last frame in Pulse-Ogram. Similarly, if marker is moved in TOV and Spectrum, then the marker in Pulse-Ogram will move to the last frame automatically.

If you want the marker movement in Pulse-Ogram to change the pulse indicator in the Pulse Table or Pulse Trace display, then you must add the Pulse Statistics display in Time trend mode. Movement of the marker now in the Pulse Statistics display or Pulse-Ogram display will change the pulse indicator position too, and therefore the appropriate pulse will be shown in the Pulse Trace display.

1. Press the **Displays** button or select **Setup > Displays**.
2. In the **Select Displays** dialog, select **Pulsed RF** in the **Measurements** box.
3. In the Available displays box, double-click the **Pulse-O-gram** icon or select the icon and click **Add**. The icon will appear in the **Selected displays** box and will no longer appear under Available displays.
4. Click **OK** to show the Pulse-O-gram display.
5. Press **Replay/Run** button to take measurements on the acquired data.

Elements of the display

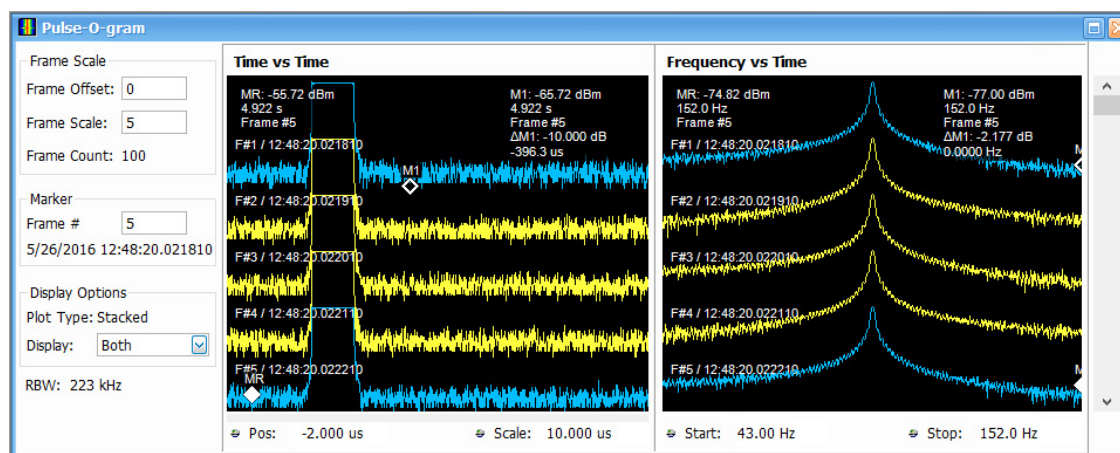

Display element	Description
Time vs Time	This view has the IQ data captured in the fast frames in a stacked view (with overlap).
Frequency vs Time	This view has the corresponding spectrum of the signal captured.
Frame offset	Controls the number of frames that are offset in the display. The starting frame will be frame offset + 1.
Frame scale	Controls the number of frames that can be seen in the display.
Frame count	Total number of fast frames in the acquisition.
Frame #	Indicates the frame number in which the marker is present. This option will only appear when the marker is added.
Plot type	Shows Stacked and is not selectable.
Display	Select to view Time vs Time or Frequency vs Time or Both.
RBW	Shows the resolution bandwidth for the Frequency vs Time view.

Pulse-Ogram display settings

Main menu: Setup > Settings

Favorites Toolbar: 

The Settings control panel tabs for the Pulse-Ogram display are shown in the following table.

Settings tab	Description
Analysis	Specifies settings related to analysis of the signal.
Traces	Specifies the display characteristics of displayed traces.
Scale	Specifies the parameters related to fast frame.
Prefs	Specifies marker readout options.

Pulse Table display

The Pulse Table lists selected measurements in a spreadsheet format, showing the pulse numbers and all the results for each measurement on all the detected pulses. Pulses are numbered from one.

Freq Error: -4.208 kHz (Auto)		Freq: 999.9957918 MHz					
Pulse #	Avg ON	Width	Rise	Rep Int	RMS Ø Err	Peak	Avg Tx
1	-1.40 dBm	100.00345 ns	7.99554 ns	4.90948 us	802.20618 °	-0.85 dBm	-18.32 dBm
2	-1.38 dBm	99.52590 ns	7.83859 ns	2.91027 us	278.82507 °	-0.84 dBm	-16.10 dBm
3	-1.37 dBm	99.73721 ns	7.80641 ns	2.91002 us	280.49780 °	-0.70 dBm	-16.10 dBm
4	-1.36 dBm	99.85104 ns	7.68201 ns	2.91014 us	284.17639 °	-0.62 dBm	-16.08 dBm
5	-1.37 dBm	99.50647 ns	7.98586 ns	2.91022 us	287.90259 °	-0.64 dBm	-16.08 dBm
6	-1.40 dBm	99.67329 ns	8.03208 ns	4.90946 us	806.15570 °	-0.73 dBm	-18.32 dBm
7	-1.36 dBm	99.91533 ns	7.84547 ns	2.91045 us	272.54922 °	-0.62 dBm	-16.08 dBm
8	-1.36 dBm	99.55097 ns	7.48575 ns	2.90986 us	276.32895 °	-0.78 dBm	-16.08 dBm
9	-1.39 dBm	99.41364 ns	7.65567 ns	2.91011 us	280.42859 °	-0.87 dBm	-16.11 dBm
10	-1.36 dBm	99.56028 ns	7.80557 ns	2.91018 us	284.14838 °	-0.74 dBm	-16.07 dBm
11	-1.40 dBm	99.63683 ns	8.02328 ns	4.90990 us	810.08453 °	-0.86 dBm	-18.31 dBm
12	-1.38 dBm	99.55033 ns	7.95047 ns	2.91008 us	268.64148 °	-0.74 dBm	-16.10 dBm
13	-1.37 dBm	99.37347 ns	7.73742 ns	2.90983 us	272.31412 °	-0.68 dBm	-16.09 dBm
14	-1.36 dBm	99.58830 ns	7.79934 ns	2.91000 us	275.92587 °	-0.77 dBm	-16.08 dBm
15	-1.37 dBm	99.59512 ns	7.74599 ns	2.91024 us	279.55917 °	-0.53 dBm	-16.08 dBm
16	-1.41 dBm	99.75660 ns	8.28168 ns	-- s	814.49548 °	-0.90 dBm	-- dBm

Displaying the Pulse Table

1. Press the **Displays** button or select **Setup > Displays**.
2. Select **Pulsed RF** in the Measurements box.
3. **Double-click Pulse Table** in the **Available displays** box to add the display to the Selected displays box.
4. Click **OK**.

Selecting the Measurements to Show

1. With the Pulse Table selected, press the **Settings** button.
2. In the Pulse Table Settings control panel, select the **Measurements** tab.

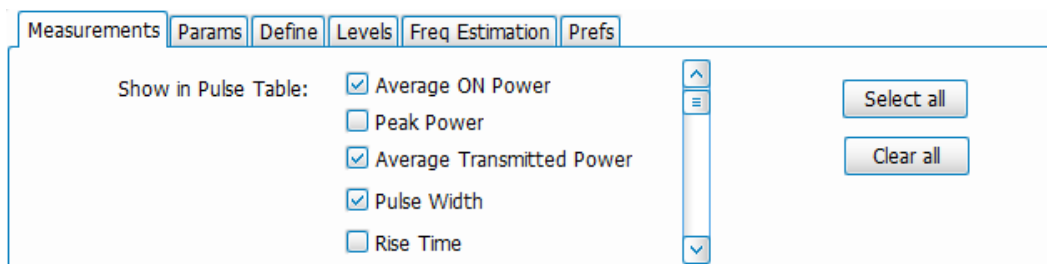

3. Select the measurements you wish to take from the list of measurements or click **Select all** to choose all measurements.
4. Click the close box () to remove the Settings control panel.

[Changing the Pulse Table Display Settings \(see page 284\)](#)

Pulse Table display settings

Main menu bar: Setup > Settings

Favorites toolbar: 

The Settings control panel tabs for the Pulse Table Display are shown in the following table.

Settings tab	Description
Measurements	Selects the measurements to be show in the Pulse Table.
Params	Specifies several parameters that control how pulses are counted and defined.
Define	Specifies parameters that control where measurements are taken on a pulse.
Levels	Specifies parameters that control the method and levels used to calculate some pulse values.
Freq Estimation	Specifies the reference used for computing frequency errors.

Restore defaults button

This button is located on the Pulse Table Settings control panel. Sets the Pulse Table parameters to their default values.

Clearing results

If you want to clear the Pulse Table results for a new acquisition, open the Time Overview window and select Autoscale. This causes the Pulse Table to refresh.

Pulse Trace display

The Pulse Trace display shows one measurement result and a trace graph illustrating that measurement for a selected pulse number. You can also choose to display arrows and lines in the graph that illustrate where on the pulse the measurement is being taken.

Elements of the Pulse Trace Display

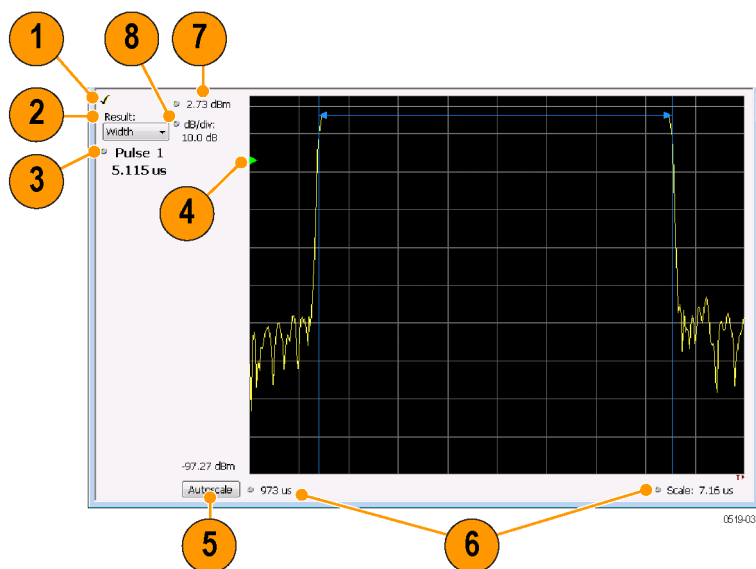

Item	Display element	Description
1	Check mark indicator	The check mark indicator in the upper, left-hand corner of the display shows when the Pulse Trace display is the optimized display. NOTE. When Best for multiple windows is selected in the Amplitude control panel's RF & IF Optimization control, none of the measurement displays shows a checkmark, as there is not a single optimized measurement.
2	Result	Use this list to select the measurement to show. The measurement chosen here selects the same result to be displayed in the Statistics view and highlighted in the Table view. Selecting a result in any of these views causes the same result to be selected in all of them.
3	Pulse	Selects which pulse result is shown. Like the Result, this selection is shared with the Statistics and Table views. The maximum number of pulses that can be measured is limited to 10000.
4	Pulse threshold indicator	This green triangle indicates the power threshold used to detect pulses. See Settings > Params > Power threshold to detect pulses.
5	Autoscale	Set the axes to values that show all trace points.
6	Horizontal offset and scale	Located along the bottom edge of the trace display, these controls specify the offset and scale on the horizontal axis.
7	Top of graph adjustment	Sets the power level shown at the top of the graph. If the number is greater than the Ref Level, a white line will appear in the graph to indicate the Ref Level.
(not shown)	Units	Sets the global amplitude units for all the views in the analysis window. This will change the amplitude selection in the Units tab of the Amplitude control panel.
8	Vertical scale	Sets the vertical scale value.

[Changing the Pulse Trace Display Settings \(see page 286\)](#)

Pulse Trace display settings

Main menu: Setup > Settings

Favorites Toolbar: 

The Setup settings for the Pulse Trace display are shown in the following table.

Settings tab	Description
Params (see page 292)	Specifies several parameters that control how pulses are counted and defined.
Define (see page 294)	Specifies parameters that control where measurements are taken on a pulse.
Levels (see page 299)	Specifies parameters that control the method and levels used to calculate some pulse values.
Freq Estimation (see page 300)	Specifies the reference used for computing frequency error.
Scale (see page 304)	Specifies the vertical and horizontal scale settings.
Prefs (see page 306)	Specifies whether or not certain display elements are shown.

Restore defaults button

This button is located on the Pulse Trace Settings control panel. Sets the Pulse Trace display parameters to their default values.

Pulse Statistics display

The Pulse Statistics view displays a plot of a pulse measurement's values for every pulse in the analysis period. For example, the Pulse Statistics display will show the Rise Time measurement for each of 30 pulses, with rise time on the Y axis and pulse number on the X axis. Alternatively, the Statistics Display can show an FFT trace for the values of a measurement over all the pulses analyzed. Numeric readouts of Pulse Count, Max, Min, Peak to Peak, Average, and Standard Deviation in this display summarize results for the selected pulse measurement.

Elements of the Pulse Statistics Display

The following images show the display when different plot types are selected. The table following these images explains the elements of these displays.

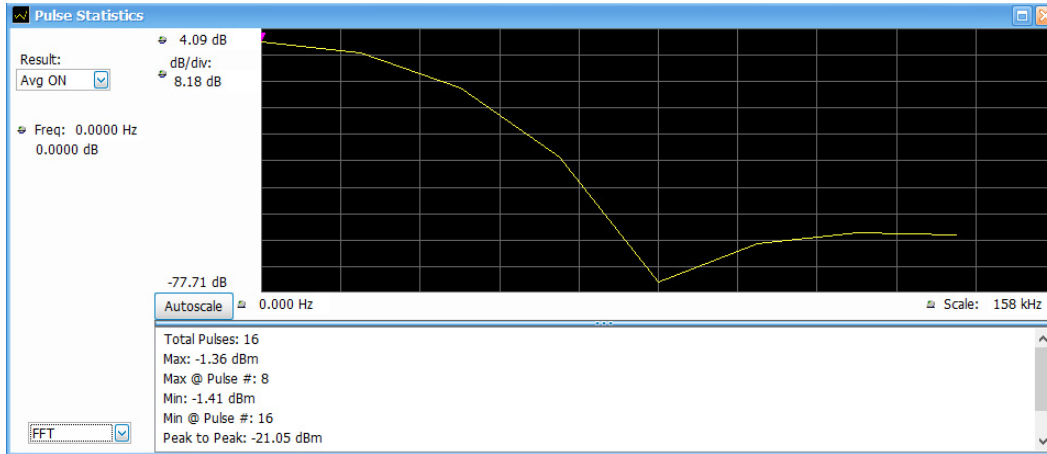

The above image shows an FFT plot.

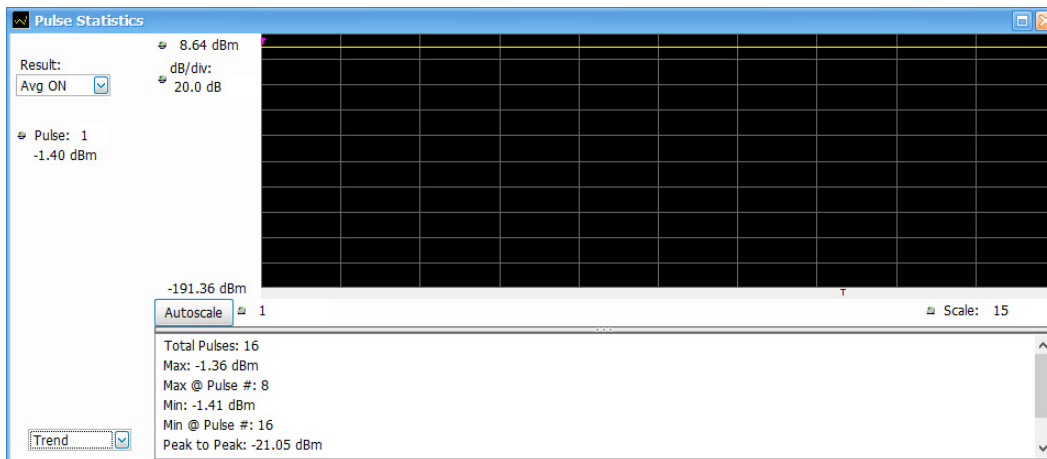

The above image shows a Trend plot.

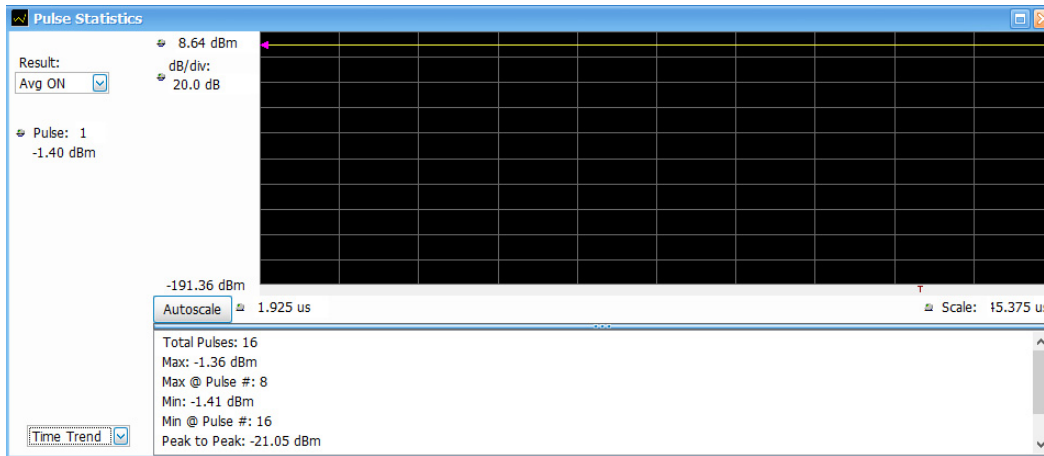

The above image shows a Time Trend plot.

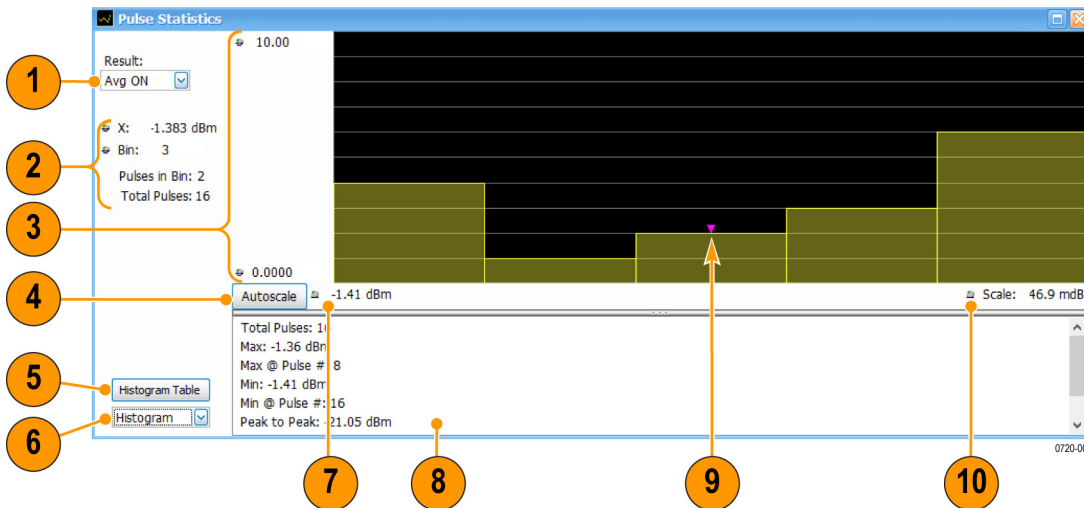

The above image shows a Histogram plot.

Item	Display element	Description
1	Result	Use this list to select which measurement statistics to display. The measurement chosen here selects the same result to be displayed in the Pulse Trace display and the Pulse Table display. Selecting a result in any of these views causes the same result to be selected in all of them.
2	Results indicators	(The indicators shown depend on the plot type selection. The values shown are plot indicator (Item 9) values.)
	Pulse	Pulse indicator for Trend or Time Trend plots that indicates the pulse selected by the Pulse setting.
	Freq	Pulse indicator for FFT plots that marks the trace point at the selected frequency.

Item	Display element	Description																																																
	X	For Histogram plots: A value of the selected result where the pulse indicator is positioned. Changing X will automatically change the bin number to the one that contains the X value.																																																
	Bin	For Histogram plots: Bin number where the indicator is positioned. Changing this number will change the value of X to the middle of the selected bin.																																																
	Pulses in Bin	For Histogram plots: Number of pulses in the selected bin.																																																
	Total Pulses	For Histogram plots: Total number of pulses analyzed in the current acquisition.																																																
3	Vertical	Sets the vertical range.																																																
4	Autoscale	Sets the axes to values for clear visibility of trace points.																																																
5	Histogram Table button	Contains the Bin number, Bin range, and Pulses in bin for the chosen measurement.																																																
		<table border="1"> <thead> <tr> <th>Bin Number</th> <th>Bin Range</th> <th>Pulses in Bin</th> </tr> </thead> <tbody> <tr><td>1</td><td>196.00 MHz - 198.42 MHz</td><td>2</td></tr> <tr><td>2</td><td>198.42 MHz - 200.84 MHz</td><td>1</td></tr> <tr><td>3</td><td>200.84 MHz - 203.26 MHz</td><td>0</td></tr> <tr><td>4</td><td>203.26 MHz - 205.68 MHz</td><td>0</td></tr> <tr><td>5</td><td>205.68 MHz - 208.10 MHz</td><td>0</td></tr> <tr><td>6</td><td>208.10 MHz - 210.52 MHz</td><td>0</td></tr> <tr><td>7</td><td>210.52 MHz - 212.94 MHz</td><td>1</td></tr> <tr><td>8</td><td>212.94 MHz - 215.36 MHz</td><td>0</td></tr> <tr><td>9</td><td>215.36 MHz - 217.77 MHz</td><td>0</td></tr> <tr><td>10</td><td>217.77 MHz - 220.19 MHz</td><td>0</td></tr> <tr><td>11</td><td>220.19 MHz - 222.61 MHz</td><td>0</td></tr> <tr><td>12</td><td>222.61 MHz - 225.03 MHz</td><td>0</td></tr> <tr><td>13</td><td>225.03 MHz - 227.45 MHz</td><td>0</td></tr> <tr><td>14</td><td>227.45 MHz - 229.87 MHz</td><td>0</td></tr> <tr><td>15</td><td>229.87 MHz - 232.29 MHz</td><td>0</td></tr> </tbody> </table>	Bin Number	Bin Range	Pulses in Bin	1	196.00 MHz - 198.42 MHz	2	2	198.42 MHz - 200.84 MHz	1	3	200.84 MHz - 203.26 MHz	0	4	203.26 MHz - 205.68 MHz	0	5	205.68 MHz - 208.10 MHz	0	6	208.10 MHz - 210.52 MHz	0	7	210.52 MHz - 212.94 MHz	1	8	212.94 MHz - 215.36 MHz	0	9	215.36 MHz - 217.77 MHz	0	10	217.77 MHz - 220.19 MHz	0	11	220.19 MHz - 222.61 MHz	0	12	222.61 MHz - 225.03 MHz	0	13	225.03 MHz - 227.45 MHz	0	14	227.45 MHz - 229.87 MHz	0	15	229.87 MHz - 232.29 MHz	0
Bin Number	Bin Range	Pulses in Bin																																																
1	196.00 MHz - 198.42 MHz	2																																																
2	198.42 MHz - 200.84 MHz	1																																																
3	200.84 MHz - 203.26 MHz	0																																																
4	203.26 MHz - 205.68 MHz	0																																																
5	205.68 MHz - 208.10 MHz	0																																																
6	208.10 MHz - 210.52 MHz	0																																																
7	210.52 MHz - 212.94 MHz	1																																																
8	212.94 MHz - 215.36 MHz	0																																																
9	215.36 MHz - 217.77 MHz	0																																																
10	217.77 MHz - 220.19 MHz	0																																																
11	220.19 MHz - 222.61 MHz	0																																																
12	222.61 MHz - 225.03 MHz	0																																																
13	225.03 MHz - 227.45 MHz	0																																																
14	227.45 MHz - 229.87 MHz	0																																																
15	229.87 MHz - 232.29 MHz	0																																																
6	Plot type selector	Select Trend, Time Trend, FFT, or Histogram as plot type.																																																
7	Horizontal offset	Adjusts the horizontal offset.																																																
8	Statistics summary	Display of measurement statistics for the selected result.																																																
9	Pulse indicator	For Trend and Time Trend plot types, this indicates the pulse selected by the Pulse setting. For the FFT plot type, this indicator marks the trace point at the selected frequency. For Histogram plot types, this indicator marks the selected results bin.																																																
10	Scale	Adjusts the horizontal scale.																																																

[Changing the Pulse Statistics Display Settings \(see page 289\)](#)

Pulse Statistics settings

Main menu bar: Setup > Settings

Favorites toolbar: 

The settings for the Pulse Statistics display are shown in the following table.

Settings tab	Description
Params (see page 292)	Specifies several parameters that control how pulses are counted and defined.
Define (see page 294)	Specifies parameters that control where measurements are taken on a pulse.
Levels (see page 299)	Specifies parameters that control the method and levels used to calculate some pulse values.
Freq Estimation (see page 300)	Specifies the reference used for computing frequency errors.
Scale (see page 304)	Specifies the vertical and horizontal scale settings.
Prefs (see page 306)	Specifies whether or not certain elements of the display are shown.

Restore defaults button

This button is located on the Pulse Statistics Settings control panel. Sets the Pulse Statistics display parameters to their default values.

Pulsed RF Measurement Settings

Some of the control panel tabs are shared by the Pulsed RF displays (Setup > Displays). Changing a setting in a shared tab changes that setting for all the Pulsed RF displays. The other control panel tabs are unique for each display. The following information explains both types.

Common controls for pulsed RF displays

Settings tab	Description
Measurements (see page 291)	Specifies which measurement results appear in the Cumulative Statistics Table and Pulse Table displays.
Params (see page 292)	Specifies several parameters that control how pulses are counted and defined.
Define (see page 294)	Specifies parameters that control where measurements are taken on a pulse.
Analysis (see page 301) (Only Available for the Pulse-Ogram display)	Specifies parameters related to analysis of the signal.
Levels (see page 299)	Specifies parameters that control the method and levels used to calculate some pulse values.
Freq Estimation (see page 300)	Specifies the reference used for computing frequency errors.
Traces (see page 303) (Only available for the Pulse-Ogram display)	Specifies the smooth points for the Time vs Time view and the detection method for the Frequency vs Time view.
Scale (see page 304)	Specifies the vertical and horizontal scale settings.
Prefs (see page 306)	Specifies whether or not certain elements of the display are shown.

Measurements Tab

The Measurements tab is used to specify the measurements that appear in the Cumulative Statistics Table display and the Pulse Table display.

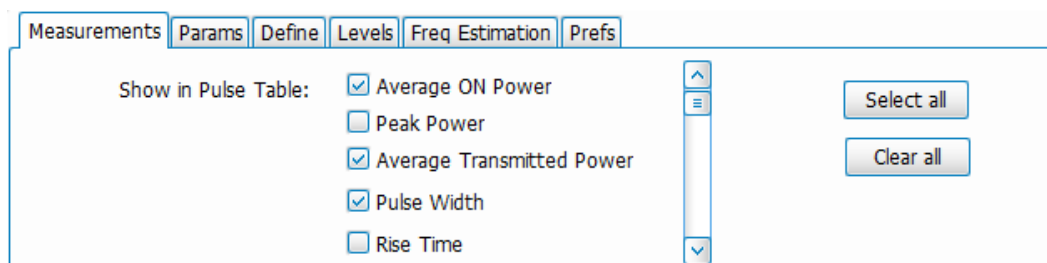

Show in Cumulative Statistics Table

Checked measurements appear in the table.

Select all

Click **Select all** to choose all measurements for display in the table.

Clear all

Click **Clear all** to remove all measurements from the table display.

Params Tab

The Params tab enables you to adjust several measurement parameters for Pulsed RF displays. Not all parameters show for all displays.

The screenshot shows the 'Params' tab in a software interface. It contains several settings:

- Measurement Filter:** A dropdown menu set to 'Gaussian'.
- Power threshold to detect pulses:** A text input field containing '-10 dBc'.
- Bandwidth:** A text input field containing '10 MHz'.
- Minimum OFF time between pulses:** A text input field containing '100.000 ms'.
- Max number of pulses:** A checkbox that is checked, followed by a text input field containing '100'.

 The interface also shows other tabs: 'Define', 'Levels', 'Freq Estimation', 'Scale', and 'Prefs'.

Setting	Description
Measurement Filter	Specify whether a filter is used to limit the bandwidth of the input signal.
Bandwidth	Sets the bandwidth of the measurement filter.
Power threshold to detect pulses	Specifies the level used for locating pulses in the data.
Minimum OFF time between pulses	Specifies the time the signal must fall below the power threshold for two pulses to be considered separate pulses.
Max number of pulses	Specifies the number of pulses to measure within the analysis time. (Only available for the Pulse Statistics, Pulse Trace, and Pulse Table displays.)

Measurement Filter

Three choices are available for the measurement filter:

- **No Filter - Max BW:** The widest acquisition bandwidth available is used. The **Bandwidth** setting is disabled, but shows the value in use.
- **No Filter:** - This is the default. The Bandwidth control is enabled to specify an acquisition bandwidth.
- **Gaussian** - The Bandwidth control is enabled for you to specify a value. The instrument uses an acquisition bandwidth two times wider than the entered value.

Power Threshold to Detect Pulses

Specifies the minimum power level the trace must exceed to be detected as a pulse. The range for this setting is: -3 to -70 dBc. The setting resolution is 1 dB. The default value is -10 dB.

Minimum OFF time between pulses

Specifies the time the signal must fall below the power threshold for two pulses to be considered separate pulses. The minimum value for this setting is 1.000 ns.

Max Number of Pulses

Only available for the Pulse Statistics, Pulse Trace, and Pulse Table displays.

If the Analysis Time contains fewer pulses than specified, the analyzer will measure all the pulse within the analysis time. If there are more pulses in the Analysis Time, than the specified number, the analyzer measures the specified number of pulses and ignores the rest. The setting resolution is: 1. If this setting is not checked, the analyzer will measure all pulses within the Analysis Time.

To determine the maximum number of pulses that can be analyzed, use the following equation:

$$\text{Max number of pulses that can analyzed} = \text{Pulse Rate} \times \text{capacity}$$

where:

- Pulse rate is the number of pulses per second (frequency).
- Capacity is a length of time which is displayed on the **Acquire > Sampling Parameters** tab.

Note that the maximum number of pulses is affected by several parameters. For example, measurement bandwidth affects the sample rate. The measurement algorithm also can reduce the maximum number of pulses that can be analyzed (by increasing the sample rate) based on the characteristics of the signal.

Additionally, when FastFrame is enabled, determining the maximum number of pulses is even more challenging. In FastFrame mode, the signal analyzer samples the signal around events of interest and ignores the signal between events of interest. Thus, if the instrument is only looking at pulses and ignoring the signal between pulses, the number of pulses that can be analyzed depends strongly on the characteristics of the pulse itself (for example, fewer wide pulses can be analyzed than narrow pulses, all other things being equal).

The Pulse Cumulative Statistics display provides statistics of pulses like Average, Standard Deviation, and Peak to Peak. Pulse Count does not have an upper limit for Pulse Cumulative Statistics. The Pulse Cumulative Histogram display provides information about the trend of the Pulse characteristics and outliers. This display does not support any upper limit or lower limit.

NOTE. In Fast Save mode, Pulse /Frame Count can go up to 200,000. This count also depends on the hard disk drive (HDD) capacity to store acquisitions.

The asterik (*) around a pulse number indicates that it is a Fast Frame.

All Pulse Analysis displays except the Pulse-Ogram update results only after analysis of all fast frames.

Define Tab

The Define tab enables you to specify parameters that control where measurements are made on a pulse. The settings available depend on the measurement selected. This tab is not available for the Pulse-Ogram display.

Measurements	Params	Define	Levels	Freq Estimation
Measurement(s):				
Impulse Response <input type="button" value="v"/>		Time method: Absolute <input type="button" value="v"/>	Ref (R): 100 %	
<input checked="" type="checkbox"/> Apply ampl corrections			Start (S): 0.000 s	
Keep-out time (+/-): 0.000 s			Length (L): 1.00 us	

The settings that appear on the Define tab are described below. They may vary according to the Measurement(s) selection.

Freq-Domain Linearity

Measurements	Params	Define	Levels	Freq Estimation
Measurement(s):				
Freq-domain Linearity <input type="button" value="v"/>		Time method: Absolute <input type="button" value="v"/>	Ref (R): 100 %	
			Start (S): 0.000 s	
			Length (L): 1.00 us	

Setting	Description
Time method	Specifies how the measurement's duration is determined. The choices are Absolute and Relative.
Absolute time method	
Ref (R)	Ref specifies the level along the pulse rising edge that is defined as the point from which Start time is counted. Choices: 50%, 60%, 70%, 80%, 90% 100%; Default: 100%
Start (S)	Start specifies the time the instrument waits after the rising-edge reference before starting to measure the pulse. The Start time is measured from the point along the pulse rising edge specified by the Ref setting. Start Range: ± 100 ms; Resolution: 3 digits; inc/dec small: 1 ns, large: 1,2,5,10...; Default: 0
Length (L)	Length specifies the period of time that is used for pulse measurements The measurement time begins at the Start point and continues for the amount of time specified by Length.
Relative time method	
Length	In the Relative time method, Length specifies the percentage of the top of the pulse that is used for measurements. The instrument automatically determines the pulse top. The measurement length is centered within the pulse ON time.

Impulse Response

Measurements
Params
Define
Levels
Freq Estimation

Measurement(s):
 ▼

Apply ampl corrections

Keep-out time (+/-):



Time method: ▼

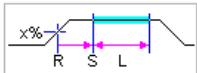

Ref (R):

Start (S):

Length (L):

Setting	Description
Apply ampl corrections	Enable/disable corrections that remove errors due to the window function and to the time offset of the side lobe.
Keep-out time (+/-)	The Keep-out time specifies a region that is ignored when the trace is analyzed for side lobes. The setting defines a region to the left and to the right of the center of the main lobe. Lobes that fall within this time region are not eligible to be the "highest side lobe".
Time method	Specifies how measurement parameters are determined. The choices are Absolute and Relative.
Absolute time method	
Ref (R)	Ref specifies the level along the pulse rising edge that is defined as the point from which Start time is counted. Choices: 50%, 60%, 70%, 80%, 90% 100%; Default: 100%
Start (S)	Start specifies the time the instrument waits after the rising-edge reference before starting to measure the pulse. The Start time is measured from the point along the pulse rising edge specified by the Ref setting. Start Range: ± 100 ms; Resolution: 3 digits; inc/dec small: 1 ns, large: 1,2,5,10...; Default: 0
Length (L)	Amount of time that should be included in the measurement. The measurement time begins at the Start point and continues for the amount of time specified by Length.
Relative time method	
Length	In the Relative time method, Length specifies the percentage of the top of the pulse that is used for measurements. The instrument automatically determines the pulse top. The measurement length is centered within the pulse ON time.

P-R F Diff, P-P F Diff, F Abs, P-R \emptyset Diff, P-P \emptyset Diff

Params Define Levels Freq Estimation Scale Prefs

Measurement(s):
 P-R F Diff, P-P F Diff, F Abs, P... 



Measurement point: 500.000 ns

Setting	Description
Measurement point	Specifies the period in time after the 50% rising edge at which frequency and phase difference measurements are made.

Ripple

Measurements Params Define Levels Freq Estimation

Measurement(s):
 Ripple
 Time method: Relative Ref (R): 100 %
 Start (S): 0.000 s
 Length (L): 50.0 %

Setting

Description

Length	Length specifies the percentage of the top of the pulse that is used for measurements. The instrument automatically determines the pulse top. The measurement length is centered within the pulse ON time. Only the Relative Time method is available for Ripple.
--------	---

Overshoot

Measurements Params Define Levels Freq Estimation

Measurement(s):
 Overshoot
 Time method: Absolute Ref (R): 100 %
 Start (S): 0.000 s
 Length (L): 1.00 us

Setting	Description
Time method	Specifies how measurement parameters are determined. The choices are Absolute and Relative.
Absolute time method	
Ref (R)	Ref specifies the level along the pulse rising edge that is defined as the point from which Start time is counted. Choices: 50%, 60%, 70%, 80%, 90% 100%; Default: 100%
Start (S)	Start specifies the time the instrument waits after the rising-edge reference before starting to measure the pulse. The Start time is measured from the point along the pulse rising edge specified by the Ref setting. Start Range: ± 100 ms; Resolution: 3 digits; inc/dec small: 1 ns, large: 1,2,5,10...; Default: 0
Length (L)	Amount of time that should be included in the measurement. The measurement time begins at the Start point and continues for the amount of time specified by Length.
Relative time method	
Ref	Ref specifies the level along the pulse rising edge that is defined as the point from which Start time is counted. Choices: 50%, 60%, 70%, 80%, 90% 100%; Default: 100%
Start	Start specifies the time the instrument waits after the rising-edge reference before starting to measure the pulse. The Start time is measured from the point along the pulse rising edge specified by the Ref setting. Start Range: ± 100 ms; Resolution: 3 digits; inc/dec small: 1 ns, large: 1,2,5,10...; Default: 0
Length	In the Relative time method, Length specifies the percentage of the top of the pulse that is used for measurements. The instrument automatically determines the pulse top. The measurement length is centered within the pulse ON time.

Levels Tab

Use the Levels tab to set parameters that control the method and levels used to calculate some pulse values.

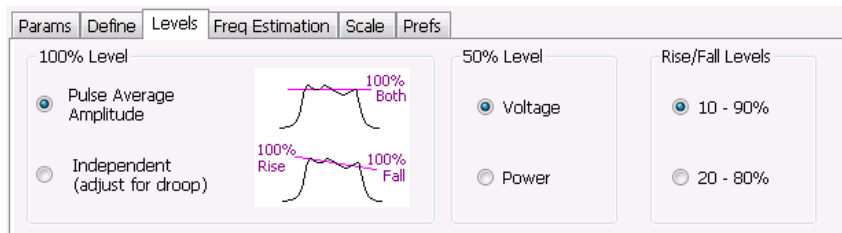

Setting	Description
100% Level	Specifies the method used to determine the 100% level(s).
50% Level	Specifies the method used to determine the 50% level on the pulse.
Rise/Fall Levels	Select whether to use the 10% to 90% or 20% to 80% points (based on voltage level) to define the rise and fall times.

100% Level

Use the 100% Level settings to select the method used to determine the 100% level(s) used for calculating pulse parameters, for example, Rise, Fall, and Width.

The Pulse Average Amplitude defines the pulse top as the average of the values of all the points along the pulse top. This average is used as the 100% level, from which the 10, 20, 50, 80 and 90% levels are calculated. Pulse measurements are referenced against these various levels. For example, Rise is the time between the 10 and 90% (or 20 and 80%) levels on the rising edge of the pulse. When the Pulse Average Amplitude method is selected, the same 100% level is used for both rising and falling edges.

Because some RF pulse types have droop (a height difference between the beginning and ending points of the pulse top), the 100% percent level on the rising edge may not be equal to the 100% level on the falling edge. The Independent method of pulse point location is designed for pulses with different 100% levels at their rising and falling edges. The Independent method calculates the 100% level for the rising edge separately from the 100% level of the falling edge. As a result, the 10, 20, 50, 80 and 90% levels are also different for the rising and falling edges, allowing for more accurate measurements on pulses with droop.

50% Level

Select Voltage to use -6 dB as the 50% point. Select Power to use -3 dB as the 50% level.

Freq Estimation Tab

Use the Freq Estimation tab to specify parameters used for determining frequency offset. This tab is not available for the Pulse-Ogram display.

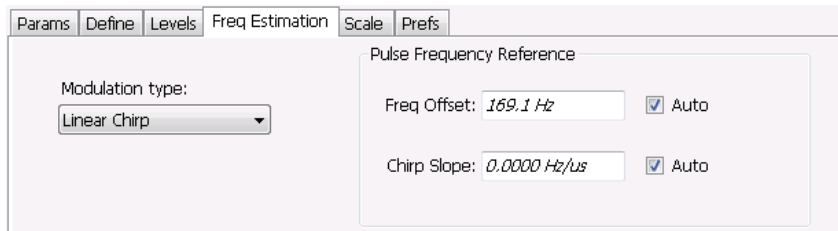

Setting	Description
Modulation type	Specifies which algorithm to use for estimating frequency error.
Pulse Frequency Reference	Specifies the method used to determine the pulse frequency error and if applicable, the chirp slope.
Auto	Selecting Auto causes the instrument to calculate the frequency offset and if applicable, the chirp slope.
Freq Offset	If Auto is not enabled, specify the value for frequency offset here. If Auto is enabled, the offset is set to zero and this readout displays the calculated frequency error.
Chirp BW	If Auto is not enabled, specify the value for Chirp Slope here. If Auto is enabled, this readout displays the calculated Chirp slope. This setting is used only when the modulation type is set to Linear Chirp.

Modulation Type

Frequency estimation is performed by the instrument using selectable methods, depending on signal type. The selections for modulation type are CW (constant phase), CW (changing phase), Linear Chirp and Other. Select the method of frequency method based upon a best match to your signal based on the following descriptions:

- CW (constant phase): The signal is not designed to change in either frequency or phase during the measured pulse train.
- CW (changing phase): The signal does not change the carrier phase within each pulse, although it could change the phase from one pulse to another pulse. The signal is not designed to make frequency changes.
- Linear Chirp: The signal changes frequency in a linear manner during each pulse. The signal has the same carrier phase at the same time offset from the rising edge of the pulse.
- Other: The signal is not one of the listed types. You must manually enter the Frequency Offset value.

The following table maps the appropriate signal type selection with the signal characteristics.

Signature	Phase offset from one pulse to another	
	Zero	Any (unknown)
CW	CW Constant Phase	CW Changing Phase
LFM	Linear Chirp	N/A

Analysis Tab

The Analysis tab is only available for the Pulse-Ogram display. It allows you to set parameters related to analysis of the signal. The settings vary depending on which spectrum analysis region you select.

Analysis | Traces | Scale | Prefs

Measurement Bandwidth: 40 MHz

Frequency vs Time

Filter Shape: Kaiser (RBW)

Spectrum Analysis Region:

- Use Analysis Time settings
- Pulse ON Time
- Independent

Analysis | Traces | Scale | Prefs

Measurement Bandwidth: 40 MHz

Frequency vs Time

Filter Shape: Kaiser (RBW)

Spectrum Analysis Region:

- Use Analysis Time settings
- Pulse ON Time
- Independent

Length: 100 %

Power threshold to detect pulses: -10 dBc

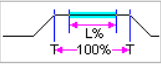

Analysis | Traces | Scale | Prefs

Measurement Bandwidth: 40 MHz

Frequency vs Time

Filter Shape: Kaiser (RBW)

Spectrum Analysis Region:

- Use Analysis Time settings
- Pulse ON Time
- Independent

Start: 0.000 s

Length: 89.143 us

Setting	Description
Measurement bandwidth	Specifies the frequency range used by the measurement. This control is linked to the Bandwidth control of other Pulsed RF Displays. If No Filter – Max BW is selected in other displays, the control setting is disabled, but shows the maximum value possible. If No Filter or Gaussian is selected in other displays, then the Bandwidth control is also enabled in the Pulse-Ogram display.
Filter shape	Spectrum of the signal is windowed by the desired filter shape.
Use analysis time settings	Provides the complete analysis length as displayed in Time Overview.
Pulse on time	Analysis is done in the ON period of the data.
Length	Specifies the analysis length.
Power threshold to detect pulses	Specifies the level used for locating pulses in the data.
Independent	In Manual option, you can choose the analysis length of the desired type for the Freq vs Time view in the display.
Start	Specify the analysis offset. The default value is the offset in Time Overview.
Length	Specify the analysis length. The default value is the length in Time Overview.

Traces Tab

The Traces tab is only available for the Pulse-Ogram display. It allows you to set the trace characteristics for the display.

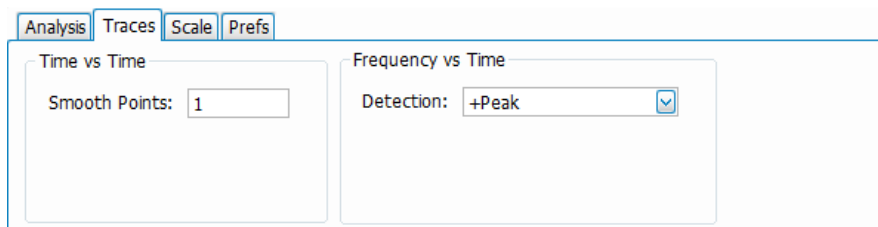

Setting	Description
Smooth points	Shows the number of filter coefficients used for smoothening the noisy region for visual clarity.
Detection	Trace Detection is used to reduce the results of a measurement to the desired number of trace points.

Detection

Trace Detection is used to reduce the results of a measurement to the desired number of trace points. For example, if the maximum number of trace points is 100,000 and a measurement over the selected analysis length yields 200,000 points, the measurement must decimate these 200,000 trace points by 2 to prevent exceeding the 100,000 trace point limit. Since only one value can be represented for each trace point, an algorithm must be used to select (detect) the appropriate value to use.

The results array from an analysis can be detected (or “decimated”) in a variety of ways. The number of results points produced for each trace point varies with both analysis length and trace length. For example, the frequency transform used for the Spectrum display produces just one output value for each desired trace point. In this case, the detection method chosen has no effect, as no decimation is required.

Increasing the Analysis Length (or for the Spectrum display, the Spectrum Length), causes the available detection method's output traces to differ from each other because they have a larger set of samples for the various detection methods to process.

The available detection methods are:

- **+Peak**: The highest value is selected from the results to be compressed into a trace point.
- **-Peak**: The lowest value is selected from the results to be compressed into a trace point.
- **Avg (VRMS)**: Each point on the trace is the result of determining the RMS Voltage value for all of the results values it includes. When displayed in either linear (Volts, Watts) or Log (dB,dBm), the correct RMS value results.
- **Sample**: The first value is selected from the set of results to be compressed into a trace point.

Scale Tab

The Scale tab is only available for trace displays. It allows you to change the vertical and horizontal scale settings. Changing the scale settings changes how the trace appears on the display but does not change control settings such as Measurement Frequency. In effect, these controls operate like pan and zoom controls. Each display has different settings, as shown below.

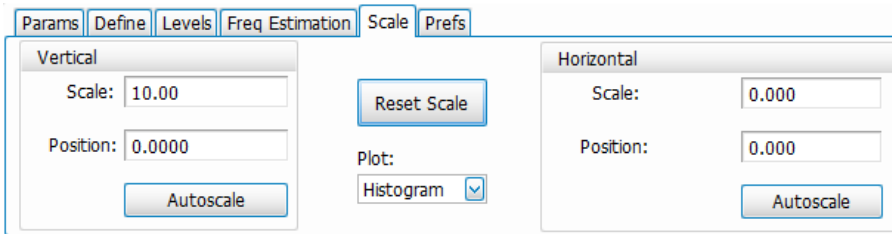

The above image shows the Scale tab for the Pulse Statistics display.

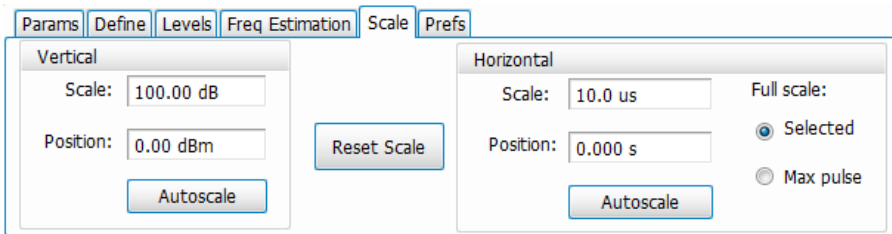

The above image shows the Scale tab for the Pulse Trace display.

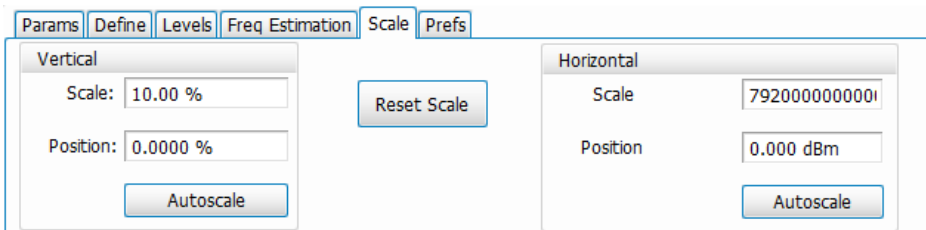

The above image shows the Scale tab for the Pulse Cumulative Statistics display.

Setting	Description
Vertical	Controls the vertical position and scale of the trace display.
Scale	Changes the vertical scale. The units for this setting depend on the statistic selected from the Result drop-down list in the Pulse Statistics display.
Position	Adjusts the Reference Level away from the top of the trace display. The units for this setting depend on the statistic selected from the Result drop-down list in the Pulse Statistics display.
Autoscale	Resets the scale of the vertical axis to contain the complete trace.
Horizontal	Controls the span of the trace display and position of the trace.
Scale	Allows you to change the span.
Position	Allows you to pan a zoomed trace.
Full Scale (Pulse Trace display only)	Specifies the Horizontal scale default.
Selected	Sets the horizontal scale default to be based on the result value for the currently-select pulse.
Max Pulse	Sets the horizontal scale default to be based on the largest value for the selected pulse measurement.
Autoscale	Resets the scale of the horizontal axis to contain the complete trace.
Plot (Pulse Statistics display only)	Specifies the FFT, Trend, Time Trend, or Histogram plot.
Reset Scale	Restores all settings to their default values.

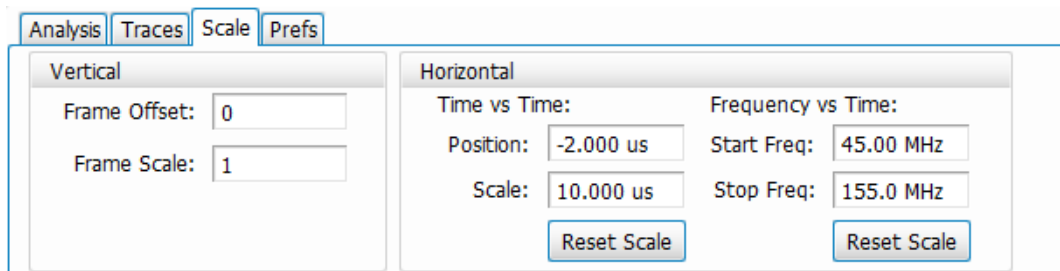

The above image shows the Scale tab for the Pulse-Ogram display.

Setting	Description
Vertical	Controls the vertical position and scale of the trace display.
Frame Offset	Display will start after the indicated frame number.
Frame Scale	Shows how many frames are displayed in both Time vs Time and Frequency vs Time views.
Horizontal (Time vs Time view)	Controls the span of the Time vs Time trace display and position of the trace.
Position	Allows you to pan a zoomed trace. The default value matches the offset of the acquisition.
Scale	Allows you to change the span. The default value matches the length of the acquisition.
Reset Scale	Restores the position and scale settings to default value.
Horizontal (Frequency vs Time view)	Controls the span of the Frequency vs Time trace display and position of the trace.
Start Freq	Allows you to set the starting frequency shown in the graph without changing analysis. The default value matches the highest frequency of the span.
Stop Freq	Allows you to set the stop frequency shown in the graph without changing analysis. The default value matches the highest frequency of the span.
Reset Scale	Restores the start frequency and stop frequency to default values.

Prefs Tab

The Prefs tab is only available for Pulsed RF trace displays. It is not available for the table displays. It enables you to change parameters of the measurement display. Available parameters vary depending on the selected display.

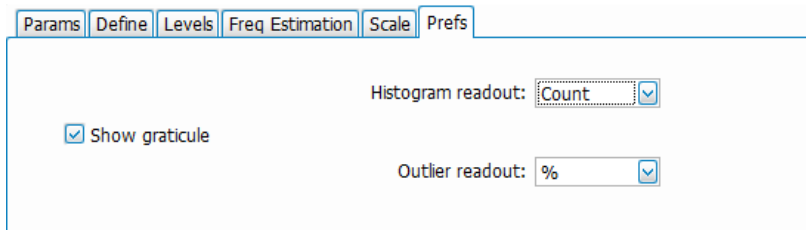

The above image shows the Prefs tab for the Pulse Cumulative Histogram display.

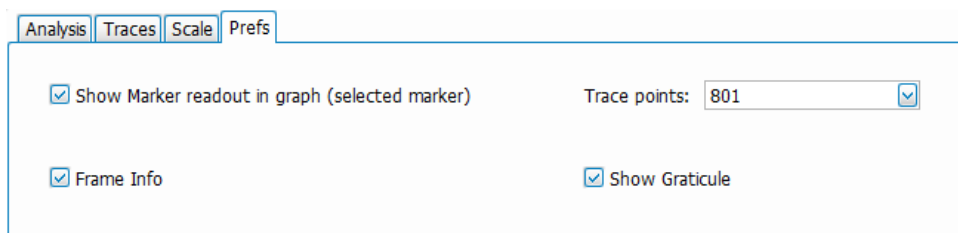

The above image shows the Prefs tab for the Pulse-Ogram display.

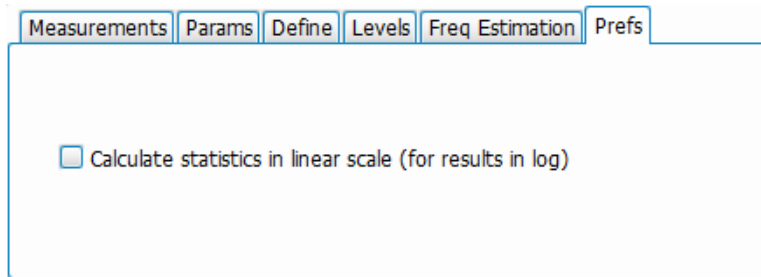

The above image shows the Prefs tab for the Pulse Cumulative Statistics display.

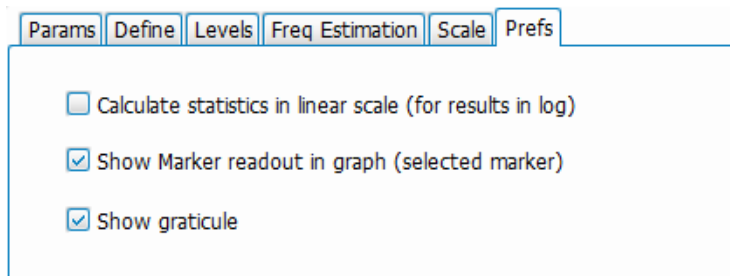

The above image shows the Prefs tab for the Pulse Statistics display when Time Trend is the selected plot type. Trend and FFT plot types do not show the Show Marker readout selection.

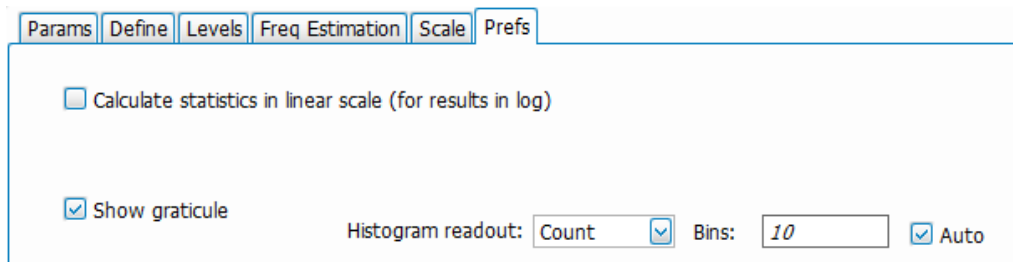

The above image shows the Prefs tab for the Pulse Statistics display when Histogram is the selected plot type.

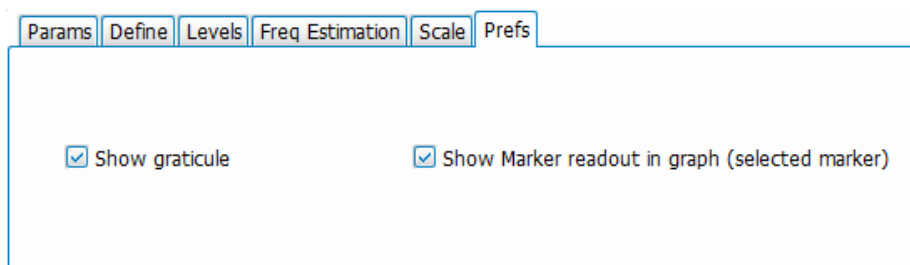

The above image shows the Prefs tab for the Pulse Trace display.

Setting	Description
Show graticule	Displays or hides the graticule in the trace display.
Show Marker readout in graph <i>(Only available for Pulse Trace and Pulse-Ogram displays.)</i>	When a marker is enabled, this setting displays or hides the maker readout, but not the maker itself, on Time Trend plots.
Histogram readout <i>(Only available for Cumulative Histogram display and the Pulse Statistics display when Histogram is the plot type.)</i>	Controls the parameters Histogram readout and Bins. Histogram readout can be set to either Count or %. Count indicates the number of hits that fell into each bin. % indicates percentage of the total count (for the acquisition) that fell into each bin.
Calculate statistics in linear scale (for results in log) <i>(Only available for Pulse Statistics display.)</i>	Checking this box allows for calculation of statistics in the linear domain (for example, the Power values in dB are converted to Watts (linear scale) and statistics are computed in Watts and then converted back to dB scale). This measurement will be observed only when this box is selected. This selection only appears in the Pulse Statistics display for these measurements: Average ON Power, Average Transmitted Power, Peak Power, Impulse Response Amplitude, Droop dB, Overshoot dB, and Ripple dB.
Bins <i>(Only available for Pulse Statistics display when Histogram is the plot type.)</i>	Specifies how many "bins" or histogram bars the results are distributed into.
Auto <i>(Only available for Pulse Statistics display when Histogram is the plot type.)</i>	Sets the bin number to automatic default, which is 10.
Outlier readout <i>(Only available for Cumulative Histogram display)</i>	Controls the parameters Outlier readout and Bins. Outlier readout can be set to either Count or %. Count indicates the number of hits that fell into each bin. % indicates percentage of the total count (for the acquisition) that fell into each bin.
Trace points <i>(Only available for the Pulse-Ogram display.)</i>	Sets the number of trace points used for marker measurements and for results export.
Frame Info <i>(Only available for the Pulse-Ogram display.)</i>	Displays or hides the frame information in the display.

The statistics can be calculated in the linear domain as well the log

Average ON Power, Average Transmitted Power, Peak Power, Impulse Response Amplitude, Droop dB, Overshoot dB, Ripple dB, the statistics can be calculated in linear domain as well, i.e. the Power values in dB are converted to watts (linear scale) and statistics are computed in watts and then converted back to dB scale. This measurement will be observed only when the Calculate statistics in linear scale (for results in log) is selected.

APCO P25 Analysis

Overview

The Association of Public Safety Communication Officials (APCO) P25 Compliance Testing and Analysis option allows you to evaluate radio signals to ensure they meet the standards set for the public safety communications community for interoperable LMR equipment. This complete set of push-button Telecommunication Industry Association TIA-102 standard-based transmitter measurements includes modulation measurements, power measurements, and timing measurements. These measurements are also compared with the limits that best fit the signal for which the standard applies to provide pass/fail results.

The P25 measurements available with this option can be made on signals defined by the Phase 1 (C4FM) and Phase 2 (HCPM, HDQPSK) P25 standards. With this test suite, test engineers can simplify the execution of a number of transmitter tests while still allowing for controls to modify signal parameters for signal analysis. The analysis results give multiple views of P25 signal characteristics to allow the diagnosis of signal imperfections and impairments quickly and easily. Display controls allow you to selectively display the analysis results to help locate trouble-spots in the signal.

P25 Topics

The following information about the P25 Analysis option is available:

- [Reference Table of Supported P25 Measurements \(see page 309\)](#)
- [P25 Standards Presets \(see page 310\)](#)
- [P25 Displays \(see page 311\)](#)
- [P25 Settings \(see page 340\)](#)
- [P25 Measurements \(see page 312\)](#)
- [P25 Test Patterns \(see page 320\)](#)

Reference Table of Supported P25 Measurements

TIA-102 transmitter measurement	Tektronix measurement display(s) (value name if different from TIA-102 measurement name)	Phase 1	Phase 2
RF output power	P25 Summary P25 Power vs Time	Yes	Yes
Operating frequency accuracy	P25 Summary (Operating Freq Accuracy)	Yes	Yes
Modulation emission spectrum	SEM (The SEM display can be found in Select Displays > RF Measurements)	Yes	Yes
Unwanted emissions: Non spurious adjacent channel power ratio	MCPR (The MCPR display can be found in Select Displays > P25 Analysis)	Yes	Yes

TIA-102 transmitter measurement	Tektronix measurement display(s) (value name if different from TIA-102 measurement name)	Phase 1	Phase 2
Frequency deviation	P25 Summary (Freq Dev)	Yes	HCPM
Modulation fidelity	P25 Summary P25 Constellation	Yes	Yes
Symbol rate accuracy	P25 Summary	Yes	Yes
Transmitter power and encoder attack time	P25 Summary (Phase1 Tx Attack Time) P25 Power vs Time (Power Attack Time and Encoder Attack Time)	Yes	N/A
Transmitter power and encoder attack time with busy/idle operations	P25 Summary (Phase1 Tx Attack Time (Busy/Idle)) P25 Power vs Time (Power Attack Time Busy Idle and Encoder Attack Time Busy Idle)	Yes	N/A
Transmitter throughput delay	P25 Summary (Phase1 Tx Throughput Delay)	Yes	N/A
Transient frequency behavior	P25 Freq Dev vs. Time	Yes	N/A
HCPM transmitter logical channel peak adjacent channel power ratio	P25 Summary (HCPM Tx Logic Ch Pk ACPR)	N/A	HCPM
HCPM Transmitter logical channel off slot power	P25 Power vs Time (Off Slot Power) P25 Summary (HCPM Tx Logic Ch Off Slot)	N/A	HCPM
HCPM Transmitter logical channel power envelope	P25 Power vs Time (Power Info) P25 Summary (HCPM Tx Logic Ch Pwr Env Limits)	N/A	HCPM
HCPM Transmitter logical channel time alignment	P25 Summary (HCPM Tx Logic Ch Time Alignt)	N/A	HCPM

P25 Standards Presets

The P25 standards preset allows you to access displays preconfigured for the P25 standards you select. You can read more about how Presets work [here \(see page 13\)](#).

The following table shows the bandwidth, modulation type, and displays that are automatically loaded for each of the listed standards. MCPR masks are also loaded and are explained [here \(see page 311\)](#).

Table 2: P25 standards, modulation type, bandwidth, and displays

Standard	Modulation type	Bandwidth (kHz)	Displays loaded with preset
Phase 1	C4FM	12.5	MCPR, Time Overview, P25 Constellation, P25 Summary
Phase 2	HCPM (inbound)	12.5	MCPR, Time Overview, P25 Constellation, P25 Summary
	HDQPSK (outbound)	12.5	

Retain Current Center Frequency

This setting becomes available when P25 is the selected preset in the Standards Preset window. You can access this window by selecting **Presets > Standards** and then selecting **P25** from the **Preset** drop down menu. To activate the **Retain current Center Frequency Setting**, check the box. This setting allows you to retain the previously used center frequency. By default, the box is unchecked and therefore the four P25 preset displays will load with a center frequency of 850 MHz.

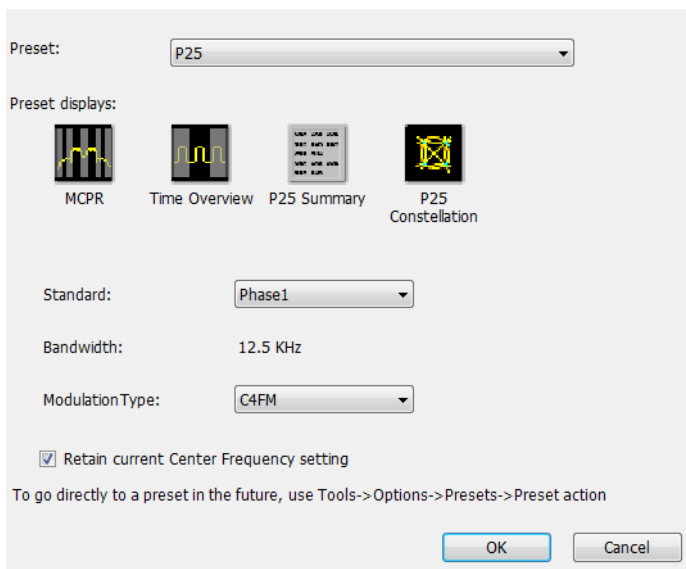

The default adjacent channels table for MCPR is different for RF frequencies in the range of 769 to 806 MHz (called 700 MHz band) and for frequency ranges outside it. The option of retaining center frequency in Standards Preset is therefore useful if you want to load the default table for center frequencies in the 700 MHz band.

MCPR channel and limit parameters. The MCPR (ACPR) standard channel and limit parameters that are applied to the P25 signal depend on the standard you select when you configure the preset. Once you select a standard and center frequency, the application will automatically load the parameters and default limits recommended for best performance comparison by the Standard document. All channel and limit parameters are derived from the TIA-102 standard and loaded for you. This provides you the assurance that you are evaluating the signal with the most appropriate parameters.

NOTE. *Changing analysis and display parameters recalculates the measurement results, but does not affect acquisitions.*

P25 Displays

The displays in P25 Analysis (Setup > Displays > Measurements: P25 Analysis) are:

- [MCPR](#)
- [P25 Constellation \(see page 323\)](#)

- [P25 Power vs Time \(see page 328\)](#)
- [P25 Eye Diagram \(see page 326\)](#)
- [P25 Frequency Dev Vs Time \(see page 337\)](#)
- [P25 Symbol Table \(see page 334\)](#)
- [P25 Summary \(see page 331\)](#)
- [Time Overview \(see page 37\)](#)

P25 Measurements

The following topics contain important information you should know about specific P25 measurements.

RF Output Power (Phase 1 and Phase 2)

This is a measure of RF output power when the transmitter is connected to the standard load during defined duty cycle. This measurement is presented as a scalar result in the P25 Summary display. Power variation is shown in the P25 Power vs Time display.

Information of note about this measurement:

- For bursty HCPM (Phase 2 Inbound) signals, the RF Output Power is measured only during the on slot regions centered at the middle of the on slot.
- The result shown in the P25 Summary Display is the average RF Output Power of all the bursts selected in the analysis window.
- If only one on slot region is chosen in the analysis window, then the RF Output Power of only the chosen on slot is reported.
- For non-bursty data, the entire duration of analysis window is considered to obtain RF Output Power.
- Enter external attenuation introduced by the user by entering the attenuation in the Amplitude control panel (**Setup > Amplitude > External Gain/Loss Correction** tab. > **External Gain Value** (dB). Select **All acquired data (filter method)**).
- The Limits tab in the P25 Summary Settings control panel allows you to compare the results against limits set for Pass/Fail.
- This measurement result is not shown in the P25 Summary display when Trigger Measurements are selected.

NOTE. Read about important information related to HCPM bursty data measurements [here \(see page 322\)](#).

Operating Frequency Accuracy (Phase 1 and Phase 2)

The Operating Frequency Accuracy is the ability of the transmitter to operate on its assigned frequency. This measurement is presented as a scalar result in the P25 Summary display.

- For bursty HCPM (Phase 2 Inbound) signals, the operating frequency accuracy is measured only during the on slot regions centered at the middle of the on slot.
- The result shown in the P25 Summary display is the average of all the bursts selected in the analysis window.
- If only one on slot region is chosen in the analysis window, then the operating frequency accuracy of only the chosen on slot is reported.
- For non-bursty data, the entire duration of the analysis window is considered to obtain the operating frequency accuracy.
- The Limits tab in the P25 Summary Settings control panel allows you to compare the results against limits set for Pass/Fail.

In Operating Frequency Error, double sided operating frequency error is converted to one sided error and compared against the Absolute Limit.

- This measurement result is not shown in the P25 Summary display when Trigger Measurements are selected.

Unwanted Emissions (ACPR) (Phase 1 and Phase 2)

This measurement is the ratio of the total power of a transmitter under prescribed conditions and modulation to that of the output power that falls within a prescribed bandwidth centered on the nominal frequency of adjacent channels. This measurement is shown in the MCPR display.

- For HCPM signals, Adjacent Channel Power Ratio analysis is only done on the first on slot region. When the Modulation Type is set to HCPM from any P25 display or from Standards Presets, there will be a search for bursts before ACPR analysis is done. If a burst is found, then analysis is done only on first burst. If a burst is not found, it will show the results of the entire analysis length. The Main Preset will remove the HCPM modulation Type setting, allowing MCPR to work in its regular mode.
- The MCPR display will only have one Main channel for P25 signals in addition to relevant adjacent channels.
- The default adjacent channels table for Unwanted Emissions (ACPR) as suggested by the standard can be loaded by using the P25 Standards Preset option (for which MCPR is one of the four displays).
- The default adjacent channels table for MCPR is different for RF frequencies in the range of 769 to 806 MHz (called 700 MHz band) and for frequency ranges outside it.
- To load the default adjacent channels table of a 700 MHz band, first set the center frequency. Next, select **Presets > Standards** to view the Standards Preset window. Lastly, check the **Retain current Center Frequency Setting** box.
- By default, the Retain Center Frequency box is unchecked and therefore the four P25 preset displays will load with a center frequency of 850 MHz and load the adjacent channels table for non-700 MHz band.
- By default, only six adjacent channels (on either side) will be shown when 700 MHz band is analyzed in P25 (for visual clarity). However, analysis is done for all the ten channels and results will be available in the table just under the display. You can zoom out to see the remaining bands.

Frequency Deviation (Phase 1 (C4FM) and Phase 2 (HCPM))

This measurement shows the amount of frequency deviation that results for a Low Deviation and High Deviation test pattern. This measurement is shown in the P25 Summary display.

- This measurement only applies to HCPM and C4FM signals and High Deviation or Low Deviation test patterns. If this measurement is run for any other test patterns or for HDQPSK signals, comparisons for limits (set in the Limits tab of the control panel) will result in N/A being shown, as the measurement will not be valid.
- This measurement is done using a FM demodulator without any filter. As a result, it will not be exactly the same as the result given in the P25 Frequency Deviation vs Time display. That display shows the frequency deviation after complete demodulation and might use relevant shaping filters.
- The Low pass filter cut off frequency can be set from the Analysis Params tab of the Settings Control panel. The default value of the cut off frequency is 5 kHz.
- Measurement results are only available when High Deviation, Low Deviation, or Symbol Rate test pattern is selected.
- The scalar result in the P25 Summary display will be shown as f1 (Positive Peak) and f2 (Negative Peak) when analyzing the High Deviation test pattern (or the Symbol Rate test pattern for C4FM signals).
- The scalar result in the P25 Summary display will be shown as f3 (Positive Peak) and f4 (Negative Peak) when analyzing the Low Deviation test pattern.
- The scalar results in the P25 Summary display do not have a corresponding graphical view. A closely representative display would be the FM display (Setup > Displays > Analog Modulation).
- The Limits tab in the P25 Summary Settings control panel allows you to compare the results against limits set for Pass/Fail.

Modulation Fidelity (Phase 1 and Phase 2)

This measures the degree of closeness to which the modulation follows the ideal theoretical modulation determined by the rms difference between the actual deviation and the expected deviation for the transmitted symbols. This measurement is shown in the P25 Summary and P25 Constellation displays.

- This measurement is done on the first on slot region in the analysis window for bursty HCPM data. The analysis is done on 160 symbols centered at the burst.
- This measurement is done on all of the data chosen in the analysis window for non-bursty modulation types. A warning message is issued if the data is less than 164 symbols (the standard recommends at least 164 symbols be present for the measurement of non-bursty signals).
- This measurement is done by performing the frequency demodulation after taking the signal through relevant shaping filters and comparing it with expected frequency deviation points.
- The Limits tab in the P25 Summary Settings control panel allows you to compare the results against limits set for Pass/Fail.

- This measurement result is not shown in the P25 Summary display when Trigger measurements are selected.
- HDQPSK-P25 filter attempts to remove the Inter Symbol Interference before symbol detection.

NOTE. Read about important information related to HCPM bursty data measurements [here \(see page 322\)](#).

Symbol Rate Accuracy (Phase 1 and Phase 2)

Symbol Rate Accuracy measures the ability of the transmitter to operate at the assigned symbol rate (4.8 kHz for Phase 1, 6 kHz for Phase 2). It is a scalar result shown in the P25 Summary display.

- This measurement result appears in the P25 Summary display and only applies to High Deviation or Low Deviation test patterns. Test patterns are selected in the Test Patterns tab in the Settings control panel.
- The Limits tab in the P25 Summary Settings control panel allows you to compare the results against limits set for Pass/Fail.
- This measurement only applies to High Deviation or Low Deviation test patterns. If this measurement is run for any other test patterns, comparisons for limits will result in N/A being shown, as the measurement will not be valid.

Common Trigger Related Measurements

The measurements covered in this subsection have some common information. These measurements are:

- **Transmitter Power and Encoder Attack Time (Phase 1):** This measurement is the time required for a transmitter to prepare and transmit information on the radio channel after changing state from standby to transmit (applies to conventional mode). This measurement result can be seen in the P25 Summary display. A graphical representation of these results can be seen in the P25 Power vs Time display.
- **Transmitter Power and Encoder Attack Time with Busy/Idle Operations (Phase 1):** This measures the time required for a transmitter to prepare and transmit information on the radio channel after the receiving channel changes state from busy to idle. Transmission is inhibited until a status symbol indicates an idle channel. This measurement result can be seen in the P25 Summary display. A graphical representation of these results can be seen in the P25 Power vs Time display.
- **Transmitter Throughput Delay (Phase 1):** This measures the time it requires for audio changes in the microphone to be encoded and transmitted over the air. A calibrated receiver with a known receiver throughput delay is used to monitor the transmitted signal. The aggregate delay of the transmitter under test and calibrated receiver is measured and the desired transmitter throughput delay is then the aggregate delay less the delay of the calibrated receiver. A calibrated Receiver throughput delay from the UI is needed. This measurement result can be seen in the P25 Summary display.
- **Transient Frequency Behavior (Phase 1):** This is a measure of difference of the actual transmitter frequency and assigned transmitter frequency as a function of time when the RF output power is switched on or off. This measurement appears in the P25 Freq Dev vs Time display.
- **HCPM Tx Logical Channel Time Alignment (Phase 2 HCPM):** This measures the ratio of total transmitter power under prescribed conditions and modulation to the peak power that falls in a

prescribed bandwidth centred on the nominal frequency of the adjacent channel during the transmitter power ramping interval. This applies only to inbound signals. This measurement result appears in the P25 Summary display.

Common information. The following information applies to all of the measurements in the previous list.

- Select the relevant Trigger measurement from the Trig Meas tab of the control panel.
- When this measurement is chosen from the Trig Meas tab of the control panel, only this result will be populated in the P25 Summary display and everything else will have no result.
- The Time Zero Reference under the Analysis Time tab in the control panel is forced to Trigger.
- Use the Acquisition control panel to select enough acquisition length to ensure that sufficient data is available when the acquisition is triggered.
- This measurement operates in Single Acquisition mode as the acquisition is triggered.
- You can select to do the same experiment multiple times and this measurement will produce an average result of the last 10 single acquisitions. Clicking the **Clear** button on the P25 Summary display will clear the results and start a new measurement.

Transmitter Power and Encoder Attack Time and Transmitter Power and Encoder Attack Time with Busy/Idle Operations (Phase 1). The following information is specific to these two measurements.

- The Transmitter Power Attack Time analysis is done by measuring the time taken from the trigger point to the point where the transmitter output power will reach 50% of its maximum value.
- For Encoder Attack Time, the initial frame synchronization word is searched in the demodulated output and the time taken from trigger to the start of the synchronization word is reported as the result.
- When a clear power ramp up is not available, the analysis will report the following error, indicating that no power ramp was received as expected: *Input data too short*. When the synchronization word is not found, the analysis will report the following error: *IQ Processing error*.
- The Limits tab in the P25 Summary Settings control panel allows you to compare the results against limits set for Pass/Fail.
- The P25 Power vs Time display shows marking from trigger point to 50% ramp point and also up to the Synchronization word for Transmitter Power and Encoder Attack Time. Frequency Dev vs Time can also be used to check for the synchronization word. The following image shows this measurement.

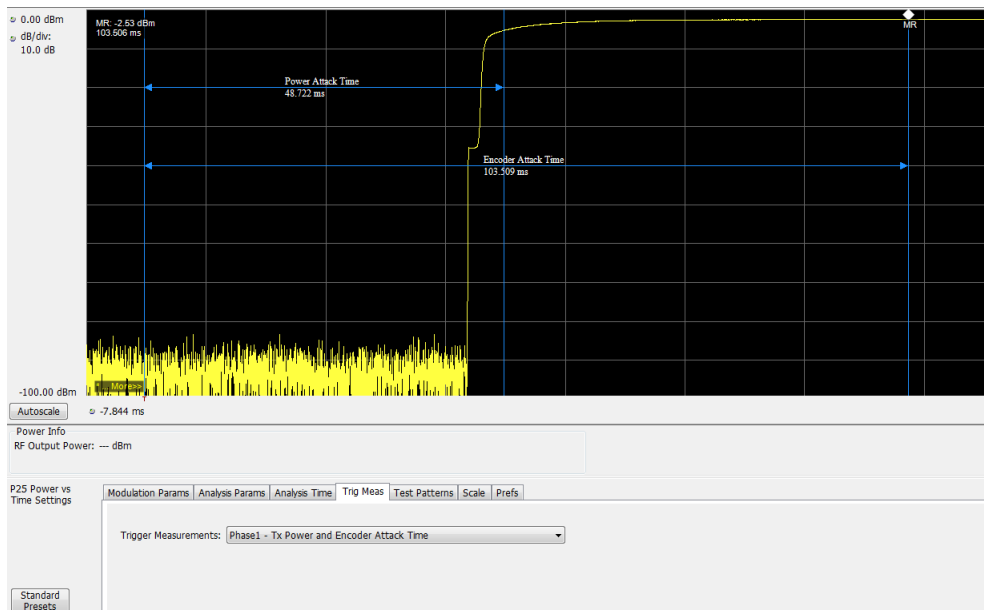

Transmitter Throughput Delay (Phase 1). The following information is specific to this measurement.

- Select Tx Throughput Delay from the Trig Meas tab of the Settings control panel to get this measurement.
- The actual input to the RSA comes after the noise signal from the source has passed through the DUT and calibrated receiver as shown in the setup for this measurement in the measurement methods standard document.
- The calibrated receiver throughput delay entered by the user in the Trig Meas tab in the Settings control panel (this option appears when Throughput Delay is selected) is subtracted from the calculated time difference and reported as Throughput Delay.
- A limit comparison can be performed by selecting the appropriate limits from the Limits tab in the Settings control panel.

Transient Frequency Behavior (Phase 1). The following information is specific to this measurement.

- Select Transmitter Frequency Behavior from the Trig Meas tab of the Settings control panel to get this measurement.
- This measurement can be done for On to Off and Off to On behaviors. Select which behavior to measure by selecting the desired behavior from the Transient Frequency drop down list that appears when the Transient Frequency Behavior measurement is selected in the Trig Meas tab of the Settings control panel.
- Select enough acquisition length (from the Acquisition control panel) to ensure that sufficient data is available when the acquisition is triggered. For a transient frequency behavior, there is a need for t_1+t_2 amount of time after t_{on} as defined in the measurement methods standard document. Approximately 100 ms of data after trigger should ensure that all cases are taken care of as suggested by the standard. t_1 , t_2 , and t_3 durations are fetched based on the RF frequency range.

- The identification of t_{on} is done by looking for a significant frequency deviation after a certain power level has been achieved. A manual override for the t_{on} is also provided in the Trigger Meas tab of the Settings control panel when a Transient Frequency Behavior measurement is chosen. This allows you to manually override the t_{on} that is calculated (by releasing the Auto Option) and place it appropriately based on the P25 Freq Dev vs Time display. The same is true for t_{off} when the measurement is being done for the On to Off behavior.
- t_1 and t_2 regions are identified after t_{on} and t_3 before t_{off} (for the On to Off behavior).
- The mean and max frequency deviation is reported in the regions identified.
- A Pass or Fail is also reported by comparing the Mean frequency deviation with the recommended values given in the standard. A red band is shown if a particular region's result is less than the performance recommendation. The following image shows this measurement.

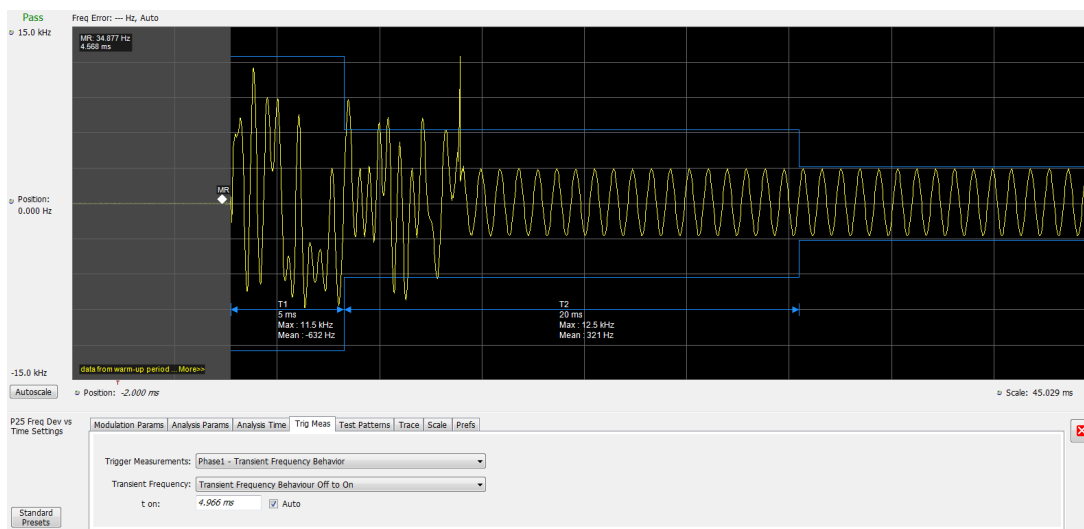

HCPM Tx Logical Channel Time Alignment (Phase 2 HCPM). The following information is specific to this measurement. This result can be viewed in P25 Summary and P25 Power vs Time displays.

- This measurement is done in two steps: First by calculating tOB_sync using HDQPSK data (the ISCH pattern is looked for) and then by using the result to calculate tIB_sync using HCPM data (the SACCH pattern is looked for).

The first step is done by choosing Time Alignment (tOB_sync measurement) in the Trig Meas tab in the Settings control panel.

When the second step, Time Alignment (t_error_0 calculation) or (t_error_1 calculation) is selected in the Trig Meas tab of the control panel, there is an option to override the tOB_sync value calculated in the first step.

- When this measurement is chosen, only this result is provided in the P25 Summary display.
- You must provide the ultraframe boundary to the trigger of the analyzer.
- An autocorrelation of the input RF signal with the reference patterns is performed to get the peak that will determine tOB_sync (measured) and t_error_0 or t_error_1 from the trigger point.

HCPM Tx Logical Channel Peak ACPR (Phase 2 HCPM)

This measures the ratio of total transmitter power under prescribed conditions and modulation to the peak power that falls in a prescribed bandwidth centred on the nominal frequency of the adjacent channel during the transmitter power ramping interval. This applies only to inbound signals. This measurement result appears in the P25 Summary display.

- This measurement is done by calculating power in the adjacent channels for the entire duration of data chosen by the user, including the power ramp up and ramp down portions. The standard recommends 360 ms of data for this measurement, unlike the other ACPR measurements for which the analysis is done only for the on slot region.
- The higher and lower adjacent channel power is reported in the P25 Summary display under Power Measurements.
- The two results are then subtracted from the calculated RF output power and the minimum of the two results is presented as the Min Pk ACPR in the P25 Summary display.
- This measurement is only done for bursty HCPM data and not for High Deviation or Low Deviation test patterns.
- The Limits tab in the P25 Summary Settings control panel allows you to compare the results against limits set for Pass/Fail.
- This measurement result is not shown in the P25 Summary display when trigger measurements are chosen.

NOTE. Read about important information related to HCPM bursty data measurements [here \(see page 322\)](#).

HCPM Transmitter Logical Channel Off Slot power (Phase 2 HCPM)

This measures the power of a TDMA transmitter during the off portion of the TDMA pulse. This measurement only applies to inbound signals. This result can be viewed in P25 Summary and P25 Power vs Time displays.

- The measurement is done as suggested by the standard to calculate P_{ONREL} and P_{OFFREL} . P_{ONREL} is the maximum level observed in the interval 1 ms to 29 ms and P_{OFFREL} is the maximum level observed in 30.2 ms to 59.8 ms.
- P_{TX} is the rated carrier power and can be set by the user from the Analysis Params tab in the Settings control panel.
- The absolute level of the off slot power is then calculated as $P_{\text{OFF}} = P_{\text{TX}} - (P_{\text{ONREL}} - P_{\text{OFFREL}})$ dBm
- This measurement is only done for bursty HCPM data and not for High Deviation or Low Deviation test patterns.
- The Limits tab in the P25 Summary Settings control panel allows you to compare the results against limits set for Pass/Fail.
- This measurement result is not shown in the P25 Summary display when trigger measurements are chosen.

NOTE. Read about important information related to HCPM bursty data measurements [here \(see page 322\)](#).

HCPM Transmitter Logical Channel Power Envelope (Phase 2 HCPM)

This is a measure of how well a portable radio controls the transmitter power as it inserts an inbound HCPM TDMA burst into a frame on a voice channel. This measurement applies to inbound signals only.

- All scalar results relevant to this measurement are shown both in P25 Power vs Time display and the P25 Summary display.
- The measurement results and the duration in which the measurements are made are shown graphically in P25 Power vs Time display. The results are grouped under Power Info and Time Info in the table at the bottom of the display.
- This measurement is only done for bursty HCPM data and not for High Deviation or Low Deviation test patterns.
- The Limits tab in the P25 Summary Settings control panel allows you to compare the results against limits set for Pass/Fail.
- This measurement result is not shown in the P25 Summary display when trigger measurements are chosen.

NOTE. Read about important information related to HCPM bursty data measurements [here \(see page 322\)](#).

P25 Test Patterns

A variety of test patterns are specified in the TIA-102 documents for use in performance testing of transmitters. These test patterns allow the software to compare the measurement result to the standards limit. Test engineers can select from the test patterns described in the following tables.

NOTE. Although this table gives the test patterns for measurements as recommended by the Standard, other measurement results are also be provided as additional information for a given test pattern. For example, Modulation Fidelity results can also be provided for High Deviation and Low Deviation test patterns.

Table 3: P25 test patterns, Phase 1 C4FM

TIA-102 Phase 1 C4FM test pattern	Phase 1 (C4FM) measurement
Standard transmitter	RF Output Power
	Operating Frequency Accuracy
	Modulation Emission Spectrum
	Unwanted Emissions (Adjacent Channel Power Ratio)
	Modulation Fidelity
	Transmitter Power and Encoder Attack Time

Table 3: P25 test patterns, Phase 1 C4FM (cont.)

TIA-102 Phase 1 C4FM test pattern	Phase 1 (C4FM) measurement
Standard Busy	Transmitter Power and Encoder Attack Time (With Busy/Idle Operations)
Low Deviation	Operating Frequency Accuracy
	Transient Frequency Behavior
	Frequency Deviation
Standard Idle	Transmitter Power and Encoder Attack Time (With Busy/Idle Operations)
Standard Transmitter Symbol Rate (Same as High Deviation test pattern)	Symbol Rate Accuracy
	Frequency Deviation
C4FM Modulation Fidelity	Modulation Fidelity
Standard Tone	Can be used for measurements such as RF Output Power, Operating Frequency Accuracy, Modulation Fidelity, and ACPR
Other (User created test pattern)	Can be used for measurements such as RF Output Power, Operating Frequency Accuracy, Modulation Fidelity, and ACPR

Table 4: P25 test patterns, Phase 2 Inbound and Outbound

TIA-102 Phase 2 test pattern	Phase 2 measurement
Standard Transmitter (Inbound and Outbound)	RF Output Power
	Operating Frequency Accuracy
	Modulation Emission Spectrum
	Unwanted Emissions (Adjacent Channel Power Ratio)
	Modulation Fidelity
Inbound Standard Tone Ch0	Can be used for measurements such as RF Output Power, Operating Frequency Accuracy, Modulation Fidelity, and ACPR
Inbound Standard Tone Ch1	Can be used for measurements such as RF Output Power, Operating Frequency Accuracy, Modulation Fidelity, and ACPR
Outbound Standard Tone	Operational Frequency Accuracy
Inbound Symmetrical Time Slot	RF Output Power
	Modulation Emission Spectrum
	Modulation Fidelity
	HCPM (Peak ACPR)
	HCPM (Off slot power)
	HCPM (Power envelope)
	Unwanted Emissions (Adjacent Channel Power Ratio)

Table 4: P25 test patterns, Phase 2 Inbound and Outbound (cont.)

TIA-102 Phase 2 test pattern	Phase 2 measurement
Low Deviation (Inbound)	Frequency deviation for HCPM
	Symbol Rate Accuracy
Low Deviation (Outbound)	Symbol Rate Accuracy
High Deviation (Inbound and Outbound)	Symbol Rate Accuracy
Other (User created test pattern)	Can be used for measurements such as RF Output Power, Operating Frequency Accuracy, Modulation Fidelity, and ACPR

Analysis of HCPM Bursty Data

It important to take into account the following information when analyzing HCPM bursty data.

- It is mandatory that at least one complete on slot and off slot region (including the ramp up and ramp down portion) have to be included in the analysis window for HCPM measurement results to be analyzed.
- If HCPM is the chosen standard in Standards Presets, then a minimum length of 94 ms is set for the analysis window. This is to ensure that a full on slot and off slot region is available irrespective of the selected analysis offset.
- Do not use the High Deviation or Low Deviation test patterns for bursty signals. Test patterns are selected in the P25 Settings control panel on the Test Patterns tab. If selected, analysis would look for a bursty pattern. High Deviation and Low Deviation test patterns are not bursty and therefore do not have the above analysis length restriction.

If you try to set the analysis length to less than 94 ms, the following status message will display:
P25:HCPM:Minimum Analysis Length should be \geq 94 ms.

- Most measurements that are required to be done on on slot regions are done centered at the on slot region of HCPM bursty data.

HCPM Pilot symbols are not displayed in the P25 Symbol Table.

It is mandatory that at least one complete on slot and off slot region (including the ramp up and ramp down portion) have to be included in the analysis window for HCPM measurement results to be analyzed.

The analysis module does not analyze two active adjacent slots (28 ms each) if they do not have the off slot (power off) region between them.

When HCPM bursty data is analyzed, the following status message will appear on all relevant displays:
P25:HCPM modulation analysis is done only on on slot regions.

NOTE. *The test patterns, except for High Deviation and Low Deviation, do not impact the HCPM pattern analysis for other selected test patterns, such as Standard Transmitter Test Pattern, Inbound Standard Tone Test Pattern Ch0, Inbound Standard Tone Test Pattern Ch1, Inbound Symmetrical Time Bound Test Pattern, and Others.*

P25 Constellation Display

The P25 Constellation Display shows the P25 signal modulation amplitude. For the HCPM and HDQPSK standards, you can view this display as frequency deviation or as I and Q. For the C4FM standard, only the frequency deviation applies.

To show the P25 Constellation display you can select **Presets > Standards > P25** or do the following:

1. Recall an appropriate acquisition data file.
2. Press the **Displays** button or select **Setup > Displays**.
3. In the **Select Displays** dialog, select **P25 Analysis** in the **Measurements** box.
4. In the Available displays box, double-click the **P25 Constellation** icon or select the icon and click **Add**. The P25 Constellation icon will appear in the **Selected displays** box and will no longer appear under Available displays.
5. Click **OK** to show the P25 Constellation display.
6. Select **Setup > Settings** to display the control panel.
7. Select the **Modulation Params** tab. Set the Standard, Modulation Type, and Measurement and Reference filters as appropriate for the input signal.
8. For Phase 2 signals, select the **Trace** tab and set the **Trace Type** to Freq Dev or IQ.
9. Select the **Test Patterns** tab and select the desired test pattern as appropriate for the input signal.

Elements of the Display

The following image shows the P25 Constellation display set to IQ for a HDQPSK signal.

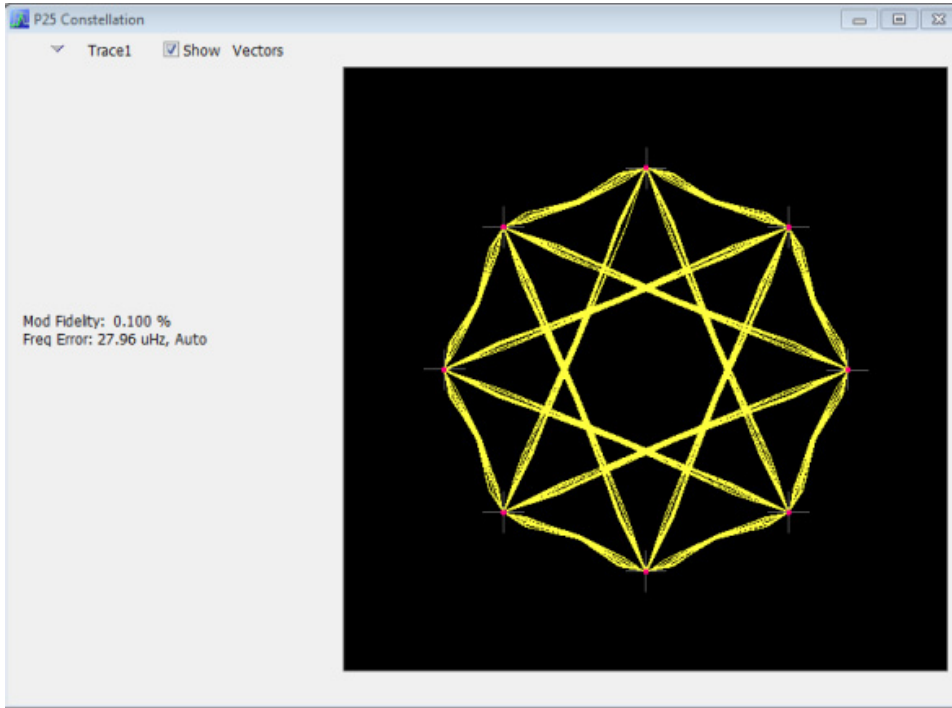

The following image shows the same signal as the previous image, but with the display set to Frequency Deviation.

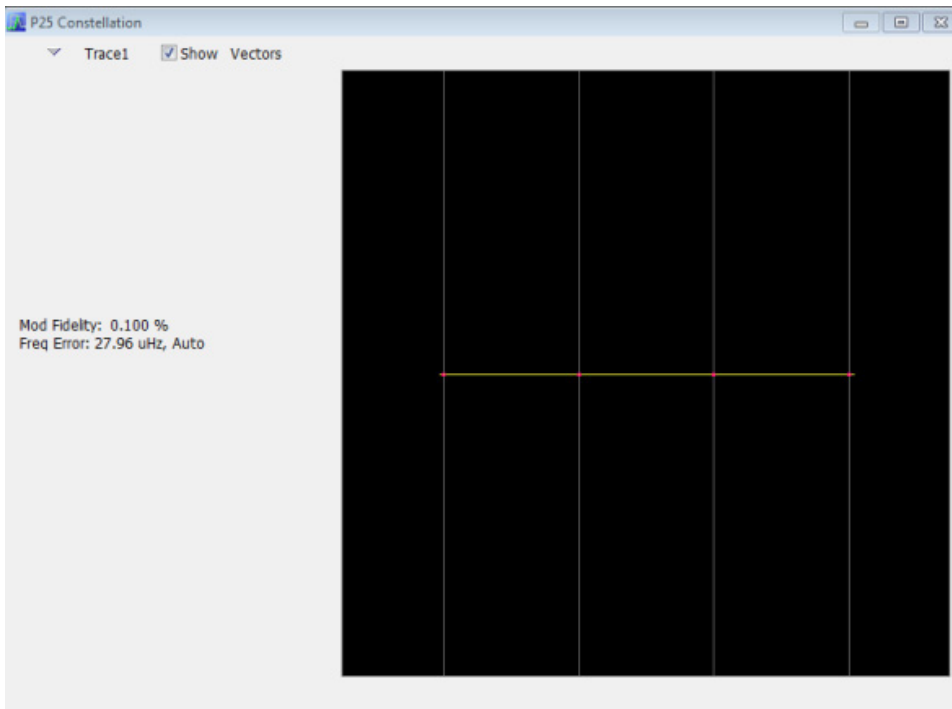

Item	Display element	Description
1	Marker Readout	Located to the left of the constellation plot or below it, depending on the size of the window. If markers are enabled, the marker readout will show frequency deviation results or IQ results (time, mag, phase, symbol marker and symbol value) of the point with the selected marker.
2	Measurement results readout	These readouts are located to the left or below of the Constellation plot, depending on the window size. The readout shows Modulation Fidelity (%) and Frequency Error (Hz). The second readout can either be Freq Error where the result is followed by Auto or it could be Freq Offset where the result is followed by Manual. This choice between Freq Error and Freq Offset is made from the Analysis Params tab in the Settings control panel.
3	Plot	Shown as either I vs Q or as Frequency Deviation. The trace type is controlled from the Settings > Trace tab.

P25 Constellation Settings

Main menu bar: Setup > Settings

Favorites toolbar: 

The P25 Constellation Settings control panel provides access to settings that control parameters of the Constellation Display.

Settings tab	Description
Modulation Params (see page 341)	Specifies the input signal standard and additional user-settable signal parameters.
Analysis Params (see page 344)	Specifies parameters used by the instrument to analyze the input signal.
Analysis Time (see page 344)	Specifies parameters that define the portion of the acquisition record that is used for analysis. Also allows you to specify the Units (Symbols or Seconds) and Time Zero Reference (Trigger or Acquisition Start) for P25 Analysis displays.
Test Patterns (see page 346)	Specifies the type of test pattern being used. Some analysis differs based on the selected test pattern. Available test patterns vary depending on the selected standard and modulation type.
Trace (see page 347)	Specifies the trace type (Vectors, Points, and Lines), the number of points per symbol when chosen to view as Vectors or Lines, and to control the view as Freq Dev or IQ.
Prefs (see page 350)	Specifies the radix of the marker readout and whether elements of the graphs are displayed.
Trig Meas (see page 349)	Enables you to select from several different trigger measurements.

P25 Eye Diagram Display

The P25 Eye Diagram display shows a digitally modulated signal overlapped on itself to reveal variations in the signal.

To show the P25 Eye Diagram display:

1. Recall an appropriate acquisition data file.
2. Press the **Displays** button or select **Setup > Displays**.
3. From the **Measurements** box, select **P25 Analysis**.
4. Double-click the **P25 Eye Diagram** icon in the **Available Displays** box. This adds the P25 Eye Diagram icon to the **Selected displays** box.
5. Click **OK** button. This displays the P25 Eye Diagram view.
6. Select **Setup > Settings** to display the control panel.
7. Select the **Modulation Params** tab. Set the Standard, Modulation Type, and Measurement and Reference filters as appropriate for the input signal.
8. For Phase 2 signals, select the **Trace** tab and set the **Trace Type** to Freq Dev or IQ.
9. Select the **Test Patterns** tab and choose a test pattern appropriate for the input signal.

Elements of the Display

The following image shows the P25 Eye display with Trace Type set to IQ.

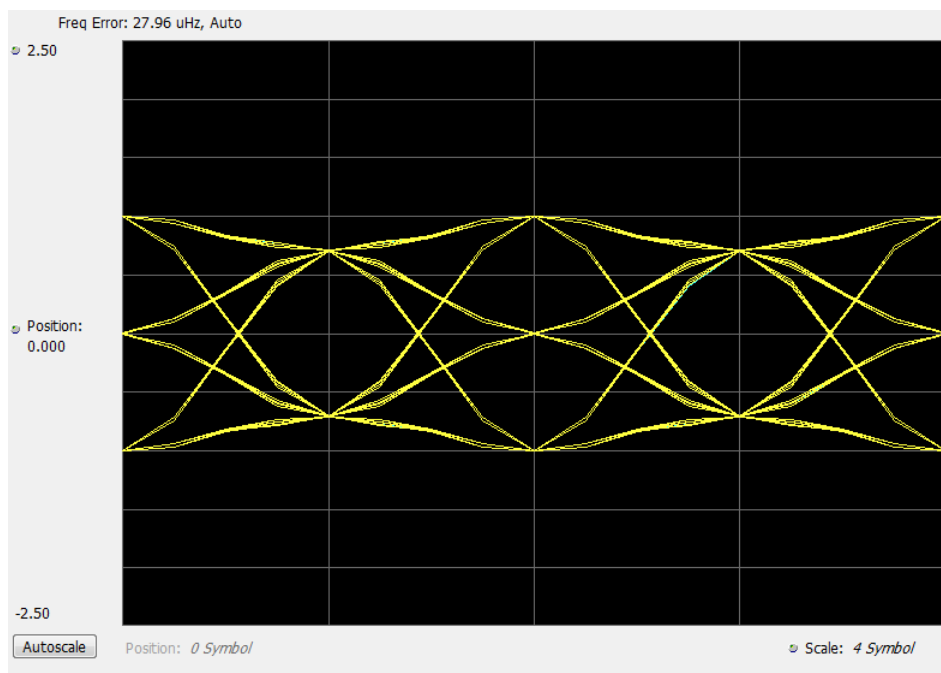

The following image shows the P25 Eye display with Trace Type set to Freq Dev.

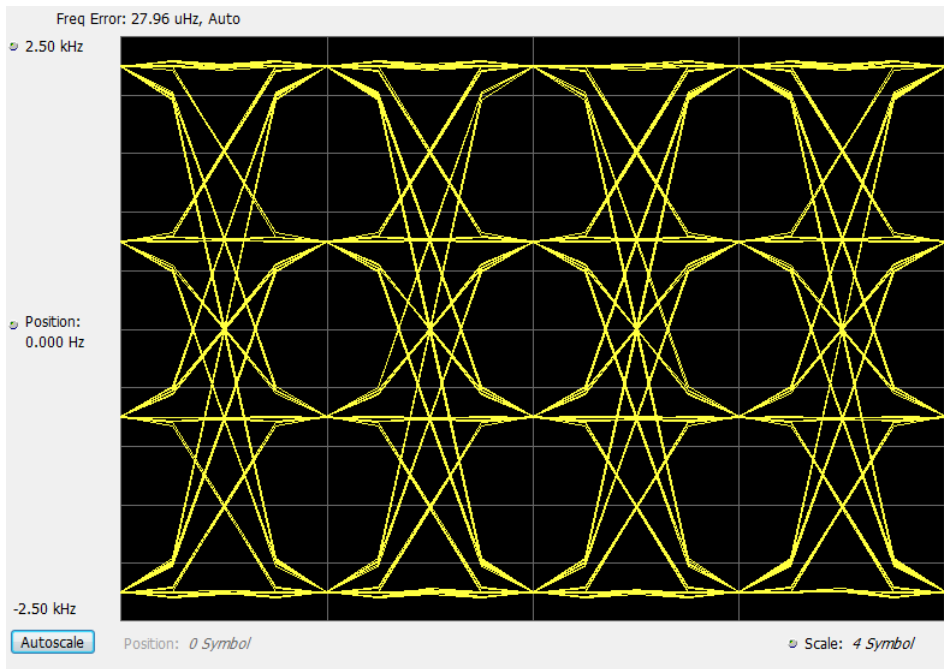

Item	Display element	Description
1	Top of graph	The vertical scale is normalized with no units (for IQ) and with Hz (for Freq dev).
2	Position	Specifies the value shown at the center of the graph display.
3	Bottom Readout	Displays the value indicated by the bottom of graph.
4	Autoscale	Adjusts the vertical and horizontal settings to provide the best display.
5	Position	Displays the horizontal position of the trace on the graph display.
6	Scale	Adjusts the span of the graph in symbols.
7	Freq Error	Displays the difference between the maximum and minimum measured values of the signal frequency during the Measurement Time. The readout can either be Freq Error where the result is followed by Auto or it could be Freq Offset where the result is followed by Manual. This choice between Freq Error and Freq Offset is made from the Analysis Params tab in the Settings control panel.

P25 Eye Diagram Settings

Main menu bar: Setup > Settings

Favorites toolbar: 

The settings for the P25 Eye Diagram display are shown in the following table.

Settings tab	Description
Modulation Params (see page 341)	Specifies the input signal standard and additional user-settable signal parameters.
Analysis Params (see page 344)	Specifies parameters used by the instrument to analyze the input signal.
Analysis Time (see page 344)	Specifies parameters that define the portion of the acquisition record that is used for analysis. Also allows you to specify the Units (Symbols or Seconds) for P25 Analysis displays.
Trig Meas (see page 349)	Enables you to select from various trigger measurements. The trigger selections vary by signal type.
Test Patterns (see page 346)	Specifies the type of test pattern being used. Some analysis differs based on the selected test pattern. Available test patterns vary depending on the selected standard and modulation type.
Trace (see page 347)	Specifies the trace type (Vectors, Points, and Lines), the number of points per symbol when chosen to view as Vectors or Lines, and to control the view as Freq Dev or IQ.
Scale (see page 347)	Defines the vertical and horizontal axes.
Prefs (see page 350)	Specifies the radix of the marker readout and whether elements of the graphs are displayed.

P25 Power vs Time Display

The P25 Power vs Time display shows the signal power amplitude versus time. In HCPM bursty data, the Regions A, B and C are shown based on the middle of the burst and not based on the pilots.

To show the P25 Power vs Time display:

1. Recall an appropriate acquisition data file.
2. Press the **Displays** button or select **Setup > Displays**.
3. In the **Select Displays** dialog, select **P25 Analysis** in the **Measurements** box.
4. In the Available displays box, double-click the **P25 Power vs Time** icon or select the icon and click **Add**. The P25 Power vs Time icon will appear in the **Selected displays** box and will no longer appear under Available displays.
5. Click **OK** to show the P25 Power vs Time display.
6. Select **Setup > Settings** to display the control panel.
7. Select the **Modulation Params** tab. Set the Standard, Modulation Type, and Measurement and Reference filters as appropriate for the input signal.
8. Select the **Test Patterns** tab and choose a test pattern appropriate for the input signal.

Elements of the Display

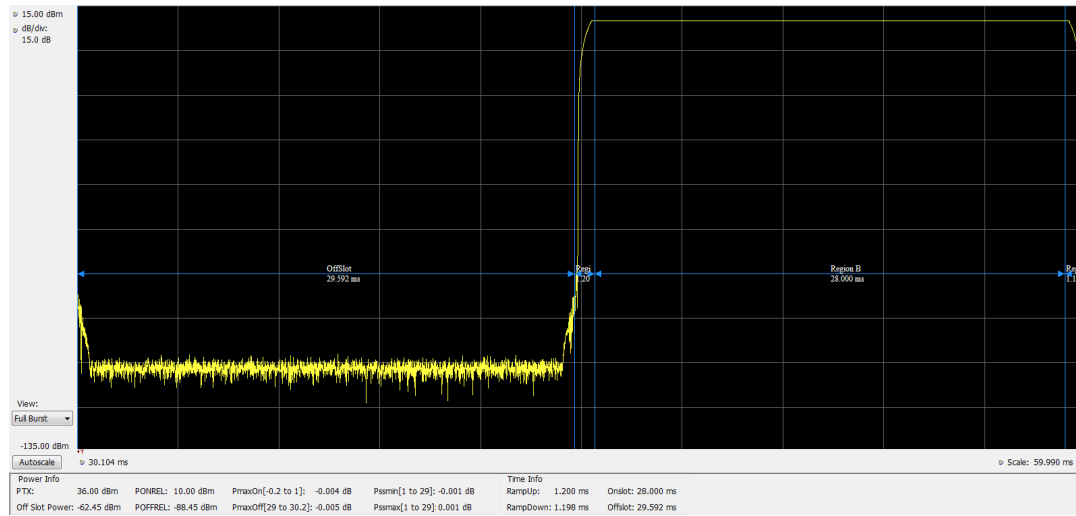

Item	Display element	Description
1	Top of graph, first setting	Sets the Power level that appears at the top of the graph, in dBm. This is only a visual control for panning the graph.
2	Units	Sets the global amplitude units for all the views in the analysis window. This will change the amplitude selection in the Units tab of the Amplitude control panel.
3	Top of graph, second setting	Sets the vertical Scale of the graphs, in dB/div. This is only a visual control for panning the graph.
4	View (Only available for bursty HCPM data.)	Selects the specific view of the packet burst within the display: Full Burst displays the entire packet, with vertical lines indicating Power ramp up, On Slot, Power ramp down, and Off slot regions. Ramp Up zooms the display into the interval around the packet rising edge. Ramp Down zooms the display into the interval around the packet falling edge.
5	Bottom of graph readout	Shows the Power level at the bottom of the graph in dBm.
6	Autoscale	Adjusts the vertical and horizontal settings to provide the best display.
7	Bottom of graph, left side	Sets the starting time of the graph in seconds
8	Bottom of graph, right side	Sets the scale (width) of the graph in seconds
9	Table below graph	This table shows the following results. For non-bursty signals: RF output power For bursty signals: Power Info (Offslot Power and Power Envelope results) and Time Info.

P25 Power vs Time Settings

Main menu bar: Setup > Settings

Favorites toolbar: 

The settings for the P25 Power vs Time display are shown in the following table.

Settings tab	Description
Modulation Params (see page 341)	Specifies the input signal standard and additional user-settable signal parameters.
Analysis Params (see page 344)	Specifies parameters used by the instrument to analyze the input signal.
Analysis Time (see page 344)	Specifies parameters that define the portion of the acquisition record that is used for analysis. Also allows you to specify the Units (Symbols or Seconds) for P25 Analysis displays.
Trig Meas (see page 349)	Enables you to select from various trigger measurements. The trigger selections vary by signal type.
Test Patterns (see page 346)	Specifies the type of test pattern being used. Some analysis differs based on the selected test pattern. Available test patterns vary depending on the selected standard and modulation type.
Scale (see page 347)	Defines the vertical and horizontal axes.
Prefs (see page 350)	Specifies the radix of the marker readout and whether elements of the graphs are displayed.

P25 Summary Display

The P25 Summary display shows a summary of all the scalar measurements done on the acquired test pattern. The summary display and contents will vary according to the selected standard.

Pass/Fail information is also provided in this display for all enabled scalar measurements. You can set limits and choose which measurement to compare for Pass/Fail from the Limits tab in the P25 Summary Settings control panel. The default limits come from the performance recommendation limits given by the Standard document. The default limits can be reloaded by selecting the P25 Standards Preset option or by loading the default limits table.

To show the P25 Summary display you can select **Presets > Standards > P25** or do the following:

1. Recall an appropriate acquisition data file.
2. Press the **Displays** button or select **Setup > Displays**.
3. In the **Select Displays** dialog, select **P25 Analysis** in the **Measurements** box.
4. In the Available displays box, double-click the **P25 Summary** icon or select the icon and click **Add**. The P25 Summary icon will appear in the **Selected displays** box and will no longer appear under Available displays.
5. Click **OK** to show the P25 Summary display.
6. Select **Setup > Settings** to display the control panel.
7. Select the **Modulation Params** tab. Set the Standard, Modulation Type, and Measurement and Reference filters as appropriate for the input signal.
8. Select the **Test Patterns** tab and select a test pattern. The available test patterns in the drop down list depend of the standard and modulation type you have selected.

P25 Summary Display

The Modulation Measurements, Power Measurements, and Trigger Measurements components of this display vary depending on which modulation type is selected.

The following image shows an example of the display for a Phase 1 C4FM signal.

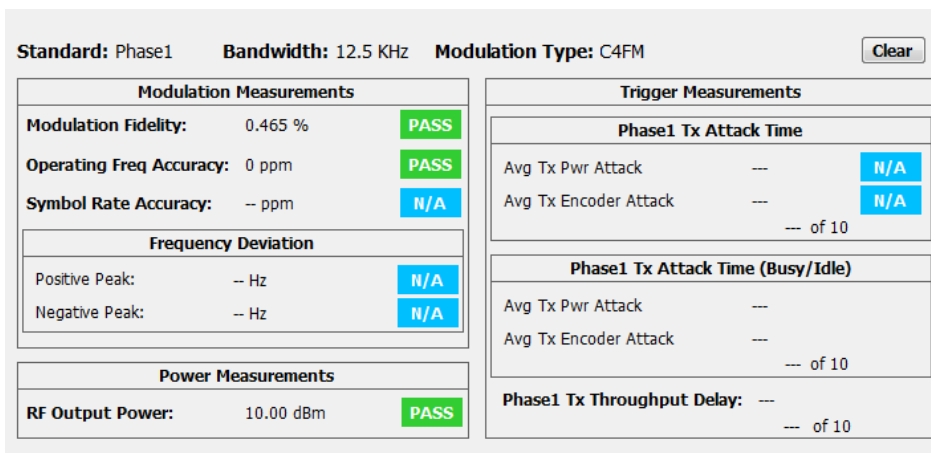

The following image shows an example of the display for a Phase 1 C4FM High Deviation signal.

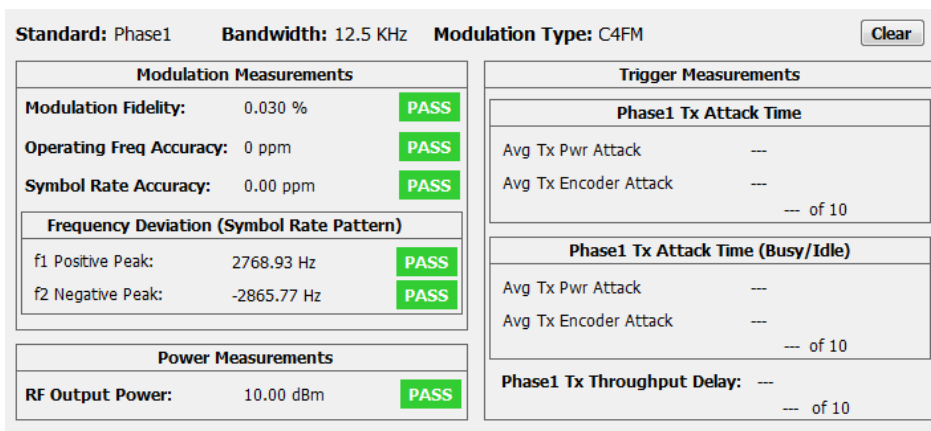

The following image shows an example of the display for a Phase 2 HCPM (Inbound) signal.

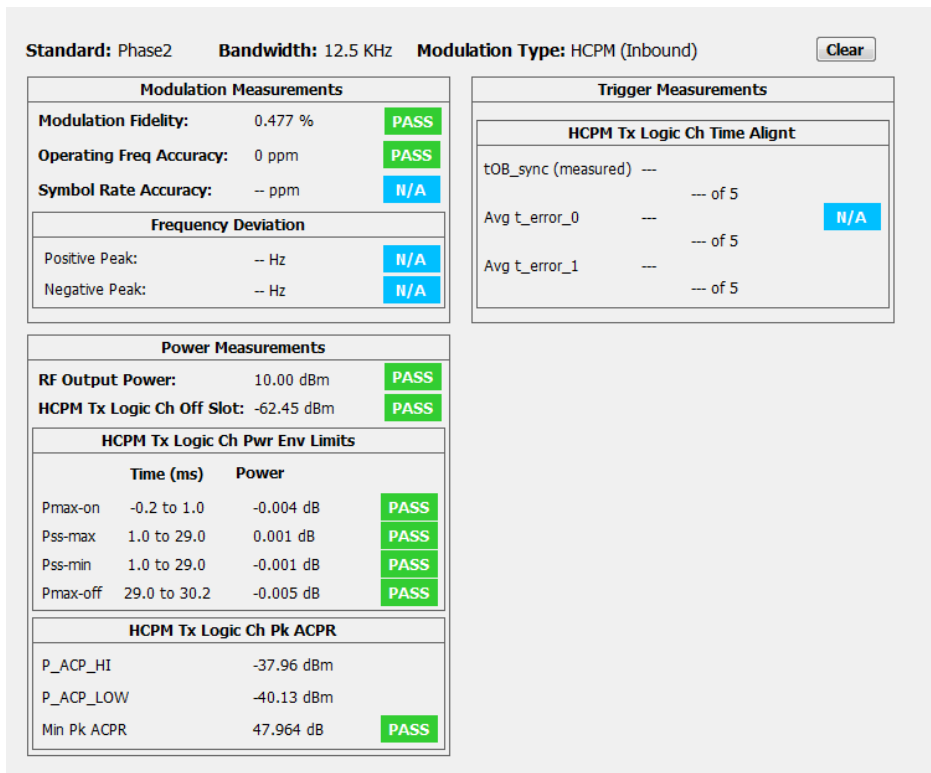

The following image shows an example of the display for a Phase 2 HDQPSK (Outbound) signal.

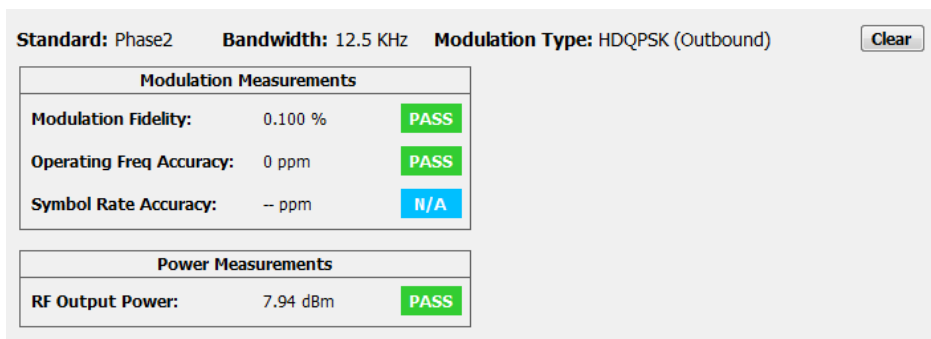

For more information about specific measurement results, see the P25 Measurements section [here \(see page 359\)](#).

Elements of the Display

Element	Description
Standard	Display of the standard selected on the Setup > Settings > Modulation Params tab.
Bandwidth	Display of the channel bandwidth which is set based on the standard and modulation type.
Modulation Type	Display of the modulation type selected on Setup > Settings > Modulation Parameters tab.
Clear	Click button to reset measurement. Clears all values.
Modulation Measurements	Shows the modulation measurements associated with the signal.
Power Measurements	Shows the power measurements associated with the signal.
Trigger Measurements	Shows the trigger measurements associated with the signal.

P25 Summary Settings

Main menu bar: Setup > Settings

Favorites toolbar: 

The settings for the P25 Summary display are shown in the following table.

Settings tab	Description
Modulation Params (see page 341)	Specifies the input signal standard and additional user-settable signal parameters.
Analysis Params (see page 344)	Specifies parameters used by the instrument to analyze the input signal.
Analysis Time (see page 344)	Specifies parameters that define the portion of the acquisition record that is used for analysis. Also allows you to specify the Units (Symbols or Seconds) for P25 Analysis displays.
Trig Meas (see page 349)	Enables you to select from various trigger measurements. The trigger selections vary by signal type.
Test Patterns (see page 346)	Specifies the type of test pattern being used. Some analysis differs based on the selected test pattern. Available test patterns vary depending on the selected standard and modulation type.
Limits (see page 351)	Load and define P25 measurement limits for Pass/Fail comparison. You can save defined limits as a .csv file and also load previously saved .csv files.

P25 Symbol Table Display

The P25 Symbol Table display shows decoded data values for each data symbol in the analyzed signal packet.

To show the P25 Symbol Table display:

1. Recall an appropriate acquisition data file.
2. Press the **Displays** button or select **Setup > Displays**.
3. In the **Select Displays** dialog, select **P25 Analysis** in the **Measurements** box.
4. In the Available displays box, double-click the **P25 Symbol Table** icon or select the icon and click **Add**. The P25 Symbol icon will appear in the **Selected displays** box and will no longer appear under Available displays.
5. Click **OK** to show the P25 Symbol Table display.
6. Select **Setup > Settings** to display the control panel.
7. Select the **Modulation Params** tab. Set the Standard, Modulation Type, and Measurement and Reference filters as appropriate for the input signal.
8. Select the **Test Patterns** tab and select a test pattern. The available test patterns in the drop down list depend on the standard and modulation type you have selected.

P25 Symbol Table

The following image shows the P25 Symbol Table for HCPM (bursty) signals. For this signal type, the symbols are arranged as Bursts vs Symbols. The analysis is done only on the on slot regions of the bursty HCPM data and 160 symbols (centered at the middle of the burst) are reported on the symbol table for every on slot region. You can read more about specific measurements [here \(see page 359\)](#).

	B1	B2
0	1	3
1	3	1
2	2	1
3	1	0
4	2	3
5	3	3
6	0	0
7	3	1
8	2	3
9	1	2
10	0	3
11	2	2
12	3	0
13	1	3
14	2	2
15	2	2
16	0	1
17	0	3
18	0	2
19	3	3
20	2	3
21	1	0
22	3	0
23	1	0

The following image shows the P25 Symbol Table for C4FM (non-bursty) signals. For this signal type and for HDQPSK, there is no grouping into bursts and all symbols that are analyzed are shown.

0	3	2	0	0	0	2	1	1	3	2	2	3	0	2	2	1
16	1	3	3	1	1	3	0	2	2	0	0	3	0	0	0	3
32	3	2	0	2	0	0	0	3	1	2	0	3	1	0	3	2
48	3	2	3	3	3	1	3	1	3	1	0	0	1	1	2	3
64	2	1	2	3	3	3	3	0	2	1	0	2	3	3	3	1
80	0	1	3	3	0	1	3	1	0	1	2	3	1	1	2	2
96	0	2	0	0	3	0	1	3	2	3	0	0	2	2	0	3
112	3	2	3	3	1	0	3	3	2	0	3	0	2	0	0	2
128	1	2	2	1	2	2	2	0	3	1	1	2	2	2	1	2
144	3	1	3	1	3	2	2	0	2	1	1	1	2	0	0	3
160	3	2	2	0	2	3	1	1	3	0	2	2	0	2	3	0
176	2	1	1	0	0	0	3	2	1	1	3	1	3	3	3	2
192	3	1	0	3	1	2	2	2	1	3	3	0	3	0	3	0
208	2	3	3	2	1	3	0	3	1	2	2	2	0	0	0	1
224	0	2	1	0	1	0	1	3	2	3	2	2	3	1	2	0
240	3	2	2	0	2	3	2	1	0	1	3	3	2	1	2	0
256	1	2	3	2	0	0	2	0	0	0	1	0	1	1	0	3
272	3	2	0	2	1	3	3	0	0	3	2	0	3	0	3	3
288	3	2	3	0	2	1	1	1	2	0	1	1	1	2	1	3
304	1	2	3	0	1	0	1	3	1	2	2	1	1	3	3	2
320	1	1	3	2	3	2	0	0	1	0	0	0	3	3	2	1

Marker: MR Symbol: 152
 Time: 39.578 ms Value: 2

Elements of the Display

Element	Description
Marker	Displays the selected marker label.
Time	Displays the time in ms or in Symbols based on the Units chosen in the Analysis Time tab of the Settings Control panel.
Symbol	The value shown here reflects the symbol you have selected (highlighted) in the display.
Value	Displays the value of the selected symbol.

P25 Symbol Table Settings

Main menu bar: Setup > Settings

Favorites toolbar: 

The settings for the P25 Symbol Table display are shown in the following table.

Settings tab	Description
Modulation Params (see page 341)	Specifies the input signal standard and additional user-settable signal parameters.
Analysis Params (see page 344)	Specifies parameters used by the instrument to analyze the input signal.
Analysis Time (see page 344)	Specifies parameters that define the portion of the acquisition record that is used for analysis. Also allows you to specify the Units (Symbols or Seconds) for P25 Analysis displays.
Trig Meas (see page 349)	Enables you to select from various trigger measurements. The trigger selections vary by signal type.
Test Patterns (see page 346)	Specifies the type of test pattern being used. Some analysis differs based on the selected test pattern. Available test patterns vary depending on the selected standard and modulation type.
Prefs (see page 350)	Specifies the radix of the marker readout.

P25 Frequency Dev vs Time Display

The P25 Frequency Deviation vs. Time Display shows how the signal frequency varies with time.

To display the P25 Frequency Dev vs. Time Display:

1. Recall an appropriate acquisition data file.
2. Select the **Displays** button or **Setup > Displays**.
3. In the **Select Displays** dialog, select **P25 Analysis** in the **Measurements** box.
4. In the **Available displays** box, double-click the **P25 Frequency Dev vs. Time** icon or select the icon and click **Add**. The P25 Frequency Dev vs. Time icon will appear in the **Selected displays** box and will no longer appear under Available displays.
5. Click **OK** to display the Freq Dev vs. Time display.
6. Select the **Modulation Params** tab. Set the Standard, Modulation Type, and Measurement and Reference filters as appropriate for the input signal.
7. Select the **Test Patterns** tab and select a test pattern. The available test patterns in the drop down list depend of the standard and modulation type you have selected.

Elements of the Display

The following image shows the P25 Freq Dev vs Time display for Phase 1 C4FM (non-bursty) High Deviation signals.

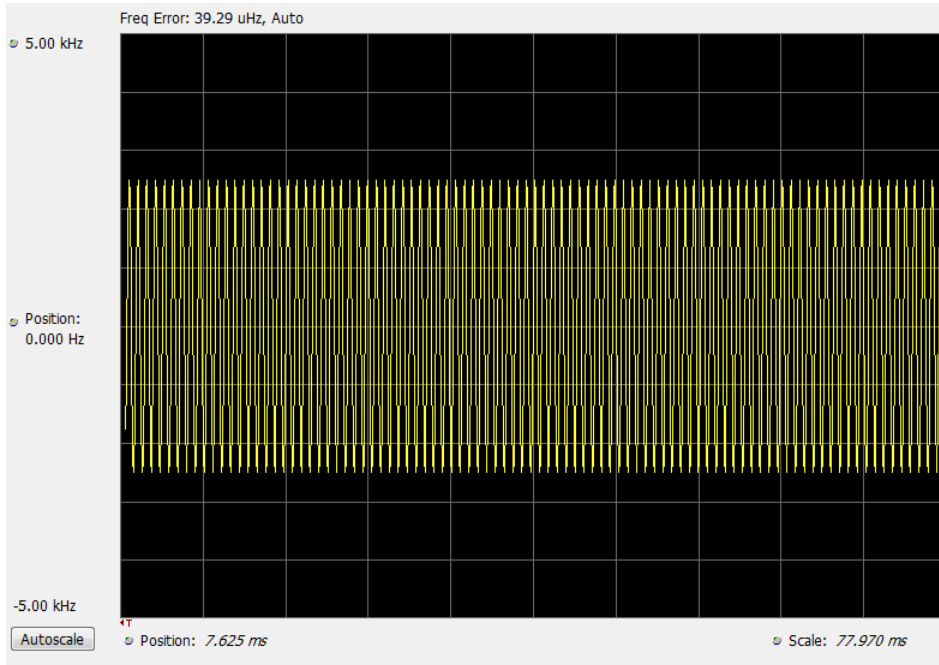

The following image shows the P25 Freq Dev vs Time display for Phase 2 HCPM (bursty) signals.

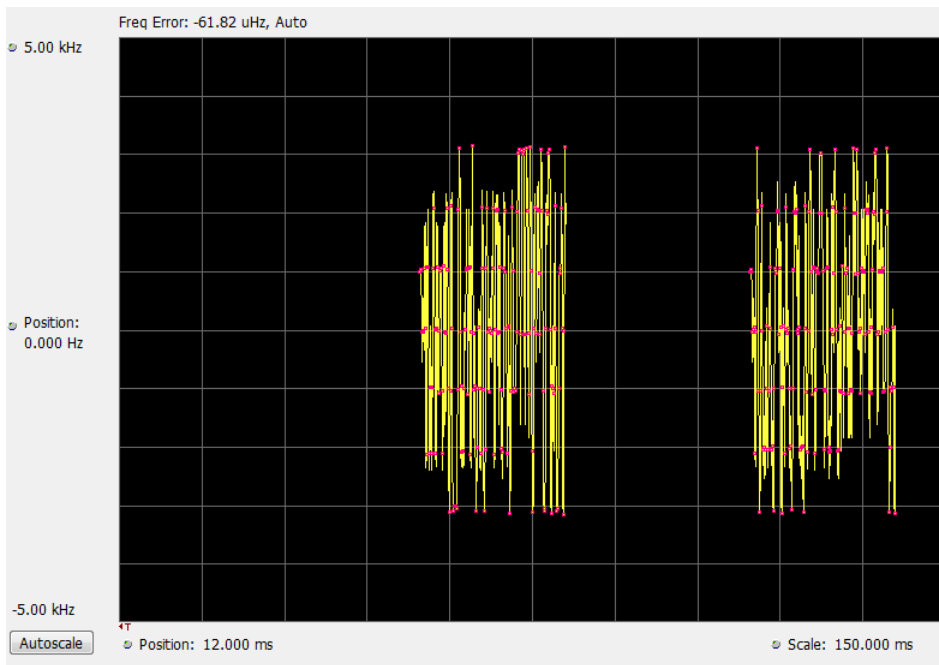

NOTE. For bursty HCPM signals, frequency deviation analysis is done only on 160 symbols centered at every on slot region in the chosen analysis window and not on off slot regions. That is why there is no information shown during off slot regions. You can read more specific information about P25 measurements [here \(see page 312\)](#).

Elements of the Display

Item	Display element	Description
1	Top of graph adjustment	Adjust the frequency range displayed on the vertical axis.
2	Position (center)	Adjust the frequency shown at the center of the display.
3	Autoscale button	Adjusts the offset and range for both vertical and horizontal to provide the best display.
4	Position	Displays the horizontal position of the trace on the graph display.
5	Scale	Adjust the horizontal scale (time).

[Changing Frequency vs Time Display Settings \(see page 339\)](#)

P25 Frequency Dev Vs Time Settings

Main menu bar: Setup > Settings

Favorites toolbar: 

The Setup settings for P25 Frequency Dev vs. Time are shown in the following table.

Settings tab	Description
Modulation Params (see page 341)	Specifies the input signal standard and additional user-settable signal parameters.
Analysis Params (see page 344)	Specifies parameters used by the instrument to analyze the input signal.
Analysis Time (see page 344)	Specifies parameters that define the portion of the acquisition record that is used for analysis. Also allows you to specify the Units (Symbols or Seconds) for P25 Analysis displays.
Trig Meas (see page 349)	Enables you to select from various trigger measurements. The trigger selections vary by signal type.
Test Patterns (see page 346)	Specifies the type of test pattern being used. Some analysis differs based on the selected test pattern. Available test patterns vary depending on the selected standard and modulation type.
Trace (see page 347)	Specifies the trace type (Vectors, Points, and Lines), the number of points per symbol when chosen to view as Vectors or Lines, and to control the view as Freq Dev or IQ.
Scale (see page 347)	Defines the vertical and horizontal axes.
Prefs (see page 350)	Specifies the radix of the marker readout and whether elements of the graphs are displayed.

P25 Analysis Shared Measurement Settings

Main menu bar: Setup > Settings

Favorites toolbar: 

The control panel tabs in this section are shared between the displays in P25 Analysis (Setup > Displays). Some tabs are shared by all the displays, some tabs are shared by only a subset of displays. The settings available on some tabs change depending on the selected display.

Common controls for P25 analysis displays

Settings tab	Description
Modulation Params (see page 341)	Specifies the input signal standard and additional user-settable signal parameters.
Analysis Params (see page 344)	Specifies parameters used by the application to analyze the input signal.
Analysis Time (see page 344)	Specifies parameters that define the portion of the acquisition record that is used for analysis. Also allows you to specify the Units (Symbols or Seconds) for P25 Analysis displays.
Trace (see page 347)	Specifies the trace type (Vectors, Points, and Lines), the number of points per symbol when chosen to view as Vectors or Lines, and to control the view as Freq Dev or IQ.
Scale (see page 347)	Defines the vertical and horizontal axes.
Test Patterns (see page 346)	Enables you to select from eight different test patterns.
Trig Meas (see page 349)	Enables you to select from various trigger measurements. The trigger selections vary by signal type.
Prefs (see page 350)	Specifies the radix of the marker readout and whether elements of the graphs are displayed.

Modulation Params Tab - P25

The Modulation Params tab specifies the type of modulation used by the input signal and other parameters that define the signal format.

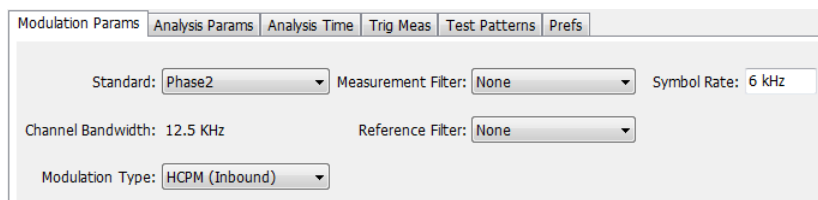

The screenshot shows the 'Modulation Params' tab selected in a software interface. The settings are as follows:

- Standard: Phase2
- Measurement Filter: None
- Symbol Rate: 6 kHz
- Channel Bandwidth: 12.5 KHz
- Reference Filter: None
- Modulation Type: HCPM (Inbound)

Settings	Description
Standard	Specifies the standard used for the input signal: Phase 1, Phase 2.
Channel Bandwidth	This readout shows the nominal channel bandwidth based on the standard.
Modulation Type	Specifies the modulation type of the input signal. Choices vary depending on the selected standard. Modulation types for Phase 2 are HCPM (Inbound) and HDQPSK (Outbound). Phase 1 has only C4FM as the modulation type selection.
Measurement Filter	Specifies the filter used as a measurement.
Reference Filter	Specifies the filter used as a reference.
Filter Parameter	Enter a value used for defining the Reference Filter. (Not present for some filter types)
Symbol Rate	This is a readout that shows the symbol rate for demodulating digitally modulated signals based on the standard. This rate is always 4.8 kHz for Phase 1 signals and 6 kHz for Phase 2 signals.

Symbol Rate

Specifies the symbol rate for demodulating digitally modulated signals based on the standard. The symbol rate and the bit rate are related as follows:

$$(\text{Symbol rate}) = (\text{Bit rate}) / (\text{Number of bits per symbol})$$

The bit rate used for Phase 1 (C4FM) is 9600 bps. For Phase 2 (HCPM and HDQPSK) it is 12000 bps. There are two bits per symbol for all above mentioned modulation types. Therefore, the symbol rate is 4800 Hz for Phase 1 and 6000 Hz for Phase 2.

Measurement and Reference Filters

The available measurement and reference filters depend on the selected modulation type. The following table shows the recommended filters for the specified modulation types.



CAUTION. *Although there are other filter types listed in the drop down menu, if you select any filter other than that which is recommended, the measurement results may not be accurate.*

Modulation type	Measurement filters	Reference filters
HDQPSK	HDQPSK-P25	None
HPCM	None	None
C4FM	C4FM-P25	RaisedCosine (Filter parameter 0.2)

The measurement filter is applied before the demodulation bit is detected and the ideal reference is calculated.

The reference filter is applied to the internally generated ideal reference signal before the modulation fidelity is calculated.

How to Select Filters

In a signal transmitter/receiver system, the baseband signal might be filtered for bandwidth limiting or for another kind of necessary shaping that needs to be applied. Normally, a filter in the transmitter (F_t) and a filter in the receiver (F_r) are applied.

The Measurement Filter setting in the analyzer corresponds to the baseband filter in the receiver (F_r): This setting tells the analyzer what filter your receiver uses. When the analyzer is set to the same filter used by the receiver, the analyzer sees the signal as your receiver would. The Measurement Filter setting should be the same as the filter used in the receiver under normal operation (as opposed to testing).

The Reference Filter setting in the analyzer corresponds to the baseband filter in the transmitter-receiver combination ($F_r * F_t$). The baseband filter for the transmitter-receiver combination is often referred to as the *System Filter*. This filter is called the reference filter because it is used to recreate a reference signal that is compared to the received signal. This recreated reference signal is the *ideal signal* with $F_r * F_t$ applied; differences between this *ideal signal* and the received signal enables the determination of signal quality, such as modulation fidelity measurements.

Filter Parameter (C4FM only)

The filter parameter specifies the alpha for the Raised Cosine filter when selected as the Reference filter. Some filter types have a fixed parameter value that is specified by industry standard, while other filter types by definition have no filter parameter. For filter types with no filter parameter, there is no filter parameter control present in the control panel. The recommended Reference filter for C4FM is Raised Cosine and the corresponding filter parameter for C4FM is 0.2.

Analysis Params Tab - P25

The Analysis Params tab contains parameters that control the analysis of the input signal.

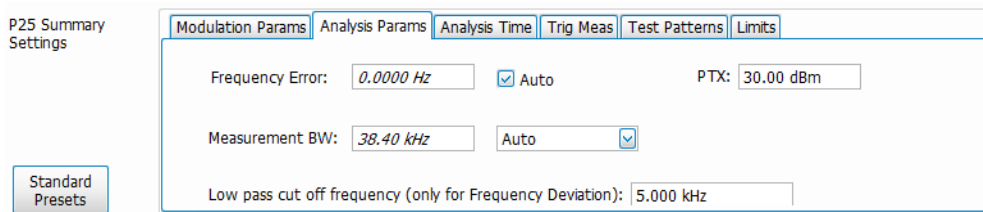

Settings	Description
Frequency Error	When the Auto box is checked, the analysis determines the Frequency Error and the measured Frequency Error is displayed. When the Auto box is unchecked, the entered value is used by the analysis as a fixed frequency offset. This is useful when the exact frequency offset of the signal is known.
Measurement BW	Specifies the bandwidth about the center frequency at which measurements are made. Select Manual, Auto, or Link to Span.
PTX	Specifies the RF Output Power as recommended for transmitters. This is only used in the computation of off slot power in HCPM modulated signals.
Low Pass cut off frequency (only for frequency deviation)	Specifies the filter cut off frequency for Frequency deviation measurement. This setting will only affect the scalar results Frequency Deviation (Positive and Negative Peak f1,f2,f3, and f4) in the Summary display. This selection is only visible when High or Low Deviation or Standard Transmitter Symbol Rate Pattern is chosen from the Test Patterns tab of the Settings Control panel.

Analysis Time Tab - P25

The Analysis Time tab contains parameters that define how the signal is analyzed in the P25 Analysis displays.

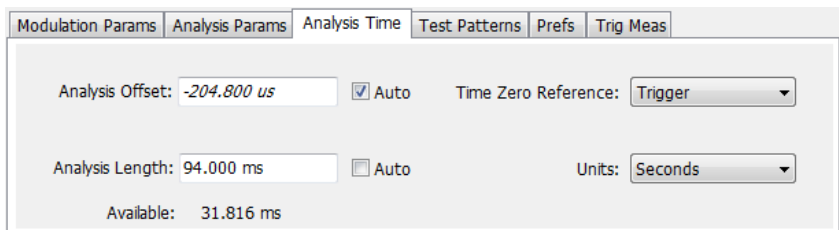

Settings	Description
Analysis Offset	Specifies the location of the first time sample to use in measurements.
Auto	When enabled, causes the instrument to set the Analysis Offset value based on the requirements of the selected display.
Analysis Length	Specifies the length of the analysis period to use in measurements. Length is specified in either symbols or seconds, depending on the Units setting.
Auto	When enabled, causes the instrument to set the Analysis Length value based on the requirements of the selected display.
Actual	This is a displayed value, not a setting. It is the Analysis Length (time or symbols) being used by the analyzer, this value may not match the Analysis Length requested (in manual mode).
Time Zero Reference	Specifies the zero point for the analysis time.
Units	Specifies the units of the Analysis Length to either Symbols or Seconds.

Analysis Offset

Use analysis offset to specify where measurements begin. Be aware that you cannot set the Analysis Offset outside the range of time covered by the current acquisition data. (all time values are relative to the Time Zero Reference).

You can set the Analysis Length so that the requested analysis period falls partly or entirely outside the current range of acquisition data settings. When the next acquisition is taken, its Acquisition Length will be increased to cover the new Analysis Length, as long as the Sampling controls are set to Auto. If the Sampling parameters are set to manual, or if the instrument is analyzing saved data, the actual analysis length will be constrained by the available data length, but in most cases, measurements are able to be made anyway. The instrument will display a notification when measurement results are computed from less data than requested. Range: 0 to [(end of acquisition) - Analysis Length]. Resolution: 1 effective sample (or symbol).

Analysis Length

Use the analysis length to specify how long a period of time is analyzed. As you adjust this value, the actual amount of time for Analysis Length, in Symbol or Seconds units, is shown below the control in the "Actual" readout. This setting is not available when Auto is checked. Range: minimum value depends on modulation type. Resolution: 1 symbol.

Time Zero Reference

All time values are measured from this point (such as marker position or horizontal position (in Y vs Time displays). Choices are: Acquisition Start or Trigger. When a trigger measurement is chosen from the Trig Meas tab of the Settings control panel, Time Zero Reference is forced to Trigger.

Parameter	Description
Acquisition Start	Time zero starts from the point at which acquisition begins.
Trigger	Time zero starts from the trigger point.

Test Patterns Tab - P25

Test patterns allow the software to compare the measurement result to the standards limit. The list of available test patterns varies depending on which standard and modulation type is selected.

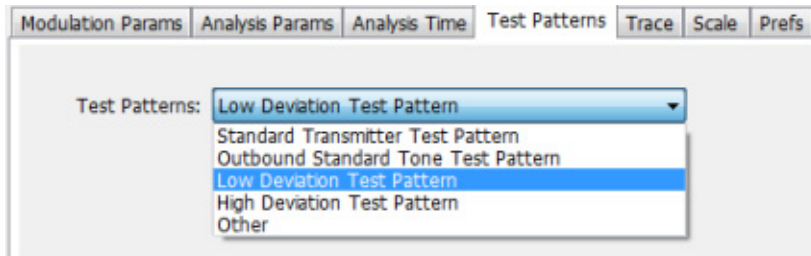

Settings	Description
Test Patterns	Use this drop-down list to select an appropriate test pattern. The list varies depending on which standard and modulation type is selected.

You can read more about test patterns [here \(see page 320\)](#).

Trace Tab - P25

The Trace tab allows you to set the trace display characteristics of the P25 trace display. The selections vary depending on the selected display.

The following image shows the tab for the Constellation and Eye Diagram displays. For the other trace displays, the Trace Type setting is not available.

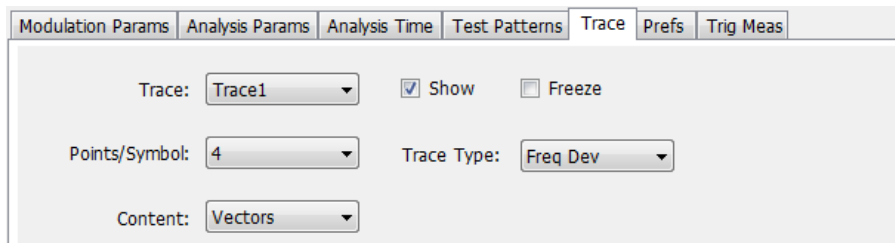

Setting	Description
Trace (P25 Constellation and P25 Eye Diagram displays only)	Select the trace to display. P25 Constellation display only: Select the trace that is hidden or displayed based on whether or not Show is selected.
Show (P25 Constellation and P25 Eye Diagram displays only)	Specifies whether the trace selected by Trace is displayed or hidden.
Freeze (P25 Constellation display only)	Halts updates to the trace selected by the Trace setting. Present for the Constellation display only.
Points/Symbol	Select how many points to use between symbols when connecting the dots. Values: 1, 2, 4, 8.
Content (P25 Constellation and P25 Freq Dev & Time displays only)	Select whether to display the trace as vectors (points connected by lines), points (symbols only without lines), or lines (lines drawn between symbols, but no symbols are displayed). The choices available depend on the display.
Trace Type (P25 Constellation and P25 Eye Diagram displays only)	Select to specify whether the plots in the Constellation and Eye Diagram displays are shown as I vs Q or as Frequency Deviation.

Scale Tab - P25

The Scale tab allows you to change the scale settings that control how the trace appears on the display but does not change control settings such as Measurement Frequency. There are three versions of the Scale tab for P25 displays.

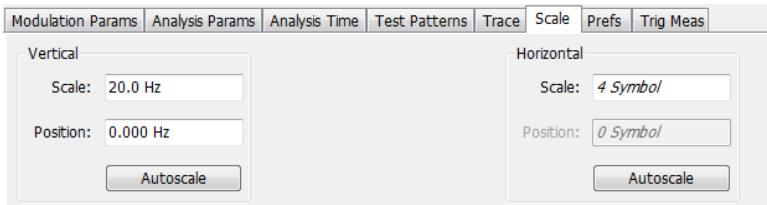

Scale tab for the P25 Eye Diagram display

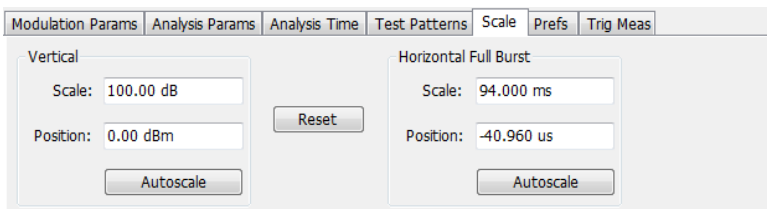

Scale tab for the P25 Power vs Time display

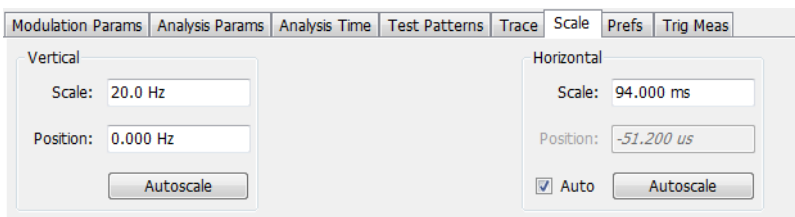

Scale tab for the P25 Freq Dev vs Time display

Settings	Description
Vertical	Controls the vertical position and scale of the trace display.
Scale	Changes the vertical scale of the graph.
Position	Adjusts the reference level away from top of the graph.
Autoscale	Resets the scale of the vertical axis to contain the complete trace.
Horizontal	Controls the span of the trace display and position of the trace.
Horizontal Full Burst	
Scale	Allows you to, in effect, change the span.
Position	Allows you to pan a zoomed trace without changing the Measurement Frequency.
Autoscale	Resets the scale of the horizontal axis to contain the complete trace.
Auto	When Auto is checked, the scale and position values for the Symbols graph are automatically adjusted to maintain the optimal display.
Reset	Resets the vertical and horizontal settings.

NOTE. The Units used for the horizontal scale can be either Seconds or Symbols. To set the units for the horizontal scale, display the Analysis Time tab. On the tab, select the appropriate units from the Units drop-down list.

Trig MeasTab - P25

The Trig Meas tab enables you to chose a trigger measurement. The available measurements in the drop-down menu depend on the standard and modulation type selected in the Modulation Params tab. The Trig Meas tab is not available for Phase 2 HDQPSK (Outbound) signals. You can read more about P25 trigger related measurements [here \(see page 315\)](#).

The following image shows the tab for Phase 1 (C4FM) signals.

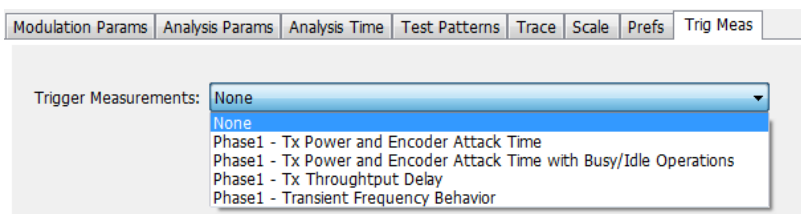

The following image shows the tab for Phase 1 (HCPM Inbound) signals.

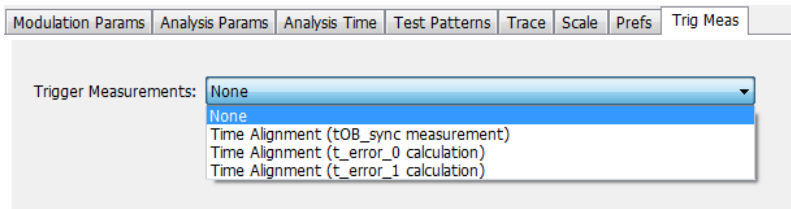

Settings	Description
Trigger Measurements	Select the trigger measurement test.

Prefs Tab - P25

The Prefs tab enables you to change appearance characteristics of the P25 Analysis displays. Not all settings on the Prefs tab shown below appear for every P25 display. The Summary display does not have a Prefs tab.

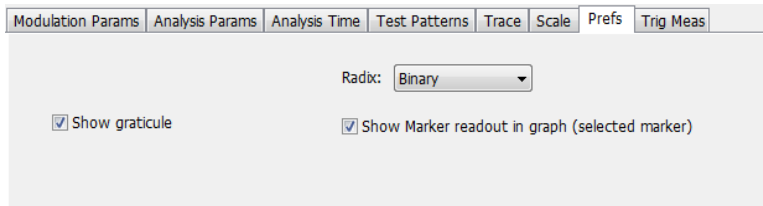

Setting	Description
Show graticule	Shows or hides the graticule.
Show Marker readout in graph (selected marker)	Shows or hides the readout for the selected marker in the graph area.
Radix	Specifies how symbols are displayed in the Symbol Table display and in the Marker readout in the display. There are three choices for Radix: Binary (00,01,10,11), Quaternary (0,1,2,3), and Modulation Symbols (+1,+3,-1,-3).

Limits Tab - P25

The Limits tab is only available for the P25 Summary display. It enables you to load an existing limits table, save a limits table, or edit limits values.

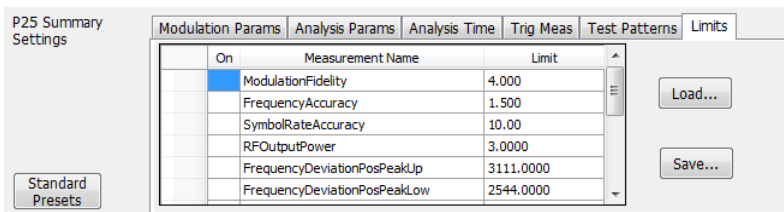

Setting	Description
Load	Click to load a saved Limits table from a .csv file.
Save	Click to save the current Limits table to a .csv file.

Edit Limits

To directly edit measurement limits in the table, click on the value in the Limit column that you want to change.

The following table describes the parameters that are set in the Limits Table.

Limits Table Settings

Setting	Description
On	Click on the cell in the On column next to the measurement to specify whether or not measurements are selected for limit comparison to indicate Pass or Fail.. A check mark means the measurement will be taken. An empty box means it will not be taken.
Measurement Name	Specifies the name of the measurement related to the limit. (Not editable.)
Limit	Specifies the value of the limit to the related measurement. When the cell is selected, the value is shown along with the units.

LTE Analysis

Overview

The Long Term Evolution (LTE) Downlink RF Measurements Analysis option allows you to evaluate RF signals to ensure that they meet 3GPP measurements. These are described in the TS 36.104 Base Station (BS) radio transmission and reception and test specifications TS36.141 Base Station (BS) conformance testing documents version 12.5. This analysis option supports both LTE TDD and LTE FDD frame structures. This analysis option supports the following measurements.

- Channel Power
- Occupied Bandwidth
- Adjacent Channel Leakage Ratio (ACLR)
- Spectral Emission Mask (Operating Band Unwanted Emission)
- Cell ID
- For TDD LTE Transmitter Off Power
- Reference Signal Power

These measurements are also compared with the limits provided by the standard to give pass/fail results (except for Channel Power and OBW).

More detailed information about these measurements is available in the [LTE measurements](#) section and the supported measurements [table](#).

You can also select these measurements from four LTE preset test setups. The test setups load pre-configured displays and control setting as suggested by the standard to accelerate the test setup of the analyzer. The following four test setups are available for this analysis option.

- Cell ID
- ACLR
- Channel Power and TDD Toff Power
- SEM

More detailed information about these test setups is available [here](#).

With the LTE downlink RF Measurement Analysis test suite, test engineers can simplify the execution of a number of transmitter tests while still enabled to modify signal parameters for in-depth signal analysis. The analysis results give multiple views of LTE signal characteristics to allow the diagnosis of signal imperfections and impairments quickly and easily. Display controls allow you to selectively display the analysis results to help locate trouble spots in the signal.

LTE topics in this Help

The following information about the LTE Analysis option is available:

- [Reference table of supported LTE measurements](#)
- [LTE measurements](#)
- [LTE Standards preset test setups](#)
- [LTE displays](#)
- [LTE measurement control settings](#)

Supported LTE measurements

The following table gives a brief description of the available LTE measurements. More detailed information can be found here. [LTE measurements](#)

LTE measurement	LTE standard(s)	Description
Cell ID detection	TDD FDD	The Cell ID is detected from the input LTE signal.
Adjacent Channel Leakage Ratio (ACLR)	TDD FDD	The Adjacent Channel integrated power is calculated and shown. The relative power compared to the reference signal is also computed. The computed power is compared against limits suggested by the selected standard and pass/fail is reported. The appropriate settings for this measurement are loaded with the ACLR test setup (Presets>Standards>LTE).
Channel Power	TDD FDD	The channel power is calculated in the channel bandwidth.
Occupied Bandwidth	TDD FDD	The Occupied bandwidth is calculated as bandwidth containing 99% of the total integrated power in the selected span around the selected center frequency.
Operating Band Unwanted Emission	TDD FDD	The power in the offset regions is calculated and presented and compared against limits set in the offset and limits table and pass/fail is reported. The appropriate settings for this measurement are loaded with the SEM test setup (Presets>Standards>LTE).
Toff	TDD	The power in off-slot region is computed and compared against selected limits.
Reference Signal Power	TDD FDD	Measures the power of cell specific reference signals.

LTE Standards preset test setups

Presets > Standards

The LTE Standards preset allows you to access displays preconfigured for the test setup you select. The test setups load the displays and control setting options suggested by the LTE standard to perform the measurements. You can read more about how Presets work [here](#).

There are four test setups for LTE:

■ Cell ID

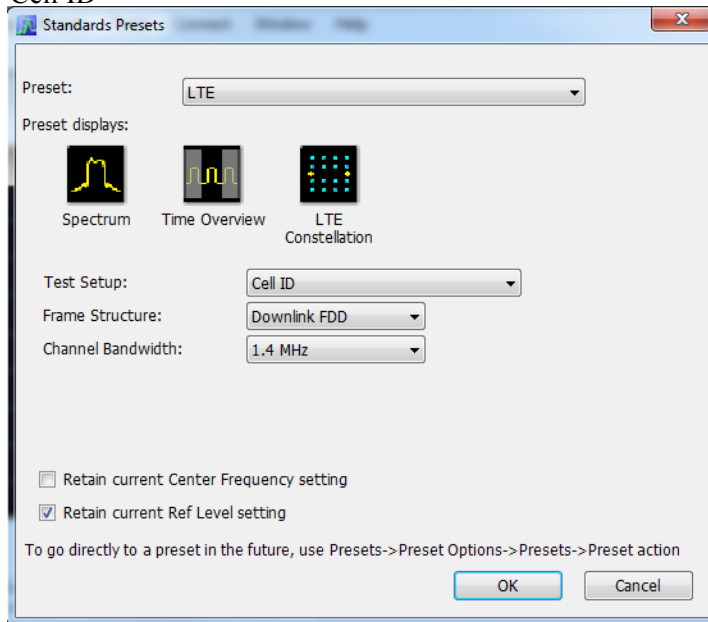

■ ACLR

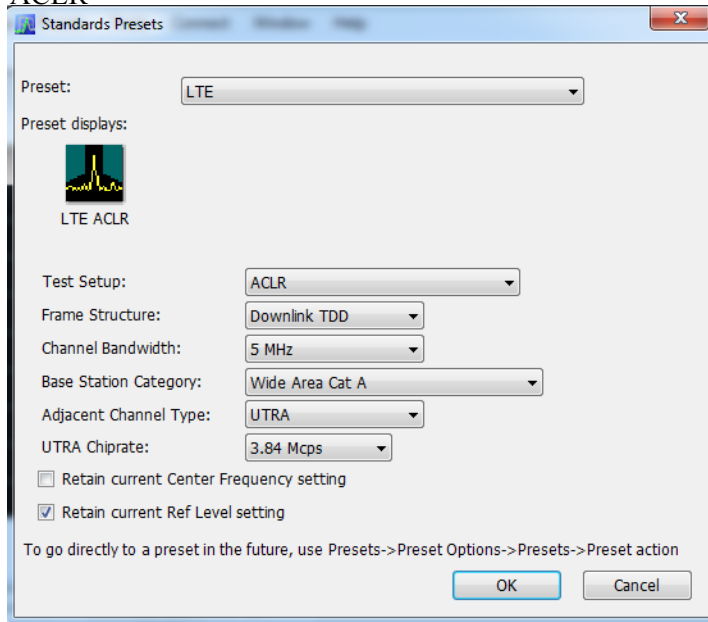

■ Channel Power and TDD Toff Power

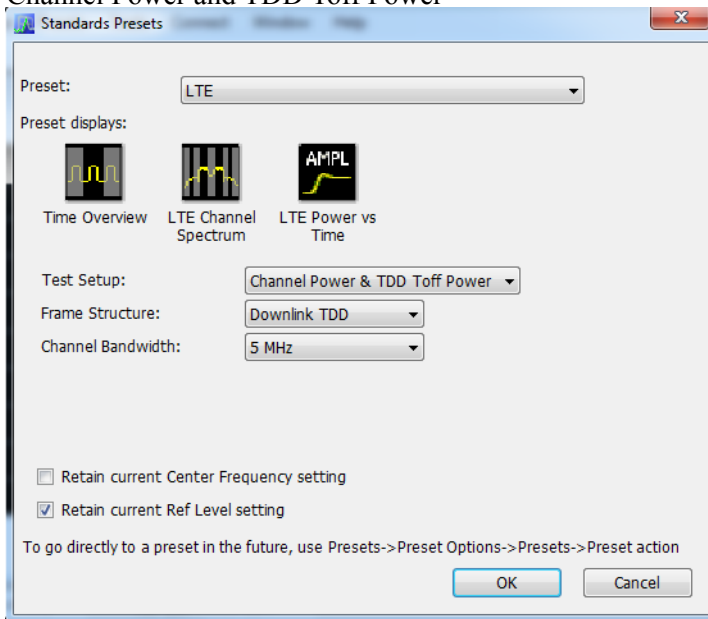

■ SEM

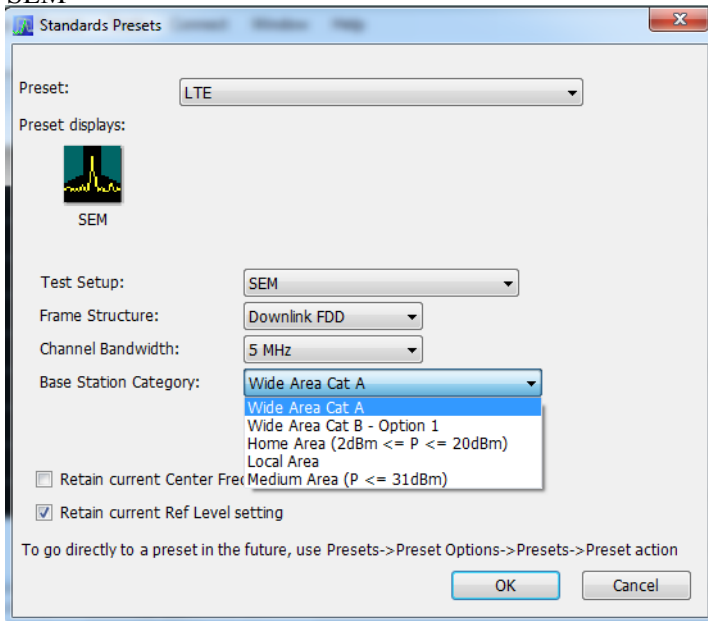

The following table shows what automatically loads with each test setup.

Table 5: LTE preset test setups

Test setup		Displays loaded with preset
Cell ID	Frame structure: - Downlink FDD - Downlink TDD (Default is Downlink FDD.) <hr/> Channel bandwidth: 1.4, 3, 5, 10, 15, 20 MHz (Default is 1.4 MHz.)	Spectrum, Time Overview, LTE Constellation
ACLR	Frame structure: - Downlink FDD - Downlink TDD (Default is Downlink FDD.) <hr/> Channel bandwidth: 1.4, 3, 5, 10, 15, 20 MHz (Default is 1.4 MHz.) <hr/> Base station category: - Wide Area Cat A - Wide Area Cat B — Option 1 - Home Area (P-rated ≤ 20 dBm) - Local Area (P-rated ≤ 24 dBm) - Medium Area (P-rated ≤ 38 dBm) (Default is Wide Area Cat A.) <hr/> Adjacent channel type: - UTRA - E-UTRA (Default is UTRA.) <hr/> UTRA chip rate. 1.28 Mcps 3.84 Mcps 7.68 Mcps Chip rate is only displayed under the following conditions: TDD is frame structure Adjacent channel type selected is UTRA Channel bandwidth is >3 MHz (Default chip rate is 3.84 Mpcs.)	LTE ACLR
Channel Power and TDD Toff Power	Frame structure: - Downlink FDD - Downlink TDD (Default is Downlink FDD.) <hr/> Channel bandwidth: 1.4, 3, 5, 10, 15, 20 MHz (Default is 1.4 MHz.)	Time Overview (TDD only), LTE Channel Spectrum, LTE Power vs Time (TDD only)

Table 5: LTE preset test setups (cont.)

Test setup	Displays loaded with preset
<p>SEM</p> <p>Frame structure: - Downlink FDD - Downlink TDD (Default is Downlink FDD.)</p> <hr/> <p>Channel bandwidth: 1.4, 3, 5, 10, 15, 20 MHz (Default is 1.4 MHz.)</p> <hr/> <p>Base station category: - Wide Area Cat A - Wide Area Cat B — Option 1 - Home Area (2 dBm ≤ P ≤ 20 dBm) - Local Area - Medium Area (P ≤ 31 dBm) (Default is Wide Area Cat A.)</p>	<p>SEM</p>

Retain current center frequency and reference level settings

The **Retain current Center Frequency setting** appears when the LTE Standards Preset is chosen. This setting allows you to retain the previously used center frequency. By default, the Center Frequency setting box is unchecked and the LTE preset displays will load with 1.96 GHz for FDD and 1.9 GHz for TDD.

The **Retain current Ref Level setting** appears when the LTE Standards Preset is chosen. This setting allows you to retain the previously used reference level. By default, the Ref Level setting box is checked.

To activate these settings, check the box next to the desired setting. The following image shows the **Retain current Ref Level setting** box checked.

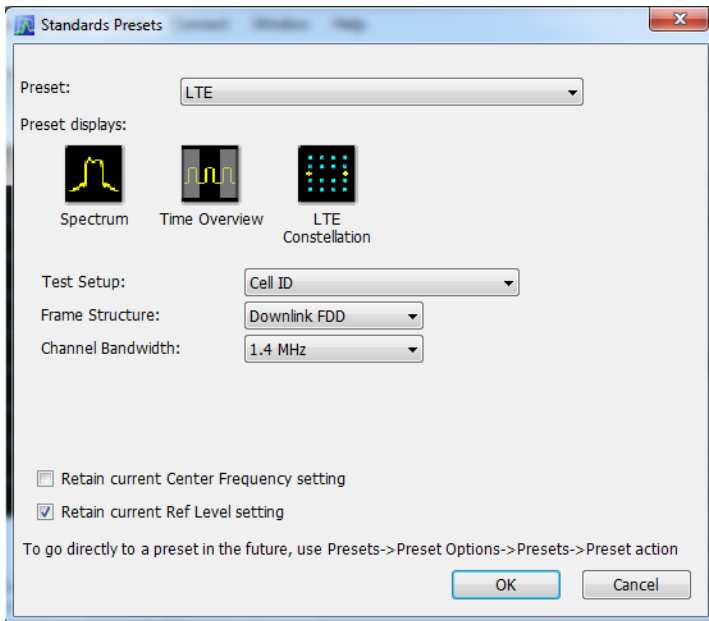

LTE displays

The displays in LTE Analysis (Setup > Displays > Measurements: LTE Analysis) are:

- [LTE Channel Spectrum](#)
- [LTE ACLR](#)
- [LTE Constellation](#)
- [LTE Power vs Time](#)
- [SEM](#) (This display is not an LTE specific display, but is available when RF Measurements is selected from the Select Displays dialog (Setup > Displays) (see the following image).)

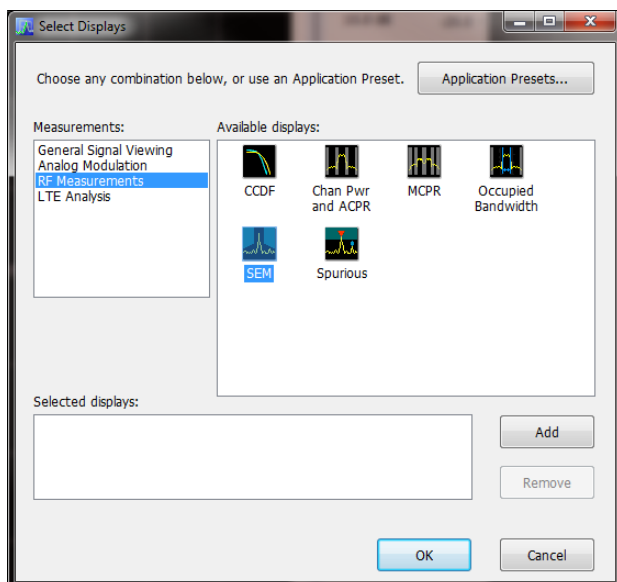

LTE measurements

LTE Analysis enables RF measurements and detection of Cell ID in the transmitted signal for both TDD and FDD frame structure LTE signals. For TDD signals, the analysis will also do the T_{OFF} measurement. The following topics contain important information you should know about specific LTE measurements. You can view a table with all of the available measurements [here](#).

Channel Power and Occupied Bandwidth (TDD and FDD)

The Channel Power measurement is done by calculating the power in the LTE signal based on the selected channel bandwidth option. The Occupied Bandwidth measurement calculates the frequency range over which 99% of the power is contained in the acquired signal. This measurement is done for the selected channel bandwidth option.

More information about this measurement:

- Select the Channel Power and TDD Toff Power test setup from Presets > Standards > LTE to perform the measurement. This will load the displays found in the [LTE preset test setups table](#).
- This test setup allows you to choose the frame structure and the channel bandwidth.
- The Channel Spectrum display will contain the results of Channel Power and Occupied Bandwidth. The result gives the power in the LTE signal (calculated over the channel bandwidth).
- Results are presented as scalar and are located below the display.
- For TDD signals, the channel power and the occupied bandwidth measurement are done on the on-slot region. If the valid on-slot region is not found, the measurement is done in the selected analysis length.

ACLR (FDD and TDD)

The Adjacent Channel specification and limits for comparison are set based on selected frame structure, adjacent channel and base station types from Standards Presets. It calculates the integrated power in the different adjacent regions and also indicates pass/fail based on comparison with absolute and relative limits in LTE ACLR display.

More information about this measurement:

- Select the ACLR test setup from Presets > Standards > LTE to perform the measurement. This will load the displays found in the [LTE preset test setups table](#).
- This test setup allows you to select the frame structure, channel bandwidth, base station type, and adjacent channel type with the following restrictions:
 - Frame Structure can be TDD or FDD
 - Channel Bandwidth can be 1.4, 3, 5, 10, 15, or 20 MHz
 - Base station type can be Wide Area Cat A, Wide Area Cat B- Option 1, Home Area (P-rated ≤ 20 dBm), Local Area (P-rated ≤ 24 dBm), Medium Area (P-rated ≤ 38 dBm)
 - Adjacent Channel type can E-UTRA or UTRA
 - UTRA chip rate can be 1.28, 3.84, or 7.68 Mcps

Default rate is 3.84 Mcps for all UTRA adjacent channels of FDD and when channel bandwidth is 1.4 or 3 MHz.

However, you can choose other rates when the frame structure is TDD and when the bandwidth is more than 3 MHz. Otherwise, the standard recommends use of 3.84 Mcps.

- Based on the settings you select from Standards Preset, the offset and bandwidth of the adjacent channels are set in the Offset and Limits tab of the control panel. The settings are different for paired and unpaired spectrum.
- The settings also include the absolute power limit for comparison based on the base station type. The standard recommends the settings in dBm/MHz for each base station type. The power limits are appropriately scaled with the integration bandwidth and presented in dBm in the Offset and Limits table of the display. The integrated power in each adjacent band is compared with the absolute and relative limits as recommended by the standard. The absolute limits are dependent on this choice of

base station type because they apply to different power levels (as the P-rated levels in the drop down menu indicate). The relative limit is also set.

- The results are presented in both tabular and display format. In the tabular display, the reference channel power and the offset, bandwidth, integrated power, and relative power of the adjacent channels are presented. An expanded view format is also available.
- The integrated power in the display is shaded blue in each adjacent channel region.
- Each adjacent channel is clearly shown. Interadjacent channel gaps are shown in gray.
- The limit lines are shown in different colors. Based on the Mask option chosen in the Offset & Limits table, failures in the different bands are shown in red on violation. By default for LTE Standards Presets, the Mask option is Abs & Rel, so the failure is shown only when the calculated power violates both relative and absolute power limits.
- The respective rows that violate both absolute and relative limits are also shown in red. Pass/fail information appears in the top left corner of the display.
- This measurement can be performed in Real Time or Non-Real Time mode. In Real Time mode, a single acquisition required for the entire span needed for this measurement is taken and the measurement is done. In the Non-Real Time mode, a separate acquisition for each adjacent channel region is taken and analyzed.

Non-real time mode is also useful when the bandwidth offered by the instrument does not support the span requirement for this measurement. The span requirement comes from the choice of adjacent channel type and channel bandwidth. In such cases, Non-Real Time mode can be used.

- For UTRA adjacent channels, filtering of the adjacent channels with an RRC filter of the same bandwidth is employed, as suggested by the standard. The chip rate is set to 3.84 Mcps for FDD and when the channel bandwidth is 1.4 or 3 MHz. For TDD, when the channel bandwidth is more than 3 MHz, you can choose the UTRA chip rate from the ACLR test setup (Presets > Standards > LTE). The options are 1.28, 3.84, and 7.68 Mcps.
- The standard recommends this measurement be done on the transmitter ON period when the signal being analyzed is TDD. An on slot detection module in the analysis helps you to do the measurement in the transmitter ON period.
 - If you are doing the measurement in Real Time, you can also load the Time Overview display, which will indicate to you the region in which the measurement is done (a purple line at the bottom). You can see the measurement is done only on the valid transmitter ON period. However, when a bursty data is not available, the measurement is done on the available analysis length.

NOTE. Real-Time mode can be set from the [Parameters tab](#) of the Settings control panel of the LTE ACLR display. Disabling Real-Time mode is the non-Real-Time setting.

- When the measurement is done in non-Real Time mode, separate acquisitions are obtained for each adjacent channel band. In such cases, it cannot be ensured that all the adjacent channel acquisitions are done on the transmitter ON period. It is recommended that you use either Real time mode or an external trigger from the source (when used with non-Real-Time mode) to do the measurement. An external trigger from the source can ensure that all the acquisitions are done just

after the rising edge of the burst. A status message in the display indicates when to use Real-Time mode or external trigger for TDD signals. The status message that is displayed in the LTE ACLR display is "Signal must be triggered or measurement in Real-Time". This message is displayed when TDD is chosen from Standard Presets, when Real-Time is not enabled from the Parameters tab of the control panel, and when the instrument is in Free Run mode.

Operating Band Unwanted Emission (FDD and TDD)

This measurement finds the power in the offset regions recommended by the standard. The offset channel specification and limits for comparison are set based on the selected channel bandwidth, frame structure, and base station types in Standards Preset. It calculates the integrated power in the different offset regions and also indicates pass/fail information based on comparison with absolute and relative limits in the SEM display.

More information about this measurement:

- Select the SEM test setup from Presets > Standards > LTE to perform the measurement. This will load the displays found in the [LTE preset test setups table](#).
- This test setup allows you to select the frame structure, channel bandwidth, and base station type with the following restrictions:
 - Frame Structure can be TDD or FDD
 - Channel Bandwidth can be 1.4, 3, 5, 10, 15, or 20 MHz
 - Base station type can be Wide Area Cat A, Wide Area Cat B - Option 1, Home Area ($2 \text{ dBm} \leq P \leq 20 \text{ dBm}$), Local Area, Medium Area ($P \leq 31 \text{ dBm}$)
- Based on the settings chosen by the user from Standards Presets the offset and bandwidth of the offset channels are set in the Offset and Limits tab of the control panel of SEM display.
- The settings also include the absolute power limit for comparison based on the base station type. The standard recommends the settings in dBm/MHz for each base station type. The power limits are appropriately scaled with the integration bandwidth and presented in dBm in the Offset and Limits table of the display. The integrated power in each adjacent band is compared with the absolute and relative limits as suggested by the standard. The absolute limits are dependent on this choice of base station type as they apply to different power levels (as the P-rated levels in the drop down menu indicate). The relative limit is also set.
- The results are presented both in tabular and display form.
- The Pass/ Fail information is also shown in the top left corner of the display.
- For TDD signals, a detection module in the analysis helps you to do the measurement in the transmitter ON period.
 - If you are doing the measurement in Real Time, you can also load the Time Overview display, which will indicate to you the region in which the measurement is done (a purple line at the bottom). You can see the measurement is done only on the valid transmitter ON period. However, when a bursty data is not available, the measurement is done on the available analysis length.

NOTE. *Real-Time mode can be set from the [Parameters tab](#) of the Settings control panel of the SEM display. Disabling Real-Time mode is the non-Real-Time setting.*

- When the measurement is done in non-Real Time mode, separate acquisitions are obtained for each adjacent channel band. In such cases, it cannot be ensured that all the adjacent channel acquisitions are done on the transmitter ON period. It is recommended that you use either Real-Time mode or an external trigger from the source (when used with non-Real Time mode) to do the measurement. An external trigger from the source can ensure that all the acquisitions are done just after the rising edge of the burst. A status message in the display indicates when to use Real Time mode or external trigger for TDD signals. The status message that is displayed in the LTE SEM display is "Signal must be triggered or measurement in Real-Time". This message is displayed when TDD is chosen from Standard Presets, when Real-Time is not enabled from the Parameters tab of the control panel, and when the instrument is in Free Run mode.

- Settings for all tables provided in the base station conformance testing document (3GPP TS 36.141 v12.5 – for Release 12) has been incorporated from Standards Presets.
 - Wide Area and Local area settings from standard presets are provided as per the standard document.
 - Home Area base station settings loaded from standard presets correspond to Reference power levels between 2 to 20 dBm.
 - Medium Area base station settings loaded from standard presets correspond to reference power levels less than 31 dBm.
- The following settings are provided in a *.csv file that you can load. These files will be available in the installed directory (Example Files\LTE).
 - Wide Area category B Option 2 (for specific bands specified by the standard). There are three csv files based on operating band and channel bandwidth for Wide Area.
 - LTE_SEM_1.4MHz_CatB_optn2_bands_3_8.csv
 - LTE_SEM_3MHz_CatB_optn2_bands_3_8.csv
 - LTE_SEM_5to20MHz_CatB_optn2_bands_1_3_8_32_33_34.csv
 - Home Area base station for power level less than 2 dBm. There are six csv files based on operating band and channel bandwidth for Home Area.
 - LTE_SEM_1_4MHz_above3GHz_Home2P.csv
 - LTE_SEM_1_4MHz_below3GHz_Home2P.csv
 - LTE_SEM_3MHz_above3GHz_Home2P.csv
 - LTE_SEM_3MHz_below3GHz_Home2P.csv
 - LTE_SEM_5to20MHz_above3GHz_Home2P.csv
 - LTE_SEM_5to20MHz_below3GHz_Home2P.csv
 - Medium Area base station for reference power level between 31 to 38 dBm. There are six csv files based on operating band and channel bandwidth for Medium Area.
 - LTE_SEM_1_4MHz_above3GHz_Medium31P38P.csv
 - LTE_SEM_1_4MHz_below3GHz_Medium31P38.csv
 - LTE_SEM_3MHz_above3GHz_Medium31P38.csv
 - LTE_SEM_3MHz_below3GHz_Medium31P38.csv
 - LTE_SEM_5to20MHz_above3GHz_Medium31P38.csv
 - LTE_SEM_5to20MHz_below3GHz_Medium31P38.csv
 - Additional requirements given in Section 6.6.3.5.3 in 3GPP TS 36.141 v12.5 standard document. There are 14 csv files based on the requirements in the standard document. The files are named based on the table numbers of Section 6.6.3.5.3 of the standard document (3GPP TS 36.141 V12.5.0 (2014-09)).

Cell ID (TDD and FDD)

The dominant Cell ID in the transmitted LTE signal is detected and presented in the Constellation display. Along with the Cell ID scalar results, the group and sector ID are also presented. The constellation of the Primary and Second Synchronization signals are presented too.

More information about this measurement:

- Select the Cell ID test setup from Presets > Standards > LTE to perform the measurement. This will load the displays found in the [LTE preset test setups table](#).
- This test setup allows you to select the frame structure and channel bandwidth with the following restrictions:
 - Frame Structure can be TDD or FDD
 - Channel Bandwidth can be 1.4, 3, 5, 10, 15, or 20 MHz
- Analysis of the LTE signals is done based on the settings you choose in the Standards Presets.
- The constellation for PSS and SSS (Primary and Secondary Synchronization Signals) are shown. You can optionally select to view only the PSS or SSS constellation (selection is made in the Trace tab).
- Equalization based on PSS (Primary Synchronization Signal) data can be enabled using the "Enable Equalization" option (available in the Analysis Params tab of the Settings Control panel.) This Equalization is based on PSS data and applied on other parts of the OFDM symbol.

Reference Signal Power (TDD and FDD)

Reference Signal Power measures the power of cell specific reference signals. Reference signals are spread across time and frequency. Reference signal position is dependent on the Cell ID, bandwidth, and antenna ports. For Downlink TDD (frame structure type 2), the position of reference signals is also dependent on uplink-downlink and special subframe configurations.

Toff (TDD)

The Toff measurement is done only for the TDD signal. It is a measure of the off slot power in a LTE TDD signal.

More information about this measurement:

- Select the Channel Power and TDD Toff Power test setup from Presets > Standards > LTE to perform the measurement. This will load the displays found in the [LTE preset test setups table](#).
- This test setup allows you to select the frame structure and channel bandwidth with the following restrictions:
 - Frame Structure can be TDD or FDD
 - Channel Bandwidth can be 1.4, 3, 5, 10, 15, or 20 MHz
- Analysis of the LTE signals is done based on the settings you choose in the Standards Presets.

- By default, the Toff measurement is the average of several non-overlapping and adjoining 70 μ s windows in the off slot region. This measurement is done only on the 70 μ s window in the center of the off slot region, when the **Average over entire offslot region** option is disabled.
- The scalar result is presented in dBm/MHz.
- The result is compared against limits that can be defined using the Limits tab of the control panel. By default, these limits are set based on the Base Station conformance testing document (3GPP TS 36.141 v12.5 – for Release 12). Pass/fail is shown in the top left corner of the LTE Power vs Time display.

LTE Status Messages

The following status messages may appear. Each message indicates the related condition (Description) shown in the following table.

Status message	Description
LTE Analysis: Signal must be triggered or measured in Real Time	Shown in the display and status bar when the user attempts to make the ACLR measurement and SEM measurement for TDD signals in non-Real-Time mode and when the instrument is in free run. Since the standard recommends the ACLR measurement to be done in transmitter ON periods only, either the measurement has to be done in Real-Time mode (in which a detection module ensures the measurement is done on the transmitter ON period) or has to be externally triggered if in non-Real-Time mode.
LTE Analysis: Recovery done on PSS/SSS on the center 62 carriers	Shown in the status bar to indicate that the constellation of PSS and SSS shown in the LTE constellation is done based on analysis of PSS and SSS signals in the center 62 carriers of the corresponding OFDM symbols. Therefore, you may see the correct constellation and Cell ID even when a different channel bandwidth is chosen from the control panel because the analysis for PSS and SSS is done only on the center carriers.
LTE Analysis: Analysis Failure - Synchronization Sequence not found	Shown in the status bar to indicate that a valid Cell ID (from PSS and SSS) is not detected.

LTE ACLR display

The LTE Adjacent Channel Leakage Ratio (ACLR) display shows the ratio of the mean power centered on the assigned channel frequency to the mean power centered on an adjacent channel frequency. In the 3GPP specification, both the main channel and adjacent channels are required to be filtered with RRC (Root Raised Cosine) filters.

To show the LTE ACLR display you can select **Presets > Standards > LTE**.

NOTE. Loading the LTE ACLR display from the **Presets > Standards > LTE** menu is recommended. This loads the control settings based on the selected options.

You can also load the LTE ACLR display as follows:

1. Recall an appropriate acquisition data file.
2. Press the **Displays** button or select **Setup > Displays**.
3. In the **Select Displays** window, select **LTE Analysis** in the **Measurements** box.
4. In the Available displays box, double-click the **LTE ACLR** icon or select the icon and click **Add**. The LTE ACLR icon will appear in the **Selected displays** box and will no longer appear under Available displays.
5. Click the **OK** button to show the display.
6. Select **Setup > Settings** to display the control panel.
7. Select **Replay/Run** to take measurements on the acquired data.

Elements of the Display

The following image shows the LTE ACLR display.

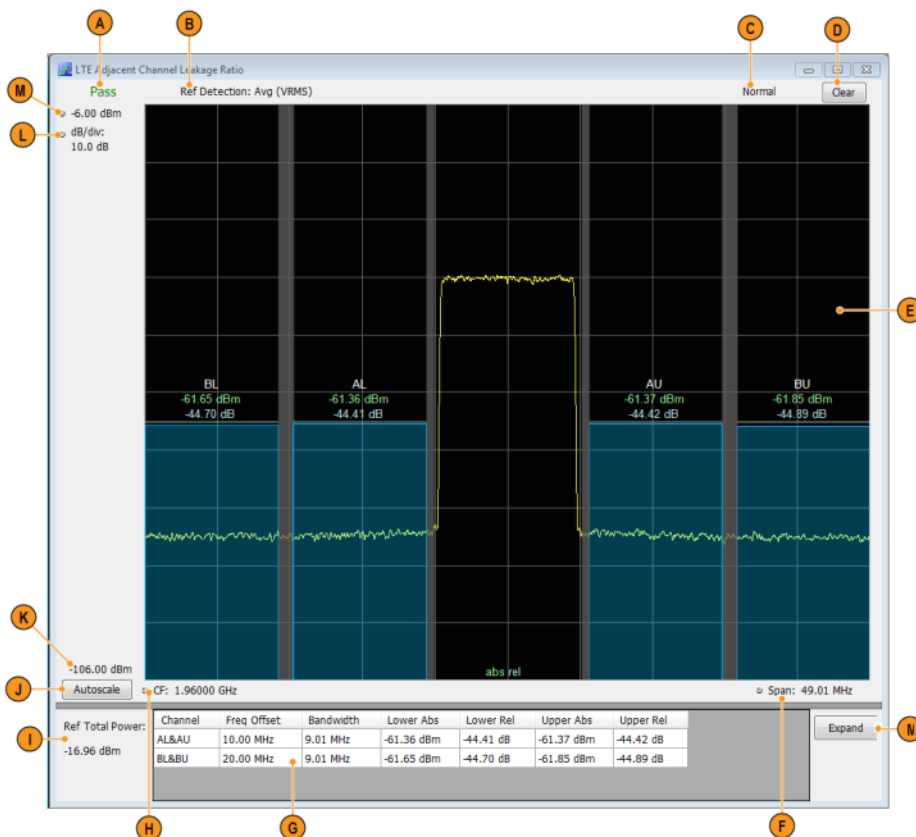

Item	Display element	Description
A	Pass/Fail	Indicates Pass or Fail based on Absolute and Relative limits set by the user. The failure condition is set by Mask in the Offset and Limits Table tab of the Settings control panel. By default, the mask is set to Abs & Rel, meaning failure is reported only when both absolute and relative results fail against the respective limits.
B	Ref Detection	Set to Avg (VRMS) or +Peak based on the choice made in Processing tab of the Settings control panel.
C	Normal	Indicates how the result is presented over multiple sweeps. This selection is made in the Processing tab of the control panel. Displays Average Count if Avg (VRMS) is checked in the Processing tab in the Settings control panel.
D	Clear	Resets measurement. Clears all values.
E	Plot	Shows the reference channel and adjacent channels and the regions in between them. The Absolute and Relative limit lines are also shown. The integrated power is shown as a band. Scalar results are also shown.
F	Span	Adjust the span of the graph in symbols.
G	Results Table	Tabulates the results in each adjacent band. Table shows the offset, bandwidth, Integrated Absolute and Relative power in the upper and lower adjacent channel regions.
H	CF	Center Frequency at which the measurement is performed.
I	Ref Total Power	Gives the power in the Reference channel.
J	Autoscale	Adjusts the vertical and horizontal settings so that the entire trace fits in the graph.
K	Bottom readout	Displays the value indicated by the bottom of graph.
L	dB / div	Shows the dB per each division in the Y axis of the plot.
(not shown)	Units	Sets the global Amplitude units for all the views in the analysis window. This will change the amplitude selection in the Units tab of the Amplitude control panel.
M	Top of graph	The vertical scale is normalized with appropriate power units.
N	Expand button	Shows the results table in its own window with larger font size.

Clicking on the **Expand** button allows you to view the results table in a separate window, as shown in the following image.

Channel	Freq Offset	Bandwidth	Lower Abs	Lower Rel	Upper Abs	Upper Rel
AL&AU	7.50 MHz	3.84 MHz	-61.53 dBm	-46.95 dB	-61.11 dBm	-46.53 dB
BL&BU	12.50 MHz	3.84 MHz	-61.53 dBm	-46.95 dB	-61.32 dBm	-46.73 dB

LTE ACLR Settings

Main menu bar: Setup > Settings

Favorites toolbar: 

The LTE ACLR Settings control panel provides access to settings that control parameters of the LTE ACLR display.

Settings tab	Description
Channels (see page 376)	Allows you to control how the measurement is performed. When in Real Time, the RBW and VBW settings apply for all channels (including offset regions) and the other parameters apply only for the reference channel. When Non-Real Time mode is selected, all information in this tab, including RBW and VBW, only applies to the reference channel.
Parameters (see page 378)	Specifies several characteristics that control how the measurement is made. These parameters are used by the instrument to analyze the input signal.
Processing (see page 380)	Specifies settings for detection on the reference channel and the offsets. Specifies the function setting on how calculations are done across multiple sweeps.
Offsets & Limits Table (see page 381)	Allows you to select the characteristics of offsets and mask limits.
Scale (see page 382)	Specifies the vertical and horizontal scale settings.
Prefs (see page 384)	Allows you to select to show or hide the graticule, power level, limits, and marker readouts.

LTE Channel Spectrum display

The LTE Channel Spectrum display shows the spectrum of the input signal across one channel. Channel power measures the average power within the selected bandwidth and is expressed in dBm. Other units can be selected from the Units tab of the Analysis control panel. The measured occupied bandwidth is calculated as the bandwidth containing 99% of the total integrated power within the selected span around the selected center frequency.

To show the LTE Channel Spectrum display:

1. Recall an appropriate acquisition data file.
2. Press the **Displays** button or select **Setup > Displays**.
3. From the **Measurements** box, select **LTE Analysis**.
4. Double-click the **LTE Channel Spectrum** icon in the **Available Displays** box. This moves the LTE Channel Spectrum icon to the **Selected displays** box.
5. Click **OK** button to view the display.

6. Select **Setup > Settings** to display the control panel.
7. Select **Replay/Run** to take measurements on the acquired data.

Elements of the Display

The following image shows the LTE Channel Spectrum display.

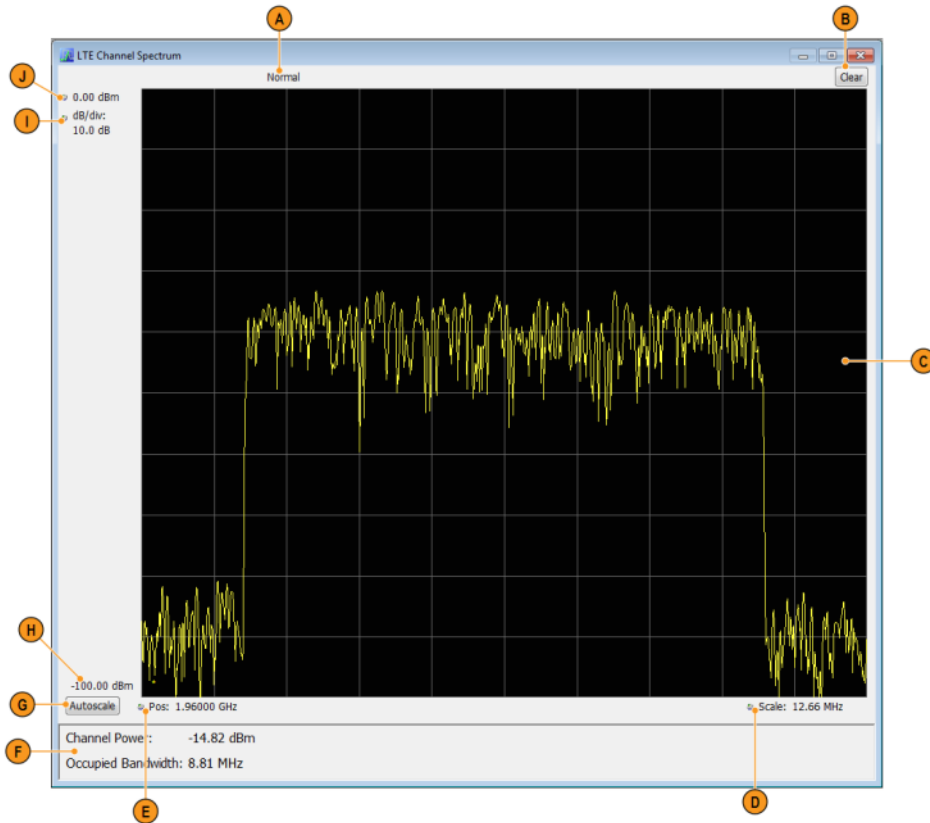

Item	Display element	Description
A	Normal	Displays Average Count if Average is turned on (set to Time Domain or Frequency Domain) from the Measurement Params tab in the Settings control panel.
B	Clear	Resets measurement. Clears all values.
C	Plot	Specifies the value shown at the center of the graph display.
D	Scale	Adjust the span of the graph.
E	Position	Displays the horizontal position of the trace on the graph display.
F	Scalar results	Shows the Channel Power and Occupied Bandwidth measurement results.
G	Autoscale	Adjusts the vertical and horizontal settings so that the entire trace fits in the graph.
H	Bottom readout	Displays the value indicated by the bottom of graph.
I	dB / div	Shows the dB per each division in the Y axis of the plot.
(not shown)	Units	Sets the global Amplitude units for all the views in the analysis window. This will change the amplitude selection in the Units tab of the Amplitude control panel.
J	Top of graph	The vertical scale is normalized with appropriate power units.

LTE Channel Spectrum Settings

Main menu bar: Setup > Settings

Favorites toolbar: 

The settings for the LTE Channel Spectrum display are shown in the following table.

Settings tab	Description
Freq & RBW (see page 387)	Allows you to specify the frequency and resolution bandwidth used for the measurement.
Measurement Params (see page 388)	Allows you to set averaging (Time Domain, Off, or Frequency Domain) and to set the number value associated with the Average setting.
Channels (see page 376)	Allows you to set the Channel BW for the Channel Power measurement.
Scale (see page 382)	Allows you to specify the horizontal and vertical scale settings.
Prefs (see page 384)	Allows you to select to show or hide certain display elements.

LTE Constellation display

The LTE Constellation display shows the constellation of Primary (PSS) and Secondary (SSS) Synchronization Signals. Scalar results include Cell ID, Group ID, Sector ID, and frequency error.

1. Recall an appropriate acquisition data file.
2. Press the **Displays** button or select **Setup > Displays**.

3. In the **Select Displays** dialog, select **LTE Analysis** in the **Measurements** box.
4. In the Available displays box, double-click the **LTE Constellation** icon or select the icon and click **Add**. The LTE Constellation icon will be added to the **Selected displays** box and will no longer appear under Available displays.
5. Click **OK** to show the display.
6. Select **Replay/Run** to take measurements on the acquired data.

Elements of the Display

The following image shows the LTE Constellation display.

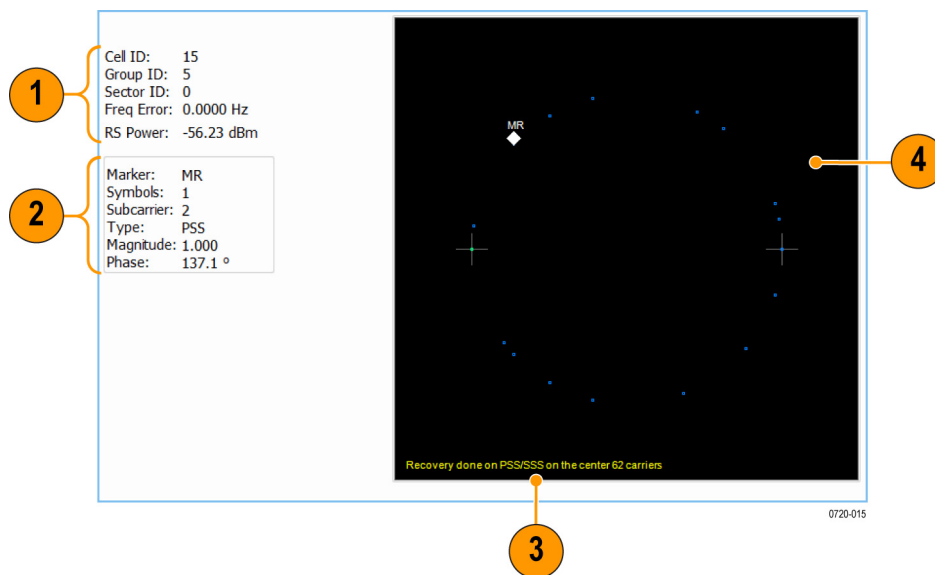

Item	Display element	Description
1	Scalar results	Gives results of Cell ID, Group and Sector ID information along with Frequency error.
2	Marker readout	Shows marker type, magnitude, phase and subcarrier number.
3	Status message	Shows relevant status messages. (You can read about status messages here .)
4	Plot	Displays PSS and SSS (Primary and Second Synchronization Signal) constellation.

LTE Constellation Settings

Main menu bar: Setup > Settings

Favorites toolbar:

The settings for the LTE Constellation display are shown in the following table.

Settings tab	Description
Modulation Params (see page 389)	Specifies the frame structure and channel bandwidth.
Analysis Params (see page 390)	Allows you to enable Equalization based on PSS (Primary Synchronization Signal).
Analysis Time (see page 390)	Specifies parameters that define the portion of the acquisition record that is used for analysis. Also allows you to specify the Units (Symbols or Seconds) and Time Zero Reference (Trigger or Acquisition Start) for LTE Analysis displays.
Trace (see page 392)	Allows you to set the display characteristics of the traces.
Scale (see page 382)	Specifies the vertical and horizontal scale settings.

LTE Power vs Time display

The LTE Power vs Time display shows the filtered power of the data and marks where the T_{OFF} measurement is done. The T_{OFF} scalar results are also shown.

You can select **Presets > Standards > LTE** to view the display.

NOTE. Loading the LTE Power vs Time display from the **Presets > Standards > LTE** menu is recommended. This loads the control settings based on the selected options.

You can also load the LTE Power vs Time display as follows:

1. Recall an appropriate acquisition data file.
2. Press the **Displays** button or select **Setup > Displays**.
3. In the **Select Displays** dialog, select **LTE Analysis** in the **Measurements** box.
4. In the Available displays box, double-click the **LTE Power vs Time** icon or select the icon and click **Add**. The LTE Power vs Time icon will be added to the **Selected displays** box and will no longer appear under Available displays.
5. Click **OK** to show the display.
6. Select **Replay/Run** to take measurements on the acquired data.

Elements of the Display

The following image shows the LTE Power vs Time display.

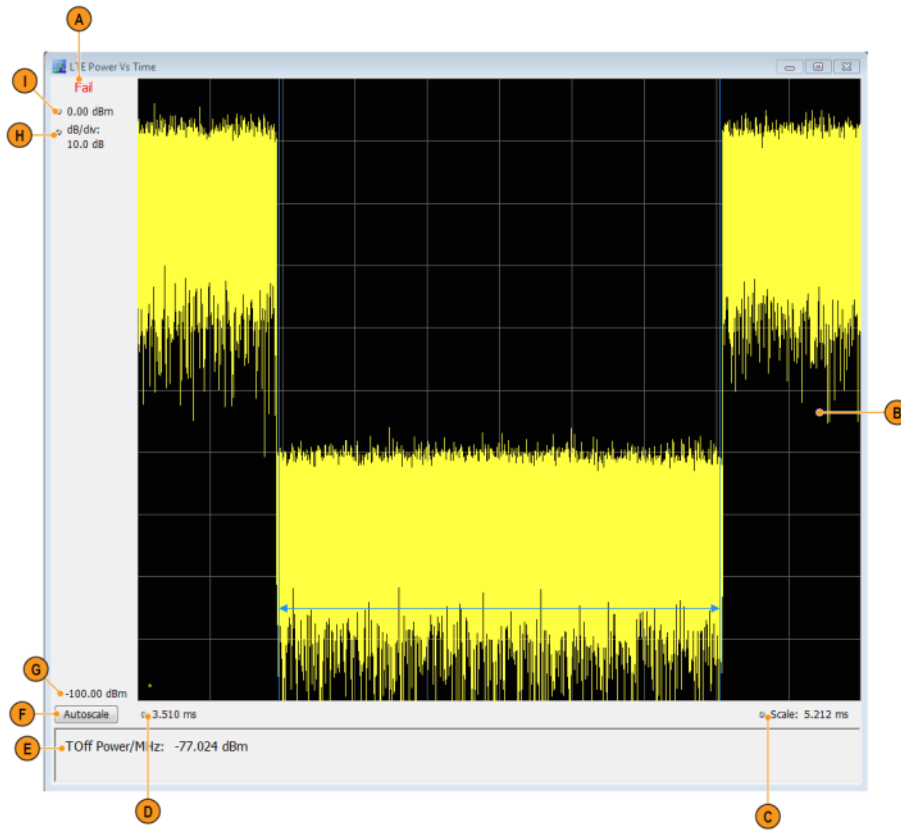

Item	Display element	Description
A	Pass / Fail	Shows Pass or Fail based on whether the T_{OFF} measurement (off slot power) is below the recommended limit set in the Limit tab of the Settings control panel or not. The Pass/Fail information is displayed only when the chosen frame structure is TDD and if a valid off slot is found.
B	Plot	Displays the filtered signal in case of TDD and the region in which the off slot power is measured is graphically shown. When the frame structure is chosen as FDD, the power in the input signal is displayed.
C	Scale	Adjust the span of the graph in symbols.
D	Analysis Start	Gives the start of analysis region.
E	Toff	The T_{OFF} (off slot power) is measured and displayed here when a valid off slot is found for a TDD signal.
F	Autoscale	Adjusts the vertical and horizontal settings so that the entire trace fits in the graph.
G	Bottom readout	Displays the value indicated by the bottom of graph.
H	dB / div	Shows the dB per each division in the Y axis of the plot.
(not shown)	Units	Sets the global Amplitude units for all the views in the analysis window. This will change the amplitude selection in the Units tab of the Amplitude control panel.
I	Top of graph	The vertical scale is normalized with appropriate power units.

LTE Power vs Time Settings

Main menu bar: Setup > Settings

Favorites toolbar: 

The settings for the LTE Power vs Time display are shown in the following table.

Settings tab	Description
Modulation Params (see page 389)	Specifies the frame structure and channel bandwidth.
Analysis Time (see page 390)	Specifies parameters that define the portion of the acquisition record that is used for analysis. Also allows you to specify the Units (Symbols or Seconds) and Time Zero Reference (Trigger or Acquisition Start) for LTE Analysis displays.
Prefs (see page 384)	Allows you to select to show or hide the graticule and marker readouts.
Scale (see page 382)	Specifies the vertical and horizontal scale settings.
Limit (see page 392)	Specifies the mask limits.

LTE Analysis Measurement Settings

Main menu bar: Setup > Settings

Favorites toolbar:

The control panel tabs in this section are shared between the displays in LTE Analysis (Setup > Displays). Some tabs are shared by all the displays and some tabs are shared by only a subset of displays. The settings available on some tabs change depending on the selected display.

Controls for LTE Analysis displays

Settings tab	Description
Modulation Params (see page 389)	Allows you to set the frame structure and channel bandwidth. <i>Available for these displays: LTE Power vs Time, LTE Constellation.</i>
Analysis Params (see page 390)	Allows you to enable Equalization based on PSS (Primary Synchronization Signal).
Analysis Time (see page 390)	Specifies parameters that define the portion of the acquisition record that is used for analysis. Also allows you to specify the Units (Symbols or Seconds) for LTE Analysis displays. <i>Available for these displays: LTE Power vs Time, LTE Constellation.</i>
Trace (see page 392)	Specifies the trace type (Vectors, Points, and Lines), the number of points per symbol when chosen to view as Vectors or Lines, and to control the view as Freq Dev or IQ. <i>Available for the LTE Constellation display only.</i>
Prefs (see page 384)	Allows preferences with Radix display and marker readouts. <i>Available for these displays: LTE Power vs Time, LTE ACLR, LTE Channel Spectrum, SEM.</i>
Scale (see page 382)	Defines the vertical and horizontal axes. <i>Available for all LTE displays.</i>
Offsets & Limits Table (see page 381)	NOTE. <i>Available for the LTE ACLR display only.</i>
Freq & RBW (see page 387)	Specifies the frequency and resolution bandwidth used for the measurement. NOTE. <i>Available for the LTE Channel Spectrum display only.</i>
Parameters (see page 378)	Specifies several characteristics that control how the measurement is made.
Processing (see page 380)	Specifies settings for detection on the reference channel and the offsets. Specifies the function setting on how calculations are done across multiple sweeps.
Limit (see page 392)	Allows you to define limits for pass/fail comparison with calculated values. The default values are as recommended in the test specification.
Channels (see page 376)	Specifies the Channel BW for the Channel Power measurement. Allows you to set RBW, VBW, power reference, as well. <i>Available for these displays: LTE ACLR, LTE Channel Spectrum.</i>
Measurement Params (see page 388)	Allows you to set averaging (Time Domain, Off, or Frequency Domain) and to set the number value associated with the Average setting.

Channels tab - LTE

The Channels tab allows you to control how the measurement is performed.

The following image shows the Channels tab for the LTE ACLR display. When in Real Time, the RBW and VBW settings apply for all channels (including offset regions) and the other parameters such as Power Reference, Channel Width, and Integrated bandwidth apply only to the reference channel. When Non-Real Time mode is selected, all information in this tab, including RBW and VBW, only applies to the reference channel.

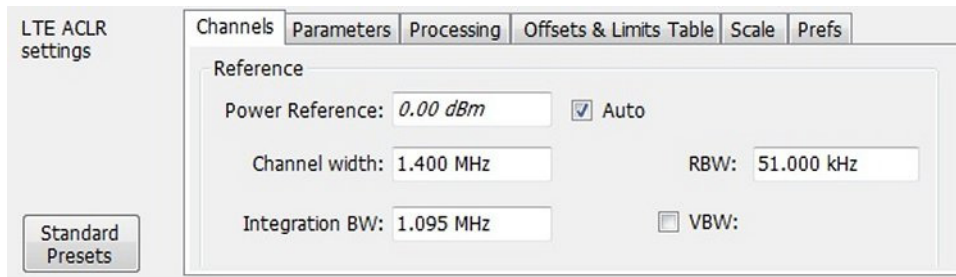

Settings	Description
Reference	
Power Reference	The value used to calculate relative measurements. When Auto is selected, the calculated reference channel power is displayed. When Auto is unchecked, you can enter a value for the reference power, and the measured reference power is not used or displayed.
Channel Width	Specifies the width of the reference channel.
Integration BW	Specifies the integration bandwidth used to compute the total power in the reference channel.
All Channels (displayed for Real-Time mode)	
Reference Channel (displayed for Non-Real Time mode)	
RBW	Sets the RBW
VBW	Enables/disables the Video Bandwidth filter. VBW is used in traditional swept analyzers to reduce the effect of noise on the displayed signal. The VBW algorithm in the analyzer emulates the VBW filters of traditional swept analyzers. When the check box next to VBW is not checked, the VBW filter is not applied. The maximum VBW value is 10 times the current RBW setting. The minimum VBW value is 1/10,000 of the RBW setting.

The following image shows the Channels tab for the LTE Channel Spectrum display. This tab allows you to set the channel bandwidth, which in turn sets the span for LTE Channel Spectrum.

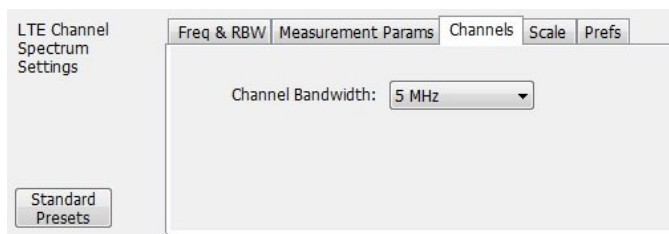

Settings	Description
Channel Bandwidth	Specifies the Channel Bandwidth, which in turn sets the span of the LTE Channel Spectrum.

Parameters tab - LTE

The Parameters tab enables you to specify several parameters that control the LTE ACLR measurements are made.

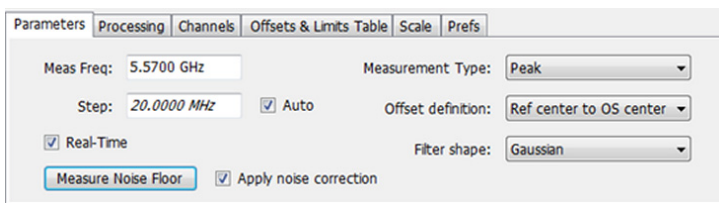
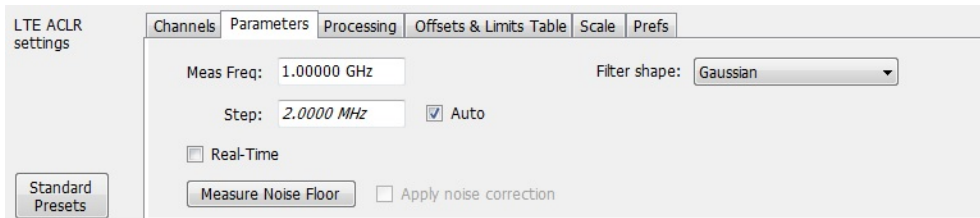

Setting	Description
Meas Freq	Specify the frequency of the signal to be measured.
Step	Sets the increment size when changing the Frequency using the knob or mouse wheel. Auto: When Auto is enabled, the step size is adjusted automatically based on the span setting.
Real-Time	When Real-Time mode is enabled, the entire LTE ACLR span is measured using a real-time/contiguous acquisition. Not all described parameters are available in Real-Time mode. When Real-Time is disabled (non-Real-Time mode), a separate acquisition for each region is taken and analyzed. Non-Real-Time mode is also useful when the bandwidth offered by the instrument does not support the span requirement for this measurement. The span requirement is guided by the choice of adjacent channel type and channel bandwidth selected in LTE Standards Presets.
Measure Noise Floor	Takes preliminary acquisitions to measure the instrument noise floor. This initiates a noise correction. A noise correction signal is created by switching off the RF input and performing acquisitions of the instrument's internal noise. Fifty acquisitions are averaged to create the noise reference signal. The noise reference signal is measured for the Reference channel and each Offset is defined by the measurement settings.
Apply noise correction	This item is enabled and the check box automatically checked after the noise reference signal is taken when the Measure Noise floor button is clicked. This initiates noise reference subtraction from the incoming signal power for each region to create the corrected result. All calculations are performed in Watts and then converted to the desired units. The amount of noise correction is limited to 20 dB to avoid the possibility of a negative power measurement. This is a rare condition that could occur if the subtraction of the reference power from the channel power results in a negative value (or "infinite" dBm). The noise reference for a region is subtracted from each trace point in the channel, rather than offsetting the entire region by a single amount. This produces a smooth trace with no discontinuities at the region edges. NOTE. <i>If any relevant settings (such as reference level, frequency, span, RBW) are changed once the noise reference is measured, the following warning message will be displayed to notify you that Noise Correction was not applied: Noise correction not applied - select Measure Noise Floor for new noise correction.</i>
Filter shape	Specifies the shape of the filter determined by the window that is applied to the data record, in the spectrum analysis, to reduce spectral leakage. 3GPP specifies a Gaussian window shape be applied to the reference channel measurements. Gaussian: This filter shape provides optimal localization in the frequency domain. Rectangular: This filter shape provides the best frequency, worst magnitude resolution. This is essentially the same as no window.

Processing tab - LTE

The Processing tab controls the detection settings for the Reference Channel and Offsets, as well as selecting the function for the LTE ACLR display.

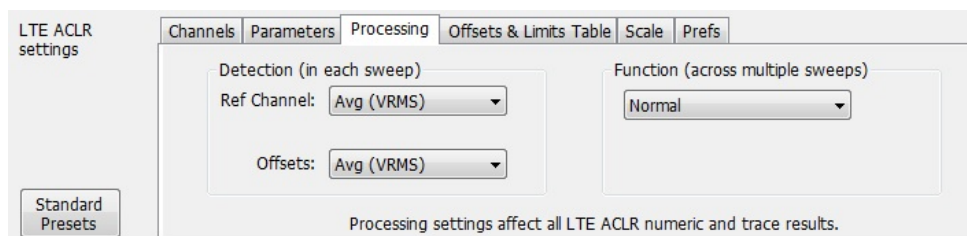

Setting	Description
Detection (in each sweep)	
Reference Channel	Specifies the Detection method used for the Reference Channel. Detection is used to produce the desired measurement result (peak or average) and to reduce the results of a measurement to the desired number of trace points.
Avg (VRMS)	For each sweep, each point of the trace is the result of determining the RMS voltage value for the last 'n counts' of the collected traces for the same point. When 'n count' has not been reached, partial averaging results are displayed.
+Peak	Selects the +Peak detection method. With this method, the highest value is selected from the results to be compressed into a trace point.
Offsets	
Avg (VRMS)	Selects the Average Vrms detection method. With this method, each point on the trace in each offset is the result of determining the RMS Voltage value for all of the results values it includes.
+Peak	Selects the +Peak detection method. With this method, the highest value is selected from the results to be compressed into a trace point.
Function (across multiple sweeps)	
Normal	When a new trace has been computed, it replaces the previous trace.
Max Hold	With each sweep, each trace point in the new trace is compared to the point's value in the old trace and the greater value is retained for display and subsequent comparisons.
Avg (VRMS)	For each sweep, each point on the trace is the result of determining the RMS Voltage value for all of the collected traces' values for the same point.
Count	Enter the Avg (VRMS) value. Displayed only when Avg (VRMS) is selected.

Offsets and Limits Table tab - LTE

The Offsets and Limits Table tab is used to specify parameters that define Offsets and masks for the LTE ACLR display. The following images show the tab and expanded view of the tab, respectively.

The following image shows the Offsets and Limits Table tab when Real-Time is selected in the Parameters tab.

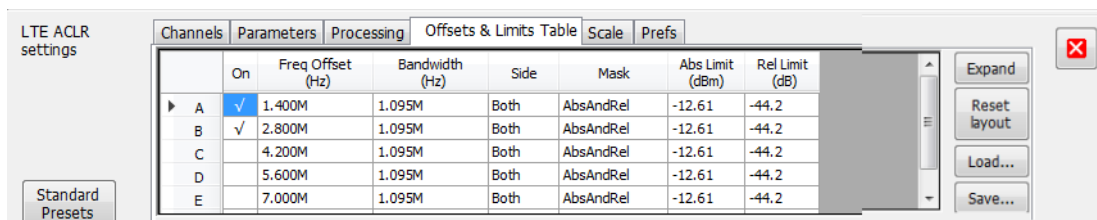

The following image shows the Offsets and Limits Table tab when Real-Time is not selected in the Parameters tab (referred to as non-Real-Time mode).



The following image shows the expanded view of the Offsets and Limits Table (click the **Expand** button to view).

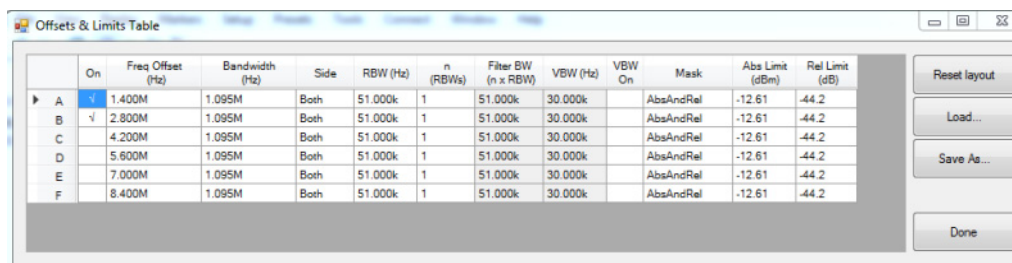

Setting	Description
Buttons	
Expand (button)	Displays the Offsets and Limits Table in a new, resizable window.
Reset Layout	Allows you to reorder columns in the Offsets & Limits Table by dragging the columns to a new position. Clicking Reset Layout returns the column order to the factory default order.
Load	Click to load a saved Offsets & Limits table from a file.
Save As	Click to save the current Offsets & Limits table to a file.
Done	When the table is expanded, click Done when you have finished editing the table to save your changes and close the expanded table display.
Table columns	
On	Specifies whether or not measurements are taken in the specified offset.
Freq Offset (Hz)	Specifies the frequency offset for the offset region (adjacent channel region) from the Center frequency of the Reference Channel. This offset is always specified from the center frequency of the Reference Channel to the center frequency of the Offset region.
Start (Hz)	Start Frequency of the selected offset.
Stop (Hz)	Stop Frequency of the selected offset.
Bandwidth (Hz)	Specifies the bandwidth of the Offset region.
Side	Specifies whether the specified range appears on both side of the carrier frequency or just one side (left or right).
RBW (Hz)	Specifies the RBW for the selected range.
n(RBWS)	An integer value that specifies how many times to multiply the RBW to set the Filter bandwidth.
Filter BW (n x RBW)	Displays the Filter BW. Filter BW is the equivalent BW of each point in the offset. When n > 1, an integration technique is used to achieve the Filter BW using narrower RBWs.
VBW (Hz)	Adjusts the VBW (Video Bandwidth) value. VBW Maximum: RBW current value; VBW Minimum: 1/10,000 RBW setting.
VBW (On)	Specifies whether the VBW filter is applied.
Mask	Select the type of limits used for Pass/Fail testing. Signal excursions that exceed the mask settings are considered violations. The available choices are Abs, Rel and Abs & Rel.
Abs Limit (dBm)	The offset region integrated power is compared against the Abs Limit value mentioned here.
Rel Limit (dB)	The offset region integrated power relative to the reference channel integrated power is compared with this limit.

Scale tab - LTE

The Scale tab allows you to change the scale settings that control how the trace appears on the display but does not change control settings. In effect, these controls operate like pan and zoom controls. The Scale tab values are unique to each display. Also, note that each display uses horizontal and vertical units that are appropriate for that display. There are three versions of the Scale tab for LTE displays.

The following image shows the Scale tab for the LTE Power vs Time display.

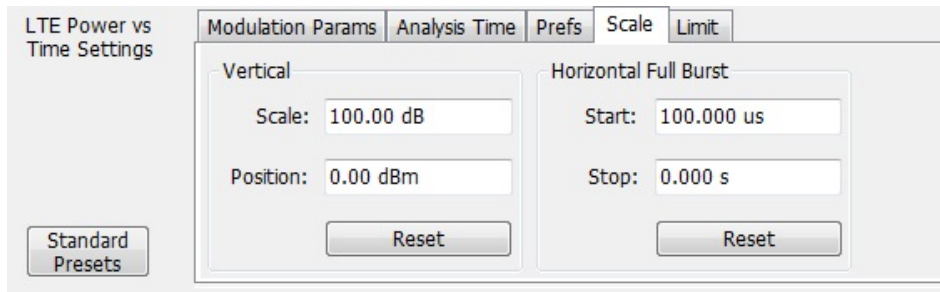

Settings	Description
Vertical	Controls the vertical position and scale of the trace display.
Scale	Changes the vertical scale units.
Position	Adjusts the reference level away from top of the graph.
Reset	Resets the scale of the vertical axis to default values.
Horizontal Full Burst	Controls the horizontal span.
Start	Specifies the horizontal axis start point.
Stop	Specifies the horizontal axis end point.
Reset	Resets the scale of the horizontal axis to default values.

The following image shows the Scale tab for the LTE Channel Spectrum and LTE ACLR displays.

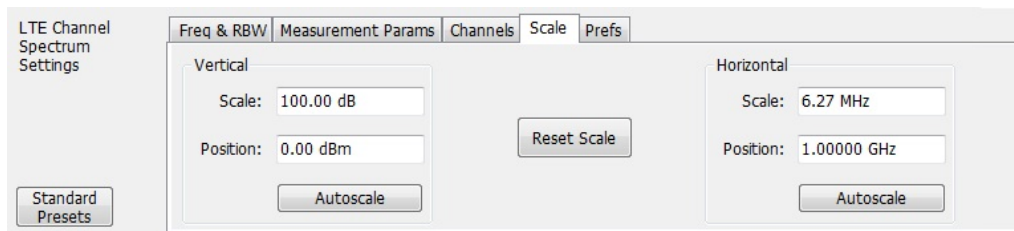

Settings	Description
Vertical	Controls the vertical position and scale of the trace display.
Scale	Changes the vertical scale units.
Position	Adjusts the reference level away from top of the graph.
Autoscale	Resets the scale of the vertical axis to contain the complete trace.
Horizontal	Controls the horizontal span of the trace display and position of the trace.
Scale	Specifies the frequency range displayed in the graph
Position	Specifies the frequency shown at the center of the graph.
Autoscale	Resets the scale of the horizontal axis to optimize the display of the trace.
Reset Scale	Resets all settings to their default values.

The following image shows the Scale tab for the LTE Constellation display.

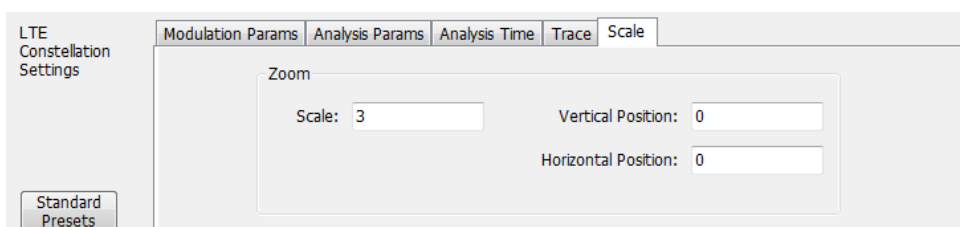

Settings	Description
Zoom	
Scale	Zooms in and out of the constellation. As the scale is increased, it will zoom out.
Vertical Position	Adjusts the vertical position.
Horizontal Position	Adjusts the horizontal position.

Prefs tab - LTE

The Prefs tab enables you to change parameters of the measurement display. The parameters available on the Prefs tab vary depending on the selected display, but include such items as enabling/disabling Marker Readout and switching the graticule display on/off. Some parameters appear with most displays, while others appear with only one display.

The following image shows the Prefs tab for the LTE ACLR display.

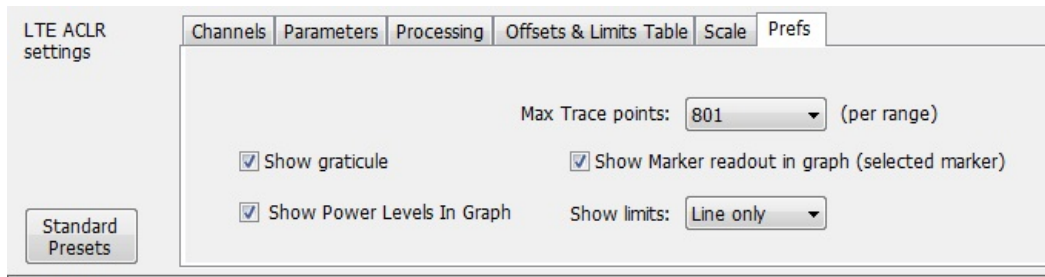

The following image shows the Prefs tab for the LTE Channel Spectrum display.

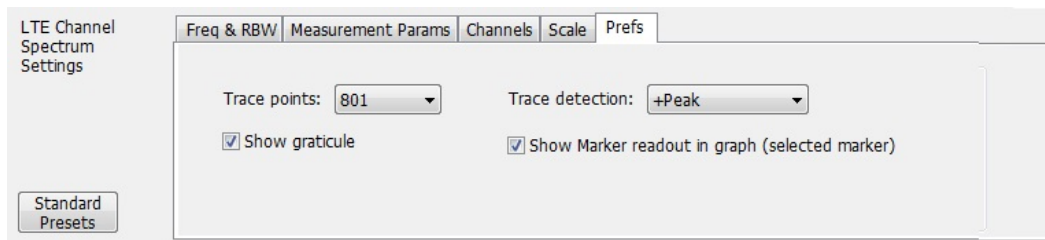

The following image shows the Prefs tab for the LTE Power vs Time display.

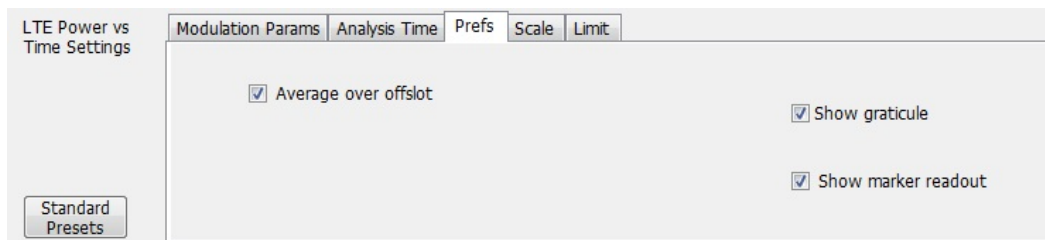

Setting	Description
Show graticule	Shows or hides the graticule.
Trace / Max Trace points	When the spectrum analysis produces more than the selected maximum number of points, the method specified in Detection control is used to decimate the result. This setting applies to both the reference channel and offsets.
Show Marker readout in graph (selected marker)	Shows or hides the readout for the selected marker in the graph area.
Show Power Levels In Graph	This display the power level (calculated integrated power in the offset region) in the graph.
Show limits	
Shaded	Shows limits using a shaded area. Absolute limit and Relative limit shading colors can be set under Presets > Options.
Line only	Shows limits using only a line. Absolute limit and Relative limit line colors can be set under Presets > Options.
None	No lines or shading are used to indicate limits in the graph. Violations of the mask are still identified by red shading.
Average Over Offslot	Enables for averaging of offslot power in non-overlapping 70 μ s windows in the entire offslot region. If this option is disabled, the off slot power is measured only in the center 70 μ s window of the offslot region.

Freq and RBW tab - LTE

The Freq and RBW tab specifies frequency parameters for the Channel Power and ACPR measurements and the MCPDR measurement. It is available for the LTE Channel Spectrum display.

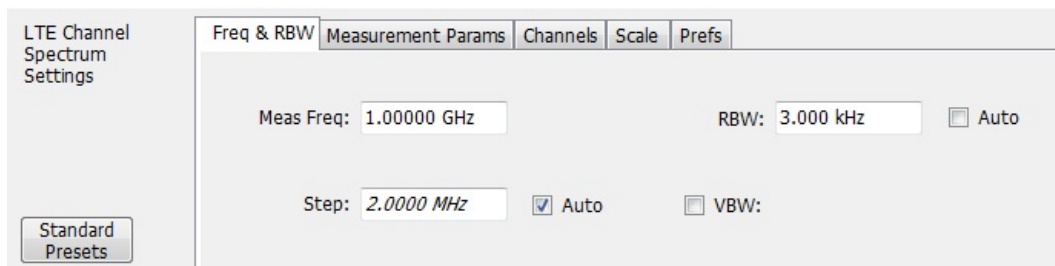

Settings	Description
Meas Freq	Specifies the center/measurement frequency
RBW	Select Auto or Manual. Adjusts the RBW for the entire measurement. This setting is Independent of the Spectrum view's RBW setting. Auto: When Auto is enabled, the step size is adjusted automatically based on the span setting.
Step	The Step control sets the increment/decrement size for the adjustment of the center frequency. If Auto is enabled, the analyzer will adjust the Step size as required. Auto: When Auto is enabled, the step size is adjusted automatically based on the span setting.
VBW	Adjusts the Video Bandwidth value. The maximum VBW value is 10 times the current RBW setting. The minimum VBW value is 1/10,000 of the RBW setting.

Measurement Params tab - LTE

The Measurement Params tab allows you to set parameters that control the ACPR and MCPR measurements. This is available for the LTE Channel Spectrum display.

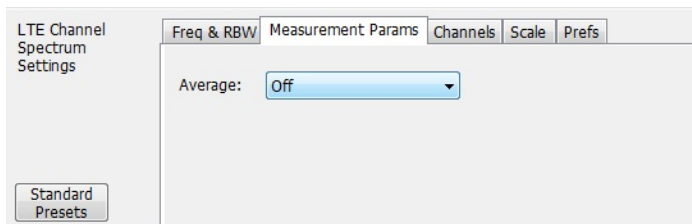

Settings	Description
Average	
Off	
Frequency-domain	This setting takes the average linear value of the traces (so that RMS values are preserved). The number of averages is user-defined. Frequency domain averaging is available in spans larger (or smaller) than the maximum real time bandwidth. This is the mode to use unless you need to extract maximum dynamic range from an ACPR measurement.
Time-domain	This setting takes the average linear value of the traces. It is useful if you need to extract maximum dynamic range from an ACPR measurement. The number of traces is user defined, however, the signals must be triggered and repeating (meaning the signal needs to be exactly the same for each acquisition). When this condition is met, each waveform contains the same signal, but the random noise changes from acquisition to acquisition and the average value of the random noise is lowered, while the signal value remains constant. Time domain averaging is not available in spans wider than the maximum real-time bandwidth.

Modulation Params tab - LTE

The Modulation Params tab specifies the type of modulation used by the input signal and other parameters that define the signal format. This tab is available for the LTE Constellation and Power vs Time displays.

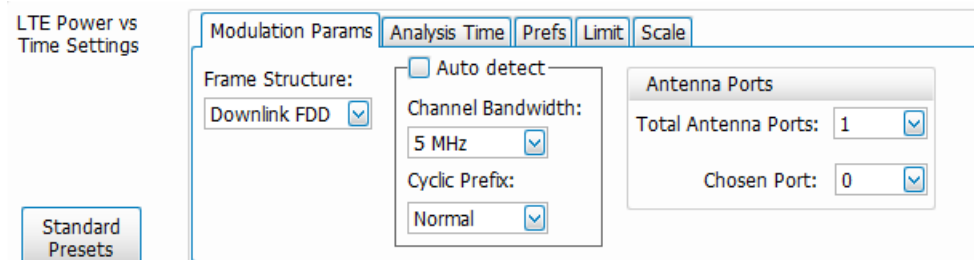

Settings	Description
Frame Structure	Select the frame structure to set how the demodulation is done.
Downlink FDD	Downlink Frequency Division Duplexing
Downlink TDD	Downlink Time Division Duplexing
Auto Detect	If checked, Channel Bandwidth and Cyclic Prefix are automatically detected. It will also detect the TDD Configuration when Downlink TDD is the selected frame structure.
Channel Bandwidth	Select from 6 bandwidths: 1.4, 3, 5, 10, 15, 20 MHz (If Auto Detect is checked, the channel bandwidth is automatically calculated.)
Cyclic Prefix	Select Normal or Extended.
TDD Configuration	
Uplink-Downlink	Select from 0 to 6. The configuration determines the appropriate downlink to uplink switch periodicity.
Special Subframe	Select from 0 to 9. This configuration determines the number of downlink pilots, guard period, and uplink pilots between uplink to downlink switch.
Antenna Ports	
Total Antenna Ports	Select from 1 to 4. This is the total number of antenna ports.
Chosen Port	Select the antenna port from which the signal is captured.

Analysis Params tab - LTE

The Analysis Params tab allows you to enable equalization on the demodulated LTE packet. The equalization is based on PSS (Primary Synchronization Signal). This tab is only available for the LTE Constellation display.

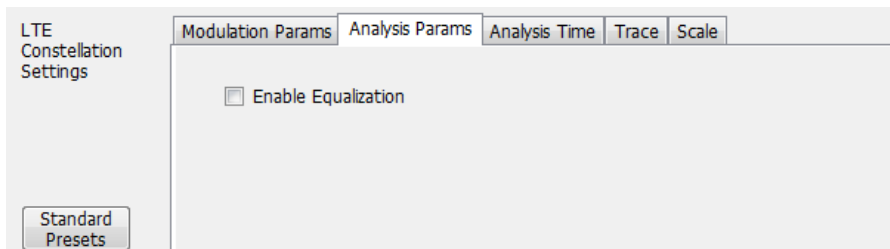

Settings	Description
Enable Equalization	Allows you to enable Equalization based on PSS (Primary Synchronization Signal).

Analysis Time tab - LTE

The Analysis Time tab contains parameters that define how the signal is analyzed in the LTE Analysis displays. This tab is available for the LTE Constellation and Power vs Time displays.

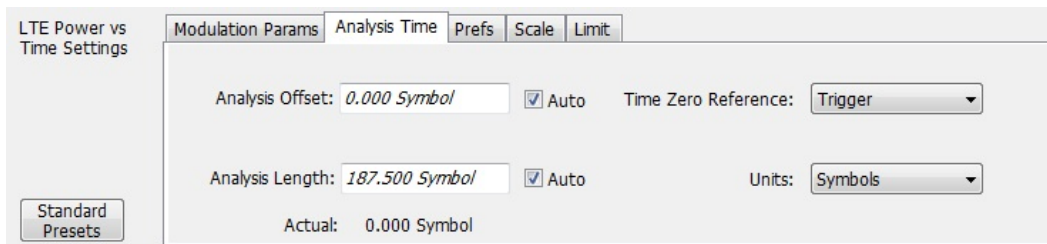

Settings	Description
Analysis Offset	Specifies the location of the first time sample to use in measurements.
Auto	When enabled, causes the instrument to set the Analysis Offset value based on the requirements of the selected display.
Analysis Length	Specifies the length of the analysis period to use in measurements. Length is specified in either symbols or seconds, depending on the Units setting.
Auto	When enabled, causes the instrument to set the Analysis Length value based on the requirements of the selected display.
Actual	This is a displayed value, not a setting. It is the Analysis Length (time or symbols) being used by the analyzer. This value may not match the Analysis Length requested (in manual mode).
Time Zero Reference	Specifies the zero point for the analysis time.
Units	Specifies the units of the Analysis Length to either Symbols or Seconds.

Analysis Offset

Use analysis offset to specify where measurements begin. Be aware that you cannot set the Analysis Offset outside the range of time covered by the current acquisition data. (All time values are relative to the Time Zero Reference.)

You can set the Analysis Length so that the requested analysis period falls partly or entirely outside the current range of acquisition data settings. When the next acquisition is taken, its Acquisition Length will be increased to cover the new Analysis Length, as long as the Sampling controls are set to Auto. If the Sampling parameters are set to manual, or if the instrument is analyzing saved data, the actual analysis length will be constrained by the available data length, but in most cases, measurements are able to be made anyway. The instrument will display a notification when measurement results are computed from less data than requested. Range: 0 to [(end of acquisition) - Analysis Length]. Resolution: 1 effective sample (or symbol).

Analysis Length

Use the analysis length to specify how long a period of time is analyzed. As you adjust this value, the actual amount of time for Analysis Length, in Symbol or Seconds units, is shown below the control in the "Available" readout. This setting is not available when Auto is checked. Range: minimum value depends on the standard. Resolution: 1 symbol.

Time Zero Reference

All time values are measured from this point (such as marker position or horizontal position (in Y vs Time displays). Choices are: Acquisition Start or Trigger.

Parameter	Description
Acquisition Start	Time zero starts from the point at which the acquisition begins.
Trigger	Time zero starts from the trigger point.

Trace tab - LTE

The Trace tab allows you to set the trace display characteristics of the LTE Constellation display.

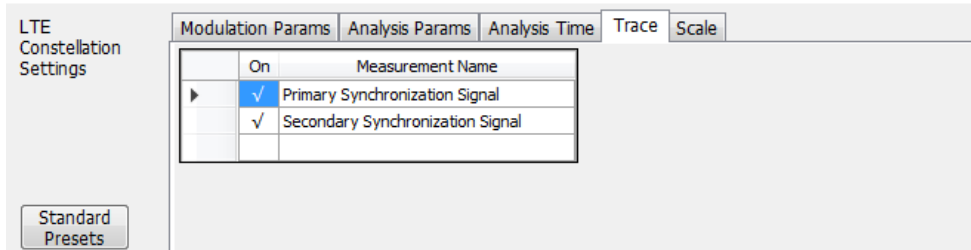

Setting	Description
>	The arrow indicates which measurement name is active so that you can check it (on) or uncheck it (off).
On	Check the box next the measurement name you want to turn on.
Measurement Name	Selections are PSS (Primary Synchronization Signal) or SSS (Secondary Synchronization Signal)

Limit tab - LTE

The Limit tab is only available for the LTE Power vs Time display. It enables you to specify the limit used for comparison against measured values of Toff measurement.

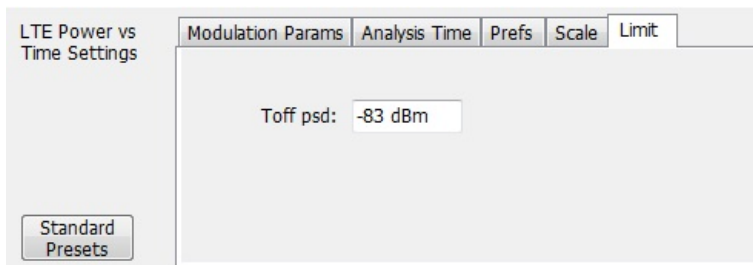

Setting	Description
Toff psd	Specifies the limit that is used for comparison against measured values of Toff measurement. Pass/ Fail is determined with this limit.

Bluetooth Analysis

Overview

There are two Bluetooth Analysis options: Bluetooth (SV27) and Bluetooth 5 (SV31). These options allow you to evaluate short range RF signals to ensure that they meet Bluetooth standard per Bluetooth Special Interests Group (SIG) Test Specifications for version 5. This analysis option enables measurements and supports detection, demodulation, and decoding of packet information for the following three standards: Basic Rate, Low Energy (LE), and Enhanced Data Rate (EDR).

- Basic Rate
- Low Energy (LE)
- Enhanced Data Rate (EDR)

You can also select from three RF test presets for the Low Energy standard and four test presets for the Basic Rate standard. This analysis option includes modulation, power, carrier drift, and spectral measurements as mentioned in the Radio Frequency test specification document by the Bluetooth SIG. These measurements are also compared with the limits provided by the standard to give pass/fail results. (There are no pass/fail results for EDR.)

With the Bluetooth Analysis test suite, test engineers can simplify the execution of a number of transmitter tests while still enabled to modify signal parameters for in-depth signal analysis. The analysis results give multiple views of Bluetooth signal characteristics to allow the diagnosis of signal imperfections and impairments quickly and easily. Display controls allow you to selectively display the analysis results to help locate trouble spots in the signal.

Bluetooth topics in this Help

The following information about Bluetooth Analysis is available:

- [Bluetooth key features \(see page 394\)](#)
- [Reference table of supported Bluetooth measurements](#)
- [Bluetooth measurements and test setups \(see page 397\)](#)
- [Bluetooth status messages \(see page 402\)](#)
- [Bluetooth Standards presets \(see page 395\)](#)
- [Bluetooth displays \(see page 397\)](#)
- [Bluetooth Settings \(see page 428\)](#)

Bluetooth key features

- Modulation/Carrier Drift/Output Power test setup in Bluetooth Standards Preset that will calculate results and compare against recommended or user defined limits or Basic Rate and Low Energy.
- In-band Emission measurement preset with capability to compare results against recommended or user defined limits for Basic Rate and Low Energy.
- 20 dB Bandwidth and Frequency Range measurement preset with capability to compare results against recommended or user defined limits for Basic Rate.
- Appropriate masks for Out-of-band Spurious measurements for ETSI and FCC specifications.
- Enhanced Data Rate (EDR) demodulation of GFSK and PSK data and relative power measurement preset.
- [Automatic detection of standards \(see page 394\)](#).
- Automatic detection of test pattern.
- Automatic determination of packet type.
- Summary display with decoded preamble, access code, packet header, payload header, and CRC packet information along with other scalar measurements.
- Symbol Table display with color coding to show different regions in the packet.
- Freq Dev vs Time display with zoomed Octet viewing to help you understand how the modulation characteristics measurement is done.
- CF Offset & Drift display with offset (calculated in preamble and 10 bit intervals in payload) and drift results in a tabular view.
- Summary display that allows you to edit pass/fail limits for comparison with actual results. (Default is recommended limits from the Bluetooth SIG Radio Frequency test specification document.)

Automatic detection of standards. This function can be enabled from the Standard Parameters control panel. This automatically detects whether the Bluetooth standard is Basic Rate, Low Energy, or Enhanced Data Rate (EDR). This function is not available as a test setup from the Standards Presets window.

Supported automated Bluetooth measurements

Bluetooth measurement	Bluetooth standard(s)
Modulation characteristics	Basic Rate
	Low Energy
Carrier frequency offset and drift	Basic Rate
	Low Energy
Output power	Basic Rate
	Low Energy
In-band emission /ACPR	Basic Rate
	Low Energy

Bluetooth measurement	Bluetooth standard(s)
Out-of-band spurious emission	Basic Rate Low Energy
20 dB bandwidth	Basic Rate
Frequency range	Basic Rate
Power density	Basic Rate
Relative power	Enhanced Data Rate (EDR)

Bluetooth Standards presets

Presets > Standards

The Bluetooth Standards preset allows you to access displays preconfigured for the Bluetooth standard and test setup you select. The test setups load the displays and control setting options suggested by the standard to perform the measurements. You can read more about how Presets work ([see page 13](#)).

There are four test setups for the Low Energy standard and eight test setups for the Basic Rate standard. There is one preset (no test setups) for the EDR standard.

The following table shows the set of Preset displays that load when the specified standards and test setups are selected.

Table 6: Bluetooth standards, test setups, and Preset displays

Standard	Test setup	Displays loaded with preset
Low Energy	Modulation/Frequency Offset/Drift/Output Power	BT Eye Diagram, BT Freq Dev vs Time, BT Summary, BT CF Offset and Drift, Spectrum, Time Overview
	In-band Emissions	BT InBand Emission, Spectrum, Time Overview
	Non-compliance	BT Freq Dev vs Time, BT Constellation, BT Summary, Spectrum, Spectrogram, Time Overview
Basic Rate	Modulation/Frequency Offset/Drift/Output Power	BT Eye Diagram, BT Freq Dev vs Time, BT Summary, BT CF Offset and Drift, Spectrum, Time Overview
	In-band Emissions	BT InBand Emission, Spectrum, Time Overview
	Tx Output Spectrum — 20dB Bandwidth	Bluetooth 20 dB BW, Spectrum, Time Overview
	Non-compliance	BT Freq Dev vs Time, BT Constellation, BT Summary, Spectrum, Spectrogram, Time Overview
Enhanced Data Rate (EDR)	Generic	BT Eye Diagram, BT Constellation, BT Summary, BT Symbol Table, Spectrum, Time Overview

Retain current center frequency and reference level settings

The **Retain current Center Frequency setting** appears when the Bluetooth Standards Preset is chosen. This setting allows you to retain the previously used center frequency.

The **Retain current Ref Level setting** appears when the Bluetooth Standards Preset is chosen. This setting allows you to retain the previously used reference level.

To activate these settings, check the box next to the desired setting.

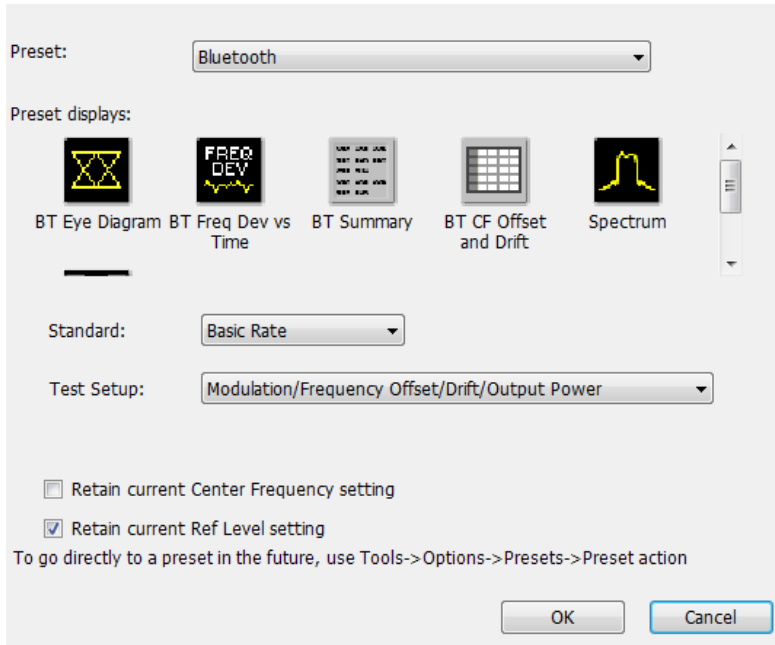

By default, the Ref Level setting box is checked.

By default, the Center Frequency setting box is unchecked and the Bluetooth preset displays will load with one of the center frequency values shown in the following table.

Table 7: Default center frequencies for Bluetooth test setups

Standard	Test setup	Center frequency
Basic Rate Low Energy	Modulation/Frequency Offset/Drift/Output Power	2.441 GHz
Basic Rate Low Energy	In-band Emissions	2.441 GHz
Basic Rate Low Energy	Out-of-band Spurious Emissions	2.441 GHz
Basic Rate	Tx Output Spectrum — 20dB Bandwidth	2.441 GHz
Basic Rate	Tx Output Spectrum — Power Density	2.441 GHz
Basic Rate Low Energy	Non-compliance	2.441 GHz
Basic Rate	Tx Output Spectrum — Frequency Range Lower	2.402 GHz

Table 7: Default center frequencies for Bluetooth test setups (cont.)

Standard	Test setup	Center frequency
Basic Rate	Tx Output Spectrum — Frequency Range Higher	2.480 GHz
Enhanced Data Rate	Generic	2.441 GHz

NOTE. *Changing analysis and display parameters recalculates the measurement results, but does not affect acquisitions.*

Bluetooth displays

The displays in Bluetooth Analysis (Setup > Displays > Measurements: Bluetooth Analysis) are:

- [Bluetooth 20dB Bandwidth](#)
- [Bluetooth Center Frequency Offset and Drift](#)
- [Bluetooth Constellation](#)
- [Bluetooth Eye Diagram](#)
- [Bluetooth Frequency Dev vs Time](#)
- [Bluetooth InBand Emission](#)
- [Bluetooth Summary](#)
- [Bluetooth Symbol Table](#)
- [Time Overview](#)

Bluetooth measurements and test setups

A variety of measurements and test setups are provided by the Bluetooth Analysis option for use in performance testing of transmitters. These test setups allow the analyzer to compare the measurement result to the standards limit. Test engineers can select from the test setups and measurements described here. The following topics contain important information you should know about specific Bluetooth measurements and test setups.

NOTE. *Although the following information describes test setups for measurements recommended by the standard document, other measurement results may also be provided as additional information for a given measurement. For example, carrier frequency offset and drift results may be provided for modulation characteristics test setups.*

Modulation characteristics (Basic Rate and Low Energy)

This measurement verifies that the modulation characteristics of the transmitted signal are correct. The Bluetooth test specification recommends this measurement be done using fixed frequency, also known as *hopping off*, and can be done in Direct Tx mode. This measurement can only be done if the payload has the bit pattern 10101010 or 11110000. This measurement and test setup are set to Free Run mode by default. However, you can set the analyzer to Triggered mode (Setup > Trigger) to do the measurements.

More information about this measurement:

- Select the Modulation/Frequency Offset/Drift/Output Power test setup from Presets > Standards to perform modulation characteristics measurements. This will load the displays found in the [Bluetooth standards, test setups, and Preset displays table](#). Additionally, you can choose to load the BT Symbol Table and BT Constellation displays, which can provide useful information.
- The Bluetooth Analysis splits the frequency deviation results in the payload region into octets (8 bit intervals). If the payload pattern is 10101010, then the maximum frequency deviation is calculated in every bit interval within an octet and recorded as Δf_{max} . The Δf_{max} results are averaged to give Δf_{2avg} . The percentage of Δf_{max} values greater than recommended lower limit is also found.
- If the payload is 11110000, the average frequency deviation is found in 4 bit intervals (2, 3, 6 and 7) and the average of these values is calculated as Δf_{1avg} . The ratio of Δf_{2avg} and Δf_{1avg} is also found.
- BT Freq Dev vs Time display has an octet view (zoomed view of the 8 bit intervals in Payload) and also shows the bit intervals in which the Δf_{max} values are computed. The octet view option also allows you to see the regions in which the calculations are done.

NOTE. *The octet view option is only available when Preamble is detected.*

- Specify an octet to view by entering a value in the Octet # field in the BT Freq Dev vs Time display. This also shows the maximum number of octets used for analysis. The start and end point for every octet can be clearly seen using the octet view.
- In the Summary display, the scalar results (Δf_{1avg} , Δf_{2avg} , Ratio, Percentage of Δf_{max} values greater than a limit) averaged over the last 10 packets analyzed are shown along with the packet count. These averaged results can be compared against limits set in the Limits tab of the Settings control panel.
- The Points/symbol option in the Trace tab can be used to control how many samples per symbol should be used for computation of these measurements. The standard recommends 32 samples per symbol for Low Energy and 4 samples per symbol for Basic Rate. These are the default values provided for the respective standards in the Bluetooth Standards presets.

Carrier frequency offset and drift (Basic Rate and Low Energy)

This measurement verifies that the carrier frequency offset and carrier drift of the transmitted signal is within the specified limits for the specified standard. The Bluetooth test specification recommends this measurement be done using fixed frequency, also known as *hopping off*, and can be done in Direct Tx mode. This test can be done only if the payload contains 10101010 bit pattern. This measurement and test setup are set to Free Run mode by default. However, you can set the analyzer to Triggered mode (Setup > Trigger) to do the measurements.

More information about this measurement:

- Select the Modulation/Frequency Offset/Drift/Output Power test setup from Presets > Standards to perform carrier frequency offset and drift measurements. This will load the displays found in the [Bluetooth standards, test setups, and Preset displays table](#). Additionally, you can choose to load the BT Symbol Table and BT Constellation displays, which can provide useful information.
- This measurement calculates the following:
 - Frequency offset in Preamble (initial Carrier Frequency Offset).
 - Frequency offset in Payload (calculated in 10 bit intervals in Payload).
 - Drift (the difference in frequency offset calculated in Payload from that calculated in Preamble).
 - The drift is measured by taking the difference in frequency offset between two fixed intervals. The interval length is 10 bits in Payload separated by 50 μ s (5 intervals away).
- The BT CF Offset and Drift display shows all results in a table.
- The measurements shows the following scalar results:
 - Preamble frequency offset (initial carrier frequency offset).
 - Maximum frequency offset in Payload (along with the index number at which the offset is at maximum).
 - Drift of frequency offset from Preamble to first 10 bit interval in Payload (f_1-f_0).
 - Maximum drift between Payload and Preamble (f_n-f_0) (along with index number at which the drift is maximum).
 - Drift between two 10 bit intervals spaced 50 μ s away (f_n-f_{n-5}) (along with index number at which the drift is maximum).
- The Preamble region in which the Preamble offset is calculated is shown in the BT Freq Dev vs Time display along with markings to show the region in which maximum drift occurred. Maximum drift between Payload and Preamble is shown from the end of Preamble to the end of 10 bit interval in Payload in which maximum drift occurred. Maximum drift in payload (in 50 μ s duration) is also shown.
- In the Summary display, the scalar results (mentioned above) averaged over the last 10 packets are shown along with the packet count. The results are compared against recommended limits. You can set these limits in the Limits tab of the Settings control panel.

In-band Emissions (Basic Rate and Low Energy)

This measurement verifies that the in-band spectral emissions are within limits. The standard document recommends that this measurement be done with Hopping off, finding the integrated power in 1 MHz band (with RBW 100 kHz) in 80 channels starting from 2401 MHz to 2481 MHz. The test can be done in Direct Tx mode. The integrated power values calculated in the adjacent channels are compared against recommended limits (except the three channels around transmitted frequency). This measurement is referred to as ACPR in the Radio Frequency Test Specification for Basic Rate. It is recommended to do this measurement in Free Run mode (set in Setup > Trigger) if the analyzer does not support the required BW (80 MHz). The measurement internally searches for burst and aligns the measurement to the on-slot region.

NOTE. For analyzers with limited bandwidth, this measurement will be done over multiple acquisitions to generate the data required for the entire span. Therefore, it is important for the user to set an analysis length that will ensure that on slot region is always included.

More information about this measurement:

- Select the In-band Emissions test setup from Presets > Standards to perform the in-band emissions measurements. This will load the displays found in the [Bluetooth standards, test setups, and Preset displays table](#).
- The In-band Emissions display will set the Center Frequency to 2.441 GHz by default. When the Retain CF option is not enabled from Standards Presets, 80 bands (each of bandwidth 1 MHz) are analyzed and the integrated power is found (indicated by Blue lines in the plot).
- The integrated power is compared against limits for comparison (shown by white masks) in all bands except the three channels around the transmitted frequency. If any band fails, that band is shown in red color. If more than three channels fail to meet the recommended limits, a FAIL is shown in the top left corner of the display.
- The table below the plot shows the integrated power and also the limit for comparison.
- The limits for comparison are set to the values given by the standard by default, but you can manually set them from the Limits tab of the Settings control panel.
- This measurement is done only on the on slot region if a ramp-up and ramp-down portions are available. However, the measurement is done on the complete analysis region if a ramp up or ramp down is not available. It is recommended that a complete packet is included in the analysis region.
- When the analyzer does not support the 80 MHz bandwidth requirement, multiple acquisitions are taken in different bands and stitched together. This measurement is therefore best done in Free Run mode (set in Setup > Trigger) as Triggered mode might not find a proper edge in an acquisition taken for stitching purposes.

Output Power (Basic Rate and Low Energy)

This test verifies the maximum peak and average power emitted from the EUT. The standards document recommends this test be done for a PRBS payload pattern. Also, the measurement must be done over the duration of a burst starting at preamble position. The Bluetooth test specification recommends this measurement be done using fixed frequency, also known as *hopping off*, and can be done in Direct Tx mode.

More information about this measurement:

- Select the Modulation/Frequency Offset/Drift/Output Power test setup from Presets > Standards to perform carrier frequency offset and drift measurements. This will load the displays found in the [Bluetooth standards, test setups, and Preset displays table](#).
- Calculates the average power and peak power for any Bluetooth signal. The peak power is the peak power value in the chosen on slot region.
- The measurement is done only on preamble detection; otherwise, it is invalid.
- The BT Summary display shows the averaged result over 10 packets.

20dB Bandwidth (Basic Rate)

This measurement verifies if the emissions inside the operating frequency range are within limits. This measurement is done with Hopping off. The difference between frequency points at which the power level drops to 20 dB below the peak power of the emission is found at 20 dB Bandwidth.

More information about this measurement:

- Select the 20dB Bandwidth test setup from Presets > Standards to perform the 20 dB emissions measurements. This will load the displays found in the [Bluetooth standards, test setups, and Preset displays table](#).
- The BT 20 dB BW display allows you to set the relative power level (x dB BW) compared to the peak power at which the frequency points are to be found.
- When you select the 20dB Bandwidth test setup, the center frequency (CF), span, and relative bandwidth (RBW) are set as recommended by the standard document.
- It is recommended this measurement be done over three different center frequencies. You can do this by changing the center frequency as needed.
- From the Params tab of the Settings control panel, you can select that the search for the x dB relative power (20 dB in this case) be performed in one of two modes: from the edges towards the peak power (inwards) or vice versa (outwards). The default for this setting is Inwards (from edges to peak power) when this measurement is chosen from the Standards Preset menu, as recommended.
- The blue markings in the plot indicate the 20 dB bandwidth and the frequency points at which the power level drops down by 20 dB from the peak power.
- The resulting 20 dB bandwidth is compared with the limits recommended by the standard document and Pass/Fail is shown in the top left corner of the plot. This is not user defined.

If the highest power value measured in step d) is equal or higher than 0 dBm: $f = |fH - fL| \leq 1.0 \text{ MHz}$.

If the highest power value measured in step d) is lower than 0 dBm: $f = |fH - fL| \leq 1.5 \text{ MHz}$.

Frequency Range (Basic Rate)

These measurements verify if the emissions inside the operating frequency range are within limits. These measurements are done with Hopping off in two steps. The first measurement is done at the lower frequency spectrum of the Bluetooth band. (Start – 2399 MHz and Stop 2405 MHz). The second is done at the higher frequency spectrum of the Bluetooth band (Start -2475 MHz and Stop at 2485 MHz). The difference between the frequency point at which the power level drops to -30 dBm from the center frequency is measured. fL is the difference on the lower side from the center frequency when the lower end of the spectrum is being analyzed. fH is the difference from the center frequency on the higher side when the higher end of the spectrum is analyzed. $fH - fL$ is the Frequency Range.

More information about these measurements:

- The BT 20dB BW display allows you to set the absolute power level (x dBm level) from the Parameters tab of the Settings control panel. The Bluetooth SIG Radio Frequency test specification document suggests that this value be set to -30 dBm for doing the Frequency Range measurement. If you chose to set up this measurement using start and stop frequencies and RBW, those should be

set as recommended by the standard. Separate start and stop frequencies are given for the two steps of this measurement.

- You can select for the analysis to find the x dBm frequency difference from the center frequency either on the lower side, higher side, or both sides. This option (Meas Range) can be set from the Params tab of the Settings control panel.
- The blue marking indicates the frequency difference from the center frequency based on the Meas Range option choice. You can set this option to Low while analyzing in the lower range of the frequency spectrum, and set it to High when analyzing the higher range of the frequency spectrum.

Power Density (Basic Rate)

This measurement verifies the maximum RF output power density.

More information about this measurement:

- This measurement can be done using the Spectrum display (Displays > Measurements > General Signal Viewing) and by setting appropriate parameters as recommended in the Bluetooth SIG Radio Frequency test specification document.
- The Bluetooth test specification recommends this measurement be done using fixed frequency, also known as *hopping off*, and can be done in Direct Tx mode.

Out-of-band Spurious Emission (Basic Rate and Low Energy)

This measurement can be done for FCC or ETSI masks using the [Spurious](#) display.

Relative Power (Enhanced Data Rate)

This measurement calculates the relative power in the GFSK and PSK part of the Enhanced Data Rate (EDR) signal. This measurement is supported only when an EDR signal is detected.

Select the Enhanced Data Rate standard from Presets > Standards to perform the measurement. This will load the displays found in the [Bluetooth standards, test setups, and Preset displays table](#).

Bluetooth Status Messages

The following status messages may appear. Each message indicates the related condition (Description) shown in the following table.

Status message	Description
Bluetooth Analysis: Preamble Not Detected	Shown in the display and status bar when no valid Sync and Preamble are found for the chosen standard. Also shown when no preamble is found for any of the standards in Automatic Standard Detection mode.
Bluetooth Analysis: Low Energy Sequence Detected	Shown in the status bar when the Low Energy standard is detected in Automatic Standard Detection mode.
Bluetooth Analysis: Basic Rate Sequence Detected	Shown in the status bar when the Basic Rate standard is detected in Automatic Standard Detection mode.
Bluetooth Analysis: EDR Signal Detected	Shown in the status bar when the EDR standard is detected in Automatic Standard Detection mode.
Bluetooth Analysis: EDR Sync Word Not Detected	Shown in the display and status bar when EDR Sync Word is not found (when EDR standard is selected).
Bluetooth Analysis: Not enough payload data for Bluetooth measurements	Shown in the display and status bar when Preamble and Access Address/Sync Word is detected but there is not enough payload data for Modulation Characteristics and CF Offset and Drift measurement.
Bluetooth Analysis: Meas BW may be too low	Shown in the InBand Emission display and in status bar when Measurement Bandwidth is too low.
Bluetooth Analysis: BT x dB BW detection failed	Shown in the BT 20 dB BW display when x dB measurement detection fails.
Bluetooth Analysis: BT x dBm BW detection failed	Shown in the BT 20 dB BW display when x dBm measurement detection fails.

Bluetooth Constellation display

The BT Constellation display shows a digitally modulated signal in constellation form. The constellation can be viewed either as IQ or Freq Dev. The default view is Freq Dev. The frequency deviation result that is shown in the Constellation display is compensated for the frequency error (shown as readout).

To show the BT Constellation display you can select **Presets > Standards > Bluetooth** or do the following:

1. Recall an appropriate acquisition data file.
2. Press the **Displays** button or select **Setup > Displays**.
3. In the **Select Displays** window, select **Bluetooth Analysis** in the **Measurements** box.
4. In the Available displays box, double-click the **BT Constellation** icon or select the icon and click **Add**. The BT Constellation icon will appear in the **Selected displays** box and will no longer appear under Available displays.
5. Click the **OK** button to show the display.
6. Select **Setup > Settings** to display the control panel.
7. Select the **Standard Params** tab. Set the Standard, Power class (if required), and Measurement and Reference filters as appropriate for the input signal. You can also check the **Auto Detect Standard** box.

Item	Display element	Description
A	Trace	Select and enable a trace.
B	Trace Type	Specifies Trace type (choice between Freq Dev and IQ). This option appears only when EDR signal is detected.
C	Freq Error / Freq Offset / marker readouts	<p>The Freq Error, Freq Offset, and marker readout values appear here or below the plot, depending on the display view and size.</p> <p>The Freq Error value is the difference between the maximum and the minimum values of signal frequency during the measurement time. The Freq Error (Auto) value is displayed when the Auto check box is selected in the Analysis Params tab in the Settings control panel.</p> <p>The Freq Offset (Manual) value is displayed when the Auto check box is unselected in the Analysis Params tab in the Settings control panel.</p> <p>When markers are enabled, marker information (including time, magnitude, phase, symbol, and value) is displayed.</p>
D	Avg Dev	Shows the average deviation result at every symbol point.
E	Plot	Bluetooth constellation graph. Shown as either IQ or as Frequency Deviation. The trace type is controlled from the Settings > Trace tab.
F	Show Vectors	Specifies whether to show or hide the selected trace.

The following image shows the BT Constellation display of GFSK data in a Basic Rate signal. Trace Type is set to Freq Dev.

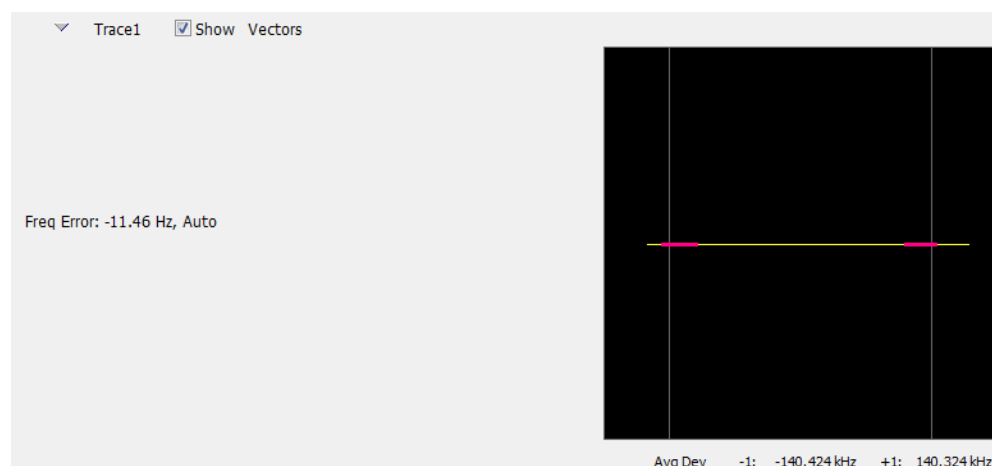

BT Constellation Settings

Main menu bar: Setup > Settings

Favorites toolbar: 

The BT Constellation Settings control panel provides access to settings that control parameters of the Constellation Display.

Settings tab	Description
Standard Params	Select the standard, measurement filters, reference filters, and power class (when applicable). You can also set the analyzer to auto detect the standard.
Analysis Params	Specifies frequency error, frequency offset, measurement BW, and test patterns. You can also select to auto detect test patterns. These parameters are used by the instrument to analyze the input signal.
Analysis Time	Specifies parameters that define the portion of the acquisition record that is used for analysis. Also allows you to specify the Units (Symbols or Seconds) and Time Zero Reference (Trigger or Acquisition Start) for Bluetooth Analysis displays.
Traces	Allows you to select the trace to view, the trace type (IQ or Freq Dev), the number of points per symbol (when trace content is set to Vectors or Lines), and to show or freeze the selected trace.
Prefs	Allows you to select to show or hide the graticule and marker readouts.

Bluetooth Eye Diagram display

The BT Eye Diagram display shows a digitally modulated signal overlapped on itself to reveal variations in the signal.

To show the BT Eye Diagram display:

1. Recall an appropriate acquisition data file.
2. Press the **Displays** button or select **Setup > Displays**.
3. From the **Measurements** box, select **Bluetooth Analysis**.
4. Double-click the **BT Eye Diagram** icon in the **Available Displays** box. This adds the BT Eye Diagram icon to the **Selected displays** box.
5. Click **OK** button. This displays the BT Eye Diagram view.
6. Select **Setup > Settings** to display the control panel.
7. Select the **Standard Params** tab. Set the Standard, Power class (when appropriate), and Measurement and Reference filters as appropriate for the input signal. You can also check the **Auto Detect Standard** box.
8. Select the **Trace** tab and set the **Trace Type** to Freq Dev or IQ, as required..
9. Select Replay/Run to take measurements on the acquired data.

Elements of the Display

The following image shows the BT Eye display of a basic rate signal with Trace Type set to IQ.

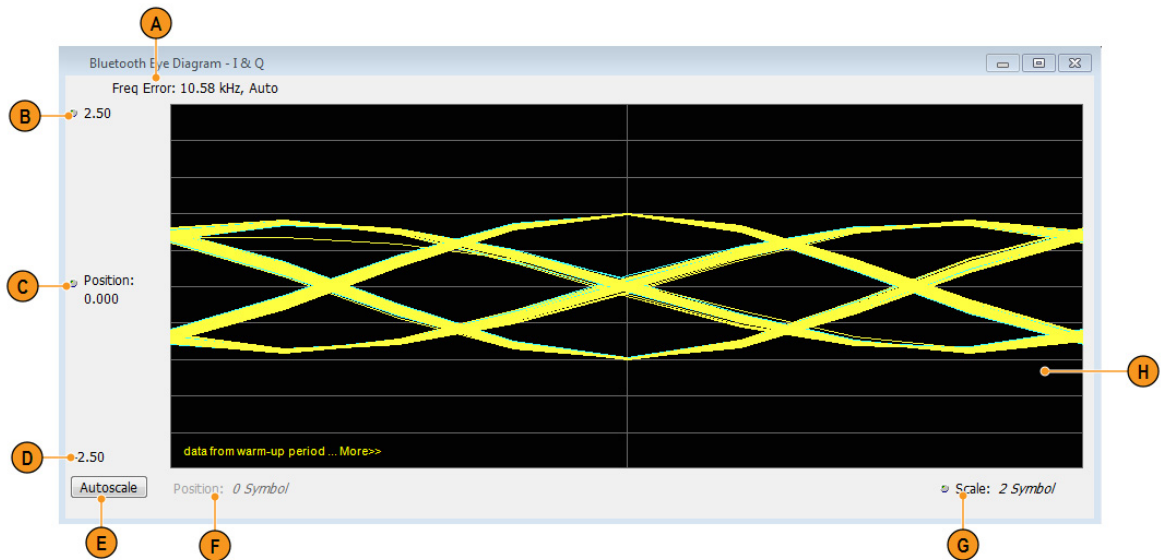

Item	Display element	Description
A	Freq Error / Freq Offset	The Freq Error value is the difference between the maximum and the minimum values of signal frequency during the measurement time. The Freq Error (Auto) value is displayed when the Auto check box is selected in the Analysis Params tab in the Settings control panel. The Freq Offset (Manual) value is displayed when the Auto check box is unselected in the Analysis Params tab in the Settings control panel.
B	Top of graph	The vertical scale is normalized with no units (for IQ) and with Hz (for Freq Dev).
C	Position	Specifies the value shown at the center of the graph display.
D	Bottom Readout	Displays the value indicated by the bottom of graph.
E	Autoscale	Adjusts the vertical and horizontal settings to provide the best display.
F	Position	Displays the horizontal position of the trace on the graph display.
G	Scale	Adjusts the span of the graph in symbols.
H	Plot	Displays the input signal.

The following image shows the BT Eye display of a Basic Rate signal with Trace Type set to Freq Dev.

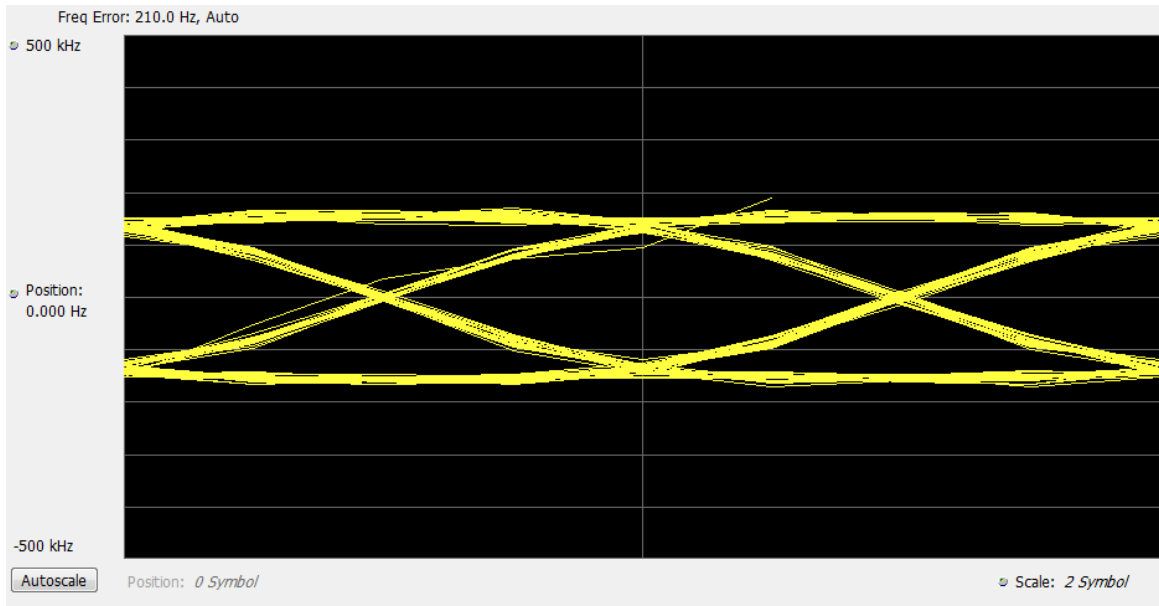

BT Eye Diagram Settings

Main menu bar: Setup > Settings

Favorites toolbar: 

The settings for the BT Eye Diagram display are shown in the following table.

NOTE. You might save time configuring the BT Eye Diagram display by selecting the Standard Presets button in the Bluetooth Eye Diagram Settings control panel. This allows you to select a preset optimized for the selected standard.

Settings tab	Description
Standard Params	Select the standard, measurement filters, reference filters, and power class (when applicable). You can also set the analyzer to auto detect the standard.
Analysis Params	Specifies frequency error, frequency offset, measurement BW, and test patterns. You can also select to auto detect test patterns. These parameters are used by the instrument to analyze the input signal.
Analysis Time	Specifies parameters that define the portion of the acquisition record that is used for analysis. Also allows you to specify the Units (Symbols or Seconds) and Time Zero Reference (Trigger or Acquisition Start) for Bluetooth Analysis displays.
Traces	Allows you to select the trace to view, the trace type (IQ or Freq Dev), the number of points per symbol (when trace content is set to Vectors or Lines), and to show the selected trace.
Scale	Allows you to specify the horizontal and vertical scale settings.
Prefs	Allows you to select to show or hide the graticule and marker readouts.

Bluetooth Carrier Frequency Offset and Drift display

The BT CF (Carrier Frequency) Offset and Drift display shows the frequency offset preamble, payload regions, and the drift result values are shown in this display. You can also view the values of frequency offset calculated in every ten bit interval in the payload and look for excursions.

To show the BT CF (Carrier Frequency) Offset and Drift display:

1. Recall an appropriate acquisition data file.
2. Press the **Displays** button or select **Setup > Displays**.
3. In the **Select Displays** dialog, select **Bluetooth Analysis** in the **Measurements** box.
4. In the Available displays box, double-click the **BT CF Offset and Drift** icon or select the icon and click **Add**. The BT CF Offset and Drift icon will appear in the **Selected displays** box and will no longer appear under Available displays.
5. Click **OK** to show the display.
6. Select **Setup > Settings** to display the control panel.
7. Select the **Standard Params** tab. Set the Standard, Power class (when appropriate), and Measurement and Reference filters as appropriate for the input signal. You can also check the **Auto Detect Standard** box.
8. Select the **Limits** tab and set the limits , as required.
9. Select **Replay/Run** to take measurements on the acquired data.

Elements of the Display

The following image shows the frequency offset and drift values of a basic rate signal in the BT Freq Offset and Drift display.

Interval#	Frequency offset (Hz)	Drift from f ₀ (Hz)	Drift - 50us (Hz)
	Limits f _n (-150.0kHz to +150.0kHz)	Limits f _n -f ₀ (-40.0kHz to +40.0kHz) f ₁ -f ₀ (-20.0kHz to +20.0kHz)	Limits f _n -f _(n-5) (-20.0kHz to +20.0kHz)
▶ 0 (Preamble)	6434.094		
1	6422.583	-11.51074	
2	5296.85	-1137.244	
3	6478.38	44.28564	
4	6880.799	446.7051	
5	5173.156	-1260.938	
6	5455.798	-978.2959	-966.7852
7	5832.239	-601.855	535.3892
8	6631.489	197.395	153.1094
9	5221.211	-1212.883	-1659.588
10	4814.595	-1619.499	-358.5605
11	6111.346	-322.748	655.5479
12	6569.333	135.2388	737.0938
13	4871.332	-1562.763	-1760.158

Freq Offset Preamble: 6.434 kHz Drift f₁-f₀: -11.51 Hz Max Drift f_n-f_(n-5): 3.696 kHz @ 208
 Max Freq Offset (Payload): 7.826 kHz @ 131 Max Drift f_n-f₀: -4.080 kHz @ 115

Display element	Description
Column 1	Indicates ten bit interval numbers. Zero indicates preamble region and the non-zero number indicate the ten bit intervals in payload.
Column 2	Shows the calculated frequency offset in the preamble and the ten bit intervals in the payload.
Column 3	Shows the drift of offset from the preamble and over a 50 μs duration.
Column 4	Shows the drift of offset over a 50 μs duration.
—	Results that do not meet the limits are shown with a red colored background, indicating failure. (Limits can be set in the Limits tab from the Settings control panel.)
Scalar results	The scalar results show below the table. They are as follows: Freq Offset Preamble Max Freq Offset (Payload) Drift f ₁ -f ₀ Max Drift f _n -f Max Drift f _n -f _(n-5)

BT CF Offset and Drift Settings

Main menu bar: Setup > Settings

Favorites toolbar: 

The settings for the BT CF Offset and Drift display are shown in the following table.

Settings tab	Description
Standard Params	Select the standard, measurement filters, and power class (when applicable). You can also set the analyzer to auto detect the standard.
Analysis Params	Specifies frequency error, frequency offset, measurement BW, and test patterns. You can also select to auto detect test patterns. These parameters are used by the instrument to analyze the input signal.
Analysis Time	Specifies parameters that define the portion of the acquisition record that is used for analysis. Also allows you to specify the Units (Symbols or Seconds) and Time Zero Reference (Trigger or Acquisition Start) for Bluetooth Analysis displays.
Limits	Allows you to load and define Bluetooth measurement limits for Pass/Fail comparison. You can save defined limits as a .csv file and also load previously saved .csv files. These limits also apply to the Settings control panel Limits tab of the BT Summary display.

Bluetooth Summary display

The BT Summary display shows a summary of all the scalar measurements done on the acquired test pattern. The summary display and contents will vary according to the selected standard.

Pass/Fail information is also provided in this display for all enabled scalar measurements. You can set limits and choose which measurement to compare for Pass/Fail from the Limits tab of the BT Summary Settings control panel. The default limits come from the performance recommendation limits given by the Standards document. The default limits can be reloaded by selecting the Bluetooth Standards Preset option.

The results presented in the BT Summary display include scalar results of modulation characteristics, frequency offset and drift and, output power measurements (these are averaged over the last 10 acquired packets). The display also shows packet related information for the current acquired packet.

To show the BT Summary display you can select **Presets > Standards > Bluetooth** or do the following:

1. Recall an appropriate acquisition data file.
2. Press the **Displays** button or select **Setup > Displays**.
3. In the **Select Displays** dialog, select **Bluetooth Analysis** in the **Measurements** box.
4. In the Available displays box, double-click the **BT Summary** icon or select the icon and click **Add**. The BT Summary icon will appear in the **Selected displays** box and will no longer appear under Available displays.
5. Click **OK** to show the display.
6. Select **Setup > Settings** to display the control panel.
7. Select the **Standard Params** tab. Set the Standard, Power class (when appropriate), and Measurement and Reference filters as appropriate for the input signal. You can also check the **Auto Detect Standard** box.
8. Select the **Limits** tab and set the limits , as required.
9. Select **Replay/Run** to take measurements on the acquired data.

Elements of the display

The following image shows all average scalar results and packet information for a Basic Rate signal in the BT Summary display. Modulation characteristics, carrier frequency offset and drift, and power measurements, along with packet information, are shown. The packet information will vary depending on the chosen or detected standard. For more information about specific measurement results, see the Bluetooth measurements and test setups section [here \(see page 359\)](#).

Standard: Basic Rate Class3 Clear

Modulation Characteristics [10 packet-average]	Packet Information
$\Delta F1_{avg}$ (00001111): -- Hz -- of 10 N/A	Packet Type: DH5
$\Delta F2_{avg}$ (10101010): 144.8 kHz	Preamble (4 bits): 0101
$\Delta F2_{Max\%} \geq 115$ kHz: 100.0 % 1 of 10 PASS	Sync Word (64 bits): 0x4F36F2CEE85390CB
$\Delta F2_{avg}/\Delta F1_{avg}$: -- N/A	Packet Header (18 bits)
Modulation Index: --	LT_ADDR (3 bits): 001
Frequency Offset and Drift [10 packet-average]	Type (4 bits): 1111
Freq Offset (Preamble): 6.434 kHz PASS	Flow (1 bit): 1
Max Freq Offset: 7.826 kHz PASS	ARQN (1 bit): 0
Drift f1-f0: -11.51 Hz PASS	SEQN (1 bit): 1
Max Drift fn-f0: -4.080 kHz PASS	HEC (8 bits): 00110001
Max Drift fn-f(n-5): 3.696 kHz 1 of 10 PASS	PayLoad Length: 0101010011
Output Power [10 packet-average]	CRC (16 bits): 0x273D
Peak Power Ppk: -20.77 dBm PASS	
Average Power Pavg: -21.04 dBm 1 of 10 PASS	

Element	Description
Standard	Display of the selected standard or the detected standard (if the Auto Detect Standard setting is chosen in the Standard Params tab of the Settings control panel).
Power class	Display of the Power class in the Standard Params tab of the Settings control panel. Only available when Basic Rate is the selected or detected standard.
Clear	Click button to reset measurement. Clears all values and all results in the queue used for average computation.
Modulation characteristics (ten packet average)	<p>Display of a group of scalar results related to Modulation Characteristics measurements. These scalar results are only populated in the BT Summary display if preamble is detected in the acquired data. The four scalar results are:</p> <ul style="list-style-type: none"> $\Delta f1_{avg}$ is calculated when analyzed test pattern (payload) is 11110000. $\Delta f2_{avg}$ and the percentage of $\Delta f2_{max}$ value (greater than a given limit) are calculated only when analyzed test pattern (payload) is 10101010. The ratio of $\Delta f2_{avg}$ and $\Delta f1_{avg}$ is calculated provided both the results are available (or have been done before). <p>All the results given are averaged over the last ten packets. The scalar results can be compared with pass/fail limits set in the Limits tab of the Settings control panel.</p> <p>More information can be found here (see page 359).</p>

Element	Description
Modulation index	The Modulation index denotes if the transmitter of a BLE Packet is Stable or Standard. If it is Stable, the modulation index will be between 0.495 and 0.505. If it is Standard, the modulation index will be between 0.475 and 0.525. If neither of these conditions is satisfied, then no text is shown.
Frequency offset and drift (ten packet average)	<p>Display of a group of five scalar results related to the carrier frequency offset and drift measurement. These scalar results are only populated in the BT Summary display if preamble is detected and if the test pattern payload is a 10101010 pattern. All the results given are averaged over the last ten packets. The scalar results can be compared with pass/fail limits set in the Limits tab of the Settings control panel.</p> <p>The eight scalar results are:</p> <ul style="list-style-type: none"> Preamble offset Maximum offset in Payload (calculated over 10 bit intervals) Drift (f_1-f_0) Max Drift (f_n-f_0). Max Drift (f_n-f_{n-5}) <p>For more information about this measurement, see the Carrier frequency offset and drift (Basic Rate and Low Energy) topic in <i>Bluetooth Measurements and test setups</i>.</p>
Output power	<p>Display of Average Power and Peak Power scalar results for Output Power. All the results given are averaged over the last ten packets. The scalar results can be compared with pass/fail limits set in the Limits tab of the Settings control panel.</p> <p>For Enhanced Data Rate signals, the relative power in GFSK and PSK regions is measured.</p> <p>For more information about this measurement, see the Output Power (Basic Rate and Low Energy) (see page 365) topic in <i>Bluetooth Measurements and test setups</i>.</p>
Packet information	The Packet information includes the Packet type, Preamble, Synchronization Word or Access Code, Packet Header, Payload length, and CRC details. The decoded bits are shown for the current analyzed packet.

The following image shows all average scalar results and packet information for a Low Energy signal in the BT Summary display.

Standard: LE 1M Clear

Modulation Characteristics [10 packet-average]		Packet Information	
ΔF_{1avg} (00001111):	-- Hz -- of 10	Packet Type	BLE_TEST
ΔF_{2avg} (10101010):	229.1 kHz	Preamble (8 bits)	01010101
$\Delta F_{2Max\%} \geq 185$ kHz:	100.0 % 2 of 10	Access Address (32 bits)	0x71764129
$\Delta F_{2avg}/\Delta F_{1avg}$:	--	PDU Header (16 bits)	
Modulation Index:	--	Length (8 bits)	00100101
Frequency Offset and Drift [10 packet-average]		PDU Type (4 bits)	0010
Freq Offset (Preamble):	158.1 Hz	ChSel (1 bit)	--
Max Freq Offset:	57.43 Hz	Tx Address (1 bit)	--
Drift f_1-f_0 :	-100.7 Hz	Rx Address (1 bit)	--
Max Drift f_n-f_0 :	-160.2 Hz	CRC (24 bits)	0x555555
Max Drift $f_n-f(n-5)$:	-57.43 Hz 2 of 10		
Output Power [10 packet-average]			
Peak Power Ppk:	-29.51 dBm		
Average Power Pavg:	-30.00 dBm 2 of 10		

The following image shows all average scalar results and packet information for an EDR signal in the BT Summary display.

Standard: EDR Clear

Modulation Characteristics [10 packet-average]		Packet Information	
ΔF_{avg} :	-- Hz 0 of 10	Packet Type	EDR_2DH1
Frequency Offset and Drift [10 packet-average]		Preamble (4 bits)	0101
Freq Offset (Preamble):	-- Hz	Sync Word (64 bits)	0x4F36F2CEE85390CB
Max FreqOffset:	-- Hz	Packet Header (18 bits)	
Drift f_1-f_0 :	-- Hz	LT_ADDR (3 bits)	001
Max Drift f_1-f_0 :	-- Hz	Type (4 bits)	0100
Max Drift $f_1-f_1-5_1$:	-- Hz -- of 10	Flow (1 bit)	1
		ARQN (1 bit)	0
		SEQN (1 bit)	1
		HEC (8 bits)	11010111
Output Power [10 packet-average]		PayLoad Length	110110
POWER GFSK:	-28.42 dBm	CRC (16 bits)	--
POWER DPSK:	-28.51 dBm 1 of 10		

BT Summary Settings

Main menu bar: Setup > Settings

Favorites toolbar: 

The settings for the BT Summary display are shown in the following table.

Settings tab	Description
Standard Params	Select the standard, measurement filters, reference filters, and power class (when applicable). You can also set the analyzer to auto detect the standard.
Analysis Params	Specifies frequency error, frequency offset, measurement BW, and test patterns. You can also select to auto detect test patterns. These parameters are used by the instrument to analyze the input signal.
Analysis Time	Specifies parameters that define the portion of the acquisition record that is used for analysis. Also allows you to specify the Units (Symbols or Seconds) and Time Zero Reference (Trigger or Acquisition Start) for Bluetooth Analysis displays.
Limits	Allows you to load and define Bluetooth measurement limits for Pass/Fail comparison. You can save defined limits as a .csv file and also load previously saved .csv files. The frequency offset and drift limits set here also apply to the CF Offset and Drift display.

Bluetooth Symbol Table display

The BT Symbol Table display shows decoded data values for each data symbol in the analyzed signal packet. It is like the BT Constellation display except that a text table is used to display data instead of a graph.

To show the BT Symbol Table display:

1. Recall an appropriate acquisition data file.
2. Press the **Displays** button or select **Setup > Displays**.
3. In the **Select Displays** dialog, select **Bluetooth Analysis** in the **Measurements** box.
4. In the Available displays box, double-click the **BT Symbol Table** icon or select the icon and click **Add**. The BT Symbol Table icon will appear in the **Selected displays** box and will no longer appear under Available displays.
5. Click **OK** to show the display.
6. Select **Setup > Settings** to display the control panel.
7. Select the **Standard Params** tab. Set the Standard, Power class (when appropriate), and Measurement and Reference filters as appropriate for the input signal. You can also check the **Auto Detect Standard** box.

8. Select the **Limits** tab and set the limits , as required.
9. Select Replay/Run to take measurements on the acquired data.

Regions of the Display

The BT Symbol Table is color coded to indicate different regions of the packet. The legend at the bottom of the symbol table lists the packet contents in their associated colors. The following image shows values for a Basic Rate signal.

Symbol	0	1	0	1	0	1	1	0	1	0	0	1	1	0	0	0	0
0	1	0	1	0	1	1	0	1	0	0	1	1	0	0	0	0	
16	1	0	0	1	1	1	0	0	1	0	1	0	0	0	0	1	
32	0	1	1	1	0	1	1	1	0	0	1	1	0	1	0	0	
48	1	1	1	1	0	1	1	0	1	1	0	0	1	1	1	1	
64	0	0	1	0	0	0	0	0	0	0	0	0	0	1	1	1	
80	1	1	1	1	1	1	1	1	1	1	1	1	1	1	1	0	
96	0	0	1	1	1	0	0	0	0	0	0	0	0	0	1	1	
112	1	1	1	1	0	0	0	0	0	0	1	1	1	1	1	0	
128	0	1	0	1	0	1	0	0	0	0	1	1	1	1	0	0	
144	0	0	1	1	1	1	0	0	0	0	1	1	1	1	0	0	
160	0	0	1	1	1	1	0	0	0	0	1	1	1	1	0	0	
176	0	0	1	1	1	1	0	0	0	0	1	1	1	1	0	0	
192	0	0	1	1	1	1	0	0	0	0	1	1	1	1	0	0	
208	0	0	1	1	1	1	0	0	0	0	1	1	1	1	0	0	

Preamble	Packet Header	Payload
Synchronization/Access Address	Payload Header	MIC/CRC
Marker:	Time:	Symbol:
		Value:

Packet standard	Associated regions
Basic rate	4-bit preamble 64-bit access code 4-bit trailer 54-bit packet header 8- or 16-bit payload header based on packet type Variable length payload data 16-bit CRC (Cyclic Redundancy Check)
Low Energy	8-bit preamble 32-bit access address / synchronization word 16-bit payload header Variable length payload data (37 bytes) 24-bit CRC (Cyclic Redundancy Check)
Enhanced Data Rate (EDR)	4-bit preamble 64-bit access code 4-bit trailer (if present, shown in black) 54-bit packet header Guard region (shown as X) EDR sync sequence (QPSK or 8PSK symbols) 16-bit payload header (QPSK or 8PSK symbols) Variable length payload data (QPSK or 8PSK symbols) 16-bit CRC (Cyclic Redundancy Check) (QPSK or 8PSK symbols)

The following image shows values for a Low Energy signal.

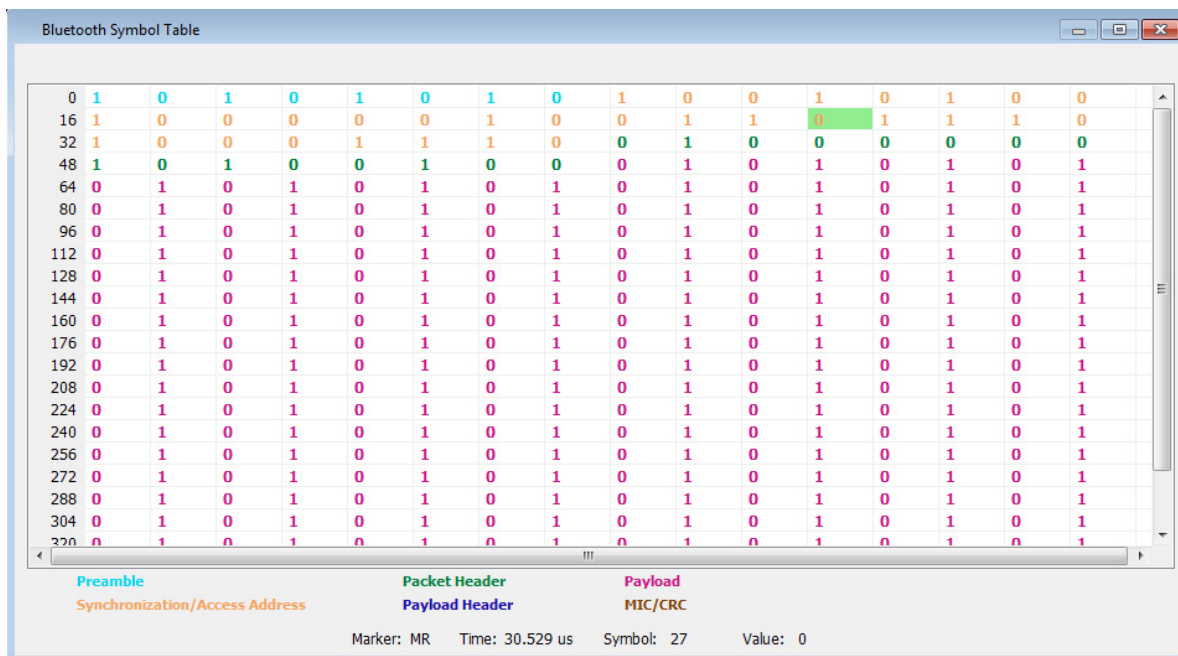

The following image shows values for an EDR signal.

Markers and the BT Symbol Table. Markers are indicators in the display that you can position on a trace to measure values such as frequency, power, and time. A Marker always displays its position and, if the Delta Marker (M1-M4) readout is enabled, will display the difference between its position and that of the Marker Reference (MR). In the BT Symbol Table, colored cells indicate the location of markers. The selected Marker is highlighted with a light green background. All other markers are highlighted with a light gray background. In the BT Symbol Table, the marker readout below the table shows the marker location in time, symbol numbers and symbol value.

BT Symbol Table Settings

Main menu bar: Setup > Settings

Favorites toolbar: 

The settings for the BT Symbol Table display are shown in the following table.

Settings tab	Description
Standard Params (see page 429)	Select the standard, measurement filters, reference filters, and power class (when applicable). You can also set the analyzer to auto detect the standard.
Analysis Params (see page 431)	Specifies frequency error, frequency offset, measurement BW, and test patterns. You can also select to auto detect test patterns. These parameters are used by the instrument to analyze the input signal.
Analysis Time (see page 432)	Specifies parameters that define the portion of the acquisition record that is used for analysis. Also allows you to specify the Units (Symbols or Seconds) and Time Zero Reference (Trigger or Acquisition Start) for Bluetooth Analysis displays.
Prefs (see page 437)	Allows you to select to show or hide the marker readouts and set the radix of shown symbols.

Bluetooth Frequency Dev vs Time display

The BT Freq Dev vs. Time display shows how the signal frequency varies with time.

To display the BT Freq Dev vs. Time display:

1. Recall an appropriate acquisition data file.
2. Select the **Displays** button or **Setup > Displays**.
3. In the **Select Displays** dialog, select **Bluetooth Analysis** in the **Measurements** box.
4. In the **Available displays** box, double-click the **BT Freq Dev vs. Time** icon or select the icon and click **Add**. The BT Freq Dev vs. Time icon will appear in the **Selected displays** box and will no longer appear under Available displays.
5. Click **OK** to show the display.
6. Select the **Standard Params** tab. Set the Standard, Power class (when appropriate), and Measurement and Reference filters as appropriate for the input signal. You can also check the **Auto Detect Standard** box.
7. Select the **Trace** tab and set the **Content** to Vectors or Points, as required.
8. Select Replay/Run to take measurements on the acquired data.

Elements of the Display

The following image shows the frequency deviation of the complete packet of a Basic Rate signal in the BT Freq Dev vs. Time display.

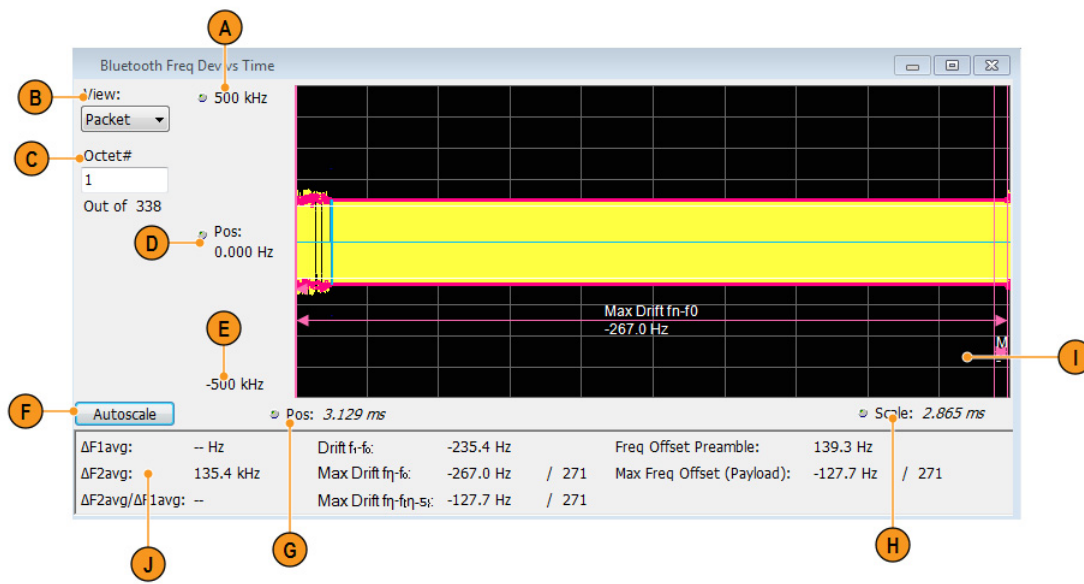

Item	Display element	Description
A	Top of graph	The vertical scale is normalized with Hz.
B	View	(This option is visible only when Preamble is detected.) Select one of the following: Packet: view frequency deviation for an entire packet. Octet: view frequency deviation for a specified octet duration (8 μ s). The Octet is specified in the Octet # field.
C	Octet # (xx of total)	(This option is visible only when Preamble is detected and Octet is selected as the View.) Specifies the Octet number. (The total number of octets is also indicated.) When View is set to Octet, you can enter a particular octet in the Octet # field for zoom view. The plot will show only 8 μ s of information corresponding to the octet number chosen in the payload. The regions that are used for doing the exact measurements are highlighted in the Octet View. For F0F0 (Low Deviation) pattern in payload, bit intervals 2,3,6,7 regions are highlighted. For 1010 (high deviation) pattern, all bit regions are highlighted with appropriate results. The offset calculated for every octet region (f1ccf or f2ccf) are also shown.
D	Position (center)	Adjust the frequency shown at the center of the display.
F	Autoscale button	Adjusts the offset and range for both vertical and horizontal to provide the best display.
G	Position	Displays the horizontal position of the trace on the graph display.
H	Scale	Adjusts the horizontal scale (time).
I	Plot	Displays the last analyzed complete packet or the selected octet (Octet zoom view) of the signal.
J	Scalar results	The Scalar results for Modulation Characteristics and Frequency Offset and Drift measurements are captured here. These results are from the last analyzed packet and therefore could be different from the Averaged Scalar results shown in the BT Summary display. For Drift results, the index is also shown where the maximum drift occurred. The Drift results are shown only when the preamble is detected and the test pattern payload detected is 10101010. ΔF_{1avg} or ΔF_{2avg} is shown only when the detected test pattern payload is 10101010 or 11110000.

NOTE. *This display shows the frequency deviation results without compensating for the frequency error.*

The following image shows the frequency deviation of the first octet in the payload of a Basic Rate signal (high deviation).

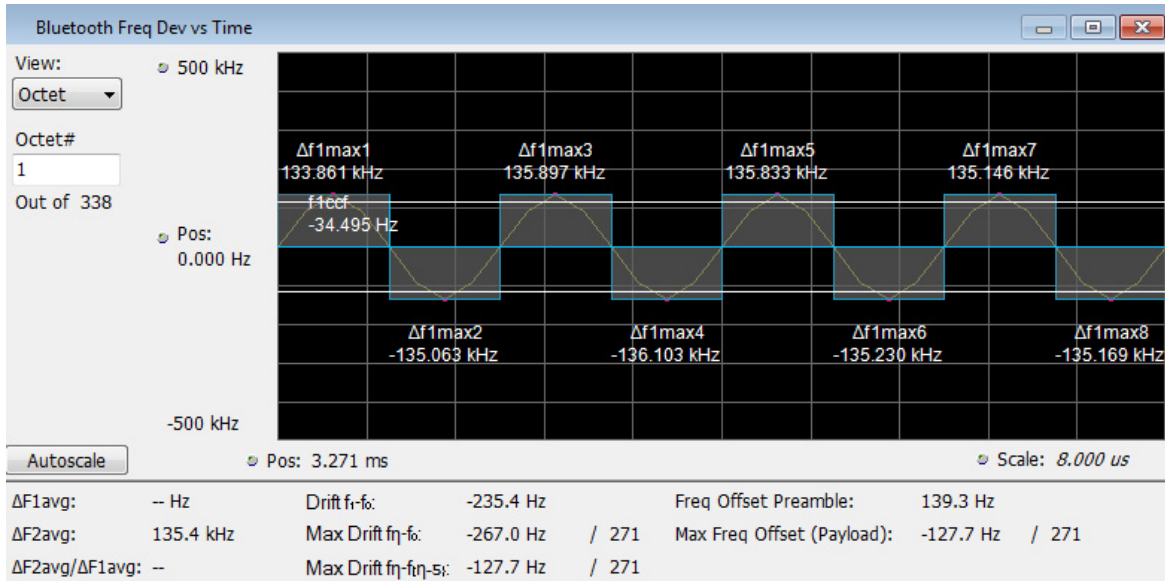

The following image shows the frequency deviation of the first octet in the payload of a Basic Rate signal (low deviation).

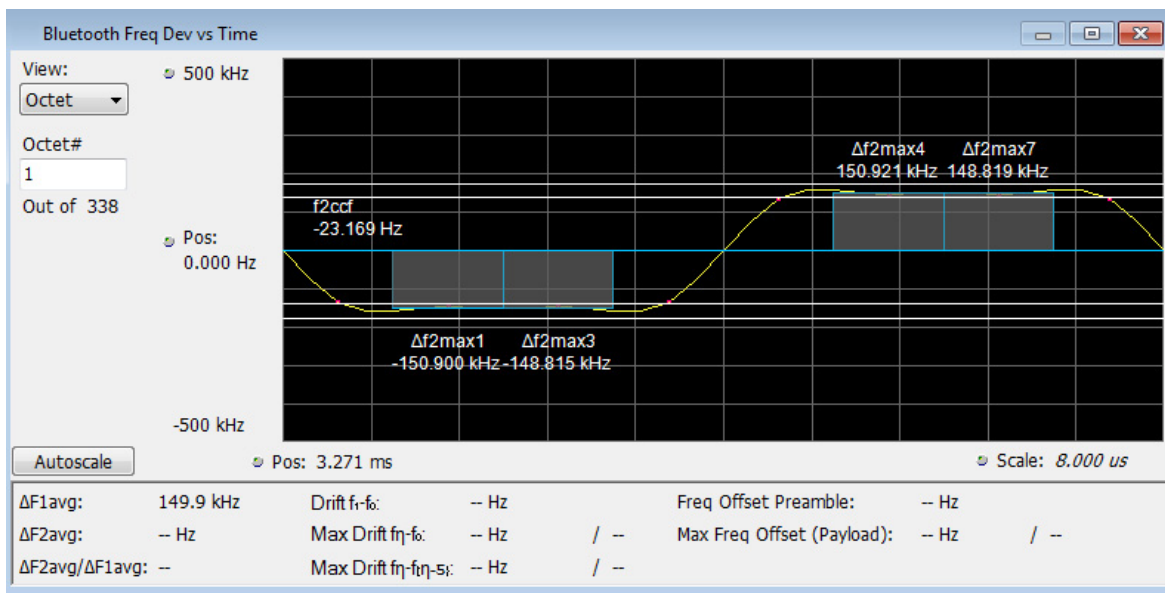

BT Frequency Dev Vs Time Settings

Main menu bar: Setup > Settings

Favorites toolbar: 

The Setup settings for BT Freq Dev vs. Time are shown in the following table.

Settings tab	Description
Standard Params (see page 429)	Select the standard, measurement filters, reference filters, and power class (when applicable). You can also set the analyzer to auto detect the standard.
Analysis Params (see page 431)	Specifies frequency error, frequency offset, measurement BW, and test patterns. You can also select to auto detect test patterns. These parameters are used by the instrument to analyze the input signal.
Analysis Time (see page 432)	Specifies parameters that define the portion of the acquisition record that is used for analysis. Also allows you to specify the Units (Symbols or Seconds) and Time Zero Reference (Trigger or Acquisition Start) for Bluetooth Analysis displays.
Trace (see page 435)	Allows you to select the number of points per symbol, content, and to choose between entire packet view or zoom Octet view for a chosen octet number in a packet.
Scale (see page 434)	Allows you to specify the horizontal and vertical scale settings.
Prefs (see page 437)	Allows you to select to show or hide the graticule and marker readouts.

Bluetooth 20dB Bandwidth display

The BT 20dB BW display shows the results of two Bluetooth measurements: 20dB Bandwidth and Frequency Range. When the xdB BW is chosen, the display shows the x dB bandwidth from the peak power. More detailed information about this measurement is available [here \(see page 397\)](#).

To display the BT 20dB BW display:

1. Recall an appropriate acquisition data file.
2. Select the **Displays** button or **Setup > Displays**.
3. In the **Select Displays** dialog, select **Bluetooth Analysis** in the **Measurements** box.
4. In the **Available displays** box, double-click the **BT 20dB BW** icon or select the icon and click **Add**. The BT 20dB BW icon will appear in the **Selected displays** box and will no longer appear under Available displays.
5. Click **OK** to show the display.
6. Select the **Standard Params** tab. Set the Standard, Power class (when appropriate), and Measurement and Reference filters as appropriate for the input signal. You can also check the **Auto Detect Standard** box.

7. Select the **Trace** tab and set the **Content** to Vectors or Points, as required.
8. Select Replay/Run to take measurements on the acquired data.

Elements of the Display

The following image of the BT 20dB BW display shows a Basic Rate signal that would allow you to measure 20 dB bandwidth.

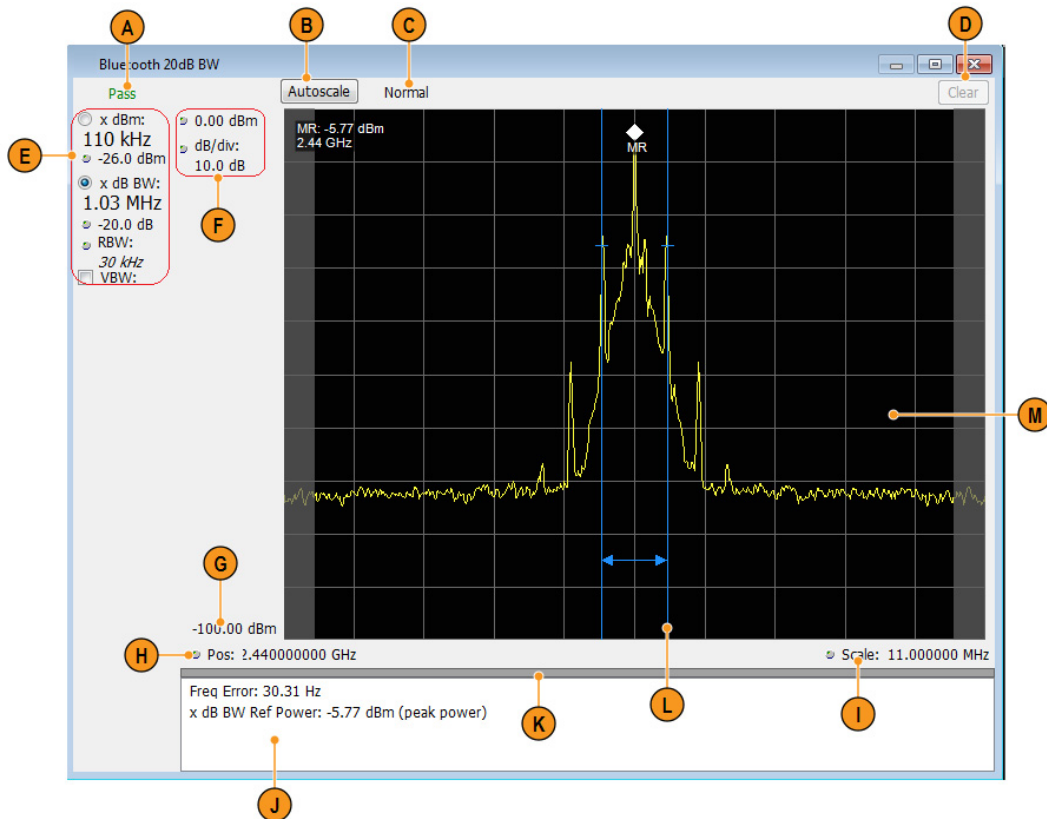

Item	Display element	Description
A	PASS / FAIL	Indicates Pass or Fail for the 20 dB BW measurement.
B	Autoscale	Adjusts the vertical and horizontal settings so that the entire trace fits in the graph.
C	Normal / MaxHold	Indicates whether the measurement is done with a MaxHold or a Normal condition.
D	Clear	Resets count for Average and MaxHold functions. Enabled only when Averaging or MaxHold is enabled. Pressing Clear will clear the trace and, if acquisition is running, restart the averaging or hold process.
E	Main results area	Shows the xdBm and xdB results. The requested dB or dBm value can be set in the controls below the result readout. Use the two radio buttons to select which of the two results are illustrated in the graph with the blue lines and arrows. RBW also can be set using the control. VBW enables the VBW (Video Bandwidth) filter. Displays current VBW filter setting. See Setup > Settings > Freq & RBW tab.
F	Position and dB/div Units (not shown)	Position sets the top of graph value. The dB/div setting is the vertical scale value. Set the global Amplitude units for all the views in the analysis window using the drop down menu that appears when you click on the box. This will change the amplitude selection in the Units tab of the Amplitude control panel.
G	Bottom readout	Displays the value indicated by the bottom of graph.
H	Position	Displays the horizontal position of the trace on the graph display.
I	Scale	Adjust the span of the graph in symbols.
J	Detailed results	Displays the following additional measurements results: Freq Error: The frequency difference between the measured carrier frequency of the signal and the user-selected center frequency of the analyzer. x dB BW Ref Power: The peak power measured within the measurement bandwidth.
K	Grid divider	Determines the portion of the display allocated to the graph and detailed results area. You can move the grid divider all the way to the top or bottom and any position in between.
L	Blue lines	Indicates the measurement positions.
M	Plot	Displays the input signal. Shaded areas indicate the measurement bandwidth (Settings > Parameters tab > Measurement BW).

BT 20dB BW settings

Main menu bar: Setup > Settings

Favorites toolbar: 

The Setup settings for BT 20dB BW are shown in the following table.

Settings tab	Description
Freq & RBW (see page 441)	Allows you to specify the frequency, resolution bandwidth (RBW), step, and VBW used for the MCPR measurements.
Parameters (see page 439)	Allows you to specify the x dB level, Measurement Direction, Measurement BW, xdBm level, xdBm Range, count, and to enable averaging and the Max Hold function.
Scale (see page 434)	Allows you to define the vertical and horizontal axes.
Prefs (see page 437)	Allows you to select show or hide the graticule and marker readouts.

Bluetooth InBand Emission display

The BT InBand Emission display verifies whether the emissions inside the operating frequency range are within limits. The power in adjacent channels of 1 MHz bandwidth around the frequency of transmission are calculated and compared against limits. The integrated power in the 1 MHz band for the adjacent channels is shown in a table below the plot.

To display the BT InBand Emission display:

1. Recall an appropriate acquisition data file.
2. Select the **Displays** button or **Setup > Displays**.
3. In the **Select Displays** dialog, select **BT Inband Emission** in the **Measurements** box.
4. In the **Available displays** box, double-click the **BT Inband Emission** icon or select the icon and click **Add**. The BT Inband Emission icon will appear in the **Selected displays** box and will no longer appear under Available displays.
5. Click **OK** to show the display.
6. Select the **Standard Params** tab and select the appropriate standard.
7. Select the **Measurement Params** tab and turn on averaging, if desired.
8. Select the **Limits** tab and set the desired limits.
9. Select **Replay/Run** to take measurements on the acquired data.

Elements of the Display

The following image shows the BT Inband Emission display of a Basic Rate signal operating at 2.441 GHz (showing 80 adjacent bands).

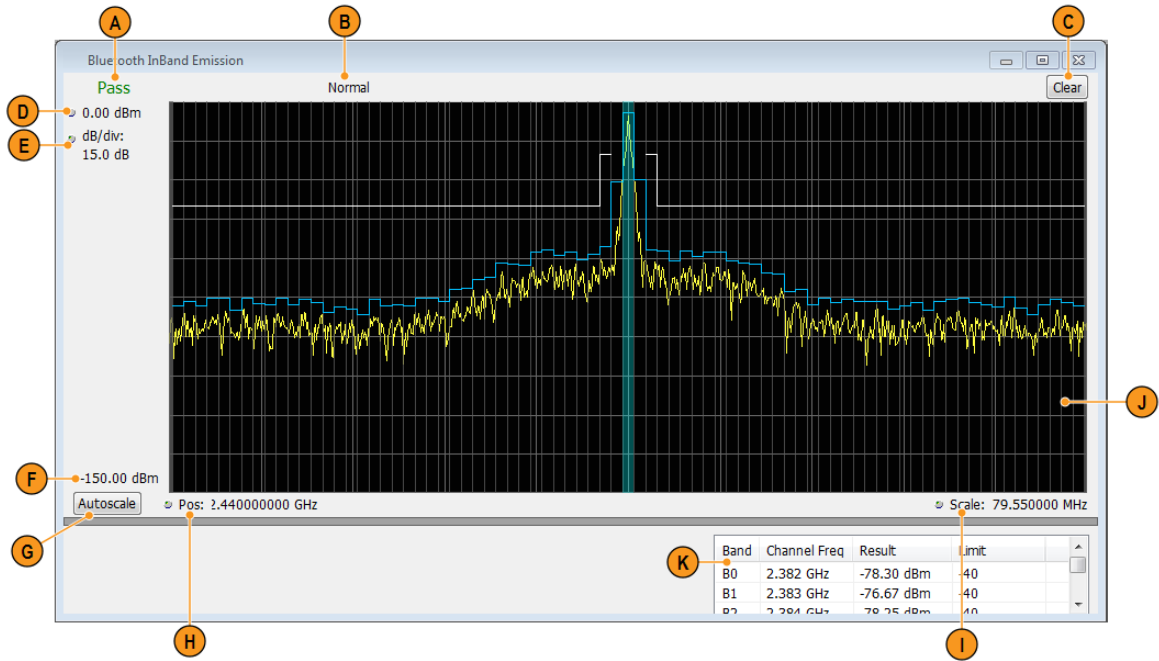

Item	Display element	Description
A	PASS / FAIL	Indicates Pass or Fail based on the number of adjacent channels that are below an upper limit. A maximum of 3 adjacent channels can have integrated power higher than an upper limit (Pass); otherwise, Fail is reported.
B	Normal	Displays Average Count if Average is turned on (set to Time Domain or Frequency Domain) from the Measurement Params tab in the Settings control panel.
C	Clear	Resets measurement. Clears all values.
D	Top of graph	The vertical scale is normalized with appropriate power units.
(not shown)	Units	Sets the global Amplitude units for all the views in the analysis window. This will change the amplitude selection in the Units tab of the Amplitude control panel.
E	dB/div	The vertical scale value.
F	Bottom readout	Displays the value indicated by the bottom of graph.
G	Autoscale	Adjusts the vertical and horizontal settings so that the entire trace fits in the graph.
H	Position	Displays the horizontal position of the trace on the graph display.
I	Scale	Adjust the span of the graph in symbols.
J	Plot	Divides the spectrum into different adjacent channels (each of 1 MHz bandwidth) as suggested in the standard document. You can select to show integrated power by checking the <i>Show power levels in graph</i> box in the Prefs tab in the Settings control panel). The integrated power level is shown in blue and the prescribed limits for comparison (set in the Limits tab of the Settings control panel) are shown in white. The region around the frequency of transmission is shown in a different color.
K	Results table	Reports the integrated power results (Channel frequency, Integrated power, and Limits) from the display in a table.

Bluetooth Analysis Measurement Settings

Main menu bar: Setup > Settings

Favorites toolbar: 

The control panel tabs in this section are shared between the displays in Bluetooth Analysis (Setup > Displays). Some tabs are shared by all the displays, some tabs are shared by only a subset of displays. The settings available on some tabs change depending on the selected display.

Common controls for Bluetooth Analysis displays

Settings tab	Description
Standard Params (see page 429)	Specifies the input signal standard and additional user-settable signal parameters.
Analysis Params (see page 431)	Specifies parameters used by the application to analyze the input signal.
Analysis Time (see page 432)	Specifies parameters that define the portion of the acquisition record that is used for analysis. Also allows you to specify the Units (Symbols or Seconds) for Bluetooth Analysis displays.
Trace (see page 435)	Specifies the trace type (Vectors, Points, and Lines), the number of points per symbol when chosen to view as Vectors or Lines, and to control the view as Freq Dev or IQ.
Prefs (see page 437)	Allows preferences with Radix display and marker readouts.
Scale (see page 434)	Defines the vertical and horizontal axes.
Parameters (see page 439)	Specifies parameters used to analyze the signal.
Freq RBW (see page 441)	Allows you to set Frequency and RBW settings for the BT 20 dB BW display.
Limits (see page 433)	Allows you to define limits for pass/fail comparison with calculated values. The default values are as recommended in the test specification.
Measurement Params (see page 441)	Allows you to set average (Time Domain, Off, or Frequency Domain) and to correct for noise floor.

Standard Params tab - BT

The Standard Params tab allows you to specify the standard, measurement and reference filters, power class (for some standards), and set standard auto detect.

The following image shows the tab for all of the Bluetooth displays except for the BT InBand Emission display. The Power Class menu only appears when Basic Rate is the selected standard.

Standard Params | Analysis Params | Analysis Time | Limits

Standard: Basic Rate Auto Detect

Measurement Filter: None

Reference Filter: None

Power Class: 3

The following image shows the tab for the BT InBand Emission display.

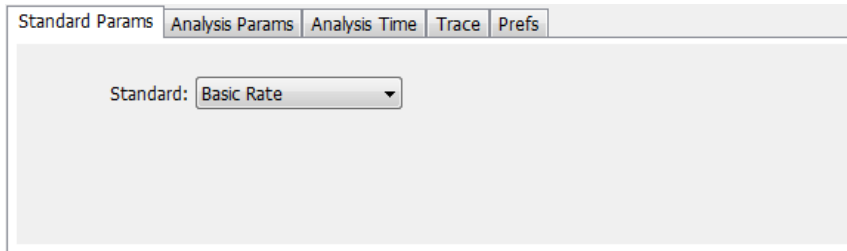

Settings	Description
Standard	Select the appropriate standard: Basic Rate, Low Energy, or Enhanced Data Rate.
Auto Detect Standard	Check box to enable automatic detection of the Bluetooth standard (Basic Rate, Low Energy, or Enhanced Data Rate). A status message will appear indicating which of the three standards is detected and the result will show as Standard selection.
Measurement Filter	Specifies the filter used for measurement. The default filters for the Low Energy and Basic Rate standards are LE-Recommended and BR-Recommended, respectively.
Reference Filter	Specifies the filter used as a reference.
Power Class (only available for Basic Rate)	Select one out of three available power classes. This sets the default limits for comparison (set in the Limits tab of the Settings control panel) for Average and Peak power measurements.

Power class for the Basic Rate standard

The power class for Basic Rate is the reference receive power range as specified by the standard. It sets the default limits for comparison in the Limits tab of the control panel for Average and Peak power measurements. The power classes are specified as follows:

Class 1: max power 20 dBm (100 mW) with mandatory power control.

Class 2: max power 6 dBm (4 mW) with optional power control.

Class 3: max power 0 dBm (1 mW) with optional power control.

Recommended measurement and reference filters

The available measurement and reference filters depend on the selected standard. You can use the filters recommended by the standard (shown in following table) or load your own filters by selecting one of the User defined filters from a file.

The measurement filter is applied before the demodulation bit is detected and the ideal reference is calculated.

The reference filter is applied to the internally generated ideal reference signal.



CAUTION. *Although there may be other filter types listed in the drop down menu, if you select any filter other than that which is recommended, the measurement results may not be accurate.*

Standard	Measurement filters	Reference filters
Basic Rate	BR-Recommended	None
Low Energy	LE-Recommended	None
Enhanced Data Rate	BR-Recommended	None

How to select filters

In a signal transmitter/receiver system, the baseband signal might be filtered for bandwidth limiting or for another kind of necessary shaping that needs to be applied. Normally, a filter in the transmitter (Ft) and a filter in the receiver (Fr) are applied.

The Measurement Filter setting in the analyzer corresponds to the baseband filter in the receiver (Fr): This setting tells the analyzer what filter your receiver uses. When the analyzer is set to the same filter used by the receiver, the analyzer sees the signal as your receiver would. The Measurement Filter setting should be the same as the filter used in the receiver under normal operation (as opposed to testing).

Analysis Params tab - Bluetooth

The Analysis Params tab contains parameters that control the analysis of the input signal. The Test Patterns menu only appears when the Auto Detect Test Pattern is not checked. This tab is available for all displays except for the BT 20dB BW and the BT InBand Emission displays.

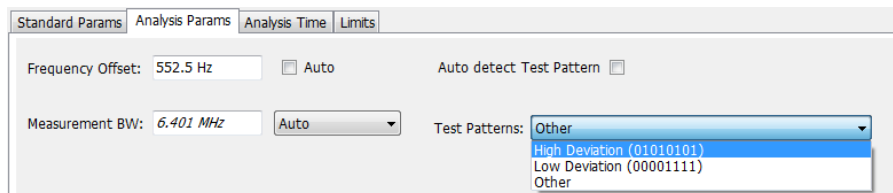

Settings	Description
Frequency Error	When the Auto box is checked, the analysis determines the Frequency Error and the measured Frequency Error is displayed. When the Auto box is unchecked, the entered value is used by the analysis as a fixed frequency offset. This is useful when the exact frequency offset of the signal is known.
Measurement BW	Specifies the bandwidth about the center frequency at which measurements are made. Select Manual, Auto, or Link to Span.
Auto Detect Test Pattern	When this box is checked, automatic detection of the test pattern is enabled. When this box is unchecked (Manual mode), automatic detection is disabled and you can select the test pattern and specify the Δf_{avg} for the other pattern for ratio computation.
Test Pattern	Allows you to select the test pattern to be analyzed. This choice is available only when Auto Detect Test Pattern is disabled.

Analysis Time tab - Bluetooth

The Analysis Time tab contains parameters that define how the signal is analyzed in the Bluetooth Analysis displays. This tab is available for all displays except for the BT 20dB BW and the BT InBand Emission displays.

Standard Params | Analysis Params | **Analysis Time** | Trace | Prefs

Analysis Offset: Auto Time Zero Reference:

Analysis Length: Auto Units:

Available: 0.000 s

Settings	Description
Analysis Offset	Specifies the location of the first time sample to use in measurements.
Auto	When enabled, causes the instrument to set the Analysis Offset value based on the requirements of the selected display.
Analysis Length	Specifies the length of the analysis period to use in measurements. Length is specified in either symbols or seconds, depending on the Units setting.
Auto	When enabled, causes the instrument to set the Analysis Length value based on the requirements of the selected display.
Available	This is a displayed value, not a setting. It is the Analysis Length (time or symbols) being used by the analyzer. This value may not match the Analysis Length requested (in manual mode).
Time Zero Reference	Specifies the zero point for the analysis time.
Units	Specifies the units of the Analysis Length to either Symbols or Seconds.

Analysis Offset

Use analysis offset to specify where measurements begin. Be aware that you cannot set the Analysis Offset outside the range of time covered by the current acquisition data. (All time values are relative to the Time Zero Reference.)

You can set the Analysis Length so that the requested analysis period falls partly or entirely outside the current range of acquisition data settings. When the next acquisition is taken, its Acquisition Length will be increased to cover the new Analysis Length, as long as the Sampling controls are set to Auto. If the Sampling parameters are set to manual, or if the instrument is analyzing saved data, the actual analysis length will be constrained by the available data length, but in most cases, measurements are able to be made anyway. The instrument will display a notification when measurement results are computed from less data than requested. Range: 0 to [(end of acquisition) - Analysis Length]. Resolution: 1 effective sample (or symbol).

Analysis Length

Use the analysis length to specify how long a period of time is analyzed. As you adjust this value, the actual amount of time for Analysis Length, in Symbol or Seconds units, is shown below the control in the "Available" readout. This setting is not available when Auto is checked. Range: minimum value depends on the standard. Resolution: 1 symbol.

Time Zero Reference

All time values are measured from this point (such as marker position or horizontal position (in Y vs Time displays). Choices are: Acquisition Start or Trigger.

Parameter	Description
Acquisition Start	Time zero starts from the point at which the acquisition begins.
Trigger	Time zero starts from the trigger point.

Limits tab - Bluetooth

This tab is only available for the BT CF Offset and Drift, BT InBand Emission, and BT Summary displays. It enables you to load an existing limits table, save a limits table, or edit limits values. The content under Measurement Name varies based on the chosen standard and power class.

Some measurements are done only when a specific test pattern is detected. If the specific pattern is not detected, then N/A appears in blue in the BT Summary display because the measurement is not done. If the measurement is done, Pass or Fail is shown in the BT Summary display.

The following image shows the Limits tab for the BT CF Offset and Drift and BT Summary displays.

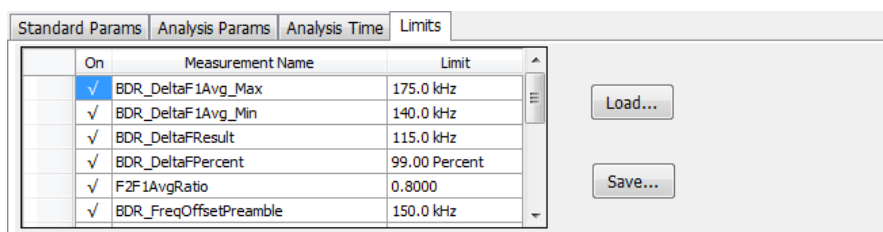

The following image shows the Limits tab for the BT InBand Emission display.

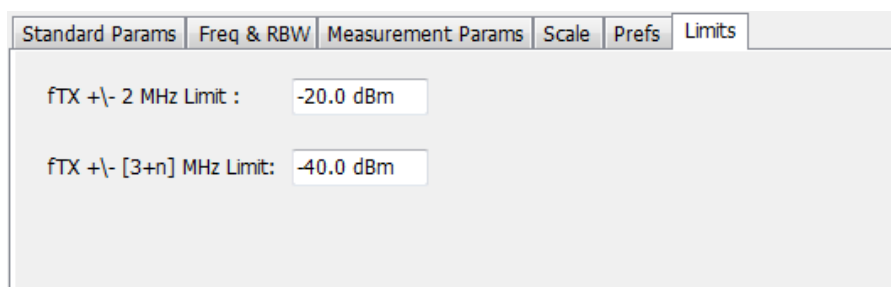

Settings	Description
Load	Click to load a saved Limits table from a .csv file.
Save	Click to save the current Limits table to a .csv file.

Edit limits

To directly edit measurement limits in the table, click on the value in the Limit column that you want to change. The following table describes the parameters that are set in the Limits Table.

Settings	Description
On	Click on the cell in the On column next to the measurement to specify whether or not measurements are selected for limit comparison to indicate Pass or Fail. A check mark means the measurement will be taken. An empty box means it will not be taken.
Measurement Name	Specifies the name of the measurement related to the limit. (Not editable.) The content under Measurement Name varies based on the chosen standard and power class.
Limit	Specifies the value of the limit to the related measurement. When the cell is selected, the value is shown along with the units.

Scale tab - Bluetooth

The Scale tab allows you to change the scale settings that control how the trace appears on the display but does not change control settings such as Measurement Frequency. In effect, these controls operate like pan and zoom controls. The Scale tab values are unique to each display. Also, note that each display uses horizontal and vertical units that are appropriate for that display. There are three versions of the Scale tab for Bluetooth displays.

The following image shows the Scale tab for the BT 20dB BW and BT InBand Emission displays.

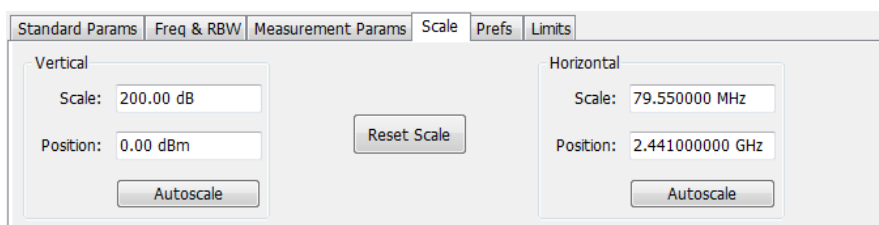

The following image shows the Scale tab for the BT Eye Diagram display.

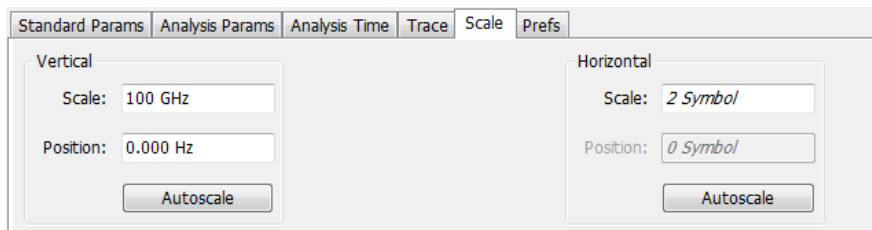

The following image shows the Scale tab for the BT Freq Dev vs Time display.

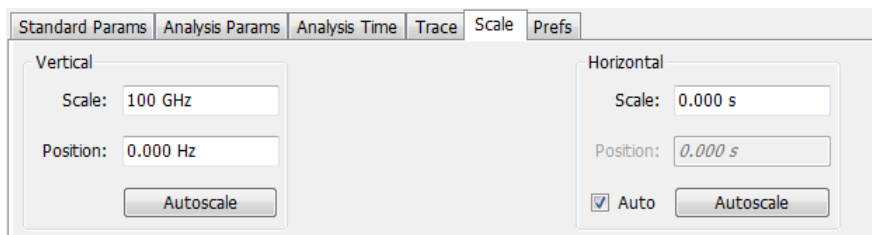

Settings	Description
Vertical	Controls the vertical position and scale of the trace display.
Scale	Changes the vertical scale of the graph.
Position	Adjusts the reference level away from top of the graph.
Autoscale	Resets the scale of the vertical axis to contain the complete trace.
Horizontal	Controls the horizontal span of the trace display and position of the trace.
Scale	Allows you to, in effect, change the horizontal span.
Position	Allows you to pan a zoomed trace without changing the frequency.
Autoscale	Resets the scale of the horizontal axis to contain the complete trace.
Auto	When Auto is checked, the scale and position values for the Symbols graph are automatically adjusted to maintain the optimal display.
Reset Scale	Resets all settings to their default values.

NOTE. The Units used for the horizontal scale for the BT Freq Dev vs Time display can be either Seconds or Symbols. To set the units for the horizontal scale, display the Analysis Time tab. On the tab, select the appropriate units from the Units drop-down list.

Traces tab - Bluetooth

The Traces tab allows you to set the trace display characteristics of the BT Constellation, BT Eye Diagram, and BT Freq Dev vs Time displays. The selections vary depending on the selected display.

The following image shows the tab for the BT Constellation display.

The screenshot shows the 'Traces' tab in the software interface. The tab bar at the top includes 'Standard Params', 'Analysis Params', 'Analysis Time', 'Traces', and 'Prefs'. The 'Traces' tab is active. The configuration area contains the following controls:

- Trace: Trace1 (dropdown menu)
- Show: (checkbox)
- Freeze: (checkbox)
- Points/Symbol: 4 (dropdown menu)
- Trace Type: Freq Dev (dropdown menu)
- Content: Vectors (dropdown menu)

The following image shows the tab for the BT Eye Diagram display.

The screenshot shows the 'Traces' tab for the BT Eye Diagram display. The tab bar at the top includes 'Standard Params', 'Analysis Params', 'Analysis Time', 'Traces', 'Scale', and 'Prefs'. The 'Traces' tab is active. The configuration area contains the following controls:

- Trace: I (dropdown menu)
- Show: (checkbox)
- Points/Symbol: 8 (dropdown menu)
- Trace Type: IQ (dropdown menu)

The following image shows the tab for the BT Freq Dev vs Time display.

The screenshot shows the 'Traces' tab for the BT Freq Dev vs Time display. The tab bar at the top includes 'Standard Params', 'Analysis Params', 'Analysis Time', 'Prefs', 'Scale', and 'Traces'. The 'Traces' tab is active. The configuration area contains the following controls:

- Points/symbol: 4 (dropdown menu)
- Content: Points (dropdown menu)

Setting	Description
Trace	Select the trace to display.
Show	Shows / hides the selected by trace.
Freeze	Halts updates to the selected trace.
Points/Symbol	Select how many points to use between symbols when connecting the dots. Values: 1, 2, 4, 8, 16, and 32.
Content	Select whether to display the trace as vectors (points connected by lines), points (symbols only without lines), or lines (lines drawn between symbols, but no symbols are displayed). The choices available depend on the display.
Trace Type	Select to specify whether the plot is shown as IQ or as Frequency Deviation.
View	Allows you to see the full packet or only the chosen Octet.
Octet # (of xx)	Allows you to view the specified octet. You can also select from the list of the available number of Payload octets in the packet.

Comparing two traces in the BT Constellation display

You can use the Traces tab to enable the display of a second trace. The second trace is a version of the current acquisition. You can choose to freeze a trace in order to display the current live trace to an earlier version of itself, you can display the trace as a second trace, or you can choose to display both traces frozen in order to compare the trace to itself at different times.

To display a second trace in the BT Constellation display:

1. If more than one display is present, select the BT Constellation display to ensure it is the selected display.
2. Click .
3. Select the Trace tab.
4. Select Trace 2 from the Trace drop-down list.
5. Click the Show check box so that it is checked.
6. Specify the Content as desired.

The Trace 2 lines will appear in blue to help you distinguish Trace 2 from Trace 1.

Prefs tab - Bluetooth

The Prefs tab enables you to change appearance characteristics of some of the Bluetooth Analysis displays.

The following image shows the Prefs tab for the BT 20dB BW, BT Freq Dev vs Time, BT Eye Diagram, and BT Constellation displays.

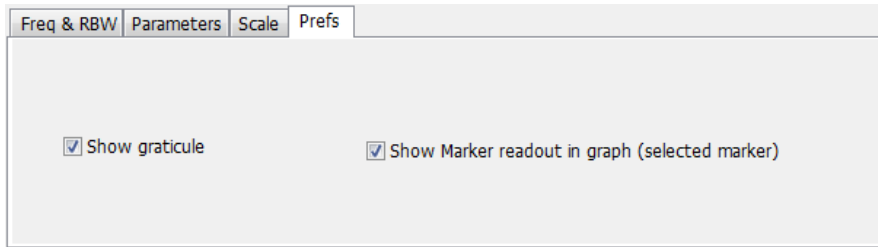

The following image shows the Prefs tab for the BT InBand Emission display.

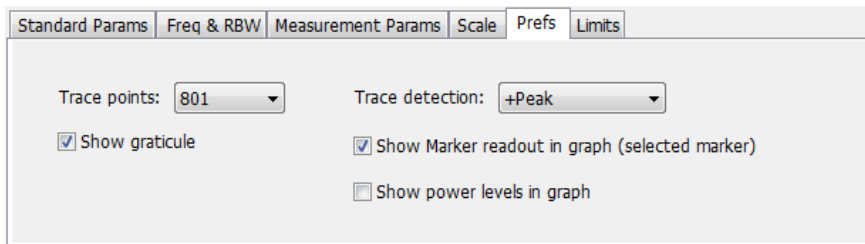

The following image shows the Prefs tab for the BT Symbol Table display.

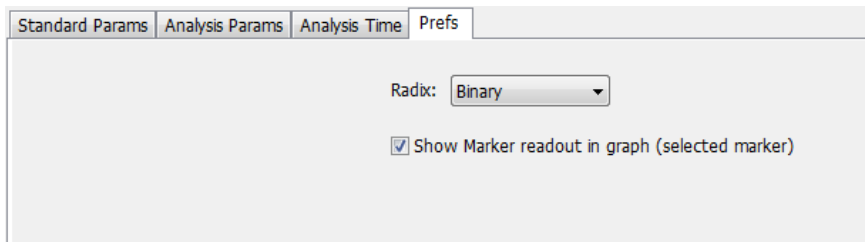

Setting	Description
Show graticule	Shows or hides the graticule.
Show Marker readout in graph (selected marker)	Shows or hides the readout for the selected marker in the graph area.
Radix	Specifies how symbols are displayed in the Symbol Table display and in the Marker readout in the display. There are three choices for Radix: Binary (0,1) and Modulation Symbols (+1,-1). When EDR is detected, the symbol table will always show results in Hex for the PSK region (after guard).
Trace detection	+Peak: Shows the peak power in a bin (of chosen RBW) if there are multiple points to choose from within a bin. Avg (VRMS): Shows the average power in a bin (of chosen RBW) if there are multiple points to choose from within a bin.
Show power levels graph	Displays the calculated power levels in graph in each band.

Parameters tab - Bluetooth

The Parameters tab enables you to specify several parameters that control signal acquisition in the BT 20dB BW display.

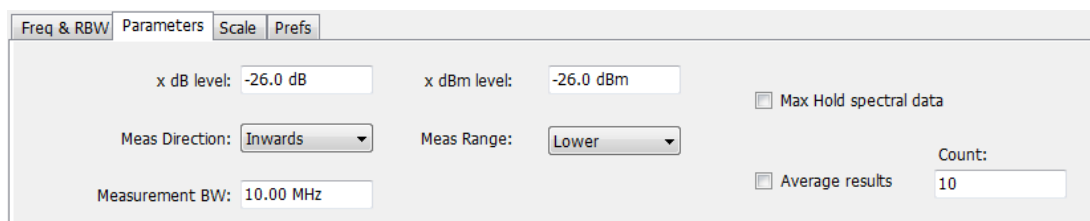

The screenshot shows the 'Parameters' tab with the following settings:

- x dB level: -26.0 dB
- x dBm level: -26.0 dBm
- Meas Direction: Inwards
- Meas Range: Lower
- Measurement BW: 10.00 MHz
- Max Hold spectral data:
- Average results:
- Count: 10

Setting	Description
x dB level	x dB level defines the x dB BW level search threshold.
Meas Direction	Specifies which way the search for the x dB level is done. Selecting Inwards directs the search for x dB from the edges towards maximum power. Selecting Outwards directs the search for x dB from maximum power (x dB ref power) to edges.
x dBm level	x dBm level defines the x dBm BW level search threshold.
x dBm range	Specifies the search direction for the x dBm level. The choices are Lower, Higher, or Both.
Measurement BW	Specifies the frequency range used by the measurement.
Max Hold spectral data	Enables the Max Hold function.
Average results	Enables/disables results average across acquisitions. (This is averaging of the results, not of the trace.)
Count	Specifies the number of results averaged to calculate the Occupied BW. Range: 2 to 10,000.

x dB level

The x dB level determines the x dB bandwidth. The analyzer analyses the spectrum trace to locate the frequencies at which the level is x dB down from the peak level, calculated over the measurement bandwidth. The frequency difference between the upper and lower crossing thresholds is the x dB BW.

Range: -80.0 to -1.0 dB; **Resolution:** 0.1%; Inc/dec small: 0.1%, large: 1%; **Default:** -20 dB

Meas Direction

The search for the x dB level or x dBm level can be done by selecting Inwards or Outwards in Meas Direction. Selecting Inwards directs the search from the edges towards maximum power. Selecting Outwards directs the search from maximum power (x dB ref power or CF for x dBm) to edges.

x dBm level

The x dBm level determines the x dBm bandwidth. The analyzer analyzes the spectrum trace to locate the frequencies at which the level is x dBm down from the Center frequency. The frequency range is calculated based on the choice of x dBm Range. The value of x dBm is set to -30 dBm when the BT 20dB BW display is launched from the Bluetooth Standards Presets.

Meas Range (Higher, Lower, Both)

This determines the search range for the x dB level. The options are as follows:

- **Lower:** Indicates the frequency range from center to the lower frequency at which the power level drops to x dBm.
- **Higher:** Indicates the frequency range from center to the higher frequency at which power level drops to x dBm.
- **Both:** Indicates the frequency between the upper and the lower crossing thresholds at which the power level drops to x dBm.

Max Hold spectral data

Max Hold displays the maximum value in the acquisition record for each display point. Each new trace display point is compared to the previous maximum value and the greater value is retained for display and subsequent comparisons.

Freq & RBW tab - Bluetooth

The Freq & RBW tab allows you to specify the bandwidth parameters used for setting measurement bandwidth in the BT 20dB BW display. This determines what acquisition bandwidth the measurement will request.

Setting	Description
Meas Freq	Specifies the measurement frequency.
RBW	Select Auto or Manual. Adjusts the resolution bandwidth for the entire measurement. This setting is independent of the Spectrum display's RBW setting.
Step	Sets the increment/decrement size for the adjustment of the center frequency. If Auto is enabled, the analyzer will adjust the step size as required.
VBW	Adjusts the video bandwidth.

Measurement Params tab - Bluetooth

The Measurement Params tab is only available for the BT InBand Emission display. It allows you to select the average domain.

Setting	Description
Average	Specify the average domain (Time Domain, Frequency Domain) or set Average to Off. If a domain is selected, then you can also specify the number.
Number	Specify the number value associated with the Average setting.

Overview

Audio Analysis (Option SVA) measures basic time- and frequency-domain parameters of analog audio signals modulated on a carrier (AM, FM and PM modulation) or unmodulated (non-carrier) audio signals (Direct).

For modulated signals, the measurement analysis first demodulates the signal to provide the *Audio signal* waveform. Direct input signals bypass the demodulation step. For FM and PM demodulation, the carrier frequency error is estimated during demodulation.

The Audio signal waveform excursions are then measured to determine the Peak and RMS waveform parameters. Next, the analysis detects the highest-amplitude frequency component within the audio bandwidth, and makes a high-accuracy frequency measurement of the frequency component. This value is called the *Audio Frequency*.

A spectral analysis of the Audio signal waveform is performed to determine the presence and level of harmonically- and/or non-harmonically-related narrowband spurs and wideband noise. The Audio signal, harmonic and non-harmonic spurs, and noise level data are combined to produce signal summary parameters including SINAD, Modulation Distortion, Signal-to-Noise, Total Harmonic Distortion, and Total Non-Harmonic Distortion.

Controls are provided to allow the user to select audio filters of Low Pass, High Pass, FM De-emphasis, or Standard-defined response, as well as completely user-definable filter response. Filtering can be applied as needed to modify the audio spectrum result before measurement to remove unwanted spurs or noise.

Flexible control parameters are provided to allow setting the Audio Bandwidth for analysis, the Resolution Bandwidth (RBW) and RBW filter type of the spectral analysis, and number and level qualifications for Harmonic and Non-harmonic spur detection. Multiple-spectrum averaging can be enabled to provide a smoothed spectrum for results with less variability than single-spectrum results.

The Audio Spectrum display shows the frequency spectrum waveform with detected harmonic and non-harmonic components identified by markers, and a corresponding table of frequency and level values for the spur components. The markers and table provide easy visualization of the significant spurs and their relation to the fundamental Audio frequency signal.

Audio Spectrum Display

The Audio Spectrum display shows audio modulation characteristics. You can choose to show just the spectrum of the audio signal or show the audio spectrum of the signal and the results of distortion measurements. The Audio Spectrum display can show a table listing the frequency of a Harmonic Distortion (HD) and Non-Harmonic Distortion (NHD) and its level. The Spectrum graph indicates these harmonics and non-harmonics with special markers.

To display the Audio Spectrum display:

1. Press the **Displays** button or select **Setup > Displays**. This shows the **Select Displays** dialog box.
2. From the **Measurements** box, select **Audio Analysis**.

3. Double-click the **Audio Spectrum** icon in the **Available Displays** box. This adds the Audio Spectrum icon to the **Selected displays** box.
4. Click the **OK** button. This shows the Audio Spectrum display.

Elements of the Audio Spectrum Display

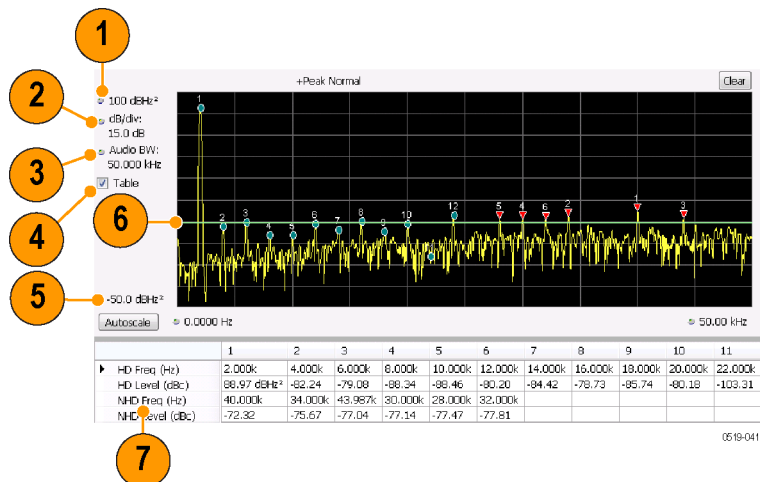

Item	Display element	Description
1	Vertical position	Sets the top of graph value.
2	dB/div	Sets the vertical scale value. The maximum value is 20.00 dB/division.
3	Audio BW	Specifies the measurement bandwidth of the Audio Spectrum display, which in turn can influence the acquisition bandwidth.
4	Table	Displays a table that shows the distortion measurement results and displays indicators on the graph that highlight the location of the harmonics on the trace.
5	Bottom of graph readout	Displays the bottom of graph value.
6	Non-harmonic threshold indicator	Displays the threshold for detecting non-harmonic components.
7	Analysis results	Display of the audio analysis results.

Audio Spectrum Settings

Main menu bar: Setup > Settings

Favorites toolbar: 

The measurement settings for the Audio Spectrum display are shown in the following table.

Settings tab	Description
Params1 Tab (see page 447)	Specifies signal type, Audio Bandwidth, RBW, RBW filter, and Ref Audio Frequency.
Params2 Tab (see page 450)	Specifies Harmonics and Non-Harmonics measurement parameters.
Audio Filters Tab (see page 450)	Specifies the audio filter characteristics.
Scale Tab (see page 139)	Sets vertical and horizontal scale and position parameters.
Prefs Tab (see page 456)	Specifies vertical units, and whether on not some features are displayed in the graph.

Audio Summary Display

To display the Audio Summary display:

1. Press the **Displays** button or select **Setup > Displays**. This shows the **Select Displays** dialog box.
2. From the **Measurements** box, select **Audio Analysis**.
3. Double-click the **Audio Summary** icon in the **Available Displays** box. This adds the Audio Summary icon to the **Selected displays** box.
4. Click the **OK** button. This shows the Audio Summary display.

The Audio Summary Display

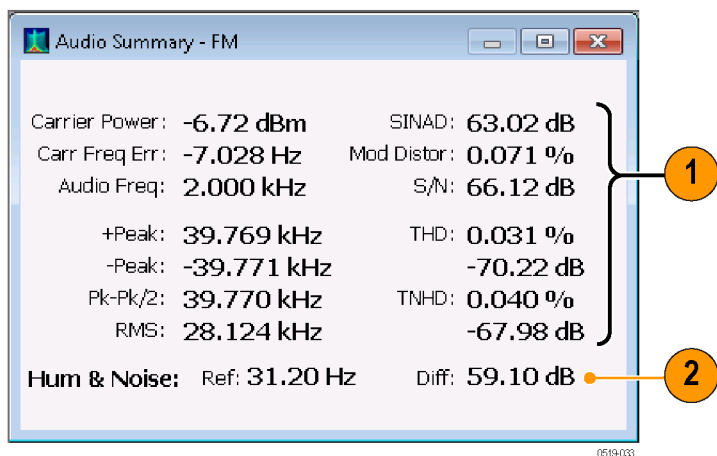

Item	Display element	Description
1	Measurement results	Measurement results are displayed in this area. The displayed measurements vary with signal type.
2	Hum & Noise results	Hum & Noise analysis readout. Hum & Noise appears only when enabled on the Hum & Noise tab

Audio Summary Displayed Measurements

Table 8: Audio Summary Measurements

Signal type	Item	Description
AM, FM, PM	Carrier Power	Average power of the carrier signal with modulation removed.
Direct	Signal Power	Average power of the input signal
FM, PM	Carr Freq Err	Carrier frequency error
AM, FM, PM, Direct	Audio Freq	Fundamental audio frequency
	+Peak	+Peak modulation excursion (where the modulation excursion readout depends on the signal type) ¹
	-Peak	-Peak modulation excursion (where the modulation excursion readout depends on the signal type) ¹
	Peak-Peak/2	Half peak-peak modulation excursion (where the modulation excursion readout depends on the signal type) ¹
	RMS	RMS modulation excursion (where the modulation excursion readout depends on the signal type) ¹
	SINAD	Signal to noise and distortion
	Mod Distor	Modulation distortion
	S/N	An estimate of the Signal level to Noise (only level, with the HD and NHD components removed)
	THD	Total harmonic distortion
	TNHD	Total non-harmonic distortion
	Ref	Ref is the RMS modulation value stored when the Capture Reference button is pressed. (Displayed only when Hum & Noise is enabled.)
	Diff	Diff is the difference between the current RMS mod value and the Ref value captured previously. (Displayed only when Hum & Noise is enabled.)

¹ For AM signal types, modulation excursion is "% Modulation Depth". For FM signal types, modulation excursion is "Frequency Deviation". For PM signal types, modulation excursion is "Phase Deviation". For Direct, there is no modulation excursion, it is actually "signal excursion".

Audio Summary Settings

Main menu bar: Setup > Settings

Favorites toolbar: 

The measurement settings for the Audio Summary display are shown in the following table.

Settings tab	Description
Params1 Tab (see page 447)	Specifies signal type, Audio Bandwidth, RBW, RBW filter, and Ref Audio Frequency.
Params2 Tab (see page 450)	Specifies Harmonics and Non-Harmonics measurement parameters.
Audio Filters Tab (see page 450)	Specifies the audio filter characteristics.
Hum Noise Tab (see page 455)	Specifies whether or not Hum & Noise is measured and enables the capture of a signal to be used as a reference of the Hum & Noise measurement.

Audio Analysis Measurement Settings

The control panel tabs in this section are shared by the displays in the Audio Analysis folder (Setup > Displays).

Common controls for Audio Analysis displays

Settings tab	Description
Params1 Tab (see page 447)	Specifies characteristics about the audio signal and how measurements are made.
Params2 Tab (see page 450)	Specifies parameters that control how measurements are made on harmonics.
Audio Filters Tab (see page 450)	Specifies characteristics of filters applied to the signal before measurements are taken.
Scale Tab (see page 139)	Sets vertical and horizontal scale and position parameters.
Prefs Tab for Audio Analysis (see page 456)	The Prefs tab enables you to change appearance characteristics of the Audio Analysis displays.

Params1 Tab

The Params1 tab is used to specify characteristics of the audio signal to be measured and how the signal will be measured.

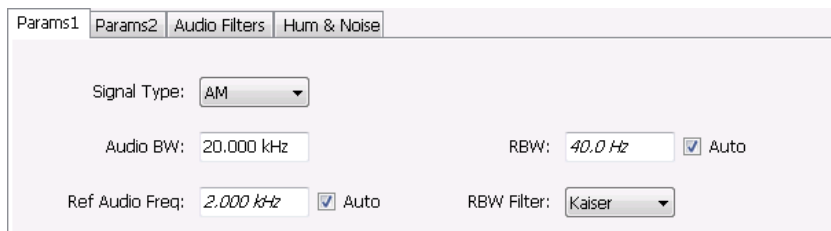

Params1 tab for AM signal types

Setting	Description
Signal Type	Specifies the type of signal to be analyzed. The available choices are AM, FM, PM, and Direct.
Audio BW	Specifies the bandwidth used for audio analysis.
Ref Audio Freq	A measured value when Auto is selected. If you want to specify the reference audio frequency, uncheck Auto and enter a value manually. If Ref Audio Freq is set manually, be aware that the automated detection is still performed, but it is limited to a frequency range of $\pm 1\%$ of the Audio BW centered around the manually specified value.
Carrier Freq Error / Carrier Freq Offset	(FM and PM only) A measured value, when Auto is selected. If Auto is unchecked, you can specify the Carrier Frequency Offset.
RBW	Displays the Resolution Bandwidth for Audio measurements. This value is automatically set by default to 1/500 of the measurement bandwidth. To manually specify the RBW, uncheck Auto. The minimum RBW value is limited to the larger of 1 Hz or AudioBW/10000. The maximum is limited to AudioBW/100.
RBW Filter	Specifies the windowing method used for the transform.

Setting Frequency for Direct Signal Types

Direct (unmodulated) signal analysis is only possible with the instrument Frequency control set to 0 Hz. You will receive a warning to set Frequency to 0 Hz when Direct signal type is selected, if you haven't already done so. Modulated signal types may be selected with Frequency set to 0 Hz, but results are not meaningful in that case. For modulated signals, Frequency should always be set to a value \geq Audio Bandwidth to avoid self-interference of the signal due to spectral folding.

Setting Audio Bandwidth

For AM, FM and PM, the Audio Bandwidth control sets not only the demodulated signal bandwidth, but also determines the pre-demodulation bandwidth. Set it to a value at least half the pre-demodulation signal bandwidth, as in this equation:

$$\text{Audio BW} \geq \text{Signal Bandwidth} / 2$$

NOTE. When performing audio analysis, you should allow the Audio BW control to automatically set the acquisition bandwidth, rather than manually adjusting the Acq BW control on the Sampling Parameters tab of the Acquire control panel. The audio measurement will cause the Acq BW setting to be \geq Audio BW (Direct) or $\geq 2 \times$ Audio BW (AM, FM, PM).

For Direct signals, set Audio Bandwidth large enough to include any significant harmonics/non-harmonics or other signal component of interest. For example, to measure up to the 10th harmonic of a signal with a 5 kHz fundamental component, set Audio Bandwidth to $10 \times 5 \text{ kHz} = 50 \text{ kHz}$.

For modulated signals, Audio Bandwidth must be set wide enough to include all significant signal modulation components in addition to the desired audio analysis bandwidth. For AM this is similar to Direct. For example, to measure up to the 10th harmonic of an AM signal with 3 kHz fundamental component, set Audio Bandwidth to $10 \times 3 \text{ kHz} = 30 \text{ kHz}$. This ensures that the bandwidth of the data provided by the system to the measurement will be at least of 60 kHz ($2 \times 30 \text{ kHz}$) which is sufficient for this signal and analysis requirement.

FM and PM are more complex. For FM, the analysis bandwidth needs to be at least twice as wide as the sum of peak Frequency Deviation and the Fundamental Frequency (Carson's rule). This is a parallel condition along with setting Audio Bandwidth large enough for the maximum audio bandwidth to analyze. Therefore, for FM, Audio Bandwidth should be:

$$\text{AudioBW (FM)} = \text{MAX}(\text{MaxAudioAnalysisFreq}, \text{FreqDeviation} + \text{FundamentalFreq})$$

where MaxAudioAnalysisFreq is the highest audio frequency desired in the analysis. For example, for an FM signal with fundamental signal of 5 kHz and peak frequency deviation (one-sided) of 10 kHz, Acquisition Bandwidth should be at least $(2 \times (10\text{k} + 5\text{k})) = 30\text{ kHz}$, or an Audio Bandwidth of 15 kHz. Also if the analysis should extend to the 8th harmonic, then the Audio Bandwidth needs to be at least $8 \times 5\text{ kHz} = 40\text{ kHz}$. So Audio Bandwidth should be set to 40 kHz. Using the equation:

$$\text{AudioBW(FM)} = \text{MAX}(8 \times 5\text{kHz}, (10 + 5)\text{kHz}) = \text{MAX}(40\text{ kHz}, 15\text{kHz}) = 40\text{ kHz}$$

The formula for PM is:

$$\text{AudioBW (PM)} = \text{MAX}(\text{MaxAudioAnalysisFreq}, \text{PMFreqDeviation} + \text{FundamentalFreq})$$

where

$$\text{PMFreqDeviation} = \text{PMPhaseDeviationInRadians} \times \text{FundamentalFreq}$$

RBW Filter Shape

Select Kaiser in most cases for best measurement performance. Select Flattop only if you want to use standard markers to measure signal amplitude with highest accuracy.

Params2 Tab

The Params2 tab is used to specify how the signal harmonics are measured and to control spectrum averaging.

The screenshot shows the Params2 tab with the following settings:

- No. of Harmonics: 12
- No. of Non-Harmonics: 12
- Averaging: 10
- Non-Harmonics only:
 - Ignore region: 0.0 Hz
 - Threshold: -65.0 dBc
 - Excursion: 6.0 dB

Setting	Description
No. of Harmonics	Specifies the number of harmonics to detect. The detected harmonics are tagged with a number on the spectrum trace. The available range is 1–20.
No. of Non-Harmonics	Specifies the number of non-harmonics to detect. The detected non-harmonics are tagged with a number on the spectrum trace. The available range is 0–20.
Averaging	Specifies the number of averages used to compute the results. Range: 2–100.
Ignore region	Specifies the region about the signal frequency where the instrument will ignore non-harmonics.
Non-Harmonic Threshold	Specifies the level which a spectrum peak must exceed to be declared a non-harmonic signal component.
Non-Harmonic Excursion	Specifies the difference in level between a spectrum peak and the average noise level that must be exceeded for the peak to be declared a non-harmonic signal component.

About Averaging In Audio Analysis Displays

Analysis averaging is implemented using a “block” method. This means that the entire record required for multiple spectrum computations is acquired and analyzed within one analysis cycle. The result of each analysis update is a complete, independent result from a set of N spectrums averaged together, where N is the Averaging control value. Since each update is a fully averaged result, no partially averaged results are output before a final result is available, so each output is fully valid. However, with large Averaging values, acquisition record sizes and measurement times may become large, so care should be taken to select the minimum amount of averaging needed.

Audio Filters Tab

The Audio Filters tab is used to specify filters to be applied to the acquired audio signal before measurements are taken. You can select from pre-defined filters or use a filter you define in a text file. You can also specify the de-emphasis time constant applied to the audio signal and the telecom weighting filters used to measure noise.



Pre-defined Filters

You can specify low-pass filter (LPF) and high-pass filter (HPF) settings, a de-emphasis time constant and/or a telecom weighting filter to match the response of your receiver. Alternatively, you can create a text file to specify the frequency response points.

To use pre-defined filters:

1. Select the **Pre-defined Filters** option button.
2. Select the LPF, HPF, De-emphasis and Standard check boxes as appropriate.
3. Select the desired filter parameter from the drop-down list for each of the enabled filters or select User from the list if you wish to use a custom value. For LPF and HPF, the listed frequencies represent the 3dB cutoff point of the filter.
4. If you select **User** from the drop-down list, enter a value in the text entry box that appears.

To disable all filtering:

1. Select the **Pre-defined Filters** option button.
2. Deselect all four filter check boxes.

Table 9: Predefined audio filters

Filter type	Available settings
LPF (Low Pass Filter) (5th-order Butterworth response)	300 Hz
	3 kHz
	15 kHz
	30 kHz
	80 kHz
	300 kHz
	User ¹
HPF (High Pass Filter) (5th-order Butterworth response)	20 Hz
	50 Hz
	300 Hz
	400 Hz
	User ¹

Table 9: Predefined audio filters (cont.)

Filter type	Available settings
De-emphasis (FM only)	25 μ s
	50 μ s
	75 μ s
	750 μ s
	User. Range: 25 μ s to 10 ms
Standard	CCITT
	C-message

¹ User-entered values are restricted to maximum of 0.9 * Audio BW, and will automatically adjust downward to meet this limit (if required) when AudioBW is decreased.

Standard. Use this setting to specify the telecom weighting filter. The characteristics of these filters are described in ITU-T Recommendation O.41, Psophometer for Use on Telephone-type Circuits.

Using Custom Audio Filters

If you want to use audio filters that have a different response shape than the pre-defined filters, you can create a custom audio filter using a text or CSV file to specify the desired filter frequency response.

To use a custom audio filter:

1. Verify that Audio Spectrum or Audio Summary is the selected display.
2. Click the Settings icon or select **Setup > Settings**.
3. Select the **Audio Filters** tab.
4. Click the **File** button.
5. Click the ... button and navigate to the location of the custom audio filter file you wish to use. Select the file you want to use and click Open.
6. Acquire a new trace or replay a saved file to see the effect of the custom filter.

Creating a Custom Audio Filter. A custom audio filter file is either a plain text file or a CSV format file. The file contains frequency (in Hz) and amplitude (in dB) value pairs which specify the filter frequency response shape. Each pair must be on a separate line. The filter response between the points is interpolated using a cubic spline fit.

The following table shows the first few lines of a custom audio filter text file.

0,	-100
16.66,	-85
50,	-63
100,	-41
200,	-21
300,	-10.6

400,	-6.3
500,	-3.6
600,	-2
700,	-0.9
800,	0
...	...

Format and rule-checking on custom audio filter files is performed as follows:

- The maximum number of frequency and amplitude pairs is 1000.
- Column 1 (frequency values in Hertz).
 - Non-negative values only (zero is allowed).
 - Strictly increasing order of frequencies (frequency value on each line > frequency value on previous line).
 - There is no upper limit on the frequency value.
- Column 2 (amplitude values in dB units, where gain is a positive value and attenuation is a negative value).
 - Values are restricted to the range -200 to +20 dB.

Scale Tab

The Scale tab allows you to change the vertical and horizontal scale settings. Changing the scale settings changes how the trace appears on the display but does not change acquisition control settings. In effect, these controls operate like pan and zoom controls.



Setting	Description
Vertical	
Scale	Changes the range shown between the top and bottom of the graph.
Position	Adjusts the level shown at the top of the graph for linear units or the top of the graph for log units (for example, dBm).
Autoscale	Resets the Position so that the highest trace points are in the graph. For linear units (Volts, Watts), the Autoscale also adjusts Scale.
Horizontal	
Left	Changes the frequency shown at the left side of the graph.
Right	Changes the frequency shown at the right side of the graph.
Autoscale	Resets the Left and Right settings to show the entire trace.
Log	Sets the graph horizontal axis to a logarithmic scale.
Reset Scale	Resets the Vertical and Horizontal settings to their default values.

Hum & Noise Tab

Hum & Noise (available only when the Audio Summary display is the active display) is useful for comparing residual power or modulation if the Ref value is captured when the Signal is On (Direct) or modulated (AM/FM/PM). When the signal is turned off (Direct) or modulation turned off (AM/FM/PM), Diff indicates how much residual Hum and Noise are still present in the measurement value.

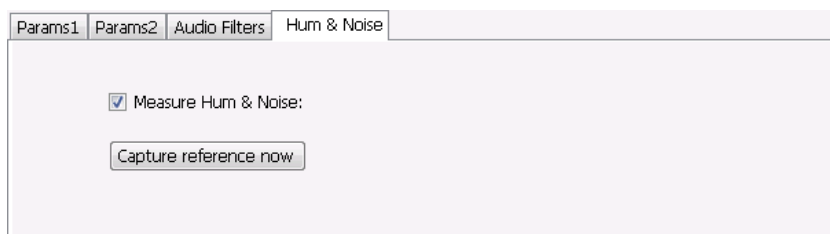

To display Hum & Noise measurement:

1. Select **Setup > Displays**.
2. In the Select Displays window, select the **Audio Analysis** folder.
3. Double-click the **Audio Summary** icon so that it appears in the **Selected displays** box.
4. Click **OK**
5. With the Audio Summary display selected, select **Setup > Settings**.
6. Select the **Hum & Noise** tab. Click on the **Measure Hum & Noise** checkbox so that it is checked.
The Hum & Noise values appear at the bottom list of measurements in the Audio Summary display.
7. Acquire an appropriate signal.
8. While the analyzer is analyzing a signal you want to use as a reference, click the **Capture reference now** button to save a reference value.

The Hum & Noise measurement compares the value of a specific signal quantity captured by the **Capture reference now** button with the current measured value of that quantity. For Direct signal types (set on the Params1 tab), the Signal Level is captured and compared. The Diff measurement is:

$$\text{SignalLevel}(\text{current}) - \text{SignalLevel}(\text{Ref})$$

in dB.

For AM, FM, and PM signal types, the RMS modulation value (related to Modulation Depth, Frequency Deviation or Phase Deviation) is captured and compared. The Diff measurement is:

$$20 \times \log_{10}(\text{RMS}(\text{current})/\text{RMS}(\text{Ref}))$$

in dB.

Prefs Tab

The Prefs tab enables you to change appearance characteristics of the Audio Spectrum display.

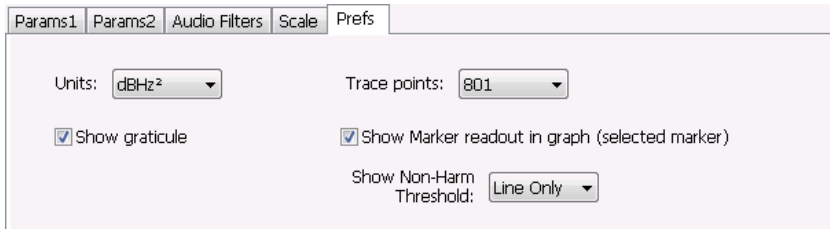

Setting	Description
Units:	Specifies the vertical scale units. The units available depend on the signal type selected.
Show graticule	Select to display or hide the graticule.
Trace points	Sets the number of trace points used for marker measurements and for results export.
Show Marker readout in graph (selected marker)	Shows or hides the readout for the selected marker in the graph area.
Show Non-Harm Threshold	Shows or hides the non-harmonic threshold line.

Overview

The displays in General Purpose (GP) Digital Modulation (Displays > Measurements > GP Digital Modulation) are:

- Constellation
- Demod I & Q vs Time
- EVM vs Time
- Eye Diagram
- Frequency Deviation vs Time
- Magnitude Error vs Time
- Phase Error vs Time
- Signal Quality
- Symbol Table
- Trellis Diagram

The General Purpose Digital Modulation Analysis (Option 21) provides vector signal analyzer functionality. A wide variety of modulation types are supported, allowing you to view your signals in Constellation, Eye and Trellis diagrams, measure the quality of the modulation, display time-domain waveforms for demodulated I & Q signals, EVM, Phase Error, Magnitude Error, and more.

Modulation Measurements

NOTE. *A maximum of approximately 163,800 samples can be analyzed by the General Purpose Digital Modulation measurements (the actual value varies with modulation type).*

Measurement	Description
EVM	The normalized RMS value of the error vector between the measured signal and the ideal reference signal over the analysis length. The EVM is generally measured on symbol or chip instants and can be reported in units of percent or dB. EVM is usually measured after best-fit estimates of the frequency error and a fixed phase offset have been removed.
Phase Error	The RMS phase difference between the measured signal and the ideal reference signal.
Magnitude Error	The RMS magnitude difference between the measured signal and the ideal reference signal.
IQ Origin Offset	The magnitude of the DC offset of the signal measured at the symbol times. It indicates the magnitude of the carrier feed-through signal.
Gain Imbalance	The gain difference between the I and Q channels in the signal generation path. Constellations with gain imbalance show a pattern with a width that is different from height.
Rho ρ	The normalized correlated power of the measured signal and the ideal reference signal. Like EVM, Rho is a measure of modulation quality. The value of Rho is less than 1 in all practical cases and is equal to 1 for a perfect signal measured in a perfect receiver.
Frequency Error	The frequency difference between the measured carrier frequency of the signal and the user-selected center frequency of the analyzer.
Quadrature Error	The orthogonal error between the I and Q channels. The error shows the phase difference between I and Q channels away from the ideal 90 degrees expected from the perfect I/Q modulation. Constellations with quadrature error will show some leakage of I into Q and vice versa.

Constellation Display

The Constellation Display shows a digitally-modulated signal in constellation form.

To show the Constellation Display:

1. Select the **Displays** button or select **Setup > Displays**. This shows the **Select Displays** dialog box.
2. From the **Measurements** box, select **GP Digital Modulation**.
3. Double-click the **Constellation** icon in the **Available Displays** box. This adds the Constellation icon to the **Selected displays** box.
4. Click the **OK** button. This shows the Constellation display.

Elements of the Constellation Display

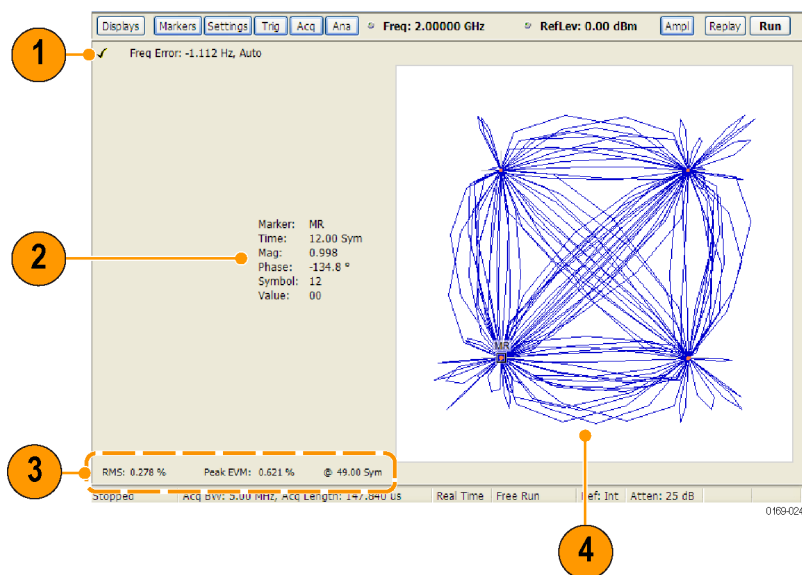

Item	Display element	Description
1	Check mark indicator	The check mark indicator in the upper, left-hand corner of the display shows when the Constellation display is the optimized display. NOTE. When Best for multiple windows is selected in the Amplitude control panel's RF & IF Optimization control, none of the measurement displays shows a checkmark, as there is not a single optimized measurement.
2	Marker Readout	Located to the left of the constellation plot or below it, depending on the size of the window. If markers are enabled, the marker readout shows the time, mag, phase, symbol marker and symbol value of the point with the selected marker.
3	EVM Readouts	The EVM readouts are located below the Constellation plot. The readout shows EVM Peak (%) and location, RMS (%).
4	Plot	Constellation graph.

[Changing Constellation Settings \(see page 459\)](#)

Constellation Settings

Main menu bar: Setup > Settings

Favorites toolbar: 

The settings for the Constellation view are shown in the following table.

NOTE. You might be able to save time configuring the Constellation display by pressing the Standard Settings button from the Settings control panel. This allows you to select a preset optimized for a standard from the Select Standard dialog box. See [Standard Settings Button](#). (see page 482)

Settings tab	Description
Modulation Params (see page 483)	Specifies the type of modulation, symbol rate, and filters to be used in demodulating the input signal.
Freq & BW (see page 487)	Sets values for frequency error/offset, measurement bandwidth, and frequency deviation (not every control is present for every modulation type).
Equalizer Tab (see page 489)	Enable the Equalizer and adjust its parameters.
Advanced Params (see page 491)	Specifies additional parameters that are less frequently used.
Find (see page 494)	Used to set parameters for finding a burst within the data record and for entering a Synch word.
Analysis Time (see page 494)	Contains parameters that define the portion of the acquisition record that is used for analysis. Also allows you to specify the Units (Seconds or Symbols) for the GP Digital Modulation displays.
Trace (see page 496)	Allows you to set the trace display characteristics.
Prefs (see page 498)	Enables you to set characteristics of the measurement display.

Demod I & Q vs Time Display

The Demod I & Q vs Time displays demodulated I and Q vs. Time. You can choose to display I only, Q only, or both.

Elements of the Display

To show the Demod I & Q vs Time display:

1. Select the **Displays** button or select **Setup > Displays**. This shows the **Select Displays** dialog box.
2. From the **Measurements** box, select **GP Digital Modulation**.
3. Double-click the **Demod I&Q vs Time** icon in the **Available Displays** box. This adds the Demod I&Q vs Time icon to the **Selected displays** box.
4. Click the **OK** button. This shows the Demod I&Q vs Time display.

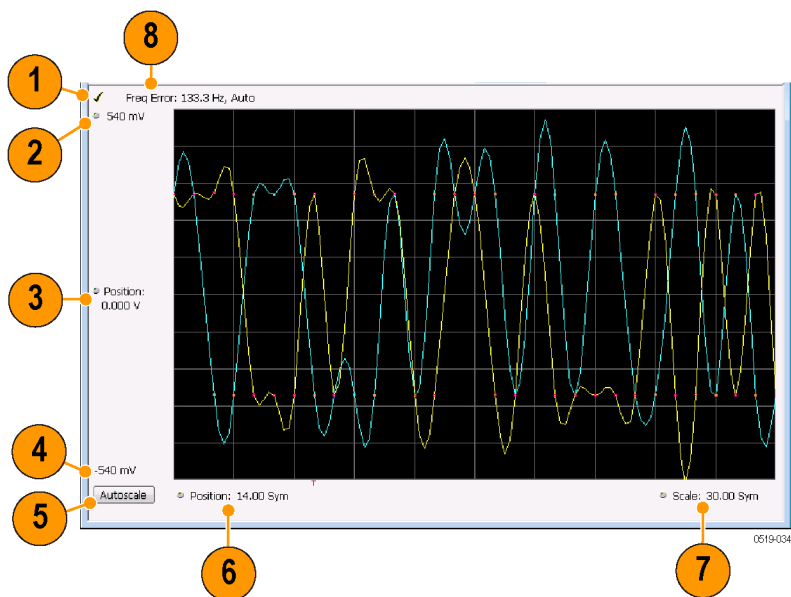

Item	Element	Description
1	Check mark indicator	The check mark indicator in the upper, left-hand corner of the display shows when the Demod I & Q vs Time display is the optimized display. NOTE. When Best for multiple windows is selected in the Amplitude control panel's RF & IF Optimization control, none of the measurement displays shows a checkmark, as there is not a single optimized measurement.
2	Top of Graph	Sets the I and Q amplitude value indicated at the top of the graph. Changing the top value affects the bottom of graph readout. Also, note that the top of graph setting interacts with the internal vertical scale setting (which is not user settable) such that the range between the top and bottom of the graph increases or decreases automatically.
3	Position	Specifies the I and Q amplitude value shown at the center of the graph display.
4	Bottom Readout	Displays the I and Q amplitude value shown at the bottom of graph.
5	Autoscale	Adjusts the vertical and horizontal settings to provide the best display.
6	Position	Specifies the horizontal position of the trace on the graph display.
7	Scale	Adjusts the span of the graph. By decreasing the scale (time per division), the graph essentially becomes a window that you can move over the acquisition record by adjusting the offset.
8	Freq Error	This readout can show Freq Error or Freq Offset. When it displays Freq Error, it shows the difference between the instrument Frequency setting and the measured value of the signal's carrier frequency. When it displays Freq Offset, it shows the frequency offset specified on the Settings > Freq & BW (see page 487) tab. If Freq Error is displayed, it also indicates that the Carrier frequency detection setting is Auto. If Freq Offset is displayed, it indicates that the Carrier frequency detection setting is manual.

[Changing Demod I&Q Settings. \(see page 462\)](#)

Demod I & Q vs Time Settings

Main menu bar: Setup > Settings

Favorites toolbar: 

The settings for the Demod I & Q vs Time display are shown in the following table.

NOTE. You might be able to save time configuring the Demod I & Q display by pressing the Standard Settings button from the Settings control panel. This allows you to select a preset optimized for a standard from the Select Standard dialog box. See [Standard Settings Button. \(see page 482\)](#)

Settings tab	Description
Modulation Params (see page 483)	Specifies the type of modulation used for the input signal and other parameters.
Freq & BW (see page 487)	Specifies settings for frequency error, measurement BW and Frequency Deviation. Each of these settings is set internally when set to Auto. Alternatively, you can specify values appropriate for specific measurement needs.
Equalizer Tab (see page 489)	Enable the Equalizer and adjust its parameters.
Advanced Params (see page 491)	Specifies additional parameters.
Find (see page 494)	Used to set parameters for finding a burst within the data record and for entering a Synch word.
Analysis Time (see page 494)	Contains parameters that define the portion of the acquisition record that is used for analysis. Also allows you to specify the Units (Seconds or Symbols) for the GP Digital Modulation displays.
Trace (see page 496)	Allows you to set the trace display characteristics.
Scale (see page 498)	Specifies the horizontal and vertical scale settings.
Prefs (see page 498)	Enables you to set characteristics of the measurement display.

EVM vs Time Display

The EVM vs. Time Display shows the Error Vector Magnitude plotted over Time.

NOTE. A maximum of approximately 80,000 samples can be analyzed by the General Purpose Digital Modulation measurements (the actual value varies with modulation type).

To show an EVM vs. Time display:

1. Press the **Displays** button or select **Setup > Displays**. This shows the **Select Displays** dialog box.
2. From the **Measurements** box, select **GP Digital Modulation**.
3. Double-click the **EVM vs. Time** icon in the **Available Displays** box. This adds the EVM vs. Time icon to the **Selected displays** box.
4. Click the **OK** button. This displays the EVM vs. Time view.

Elements of the EVM vs Time Display

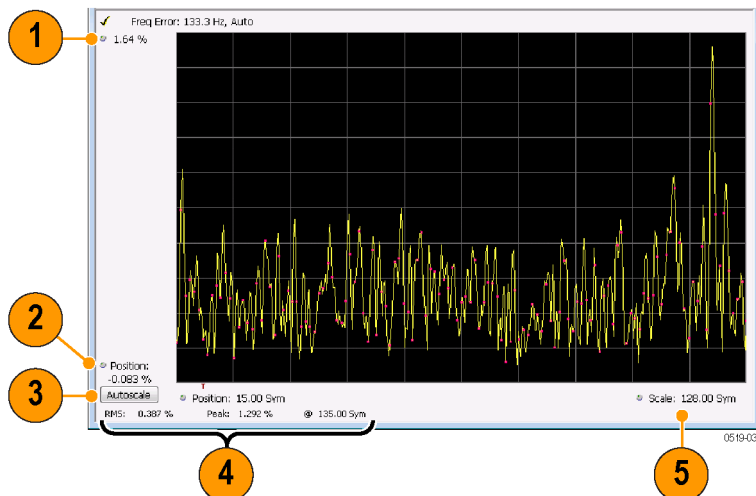

Item	Display element	Description
1	Top of graph adjustment	Use the knob to adjust the vertical scale.
2	Position	Adjusts the vertical position.
3	Autoscale	Adjusts the Horizontal and Vertical scale to show the entire trace.
4	Peak and RMS value readout	Shows the maximum result, the time it occurred, and the RMS of the result over the entire analysis length.
5	Scale	Sets the length of time shown in the graph.

[Changing the EVM vs Time Display Settings \(see page 463\)](#)

EVM vs Time Settings

Main menu bar: Setup > Settings

Favorites toolbar: 

The settings for the EVM vs. Time display are shown in the following table.

NOTE. You might be able to save time configuring the EVM vs. Time display by pressing the Standard Settings button from the Settings control panel. This allows you to select a preset optimized for a standard from the Select Standard dialog box. See [Standard Settings Button.](#) (see page 482)

Settings tab	Description
Modulation Params (see page 483)	Specifies the type of modulation used in the input signal and other parameters that controls the demodulation of the input signal.
Freq & BW (see page 487)	Specifies settings for frequency error, measurement BW and Frequency Deviation. Each of these settings is set internally when set to Auto. Alternatively, you can specify values appropriate for specific measurement needs.
Equalizer Tab (see page 489)	Enable the Equalizer and adjust its parameters.
Advanced Params (see page 491)	Specifies Freq Offset, Magnitude normalization parameters, and enables swapping I and Q.
Find (see page 494)	The Find tab is used to set parameters for finding bursts within the data record.
Analysis Time (see page 494)	The Analysis Time tab contains parameters that define how the signal is analyzed in the general purpose digital modulation displays.
Trace (see page 496)	Specifies the display characteristics of the displayed trace.
Scale (see page 498)	Specifies the horizontal and vertical scale settings.
Prefs (see page 498)	Specifies whether certain display elements are visible.

Eye Diagram Display

The Eye Diagram Display shows a digitally modulated signal overlapped on itself to reveal variations in the signal.

To show an Eye Diagram display:

1. Press the **Displays** button or select **Setup > Displays**. This shows the **Select Displays** dialog box.
2. From the **Measurements** box, select **GP Digital Modulation**.
3. Double-click the **Eye Diagram** icon in the **Available Displays** box. This adds the Eye Diagram icon to the **Selected displays** box.
4. Click the **OK** button. This displays the Eye Diagram view.

Elements of the Display

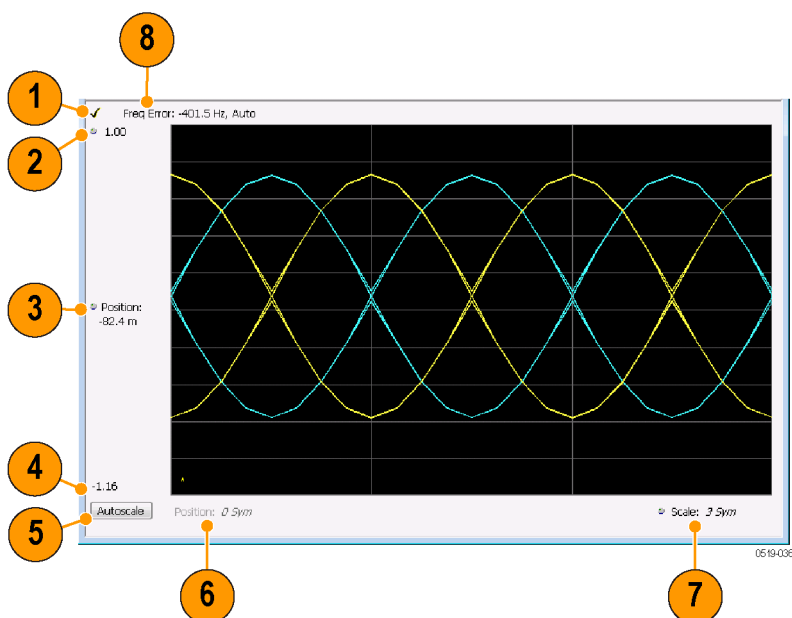

Item	Element	Description
1	Check mark indicator	The check mark indicator in the upper, left-hand corner of the display shows when the Frequency Deviation vs Time display is the optimized display. NOTE. When Best for multiple windows is selected in the Amplitude control panel's RF & IF Optimization control, none of the measurement displays shows a checkmark, as there is not a single optimized measurement.
2	Top of Graph	The vertical scale is normalized with no units (except for nFSK and C4FM modulation types where the vertical units are Hz).
3	Position	Specifies the value shown at the center of the graph display.
4	Bottom Readout	Displays the value indicated by the bottom of graph.
5	Autoscale	Adjusts the vertical and horizontal settings to provide the best display.
6	Position	Displays the horizontal position of the trace on the graph display.
7	Scale	Adjusts the span of the graph in symbols.
8	Freq Error	Displays the difference between the maximum and minimum measured values of the signal frequency during the Measurement Time. The displayed frequency error is followed by either Auto or Manual . This indicates the selected carrier frequency detection method (see Settings > Freq & BW).

[Changing Eye Diagram Settings \(see page 466\)](#)

Eye Diagram Settings

Main menu bar: Setup > Settings

Favorites toolbar: 

The settings for the Eye Diagram display are shown in the following table.

NOTE. You might be able to save time configuring the Eye Diagram display by pressing the Standard Settings button from the Settings control panel. This allows you to select a preset optimized for a standard from the Select Standard dialog box. See [Standard Settings Button. \(see page 482\)](#)

Settings tab	Description
Modulation Params (see page 483)	Specifies the type of modulation used for the input signal and other parameters.
Freq & BW (see page 487)	Specifies settings for frequency error, measurement BW and Frequency Deviation. Each of these settings is set internally when set to Auto. Alternatively, you can specify values appropriate for specific measurement needs.
Advanced Params (see page 491)	Specifies additional parameters.
Find (see page 494)	Used to set parameters for finding a burst within the data record and for entering a Synch word.
Analysis Time (see page 494)	Contains parameters that define the portion of the acquisition record that is used for analysis. Also allows you to specify the Units (Seconds or Symbols) for the GP Digital Modulation displays.
Trace (see page 496)	Allows you to set the trace display characteristics.
Scale (see page 498)	Specifies the horizontal and vertical scale settings.
Prefs (see page 498)	Enables you to set characteristics of the measurement display.

Frequency Deviation vs Time Display

To show a Frequency Deviation vs Time display:

1. Press the **Displays** button or select **Setup > Displays**. This shows the **Select Displays** dialog box.
2. From the **Measurements** box, select **Frequency Deviation vs Time**.
3. Double-click the **Frequency Deviation vs Time** icon in the **Available Displays** box. This adds the Frequency Deviation vs Time icon to the **Selected displays** box.
4. Click the **OK** button. This displays the Frequency Deviation vs Time view.

Elements of the Display



Item	Element	Description
1	Check mark indicator	The check mark indicator in the upper, left-hand corner of the display shows when the Frequency Deviation vs Time display is the optimized display. NOTE. When Best for multiple windows is selected in the Amplitude control panel's RF & IF Optimization control, none of the measurement displays shows a checkmark, as there is not a single optimized measurement.
2	Top of Graph	Sets the frequency deviation value indicated at the top of the graph. Changing the top value affects the bottom of graph readout. Also, note that the top of graph setting interacts with the internal vertical scale setting (which is not user settable) such that the range between the top and bottom of the graph increases or decreases automatically.
3	Position	Specifies the frequency deviation value shown at the center of the graph display.
4	Bottom Readout	Displays the value of the frequency deviation value shown at the bottom of graph.
5	Autoscale	Adjusts the vertical and horizontal settings to provide the best display.
6	Position	Specifies the horizontal position of the trace on the graph display.
7	Scale	Adjusts the span of the graph. By decreasing the scale (time per division), the graph essentially becomes a window that you can move over the acquisition record by adjusting the offset.
8	Freq Error	Displays the difference between the maximum and minimum measured values of the signal frequency during the Measurement Time. The displayed frequency error is followed by either Auto or Manual . This indicates the selected carrier frequency detection method (see Settings > Freq & BW).

[Changing Frequency Deviation vs Time Settings \(see page 468\)](#)

Frequency Deviation vs Time Settings

Main menu bar: Setup > Settings

Favorites toolbar: 

The Setup settings for Frequency Deviation vs. Time are shown in the following table.

NOTE. You might be able to save time configuring the Frequency vs. Time display by pressing the Standard Settings button from the Settings control panel. This allows you to select a preset optimized for a standard from the Select Standard dialog box. See [Standard Settings Button. \(see page 482\)](#)

Settings tab	Description
Modulation Params (see page 483)	Specifies the type of modulation used for the input signal and other parameters.
Freq & BW (see page 487)	Specifies settings for frequency error, measurement BW and Frequency Deviation. Each of these settings is set internally when set to Auto. Alternatively, you can specify values appropriate for specific measurement needs.
Equalizer Tab (see page 489)	Enable the Equalizer and adjust its parameters.
Advanced Params (see page 491)	Specifies additional parameters.
Find (see page 494)	Used to set parameters for finding a burst within the data record and for entering a Synch word.
Analysis Time (see page 494)	Contains parameters that define the portion of the acquisition record that is used for analysis. Also allows you to specify the Units (Seconds or Symbols) for the GP Digital Modulation displays.
Trace (see page 496)	Allows you to set the trace display characteristics.
Scale (see page 498)	Specifies the horizontal and vertical scale settings.
Prefs (see page 498)	Enables you to set characteristics of the measurement display.

Magnitude Error vs Time Display

The Magnitude Error displays the magnitude of the symbol error. The amplitude appears on the vertical axis while time is plotted along the horizontal axis.

NOTE. A maximum of approximately 80,000 samples can be analyzed by the General Purpose Digital Modulation measurements (the actual value varies with modulation type).

To display Magnitude Error vs. Time:

1. Select the **Displays** button or **Setup > Displays**. This displays the Select Displays dialog box.
2. Select **GP Digital Modulation** in the **Measurements** box.
3. Double-click the **Mag Error vs. Time** icon or select the icon and click **Add**. The icon will appear in the **Selected displays** box and will no longer appear under Available displays.
4. Click **OK**.

Elements of the Display

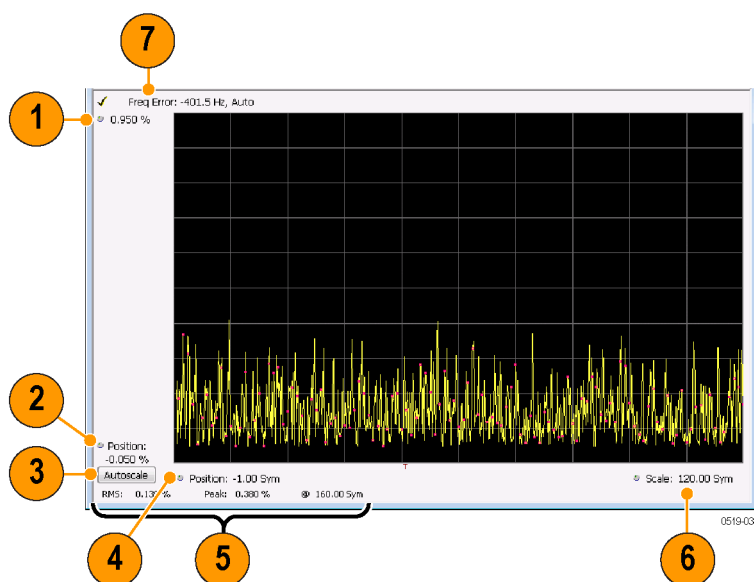

Item	Display element	Description
1	Top of graph adjustment	Use the knob to adjust the value of the vertical scale.
2	Position	Adjusts the level shown at the bottom of the display.
3	Autoscale button	Adjusts the vertical and horizontal settings to provide the best display.
4	Horizontal Position	Adjusts the horizontal position of the signal. Units can be either Symbols or Seconds (Settings > Analysis Time tab > Units).
5	Peak and RMS value readout	Displays the Peak value of the magnitude error, the RMS value of the magnitude error, and the time at which it occurs within the acquisition. Units can be either Symbols or Seconds (Settings > Analysis Time tab > Units).
6	Horizontal Scale	Sets the time spanned by the graph. Units can be either Symbols or Seconds (Settings > Analysis Time tab > Units).
7	Freq Error	Freq Error is the difference between the Center Frequency and the measured frequency of the signal being tested. This readout will be Freq Offset if the Freq Offset parameter on the Settings > Advanced Params (see page 491) tab is set to Manual.

[Changing Magnitude Error vs Time Display Settings \(see page 470\)](#)

Magnitude Error vs Time Settings

Main menu bar: Setup > Settings

Favorites toolbar: 

The Setup settings for Magnitude Errors vs. Time are shown in the following table.

NOTE. You might be able to save time configuring the Magnitude vs. Time display by pressing the Standard Settings button from the Settings control panel. This allows you to select a preset optimized for a standard from the Select Standard dialog box. See [Standard Settings Button. \(see page 482\)](#)

Settings tab	Description
Modulation Params (see page 483)	Specifies the type of modulation used for the input signal and other parameters.
Freq & BW (see page 487)	Specifies settings for frequency error, measurement BW and Frequency Deviation. Each of these settings is set internally when set to Auto. Alternatively, you can specify values appropriate for specific measurement needs.
Equalizer Tab (see page 489)	Enable the Equalizer and adjust its parameters.
Advanced Params (see page 491)	Specifies additional parameters.
Find (see page 494)	Used to set parameters for finding a burst within the data record and for entering a Synch word.
Analysis Time (see page 494)	Contains parameters that define the portion of the acquisition record that is used for analysis. Also allows you to specify the Units (Seconds or Symbols) for the GP Digital Modulation displays.
Trace (see page 496)	Allows you to set the trace display characteristics.
Scale (see page 498)	Specifies the horizontal and vertical scale settings.
Prefs (see page 498)	Enables you to set characteristics of the measurement display.

Phase Error vs Time Display

The Phase Error vs. Time display shows the phase angle of the symbol error over time. The phase is plotted along the vertical axis while time is plotted along the horizontal axis.

NOTE. A maximum of approximately 80,000 samples can be analyzed by the General Purpose Digital Modulation measurements (the actual value varies with modulation type).

To show the Phase Error display:

1. Press the **Displays** button or select **Setup > Displays**.
2. In the **Select Displays** dialog, select **GP Digital Modulation** in the **Measurements** box.
3. In the **Available displays** box, double-click the **Phase Error** icon or select the icon and click **Add**. The Phase Error icon will appear in the **Selected displays** box and will no longer appear under Available displays.
4. Click **OK** to display the Phase Error.

Elements of the Phase Error vs Time Display

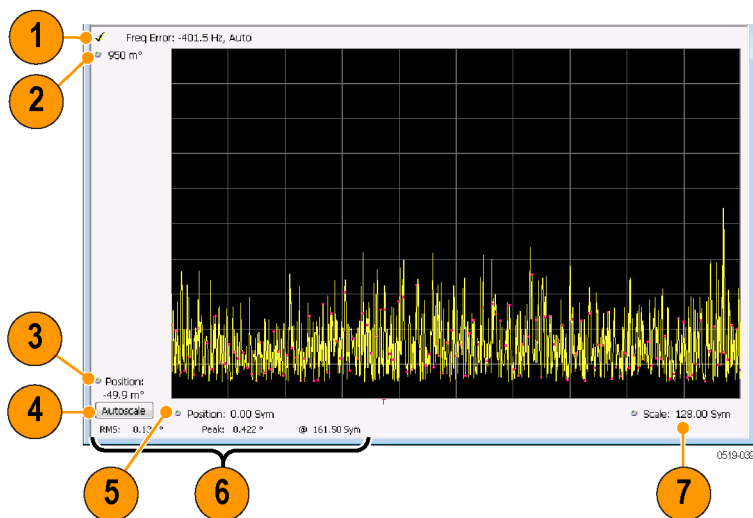

Item	Display element	Description
1	Freq Error	Freq Error is the difference between the Center Frequency and the measured frequency of the signal being tested. This readout will be Freq Offset if the Freq Offset parameter on the Settings > Advanced Params (see page 491) tab is set to Manual.
2	Top of graph adjustment	Adjusts the phase angle shown at the top of the graph.
3	Position	Adjusts the vertical offset.
4	Autoscale	Adjusts the vertical and horizontal settings so that the entire trace fits in the graph.
5	Offset	Adjusts the horizontal offset.
6	Peak and RMS readouts	Displays the Peak value of the phase error and the time at which it occurred. Also displays the RMS value over the analysis length.
7	Scale	Sets the time spanned by the graph.

[Changing the Phase Error vs Time Display Settings \(see page 472\)](#)

Phase Error vs. Time Settings

Main menu bar: Setup > Settings

Favorites toolbar: 

The settings for the Phase Error vs. Time display are shown in the following table.

NOTE. You might be able to save time configuring the Phase Error vs. Time display by pressing the Standard Settings button from the Settings control panel. This allows you to select a preset optimized for a standard from the Select Standard dialog box. See [Standard Settings Button. \(see page 482\)](#)

Settings tab	Description
Modulation Params (see page 483)	Specifies the type of modulation used for the input signal and other parameters.
Freq & BW (see page 487)	Specifies settings for frequency error, measurement BW and Frequency Deviation. Each of these settings is set internally when set to Auto. Alternatively, you can specify values appropriate for specific measurement needs.
Equalizer Tab (see page 489)	Enable the Equalizer and adjust its parameters.
Advanced Params (see page 491)	Specifies additional parameters.
Find (see page 494)	Used to set parameters for finding a burst within the data record and for entering a Synch word.
Analysis Time (see page 494)	Contains parameters that define the portion of the acquisition record that is used for analysis. Also allows you to specify the Units (Seconds or Symbols) for the GP Digital Modulation displays.
Trace (see page 496)	Allows you to set the trace display characteristics.
Scale (see page 498)	Specifies the horizontal and vertical scale settings.
Prefs (see page 498)	Enables you to set characteristics of the measurement display.

Signal Quality Display

The Signal Quality display shows several measurements of signal quality. The measurements displayed depend on the modulation type. There is a set of measurements displayed for all modulation types except nFSK and C4FM. There is a second set of measurements displayed for nFSK and C4FM modulation types.

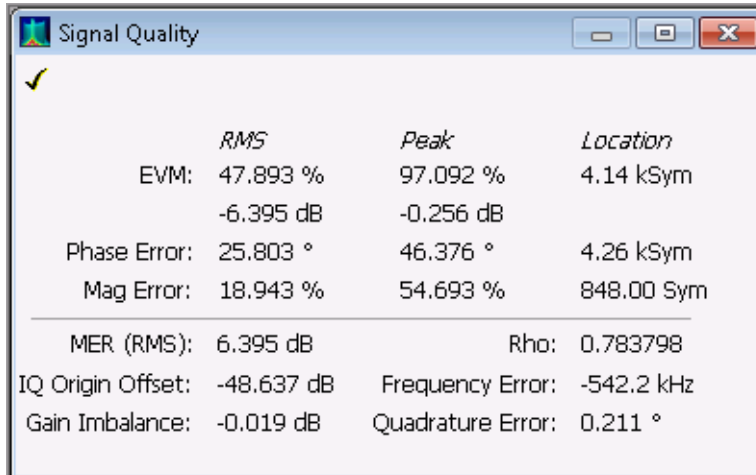

Signal Quality

✓

	<i>RMS</i>	<i>Peak</i>	<i>Location</i>
EVM:	47.893 %	97.092 %	4.14 kSym
	-6.395 dB	-0.256 dB	
Phase Error:	25.803 °	46.376 °	4.26 kSym
Mag Error:	18.943 %	54.693 %	848.00 Sym

MER (RMS):	6.395 dB	Rho:	0.783798
IQ Origin Offset:	-48.637 dB	Frequency Error:	-542.2 kHz
Gain Imbalance:	-0.019 dB	Quadrature Error:	0.211 °

Signal Quality display for all modulation types except nFSK, C4FM, OQPSK, and SOQPSK

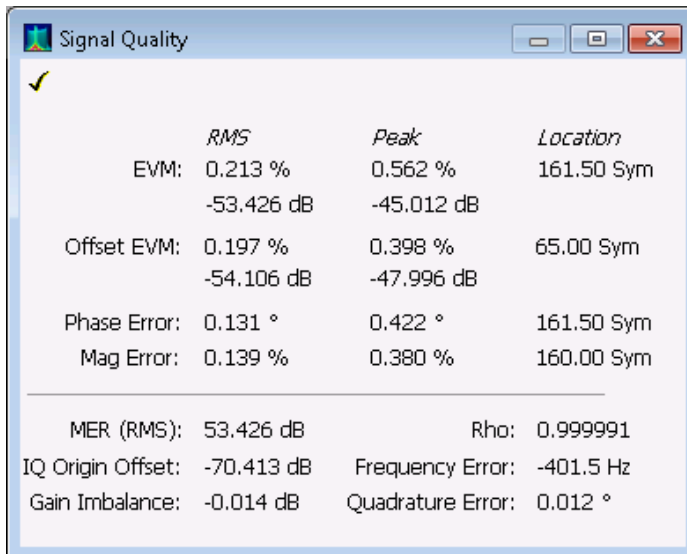

Signal Quality

✓

	<i>RMS</i>	<i>Peak</i>	<i>Location</i>
EVM:	0.213 %	0.562 %	161.50 Sym
	-53.426 dB	-45.012 dB	
Offset EVM:	0.197 %	0.398 %	65.00 Sym
	-54.106 dB	-47.996 dB	
Phase Error:	0.131 °	0.422 °	161.50 Sym
Mag Error:	0.139 %	0.380 %	160.00 Sym

MER (RMS):	53.426 dB	Rho:	0.999991
IQ Origin Offset:	-70.413 dB	Frequency Error:	-401.5 Hz
Gain Imbalance:	-0.014 dB	Quadrature Error:	0.012 °

Signal Quality display for OQPSK and SOQPSK modulation types

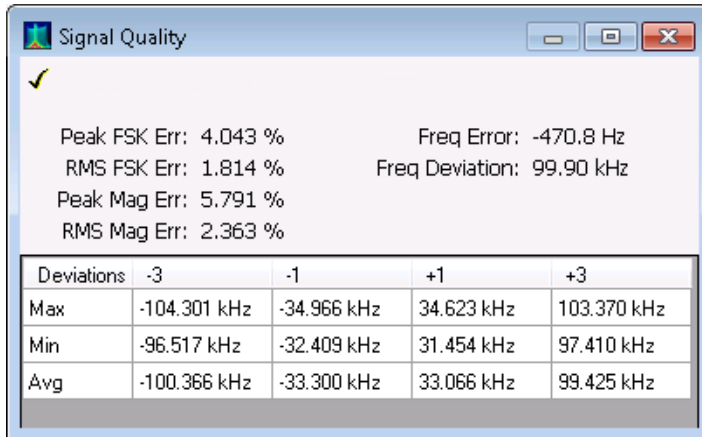

Signal Quality display for nFSK modulation type

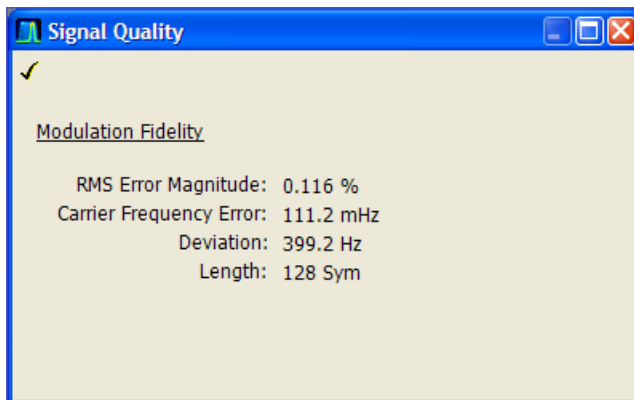

Signal Quality display for C4FM modulation type

Elements of the Display

Measurements for all modulation types except nFSK, C4FM, OQPSK and SOQPSK

Measurement	Description
EVM	The normalized RMS value of the error vector between the measured signal and the ideal reference signal over the analysis length. The EVM is generally measured on symbol or chip instants and is reported in units of percent and dB. EVM is usually measured after best-fit estimates of the frequency error and a fixed phase offset have been removed. These estimates are made over the analysis length. Displays RMS and Peak values with location of Peak value.
Phase Error	The RMS phase difference between the measured signal and the ideal reference signal. Displays RMS and Peak values with location of Peak value.
Mag Error	The RMS magnitude difference between the measured signal and the reference signal magnitude. Displays RMS and Peak values with location of Peak value.
MER (RMS)	The MER is defined as the ratio of I/Q signal power to I/Q noise power; the result is indicated in dB.
IQ Origin Offset	The magnitude of the DC offset of the signal measured at the symbol times. It indicates the magnitude of the carrier feed-through signal.
Frequency Error	The frequency difference between the measured carrier frequency of the signal and the user-selected center frequency of the instrument.
Gain Imbalance	The gain difference between the I and Q channels in the signal generation path. Constellations with gain imbalance show a pattern with a width that is different from height.
Quadrature Error	The orthogonal error between the I and Q channels. The error shows the phase difference between I and Q channels away from the ideal 90 degrees expected from the perfect I/Q modulation. Not valid for BPSK modulation type.
Rho	The normalized correlated power of the measured signal and the ideal reference signal. Like EVM, Rho is a measure of modulation quality. The value of Rho is less than 1 in all practical cases and is equal to 1 for a perfect signal measured in a perfect receiver.

Measurements for QPSK and SQPSK modulation types

Measurement	Description
EVM	The normalized RMS value of the error vector between the measured signal and the ideal reference signal over the analysis length. The EVM is generally measured on symbol or chip instants and is reported in units of percent and dB. EVM is usually measured after best-fit estimates of the frequency error and a fixed phase offset have been removed. These estimates are made over the analysis length. Displays RMS and Peak values with location of Peak value.
Offset EVM	Offset EVM is like EVM except for a difference in the time alignment of the I and Q samples. For EVM, I and Q samples are collected at the same time, for every symbol decision point (twice the symbol rate for offset modulations). For Offset EVM, the I and Q symbol decision points are time-aligned before collecting the I and Q samples. In this case, one I and one Q sample is collected for each symbol (half as many samples as the same number of symbols for (non-offset) EVM).
Phase Error	The RMS phase difference between the measured signal and the ideal reference signal. Displays RMS and Peak values with location of Peak value.
Mag Error	The RMS magnitude difference between the measured signal and the reference signal magnitude. Displays RMS and Peak values with location of Peak value.
MER (RMS)	The MER is defined as the ratio of I/Q signal power to I/Q noise power; the result is indicated in dB.
IQ Origin Offset	The magnitude of the DC offset of the signal measured at the symbol times. It indicates the magnitude of the carrier feed-through signal.
Frequency Error	The frequency difference between the measured carrier frequency of the signal and the user-selected center frequency of the instrument.
Gain Imbalance	The gain difference between the I and Q channels in the signal generation path. Constellations with gain imbalance show a pattern with a width that is different from height.
Quadrature Error	The orthogonal error between the I and Q channels. The error shows the phase difference between I and Q channels away from the ideal 90 degrees expected from the perfect I/Q modulation. Not valid for BPSK modulation type.
Rho	The normalized correlated power of the measured signal and the ideal reference signal. Like EVM, Rho is a measure of modulation quality. The value of Rho is less than 1 in all practical cases and is equal to 1 for a perfect signal measured in a perfect receiver.

Measurements for nFSK modulation types

Measurement	Description
Peak FSK err	Peak value of the frequency deviation error at the symbol point.
RMS FSK Err	RMS value of the frequency deviation error at the symbol point.
Peak Mag Err	The Peak magnitude difference between the measured signal and the reference signal magnitude.
RMS Mag Err	The RMS magnitude difference between the measured signal and the reference signal magnitude.
Freq Error	The frequency difference between the measured carrier frequency of the signal and the user-selected center frequency of the instrument.
Freq Deviation	Frequency distance from the center frequency at the symbol point.
Symbol Rate Error	This compares the user-entered symbol rate to the instrument calculated symbol rate of the analyzed signal.
Symbol Rate	When in Auto-symbol rate, the instrument calculates the symbol rate of the signal and the instrument calculates the error between the user entered value and the instrument calculated value.

Measurements for C4FM modulation type

Measurement	Description
RMS Error Magnitude	RMS value of the frequency deviation error at the symbol point.
Carrier Frequency Error	Frequency difference between averaged signal frequency and the center frequency.
Deviation	Frequency distance from the center frequency at the symbol point.
Length	Number of symbols in the analysis area.

[Changing the Signal Quality Display Settings \(see page 477\)](#)

Signal Quality Settings

Main menu bar: Setup > Settings

Favorites toolbar: 

The Setup settings for Signal Quality are accessible only when the Signal Quality display is selected.

NOTE. You might be able to save time configuring the Signal Quality display by pressing the Standard Settings button from the Settings control panel. This allows you to select a preset optimized for a standard from the Select Standard dialog box. See [Standard Settings Button. \(see page 482\)](#)

Settings tab	Description
Modulation Params (see page 483)	The Modulation tab specifies the type of modulation used for the input signal and other parameters.
Freq & BW (see page 487)	Specifies settings for frequency error, measurement BW and Frequency Deviation. Each of these settings is set internally when set to Auto. Alternatively, you can specify values appropriate for specific measurement needs.
Equalizer Tab (see page 489)	Enable the Equalizer and adjust its parameters.
Advanced Params (see page 491)	The Advanced Params tab specifies frequency offset, magnitude normalization method and allows you to swap the I and Q signals.
Find (see page 494)	Find tab is used to set parameters for finding bursts within the data record.
Analysis Time (see page 494)	The Analysis Time tab contains parameters that define the portion of the acquisition record that is used for analysis.
Prefs (see page 498)	The Prefs tab enables you to set characteristics of the measurement display.

Symbol Table Display

The Symbol Table Display is like the Constellation Display except that a text table is used to display data bits at a symbol rather than a graph. The Synch Word characters, if used, are in bold font.

To display the Symbol Table:

1. Select the **Displays** button or select **Setup > Displays**. This displays the **Select Displays** dialog box.
2. From the **Measurements** box, select **GP Digital Modulation**.
3. Double-click the **Symbol Table** icon in the **Available Displays** box. This adds the Symbol Table icon to the **Selected displays** box.
4. Click the **OK** button. This displays the Symbol Table view.

0	10	01	11	10	00	10	01	10	11	00	00	11	01	11	01	11
16	01	10	00	01	10	11	10	00	01	10	10	00	00	01	10	11
32	10	00	01	11	01	10	10	00	11	00	00	10	00	11	10	01
48	11	10	01	01	11	11	11	01	01	00	11	00	00	11	01	11
64	01	01	11	11	10	11	10	10	01	10	10	10	00	10	01	11
80	10	10	00	11	11	01	01	01	00	00	00	10	10	10	10	01
96	10	11	11	01	11	01	11	10	01	00	00	00	00	11	00	01
112	01	01	10	00	11	01	01	01	10	11	01	01	10	11	11	01
128	01	00	11	00	11	10	00	01	01	01	01	10	01	11	01	10
144	01	10	00	10	11	10	00	01	10	11	10	10	01	01	00	10
160	11	10	10	11	00	00	11	10	00	00	11	00	10	10	01	11
176	10	01	10	11	11	00	10	10	11	10	11	01	01	00	00	10
192	00	11	11	00	00	00	11	00	00	10	10	00	11	00	10	00
208	11	10	01	11	10	10	01	11	11	00	01	10	11	11	10	11
224	10	00	10	10	00	10	10	10	11	01	10	10	10	11	00	01
240	11	00	11	00	01	01	01	11	11	10	10	10	10	01	00	10

Marker: M1 Symbol: 0
Time: 0.00 Sym Value: 10

Using Markers

Markers are indicators in the display that you can position on a trace to measure values such as frequency, power, and time. A Marker always displays its position and, if the Delta readout is enabled, will display the difference between its position and that of the Marker Reference. Within the Symbol Table, colored cells indicate the location of markers. The selected Marker is highlighted with a light green background. All other markers are highlighted with a light gray background. In the Symbol Table, the marker readout below the table shows the marker location in time, symbol numbers and symbol value.

[Changing the Symbol Table Display Settings \(see page 479\)](#)

Symbol Table Settings

Main menu bar: Setup > Settings

Favorites toolbar: 

The Setup settings for the Symbol Table view are shown in the following table.

NOTE. You might be able to save time configuring the Symbol Table display by pressing the Standard Settings button from the Settings control panel. This allows you to select a preset optimized for a standard from the Select Standard dialog box. See [Standard Settings Button. \(see page 482\)](#)

Settings tab	Description
Modulation Params (see page 483)	The Modulation tab specifies the type of modulation used for the input signal and other parameters.
Freq & BW (see page 487)	Specifies settings for frequency error, measurement BW and Frequency Deviation. Each of these settings is set internally when set to Auto. Alternatively, you can specify values appropriate for specific measurement needs.
Equalizer Tab (see page 489)	Enable the Equalizer and adjust its parameters.
Advanced Params (see page 491)	The Advanced Params tab specifies additional parameters.
Find (see page 494)	Find tab is used to set parameters for finding bursts within the data record.
Analysis Time (see page 494)	The Analysis Time tab contains parameters that define the portion of the acquisition record that is used for analysis.
Prefs (see page 498)	The Prefs tab enables you to set characteristics of the measurement display.

Trellis Diagram Display

To show an Trellis Diagram display:

1. Press the **Displays** button or select **Setup > Displays**. This shows the **Select Displays** dialog box.
2. From the **Measurements** box, select **GP Digital Modulation**.

3. Double-click the **Trellis Diagram** icon in the **Available Displays** box. This adds the Trellis Diagram icon to the **Selected displays** box.
4. Click the **OK** button. This displays the Trellis Diagram view.

Elements of the Display

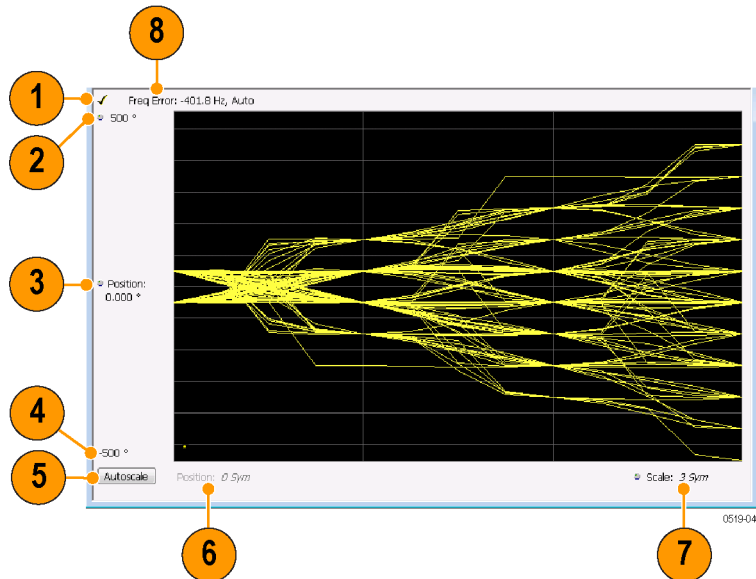

Item	Element	Description
1	Check mark indicator	The check mark indicator in the upper, left-hand corner of the display shows when the Frequency Deviation vs Time display is the optimized display. NOTE. When <i>Best for multiple windows</i> is selected in the Amplitude control panel's RF & IF Optimization control, none of the measurement displays shows a checkmark, as there is not a single optimized measurement.
2	Top of Graph	Sets the phase value indicated at the top of the graph. Changing the top value affects the bottom of graph readout. Also, note that the top of graph setting interacts with the internal vertical scale setting (which is not user settable) such that the range between the top and bottom of the graph increases or decreases automatically.
3	Position	Specifies the phase value shown at the center of the graph display.
4	Bottom Readout	Displays the value of the phase value shown at the bottom of graph.
5	Autoscale	Adjusts the vertical and horizontal settings to provide the best display.
6	Position	Displays the horizontal position of the trace on the graph display.
7	Scale	Adjusts the span of the graph in symbols.
8	Freq Error	Displays the difference between the maximum and minimum measured values of the signal frequency during the Measurement Time. The displayed frequency error is followed by either Auto or Manual . This indicates the selected carrier frequency detection method (see Settings > Freq & BW).

[Changing the Trellis Diagram Settings \(see page 481\)](#)

Trellis Diagram Settings

Main menu bar: Setup > Settings

Favorites toolbar: 

The settings for the Trellis Diagram display are shown in the following table.

NOTE. You might be able to save time configuring the Trellis Diagram display by pressing the Standard Settings button from the Settings control panel. This allows you to select a preset optimized for a standard from the Select Standard dialog box. See [Standard Settings Button. \(see page 482\)](#)

Settings tab	Description
Modulation Params (see page 483)	Specifies the type of modulation used for the input signal and other parameters.
Freq & BW (see page 487)	Specifies settings for frequency error, measurement BW and Frequency Deviation. Each of these settings is set internally when set to Auto. Alternatively, you can specify values appropriate for specific measurement needs.
Equalizer Tab (see page 489)	Enable the Equalizer and adjust its parameters.
Advanced Params (see page 491)	Specifies additional parameters.
Find (see page 494)	Used to set parameters for finding a burst within the data record and for entering a Synch word.
Analysis Time (see page 494)	Contains parameters that define the portion of the acquisition record that is used for analysis. Also allows you to specify the Units (Seconds or Symbols) for the GP Digital Modulation displays.
Trace (see page 496)	Allows you to set the trace display characteristics.
Scale (see page 498)	Specifies the horizontal and vertical scale settings.
Prefs (see page 498)	Enables you to set characteristics of the measurement display.

GP Digital Modulation Shared Measurement Settings

The displays in the GP Digital Modulation folder (Setup > Displays) are each a different format for presenting the results of a single underlying analysis. For this reason, all controls that affect the analysis parameters are shared by all the displays in the GP Digital Modulation folder.

Changing a setting on one tab changes that setting for all the GP Digital Modulation displays. For example, if you change the Modulation Type for the Constellation Display, it also changes the Modulation type setting for the Signal Quality display. There are some controls that affect only the way an individual display presents its results, such as graph scaling.

Common controls for GP digital modulation displays

Settings tab	Description
Modulation Params (see page 483)	Specifies the type of modulation, symbol rate, and filters to be used in demodulating the input signal.
Freq & BW (see page 487)	Sets values for frequency error/offset, measurement bandwidth, and frequency deviation (not every control is present for every modulation type).
Equalizer Tab (see page 489)	Enable the Equalizer and adjust its parameters.
Advanced Params (see page 491)	Specifies additional parameters that are less frequently used.
Find (see page 494)	Used to set parameters for finding a burst within the data record and for entering a Synch word.
Analysis Time (see page 494)	Contains parameters that define the portion of the acquisition record that is used for analysis. Also allows you to specify the Units (Seconds or Symbols) for the GP Digital Modulation displays.
Trace (see page 496)	Allows you to set the trace display characteristics.
Prefs (see page 498)	Enables you to set characteristics of the measurement display.

Standard Settings Button

On every GP Digital Modulation control panel there is a button labeled **Standard Settings**. This button is used to recall settings optimized for analyzing the selected standard. See the following table for a list of the standards for which standard settings are available. Choosing a standard from the dialog box changes only settings for GP Digital Modulation displays.

All of the presets in the Standard Settings Dialog make the following settings:

- Analysis Length: Auto
- Points per Symbol: 4
- Data Differential: No
- Burst Mode: Off
- Burst Detection Threshold: -10 dBc

Parameter values set by presets in the standard settings dialog

Standard	Modulation	Symbol Rate	Meas. Filter	Reference Filter	Filter Parameter	Other
802.15.4	OQPSK	1e6	None	Half sine	NA	
SBPSK-MIL	SBPSK	2.4e3	None	SBPSK-MIL	NA	
SOQPSK-MIL	SOQPSK	2.4e3	None	SOQPSK-MIL	NA	1
CPM-MIL	CPM	19.2e3	None	None	NA	
SOQPSK-ARTM Tier 1	SOQPSK	2.5e6	None	SOQPSK-ARTM	NA	1
Project25 Phase 1	C4FM	4.8e3	C4FM-P25	RC	0.2	
CDMA2000–Base	QPSK	1.2288e6	IS-95 TXE-Q_MEA	IS-95 REF	NA	
W-CDMA	QPSK	3.84e6	RRC	RC	0.22	

1 Center Symbol Position, Half Shift Removed

Modulation Params Tab

Menu bar: Setup > Settings > Modulation Params

The Modulation Params tab specifies the type of modulation on the input signal and other parameters that control the demodulation of the input signal.

Modulation Params | Freq & BW | Advanced Params | Find | Analysis Time | Trace | Scale | Prefs

Modulation type: QPSK | Measurement Filter: Root raised cosine

Symbol Rate: 40 kHz | Reference Filter: Raised cosine

Filter Parameter: 0.300

Parameter	Description
Modulation type	Specifies the type of modulation on the input signal.
Symbol Rate	Specifies the symbol rate in Hertz.
Measurement Filter	Specifies the filter used for measurements.
Reference Filter	Specifies the filter used as a reference.
Filter Parameter	Enter a value used for defining the Reference Filter. (Not present for some filter types)
Modulation index	(Present only for CPM modulation type)

Modulation Type

The modulation types that can be demodulated and analyzed are:

Modulation type	Description
QPSK	Quadrature Phase Shift Keying
8PSK	8-Phase Shift Keying
D8PSK	Differential Eight Phase Shift Keying
D16PSK	Differential Sixteen Phase Shift Keying
PI/2DBPSK	Pi/2 Differential Binary Phase Shift Keying
DQPSK	Differential Quadrature Phase Shift Keying
PI/4DQPSK	Pi/4 Differential Quadrature Phase Shift Keying
BPSK	Binary Phase Shift Keying
OQPSK	Offset Quadrature Phase Shift Keying
16QAM	16-state Quadrature Amplitude Modulation
32QAM	32-state Quadrature Amplitude Modulation
64QAM	64-state Quadrature Amplitude Modulation
128QAM	128-state Quadrature Amplitude Modulation
256QAM	256-state Quadrature Amplitude Modulation
MSK	Minimum Shift Keying
2FSK	2-Frequency Shift Keying
4FSK	4-Frequency Shift Keying
8FSK	8-Frequency Shift Keying
16FSK	16-Frequency Shift Keying
CPM	Continuous Phase Modulation
SOQPSK	Shaped Offset Quadrature Phase Shift Keying
SBPSK	Shaped Binary Phase Shift Keying
C4FM	Constant Envelope 4-Level Frequency Modulation

Symbol Rate

Specifies the symbol rate for demodulating digitally modulated signals. The symbol rate and the bit rate are related as follows:

$$(\text{Symbol rate}) = (\text{Bit rate}) / (\text{Number of bits per symbol})$$

For example, the number of bits per symbol is 3 for 8PSK.

Measurement and Reference Filters

The available measurement and reference filters depend on the selected modulation type. If a particular filter is not practical for a selected modulation type, it is not presented as an available filter. To determine which filters are available, make certain that your desired modulation type is selected. See the following table.

Modulation type	Measurement filters	Reference filters
BPSK	None	None
PI/2DBPSK	RootRaisedCosine	RaisedCosine
8PSK	RaisedCosine	Gaussian
D8PSK	Gaussian	User
DQPSK	User	Rectangular (freq)
PI/4DQPSK	Rectangular (freq)	IS-95REF
16QAM	IS-95TX_MEA	
32QAM	IS-95TXEQ_MEA	
64QAM		
128QAM		
256QAM		
QPSK		
MSK	None	None
	Root Raised Cosine	Gaussian
	RaisedCosine	User
	Gaussian	
	User	
OQPSK	Rectangular (freq)	
	None	None
	RootRaisedCosine	Half sine
	User	RaisedCosine
	IS-95TX_MEA	User
HDQPSK	IS-95TXEQ_MEA	IS-95REF
	HDQPSK-P25	None
		RaisedCosine
		Gaussian
		User
SOQPSK		Rectangular (freq)
	None	SOQPSK-MIL
	User	SOQPSK-ARTM
CPM		User
	None	None
2FSK	User	User
4FSK	None	None
8FSK	Gaussian	Gaussian
16FSK	RootRaisedCosine	RaisedCosine
	RaisedCosine	User
	Rectangular (freq)	
	User	

Modulation type	Measurement filters	Reference filters
C4FM	C4FM-P25	RaisedCosine User
SBPSK	None User	SBPSK-MIL User

The measurement filter is applied before the demodulation bit is detected and the ideal reference is calculated.

The reference filter is applied to the internally generated ideal reference signal before the EVM is calculated.

Measurement BW

The measurement BW (reported on the Settings > Freq & BW tab) is computed based on the Modulation Type, the Symbol Rate (SR), the Reference Filter type, and the Filter Parameter (alpha). The following table shows the formulas used, where SR= symbol rate, and α = filter parameter.

Modulation type	Measurement filter	Measurement bandwidth
QPSK, 8PSK, D8PSK, DQPSK, PI/4DQPSK, BPSK, PI/2DBPSK, QAM16-256, APSK	Raised Cosine	$SR * (1 + \alpha)$
	None / Rectangular	$SR * 16$
	All others	$SR * 2$
D16PSK	Raised Cosine	$SR * (1.5 + \alpha)$
	None / Rectangular	$SR * 16$
	All others	$SR * 2.5$
OQPSK	Raised Cosine	$SR * 2$
	Half Sine	$SR * 12$
	None / Rectangular	$SR * 16$
	All others	$SR * 2$
GMSK	Gaussian	$SR * 12 * \alpha$
	None / Rectangular	$SR * 4$
	All others	$SR * 4$
GFSK, FSKn, C4FM	All	$SR * 8$

How to Select Filters

In a signal transmitter/receiver system, the baseband signal might be filtered for bandwidth limiting or for another kind of necessary shaping that needs to be applied. Normally, a filter in the transmitter (F_t) and a filter in the receiver (F_r) are applied.

The Measurement Filter setting in the analyzer corresponds to the baseband filter in the receiver (F_r): This setting tells the analyzer what filter your receiver uses. When the analyzer is set to the same filter used by the receiver, the analyzer sees the signal as your receiver would. The Measurement Filter setting should be the same as the filter used in the receiver under normal operation (as opposed to testing).

The Reference Filter setting in the analyzer corresponds to the baseband filter in the transmitter-receiver combination ($F_r * F_t$). The baseband filter for the transmitter-receiver combination is often referred to as the *System Filter*. This filter is called the reference filter because it is used to recreate a reference signal that is compared to the received signal. This recreated reference signal is the *ideal signal* with $F_r * F_t$ applied; differences between this *ideal signal* and the received signal enables the determination of signal quality, such as EVM measurements.

The following is an example of a hypothetical signal that is transmitted into a vector signal analyzer for analysis:

Assume that a signal is transmitted using a baseband filter (F_t). It then travels through a transmission medium (air/cable/etc) where it may be affected by the communication channel (F_c). The signal is received and filtered by the receiver's filter (F_r). At this point, the signal has passed through F_t and F_r , and in addition, the communication channel might have affected it (so: $F_t * F_r * F_c$). This double-filtered signal is demodulated as it was received to determine the symbols/bits in it. The obtained bits are used to regenerate a baseband ideal signal that can be compared against the received signal to determine signal quality. However, to determine the effect of the environment on the signal quality, the ideal signal must be filtered by the REFERENCE FILTER ($F_t * F_r$), so that the ideal signal and the filtered signal differ only by the effect of the environment. So, the received signal is the ideal signal filtered by $F_t * F_r * F_c$ and the reference signal is the ideal signal filtered by $F_t * F_r$, since they only differ by the effect of F_c , the comparison will show the effect of the communication channel on the signal. The communication channel can also include the hardware path the signal follows after (Tx) or before (Rx) digitizing; this would account for Tx/Rx hardware linear and non-linear distortion.

Common examples of how these filters are used are shown below:

- For Transmit Filter = Root Raised Cosine (RRC), Measurement Filter = RRC, the Reference Filter = RRC^2 = Raised Cosine
- For Transmit Filter = Raised Cosine (RC), Measurement Filter = None, the Reference Filter = Raised Cosine (When the Measurement Filter = None, the Reference Filter = Transmit Filter)
- For Transmit Filter = Gaussian, Measurement Filter = None, the Reference Filter = Gaussian

Filter Parameter

The filter parameter specifies the alpha for the Root Raised Cosine or Raised Cosine filter, or the bandwidth-time product (BT) for the Gaussian filter, when selected as the Reference filter. Some filter types have a fixed parameter value that is specified by industry standard, while other filter types by definition have no filter parameter. For filter types with no filter parameter, there is no filter parameter control present in the control panel.

Freq & BW Tab

The Freq & BW tab specifies a group of settings that affect how measurements are made.

Modulation Params	Freq & BW	Advanced Params	Find	Analysis Time	Trace	Scale	Prefs
Frequency Error:	<input type="text" value="133.3 Hz"/>	<input checked="" type="checkbox"/> Auto					
Measurement BW:	<input type="text" value="30.72 MHz"/>	<input type="text" value="Auto"/>					
Frequency Deviation:	<input type="text" value="465.7 kHz"/>	<input checked="" type="checkbox"/> Auto					

Freq & BW tab with nFSK or C4FM modulation type selected and Frequency Error readout enabled (Auto selected)

Modulation Params	Freq & BW	Advanced Params	Find	Analysis Time	Trace	Scale	Prefs
Frequency Error:	<input type="text" value="-401.8 Hz"/>	<input checked="" type="checkbox"/> Auto					
Measurement BW:	<input type="text" value="640.0 kHz"/>	<input type="text" value="Auto"/>					

Freq & BW tab with SOQPSK modulation type selected and Frequency Offset enabled (Auto deselected)

Setting	Description
Frequency Error / Frequency Offset	When Auto is enabled, this readout displays frequency error and the measurement is made at the calculated frequency. When Auto is disabled, this setting changes to Frequency Offset. When set to Frequency Offset, this setting is used to demodulate a signal that is not at the center frequency. The measurement is made at the user-entered offset. The Measurement Filter (if any, specified on the Modulation Params tab) is applied about the offset frequency whether set automatically or manually.
Measurement BW	This setting allows you to override the automatic bandwidth calculation and directly enter a bandwidth value. If you enter a value for the measurement bandwidth, be aware that the actual bandwidth of data provided to the measurement will be at least as wide as the value you request and may be as much as two times wider than requested. This override of the selected measurement bandwidth is done so that the instrument uses sufficient bandwidth relative to the chosen symbol rate to ensure good signal quality measurements.
Frequency Deviation	For nFSK modulation types, this setting specifies the frequency deviation. Select Auto to make the instrument do this automatically. Deselect Auto to enter a value manually. This setting is present for only nFSK and C4FM modulation types.

Equalizer Tab

The Equalizer tab enables you to apply an adaptive equalizer to a digitally modulated signal to compensate for linear distortions in the signal. The Equalizer is available only for displays in the GP Digital Modulation folder (Select Displays window). The analyzer implements a decision directed, feed-forward FIR filter to correct linear distortion in the input signal.

Parameter	Description
Enable Equalization	This setting turns the Equalizer on and off.
Reset Equalization	Initializes the equalizer filter for training.
Enable EQ Export	Exports a text file with equalizer taps in I/Q pairs.
Mode	Specifies whether the equalizer is in learning (Train) mode or analysis (Hold) mode.
Convergence	Specifies the update rate. Maximum value: 0.002. Default value: 0.0005
Taps/Symbol	The number of filter coefficients per symbol used by the filter. Available choices are 1, 2, 4, and 8.
Taps	The number of filter coefficients. Range: 3 to 100 (you can set a higher number, but 100 is the practical limit).
Length	Specifies the number of symbols analyzed (or filter length).

Selecting the Mode

When enabled, the Equalizer is in either Train mode or Hold mode. When the equalizer is in Train mode, it will update internal filter parameters whenever you adjust the Convergence, Taps/Symbol, Taps, or Length values. When it is in Hold mode, the Equalizer uses the parameter values (both internal and the values accessible on the Equalizer tab) in effect when it was placed into Hold mode.

NOTE. *The Equalizer does not need to be retrained if the modulation type is changed. You can train the Equalizer by using a simpler modulation type (such as QPSK), place the Equalizer into Hold mode and can then measure more complex modulation types such as QAM.*

Training the Equalizer

To obtain the desired results using the Equalizer, you must first train the Equalizer. This is an iterative process where you adjust some filter parameters (and the analyzer adjusts internal parameters) to achieve the lowest error possible on the acquired signal.

To configure the Equalizer:

1. Press the **Displays** button or select **Setup > Displays**.
2. In the **Select Displays** window, select **GP Digital Modulation** from **Measurements**.
3. Add **Signal Quality** to the **Selected Displays** and select **OK**.
4. With the Signal Quality display selected, select **Setup > Settings**.
5. Select the **Modulation Params** tab set the parameters as necessary for the signal.
6. Select the **Equalizer** tab.
7. Set the **Convergence** value to 0.0005.
8. Set **Taps/Symbol** to 2.
9. Click the **Reset Equalization** button to reset the equalizer.
10. Set the **Mode** to **Train**.
11. Click **Enable Equalization** so it is checked.
12. On the Signal Quality display, examine the value for EVM.
13. Change the Convergence, Taps/Symbol, and Taps values iteratively to achieve a minimum EVM value.

NOTE. *Changing the Taps/symbol or Taps values resets the equalizer.*

Using the Equalizer

To use the equalizer:

1. Select and configure a **GP Digital Modulation** display.
2. Select **Setup > Settings**.
3. Select the **Equalizer** tab.
4. Select **Enable Equalization** so it is checked.
5. Verify that Mode is set to **Hold** if you have previously trained the Equalizer. If you have not previously trained the Equalizer, [train the Equalizer \(see page 489\)](#) and then set the Mode to Hold.

Exporting EQ Files

If the **Enable EQ Export** box is checked, the following outputs files are automatically generated to these locations after each measurement update cycle if the EQ coefficients change: *c:\temp\EqTaps.txt* and *c:\temp\EqTapsHdr.txt*. These files have EQ taps in I/Q pairs (one pair per row).

The *Hdr* version file has a five line header before the EQ tap data. Each line in the five line header of the *Hdr* version file has two data values, with the second one always being "0":

```
<line1>Number_of_Header_Lines 0
```

<line2>EQ_Sample_Rate_Hz 0
 <line3>Demod_Symbol_Rate_Sps 0
 <line4>EQ_Samples_per_Symbol 0
 <line5>Number_of_EQ_Taps_Following 0

Exporting EQ Files

Advanced Params Tab

The Advanced Params tab specifies additional parameters that control the demodulation of the signal.

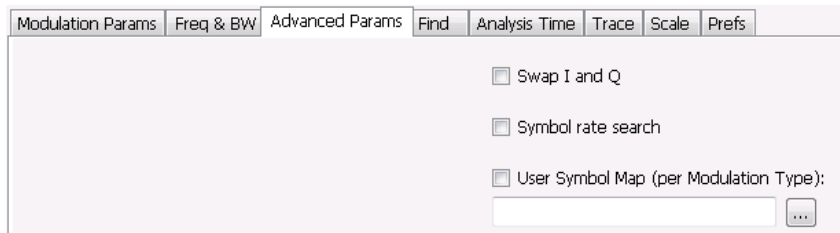

Advanced Params tab for modulation type nFSK

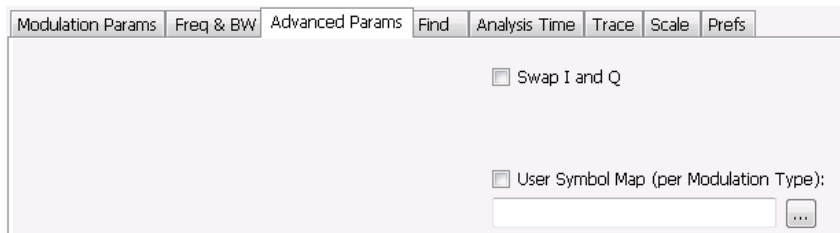

Advanced Params tab for modulation type C4FM

Parameter	Description
Mag Normalize (not present for nFSK or C4FM modulation types)	Select RMS Symbol Magnitude or Max Symbol Magnitude. This setting applies to Mag Error and EVM.
Swap I and Q	When enabled, the I and Q data are exchanged before demodulating.
Symbol rate search (Present only for nFSK modulation types)	Determines whether to automatically detect or manually set the symbol rate. When selected, automatically detects the symbol rate to perform analysis. The calculated symbol rate is displayed in the Signal Quality display. The Symbol Rate Error is also calculated and displayed when Symbol rate search is enabled.
User Symbol Map (per Modulation Type)	Enables the use of custom symbol maps. This enables you to specify the location of symbols in the display. This control can be set independently for each of the modulation types.

Mag Normalize

Specifies whether Magnitude Normalization uses the RMS Symbol Magnitude or the Maximum Symbol Magnitude as the basis for normalization. Use RMS Symbol Magnitude on QPSK modulations (equal magnitude symbol locations), and use Maximum Symbol Magnitude for signals that have a large difference in magnitude among the symbol locations (such as 128QAM). It prevents the instrument from using the very low magnitude center symbols when normalizing the constellation. The outer symbols are a better normalization reference than the center in this case.

Swap I and Q

Use the Swap I and Q control to correct a signal sourced by a downconverter that inverts the frequency of the signal under test.

User Symbol Map

A User Symbol Map is a text file that specifies the location of symbols in the display. The symbol map is unique for each modulation type. The easiest way to create a custom symbol map is to start with the default symbol map and modify it. The default symbol map file is located at C:\SignalVu Files. The default symbol map file is named **DefaultSymbolMaps.txt**. See [Symbol Maps \(see page 499\)](#) for illustrations of the default symbol mapping.

To specify a user symbol map:

1. Click the ... button.
2. Navigate to the directory containing the user symbol text file you want to use.
3. Select the desired file in the Open window and click **Open**.
4. Select **User Symbol Map** to enable the user symbol map.

Editing the User Symbol Map. The symbol map is a plain text file and can be edited with any plain text editor.



CAUTION. Whenever you reinstall the program software, the existing *DefaultSymbolMaps.txt* file will be overwritten. To create a custom symbol map, you should make a copy of the default symbol map file, edit the copy to suit your needs, and save it with a new name. Guidance on how to edit the symbol map file is contained within the default symbol map file.

The following excerpt from the default symbol map file explains the structure of the file and how to edit it.

```
## Symbol Mapping Definitions
## Version 1.2

## This file defines the mapping of modulation states to symbol values.
##
## File Format :
## -----
## 1. Comments begin with '##' and may appear after the last field in a line
## 2. A symbol map begins and ends with a line containing the name of the
## modulation type. These names must exactly match the name of one of the
## modulation types in the RSA software
## 3. Empty cells may be included to preserve the constellation shape.
## 4. Blank lines are ignored.
## 5. A modulation type which does not match the name of an existing
## type will be ignored.
##
## Usage :
## -----
## 1. The file is intended to be edited with Notepad or similar text editor
```

The following text is an example of a symbol map.

```
## Symbol Map for 32 QAM
## (Resembles the shape of the constellation)
      32QAM
00011 00010 00001 00000
01001 01000 00111 00110 00101 00100
01111 01110 01101 01100 01011 01010
10101 10100 10011 10010 10001 10000
11011 11010 11001 11000 10111 10110
      11111 11110 11101 11100
      32QAM
```

Find Tab

The Find tab is used to set parameters for finding bursts within the data record. This is a post-acquisition operation. Synch Word search controls are also on this tab.

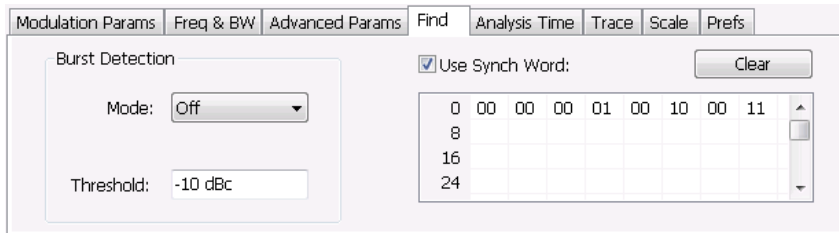

Setting	Description
Burst Detection: Mode	Select whether to analyze bursts - Auto: If a burst is found, analyze just that burst period. If a burst is not found, analyze the whole analysis length. - On: If a burst is found, analyze just that burst period. If a burst is not found, display an error message. - Off: Analyze the whole analysis length. If the signal isn't adequate for demodulation, an error message is shown.
Burst Detection: Threshold	Sets the level required for the signal to qualify as a burst. Enter a value in dBc down from top of the signal.
Use Synch Word	When enabled, specifies the string of symbols to look for. Enter the search string with external keyboard or the on-screen keyboard.
Clear	Blanks the search string field.

Analysis Time Tab

The Analysis Time tab contains parameters that define how the signal is analyzed in the general purpose digital modulation displays.

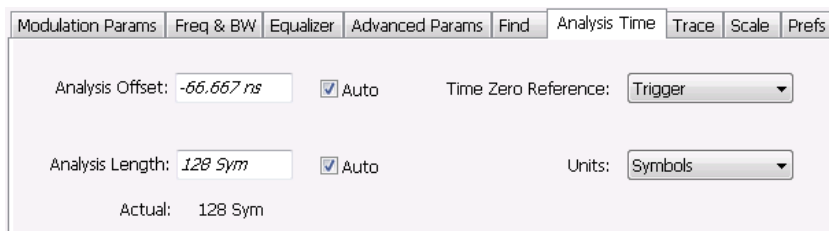

The settings values on this tab are the same as those on the main Analysis control panel for the instrument with the only difference being that Analysis Length can be set in either Seconds or Symbols in this location.

Setting	Description
Analysis Offset	Specifies the location of the first time sample to use in measurements.
Auto	When enabled, causes the instrument to set the Analysis Offset value based on the requirements of the selected display.
Analysis Length	Specifies the length of the analysis period to use in measurements. Length is specified in either seconds or symbols, depending on the Units setting. For most modulation types, the Analysis Length set when Auto is enabled is 128 symbols. For some modulation types, a longer length is used.
Auto	When enabled, causes the instrument to set the Analysis Length value based on the requirements of the selected display.
Time Zero Reference	Specifies the zero point for the analysis time.
Actual	This is a displayed value, not a setting. It is the Analysis Length (time or symbols) being used by the analyzer; this value may not match the Analysis Length requested (in manual mode).
Units	Sets the units of the Analysis Length to either Symbols or Seconds.

Analysis Offset

Use analysis offset to specify where measurements begin. Be aware that you cannot set the Analysis Offset outside the range of time covered by the current acquisition data. (all time values are relative to the Time Zero Reference).

You can set the Analysis Length so that the requested analysis period falls partly or entirely outside the current range of acquisition data settings. When the next acquisition is taken, its Acquisition Length will be increased to cover the new Analysis Length, as long as the Sampling controls are set to Auto. If the Sampling parameters are set to manual, or if the instrument is analyzing saved data, the actual analysis length will be constrained by the available data length, but in most cases, measurements are able to be made anyway. The instrument will display a notification when measurement results are computed from less data than requested. Range: 0 to [(end of acquisition) - Analysis Length]. Resolution: 1 effective sample (or symbol).

Analysis Length

Use the analysis length to specify how long a period of time is analyzed by a measurement. As you adjust this value, the actual amount of time for Analysis Length, in Symbol or Seconds units, is shown below the control in the "Actual" readout. This setting is not available when Auto is checked. Range: minimum value depends on modulation type. Resolution: 1 symbol. A maximum of approximately 80,000 samples can be analyzed (the actual value varies with modulation type).

Time Zero Reference

All time values are measured from this point (such as marker position or horizontal position (in Y vs Time displays). Choices are: Acquisition Start or Trigger.

Parameter	Description
Acquisition Start	Offset is measured from the point at which acquisition begins.
Trigger	Offset is measured from the trigger point.

Trace Tab

Menu Bar: Setup > Settings > Trace

The Trace tab allows you to set the trace display characteristics of the selected display.

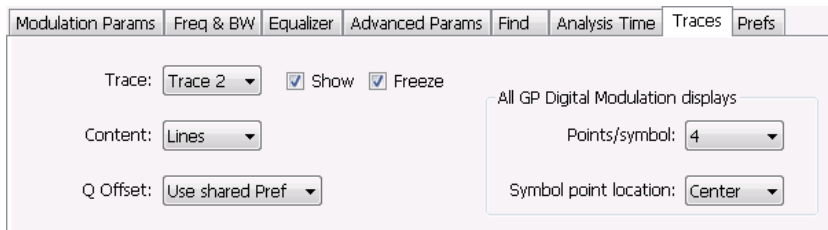

Example traces tab for constellation display set to SOQPSK modulation type

Note that some settings are not present for all modulation types and some settings are not present for all displays.

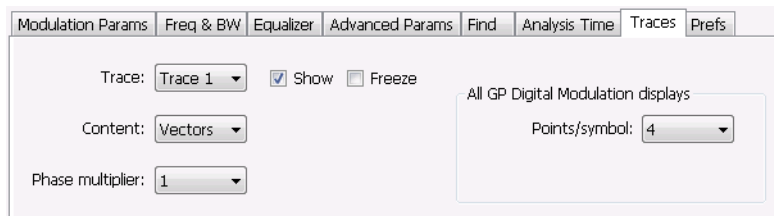

Example trace tab for constellation display set to CPM modulation type

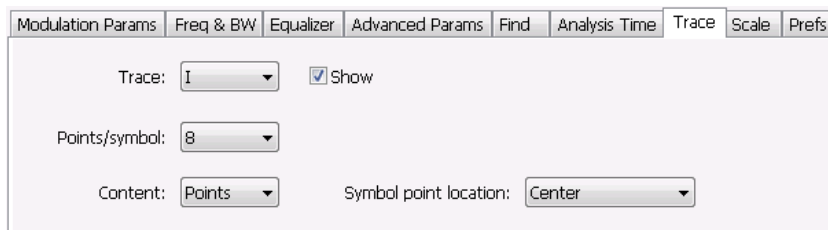

Example trace tab for Demod I&Q display

Setting	Description
Trace	Selects the trace that is hidden or displayed based on whether or not Show is selected.
Show	Specifies whether the trace selected by Trace is displayed or hidden.
Freeze	Halts updates to the trace selected by the Trace setting. Present for the Constellation display only.
Content	Selects whether to display the trace as vectors (points connected by lines), points (symbols only without lines), or lines (lines drawn between symbols, but no symbols are displayed). The choices available depend on the display.
Q Offset	For traces with offset modulation (OQPSK and SOQPSK), this setting enables the trace to be displayed with Q offset or without Q offset. Choices available are Remove Q offset , Include Q Offset , and Use Shared Pref . Selecting Use Shared Pref causes the analyzer to add or remove Q offset according to the Remove Q Offset setting located on the Prefs tab. Setting the Q Offset on the Traces tab changes the Q offset only for the Constellation display. If other GP Digital Modulation displays are shown, they will use the use the Remove Q Offset setting on the Prefs tab regardless of the Q Offset setting on the traces tab for the Constellation display. The Q Offset setting is available only when the modulation type is set to OQPSK or SOQPSK.
Points/symbol	Select how many points to use between symbols when connecting the dots. Values: 1, 2, 4, 8.
Symbol point location	Selects whether to evaluate the symbol value at the center or the end of the eye opening. This control is only present for some of the supported modulation types.
Phase Multiplier	Sets the multiplication constant for the phase multiplication display: $\times 1$ (default), $\times 2$, $\times 4$, $\times 8$, $\times 16$, or $\times 32$. The phase multiplication display facilitates observation of noisy CPM signals by multiplying measurement signal phase by the constant to reduce the number of phase states and expand the phase difference between adjacent symbols.

Comparing Two Traces in the Constellation Display

When the Constellation display is the selected display, you can use the Traces tab to enable the display of a second trace. The second trace is a version of the current acquisition. You can choose to freeze a trace in order to display the current live trace to an earlier version of itself, you can display the trace as a second trace with or without Q Offset, or you can choose to display both traces frozen in order to compare the trace to itself at different times.

To display a second trace in the Constellation display:

1. If more than one display is present, select the Constellation display to ensure it is the selected display.
2. Click the settings icon or select **Setup > Settings** from the menu bar.
3. Select the **Traces** tab.
4. Select **Trace 2** from the **Trace** drop-down list.
5. Click the **Show** checkbox so that it is checked.
6. Specify the **Content** as desired. Trace 2 lines appear in blue to aid in distinguishing Trace 2 from Trace 1.

Scale Tab

The Scale tab allows you to change the vertical and horizontal scale settings. Changing the scale settings changes how the trace appears on the display but does not change control settings such as Measurement Frequency.



Setting	Description
Vertical	Controls the vertical position and scale of the trace display.
Scale	Changes the vertical scale units.
Position	Position adjusts the reference level away from top of the graph.
Autoscale	Resets the scale of the vertical axis to contain the complete trace.
Horizontal	Controls the span of the trace display and position of the trace.
Scale	Allows you to, in effect, change the span.
Position	Allows you to pan a zoomed trace without changing the Measurement Frequency. Position is only enabled when the span, as specified by Freq/div, is less than the acquisition bandwidth.
Autoscale	Resets the scale of the horizontal axis to contain the complete trace.
Auto	

A Note About Units

The Units used for the horizontal scale can be either Seconds or Symbols. To set the units for the horizontal scale, display the **Analysis Time** tab. On the tab, select the appropriate units from the **Units** drop-down list.

Prefs Tab

The Prefs tab enables you to change appearance characteristics of the GP Digital Modulation displays.

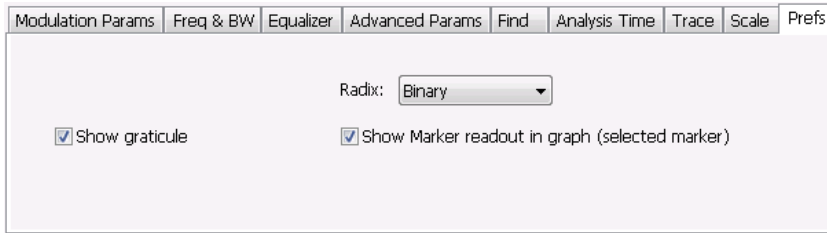

Setting	Description
Show graticule	Shows or hides the graticule.
Show Marker readout in graph (selected marker)	Shows or hides the readout for the selected marker in the graph area.
Radix	Specifies how symbols are displayed in the Symbol Table display and in the Marker readout in the Constellation display.
Remove Q offset	The I and Q data traces are displayed with an offset of half a symbol when the modulation type is set to SOQPSK or OQPSK. You can remove this offset by selecting Remove Q offset . (Which is only present when the modulation type is set to OQPSK or SOQPSK.)
Show EVM and Offset EVM results	Adds EVM results in the display when enabled (Offset EVM is always displayed). Present only in Signal Quality display and with SOQPSK and OQPSK modulation types only

Symbol Maps

This topic shows the symbol mapping for each digital modulation technique.

1	3
0	2

01	11
00	10

01	11
00	10

0169-018

Left		Right	
		3	
	2		1
6			0
	7		4
		5	

0169-009

BPSK

1	0
---	---

SBPSK

1	0
---	---

0100-010

D8PSK

Phase shift (radians)	Symbol value (binary)
0	000
$\pi/4$	001
$\pi/2$	011
$3\pi/4$	010
π	110
$5\pi/4$	111
$3\pi/2$	101
$7\pi/4$	100

Pi/2 DBPSK

Phase shift (radians)	Symbol value (binary)
$+\pi/2$	0
$-\pi/2$	1

DQPSK

Phase shift (radians)	Symbol value (binary)
0	00
$\pi/2$	01
π	11
$3\pi/2$	10

Pi/4 DQPSK

Phase shift (radians)	Symbol value (binary)
$+\pi/4$	00
$+3\pi/4$	01
$-\pi/4$	10
$-3\pi/4$	11

MSK

Phase shift direction	Symbol value (binary)
-	0
+	1

16QAM

Left		Right	
3	2	1	0
7	6	5	4
B	A	9	8
F	E	D	C

0100-010

32QAM

Left			Right		
	3	2	1	0	
9	8	7	6	5	4
F	E	D	C	B	A
15	14	13	12	11	10
1B	1A	19	18	17	16
	1F	1E	1D	1C	

0100-011

64QAM

Left				Right			
7	6	5	4	3	2	1	0
F	E	D	C	B	A	9	8
17	16	15	14	13	12	11	10
1F	1E	1D	1C	1B	1A	19	18
27	26	25	24	23	22	21	20
2F	2E	2D	2C	2B	2A	29	28
37	36	35	34	33	32	31	30
3F	3E	3D	3C	3B	3A	39	38

0169-012

128QAM

		5D	5F	4F	4D	1A	1B	0B	0A		
		5C	5E	4E	4C	18	19	09	08		
4A	48	54	56	46	44	10	11	15	14	1C	1D
4B	49	55	57	47	45	12	13	17	16	1E	1F
5B	59	51	53	43	41	02	03	07	06	0E	0F
5A	58	50	52	42	40	00	01	05	04	0C	0D
6D	6C	64	65	61	60	20	22	32	30	38	3A
6F	6E	66	67	63	62	21	23	33	31	39	3B
7F	7E	76	77	73	72	25	27	37	35	29	2B
7D	7C	74	75	71	70	24	26	36	34	28	2A
		68	69	79	78	2C	2E	3E	3C		
		6A	6B	7B	7A	2D	2F	3F	3D		

0169-017

256QAM

Left															Right
EF	FD	EB	F9	E7	F5	E3	F1	0F	3F	4F	7F	8F	BF	CF	FF
CE	DC	CA	D8	C6	D4	C2	D0	0C	3C	4C	7C	8C	BC	CC	FC
AF	BD	AB	B9	A7	B5	A3	B1	0B	3B	4B	7B	8B	BB	CB	FB
8E	9C	8A	98	86	94	82	90	08	38	48	78	88	B8	C8	F8
6F	7D	6B	79	67	75	63	71	07	37	47	77	87	B7	C7	F7
4E	5C	4A	58	46	54	42	50	04	34	44	74	84	B4	C4	F4
2F	3D	2B	39	27	35	23	31	03	33	43	73	83	B3	C3	F3
0E	1C	0A	18	06	14	02	10	00	30	40	70	80	B0	C0	F0
E1	D1	A1	91	61	51	21	11	01	13	05	17	09	1B	0D	1F
E2	D2	A2	92	62	52	22	12	20	32	24	36	28	3A	2C	3E
E5	D5	A5	95	65	55	25	15	41	53	45	57	49	5B	4D	5F
E6	D6	A6	96	66	56	26	16	60	72	64	76	68	7A	6C	7E
E9	D9	A9	99	69	59	29	19	81	93	85	97	89	9B	8D	9F
EA	DA	AA	9A	6A	5A	2A	1A	A0	B2	A4	B6	A8	BA	AC	BE
ED	DD	AD	9D	6D	5D	2D	1D	C1	D3	C5	D7	C9	DB	CD	DF
EE	DE	AE	9E	6E	5E	2E	1E	E0	F2	E4	F6	E8	FA	EC	FE

0169-013

2FSK

Left	Right
0	1

4FSK

Left	Right		
0	1	3	2

0169-014

8FSK

Left	Right						
0	1	2	3	7	6	5	4

0169-015

16FSK

Left

Right

0	1	2	3	4	5	6	7	15	14	13	12	11	10	9	8
---	---	---	---	---	---	---	---	----	----	----	----	----	----	---	---

0169-016

C4FM

Left

Right

11	10	00	01
----	----	----	----

0169-020

CPM

Phase shift (h = modulation index)	Symbol value (binary)
-3h	11
-h	10
+h	01
+3h	00

Overview: User Defined Measurement and Reference Filters

The Modulation Parameters control tab for GP Digital Modulation displays enables you to load custom measurement and reference filters. If the existing filters do not meet your requirements, you can create your own filters for use in the measurement and reference settings. This section describes the structure of user filters and provides two examples of customized filters. See [User Filter File Format \(see page 505\)](#).

Loading a User Measurement Filter

To load a your own measurement filter:

1. From the Modulation Params control tab (Settings > Modulation Params), click on the drop-down list for **Measurement Filter**.
2. Select one of the filter names that starts with **User**. This displays the **Manage user filters** window.
3. Enter a name for the filter in one of the **Name (editable)** boxes. This name will appear in the drop-down list on the Modulation Params tab, prefaced with **User**. The maximum number of characters for the filter name is 20.

4. Click the **Browse** button and navigate to the directory containing the filter you want to load. Select the filter and click **Open**. If you wish to use a filter that is not in the list, select **User other** and locate and open the file you wish to use.
5. Click **OK** to load the filter and return to the Modulation Params page.

User Filter File Format

The filter file is selected on the Modulation Params control panel tab used by the GP Digital Modulation displays (Option 21 only). It stores the user-defined measurement or reference filter coefficient data in CSV format. The following figure shows the file structure.

```
# Rate
10
# FilterI,FilterQ
0.97321,0.01947
0.89559,0.04051
0.77497,0.05942
0.62333,0.07202
0.45524,0.07438
0.28614,0.06354
...
0.13045,0.01947
```

0169-023

User filter file structure

A filter file is a plain text file, in comma-separated-variable format. The file extension must be CSV.

The filter file contains the following variables:

Rate. Specifies the oversampling rate (the number of samples per symbol). The filter coefficient data will be interpolated by the specified rate.

FilterI,FilterQ. Specifies IQ pairs (1 to 1024) of the filter coefficient in time domain.

Rules for Creating a Filter File

- A line beginning with “#” is a comment line.
- Enter a positive value for the oversampling rate.
- A decimal number can be expressed by fixed point or floating point. For example, 0.01 and 1.0E-2 are both valid.
- “0” (zero) and “,0” (comma zero) can be omitted. For example, “1.5,0”, “1.5,”, and “1.5” are equivalent.
- Lines with only a comma and blank lines are skipped.

Example filters. For your reference, two example filters, Raised Cosine and Gaussian, are shown here. Both filters contain 65 data points with an oversampling rate of 8.

Raised Cosine ($\alpha = 0.3$)

(Row 1 to 18)	(Row 19 to 36)	(Row 37 to 54)	(Row 55 to 68)
# Rate	0.0383599,0	0.973215,0	0.0743803,0
8	0,0	0.895591,0	0.0720253,0
# FilterI,FilterQ	-0.047715,0	0.774975,0	0.0594205,0
0,0	-0.0984502,0	0.623332,0	0.0405144,0
-0.0062255,0	-0.143898,0	0.455249,0	0.0194761,0
-0.0136498,0	-0.174718,0	0.286147,0	0,0
-0.0209294,0	-0.181776,0	0.130455,0	-0.0151973,0
-0.0263419,0	-0.157502,0	0,0	-0.0246357,0
-0.0280807,0	-0.0971877,0	-0.0971877,0	-0.0280807,0
-0.0246357,0	0,0	-0.157502,0	-0.0263419,0
-0.0151973,0	0.130455,0	-0.181776,0	-0.0209294,0
0,0	0.286147,0	-0.174718,0	-0.0136498,0
0.0194761,0	0.455249,0	-0.143898,0	-0.0062255,0
0.0405144,0	0.623332,0	-0.0984502,0	0,0
0.0594205,0	0.774975,0	-0.047715,0	
0.0720253,0	0.895591,0	0,0	
0.0743803,0	0.973215,0	0.0383599,0	
0.063548,0	1,0	0.063548,0	

Gaussian (BT = 0.5)

(Row 1 to 18)	(Row 19 to 36)	(Row 37 to 54)	(Row 55 to 68)
# Rate	0.00191127,0	0.978572,0	0.000401796,0
8	0.00390625,0	0.917004,0	0.000172633,0
# FilterI,FilterQ	0.00764509,0	0.822878,0	7.10E--05,0
2.33E-10,0	0.0143282,0	0.707107,0	2.80E-05,0
9.11E-10,0	0.0257149,0	0.581862,0	1.06E-05,0
3.42E-09,0	0.0441942,0	0.458502,0	3.81E-06,0
1.23E- 08,0	0.0727328,0	0.345977,0	1.32E-06,0
4.21E-08,0	0.114626,0	0.25,0	4.37E-07,0
1.39E-07,0	0.172989,0	0.172989,0	1.39E-07,0
4.37E-07,0	0.25,0	0.114626,0	4.21E-08,0
1.32E-06,0	0.345977,0	0.0727328,0	1.23E-08,0
3.81E-06,0	0.458502,0	0.0441942,0	3.42E-09,0
1.06E-05,0	0.581862,0	0.0257149,0	9.11E-10,0
2.80E-05,0	0.707107,0	0.0143282,0	2.33E-10,0
7.10E-05,0	0.822878,0	0.00764509,0	
0.000172633,0	0.917004,0	0.00390625,0	
0.000401796,0	0.978572,0	0.00191127,0	
0.000895512,0	1,0	0.000895512,0	

Using Markers

Markers are indicators in the display that you can position on a trace to measure values for the X and Y axes, such as frequency, power, and time. A Marker always displays its position and, if enabled, will display the difference between its position and that of the Marker Reference (MR).

You can display up to five markers including the reference marker. Markers can all be placed on the same trace or they can be placed on different traces. There are three types of Markers: Reference, Delta, and Power Markers. The Marker Reference (labeled MR in the graph) makes absolute measurements and is also used for calculating differences when Delta or Power readouts are enabled. The Delta Markers (labeled M1 to M4 in the graph) are used to measure other points on the trace or the difference between the Marker Reference and the Delta marker. The Power Markers (labeled M1 to M4 in the graph) function the same way as the Delta Markers, except they show power density and integrated power density (dBm/Hz) instead of power level (dBm).

The following two tables show the appearance of the four types of marker readouts.

Marker Reference Readout	Absolute Marker Readout	Power Marker Readout	Delta Marker Readout
<p>Reference Marker label</p> <p>Power level at marker</p> <p>Frequency at marker</p>	<p>Absolute Marker label</p> <p>Power level at marker</p> <p>Frequency at marker</p>	<p>Power density at Power Marker</p> <p>Power density at Power Marker</p> <p>Difference in frequency between Power Marker and Reference Marker</p> <p>Integrated power value from points between and including Reference Marker to Power Marker</p> <p>Integrated power density value from points between and including Reference Marker to Power Marker</p>	<p>Delta Marker label</p> <p>Difference in power level between Delta Marker and Marker Reference</p> <p>Difference in frequency between Delta Marker and Marker Reference</p>

The following table shows the appearance of the marker indicators as they appear on the trace. Whichever marker is active will appear as a solid diamond.

Marker Reference	Absolute, Delta, and Power Marker

Controlling Markers with the Touchscreen Actions Menu

In addition to controlling the marker actions from the front panel or screen menu items, you can use the touch screen actions menu to move markers or add and delete markers.

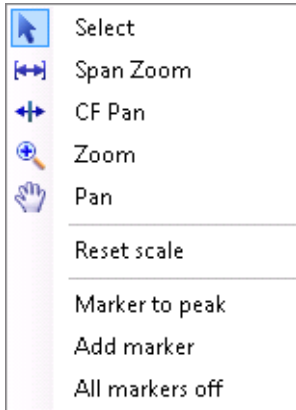

To use the Touchscreen Actions menu, touch the display and hold for one second, then remove your finger. You can also use a mouse to display the Touchscreen Action menu by clicking the right mouse button.

Menu item	Description
Marker to peak	Moves the selected marker to the highest peak. If no marker is turned on, this control automatically adds a marker.
Next Peak	Moves the selected marker to the next peak. Choices are Next left, Next right, Next lower (absolute), and Next higher (absolute).
Add marker	Defines a new marker located at the horizontal center of the graph.
Delete marker	Removes the last added marker.
All markers off	Removes all markers.

Markers Context Menu

The Markers context menu appears when you right-click (or touch and hold) on a marker. The Markers context menu enables you to assign a marker to a different trace, synchronize markers with oscilloscope cursors and pan the trace to place the marker at the measurement frequency.

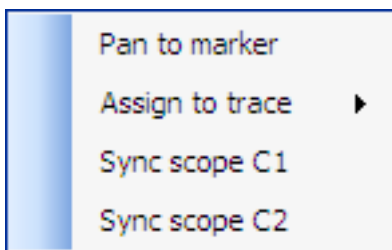

Icon	Menu	Description
-	Pan to marker	Adjusts horizontal position of the waveform to locate the selected marker at the measurement frequency.
-	Assign to trace	Assigns the selected marker to Trace 1, Trace 2, Trace 3 or the Math trace. A trace must be enabled to assign a marker to it.
-	Sync scope C1	Synchronizes the position of oscilloscope Cursor 1 with the location of the selected marker. Turns on cursors if necessary.
-	Sync scope C2	Synchronizes the position of oscilloscope Cursor 2 with the location of the selected marker. Turns on cursors if necessary.

Measuring Frequency and Power in the Spectrum Display

To measure the frequency and power at a point on a Spectrum trace:

1. Select **Markers > Define Markers**.
2. Select the **Marker Properties** tab.
3. Click **Add**. This displays a drop-down list under **MR** (Marker Reference), found inside the **Reference** box. The first marker defined is always designated the Marker Reference. Subsequently defined markers are Delta Markers for which readouts can be selected for Delta, Power, or Absolute. You can also select and adjust markers by clicking on an existing marker on a trace.
4. From the drop-down list, select the trace to which you want to assign the marker.

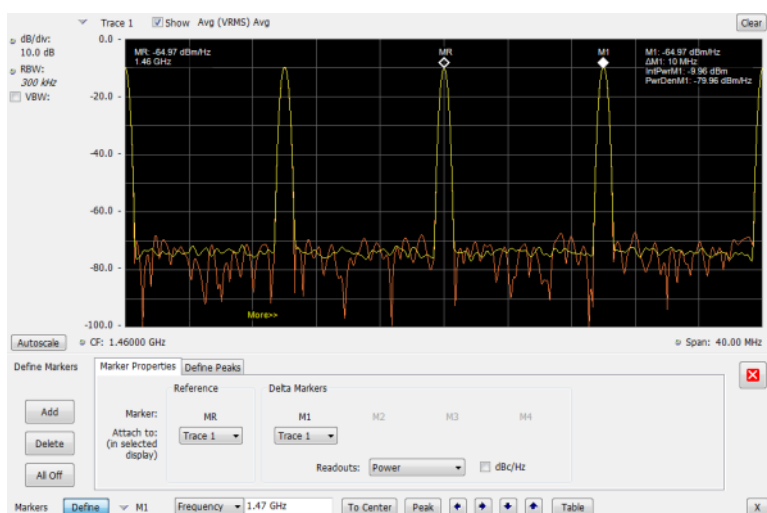

5. Click the close control panel button to remove the Define Markers control panel.
6. Click on the marker on the trace to activate that marker.
7. Drag the marker in the graph using the touchscreen or a mouse to move the marker to the desired location on the trace. You can also click on the marker location text box in the Markers toolbar at the bottom of the screen and adjust it with your mouse wheel. The Peak button in the Markers toolbar and the arrow buttons to the right of it control marker peak searching on the trace.
8. Read the frequency and power level of the marker position on the display.
9. Read the signal density, frequency, and power level of the marker position on the display.
10. If Power markers are selected, read the point power density and the integrated power density.

Marker Action Controls

Controls for enabling and moving markers and for initiating marker peak searches are found in several locations. There are buttons for a few of the most common marker activities on the front panel of the instrument, used along with the knob for adjusting marker positions. The Markers menu contains selections for peak searches. Each graph display has a Marker button on the status bar that provides access to the Markers toolbar. The Markers toolbar has buttons for peak searches, centering, and defining markers.

Peak

Selecting **Peak** from the Markers menu moves the selected marker to the highest level peak within the acquisition record.

Next Peak

Selecting Next Peak displays a submenu that enables you to move the selected marker to the next peak.

Setting	Description
Next Left	Moves the selected marker to the next peak to the left of the current marker position.
Next Right	Moves the selected marker to the next peak to the right of the current marker position.
Next Lower (absolute)	Moves the selected marker to the lower level peak (in absolute terms) on the trace.
Next Higher (absolute)	Moves the selected marker to the higher level peak (in absolute terms) on the trace.

Marker to Center Frequency

Changes the center frequency to match the frequency of the selected marker.

Sync Scope C1/C2 to Active Marker

Moves the selected oscilloscope cursor (Cursor 1 or Cursor 2) to the location on the oscilloscope waveform that matches the location of the active marker on the SignalVu active marker. If the oscilloscope cursors are off, this command turns them on. These commands are also available from the Markers context menu.

Enabling Markers and Setting Marker Properties

The Define Markers Control Panel is used to enable markers and set their properties. You can set up to five markers including the marker reference. Markers are shown in most displays.

Markers have three types of on-screen readouts: Absolute, Delta, and Power. When **Readouts** is set to **Absolute**, each readout displays only the marker's position on the trace. In Frequency displays, this means the marker readout shows the frequency and power of the trace at the marker position. When **Readouts** is set to **Delta**, each delta marker (M1-M4) readout displays both the marker's position on the trace and the difference between its position and the position of the Reference Marker (MR). When **Readouts** is set to **Power**, each delta marker (M1-M4) readout displays the marker's position on the trace, the difference between its position and the position of the Reference Marker (MR), the point power density, and the integrated power density.

Defining Markers

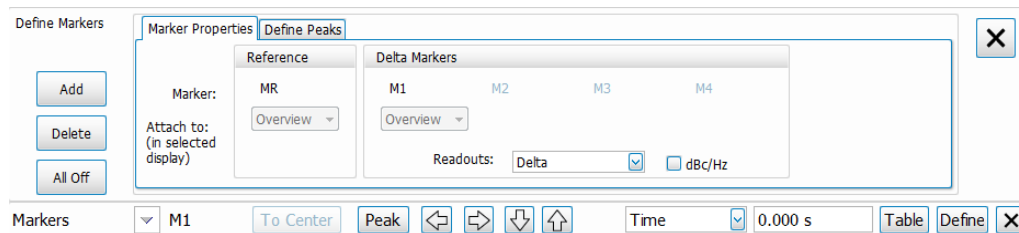

1. Click the **Markers** button on the basic control toolbar to view the Markers toolbar.
2. Click the **Define** button on the Markers toolbar to open the Define Markers control panel.
3. In the Marker Properties tab, select **Add** to turn on the next marker. A drop-down list under the marker label allows you to assign the marker to a trace.

NOTE. The first marker defined will always be **MR**. The MR marker is the reference for delta marker readouts.

4. Select the trace to which the marker should be attached from the drop-down list.
5. Click **Add** to add additional markers.
6. Click on the **Readouts** drop down menu to select the readout to view. If you select Delta from the drop down menu, you can check the **dBc/Hz** box to measure noise in dBc/Hz and show that for the delta value. Checking this box if other readouts are selected will force the readout to Delta. You can read more about marker noise (dBc/Hz) mode [here \(see page 516\)](#).
7. Click the close button to remove the Define Markers control panel.

Defining Peaks

You can specify two amplitude values that define peaks.



Amplitude

Peak Threshold	Peak Threshold specifies the level that the signal must exceed to be considered a peak.
Minimum Excursion	Minimum Excursion specifies how much the signal must decrease and then increase before another peak can be declared.

1. Select **Markers > Define Markers** to display the Define Markers control panel.
2. Select the **Define Peaks** tab.
3. To define the level for Peak Threshold, enter a value in the Peak Threshold number entry box.
4. To define the amount the trace must dip, enter a value in the Peak Excursion number entry box.
5. Click the close button to remove the Define Markers control panel.

Using the Markers Toolbar









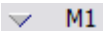

Favorites toolbar:

Status bar: Markers button

Select **Markers** to display or hide the Markers toolbar at the bottom of the application window. The Markers toolbar enables you to operate existing markers or define new markers.



Enabling a marker or adjusting the position of a marker automatically opens the Markers toolbar.

Icon / Readout	Description
	Opens the Define Markers control panel.
	Selected marker readout. This readout shows which marker is selected. The pop-up menu allows you to choose the selected marker, add markers, and turn all markers off.
	Marker position controls. For frequency displays, this readout shows the marker position in Hertz. For time displays, this readout shows the marker position in seconds. The position of the selected marker can be changed by selecting the numeric readout and using the knob to adjust the value.
	Changes the analyzer's Center Frequency to the frequency of the selected marker. Not selectable for time markers.
	Moves the marker to the highest peak on the signal. On displays that scale about zero on the vertical axis (for example, Magnitude Error, EVM, and Frequency vs. Time), the highest peak selected by the Peak button is an "absolute value", therefore, negative peaks are included in the search for the highest peak.
	Moves the selected marker to the next peak to the left of the current position.
	Moves the selected marker to the next peak to the right of the current position.
	Moves the selected marker to the next lower peak value. The peak value here refers to the numeric value of the peak amplitude. Thus, when repeatedly moving the marker, it can move to the right or left depending on the location of the next lower value.
	Moves the selected marker to the next higher peak value. The peak value here refers to the numeric value of the peak amplitude. Thus, when repeatedly moving the marker, it can move to the right or left depending on the location of the next higher value.
	Displays/hides the marker table from the display.
	Removes the Markers toolbar from the display.

Measuring Noise Using Delta Markers in the Spectrum Display

In the Spectrum display, you can set Markers to dBc/Hz to measure noise on the trace. Markers in this mode operate just as they do in normal mode, but the readouts for the markers are in dBm/Hz and dBc/Hz.

dBm/Hz is the power in milliwatts referenced to a 1 Hz bandwidth. To make this measurement, the analyzer assumes that the measured signal is random noise. It then converts the measured power (made at any RBW) to the power that would be measured had a 1 Hz filter been applied for the measurement.

dBc/Hz represents dBm/Hz referenced to a carrier. Here, it is assumed that the carrier is a CW signal, and its signal level does not change when the RBW is changed, so the Reference Marker measurement on the carrier is unchanged from any other marker measurement. However, the delta marker values are converted to dBm/Hz, and then a difference value, in dBc/Hz, is calculated between each delta measurement and the reference.

Measuring Noise

To measure noise on a Spectrum trace:

1. Select **Markers > Define** to display the Markers control panel.
2. Click **Add**. The first marker defined is always designated the Marker Reference. Subsequently defined markers are Delta Markers for which readouts can be selected for Delta, Power, or Absolute. You can also select and adjust markers by clicking on an existing marker on a trace.
3. Click **Add** again so that there are at least two markers defined.
4. Check that **Readouts** is set to Delta and check the **dBc/Hz** box.
5. If you have more than one trace defined, use the drop-down list for each marker to set it to the trace on which you want to measure noise.
6. Notice that Detection is set to **Average** for the trace you are using for this measurement.
7. Check that the Amplitude units are set to dBm (that is the default). If they are not, click the  (Analysis) icon, select the **Units** tab, and select **dBm**.
8. Click the Close button to remove the control panel.
9. Move the markers to the desired locations on the trace.
10. Read the frequency and power level for the selected marker in the upper corners of the display. To display the delta measurement in dBc/Hz, select the delta marker (M1, M2, M3 or M4) by clicking on it or by selecting it in the drop-down marker list in the Markers toolbar.

The following image shows the Spectrum display with a Delta Marker.

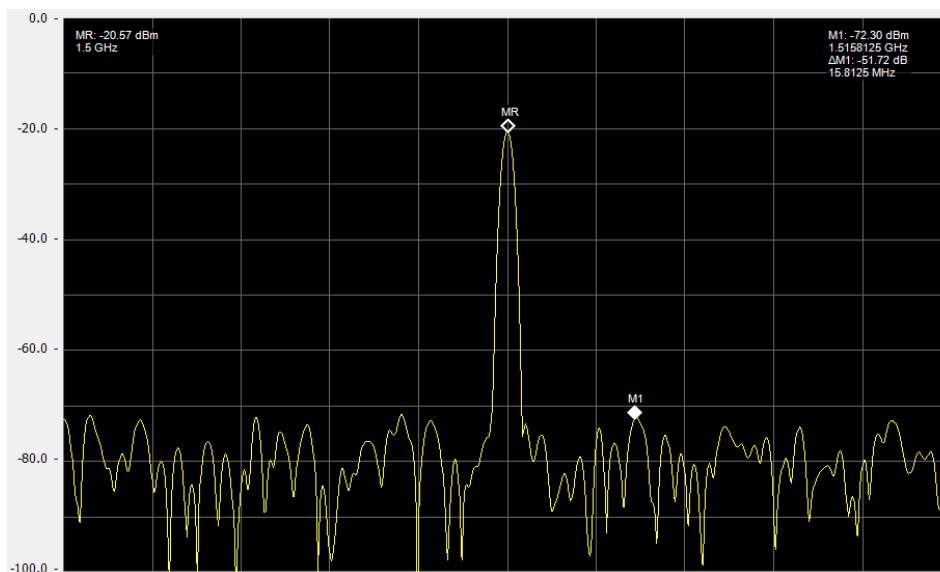

The following image shows the Spectrum display with Power Markers.

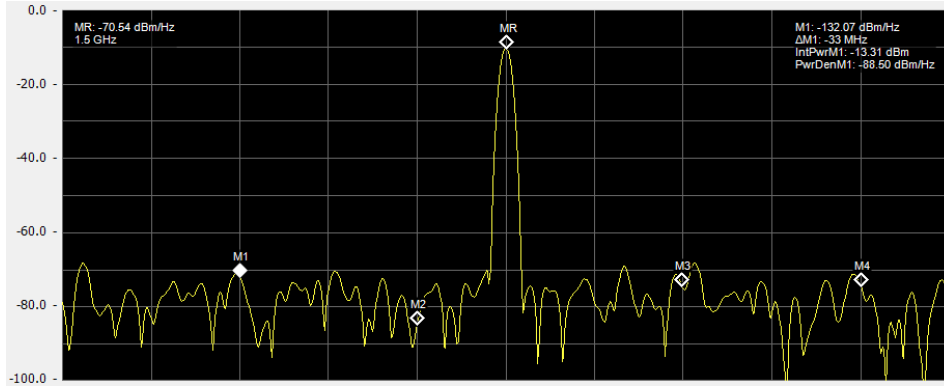

The Mask Test Tool

You can specify pass/fail and mask parameter conditions for the Spectrum, Spurious, Gain, Frequency Settling Time and Phase Settling Time displays. When these conditions are met, the instrument can perform actions such as stopping acquisitions or saving data.

Mask Test Settings

Menu Bar: Tools > Mask Test

Selecting **Mask Test** displays the Mask Test control panel. These settings define test parameters and specify actions to be performed when the test conditions are met. Checking the **Enable Test** box sets the application to perform the test once the conditions are defined.

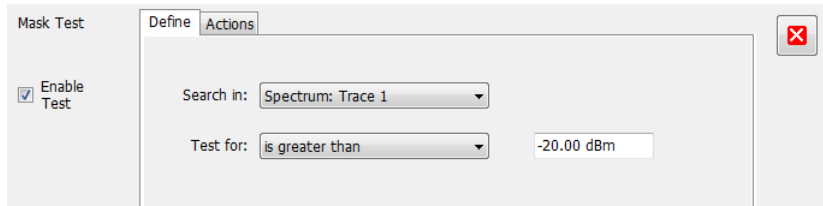

Setting	Description
Enable Test	Select to perform a test, then set the test conditions.
Define (see page 519)	Specifies which result to test and what to test for.
Actions (see page 524)	Specifies the action to take when the test condition is met.

Define Tab (Mask Test)

The Define tab sets the parameters for tests. From this tab, you specify which result to test and what kind of violation to test for.

The following image shows the Define tab with *is great than* selected. After you select that test, you will enter the desired signal level. The procedure is the same if you select *is less than*.

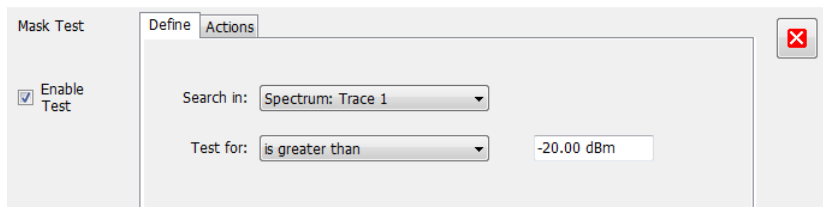

The following image shows the Define tab with *is outside mask* selected. After you select that test, you need to click the Edit limits button and set the desired test limits. The procedure is the same if you select *is inside mask*.

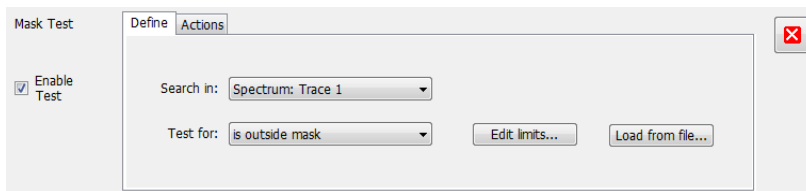

Setting	Description
Search in	Specifies which result to test.
Test for	Specifies what to test for. You can specify a test based on a signal level ("is greater than", "is less than") or a mask ("is outside mask", "is inside mask"). Options for Spurious and Settling Time are Pass and Fail.

Search In

The possible choices for **Search in** include traces from Spectrum, DPX, Noise Figure, Spurious, and Settling Time displays. The available choices are Trace 1, Trace 2, Trace 3, Math, Spectrogram Trace, Spurious, and Settling Time. The available choices include only results from displays that are currently open.

NOTE. If you select a result that is not the selected trace or result in the target display, you will not see the results of the test. To see the results, select the trace from the drop-down menu in the target measurement

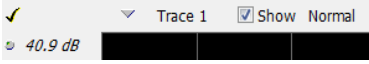
display and check the Show box: 

Test For

The **Test for** setting has selections that vary based on which display's results you are testing.

Pass/Fail Tests for Spurious and Settling Time

The Frequency Settling Time, Phase Settling Time measurements, and Spurious measurements test functions provide pass/fail results.

Greater Than/Less Than Tests for Spectrum

If you select a greater than/less than test, you also specify the level that defines a violation. When you select either **is greater than** or **is less than**, a text entry box appears to the right of the drop-down list. Use the text entry box to specify the signal level you wish to test for. While not as flexible as mask testing, this type of test is quicker to set up.

The following figure shows the results of an **is greater than** test. The vertical red bar highlights results that match the test definition.

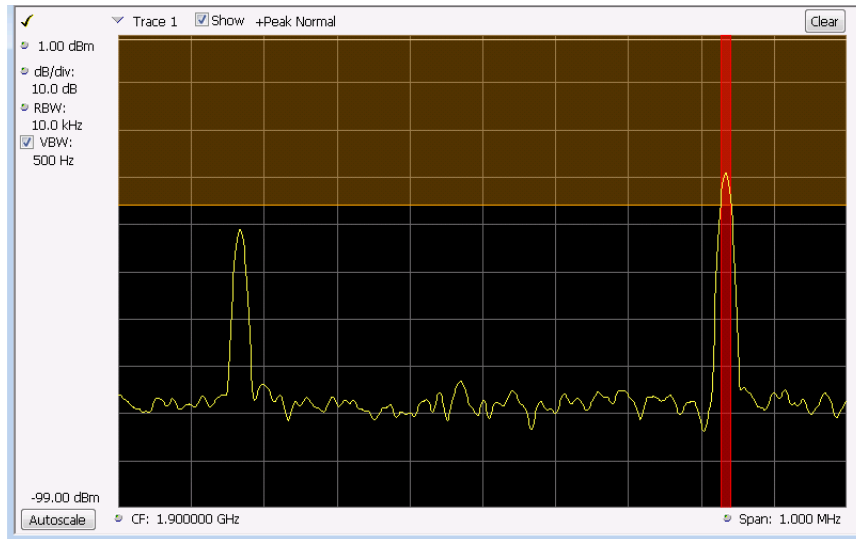

Outside/Inside Mask Tests

If you specify a mask-based test, then you need to edit the mask to specify the levels that define a violation. When you select **is outside mask** or **is inside mask**, an **Edit limits** button is displayed. Click the **Edit limits** button to display the Mask Test Editor window.

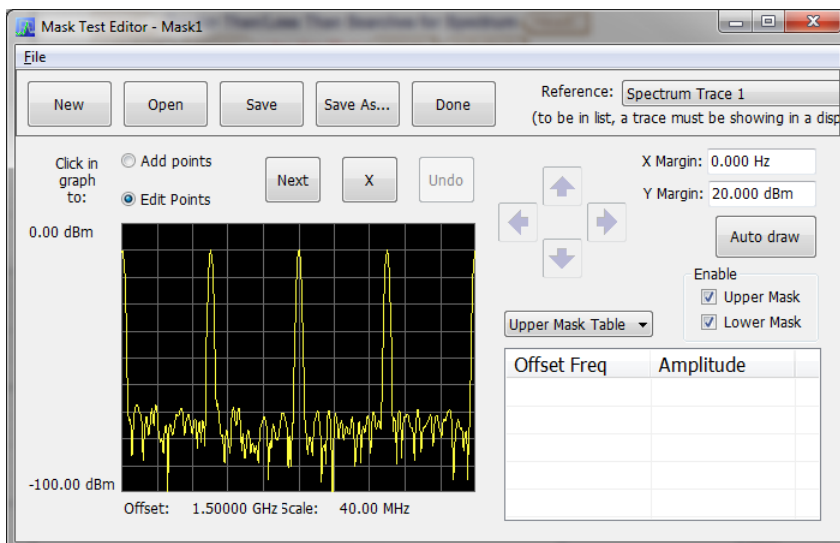

To set up and save mask test limits for a test. Perform the following procedure to set up a test using the mask limits.

1. After choosing the desired **Search in** and **Test for** items, click **Edit limits** to display the Mask Test Editor window.
2. Click the **New** button to create a table. This clears the existing points and loads the default table. You can also click **Open** to open an existing table.
3. To edit values, add points, or delete points in a table:
 - a. To edit an existing value, double-click on the cell you want to edit and enter the desired value. The active point shows as a red point on the plot.

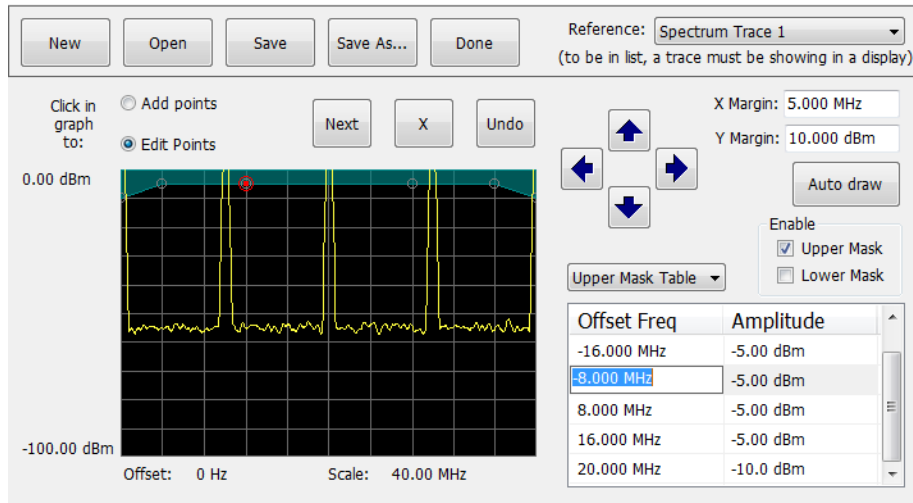

- b. To add a new point, check the box next to the target mask (located below the **Auto draw** button).
- c. Select **Add points** located below the **Open** button.
- d. Select the target mask (Upper Mask Table or Lower Mask Table) from the drop-down menu.
- e. Click in the desired location on the plot to add the point.

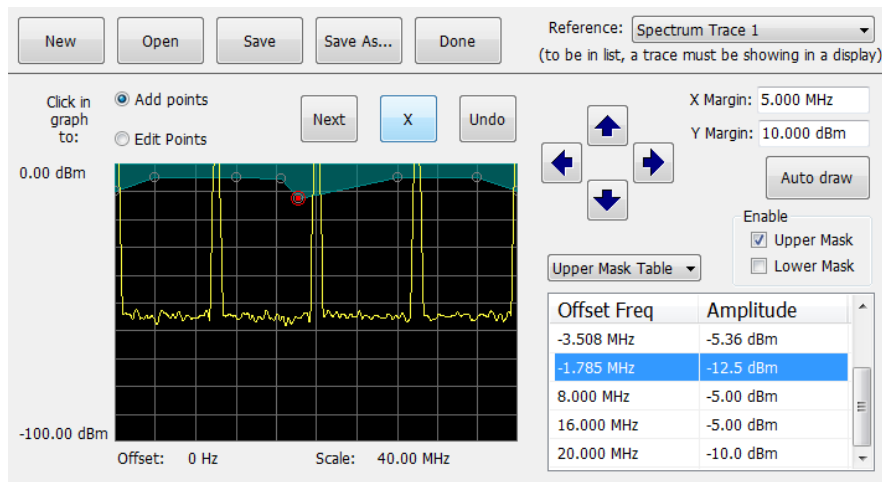

- f. To use the auto draw feature to automatically place points on the chosen mask, enable the desired mask from the drop-down menu and then click the **Auto draw** button.

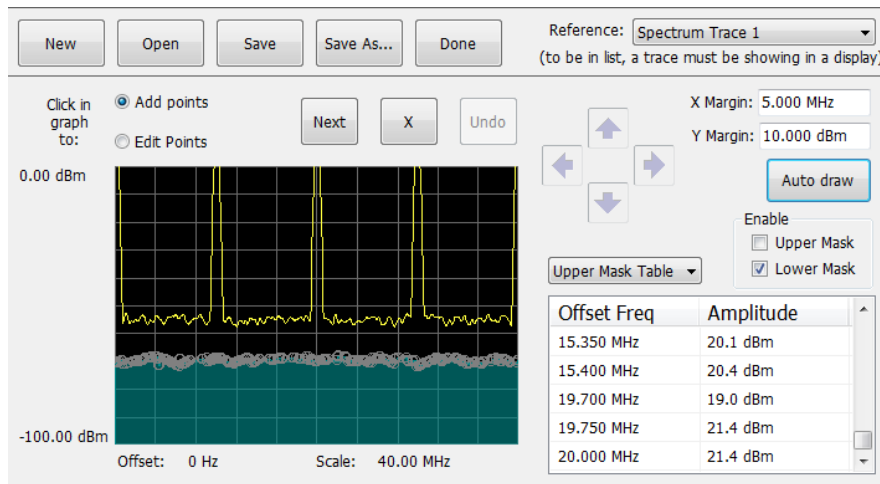

NOTE. Units may be changed for measurements other than Noise Figure in Setup > Analysis > Units.

4. To delete a point from the table, select the point to be removed, and click the **X** button.
5. To save the mask to a file for later recall, click **Save As**.
6. From the Save As dialog, name the file and save it in the desired location.

NOTE. Masks are saved in XML format with a .msk extension.

7. To dismiss the Mask Test Editor window, click **Done**.

Mask Test Result Example

The following figure shows the results of a Spectrum **is outside mask** test with Upper Mask enabled. The vertical red bar highlights results that have exceeded the test limits. The shaded region shows the mask area.

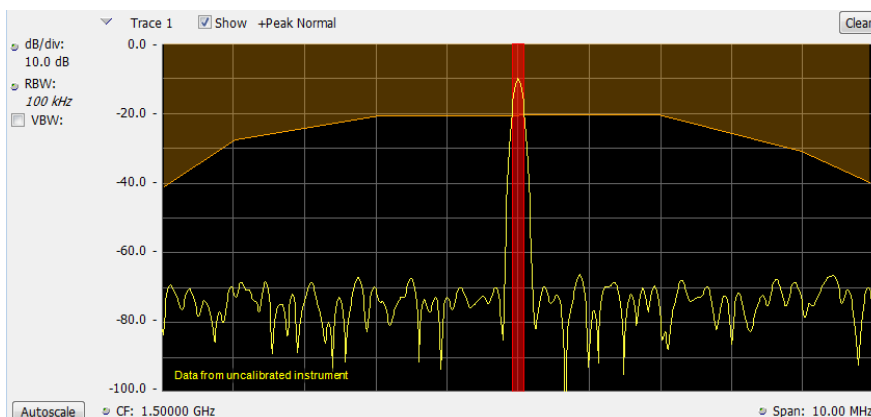

Actions Tab

The Actions tab allows you to trigger the application when a signal in the frequency domain violates the mask.

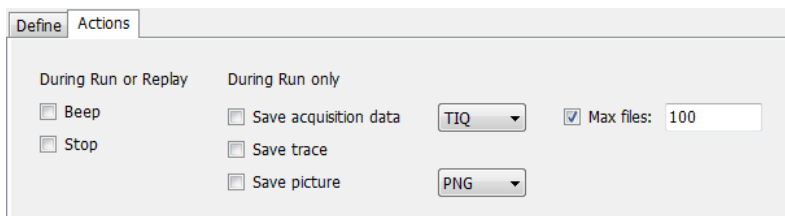

Setting	Description
During Run or Replay	Actions specified here will occur in either Run mode or Replay mode.
Beep	The analyzer beeps when the test condition is met. There will be no sound if the instrument hardware does not support audible output.
Stop	The analyzer stops when the test condition is met.
During Run Only	Actions specified here are taken only during Run mode (while acquiring live data).
Save acquisition data	Saves acquisition data to a file when the test condition is met. Use the drop-down list to specify the format of the saved data. The available file formats are: TIQ , CSV , and MAT (see page 567) .
Save trace	Saves Trace data to a file when the test condition is met.
Save picture	Saves a screen capture to a file when the test condition is met. Use the drop-down list to specify the format of the saved picture. The available file formats are: PNG , JPG , and BMP (see page 567) . Note that no trace will be saved if the tested trace isn't a saveable trace type. For example, a Spurious trace is not saveable.
Max files	Specifies the number of times a test action stores a file. After this limit is reached, no more files are saved. The instrument will continue to run, but no additional files are saved when test conditions are met. Keep in mind when setting this number that picture files are counted as part of the total number of files. For example, if you set Max files to 100, the instrument will save 100 acquisitions if only acquisitions are saved or only pictures are saved. But, if both acquisitions and pictures are saved, then 50 acquisitions and 50 pictures will be saved.

AutoSave File Naming

When one of the AutoSave actions is enabled, the name of the saved file is automatically incremented even if the **Automatically generate filenames** option (Tools > Options > Save and Export) is not enabled. When the file is saved, it will be saved to *C:\<instrument name>Files*.

Analysis Settings

Menu Bar: Setup > Analysis

Favorites toolbar: 

The Analysis control panel provides access to settings that are used by all displays. These settings affect only post processing and they do not control hardware settings.

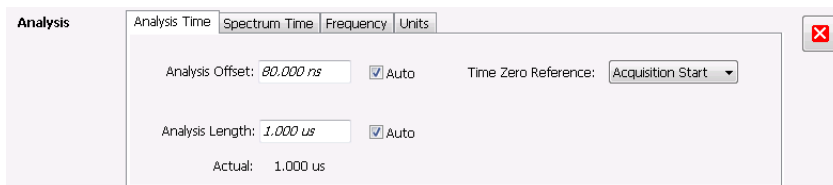

Setting	Description
Analysis Time (see page 525)	Specifies the length of time to use in measurements.
Spectrum Time (see page 527)	Specifies whether the Spectrum Analysis display uses the same Analysis Time parameters as all the other displays or if it uses a different Offset and Length.
Frequency (see page 527)	Specifies the measurement frequency (center frequency).
Units (see page 530)	Specifies the Power units for all displays.

Analysis Time Tab

The Analysis Time tab contains parameters that define the portion of the acquisition record that is used for analysis.

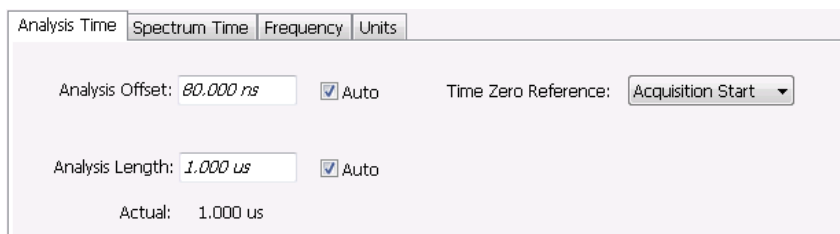

Setting	Description
Analysis Offset	Specifies the location of the first time sample to use in measurements.
Auto	When enabled, causes the instrument to set the Analysis Offset value based on the requirements of the selected display.
Analysis Length	Specifies the length of time to use in measurements.
Auto	When enabled, causes the instrument to set the Analysis Length value based on the requirements of the selected display.
Time Zero Reference	Specifies the zero point for the analysis time.
Actual	This is a displayed value, not a setting. It is the Analysis Length (time) being used by the analyzer; this value may not match the Analysis Length requested (in manual mode).

Analysis Offset

Use analysis offset to specify where measurements begin. Range: 0 to [(end of acquisition) - Analysis Length)]. Resolution: 1 effective sample (or symbol).

Analysis Length

Use the analysis length to specify how long a period of time is analyzed by a measurement. After you enter a value, this box changes to show the actual value in use, which is constrained by Acquisition Time. This setting is not available when Auto is checked. Range: minimum value depends on modulation type to Acquisition Length. Resolution: 1 effective sample (or symbol).

Time Zero Reference

The analysis offset is measured from this point. Choices are: Acquisition Start or Trigger Point.

Parameter	Description
Acquisition Start	Offset is measured from the point at which acquisition begins.
Trigger Point	Offset is measured from the trigger point.

Spectrum Time Tab

This tab controls whether the Spectrum display uses the same Analysis Time parameters as all the other views or uses a different Offset and Length.

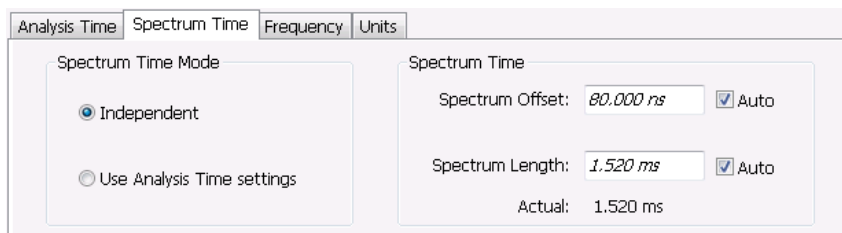

Settings	Description
Spectrum Time Mode	
Independent	Causes the spectrum analysis views to use the settings unique to those displays.
Use Analysis Time settings	Causes the spectrum analysis views to use the settings on the Analysis Time tab.
Spectrum Time (only available when <i>Independent</i> is selected)	
Spectrum Offset	Sets the beginning of Spectrum Time with respect to the selected time reference point (selectable in the Analysis Time tab as either Acquisition Start or Trigger).
Spectrum Length	The amount of data, in terms of time, from which spectrum traces are computed.
Auto	When enabled, causes the instrument to set the Spectrum Length value based on the RBW setting.
Actual	This is a displayed value, not a setting. It is the Spectrum Length (time) being used by the analyzer; this value may not match the Spectrum Length requested (in manual mode). The actual spectrum length is always an integer multiple of the time needed to support the RBW value.

Frequency Tab

The Frequency tab specifies two frequency values: the Measurement Frequency and the Spectrum Center Frequency. The Measurement Frequency is the frequency at which most displays take measurements. The Spectrum Center Frequency is the center frequency used by the Spectrum, DPX Spectrum, Spectrogram and Time Overview displays.

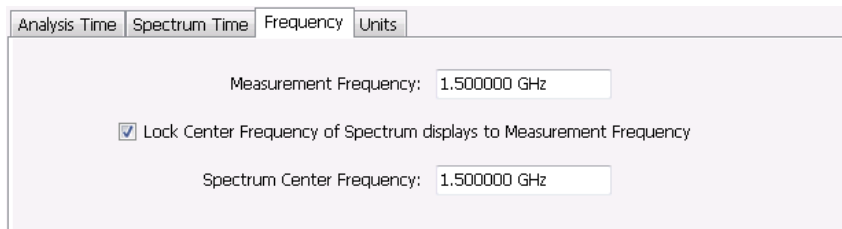

The following screen capture shows a display with both the Measurement Frequency and the Spectrum Center Frequency locked together.

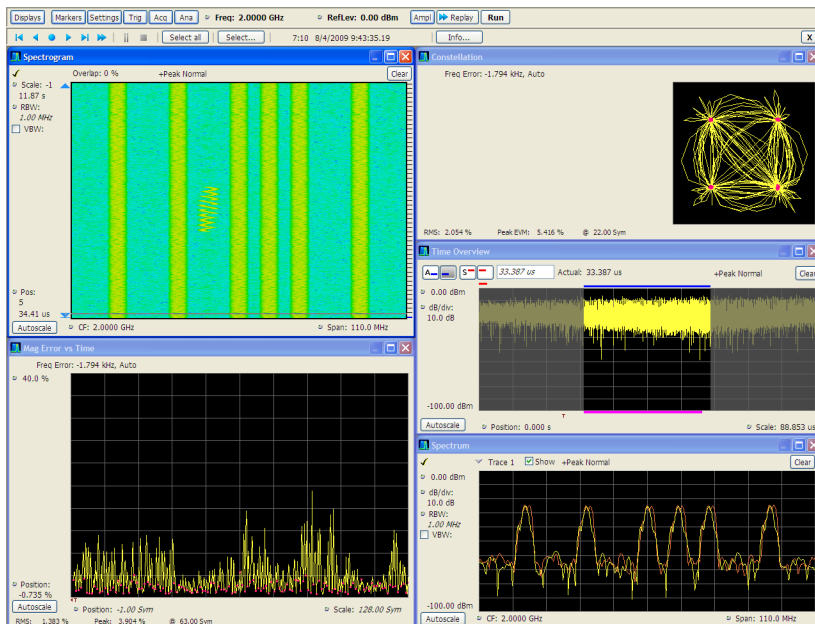

Normally, the Measurement Frequency and the Spectrum Center Frequency are locked together so that both have the same setting. But in some situations, for example, where a signal contains a set of channels, it is useful to unlock the Measurement Frequency from the Spectrum Center Frequency. When the Spectrum Center Frequency is unlocked from the Measurement Frequency, you can adjust the Measurement Frequency so that measurements can be taken at different frequencies without resetting the center frequency. The following screen capture shows the magenta-colored measurement frequency indicator still located at the center frequency.

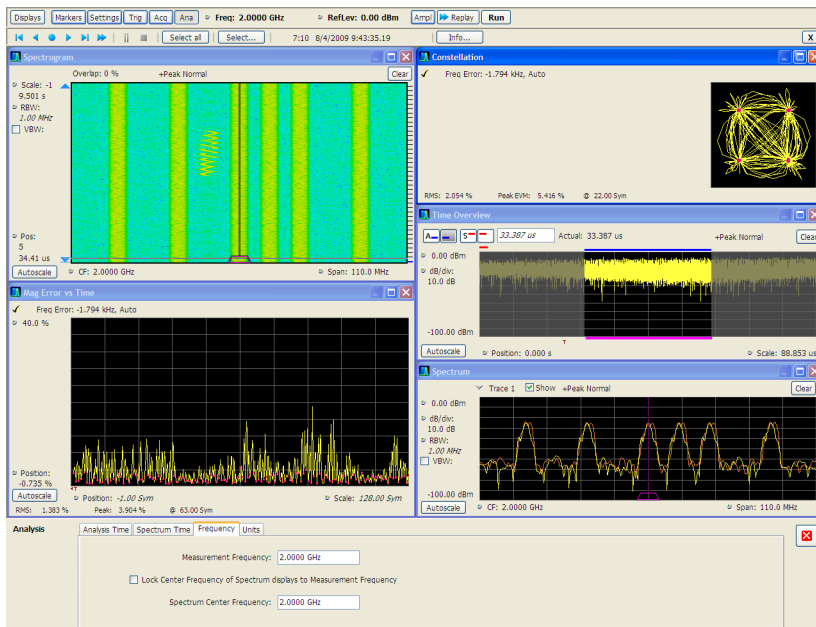

The following screen capture shows the measurement frequency indicator located at 2.0402 GHz while the Spectrum Center Frequency is still located at 2.0000 GHz.

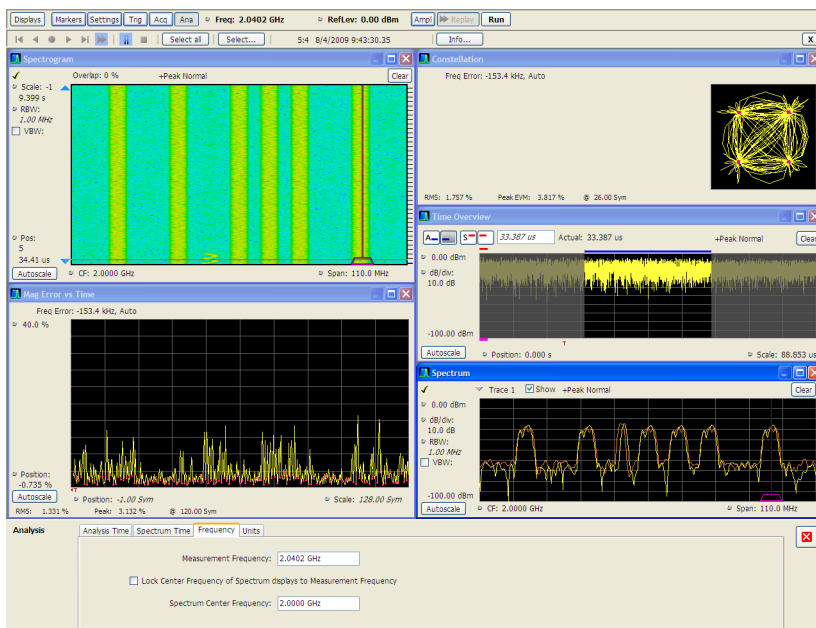

You can drag the Measurement Frequency indicator on the screen to set the measurement frequency. Note the base of the Measurement Frequency indicator. The width of the box indicates the widest measurement bandwidth in use among the open displays. You can see how the width of this box changes with the measurement bandwidth by, in this example, adjusting the Measurement BW setting for the Constellation

display (Settings > Freq & BW tab). As you adjust the setting, you will see how the width of the box at the base of the Measurement Frequency Indicator changes.

The Measurement Frequency indicator is useful for interpreting system behavior when MeasFreq is unlocked. If a measurement has a wide bandwidth relative to the spectrum span, and the Measurement Frequency is far from spectrum center, the measurement is likely to fail because its required frequency range exceeds the frequency range of the available data. In such a case, the navigation control will show that the measurement bandwidth extends outside the Spectrum's span.

There are interactions between frequency unlocking and RF & IF Optimization (see the [Amplitude control panel \(see page 537\)](#)). When **Best for multiple displays** is the selected optimization, the instrument is allowed to use its full bandwidth to meet the needs of all open displays. This is the most user-friendly optimization because it decreases the number of **Acq BW too small** errors, but it can increase noise and slightly decrease measurement accuracies. For all other optimization types, the instrument optimizes the acquisition bandwidth for the selected display, improving measurement quality somewhat, but reducing concurrent measurement capability.

There are also interactions with trigger settings. When the Spectrum Center Frequency is unlocked from Measurement Frequency, the RF triggers (Trigger Source = RF Input) can tune to either Spectrum Center Frequency or Measurement Frequency. When a spectrum display is selected, the trigger frequency is the same as the Spectrum Center Frequency. When one of the other displays that uses Measurement Frequency is selected, the trigger is tuned to the Measurement Frequency also. This allows you to trigger on the signal you are measuring. But, there is an exception: when the selected RF & IF Optimization is **Best for multiple displays**, the trigger is always tuned to the Spectrum Center Frequency.

The reason the trigger frequency is affected by Measurement Frequency and RF & IF Optimization, is that these functions control how the acquisition is tuned. The optimization **Best for multiple displays** keeps the acquisition centered about the Spectrum Center Frequency at all times. To accommodate off-center Measurement Frequencies, it just widens the acquisition bandwidth. Other optimizations tune the acquisition frequency to match that of whichever display is currently selected. The RF trigger module receives the same acquisition data as all the measurements, tuned to the center of the current acquisition bandwidth.

Units Tab

The Units tab specifies the global Amplitude units for all the views in the analysis window.



Replay Overview

The Replay function enables you to reanalyze data with different settings and even different measurements. You can replay all the acquisitions in memory, a single acquisition, a single frame within an acquisition (if Fast Frame is enabled), or any contiguous set of data records from acquisition history.

Displaying the Replay Control Panel

To display the Replay control panel:

1. Select **View** from the main menu bar.
2. Select **Replay Toolbar** in the menu. The toolbar will appear near the bottom of the display.



3. Click the **Define** button to open the Replay control panel.



TIP. You can read more about the other toolbar buttons [here](#).

Selecting the Data Type to Replay

To replay acquisition data, choose **Acq Data**.

Select Data Records Tab

The Select data records tab is used to select which data records to replay. A data record is the smallest unit that can be replayed. Note that what constitutes a data record can vary. If FastFrame is not enabled, a data record consists of a single acquisition. If FastFrame is enabled, each acquisition can contain multiple frames, and a data record consists of a single frame.



Without FastFrame enabled

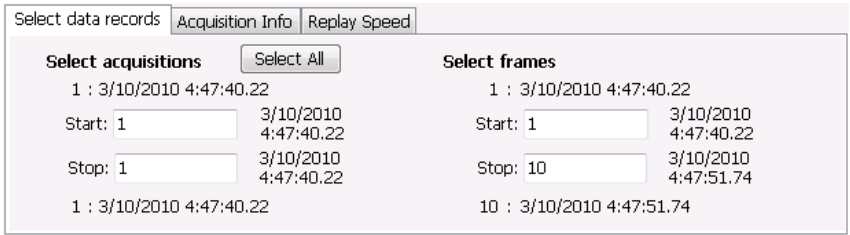

With FastFrame enabled

Date and Time Stamps. The line that appears above each Start box (one for acquisitions and one for frames when FastFrame is enabled) is a date stamp that displays the date and time the first record in the current acquisition was acquired. The line that appears below each Stop box is a date stamp that displays the date and time the last record in the current acquisition was acquired.

The line that appears to the right of each Start box displays the date and time the selected acquisition or frame was acquired. The line that appears to the right of each Stop box displays the date and time the selected record or frame in the current acquisition was acquired.

Select All button. Selecting Select All resets the Start and Stop values. The Start value is reset to the first acquisition or frame of the current acquisition. The Stop value is reset to the last acquisition or frame in the current acquisition.

Acquisition Info Tab

Displays information about acquisition settings and sets the number of decimal places used for displaying the time stamp.

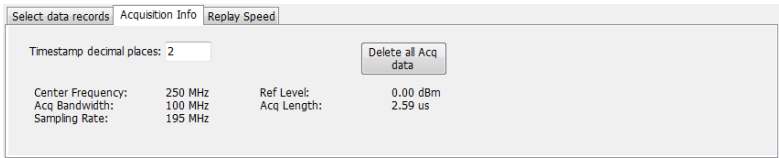

Replay Speed Tab

Sets the speed at which data records are replayed.

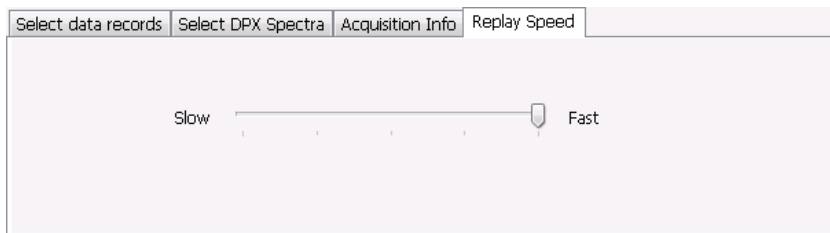

Replay Menu

The Replay menu provides controls that let you choose how to replay acquisitions. The replay function enables you to, in effect, “rerun” an analysis while applying different measurements to the same set of acquisition data.

Menu item	Description
Acq Data	Select Acq Data to replay acquisitions.
Replay all selected records	Replays the sequence of records specified by Start and Stop on the Select data records tab.
Loop overall selected records	Replays the sequence of records specified by Start and Stop on the Select data records tab continuously.
Replay current record	Replays the currently selected acquisition (or frame).
Replay from selected	Displays a submenu that you use to specify which records are to be replayed.
First record	Replays the first record within the selected set.
Previous	Replays the previous record within the selected set.
Next	Replays the next record within the selected set.
Last record	Replays the last record within the selected set.
Pause	Suspends replay of the data records as soon as the current record's replay action is completed. Press Pause again to begin replay with the next record in the sequence.
Stop	Halts the replay of acquisitions. If replay is started after Stop has been selected, replay starts from the first acquisition.
Select all	Selects all acquisitions for replay.
Select records from history	Displays the Select data records tab of the Replay control panel. Use the Select data records tab to specify which acquisitions and frames you would like to replay.
Replay toolbar	Displays or hides the Replay toolbar.

Acq Data

Selecting **Acq Data** selects acquisition data as the source for replay. Selecting Acq Data does not start replay, it only selects the type of acquisition data that will be replayed.

Replay All Selected Records

Selecting **Replay all selected records** replays all the selected data records. The set of selected records may comprise a single record, all records in acquisition history, or a subset of the records in history.

Replay Current Record

Selecting **Replay current record** replays the current data record. You can identify the current acquisition record by looking at the Replay toolbar. The first number to the right of the Select button identifies the current data record. For example, if the number is 2:10, it means the current record is the tenth frame of the second acquisition in history.

Replay from Selected

Select **Replay from selected** to replay records as selected from the submenu. The records replayed can be from the acquisition memory (history) or from a saved acquisition data file that has already been recalled as the current acquisition data.

Pause

Select Pause to suspend playback. Selecting Pause again restarts the replay at the point it was paused.

Stop

Select **Stop** to halt the replay of data. Selecting any Replay action restarts replay of records from the beginning.

Select All

Select **Select all** to select all data records for replay.

Select Records from History











Selecting **Select records from history** displays the **Select data records** tab of the **Replay** control panel. The Select data records tab allows you to specify which records in the acquisition history will be used when the Replay button is selected.

Replay Toolbar

Displays or hides the Replay toolbar that appears below the main tool bar.



Replay toolbar

Item	Description
Replay	Selects data type to be replayed.
	Replays the first record in the selected set.
	Replays the previous record in the selected set.
	Replays the current record in the selected set.
	Replays the next record in the selected set.
	Replays the last record in the selected set.
	Replays all records in the selected set.
	Replays all records in the selected set continuously until stopped.
	Pauses replay. Pressing pause suspends replay with the current record. Selecting pause again starts Replay with the next record.
	Stops replay. Starting any replay action after pressing stop starts a new Replay action rather than continuing from the record at which the previous replay action was stopped.
	Clicking Select All selects all records in history for replay. Selecting Select all resets the Start and Stop values on the Select data records tab of the Replay control panel.

Item	Description
Define	<p>Clicking the Define button displays the Define Replay control panel. The Acquisition Info tab displays information about the acquisition data such as acquisition bandwidth, sampling rate and acquisition length. All data records in the acquisition history were acquired with identical parameters. When any of these parameters are changed, all records in history are deleted as soon as the first record acquired under the new parameter values is received.</p> <p>You can also view and use the Select data records tab, Select DPX Spectra tab, and Replay Speed tab.</p>
1:10	3/10/2010 4:47:51.74 This readout shows information about the data record being replayed. The information displayed shows the acquisition and frame number and time stamp for the current data record.

Amplitude Settings

Main menu Bar: Setup > Amplitude

Favorites toolbar: 

The Amplitude control panel provides access to power-related settings that are used by all displays within the SignalVu application.

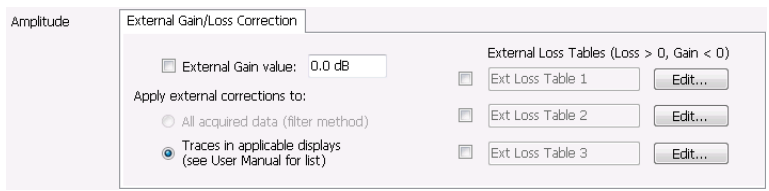

Setting	Description
External Gain/Loss Correction (see page 537)	Specifies whether a correction is applied to the signal to compensate for the use of external equipment.

External Gain/Loss Correction Tab

The External Gain/Loss Correction tab allows you to apply a correction to a signal to compensate for the use of external equipment, such as an amplifier or attenuator. You can specify whether the corrections on this tab apply to all acquired data or only to a set group of displays. You can also apply external corrections to traces in the Spectrum, Spectrogram, Spurious, and Amplitude vs Time displays.

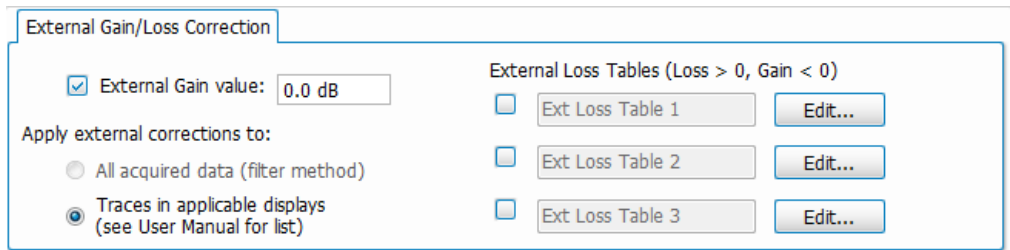

External Gain Value

Use the External Gain Value setting to apply a flat gain/loss correction to the signal. Positive values represent a gain and negative values represent a loss. The range is -80 to +50 dB. Resolution is 0.1 dB.

NOTE. Selecting Preset clears the check box, but it does not change the value.

3. To edit values in the table:
 - a. To edit an existing value, double-click on the cell you want to edit.
 - b. To add a new point to the table, click on **Add Point**. Edit the values as required.
 - c. Click **Apply** if you want to test your table without closing the editor (the table must be enabled with the check box in the control panel and measurements must already be running).
To specify a frequency multiplier, you can type K, M, or G.
4. To delete a point from the table, select the point to be removed, and click **Delete**.
5. Select the Frequency Interpolation method:
 - Select Linear when the frequency scale of the spectrum or spurious measurements are linear.
 - Select Log when the frequency scale of the spectrum is logarithmic.
6. When you have entered all the necessary values, click **Save As** (to save the table in a file) or click **OK**.
7. From the Save As dialog, name the file and save it in the desired location.
External loss tables are saved in CSV (Comma Separated Value) format.

Loading an External Loss Table

To load an external loss table file:

1. Click **Edit** to display the Table Editor.
2. Click **Load** to display the Open dialog box.
3. Navigate to the location of the desired file, select it and click Open.
4. Click **OK**.

Continuous Versus Single Sequence

Menu Bar: **Run > Single Sequence / Continuous**

Selecting **Single Sequence** sets the acquisition mode so that when you press Run, a single acquisition sequence is performed and the instrument stops once the acquisition sequence is completed. Selecting **Continuous** sets the acquisition mode so that an acquisition sequence is started as soon as you select Continuous and as one acquisition sequence completes, another begins.

Note that an acquisition sequence can require more than one acquisition. For example, in a spectrum view, the trace function might be set to Average 100 acquisitions. Thus, a complete acquisition sequence would consist of 100 acquisitions that are averaged together to create the trace that is displayed.

Run

Menu Bar: **Run > Run**

Favorites Bar: **Run**

Selecting **Run** begins a new acquisition/measurement cycle.

Resume

Favorites Bar: **Run > Resume**

Restarts data acquisition, but does not reset accumulated results, such as Average or MaxHold. This allows you to stop acquisitions temporarily, then continue. If the accumulation is already complete, for example, 10 acquisitions or 10 averages have already been completed, each subsequent Resume command will cause one more acquisition to be taken, and its results added to the accumulation. Not available if instrument settings have been changed.

Abort

Favorites Toolbar: **Run > Abort**

Selecting **Abort** immediately halts the current acquisition/measurement cycle. In-process measurements and acquisitions are not allowed to complete. Visibility and accuracy of results is unspecified after an abort.

Acquire

Main menu: Setup > Acquire

Favorites toolbar: 

Selecting **Acquire** displays the Acquire control panel. These settings control the hardware acquisition parameters for the oscilloscope. Normally, sampling parameters are automatically adjusted for selected measurements. You can use Acquire to change these parameters if necessary.

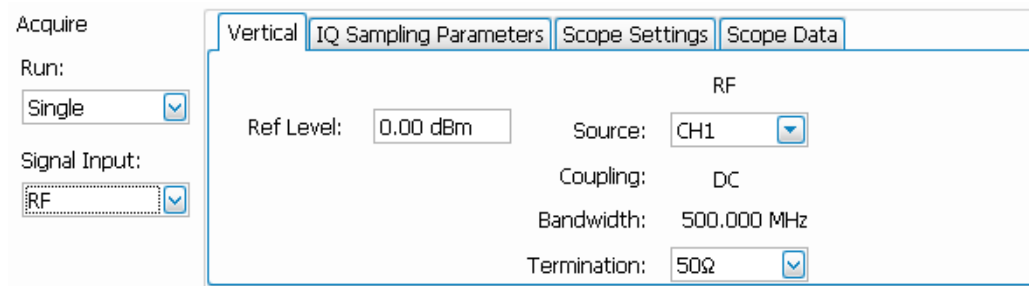

Setting	Description
Vertical (see page 543)	Sets the channel used, reference level, and termination.
IQ Sampling Parameters (see page 544)	Sets sampling parameters.
Scope Settings (see page 546)	Sets the SignalVu software to control oscilloscope acquisition parameters or use the current oscilloscope settings.
Scope Data (see page 547)	Displays the sample rate and record length reported by the oscilloscope.

Run

Run mode specifies whether the analyzer will stop acquiring data after it completes a measurement sequence.

- **Continuous** - In Continuous mode, once the analyzer completes a measurement sequence, it begins another.
- **Single** - In Single mode, once the analyzer completes a measurement sequence, it stops.

NOTE. A measurement sequence can require more than one acquisition. If the analyzer is configured to average 100 traces together, the measurement sequence will not be completed until 100 traces have been acquired and averaged.

Vertical

Use the Vertical tab to specify which oscilloscope channel is used for analysis by the SignalVu software. The number of signals analyzed by SignalVu depends on the selected signal input type. The Signal Input can be set to:

- RF
- I & Q
- Diff I & Q (Differential I & Q)

The screenshot shows the 'Vertical' tab selected in the software interface. On the left, the 'Run' dropdown is set to 'Single' and the 'Signal Input' dropdown is set to 'RF'. The main panel displays the following settings:

Parameter	Value
Ref Level	0.00 dBm
Source	CH1
Coupling	DC
Bandwidth	500.000 MHz
Termination	50Ω

Vertical tab with signal input set to RF

The screenshot shows the 'Vertical' tab selected in the software interface. On the left, the 'Run' dropdown is set to 'Continuous' and the 'Signal Input' dropdown is set to 'I & Q'. The main panel displays the following settings:

Parameter	I Value	Q Value
Ref Level	0.00 dBm	
Source	CH1	CH2
Coupling	DC	DC
Bandwidth	500.000 MHz	500.000 MHz
Termination	50Ω	50Ω

A 'Null IQ Offset' button is also visible in the bottom left of the main panel.

Vertical tab with signal input set to I & Q

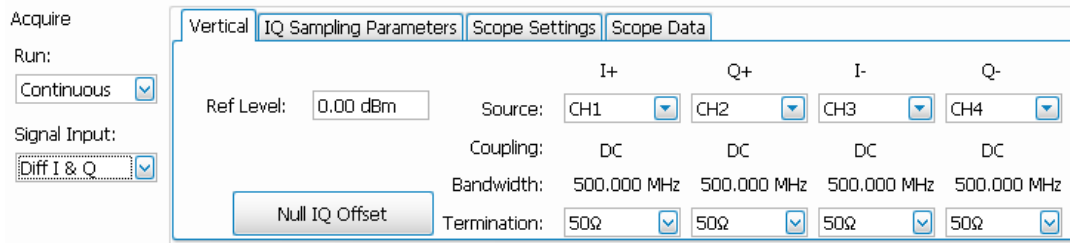

Vertical tab with signal input set to Diff I & Q

Setting	Description
Signal Input	Specifies the input signal type.
Ref Level	Specifies the Reference Level, which determines the oscilloscope's Vertical Scale setting. If Vertical settings are not enabled in the Scope Settings tab, or while analyzing a recalled data file, the Reference Level control only adjusts vertical display position.
Null IQ Offset	Removes DC offset that may be applied within the oscilloscope to eliminate offset between I and Q channels.
Source	Specifies the input source. Choices available are: CH1, CH2, CH3, CH4, Math1, Math2, Math3, Math4, Ref1, Ref2, Ref3, and Ref4.
Coupling	Display of the coupling setting on the selected channel.
Bandwidth	Display of the oscilloscope bandwidth setting.
Termination	Display of the termination setting for the selected channel.

Offset Frequency

If the Signal Input is set to I&Q or Diff I&Q, the **Freq:** readout serves as the offset frequency readout. When the Signal Type is set to I&Q or Diff I&Q, the default measurement frequency is 0 Hz. However, for signals that have near-zero IFs, the measurement frequency can be changed by entering an offset frequency value in the measurement frequency entry box (**Freq:** in the Favorites toolbar).

IQ Sampling Parameters

The IQ Sampling Parameters tab enables you to set the controls for real-time acquisition. Depending on the setting chosen for Adjust, two additional parameters can be set. Normally, the best results are achieved by leaving the Adjust control set to All Auto.

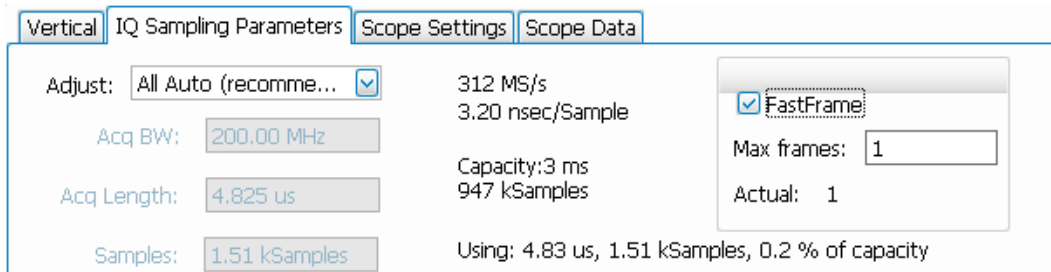

Sampling Control

There are three acquisition parameters that interact with each other: acquisition bandwidth, oscilloscope acquisition sampling rate, and memory usage. The oscilloscope's sampling rate is displayed in the status bar at the bottom of the SignalVu window. This sample rate is decimated by the SignalVu software to meet the requirements of the current measurement settings (such as the selected span, acquisition bandwidth or resolution bandwidth of a measurement). The resulting decimated sample rate is shown in the figure above (391 MSamples/sec). This is the sample rate of the IQ data analyzed and acquisition data file stored by SignalVu.

Adjust	User Sets		Analyzer Calculates
All Auto	N /A	N /A	All values based on the selected measurement
Acq BW / Acq Samples	Acq BW	Acq Samples	Acq Length
Acq BW / Acq Length	Acq BW	Acquisition Length	Acq Samples

Acquisition Memory Usage

The center portion of the tab shows how the acquisition memory is used.

Readout	Description
Samples/s, sec/Sample	Readout of the acquisition sample rate and sample period.
Capacity	The maximum period of time and number of samples that can be acquired with the current sampling parameters.
Using	The total amount of acquisition memory that will be used based on the current settings.

FastFrame

FastFrame is a feature that allows you to segment the acquisition record into a series of frames, or data records. A typical use of FastFrame is to record data samples around signal events of interest, while not wasting memory on irrelevant data between these events. FastFrame acquisitions are only valid for live waveforms and is not supported for Math or Reference Waveforms.

Setting	Description
FastFrame	Enables FastFrame acquisition mode.
Max Frames	Specifies the maximum number of frames to record in a single acquisition process.
Actual	Readout that shows the actual number of frames that will be acquired into the acquisition memory. This number changes based on the Acq BW, Acq Samples, and Acq Length values. This number will never be greater than the value set by Max Frames.

Scope Settings

The Scope Settings tab is where you specify which oscilloscope settings are controlled by the SignalVu software.

Setting

Sample Rate	When enabled, SignalVu adjusts the sample rate as required based on measurement settings in the analysis software. Sample rate determines the maximum available measurement bandwidth.
Auto	When Sample Rate is enabled and Auto is enabled, SignalVu adjusts the sample rate automatically. When Sample Rate is enabled and Auto is disabled, you can specify the sample rate using the text entry box. You can set the sample rate to any of the standard oscilloscope sample rate settings. If you choose an arbitrary value, SignalVu will adjust the value to the closest standard sample rate.
Other acquisition/horizontal settings	When enabled, SignalVu adjusts the oscilloscope horizontal and acquisition settings of the oscilloscope as needed to provide the best results. For example, SignalVu sets Sampling Mode to Real Time Only and Horizontal Mode to Manual when it is allowed to control these parameters. Checking these boxes helps reduce variability in the SignalVu results.
Vertical settings	When enabled, SignalVu adjusts the oscilloscope's vertical settings. Vertical settings include Coupling, Bandwidth, Scale and Termination. SignalVu sets these to values appropriate for RF signals. The Scale value sent to the oscilloscope is calculated from SignalVu's Reference Level control value.
Trigger Position	When enabled, SignalVu controls the trigger position on the oscilloscope. When enabled, the trigger position can be specified manually by entering a value into the text entry box or automatically, which allows SignalVu to set the trigger position.
Reset all scope settings to default values	Press this button to change all oscilloscope settings to the oscilloscope's default values.

Scope Data Tab

Displays the sample rate and record length reported by the oscilloscope.

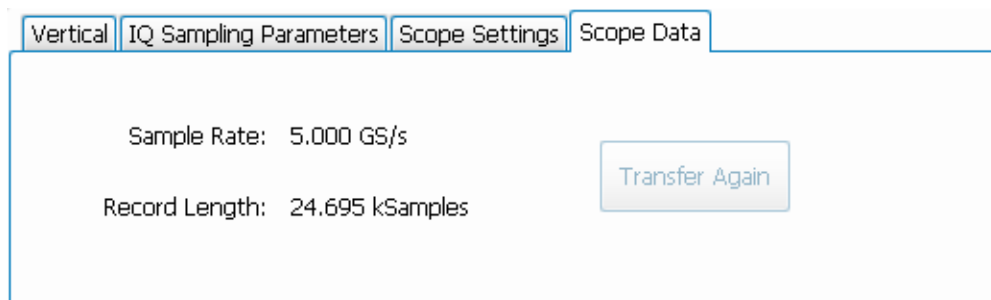

Transfer Again

The Transfer Again button, selectable only when run is stopped, causes SignalVu to request that the last acquisition made by the oscilloscope be transferred again and analyzed. This enables you to change measurement settings and then reanalyze the acquisition data with the revised measurement settings in effect. If FastFrame is enabled, all frames are replayed when the transfer is completed.

The Transfer Again function is most useful when measurements in SignalVu are set up to require less acquisition bandwidth than what is available from the oscilloscope (based on the sample rate used by the oscilloscope to acquire the waveform record). In this case, the data is decimated before being supplied to SignalVu (because SignalVu doesn't need the excess bandwidth. If you need a wider bandwidth than SignalVu was originally set up for and the original scope acquisition supports the new value, you can change the SignalVu settings, then click **Transfer again**. This time, the waveform data is sent to SignalVu with its bandwidth (sample rate) adjusted to match the current measurement settings.

Advanced

The Advanced tab is available only when an RSA7100 is connected. It contains the preselector setting. The preselector uses input filters for image suppression when the span of the instrument allows for their use.

Two methods of preselection are used in the RSA7100: a fixed low-pass filter (LPF) and a tunable bandpass filter (BPF). Due to the narrow-band nature of the tuned BPF, it is necessary to bypass this filter for wideband analysis of signals with bandwidth >50 MHz. The tuned BPF preselector is enabled depending on the acquisition mode (swept or real-time), frequency range, and user selection of preselector state (Auto, On, Off). The LPF preselector is naturally wideband, so that filter is always present, even when the preselector Off mode is manually selected.

IQ Sampling Parameters | Advanced | Frequency Reference | Timing Reference

Microwave Preselector: Auto Status: Off

Wideband Extended Tuning

Microwave preselector setting	Description
Auto	<p>This setting balances maximizing acquisition bandwidth with image suppression. The analyzer will operate up to its maximum acquisition bandwidth and may turn off the microwave preselector to accommodate this. When the requested span exceeds the acquisition bandwidth, the microwave preselector is engaged and the step size used is 50 MHz/step.</p> <p>This is the default setting.</p>
On	<p>This setting sets the preselector to always be on, independent of span. When the span exceeds 50 MHz, the instrument is stepped in frequency to create the display.</p>
Off	<p>This setting bypasses the preselector filters (except for the LPF, which is always present) when the span is greater than the allowed acquisition bandwidth. The maximum available real time span is equal to the maximum available acquisition bandwidth at the selected frequency. When the span of the analysis exceeds the available acquisition bandwidth for the selected frequency, the step size of the sweep is set to 320 MHz.</p>
Wideband Extended Tuning (RSA7100 with Option B800 only)	<p>Check the box to enable for tuning down to a center frequency of 3.2 GHz at an acquisition bandwidth of 800 MHz. The default is On and the setting does not change by Preset.</p>

800 MHz sweep mode (RSA7100 with Option B800 only)

To set the acquisition BW to 800 MHz, you need to select Minimize Sweep Time as the RF & IF Optimization setting in the Internal Settings tab in the Amplitude control panel (Favorites toolbar: ).

Note that the start frequency must be set to >3.2 GHz to view 800 MHz. A start frequency of <3.2 GHz will result in a set BW of 320 MHz (with preselector Off).

The following table shows the microwave preselector state by acquisition mode.

Acquisition mode	Auto	On	Off
Swept, 50 MHz steps	On	On	CF ≤ 3.6 GHz: On CF > 3.6 GHz: Off
Swept, 320 MHz steps	Not applicable	Not applicable	CF ≤ 3.41 GHz: On CF > 3.41 GHz: Off
Real time span ≤ 50 MHz	On	On	CF ≤ 3.6 GHz: On CF > 3.6 GHz: Off
Real time span > 50 MHz	CF ≤ 3.41 GHz: On CF > 3.41 GHz: Off	Not applicable	CF ≤ 3.41 GHz: On CF > 3.41 GHz: Off

Timing Reference

The Timing Reference tab is part of the Acquire control panel. It is only available when an RSA7100 with Option GPS is connected (units with an IRIG-B connector). This tab allows you to specify the following sources for the timing reference.

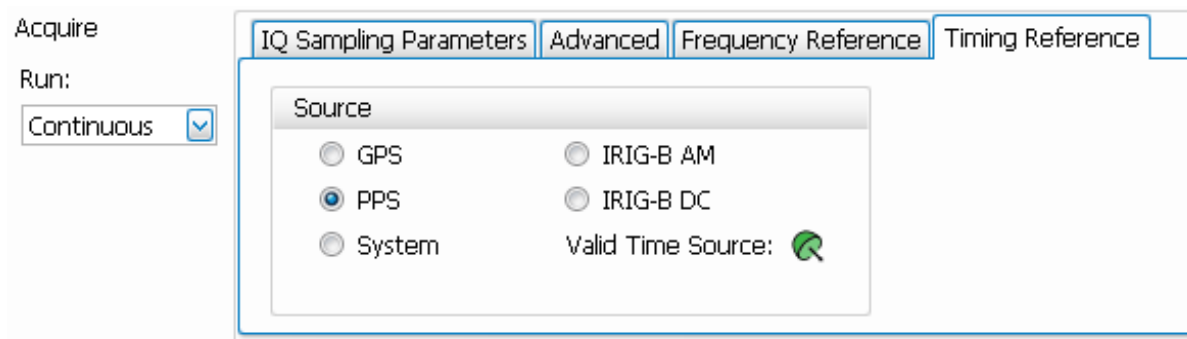

Setting	Description
GPS	<p>Specifies the timing reference for GPS from the GPS/Antenna connector on the instrument front panel.</p> <p>Click the  icon or select Setup >GNSS/Antenna from the Main menu bar of the SignalVu-PC application to access the GNSS and Antenna tabs in the GNSS/Antenna control panel. From there you can set GNSS source and baud rate and antenna settings.</p>
PPS	<p>Specifies the timing reference for PPS (Pulse Per Second) from the 1 PPS connector on the instrument front panel. The time code of that signal is used to set the time of SignalVu-PC.</p>
System	<p>Set the timing reference to local PC time. This is the default setting.</p>
IRIG-B AM	<p>When an IRIG-B signal is connected to the instrument using the IRIG-B connector on the front panel, the system first checks if an IRIG-B AM signal is present. If detected, the time code of that signal is used to set the time of SignalVu-PC.</p>
IRIG-B DC	<p>When an IRIG-B signal is connected to the instrument using the IRIG-B connector on the front panel, the system first checks if an IRIG-B DC signal is present. If detected, the time code of that signal is used to set the time of SignalVu-PC.</p>
Valid Time Source indicator	<p>This dish icon indicates the lock status of the selected time source. Green indicates that the system is locked to the selected time source. Yellow indicates that the system is not locked to the selected time source.</p>

Time stamps and timing reference sources

- The default timing reference source upon launch of SignalVu-PC is system time.
- If you change the source in the Timing Reference tab in the UI from default to one of the externally generated sources (GPS, PPS, IRIG-B) without a valid signal, the time will remain system time.
- If you set the source to GPS, PPS, or IRIG-B after launch of SignalVu-PC (thus changing the time from the default system time), and then disconnect from that source or otherwise lose the lock to that source, the time used will be that of the previous externally generated source. This will remain so until you set a different source with a valid signal.

GPS, PPS, and IRIG-B sources will update the xmrk file to include the following parameters: timestamp_source to indicate last valid signal type, event_code to indicate software_marker, and each signal pulse to be noted with a time and sample number. All other event codes, such as triggers and acquisition status events, will reference the last valid external timing reference signal.

Stored information

When recording with the XCOM format selected, a marker file (.xmrk) is generated that lists time, location (GPS only), and the time stamp of the GPS, PPS, or IRIG-B event during recording. You can read more about file formats and what they contain in the [Saved File Types \(see page 570\)](#) and the [Record Setup](#) topics.

IRIG-B signals

You can use the IRIG-B connector on the RSA7100 to connect to an IRIG-B signal generator. SignalVu-PC allows you to select one of two IRIG-200-04 standard signals to use for timing reference. IRIG-B is the standard for 1 kHz IRIG signals with frame lengths of 1 second. SignalVu-PC can detect IRIG-B AM and DC signals.

- IRIG-B detection is only available on RSA7100 units with Option GPS and an **IRIG-B** connector.
- When switching from any time reference to IRIG-B, it takes several seconds for the time to update with a valid signal.

PPS signals

A PPS (Pulse Per Second) source can be used as a timing reference to sync multiple devices. You can use the 1 PPS connector on the RSA7100 to sync the RSA7100 to a source.

- The PPS selection is only available on RSA7100 units with Option GPS and a **1 PPS** connector.

How to set up GNSS

The GNSS and Antenna features allow you to capture location coordinates when using an antenna and a GNSS receiver.

You can use the GNSS feature to connect a Global Navigation Satellite System (GNSS) receiver to a communication (COM) port on your instrument to capture the timing and positioning data of the receiver for a measurement from a satellite or constellation of satellites. The receiver must output navigation messages using NMEA 0183 serial data format, and the messages must include at least one of these sentence types: RMC, GGA or GNS.

The RSA7100 with Option GPS, the RSA500A series, and the RSA600A series instruments have an internal GNSS receiver.

How to access the GNSS/Antenna control panel

Click the  icon or select **Setup > GNSS/Antenna** from the Main menu bar to view the GNSS/Antenna control panel.

GNSS settings

The following image and table show the GNSS tab of the GNSS/Antenna control panel and its contents.

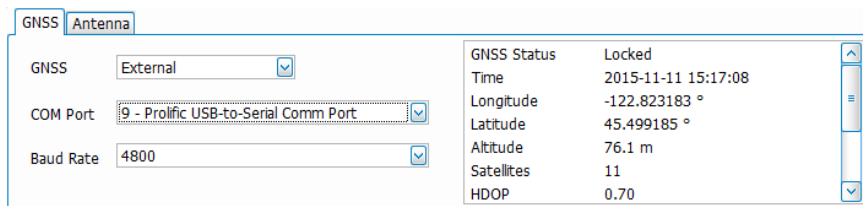

Setting	Description
Source	<p>Select the GNSS source as None or External.</p> <p>None disables use of GNSS data.</p> <p>External selects a user-provided GNSS receiver in the PC with SignalVu-PC installed, or it may be one you connect through USB or some other method.</p> <p>NOTE. When recording with XCOM format, a marker file (.xmrk) is generated that lists GPS data, such as time, location, and the time stamp of the GPS event during recording. You can read more about file formats in the Saved File Types (see page 570) topic.</p>
COM Port	<p>This list is auto-populated with the COM ports on your PC, as well as a simulation port.</p> <p>NOTE. You must first select the COM port to which the antenna is connected before an antenna connection can be established.</p>
Baud rate	<p>Select a baud rate. Selection of this rate will depend on your GNSS receiver and COM port specifications. Options are 4800, 9600, 19200, and 38400.</p>

Setting	Description
Satellite System	Select a satellite system: GPS, GLONASS; GPS, BeiDou; GPS; GLONASS, BeiDou.
GNSS readout	This readout shows the status of the GNSS connection and time, location, and satellite information. Each item is described below.
GNSS Status	GNSS receiver connection status: Off, Comm error, Unlocked, Locked.
Time	Date (yyyy-mm-dd) and time (hh:mm:ss).
Longitude	East-west position (shown in degrees), where the prime meridian is 0°. Positive numbers indicate East and negative numbers indicate West.
Latitude	North-south position between the poles (shown in degrees), where the equator is 0°. Positive numbers indicate North and negative numbers indicate South.
Altitude	Elevation from sea level (shown in meters).
Satellites	Number of GNSS satellites currently tracked by the GNSS receiver.
HDOP	Horizontal Dilution of Precision (HDOP). This value indicates the quality of the satellite signal using the relative geometry of the satellite to receiver. An ideal value is <1. The lower the value, the better the positional precision.
Speed	Speed of receiver (shown in km/s).
Course	Compass bearing (shown in degrees).

The icon  appears in the right corner of the Status Bar. It is green when GNSS is locked, yellow if unlocked, and red if there is a communication error.

How to set up the GNSS feature with an external GNSS receiver

1. Install a GNSS receiver to a COM port on your PC.
2. Select **Setup > GNSS/Antenna** from the Main menu bar to view the GNSS/Antenna control panel.
3. Select **External** from the drop-down menu in the GNSS tab.
4. From the COM Port drop-down list, select the COM port to which the GNSS receiver is connected.
5. Set the Baud Rate as appropriate for the connected GNSS receiver. The default is 4800, which is a typical rate.

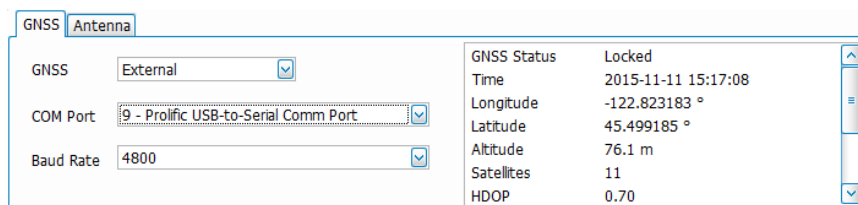

When the GNSS receiver is communicating with the analyzer, the readouts in the right portion of the GNSS panel (status area) will update to display current location information and GNSS receiver status. Lock times will vary depending on the receiver and receiving conditions.

See also:

[How to use the Antenna feature](#)

How to use the Antenna feature

The antenna feature allows you to connect to an Alaris DF-A0047 USB-connected antenna that reports bearing/azimuth data over USB. If you do not use an Alaris DF-A0047 antenna, you can use the manual controls to enter an azimuth.

Explore the following topics in this section:

NOTE. A USB driver is installed for the Alaris antenna with SignalVu-PC. However, Windows will search for new drivers if the PC is connected to the internet. The first time you plug an antenna into the port, it may take several minutes for the driver to be installed (when connected to the internet).

- [Antenna settings.](#)
- [How to set up the Antenna feature with an antenna.](#)
- [How to use the antenna Simulator.](#)
- [How to use the Alaris function button](#)

How to access the Antenna control panel

Click  or select **Setup > GNSS/Antenna** from the Main menu bar to view the GNSS/Antenna control panel. Then click on the **Antenna** tab in the control panel.

Antenna settings

Following is an image and a description of the Antenna tab of the GNSS/Antenna control panel.

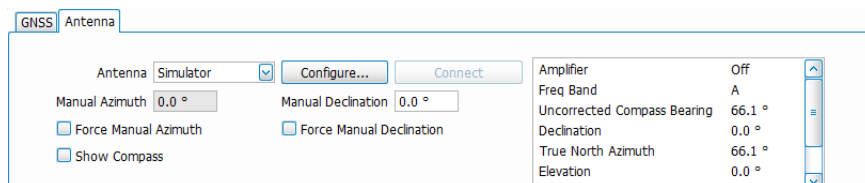

Setting	Description
Antenna	Select the antenna. Choices are None, Alaris DF-A0047, and Simulator. The Simulator simulates an antenna connection and readouts for demonstration purposes.
Manual Azimuth	Enter a value here to force the azimuth (compass direction in degrees) to be a specific value. The azimuth is the angle measured clockwise between the reference meridian (geographic north) and the current antenna direction. It can range from 0 to 360°.
Force Manual Azimuth	Check this box to force the analyzer to read the azimuth at the entered value instead of the antenna generated value.
Show Compass	Check this box to view a visual, qualitative representation of the bearing (a virtual compass). To remove the compass, uncheck the box. To adjust the compass size, click and drag from the bottom right corner.
Configure...	This button opens the Antenna Setup window. In this window you can enter the antenna serial number and set the following antenna related parameters: baud rate, data bits, stop bits, and parity.
Connect	Click this button to connect to the antenna or to start the antenna simulator. NOTE. You must first select the COM port to which the antenna is connected before a connection can be established. Use the Windows Device Manager to find the port used by your antenna.
Manual Declination	Enter a value here to force the declination (angle in degrees between magnetic (true) north and geographic north) to be a specific value.
Force Manual Declination	Check this box to force the analyzer to use the manually entered declination value. Otherwise, the analyzer will assume that geographic north and magnetic north are the same and use 0°.
Antenna readout	This readout field will contain some or all of the following readings, depending on your setup.
Amplifier	Shows Off or On depending on whether or not you have enabled the amplifier on the antenna.
Freq Band	The current operating frequency band of the antenna. For the Alaris DF-A0047, this value can be one of the following: A (0.009 - 20 MHz) B (20 - 50 MHz) C (50 - 8500 MHz)
Uncorrected Compass Bearing	Shows the azimuth reading from geographic north.
Declination	Shows the declination.
True North Azimuth	Shows the azimuth reading after declination is applied.
Elevation	Shows the antenna elevation.
Roll	Shows the antenna roll.

How to set up the Antenna feature with an antenna

1. Install the Alaris DF-A0047 driver from www.Tek.com/downloads.
2. Connect an Alaris DF-A0047 antenna to the PC.

NOTE. A USB driver is installed for the Alaris antenna with SignalVu-PC. However, Windows will search for new drivers if the PC is connected to the internet. The first time you plug an antenna into the port, it may take several minutes for the driver to be installed (when connected to the internet).

3. Select **Setup > GNSS/Antenna** to open the GNSS/Antenna control panel.
4. Select **Alaris DF-A0047** from the Antenna drop-down menu. Selections also include None (default) and Simulator.
5. Click the **Configure...** button to launch the Antenna Setup window.

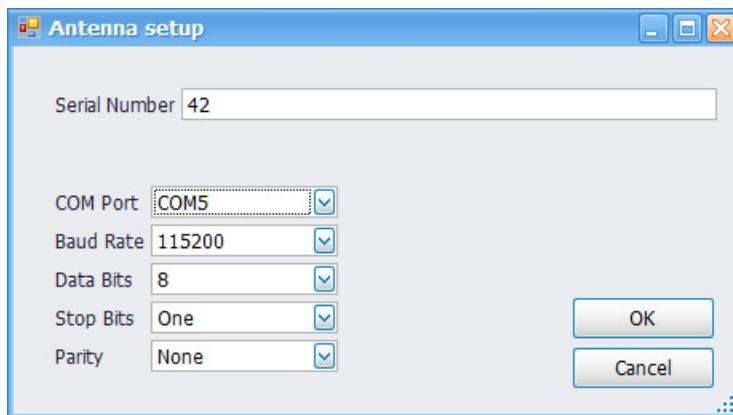

6. Do the following in the Antenna Setup window:
 - a. Enter the serial number of the antenna, if desired.
 - b. Select the COM port to which the antenna is connected.
 - c. You can change the following parameters; however, the default values are set for the Alaris DF-A0047 antenna. If you change these parameters, you may lose communication with the Alaris antenna: baud Rate, data bits, stop bits, and parity.
8. Click **OK** to save the changes and close the Antenna Setup window.
9. You can now choose to manually set the declination, if desired. To do this, check the box next to **Force Manual Declination** in the Antenna tab of the GNSS/Antenna control panel and then enter the desired value. Notice that the value you enter will appear in the antenna readout to the right of the Connect button. The True North Azimuth reading is the sum of the Uncorrected Compass Bearing and the Declination.

You can also check the box next to **Force Manual Azimuth** and enter a desired value if you want to force the azimuth or are using an antenna that does not report azimuth.

When you select to manually force the declination and/or azimuth, those values will not change in the readout, even if the antenna direction changes.

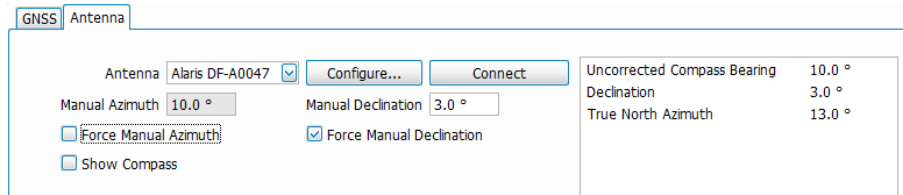

10. Check the **Show Compass** box to view a visual, qualitative representation of the bearing. As you move the antenna, the compass needle will move.

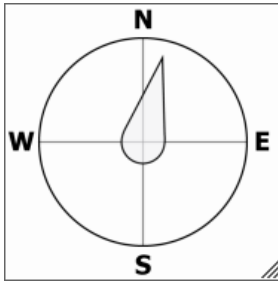

TIP: You can adjust the size of the compass by clicking on the right bottom corner and dragging it.

11. Click the **Connect** button to connect to the antenna. Connection may take about 10 seconds. Once connected, the antenna readout will reflect the antenna direction and other readings.

How to use the antenna Simulator

1. Select **Setup > GNSS/Antenna** to open the GNSS/Antenna control panel.
2. Select **Simulator** from the Antenna drop-down menu. Selections also include None (default) and Alaris DF-A0047.
3. Click the **Connect** button to launch the Smart Antenna Control Form.

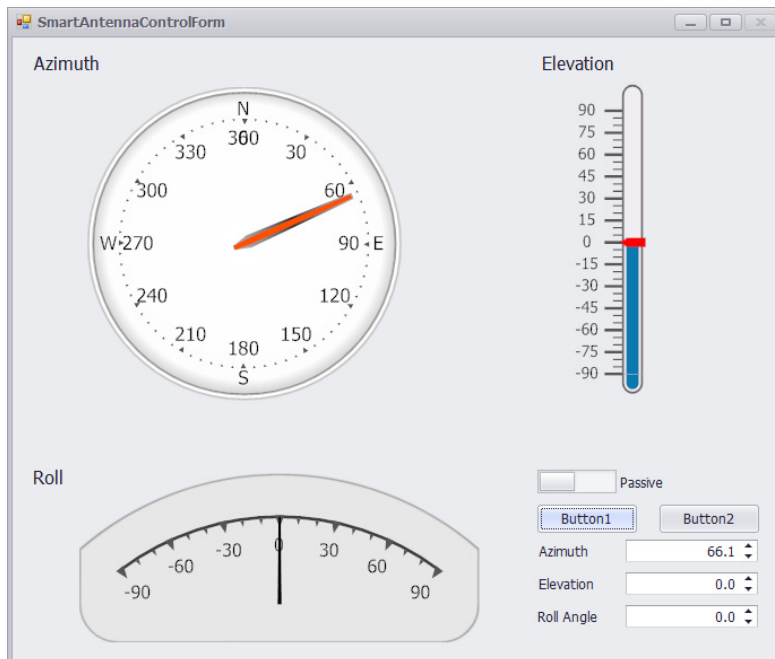

4. Click on the various areas of the Smart Antenna window to adjust azimuth, roll, or elevation. You can also enter the values directly in the Azimuth, Elevation, and Roll Angle fields. This Smart Antenna window simulates a physical antenna, except that there is no amplification available (the Passive/Active switch is non-functional).
5. Click the **Button1** button to capture the GNSS information. (See the [How to use Map It](#) topic for more information on capturing data.)
6. You can now choose to manually set the declination, if desired. To do this, check the box next to **Force Manual Declination** in the Antenna tab of the GNSS/Antenna control panel and then enter the desired value. Notice that the value you enter will appear in the antenna readout to the right of the Connect button. The True North Azimuth reading is the sum of the Uncorrected Compass Bearing and the Declination.

You can also check the box next to **Force Manual Azimuth** and enter a desired value if you want to force the azimuth or are using an antenna that does not report azimuth.

When you select to manually force the declination and/or azimuth, those values will not change in the readout, even if the antenna direction changes.

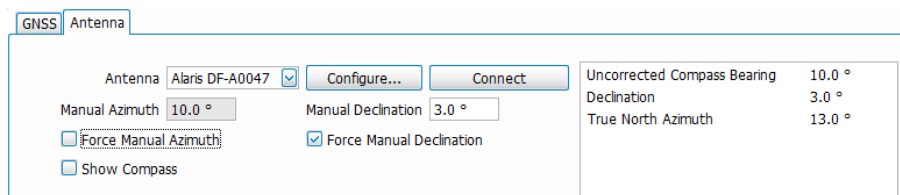

7. Check the **Show Compass** box to view a visual, qualitative representation of the bearing. As you move the antenna, the compass needle will move.

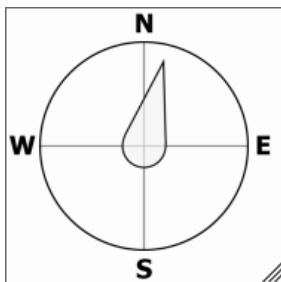

TIP: You can adjust the size of the compass by clicking on the right bottom corner and dragging it.

How to use the Alaris function button

The Alaris antenna has a function button that allows you to make Band and Mode selections. These can be selected using the rotary encoder and push button located on the front of the Alaris antenna grip.

To select a frequency:

1. Turn the rotary switch either to the left or right.
2. Watch the LEDs on the back of the grip. The LEDs indicate which frequency band is selected. Selections are:
 - Top LED, Band A: 9 kHz – 20 MHz
 - Middle LED, Band B: 20 MHz – 500 MHz
 - Bottom LED, Band C: 500 MHz – 8500 MHz

To select an amplifier mode:

1. Push the button on the front of the antenna grip.
2. Watch the LED on the back of the grip. It indicates the mode status as:
 - LED on: Active mode (amplifier on)
 - LED off: Bypass mode (amplifier off)

To take a measurement using the button:

1. Hold the button down for two seconds.
2. Release the button. The measurement is transferred and stored via the Map It function of SignalVu-PC.

See also:

[How to set up GNSS \(see page 553\)](#)

How to use the Signal Database

Select **Tools > Signal Database** to open the Signal Database window. Here you can select which signal standards and types are listed (and selectable) in the Channel Navigation toolbar and/or the Define Survey control panel.

Signal standards and signal types defined

The analyzer uses the following definitions of signal standards and signal types to populate the Signal Database.

- **Signal standard:** A group of channels that adheres to the parameters and characteristics of a given signal type. These channels could include both uplink and downlink frequencies.
- **Signal type:** Parameters and characteristics (bandwidth, spectral shape) common to a given signal. A signal type can be shared by multiple signal standards.

How to select signal standards in the database window

The following image is of the Signal Database window with the Signal Standards tab selected. The table describes the fields and buttons of the tab. The standards selected here show in the Define Survey control panel and the [Channel Navigation](#) toolbar.

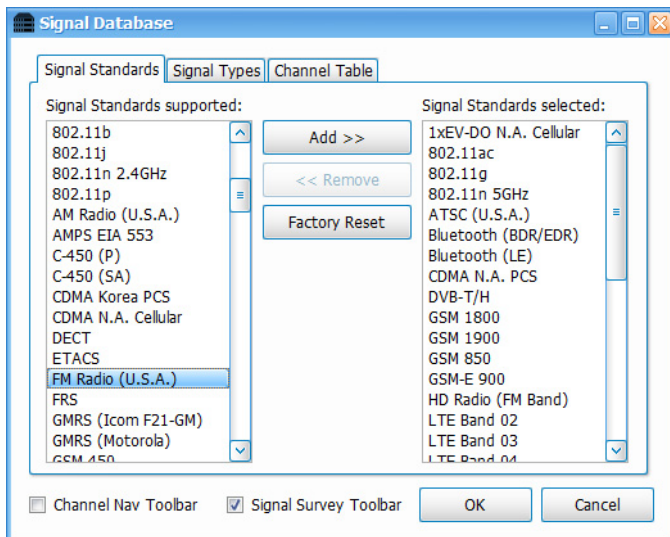

Setting	Description
Signal Standards Supported	List of all available signal standards. Click a standard to select it or click and drag to select a contiguous range of standards.
Add >>	Adds (moves) selected items from the Signal Standards Supported list to the Signal Standards selected list.

Setting	Description
< < Delete	Deletes (moves) selected items from the Signal Standards selected list to the Signal Standards Supported list.
Signal Standards selected	List of selected signal standards that will be made available in the Channel Navigation toolbar and the Region tab of Define Survey control panel. To delete items, select one or more signal standards and click the Delete button.
Factory Reset	Sets the supported and selected fields to the factory-specified signal standards.
Channel Nav Toolbar check box	Check box to open the Channel Navigation toolbar. The Signal Database window stays open. You can read more about the Channel Navigation toolbar here .
Signal Survey Toolbar check box	Check box to open the Signal Survey toolbar. The Signal Database window stays open. You can read more about the Signal Survey toolbar here .

How to select signal types in the database window

The following image is of the Signal Database window with the Signal Types tab selected. The table describes the fields and buttons of the tab. The types selected here show in the Define Survey control panel.

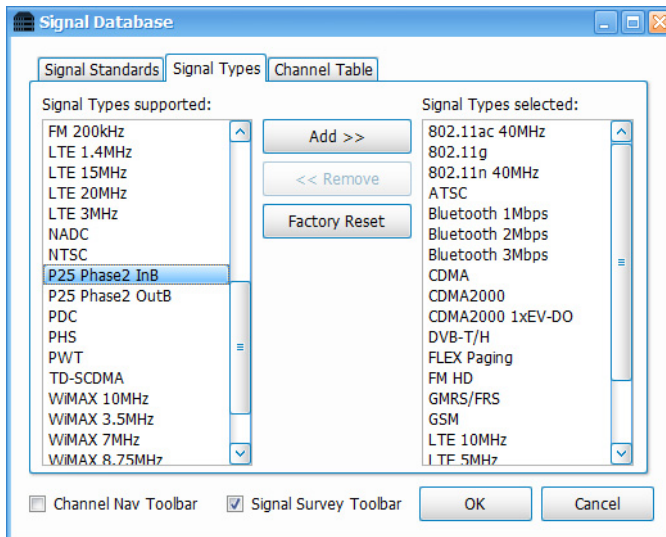

Item	Description
Signal Types supported	List of all available signal types. Click a type to select it or click and drag to select a contiguous range of types.
Add > >	Adds (moves) selected items from the Signal Types Supported list to the Signal Types selected list.
< < Delete	Deletes (moves) selected items from the Signal Types selected list to the Signal Types Supported list.
Signal Types selected	List of selected signal types made available in the Region tab of the Define Survey control panel. To delete items, select one or more signal types and tap the Delete button.
Factory Reset	Sets the supported and selected fields to the factory-specified signal types.

Item	Description
Channel Nav Toolbar check box	Check box to open the Channel Navigation toolbar. The Signal Database window stays open. You can read more about the Channel Navigation toolbar here .
Signal Survey Toolbar check box	Check box to open the Signal Survey toolbar. The Signal Database window stays open. You can read more about the Signal Survey toolbar here .

How to select channels in the database window

The following image is of the Signal Database window with the Channel Table tab selected. The table describes the fields and buttons of the tab. The channels selected here are included in the Signal Channel Selection window. (See the [Channel Navigation toolbar](#) section for information about channel selection.)

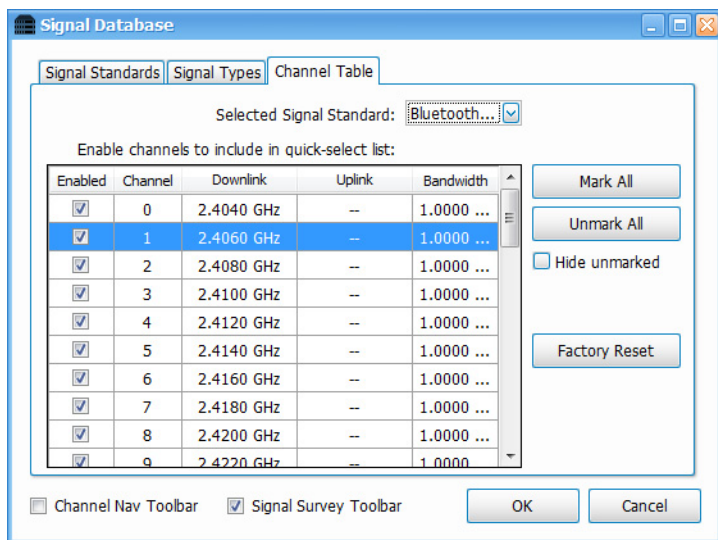

Item	Description
Selected Signal Standard	Drop down list allows you to select the signal standard, the channels of which will populate the channel table. This list is taken from the enabled standards in the Signal Standards tab.
Enabled column checkboxes	Enables/disables the channel in the row.
Mark All	Selects all channels in the table to enable them.
Unmark All	Deselects all channels in the table to disable them.
Hide unmarked checkbox	Hides any deselected channels so that you can view only the enabled channels in the table.
Factory Reset	Sets each channel to the factory-specified enabled/disabled state.

Item	Description
Channel Nav Toolbar checkbox	Check box to open the Channel Navigation toolbar. The Signal Database window stays open. You can read more about the Channel Navigation toolbar here .
Signal Survey Toolbar checkbox	Check box to open the Signal Survey toolbar. The Signal Database window stays open. You can read more about the Signal Survey toolbar here .

Channel Navigation toolbar

Select **View > Chan Nav Toolbar** to view the Channel Navigation toolbar. This toolbar allows you to navigate easily from channel to channel in any measurement display. It provides the following capabilities:

- Select a channel for enabled standards (only standards selected in the Signal Database).
- Select the channel direction, if applicable (uplink or downlink).
- Access the Signal Channel Selection window, which allows you to select from a list of enabled channels.

The following image shows the toolbar and the following table describes how it functions.

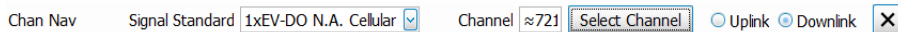

Item	Description
Signal Standard	Drop down list allows you to select the signal standard, the channels of which will populate the Channel field to the right. This list is taken from the enabled standards in the Signal Standards tab of the Signal Database.
Channel	<p>This field shows the channel number of the currently selected signal standard that the instrument is currently tuned to. An entry of "--" indicates that the current instrument frequency does not match that of any of the currently enabled channels.</p> <p>Clicking in this field allows for direct channel number entry. To select the next or previous channel, you can use the up and down arrow keys on your keyboard or the arrows in the Numeric Keypad (in the View menu, check the Numeric Keypad box). Note that this applies to enabled channels only.</p> <p>If you see a \approx in front of the channel number, it means that the current instrument frequency is close to, but not exactly equal to, the currently selected channel. It means that the current instrument frequency does not exactly match the currently selected channel frequency, but that it is within the current channel bandwidth.</p> <p>You cannot directly enter or use the arrow keys to select non-numeric channel names for signal standards. You must use the Select Channel button.</p>

Item	Description
Select Channel	Opens the Signal Channel Selection window. This window shows a table of enabled channels for the selected standard. Click on the channel you want to view in the plot and then click the OK button. This window also allows you to access the Signal Database window (using the Enabled Channels button) so that you can enable different channels or change standards or types, if desired.

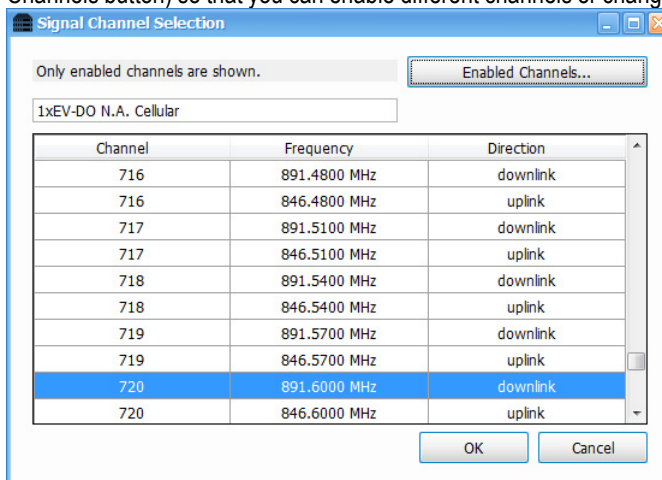

Uplink	Click to select the uplink channels for the currently selected signal standard.
Downlink	Click to select the downlink channels for the currently selected signal standard.

See also:

[How to use the Signal Database. \(see page 561\)](#)

Saving and Recalling Data, Settings, and Pictures

You can save different types of data for later recall and analysis.

Data type	Description	Save as type
Setup files	Saves all of the setup information for all displays, except those settings that are not part of Preset.	Setup (.Setup)
Picture of Selected Display (PNG/JPG/BMP)	Saves a capture of the screen in the specified format. This option is useful for including the graphic in reports or other applications. Marker readouts and other information are included.	Picture (.BMP, .PNG, .JPG)
Results Export files	Saves the trace and numeric data for the selected display. The trace and numeric data are saved as CSV files.	Results export (various)
Measurement Settings	Saves a list of settings relevant to the selected measurement to a text file. This option is useful for including the measurement settings in reports.	Measurement settings export (TXT)
Trace	Saves a trace for later recall into the display from which it was saved.	Selected trace (various)
Data	Saves data for reanalysis later or as data to use with external software (either CSV (comma-separated value) or MAT (MATLAB format)).	Acquisition data with setup (TIQ); or Acquisition data export (CSV or MAT)

Saving Files

Saving files follows the same procedure regardless of the type of data being saved. To save setups (including application presets), pictures, results, or acquisition data:

1. Select **Save As** from the **File** menu to open the **Save As** dialog box.
2. Navigate to the folder where you want to save the setups, or use the default location.
 - To save setups so that they appear in the Application Presets window, save your setup in the folder **C:\SignalVu Files\User Presets**. The saved setup will appear in the Application Presets window with the name you give the file.
3. Enter a file name.
4. Select the type of file to save from the **Save as type** drop-down list.
5. Click **Save**.

Recalling Files

You can recall three types of files: Setup files, Selected Trace, and Acquisition data with setup. Recalling data follows the same procedure regardless of the type of data being recalled.

1. Select **Recall** from the **File** menu to open the **Open** dialog box.
2. Navigate to the folder containing the file you want to recall.
3. Select the type of file to recall from the **Files of type** drop-down list. This selection determines the files that appear in the Open dialog box.
4. Select the file to recall.
5. Click **Open**.

Recalling Oscilloscope Waveform Files in SignalVu

You can recall waveform files in two ways. First, SignalVu can recall waveforms from the TekScope application. Second, SignalVu can recall waveform files directly when certain requirements are met. To recall waveforms from the TekScope application, you must recall the desired waveform file with the TekScope application as a reference waveform.

NOTE. *Before recalling a waveform (WFM) file, adjust the SignalVu settings as you want them. Otherwise, increasing the span or changing center frequency after recalling the waveform might result in the error message "Acq BW too small."*

Recalling Waveforms from the TekScope Application. To recall a waveform from the oscilloscope reference memory:

1. Recall the waveform file using the TekScope application.
2. From the SignalVu application, select **Acq** to display the Acquire control panel.
3. Specify the **Signal Input** as appropriate.
4. Set the **Source** to specify the reference waveform that contains the waveform file you recalled.
5. Click **Run** to analyze the recalled waveform.

Recalling a Waveform File Directly with SignalVu. When recalling an oscilloscope waveform file directly with SignalVu, keep these requirements in mind:

- When SignalVu is set for Signal Input = RF, the waveform to be recalled must be a single-channel waveform such as CH1, Ref 3, etc. or a "Displayed Analog" file saved with only one channel active.
- When SignalVu is set for Signal Input = IQ, the waveform recall must specify a file that also has a "twin", another file with the same base name. An example would be "xxx_CH1.wfm" and "xxx_CH2.wfm". Saving as Displayed Analog with 2 channels acquired automatically saves two wfm files with matching base names.
- When SignalVu is set for Signal Input = Diff IQ, there need to be 4 files available with the same base name.

To recall an oscilloscope waveform file directly with SignalVu:

1. From the SignalVu application, select **Acq** to display the Acquire control panel.
2. Specify the **Signal Input** as appropriate.
3. Set the **Source** to specify the reference waveform that contains the waveform file you recalled.
4. Click **Replay** to analyze the recalled waveform.

Supported MAT File versions

Data recall and saving using .mat file supports two versions: MATLAB Level 5 (v6) and MATLAB v7.3.

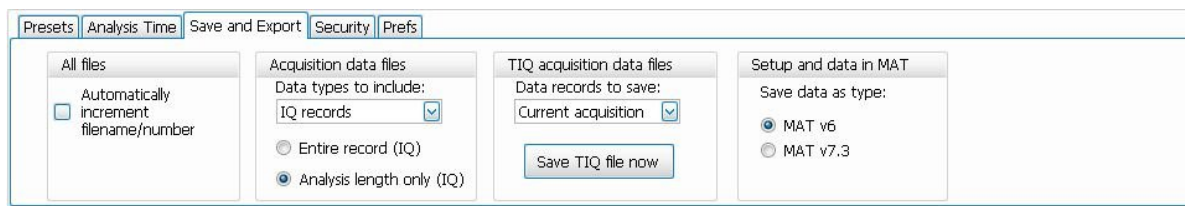

MATLAB v7.3 uses HDF5 format to store data and does not have the limit of 2 GB per variable that Level 5 does. If you try to save more than 2 GB in MATLAB Level 5 (v6 format), a warning shows and prompts you to select Level 7.3 format.

Setup Files

You can set up the instrument as desired and then save the settings in a setup file. This enables you to quickly setup the instrument by recalling previously saved setups.

Exporting Results

Save for further analysis of results in other programs, such as MATLAB or Excel.

Pictures of the Selected Display

You can save pictures of the instrument display for documentation purposes. When saving pictures of the display, you can select from three file types: BMP, JPG, or PNG.

Measurement Settings

You can save a list of settings relevant to the selected display to a file for documentation purposes. The exported file uses tab characters to separate values. The settings included in the file depend on the selected display. The contents of the file are the same as a Results export except it does not include the results.

Saving Acquisition Data with Setup

Save for later analysis with the analyzer. The setup is saved as part of the acquisition data file so you can choose when recalling data whether or not to also recall the associated acquisition and analysis parameters.

Saving Acquisition Data Export in CSV Format

Save for examining results in other programs, such as MATLAB or Excel.

Data, Settings, and Picture File Formats

You can save different types of data for later recall and analysis.

Saved File Types

File type	File extension	Description
Setup files	.setup	Setup files enable you to save instrument settings for later recall. Using these files saves setup time and ensures consistent measurements.
Picture	.png/.jpg/.bmp	Screen capture of SignalVu application window. They are useful for documenting results in test reports.
Results Export	.csv	Results files contain the trace points and numeric values that were produced by the selected measurement. The header of a Results file includes key acquisition and analysis settings to aid in the interpretation of the data. The file is saved as a plain text file, but the contents are formatted as CSV (comma-separated values). Results files can be opened from applications such as Microsoft Excel and MATLAB.
Measurement Settings	.txt	Measurement settings files contain a list of settings that describe how the instrument is set up for the selected measurement. The list contains measurement settings (for example, Span), trace settings (for example, whether or not a trace is selected) and global settings (for example, Frequency and Reference Level). The list of settings contained in the file varies depending on which display is selected.
Selected Trace	Varies with display	Trace files contain the trace results data in binary format. These files are only readable by the SignalVu application. Several of the instrument's measurements allow you to recall a Trace file for visually comparing a saved trace to a live trace.
Acquisition Data with Setup	.tiq	These files contain the acquisition data record and complete instrument setup (in binary format). Use these files to save data for later recall and analysis. When you save an Acquisition Data file, the current Setup is always saved with the file. At the time of recall, you will be asked whether you want to restore only the acquisition data or both data and setup. If the instrument is already set up for a specific measurement, you will probably want to recall only the acquisition data. Recalling both data and setup returns the instrument to the same state it was in at the time you saved the file. GNSS time locked with GPS enabled.

File type	File extension	Description
Acquisition Data	.csv	These files contain IQ sample data before it has been processed by a measurement. The acquisition data points are saved as IQ pairs. Use this format to import the acquisition data into Microsoft Excel for further analysis.
Acquisition Data	.mat	These files contain IQ sample data before it has been processed by a measurement. The acquisition data points are saved as IQ pairs. Use this format to import the acquisition data into MATLAB for further analysis. These files also contain instrument setting information. You do not have to use the settings information. To remove it, you can load all information to MATLAB, then write out is a .mat file without the settings information. (See the Acquisition Data Files (.mat) (see page 573) topic for required .mat format.)
Range file	.csv	These files contain a list of settings that describe how the instrument is set up for the Spurious measurement. The file contains the number of ranges enabled, the start and stop frequencies for each enabled range, the limits for each enabled range, the mask type and more.

Results Export File Format

The Results Export format contains trace points and/or scalar results produced by the measurement. The file contains general information about the measurement settings at the top of the file and the results data in the second part of the file. Groups of settings or results are headed with [text], as described below.

At the top of the file is the measurement name and the date and time data was acquired.

The first group of settings is [Global Parameters]. These settings include the Measurement Frequency, Acquisition Data, Reference Level and others.

The second group of settings is [Parameters]. These settings are specific parameters which vary depending on the measurement.

The next group is [Trace Parameters], which may not be present, depending on the measurement. Within this group, there are parameters specific to a trace. There will be a Trace Parameters group for each trace shown on the display.

The next group is [Results]. These are scalar results for the measurement.

Next is [Traces]. The Traces group consists of one or more [Trace] groups. There is one Trace group for each trace. Each [Trace] group contains background information about the trace (units, number of points, x scaling, and others depending on the measurement) at the top of the group, followed by the trace points.

Acquisition Data with Setup File (.tiq) Format

The file consists of two parts: the header that is in XML and the data that is in binary format.

Header. The header consists entirely of the DataFile element. This element is broken down into sub-elements.

1. DataSetsCollection
2. Setup
3. GNSS data

The GnsData group starts at byte location 612,312. GNSS data is bracketed as <GnsData></GnsData>. Each GNSS parameter is bracketed by its name. For example, <PositionX>76.854334</PositionX>.

In order of occurrence:

- Status
- Position X
- Position Y
- Altitude
- Timestamp
- Speed
- Course
- Satellites Locked

DataSetsCollection. The DataSetsCollection contains a DataDescription element, a DataSet element, and a ProductSpecific element.

Binary data. Binary data is a sequence of Int32 values, which are IQ pairs (I,Q,I,Q, ...) in binary Little Endian format.

To convert these values to volts, multiply the individual values by the Scaling value in the DataDescription.

The binary data starts at an offset into the file == the "offset" attribute in the DataFile element. This offset number will always start at the 19th character into the file (starting with 1), and will always be 9 characters long.

NOTE. *Modifying the XML header will change the offset to the start of the binary data.*

Acquisition Data Files (.csv)

The acquisition data files have two sections. At the top of the file is the following information:

- SamplingFrequency - The sampling frequency in Hertz.
- NumberSamples - The number of IQ samples in the file.
- DateTime - When the data was acquired.
- Frequency - The center frequency in Hertz.
- AcquisitionBandwidth - The acquisition bandwidth Hz.

Following the AcquisitionBandwidth are the data. The data are IQ pairs, in volts.

Groups of settings or results are headed with [some text].

The first thing in the file is the measurement name and the date/time when the acquisition was taken.

The first group [Parameters] are global parameters. Measurement Bandwidth in this group is the measurement bandwidth used by the General Signal Viewing measurements (Spectrum, Amplitude vs. Time, etc). It also includes some source settings, like Acq BW, Dither, Preamp, and RF Attenuation.

The second group [Parameters] are measurement-specific parameters.

Another group which can occur is [Trace Parameters]. Within this group, there will be a set of parameters, one for each trace that is currently shown.

Another group is [Results]. These are scalar results for the measurement.

Another group is [Traces]. It has [Trace] groups under it, one for each trace. Each [Trace] group has some background information about the trace (units, number of points, x scaling, etc), and the trace points themselves.

Acquisition Data Files (.mat)

The acquisition data files saved in MATLAB format contain the following MATLAB variables:

- InputCenter - The center frequency in Hertz.
- XDelta - The sample period in seconds.
- Y - A complex array containing IQ pairs.
- InputZoom - The acquisition bandwidth in Hertz.

The MATLAB format used to save acquisition data has the following properties and limitations:

- Files are stored in MATLAB Level 5 (when v6 is selected) or Level 7.3 (when v7.3 is selected) format.
- MATLAB Level 5 file size is limited to 2 GB. If you try to save more than 2 GB in MATLAB Level 5 (v6 format), the following warning shows and prompts you to select Level 7.3 format.



Printing Screen Shots

You can print screen shots (screen captures) two ways: use File > Print or save a picture file and print the file using a separate graphics program. Printing a screen capture is the same as printing with any windows program. For details on the available file formats for saving a screen capture, refer to [Data, Settings, and Picture File Formats \(see page 570\)](#). For details on saving a picture to a file, see [Saving and Recalling Data, Settings, and Pictures \(see page 567\)](#).

To print a screen shot:

1. Select **File > Print**.
2. Select **File > Print Preview** if you wish to review the screen shot before sending it to the printer.
3. Select **File > Print** to print the file to a printer.

Application Help

Menu Bar: Help > User Manual

This menu item displays this Help. It is a standard Windows help system. The Help menu item is the only method available to display the help; there are no other links to the help within the software.

About the Vector Signal Analysis Software

This window displays information about the SignalVu software and oscilloscope hardware it is running on.

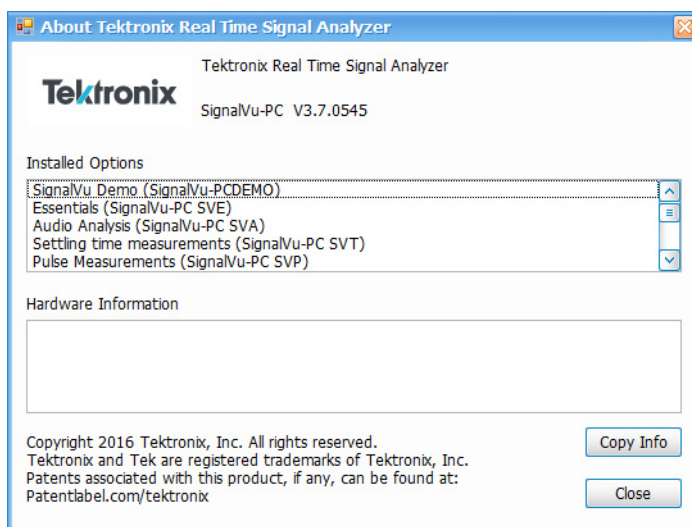

Version

At the top of the window is a line that displays the version of the vector signal analysis application software.

Installed Options

This text box lists the software options installed. This window does not list the options installed on the oscilloscope, just those that are installed with the vector signal analysis software.

Hardware Information

This text box lists the serial number of the oscilloscope on which the software is running.

Copy Info

The Copy Info button copies information about the instrument to the Windows clipboard. This information may be useful if you need to have your instrument serviced. The following text is an example of the information copied when you click Copy Info:

Tektronix Vector Signal Analysis Software

V2.6.2012

Installed Options:

Essentials (Opt SVE)

Pulse Measurements (Opt SVP)

General Purpose Modulation Analysis (Opt SVM)

Hardware Information:

Serial Number: B000001

Main menu overview

The main menus are:

Menu	Description
File (see page 577)	Select measurements, open and save files, print documents, and preset.
View (see page 581)	Change display size, display the Marker toolbar and Status bar.
Replay (see page 533)	Replay measurements; select which record(s) to play, Replay/Stop/Pause, or enable continuous loop.
Markers (see page 585)	Search for signal peaks, center the display to a marker, and access the Define Marker panel.
Setup (see page 585)	Change settings for acquisition, analysis, and measurements.
Tools (see page 586)	Perform searches and configure user preferences.

Menu	Description
Window (see page 587)	Controls the size and layout of displays within the SignalVu application.
Help (see page 587)	Access the help and display information about the SignalVu software.

File Menu

Command	Description
Recall (see page 577)	The Recall dialog enables you to recall saved data, setups and traces.
Save (see page 578)	Saves a file without asking for a file parameters (based on most recent settings).
Save As (see page 578)	Displays the Save dialog enabling you to specify the parameters of the save operation.
Acquisition data info (see page 532)	Displays the Acquisition Info tab (see page 532) of the Replay control panel. The info on this tab describes such acquisition parameters as acquisition bandwidth, sampling rate, RF attenuation, and acquisition length.
Measurement Data Info (see page 580)	Displays the characteristics of the most recently analyzed record in the display.
Print (see page 581)	Prints the selected display.
Print Preview (see page 581)	Displays a preview of the print output.
Exit	Closes the SignalVu application. Exit does not shut down the instrument.

Recall

Main menu bar: File > Recall

Favorites toolbar: 

Use the Recall command to load previously saved acquisition data, setups or trace data.

To Recall Data or Setups

1. Select **File > Recall**. This displays the **Open** dialog box.

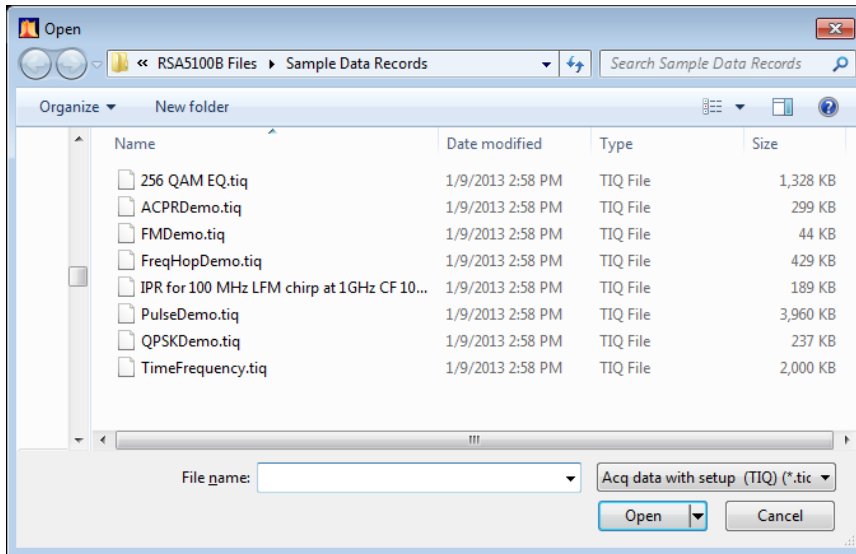

2. Select the file type to be recalled and click **Open**.

Save / Save As

Menu Bar: File > Save / Save As

Use Save / Save As to store acquisition data, setups, and traces. Save is also used to export traces, results and pictures of the display for use in other programs.

Difference Between Save and Save As

Use Save As to specify what kind of data you want to save and where the data should be saved. Use Save to quickly save the same data as you saved the last time you executed a Save, without having to specify the data type and location.

For example, suppose you want to save a picture of a spectrum trace each time you adjust a circuit to document how the adjustments affect the output of the circuit. The first time you want to save a picture of the display, you will need to select Save As. From the Save As dialog box, you specify the type of data you want to save (Picture of Selected Display) and specify the location of the saved file. As long as the [Save and Export option \(see page 21\)](#) is set to automatically name saved files, the next time you want to save a picture of the display, you can just press Save on the front panel and a picture of the selected display will be saved without requiring you to type a file name or the location of the file to be saved.

What Data Types Can Be Saved

Data type	Description
Acquisition Data	Data collected during acquisition that can be recalled for later analysis. Data is saved in a format readable only by RSA6100/RSA5100/SPECMON Series instruments or oscilloscopes running SignalVu software.
Setup	Configuration information detailing instrument settings. Data can be saved in a format readable only by SignalVu-PC, oscilloscopes running SignalVu software, or RSA6100/RSA5100/SPECMON Series instruments.
Selected Trace	Saves the selected trace for later analysis by the analyzer. Data is saved in a format readable only by SignalVu-PC, oscilloscopes running SignalVu software, or RSA6100/RSA5100/SPECMON Series instruments.
Exported Traces and Numeric Results	Save traces and results in a file format that can be used by other programs.
Pictures of the Display	Save screen images in graphic image file formats that can be used in other programs.
Exported Acquisition Data	Save acquisition data records in a file format that can be used by other programs. Acquisition data can be saved in either comma-separated-variable format or MATLAB format.

[Data, Settings, and Picture File Formats \(see page 570\).](#)

Options for Saving Pictures of the Display

Option	Setting	Description
Image Format	PNG	Saves exported screen captures in Portable Network Graphics format.
	JPG	Saves exported screen captures in Joint Photographic Experts Group (JPEG) format.
	BMP	Saves exported screen captures in Windows bitmap format.

Measurement Data Info

The Measurement Data Info command in the File menu displays a listing of acquisition-related information about the last data analyzed by the selected measurement. The last data can be from the current acquisition or it could be from a recalled data file.

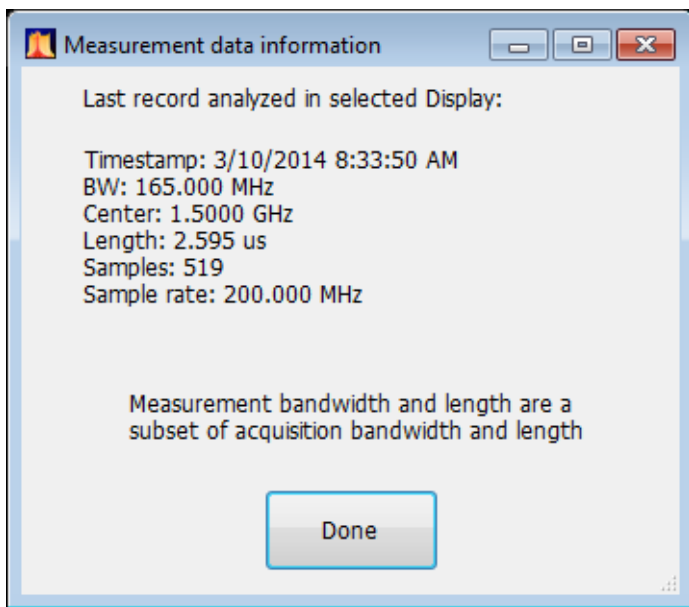

Scope Data

The Scope Data tab displays the sample rate and record length of the data received from the oscilloscope or from a recalled oscilloscope waveform file.

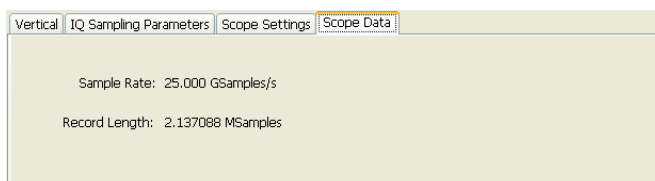

Print

Menu Bar: File > Print

Print displays the Windows Print dialog box for printing a screen capture of the display. To save ink when printing, use the Colors tab to set the color scheme. See [Options Settings \(see page 21\)](#).

Print Preview



Menu Bar: File > Print Preview

Print Preview shows how a print out will appear when it is printed.

View Menu

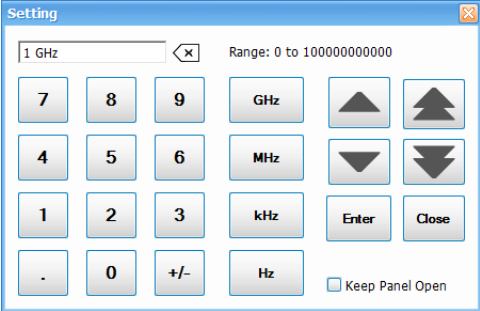
The View menu enables you to control the display of views and toolbars in the application window.

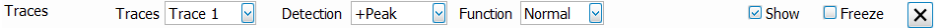
Command	Description
Full Screen (see page 582)	Toggles all views between full-screen size and user-selected size.
Navigator View (see page 40)	<p>Selecting Navigator View adds the Time Overview display to the existing measurement displays to provide a better perspective of the signal.</p> <p>When the Navigator View is enabled, the Time Overview display is always located above any other measurement displays and uses the maximum horizontal resolution of the display area, regardless of the Window Tile setting.</p>
Numeric Keypad	<p>When selected, any time you place the cursor within a control or setting that takes a numeric value, you are presented with a dialog box to easily enter a value.</p> <p>For instance, placing the cursor in the Frequency setting, displays the following dialog screen.</p> 
Chan Nav Toolbar (see page 564)	<p>Use the arrow buttons to change the value.</p> <p>Press the calculator icon to display a keypad that allows you to enter values and suffixes.</p> <p>Check to view the Channel Navigation toolbar. Uncheck to hide it. Detailed information about this toolbar is available in the Channel Navigation toolbar topic.</p>

Command	Description
Signal Survey Toolbar	Check to view the Signal Survey toolbar. Uncheck to hide it. Detailed information about this toolbar is available in the Signal Survey toolbar topic.
Map It Toolbar (Only available with optional MAP application license.)	Check to view the Signal Survey toolbar. Uncheck to hide it. Detailed information about this toolbar is available in the How to use Map It topic.
Replay Toolbar (see page 535)	Check to view the Replay toolbar. Uncheck to hide it.
Traces Toolbar	Check to view the Traces toolbar. Uncheck to hide it. This toolbar can also be accessed from the Basic Controls Toolbar. It allows quick access to the trace controls of the selected measurement display. This example is the Spectrum trace toolbar. 
Markers Toolbar (see page 515)	Check to view the Markers toolbar. Uncheck to hide it. This toolbar can also be accessed from the Basic Controls Toolbar. It enables you to define Markers and perform Peak searches. Click the Define button on the toolbar to define markers. See the Define Markers menu topic for detailed information.
Basic Controls Toolbar	The Basic Controls toolbar is defaulted to on and is located just above the Status Bar. It allows quick access to controls and settings of the selected measurement display. This example is the Spectrum Basic Controls toolbar.  <p>It contains the following:</p> <ul style="list-style-type: none"> ■ Name of selected measurement window ■ Frequency: The center frequency in the active display. To change the value, click the text and enter a value with a keyboard or the numeric keypad. For fine adjustments, you can use the mouse wheel. ■ Reference: Reference level in the active display. To change the value, click the text and enter a value with a keyboard or the numeric keypad. ■ Span: The span in the active display. To change the value, click the text and enter a value with a keyboard or the numeric keypad. For fine adjustments, you can use the mouse wheel. ■ Res BW: The resolution bandwidth (RBW) in the active display. To change the value, click the text and enter a value with a keyboard or the numeric keypad. For fine adjustments, you can use the mouse wheel. ■ Show or hide the Markers toolbar ■ Show or hide the Traces toolbar ■ Show or hide the Settings Control Panel
Status Bar (see page 583)	The Status bar is defaulted to on and is located at the bottom of the application window.

Full Screen

Menu Bar: View > Full Screen

When unchecked, clicking **Full Screen** resizes the application window to fill the screen. Full Screen mode maximizes the application window, and turns off the application title bar.

When checked, clicking **Full Screen** restores the application window to its previous size. The application title bar is restored.

Status Bar

The Status Bar displays information on specific instrument settings. It contains only status information; it does not display any error information. The Status bar has no controls. It can not be hidden.

Elements of the Status Bar

Area within Bar	Description
Run Status	Displays the running state. For example, some run states are Acquiring, Analyzing, Ready, or Stopped.
Status message area	Displays status messages (for example, Data from ADC Overrange). When there no status messages to report, displays current acquisition parameters (for example, Acq Length: 22.320 us).
Acquisition parameters	Displays parameters of the acquisition, such as acquisition bandwidth and acquisition length.
Scope Sample Rate	Displays the oscilloscope sample rate, for example, 25.00 GS/s.

Run Status Indicators

Indicator	Description
Acquiring	The analyzer is capturing the signal.
Analyzing	The analyzer has captured the signal and is processing the signal record.
Replaying	The analyzer is analyzing recalled waveform or acquisition records.
Stopped	If Stopped is displayed, Signal acquisition has been halted. This can occur because the Run button has been pressed or because a trigger event has occurred, signal acquisition has occurred and Run mode was set to Single.

Run Menu

The Run menu provides access to commands that control the signal acquisition.

Command	Description
Run (see page 541)	If acquisition mode is Stopped, selecting Run begins a new measurement/acquisition cycle. If acquisition mode is Run, pressing Run halts the current measurement/acquisition cycle after it completes.
Resume (see page 541)	Restarts data acquisition, but does not reset accumulated results, such as Average or MaxHold. This allows you to stop acquisitions temporarily, then continue. If the accumulation is already complete, for example, 10 acquisitions or 10 averages have already been completed, each subsequent Resume command will cause one more acquisition to be taken, and its results added to the accumulation. Resume is not available if instrument settings have been changed.
Abort (see page 541)	Immediately halts the current measurement/acquisition cycle.
Single Sequence (see page 584)	Selects the single-sequence acquisition mode. This is only a mode selector; it does not initiate an acquisition.

Single Sequence Acquisition Mode

Menu Bar: Run > Single

Selecting **Single** sets the Run mode to Single. In Single mode, as soon as one acquisition sequence completes, acquisition stops.

Note that a single acquisition sequence can require more than one acquisition. For example, in a spectrum view, the trace function might be set to Average 100 acquisitions. Thus, a complete acquisition sequence would consist of 100 acquisitions to produce 100 intermediate traces that are averaged together to create the final trace that is displayed. Once the 100 acquisitions have been completed, acquisition stops.

This is only a mode selector, it does not initiate an acquisition.

Continuous Acquisition Mode

Menu bar: Run > Continuous

Selecting **Continuous** places the analyzer in the Continuous acquisition mode. In Continuous mode, the analyzer acquires and displays acquisitions repeatedly. The Continuous and Single Sequence acquisition modes are mutually exclusive.

Selecting Continuous restarts acquisitions.

Replay Menu

Reruns measurements using the current acquisition data or a saved file. Use this to compute new results for old data after you change settings. If you are working with a recalled oscilloscope waveform file, you should recall the file again rather than using Replay.

Markers Menu

The Markers menu provides to settings that define and control the location of markers.

Setting	Description
Peak (see page 513)	Moves the selected marker to the highest peak on the trace.
Next Peak >	Moves the selected marker to next peak depending on the setting chosen.
Marker to Center Frequency	Sets center frequency to the frequency of the selected marker.
Define Markers (see page 514)	Displays the Define Marker control panel.
Sync Scope C1 to Active Marker	Moves oscilloscope Cursor 1 to the location on the oscilloscope waveform that matches the location of the active maker on the SignalVu active marker. If the oscilloscope cursors are off, this command turns them on.
Sync Scope C2 to Active Marker	Moves oscilloscope Cursor 2 to the location on the oscilloscope waveform that matches the location of the active maker on the SignalVu active marker. If the oscilloscope cursors are off, this command turns them on.

Setup Menu

The Setup menu provides access to control panels that specify parameters for numerous vector signal analyzer functions.

Command	Description
Displays (see page 25)	Displays the Select Displays window.
Settings (see page 598)	Displays the Settings control panel for the selected display.
Acquire (see page 542)	Displays the Acquire control panel.
Analysis (see page 525)	Displays the Analysis control panel.
Amplitude (see page 537)	Displays the Amplitude control panel.

Presets Menu

The Presets menu provides you access to instrument presets and preset options.

Command	Description
Main (see page 13)	Resets the instrument to factory defaults. Acquisition data and settings that have not been saved will be lost.
Standards (see page 18)	Recalls the Standards presets.
Application (see page 586)	Recalls the Application presets.
User (Favorites) (see page 15)	Recalls the User presets.
Preset Options (see page 13)	Displays a control panel where you can configure options for Presets.

Presets > Main

Menu Bar: Presets > Main

Preset resets settings and clears all acquisition data. Settings and acquisition data that have not been saved will be lost.

After Preset resets the analyzer settings, it displays the Spectrum view.

Preset does not affect time or date settings; the Windows operating system settings, or Tools > Alignments or Tools Options menu items.

Application Presets

SignalVu includes a set of configuration files that are tailored to specific applications. These configuration files, referred to as Application Presets, open selected displays and load settings that are optimized to address specific application requirements. You can add to the default application presets by creating your own application (user) presets. For detailed information about these presets, see [Creating User Presets \(see page 15\)](#). You access the application presets through the Application Presets menu item. Early versions of the RSA software allowed users to add their own setups to the list of Application presets, but this capability has been replaced with User Presets.

Tools Menu

Provides access to several utilities for controlling instrument functions.

Command	Description
Mask Test (see page 519)	Enables you to locate and highlight specified signal levels in specified displays.
Options (see page 21)	Displays the Options control panel.
Signal Database (see page 561)	Allows you to select which signal standards and types are listed (and selectable) in the Channel Navigation toolbar and/or the Define Survey control panel.
RSAMap	Launches the optional MAP application.
Restore Scope	Moves the SignalVu application to the background and displays the TekScope application in the foreground.

Window menu

Use the Window menu to arrange how windows are displayed. Displays can be set to appear full screen (one display at a time) or with all (selected) displays visible at once. When all displays are visible at once, you can rearrange the displays by dragging the title bar of a window (deselect Window > Lock Windows to move displays around).

Command	Description
Close View	Closes the selected view.
Cascade	Positions windows in a cascade view (not available when Lock Windows is selected).
Tile Horizontally	Positions windows in a horizontal orientation (top to bottom).
Tile Vertically	Positions windows in a vertical orientation (side by side).
Lock Windows	Locks the windows into their current position, preventing them from being moved. If the windows are locked, the Cascade arrangement is not selectable.
(List of windows)	A numbered list of open windows.

Help Menu

The Help menu provides access to the Help and version information about the vector signal analyzer software.

Command	Description
User Manual	Displays a navigable, searchable Help tool.
User Manual (PDF)	Displays a PDF version of the Help.
Application Reference (PDF)	Displays a PDF version of the SignalVu Application Note.
Quick Start Manual (PDF)	Displays a PDF version of the SignalVu Reference Manual.
PI Command Search (see page 588)	Displays a navigable, searchable PI command search tool.
About Tektronix Real Time Signal Analyzer Software	Displays information about the vector signal analyzer software and installed options.

PI Command Search tool

The PI Command search tool allows you to search for programming commands by typing the syntax or key words into the search text box.

For a quick search, do the following:

1. Select the **Search** tab from the dialog box.
2. Type in the syntax or key word you are looking for in the text box.
3. Click on **List Topics**.

TO obtain an updated version of the PI commands manual, do the following:

1. Download the latest PI manual .CHM file from www.Tek.com/downloads.
2. Copy the downloaded *PICommandSearch.chm* file into the installer path *C:\Program Files\Tektronix\SignalVu-PC\RSA*.



CAUTION. Do not change the file name *PICommandSearch.chm* or the file will not be found by the application.

Favorites bar menus

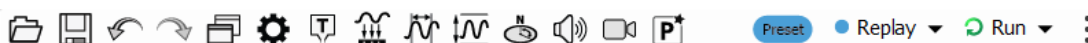

Menu	Description
Icons	The icons on the Favorites bar are detailed in the Specific areas of the application window (see page 9) topic.
Preset	Recalls the Main preset.

Menu	Description
Replay (see page 533)	Replay measurements; select which record(s) to play, Replay/Stop/Pause, or enable continuous loop.
Run (see page 584)	Start, stop and abort acquisitions, select single or continuous acquisition mode.

Error and Information Messages

The following list describes some of the common error and information messages that might appear during instrument operation. Messages that apply specifically to one or more measurements appear in the displays. Messages that pertain globally, such as those about hardware status, are shown in the Status Bar at the bottom of the analyzer application window.

Acq BW too small for current setup

The display needs a wider acquisition bandwidth than what the current data record contains. This can be due to any of the following reasons:

- The sampling parameters are being manually controlled.
In the Acquire control panel > Sampling Parameters tab, set the Adjust control to All Auto to allow the software to pick the sample rate and record length that it needs.
- A display other than the one you intended has been selected. The selected display has requested a smaller acquisition bandwidth to achieve a better accuracy or dynamic range for its particular measurement.
Select the display that contains the message. Click Run if the instrument is not already acquiring data.
- Acquisitions are not running and the measurement now requests a wider bandwidth than the last acquisition.
Click Run to perform a new acquisition with a wider bandwidth.
- The data is from a recalled TIQ file.
There is no way to increase the acquisition bandwidth for saved IQ data. You must adjust the measurement settings so that less bandwidth is required.
- The data is from a recalled oscilloscope waveform file.

In the Acquire control panel, compare the Samples/s readout on the IQ Sampling Parameters tab to the Sample Rate readout on the Scope Data tab. If the sample rate for the oscilloscope data is more than twice the value of the IQ sample rate, it means that the recalled waveform data was decimated for a previous analysis that didn't need the full bandwidth of the oscilloscope waveform. Recall the oscilloscope waveform file again to force the software to perform a new conversion based on your new measurement settings. Each time you change measurement settings in a way that increases the required acquisition bandwidth, you will need to recall the oscilloscope waveform file.

- The current Frequency setting is different than that of the data record, causing the measurement bandwidth to fall at least partly outside the bandwidth of the data.

If you are using a recalled oscilloscope waveform file, try recalling it again with the new Frequency setting. This will force a new conversion from oscilloscope samples to IQ samples.

Analysis failure: <description of error>

The instrument is unable to complete a measurement due to difficulty in characterizing the signal. For example, due to either the signal or settings, the instrument may not be able to recognize a pulse so it can compute the pulse measurements.

- Try changing settings to improve analysis. For example, when Pulse Trace is displayed, try changing the settings on the Settings > Params.

Analysis failure: Carrier detection failed

The instrument was unable to locate a carrier signal. Try adjusting the Carrier Threshold or Integration BW values, if the measurement has these controls.

Analysis Length was limited

This message appears if the "Results Length", the time over which the measurement computed its results, is less than the Actual Analysis Length reported in the Analysis Time control panel tab and the Time Overview display. The Results Length is indicated by the magenta line below the Time Overview graph. This can occur because the acquisition contained more data samples than a measurement can process (for example, digital demodulation is limited to 80,000 samples) or the measurement had to use some of the first and last samples for pre-measurement processes.

Analysis length too small for current setup

Increase the Analysis Length or decrease the RBW (Spectrum, ACPR, MCPR).

Avg Tx not available in Volts units

The Average Transmitted Power measurement is not defined for Volts.

Can't get acquisition data record

No acquisition record currently exists in memory (run an acquisition or recall a file), or an error has occurred. Repeat the acquisition.

Can't replay data from swept acq

The measurement could not produce results because it is a real-time only measurement but was asked to reanalyze (Replay) an acquisition taken in swept mode.

Can't replay. Live data needed for swept settings

The measurement could not produce results because it was asked to reanalyze (Replay) the acquisition but it is in Swept acquisition mode. Swept-mode measurements cannot analyze recalled data.

CISPR accuracy limited by acq memory. Adjust RBW or freq range

The CISPR function was applied, but the available data did not represent a long enough time to satisfy CISPR requirements. Increasing RBW reduces the amount of time needed for analysis. Reducing frequency range (for example, by reducing Span), decreases sample rate, allowing the available memory to cover a longer time period.

Data acquired during hardware failure

An acquisition was completed even though a hardware failure was detected. This message refers to the acquisition data currently being analyzed, but not necessarily to the current status of the instrument.

If this data is from a saved file, the error cannot be cleared.

Data acquired during RF ADC overrange

An acquisition was completed but the signal was outside the range of the analog-to-digital converter at the time this data was acquired. This message refers to the acquisition data currently being analyzed, but not necessarily to the current status of the instrument.

If this data is from a saved file, this error cannot be cleared.

Data acquired during RF digital gain overflow

This data was acquired when the input signal contained peaks greater than 6 dB above the Reference Level setting.

If the data is from a file, this error cannot be cleared.

Data from unaligned instrument

The acquisition data was captured when the instrument was not aligned. This message refers to the acquisition data currently being analyzed, but not necessarily to the current status of the instrument. Measurements made on this data might not be accurate.

Data from warm-up period

This data was acquired while the analyzer was warming up. The warm-up period is 30 minutes. Until this warm-up period is completed, the analyzer is considered uncalibrated.

Disabled: data is from swept acquisition

The display needs to run in real-time mode. The display associated with this message cannot run now because it is not the selected display, and the selected display is performing multiple acquisitions (it is in swept mode).

- Change the settings of the selected display so it is performing real-time acquisitions.
- Select the associated display to make it the selected display. When it is selected, it will force the acquisition parameters to change to meet its own needs.

Frequency exceeds preamp range

This is a warning that signals below the minimum preamp operating frequency are likely to be severely attenuated (this is 100 kHz for option 51, 1 MHz for option 50).

Needs swept acq or larger AcqBW - Acquire data while display is selected

The display is not running because it needs to perform multiple acquisitions (it must be in swept mode) but it is not the selected display. Only the selected display can perform multiple acquisitions.

- Select the display showing this message to give it control of acquisitions parameters.

Sometimes, only one display can work and the others will be blank and show errors. This happens when different displays have conflicting demands on the acquisition data record.

Export failure: file not saved

An error occurred while exporting Results. The file was not created.

- Export the results again.

Export failure: unable to open results file for export. File not saved.

The Export Results file could not be opened for writing, so the export of results was not completed.

- Verify that there is sufficient free space on hard disk.

Insufficient data for CISPR. Acquire while display is selected

This message appears when a measurement is not the selected measurement and CISPR filters are selected. Set the measurement to be the selected measurement and reacquire the signal.

IQ Processing Error: 8012

This message occurs in GP Digital Modulation displays. The most likely cause for this message is that there are not enough symbols to analyze. This can happen if:

- The Analysis Length is set too short. Increase the Analysis Length on the Analysis Time tab.
- The Analysis Offset has pushed the Analysis Time so far out that the actual Analysis Length is too short, even though the user-requested Analysis Length would have been long enough without the excessive offset. Decrease the Analysis Offset on the Analysis Time tab.
- The input signal is bursted, and the burst does not contain enough symbols.

Needs swept acq or larger Acq BW - Acquire data while display is selected

The display has one of two problems: It is not the selected display, which prevents it from controlling the hardware acquisition parameters, and setting the acquisition mode to Swept; or its settings require a wider data bandwidth.

- Select the display that you are interested in and it will change the acquisition to meet its own needs.
- Increase the acquisition bandwidth manually or by changing the selected display's settings to cause the wider bandwidth.

No Math trace: unmatched trace lengths

A math trace could not be produced because the traces selected to generate the math trace do not have the same number of points. This can easily happen if both traces are recalled, but were saved under different "Points" settings. This can also occur if one of the selected traces is a live trace and the other trace is a recalled trace.

- In a Spectrum display, as long as one trace is live, you can change the "Points" setting (Setup > Settings > Freq & Span tab) to match the recalled trace.
- If you are using two recalled traces to generate the Math trace. You must recreate at least one of the traces.

No burst detected

The [Burst Detection Mode \(see page 494\)](#) is On, but no burst was detected in the signal.

- Check that the Threshold setting is properly set.

Not enough samples for current setup

The measurement was not able to run because the combination of analysis length, offset, and measurement bandwidth relative to acquisition bandwidth, were such that not enough samples were available for the measurement to analyze. This can occur when two or more displays are shown and one display requires a wide acquisition bandwidth and another display requires a much narrower bandwidth. The display requiring the much narrower bandwidth must decimate and filter the acquisition record which can result in too few samples left for the measurement.

- Increase the Analysis Length to provide more samples.
- Close any displays you don't currently need.

Not enough samples – try increasing MeasBW

The measurement was not able to run because there are not enough samples available for the measurement to analyze. The Settling Time measurement requires at least 256 samples. This can occur when two or more displays are shown and one display requires a wide acquisition bandwidth and another display requires a much narrower bandwidth. The display requiring the much narrower bandwidth must decimate and filter the acquisition record which can result in too few samples left for the measurement.

- Increase the Analysis Length to provide more samples.
- Close any displays you don't currently need.

No FFT (not all pulses have results)

If a pulse cannot be measured (because its shape is too indistinct or it does not meet the [parameters that define a pulse \(see page 292\)](#)), its results will be “- -” for every measurement on that pulse. The instrument cannot compute an FFT.

No pulses found

The instrument was unable to find any complete pulses in the signal.

- Make sure the [analysis length \(see page 525\)](#) includes at least one complete pulse cycle, from before one rising edge until after the next rising edge.

Pulse Detection Error

The instrument was unable to detect a pulse.

- The pulse [Measurement Filter \(see page 292\)](#) needs to be smaller. Try reducing the bandwidth and/or selecting the Gaussian filter.
- Detection threshold is not set to the proper level for the signal. Adjust the [Power threshold to detect pulses \(see page 292\)](#).
- The pulse interval is too long for the current settings. Try decreasing the [filter bandwidth \(see page 292\)](#), as this may reduce the number of data points to a manageable quantity.

RBW conflict. Increase Span or Analysis Length

The measurement is not running because the actual RBW used by the measurement is too large for the current acquisition span. Typically, the analysis length is too short as well.

- Either increase the span or increase the Analysis Length.

RBW decreased

The current span or acquisition bandwidth is too small to allow a wider RBW filter.

- Increase the span or acquisition bandwidth if the decreased RBW is not acceptable.

RBW increased

The current Spectrum Length (or Analysis Length if Spectrum Length is not Independent) is too small to allow the requested RBW.

- Increase the Spectrum Length (or Analysis Length) if the increased RBW is not acceptable.

RBW limited by AcqBW to: XX Hz

The requested RBW is too close to the acquisition BW. Increase the frequency range of the measurement (for example, Span).

RBW too small/large for current Acq BW

If the RBW is set manually, it is possible for the acquisition bandwidth to be incompatible with the RBW setting.

- Change the RBW setting.
- Adjust the Acq BW setting, either directly (Setup > Acquire > Sampling Params: select on of the manual modes) or by adjusting the measurement bandwidth of the selected display (Setup > Acquire > Sampling Params: All Auto).

Recall error: Setup not completely restored

An error occurred while recalling a Setup file. Thus, the current setup may be a combination of settings from the Setup file and the previous Setup.

- Recall the setup again.

Recall failure: problem with file or file contents

An error occurred while recalling a Setup, Trace or Data file. This can occur because of a problem opening the file (operating system error) or because of a problem with the contents of the file.

- Recall the file again.

Restoring acquisition data

This is a status message displayed while data is being restored from a file.

Save failure: file not saved

An error occurred while saving a Setup or Data file.

- Save the file again.

Saving acquisition data

This is a status message displayed while data is being saved to a file.

Selected VBW does not use full Spectrum Length

This message can occur when the Spectrum Length is greater than required for the VBW filter. If you look at the Time Overview display, the Magenta line for Results Length indicates the part of the Spectrum Length that was actually used. The measurement results are correct, but don't include some of the data in the selected Spectrum Length. To clear this message, you can set the Spectrum Length to Auto.

Setup error: <description of error>

When this message appears, it includes text that explains the problem. For example, the ACPR display might show: “Setup error: channels can’t overlap”. Setup errors are the result of conflicts in instrument settings. These types of errors occur when a user makes manual changes to settings. In the example above, the channel settings in the Channel Power and ACPR display have been set so that the channels overlap in frequency.

- Adjust the instrument settings, or change a setting back to Auto, to eliminate the error.

Setup error: Integration BW exceeds Measurement BW

When this message appears, it includes text that explains the problem. Setup errors are the result of conflicts in instrument settings. These types of errors occur when a user makes manual changes to settings.

- Adjust the instrument settings, or change a setting back to Auto, to eliminate the error.

Setup error: Measurement time for Freq & Phase results

The [Measurement time for Freq & Phase results \(see page 294\)](#) specifies how far across the pulse top the instrument should wait before measuring the Phase Difference and Frequency Difference for each pulse. If this value is set too large for any of the pulses in the signal, the measurement point ends up on the falling edge or during the pulse off time.

- Decrease the Measurement time for Freq & Phase results setting (Settings > Define tab).

Unexpected software error. Please cycle power and try again. If the problem persists, contact your Tektronix Service Center.

An unrecoverable error has occurred, and the instrument application software will shut down.

- Switch the instrument off and restart it or relaunch the TekScope and SignalVu applications.

VBW not applied - Acq BW too small

Increase VBW or measurement bandwidth. Make sure Sampling Parameters are set to Auto.

VBW not applied - Spectrum Length too short

This message occurs when the requested VBW can't be produced because the Spectrum Length is too short.

To clear this problem, set the Spectrum Length to Auto or manually increase the Spectrum Length (see Setup > Analysis > Spectrum Time tab). If Spectrum Length is coupled to Analysis Length, set Analysis Length to Auto or manually increase it (see Setup > Analysis > Analysis Time tab).

Displaying the Windows Event Viewer

When the analyzer generates an error message, information about the error is logged to the Windows Event Viewer.

To display the Windows Event Viewer:

1. Select Start > Control Panel.
2. Select Administrative Tools. (If your instrument displays control panels in Category View, select System and Security, and then select Administrative Tools.)
3. Double-click **Event Viewer**.
4. From the Event Viewer window, select **Windows Logs**, then select **Application**. This displays a list of all errors that have been reported to the operating system from applications.

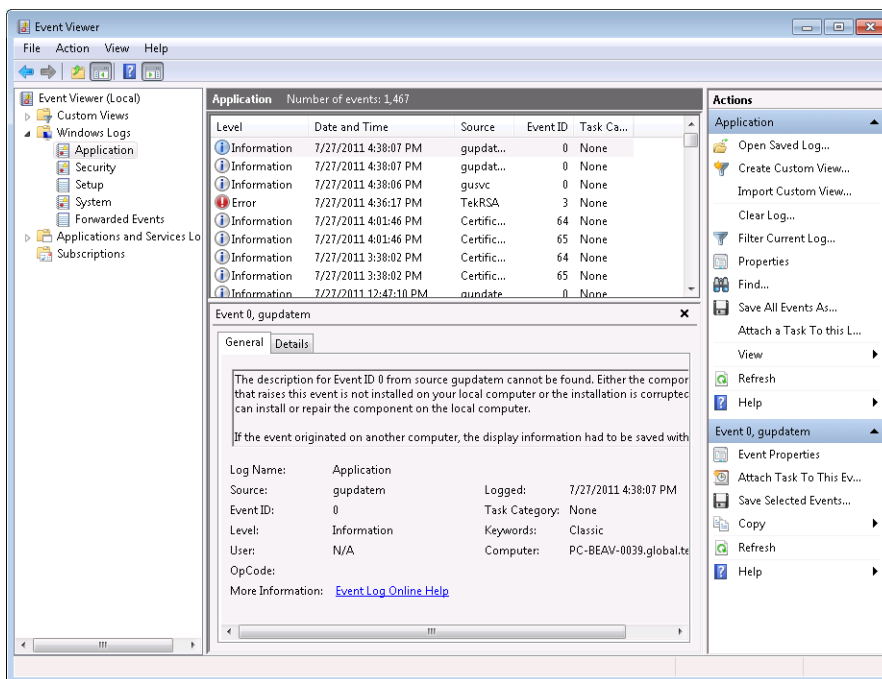

Errors reported to the Event Viewer from the analyzer application appear under Source as TekRSA.

5. Double-click the last error reported for TekRSA to see details on the most recently reported error. Please note that many items reported as “errors” are simply informational and do not mean that your instrument is impaired. Contact the Tektronix Customer Support Center or Service Center if you

are concerned about an error shown in the Event Viewer. Do not send an instrument out for repair based solely on these event reports.

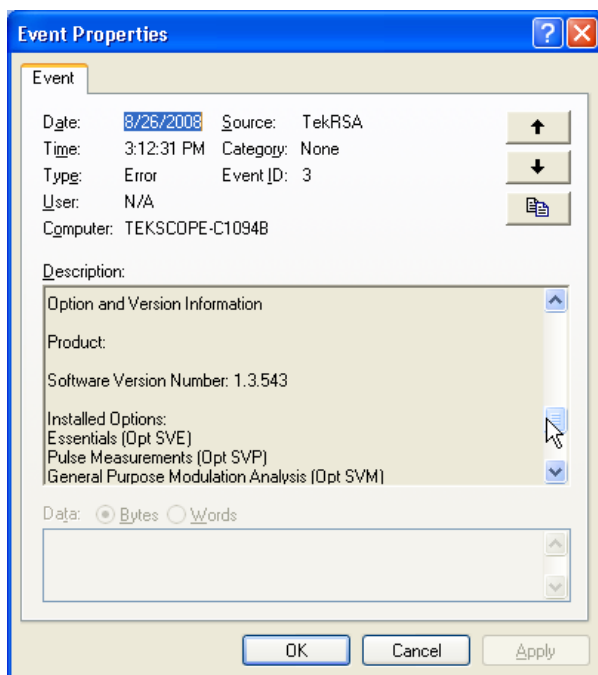

Dealing with Sluggish Instrument Operation

Over time you might notice that acquisitions seem to be occurring sluggishly. This can occur if the disk is too full or if someone has accidentally deleted the instrument cache file. While the instrument automatically recreates a missing 4 GB cache file, if the disk is too full when the replacement cache file is created, the cache file can be fragmented and result in sluggish performance.

If your instrument appears to be performing acquisitions slowly, do the following:

- Delete unnecessary files to create free space. After deleting unnecessary files, run a commercial disk defragmentation program.
- If removing unnecessary files and defragging the hard drive does not improve instrument performance, reinstall the operating system and application software. To do this, back up all your data and files, and then reinstall the instrument operating system. After reinstalling the operating system, reinstall the application software.

How to Find Out if Software Upgrades are Available

Software upgrades might be available can be downloaded from the Tektronix Web site. To see if a software upgrade is available for your product, use your browser to go to www.tektronix.com/software. Search by the product model number.

To add additional software options or features, you will need an option key from Tektronix. In some instances, you may need to upgrade the product software before adding the new option key. Follow the installation instructions provided with your software option.

Settings

Main menu bar: Setup > Settings

Favorites toolbar: 

The Settings menu item enables access to control panels that allow you to change settings for the selected display. The control panel that appears when you select **Settings** depends on the selected display. The Settings control panel for the Spectrum display is shown in the following figure.

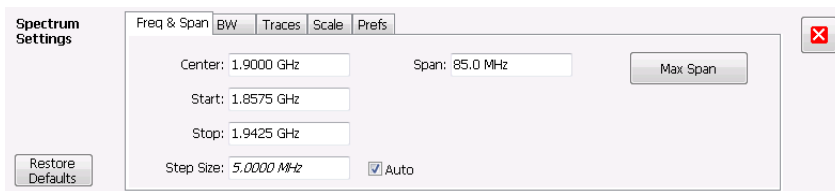

The control panel for the CCDF display is shown in the following figure.

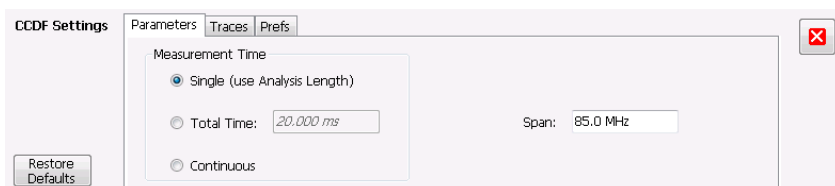

Settings Control Panels

[802.11ad Settings \(see page 232\)](#)

[Acquire \(see page 542\)](#)

[AM Settings \(see page 74\)](#)

[Amplitude vs Time Settings \(see page 54\)](#)

[Analysis Settings \(see page 525\)](#)

[Audio Spectrum Settings \(see page 444\)](#)

[Audio Summary Settings \(see page 446\)](#)

[Bluetooth 20dB BW settings](#)

[Bluetooth CF Offset and Drift Settings](#)

[Bluetooth Constellation Settings](#)

[Bluetooth Eye Diagram Settings](#)

[Bluetooth Frequency Dev Vs Time Settings](#)

[Bluetooth Summary Settings](#)

[Bluetooth Symbol Table Settings](#)

[CCDF Settings \(see page 138\)](#)

[Channel Power and ACPR Settings \(see page 100\)](#)

[Constellation Settings \(see page 459\)](#)

[EVM vs Time Settings \(see page 463\)](#)

[Eye Diagram Settings \(see page 466\)](#)

[FM Settings \(see page 81\)](#)

[Frequency Deviation vs Time Settings \(see page 468\)](#)

[Frequency vs Time Settings \(see page 56\)](#)

[LTE ACLR Settings \(see page 369\)](#)

[LTE Channel Spectrum Settings \(see page 371\)](#)

[LTE Constellation Settings \(see page 372\)](#)

[LTE Power vs Time Settings \(see page 375\)](#)

[Magnitude Error Settings \(see page 470\)](#)

[MCPR Settings \(see page 114\)](#)

[Occupied Bandwidth Settings \(see page 124\)](#)

[OFDM Channel Response Settings \(OFDM \(see page 247\)\) \(WLAN \(see page 114\)\)](#)

[OFDM Constellation Settings \(see page 249\)](#)

[OFDM EVM Settings \(see page 250\)](#)

[OFDM Magnitude Error Settings \(see page 252\)](#)

[OFDM Phase Error Settings \(see page 256\)](#)

[OFDM Power Settings \(see page 258\)](#)

[OFDM Summary Settings \(see page 260\)](#)

[OFDM Symbol Table Settings \(see page 262\)](#)

[Phase Error vs Time Settings \(see page 472\)](#)

[Phase vs Time Settings \(see page 58\)](#)

[PM Settings \(see page 89\)](#)

[Pulse Statistics Settings \(see page 289\)](#)

[Pulse Table Settings \(see page 284\)](#)

[Pulse Trace Settings \(see page 286\)](#)

[RF I Q vs Time Settings \(see page 60\)](#)

[Mask Test Limits Settings \(see page 519\)](#)

[Spectral Emissions Mask Settings \(see page 165\)](#)

[Settling Time Settings \(see page 153\)](#)

[Signal Quality Settings \(see page 477\)](#)

[Spectrogram Settings \(see page 49\)](#)

[Spectrum Settings \(see page 45\)](#)

[Spurious Settings \(see page 130\)](#)

[Symbol Table Settings \(see page 479\)](#)

[Time Overview Settings \(see page 39\)](#)

[Trellis Diagram Settings \(see page 481\)](#)

Accuracy

The closeness of the indicated value to the true value.

ACLR

Adjacent Channel Leakage power Ratio is the ratio of the RRC (Root Raised Cosine) filtered mean power centered on the assigned channel frequency to the RRC filtered mean power centered on an adjacent frequency (defined in 3GPP).

ACPR Measurement

Adjacent Channel Power Ratio (ACPR) is the ratio of the mean power centered on the assigned channel frequency to the mean power centered on an adjacent channel frequency. In the 3GPP specification, it is called ACLR (Adjacent Channel Level Ratio) and both the main channel and adjacent channels are required to be filtered with RRC (Root Raised Cosine) filters.

Acquisition

A series of time-contiguous frames. This is also called a Block.

Analysis Length

The length of time in the Analysis Time.

Analysis Time

The portion of the acquisition record over which one or more measurements are calculated.

ASK

Acronym for Amplitude Shift Keying. The process, or result of a process, in which the amplitude of the carrier is varied in accordance with the state of a digital input signal.

Block

An integer number of time-contiguous frames. See also: Acquisition.

Calibrator

A signal generator producing a specified output used for calibration purposes.

Carrier

The RF signal upon which modulation resides.

Carrier Frequency

The frequency of the CW component of the carrier signal.

Carrier Signal

The electrical signal, typically a sine wave, upon which modulation is impressed.

Carrier-to-Noise Ratio (C/N)

The ratio of carrier signal power to average noise power in a given bandwidth surrounding the carrier; usually expressed in decibels.

CCDF - Complimentary Cumulative Distribution Function

The Complementary Cumulative Distribution Function (CCDF) represents the probability that the peak power above average power of a measured signal exceeds a threshold.

CCDF is a plot of the percent of time that a signal's power value exceeds its average value versus the amount by which it exceeds the average. The CCDF plot has a log of probability on the Y-axis (100% at the top) and dB above average amplitude on the X-axis (0 at the left).

CDMA

Acronym for Code Division Multiple Access.

Center Frequency

The frequency corresponding to the center of a frequency span of the analyzer display.

Check Mark Indicator

The check mark indicator in the upper-left corner of the display indicates the display for which the acquisition hardware is optimized. When you have more than one display open, the display with the check mark indicator has control over the acquisition hardware. To give a display priority over any others, click its title bar.

When *Best for multiple windows* is selected in the Amplitude control panel's RF & IF Optimization control, none of the measurement displays shows a checkmark, as there is not a single optimized measurement.

CISPR

International special committee on radio interference. (Comité international spécial des perturbations radioélectriques)

CW

Acronym for Continuous Wave.

CW Signal

Continuous wave signal - a sine wave.

DANL

Acronym for Displayed Average Noise Level. See [Sensitivity \(see page 614\)](#).

dBfs

A unit to express power level in decibels referenced to full scale. Depending on the context, this is either the full scale of the display screen or the full scale of the analog-to-digital converter (ADC).

dBm

A unit of expressed power level in decibels referenced to 1 milliwatt.

dBmV

A unit to express voltage levels in decibels referenced to 1 millivolt.

dBuV

A unit to express voltage levels in decibels referenced to 1 microvolt.

Decibel

Ten times the logarithm of the ratio of one electrical power to another.

Detection

The process by which a long waveform is decimated (reduced) down to the desired number of trace points, by dividing the waveform into intervals and choosing a single value to represent each interval in the trace.

Display Reference Level

A designated vertical position representing a specified input level. The level may be expressed in dBm, volts, or any other units.

Distortion

Degradation of a signal, often a result of nonlinear operations, resulting in unwanted signal components. Harmonic and intermodulation distortion are common types.

Dynamic Range

The maximum ratio of the levels of two signals simultaneously present at the input which can be measured to a specified accuracy.

EVM

Acronym for Error Vector Magnitude.

Export

Save data to a file in a format other than application-native.

FastFrame

FastFrame segments the acquisition record into a series of frames and then captures acquisitions as single frames. You can then view and measure each frame individually.

FFT

Fast Fourier Transform - a mathematical process to calculate the frequency spectrum of a discrete number of time domain sample points.

Filter

A circuit that separates electrical signals or signal components based on their frequencies.

FM

Acronym for Frequency Modulation.

Frame

A series of time-contiguous samples, long enough in duration and at a sufficient sample rate to produce a spectrum view of a specified span and RBW.

Frequency

A series of time-contiguous samples, long enough in duration and at a sufficient sample rate to produce a spectrum view of a specified span and RBW.

Frequency Band

The continuous range of frequencies extending between two limiting frequencies, expressed in hertz.

Frequency Domain View

The representation of the power of the spectral components of a signal as a function frequency; the spectrum of the signal.

Frequency Drift

Gradual shift or change in displayed frequency over the specified time due to internal changes in the analyzer, where other conditions remain constant. Expressed in hertz per second.

Frequency Range

The range of frequencies over which the performance of the instrument is specified.

Frequency Span

A continuous range of frequencies extending between two frequency limits.

Frequency Settling Time

The time measured from a reference point to when the signal of interest settles to within user-defined tolerance.

GPIB

Acronym for General Purpose Interface Bus, the common name for the communications interface system defined in IEEE Std. 488.

Graticule

The calibrated grid overlaying the display screen of analyzers, oscilloscopes, and other test instruments.

Grayed Out

An on-screen control is “Grayed Out” if it is not adjustable.

I/Q

Acronym for In-phase / Quadrature.

IF

Acronym for Intermediate Frequency.

Import

Bring data into the application from a file of some format other than application-native.

Impulse Response

The Impulse Response trace display shows normalized power on the vertical axis and time on the horizontal axis.

Input Impedance

The impedance at the desired input terminal. Usually expressed in terms of VSWR, return loss, or other related terms for low impedance devices and resistance-capacitance parameters for high impedance devices.

LISN

Acronym for Line Impedance Stabilization Network.

Local Oscillator (LO)

An oscillator which produces the internal signal that is mixed with an incoming signal to produce the IF signal.

Marker

A visually identifiable point on a waveform trace, used to extract a readout of domain and range values represented by that point.

Max Hold

Digitally stored display mode which, at each frequency address, compares the incoming signal level to the stored level and retains the greater level. In this mode, the display indicates the peak level at each frequency after several successive acquisitions.

MCPR (Multiple Carrier Power Ratio)

The ratio of the signal power in the reference channel or group of channel to the power in adjacent channels.

Min Hold

Digitally stored display mode which, at each frequency address, compares the incoming signal level to the stored level and retains the lower level. In this mode, the display indicates the minimum level at each frequency after several successive sweeps.

Modulate

To regulate or vary a characteristic of a signal, typically in order to transmit information.

Modulating Signal

The signal which modulates a carrier. The signal which varies or regulates some characteristic of another signal.

Modulation

The process of varying some characteristic of a signal with a second signal.

Noise

Unwanted random disturbances superimposed on a signal which tend to obscure it.

Noise Bandwidth (NBW)

The exact bandwidth of a filter that is used to calculate the absolute power in dBm/Hz.

Noise Floor

The noise intrinsic to a system that represents the minimum limit at which input signals can be observed; ultimately limited by thermal noise (kTB). The analyzer noise floor appears as a “grassy” baseline in the display, even when no signal is present.

Open (Recall)

Bring data into the application from a file of application-native format.

OQPSK

Acronym for Offset QPSK (Quadrature Phase Shift Keying).

Phase Settling Time

The time measured from a reference point to when the signal of interest settles to within user-defined tolerance.

PM

Acronym for Phase Modulation.

Primary Marker

The marker displayed in the Single Marker mode whose frequency and/or position is changed when tuning with the general purpose knob.

PSK

Acronym for Phase Shift Keying. The process, or result of a process, in which the carrier phase is varied discretely in accordance with a digital code.

QAM

Acronym for Quadrature Amplitude Modulation. The process, or result of a process, in which the amplitude and phase of the carrier are varied concurrently by synthesizing two orthogonal ASK waves (see ASK).

Real-Time Analysis

Measurement technique based on triggering on an RF signal, seamlessly capturing it into memory, and analyzing it in the frequency, time, and modulation domains.

Real-Time Bandwidth

The frequency span over which real-time seamless capture can be performed, which is a function of the digitizer and the IF bandwidth of a Real-Time Signal Analyzer.

Real-Time Seamless Capture

The ability to acquire and store an uninterrupted series of time domain samples that represent the behavior of an RF signal over a long period of time.

Reference Level

The signal level represented by the uppermost graticule line of the analyzer display.

Residual FM (Incidental FM)

Short term displayed frequency instability or jitter due to instability in the analyzer local oscillators. Given in terms of peak-to-peak frequency deviation and expressed in hertz or percent of the displayed frequency.

Residual Response

A spurious response in the absence of an input signal. (Noise and zero pip are excluded.)

RBW

The RBW determines how well the analyzer can resolve or separate two or more closely spaced signal components.

Ripple

The Ripple measurement result is displayed in either Watts or Volts. The amplitude units selected on the Setup > Analysis > Units tab determine whether the measurement is presented in Watts or Volts. Volts are shown for linear units (for example, volts or amps); Watts are shown for non-linear units (for example, watts or dBm).

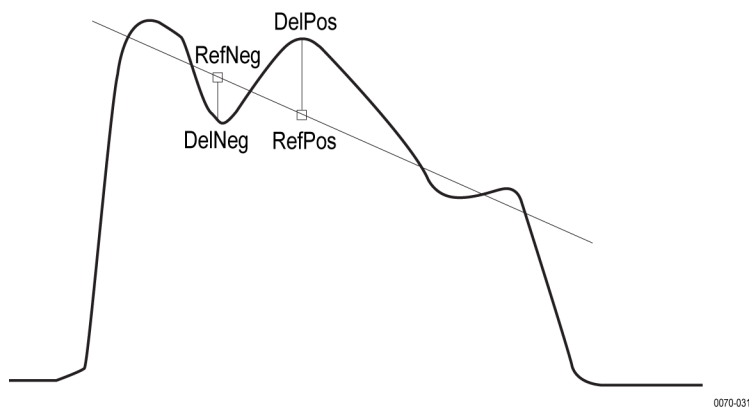

The Ripple measurement, in Watts, is calculated as follows:

$$\%Ripple (Watts) = 100 \times (RatioPos + RatioNeg)$$

Where:

$$RatioNeg = \left(\left(\left(\frac{DelNeg}{RefNeg} \right) + 1 \right)^2 \right) - 1$$

$$RatioPos = \left(\left(\left(\frac{DelPos}{RefPos} \right) + 1 \right)^2 \right) - 1$$

- DelPos = Delta Positive in Volts
- RefPos = Reference Positive in Volts
- DelNeg = Delta Negative in Volts (this is a positive value)
- RefNeg = Reference Negative in Volts

The Ripple measurement, in Volts, is calculated as follows:

$$\%Ripple (Volts) = 100 \times (RatioPosV + RatioNegV)$$

Where:

- RatioPosV = DelPos/RefPos
- RatioNegV = DelNeg/RefNeg

Secondary Marker

The “second” marker displayed only in the Delta Marker mode.

Sensitivity

Measure of a analyzer's ability to display minimum level signals, usually expressed as displayed average noise level ([DANL \(see page 604\)](#)).

Shape Factor (Skirt Selectivity)

The ratio of the frequency separation of the two (60 dB/3 dB) down points on the response curve to the static resolution bandwidth.

Signal

As used in this help, the signal refers to the input signal before it is processed. The signal is an input.

Span

Span is the range of frequencies displayed in a spectrum window. Span, start frequency and stop frequency are related by the following equation: $\text{Span} = (\text{stop frequency}) - (\text{start frequency})$. The settings for center, start and stop frequencies are related to the setting for span; when one parameter is changed, the others are changed automatically.

Span Per Division (Span/Div)

Frequency difference represented by each major horizontal division of the graticule.

Spectrogram

Frequency vs. time vs. amplitude display where the frequency is represented on the x-axis and time on the y-axis. The power level is indicated by variations in color.

Spectrum

The frequency domain representation of a signal showing the power distribution of its spectral component versus frequency.

Spectrum Analysis

The technique or process of determining the frequency content of an RF signal.

Spectrum Analyzer

A device for determining the frequency components of a signal.

Spectrum Time

Analysis Time for spectrum analysis views. Spectrum time can be the same as Analysis Time, but it can be different.

Spur/Spot

A spur is a signal peak that exceeds a user-definable threshold (See Spurious > Settings > Ranges) and excursion setting. A spur that also exceeds a limit (either Absolute or Relative) specified on the Settings > Limits tab is considered a violation. This is called a spot in the EMC-EMI display.

Spurious Response

A response to a analyzer wherein the displayed frequency is not related to the input frequency.

Time Measurement

This is the time in seconds relative to the time reference point in the first acquisition record in the data set.

Time Reference

The point in time during the acquisition record used as the zero point for counting time. The time reference can be set to either the start of the acquisition record or the trigger point.

Trace

As used in this help, trace refers to the displayed signal. The displayed signal can be a processed version of the input signal (for example, it may be averaged.) The trace is a result or output.

Vector Signal Analyzer

Like a spectrum analyzer, a device for determining the frequency components of a signal. However, unlike a standard spectrum analyzer, the vector signal analyzer is optimized for analyzing digitally modulated RF signals.

Vertical Scale Factor, Vertical Display Factor

The number of dB, volts, etc., represented by one vertical division of a spectrum analyzer display screen.

Violation

A violation is a spur that exceeds either an Absolute or Relative limit (depending on the selected mask) specified on the Settings > Limits tab. A spur is a signal peak that exceeds a user-definable threshold (See Spurious > Settings > Ranges) and excursion setting.

Index

Symbols and Numbers

- 6dB RBW (MIL) Filter shape
 - Spectrum display BW tab, 67
- 20 dB bandwidth
 - Bluetooth, 34
- 20dB Bandwidth display
 - Bluetooth, 423
- 3-D Spectrogram display, 47
- 3-D Waterfall
 - Spectrogram/DPXogram, 51
- 802.11ad/11ay Constellation display, 221
- 802.11ad/11ay displays, 220
- 802.11ad/11ay EVM vs Time display, 224
- 802.11ad/11ay measurements, 219
- 802.11ad/11ay Standards presets, 216
- 802.11ad/11ay Summary display, 229
- 802.11ad/11ay Symbol Table display, 227
- 802.11ay BW packet measurements, 216

A

- Abort acquisition, 541
- About the Vector Signal Analysis Software, 575
- Abs
 - Ranges and Limits table, 135
- Abs & Rel
 - Ranges and Limits table, 135
- Abs OR Rel
 - Ranges and Limits table, 135
- Abs Same
 - Ranges and Limits table, 135
- Abs Start (dBm)
 - Ranges and Limits table, 135
- Abs Stop (dBm)
 - Ranges and Limits table, 135
- Absolute Frequency, 36

- accuracy, 601
- ACLR, 601
 - LTE, 34
- ACLR measurement, 100
- ACPR measurement, 601
- Acq Data
 - Replay menu, 533
- Acq Data/DPX Spectra, 531
- Acquire control panel, 542
- acquisition, 601
- acquisition data
 - saving, 567
- Acquisition data files, 22
- Acquisition Info tab, 532
- acquisition memory usage, 545
- Actions tab
 - Search, 524
- adaptive equalizer, 489
- Adjacent Channel Power measurement, 100
- Adjacent Channel Power Ratio, 27
- Advanced Params tab
 - OFDM Analysis displays, 264
- Advanced Params Tab
 - GP Digital Modulation displays, 491
- Alaris
 - antenna function button, 560
- +AM, 32
 - AM display, 32
- AM
 - AM display, 32
- AM display, 73
- AM measurements, 32
- Amplitude control panel, 537
- Amplitude vs. Time display, 53
- Amplitude vs. Time display Settings, 54
- Analysis
 - 802.11ad/11ay, 219
- Analysis control panel, 525
- analysis length, 601
- Analysis Params tab
 - Bluetooth, 431
 - LTE, 390
 - P25 Analysis displays, 344
 - WLAN Analysis displays, 206
- Analysis tab
 - Pulse-Ogram display, 301
- analysis time, 601
- Analysis Time tab
 - Bluetooth, 432
 - GP Digital Modulation displays, 494
 - LTE, 390
 - OFDM Analysis displays, 265
 - Options control panel, 21
 - P25 Analysis displays, 344
 - WLAN Analysis displays, 209
- Analysis Time tab (Analysis control panel), 525
- Antenna, 555
 - Alaris function button, 560
 - control panel, 555
 - how to set up, 556
 - settings, 555
- APCO P25 measurements, 33
- Application Help, 575
- application presets
 - saving, 567
- Application presets, 13
- Apply ampl corrections, 295
- APSK parameters, 492
- arranging windows, 587
- ASK, 602
- Audio BW, 448
 - setting, 448
- audio filters
 - custom, 452
- Audio Filters tab
 - Audio Analysis displays, 450
- Audio Freq
 - Audio Summary display, 446

- Audio Spectrum display, 443
- Audio Spectrum settings, 444
- Audio Summary settings, 446
- Auto
 - Ranges and Limits table, 134
- automatically generate
 - filenames, 21
- Automatically increment
 - filename/number, 22
- Average Channel Power
 - measurement, 100
- Average ON Power, 34
- Average Transmitted Power, 271
- Averaging
 - Audio Analysis displays, 450
 - Params2 tab, 450

- B**
- Basic Controls Toolbar, 582
- black text
 - settling time
 - measurements, 148
- Blackman-Harris 4B Filter Shape
 - Spectrum display BW tab, 67
- Blizzard color scheme, 24
- block, 602
- Blue background (cells), 125
- Bluetooth
 - Analysis Params tab, 431
 - Analysis Time tab, 432
 - BT 20dB Bandwidth
 - display, 423
 - BT InBand Emission, 426
 - Freq & RBW tab, 441
 - Frequency Dev vs Time (BT)
 - display, 419
 - Limits tab, 433
 - Measurement Params
 - tab, 441
 - Parameters tab, 439
 - Power class, 430
 - Prefs tab, 437
 - Scale tab, 434
 - Trace tab, 435
- Bluetooth measurements, 33
- BT 20dB BW Settings, 425
- BT CF Offset and Drift
 - display, 409
 - settings, 372
- BT Constellation
 - display, 403
 - settings, 406
- BT Eye Diagram
 - display, 406
 - settings, 408
- BT limits, 411
- BT Summary
 - display, 411
 - settings, 415
- BT Symbol Table
 - display, 415
 - settings, 418
- Burst detect threshold, 90
- BW (Hz)
 - Ranges and Limits table, 134
- BW Tab
 - Amplitude vs. Time
 - display, 55
 - DPXOgram display, 67
 - Spectrum display, 67

- C**
- C4FM modulation type
 - measurements, 32
- C4FM signal quality
 - measurements, 477
- calibrator, 602
- Carr Freq Err
 - Audio Summary display, 446
- carrier, 602
- carrier frequency, 602
- Carrier frequency detection, 90
- Carrier Frequency Error, 32
- Carrier frequency offset and drift
 - Bluetooth, 33
- Carrier Power
 - Audio Summary display, 446
- carrier signal, 602
- carrier-to-noise ratio (C/N), 602
- CCDF, 27
- CCDF - Complimentary
 - Cumulative Distribution
 - Function, 603
- CCDF display, 137
- CDMA, 603
- Cell ID detection
 - LTE, 34
- center frequency, 603
- Channel
 - Acquire control panel, 5
 - Vertical tab, 543
- Channel direction, 565
- Channel Navigation toolbar, 564
- Channel Power, 27
 - LTE, 34
- Channel Power and ACPR
 - (Adjacent Channel Power
 - Ratio) display, 97
 - Settings control panel, 100
- Channel Power measure-
 - ment, 100
- Channel Response
 - OFDM, 28
 - WLAN, 29
- Channels
 - how to enable, 565
 - in signal database, 563
 - tune to, 564
- Channels tab
 - Channel Power & ACPR
 - display, 101
 - LTE Analysis displays, 376
 - Signal Strength display, 108
- Channels tab (MCPR), 119
- check mark indicator, 603
- Check mark indicator, 9
- CISPR, 603
- CISPR Filter shape
 - Spectrum display BW tab, 67
- Classic color scheme, 24
- configuring Presets, 15
- Constellation
 - 802.11ad, 29
 - OFDM, 28
 - WLAN, 29
- Constellation display, 458
 - displaying a second trace, 497
- Constellation display
 - settings, 459
- Continuous Acquisition
 - Mode, 584

- Convergence
 - Equalizer tab, 489
- Correct for Noise Floor
 - Channel Power & ACPR display, MCPR display, 117
 - Signal Strength display, 106
- correction tables, 537
- creating presets, 18
- Creating presets, 13
- Cumulative Histogram display
 - settings, 275
- Cumulative Statistics Table
 - display, 277
- Cumulative Statistics Table
 - settings, 280
- CW, 603
- CW signal, 604
- D**
- DANL, 604
- Data file formats, 570
- Data properties
 - File menu, 580
- Data Range tab
 - OFDM Analysis displays, 265
 - WLAN Analysis displays, 208
- Database
 - how to select channels, 563
 - how to set up signal types, 562
 - how to set up standards, 561
 - of signal standards, 561
- dBfs, 604
- dBm, 604
- dBmV, 604
- dBuV, 604
- De-emphasis
 - Audio Filters tab, 451
- decibel, 604
- Default
 - BT limits table, 411
 - P25 limits table, 331
- Define Markers, 514
- Define Peaks tab, 515
- Define tab, 519
 - Pulsed RF displays, 294
 - Settling Time displays, 154
- Delta Markers, 514
- Demod I&Q vs Time display
 - settings, 462
- detect
 - AM display, 77
 - FM display, 84
 - General Signal Viewing displays, 64
 - Time Overview, 41
- Detect
 - PM display, 92
- detection, 605
 - AM display, 77
 - FM display, 84
 - General Signal Viewing displays, 64
 - Time Overview, 41
- Detection
 - PM display, 92
- detector
 - AM display, 77
 - FM display, 84
 - General Signal Viewing displays, 64
 - Time Overview, 41
- Detector
 - PM display, 92
 - Ranges and Limits table, 135
- Deviation, 32
- Diff
 - Audio Summary display, 446
- Display
 - Pulse Statistics, 286
- display reference level, 605
- Displays
 - 802.11ad/11ay, 220
 - 802.11ad/11ay
 - Constellation, 221
 - 802.11ad/11ay EVM vs Time, 224
 - 802.11ad/11ay Summary, 229
 - 802.11ad/11ay Symbol Table, 227
 - arranging, 25
 - BT CF Offset and Drift, 409
- BT Constellation, 403
- BT Eye Diagram, 406
- BT Summary, 411
- BT Symbol Table, 415
- Cumulative Histogram, 273
- Cumulative Statistics
 - Table, 277
- Frequency Settling Time, 145
- interactions between, 25
- LTE ACLR, 366
- LTE Channel Spectrum, 369
- LTE Constellation, 373
- OFDM Channel
 - Response, 245
- OFDM Constellation, 248
- OFDM EVM, 249
- OFDM Mag Error, 253
- OFDM Phase Error, 256
- OFDM Power, 257
- OFDM Spectral Flatness, 251
- OFDM Summary, 259
- OFDM Symbol Table, 261
- P25 Constellation, 323
- P25 Eye Diagram, 326
- P25 Power, 328
- P25 Summary, 331
- P25 Symbol Table, 334
- Phase Settling Time, 145
- selecting, 25
- SEM (Spectrum Emission Mask), 161
- WLAN Channel
 - Response, 181
- WLAN Constellation, 184
- WLAN EVM, 186
- WLAN Mag Error, 188
- WLAN Phase Error, 191
- WLAN Power, 192
- WLAN Spectral Flatness, 195
- WLAN Summary, 197
- WLAN Symbol Table, 202
- distortion, 605
- documentation, 3
- Done
 - Ranges and Limits table, 135
- Downlink, 565
- DPX
 - presets, 13

- DPX Spectra/Acq Data, 531
 - Droop, 35
 - Droop dB, 35
 - Duty Factor (%) measurement, 271
 - Duty Factor (Ratio) measurement, 271
 - dynamic range, 605
- E**
- Elements of the display, 9
 - Enable EQ Export
 - Equalizer tab, 489
 - Enable Equalization
 - Equalizer tab, 489
 - Equalizer tab
 - GP Digital Modulation displays, 489
 - error message
 - Windows Event Viewer, 596
 - Error messages, 589
 - Event Viewer, 596
 - EVM, 605
 - 802.11ad, 29
 - OFDM, 28
 - WLAN, 29
 - EVM tab
 - WLAN Analysis displays, 213
 - EVM vs. Time display, 462
 - EVM vs. Time Settings, 463
 - Excrrsn (dB)
 - Ranges and Limits table, 135
 - Expand
 - Ranges and Limits Tab, 134
 - export, 605
 - External Gain value, 537
 - External Gain/Loss Correction tab, 537
 - External Loss Tables, 537
 - Eye Diagram display settings, 466
- F**
- Fall Time, 35
 - FastFrame, 605
 - FFT, 606
 - File formats, 570
 - File Menu, 577
 - File types, 570
 - filter, 606
 - Filter Parameter
 - GP Digital Modulation displays, 483
 - Filter Shape
 - Ranges and Limits table, 134
 - Spectrum display BW tab, 67
 - Find tab
 - GP Digital Modulation displays, 494
 - finding bursts in data
 - GP Digital Modulation displays, 494
 - Flatness
 - OFDM, 28
 - WLAN, 29
 - FlatTop (CW ampl) Filter Shape
 - Spectrum display BW tab, 67
 - FM, 606
 - FM display, 79
 - FM measurements, 32
 - frame, 606
 - Freq & BW tab
 - RF I & Q vs Time display, 61
 - Freq & BW Tab
 - GP Digital Modulation displays, 487
 - Freq & RBW tab
 - Bluetooth, 441
 - Freq & Span tab
 - General Signal Viewing displays, 63
 - Freq and RBW tab
 - LTE, 387
 - Freq Deviation, 32
 - Freq Diff, Phase Diff, Freq Abs settings, 296
 - Freq Error, 32
 - Freq Estimation tab
 - Pulsed RF displays, 300
 - Freq, Span & RBW tab
 - Channel Power & ACPR display, MCPR display, 116
 - RF Measurements displays, 173
 - Signal Strength display, 106
 - Freq-domain Linearity
 - setting, 294
 - frequency, 606
 - frequency band, 606
 - Frequency Dev vs Time (BT) display
 - Bluetooth, 419
 - Frequency Dev vs Time (P25) display, 337
 - Frequency Dev vs. Time (BT) Settings, 423
 - Frequency Dev vs. Time (P25) Settings, 339
 - Frequency deviation
 - P25, 33
 - Frequency Deviation vs. Time settings, 468
 - frequency domain view, 606
 - frequency drift, 607
 - Frequency Error, 30
 - GP Digital Modulation displays, 487
 - Frequency Offset
 - GP Digital Modulation displays, 487
 - frequency range, 607
 - Frequency range
 - Bluetooth, 34
 - frequency settling time, 607
 - measuring, 150
 - Frequency Settling Time display, 145
 - Frequency Settling Time settings, 153
 - frequency span, 607
 - Frequency tab, 527
 - Frequency vs. Time display, 55
 - Frequency vs. Time Settings, 56
 - Front panel controls, 5
 - Full Screen, 582
- G**
- Gain Imbalance, 475
 - GNSS, 553
 - control panel, 553
 - how to set up, 554
 - Simulation, 554

- GPIB, 607
- GPIB tab, 21
- GPS
 - time stamp, 550
- graticule, 607
- Graticule On/Off
 - RF Measurements displays, 178
 - Signal Strength display, 110
- grayed out, 607

- H**
- Hanning Filter Shape
 - Spectrum display BW tab, 67
- HCPM transmitter logical channel
 - time alignment P25, 33
- Help Menu, 587
- Hide sensitive readouts, 21
- Hide Sensitive readouts, 22
- Histogram readout
 - Pulsed RF displays, 306
- HPF
 - Audio Filters tab, 451
- Hum & Noise
 - Audio Summary display, 455

- I**
- I/Q, 608
- IF, 608
- Ignore Region
 - Params2 tab, 450
- import, 608
- Impulse Response Amplitude, 36
- Impulse Response setting, 295
- Impulse Response Time, 272
- In-band emission / ACPR
 - Bluetooth, 34
- InBand Emission
 - Bluetooth, 426
- Information messages, 589
- input
 - selecting, 5
- input impedance, 608
- Installed options, 3
- Internal attenuator (Internal Settings tab), 537
- IQ Origin Offset, 475
- IQ Sampling Parameters Tab, 544
- IQ vs. time view, 59
- IRIG-B, 551
 - time stamp, 550
- is greater than (Test), 520
- is greater than mask, 519
- is inside mask, 519
- is inside mask (Test), 521
- is less than (Test), 520
- is less than mask, 519
- is outside mask, 519
- is outside mask (Test), 521

- K**
- Kaiser (RBW) Filter Shape
 - Spectrum display BW tab, 67
- Keep-out time, 295
- Keypad, 581

- L**
- Length, 32
 - Equalizer tab, 489
- Levels tab
 - Pulsed RF displays, 299
- Limit lines, 519
- Limits
 - BT default, 411
 - P25 default, 331
 - Spurious display, 136
- Limits tab
 - Bluetooth, 433
 - P25 Analysis displays, 351
- Link to Span, 61
- LISN, 608
- Load
 - Ranges and Limits Tab, 134
 - Ranges and Limits table, 135
- local oscillator (LO), 608
- Lock Center Frequency of
 - Spectrum displays, 527
- Lock Center Frequency of
 - Spectrum displays to Measurement Frequency Frequency tab, 528
- Log
 - Audio Spectrum display, 454
- Log (Horizontal)
 - Spectrum display, 46
- Loop over all selected records
 - Replay menu, 533
- LPF
 - Audio Filters tab, 451
- LTE
 - Analysis Params tab, 390
 - Analysis Time tab, 390
 - Channels tab, 376
 - Freq and RBW tab, 387
 - Measurement Params tab, 388
 - Modulation Params tab, 389
 - Offsets and Limits Table tab, 381
 - Parameters tab, 378
 - Prefs tab, 384
 - Processing tab, 380
 - Scale tab, 382
 - Trace tab, 392
 - VBW (Channels tab), 377
 - VBW (Freq & RBW tab), 387
- LTE ACLR
 - display, 366
 - settings, 369
- LTE Channel Spectrum
 - display, 369
 - settings, 371
- LTE Constellation
 - display, 371
- LTE measurements, 34

- M**
- Mag Error, 476
 - OFDM, 28
 - WLAN, 29
- Magnitude Error vs. Time
 - display, 468
- Magnitude Error vs. Time
 - settings, 470
- Main
 - presets, 13
- manuals, 3
- Map It, 553
- marker, 609
- Marker noise mode, 516
- Marker noise mode (dBc/Hz), 514

- Marker Properties tab, 514
 - Marker to Center Frequency, 513
 - Markers, 515
 - in the BT Symbol Table, 418
 - Marker Toolbar, 515
 - Using Markers, 509
 - Using Markers in Noise Mode, 516
 - Markers menu, 585
 - Markers snap to peaks when dragged, 24
 - Markers Toolbar, 582
 - Mask
 - Ranges and Limits table, 135
 - Mask Editor, 519
 - Mask tab
 - Settling Time displays, 157
 - Mask Test, 519
 - is greater than mask, 519
 - is inside mask, 519
 - is less than mask, 519
 - is outside mask, 519
 - mask testing
 - settling time measurement, 141
 - MAT data files, 22
 - MAT files
 - supported versions, 569
 - MATLAB
 - chose a data type, 23
 - MATLAB file format, 570
 - MATLAB Level 5 (v6), 23
 - MATLAB Level 7.3 (v7.3), 23
 - Max Freq Error, 272
 - max hold, 609
 - Max number of pulses
 - Pulse Table display, 292
 - Max Number of Pulses
 - Params tab, 293
 - Max Phase Error, 36
 - Max trace points, 59
 - Settling Time displays, 161
 - MCPR (multiple carrier power ratio), 609
 - MCPR display, 110
 - MCPR settings, 114
 - Meas BW
 - Frequency Settling Time, 154
 - Meas Frequency
 - Frequency Settling Time, 154
 - Measurement BW, no filter, 61
 - Measurement Filter
 - GP Digital Modulation displays, 483
 - Params tab, 292
 - Measurement Frequency, 527
 - Frequency tab, 528
 - Measurement Length
 - Time Params tab, 156
 - Measurement Params tab
 - Bluetooth, 441
 - Channel Power & ACPR display, MCPR display, 117
 - LTE, 388
 - Signal Strength display, 106
 - Measurement point, 296
 - Measurement settings export, 567
 - Measurements, 27
 - 802.11ad/11ay, 219
 - APCO P25, 33
 - Bluetooth, 33
 - LTE, 34
 - Measurements tab, 291
 - measuring settling time, 150
 - Menus, 576
 - MER (RMS), 30
 - min hold, 609
 - Min Settled Duration
 - Time Params tab, 156
 - Minimum off time between pulses
 - Params tab, 293
 - Mod Distor
 - Audio Summary display, 446
 - Mode
 - Equalizer tab, 489
 - modulate, 609
 - modulating signal, 609
 - modulation, 610
 - Modulation characteristics
 - Bluetooth, 33
 - Modulation fidelity
 - P25, 33
 - modulation measurements, 457
 - Modulation measurements, 30
 - Modulation Params tab
 - GP Digital Modulation displays, 483
 - LTE, 389
 - OFDM Analysis displays, 263
 - P25 Analysis displays, 429
 - WLAN Analysis displays, 205
 - Modulation types supported, 483
 - moving windows, 587
 - Multi-Carrier Power Ratio, 27
 - Multiple Carrier Power Ratio, 114
- ## N
- Navigator View, 581
 - nFSK modulation type
 - measurements, 32
 - nFSK signal quality
 - measurements, 476
 - No. of Harmonics
 - Params2 tab, 450
 - No. of Non-Harmonics
 - Params2 tab, 450
 - noise, 610
 - noise bandwidth (NBW), 610
 - noise floor, 610
 - Noise markers, 516
 - Non-Harmonic Excursion
 - Params2 tab, 450
 - Non-Harmonic Threshold
 - Params2 tab, 450
 - Null IQ Offset, 544
 - Numeric keypad, 581
- ## O
- OBW Level Left/Right, 121
 - OBW Ref Power, 121
 - Occupied bandwidth
 - LTE, 34
 - Occupied Bandwidth, 124
 - Occupied Bandwidth
 - settings, 124
 - Occupied BW display, 121
 - OFDM Channel Response
 - display, 245
 - settings, 247

- OFDM Constellation
 - display, 248
 - settings, 249
 - OFDM EVM
 - display, 249
 - settings, 250
 - OFDM Mag Error
 - display, 253
 - settings, 254
 - OFDM Phase Error
 - display, 256
 - OFDM Power
 - display, 257
 - settings, 258
 - OFDM Spectral Flatness
 - display, 251
 - settings, 252
 - OFDM Summary
 - display, 259
 - settings, 260
 - OFDM Symbol Table
 - display, 261
 - settings, 262
 - Off
 - Ranges and Limits table, 135
 - Offset & Limits Table tab
 - SEM display, 168
 - Offset EVM, 476
 - offset frequency
 - IQ signal types, 544
 - Offsets and Limits Table tab
 - LTE, 381
 - On
 - Ranges and Limits table, 134
 - open (recall), 610
 - Operating band unwanted emission
 - LTE, 34
 - Operating frequency accuracy
 - P25, 33
 - Optimization
 - Channel Power & ACPR
 - display, MCPR
 - display, 117
 - Signal Strength display, 106
 - Options
 - installed, 3
 - Options control panel, 21
 - OQPSK, 610
 - OQPSK and SOQPSK modulation
 - type measurements, 31
 - Other acquisition/horizontal settings
 - Scope Settings tab, 546
 - Out-of-band spurious emission
 - Bluetooth, 34
 - Output power
 - Bluetooth, 34
 - Overlap, 49
 - Overshoot, 272
 - dB, 272
 - Overshoot dB, 272
 - Overshoot settings, 297
- P**
- P25
 - presets, 18
 - P25 Constellation
 - display, 323
 - settings, 325
 - P25 Eye Diagram
 - display, 326
 - settings, 327
 - P25 limits, 331
 - P25 measurements, 33
 - P25 Power vs Time
 - display, 328
 - settings, 330
 - P25 Summary
 - display, 331
 - settings, 334
 - P25 Symbol Table
 - display, 334
 - settings, 336
 - Parameters tab
 - AM display, 75
 - Bluetooth, 439
 - CCDF display, 140
 - FM display, 83
 - LTE, 378
 - Occupied BW display, 125
 - PM display, 90
 - SEM display, 166
 - Spurious display, 131
 - Params tab
 - Pulsed RF displays, 292
 - Params1 tab
 - Audio Analysis displays, 447
 - Params2 tab
 - Audio Analysis displays, 450
 - Pass /Fail readout
 - SEM display, 163
 - Pass/Fail Limit Testing
 - Spurious display, 136
 - Pass/Fail tests, 520
 - Pause
 - Replay menu, 533
 - +Peak
 - Audio Summary display, 446
 - Peak
 - Audio Summary display, 446
 - Peak Excursion, 514
 - Peak FSK err, 32
 - Peak Mag Err, 32
 - Peak Power, 34
 - Peak Threshold, 514
 - Peak/Avg Ratio, 27
 - Peak-Peak/2
 - Audio Summary display, 446
 - Phase Deviation, 272
 - Phase Difference, 272
 - Phase Error, 30
 - OFDM, 28
 - WLAN, 29
 - Phase Error vs. Time display, 470
 - Phase Error vs. Time settings, 472
 - phase settling time, 610
 - measuring, 150
 - Phase Settling Time display, 145
 - Phase Settling Time settings, 153
 - Phase vs. Time display, 57
 - Phase vs. Time settings, 58
 - pictures
 - saving, 567
 - +Pk
 - FM display, 32
 - PM display, 33
 - Pk
 - FM display, 32
 - PM display, 33
 - Pk-Pk
 - FM display, 32
 - PM display, 33

- Pk-Pk/2
 - FM display, 32
 - PM, 611
 - PM measurements, 33
 - Power
 - OFDM, 28
 - Power class
 - Bluetooth, 430
 - Power density
 - Bluetooth, 34
 - Power Markers, 514
 - power measurements, 97
 - Power measurements, 27
 - Power Threshold to Detect Pulses
 - Params tab, 292
 - Power vs Time
 - WLAN, 29
 - PPS, 551
 - time stamp, 550
 - Pre-defined Filters
 - Audio Filters tab, 451
 - Prefs tab
 - AM display, 79
 - Bluetooth, 437
 - FM display, 87
 - General Signal Viewing Displays, 70
 - GP Digital Modulation displays, 498
 - LTE, 384
 - OFDM Analysis displays, 269
 - Options control panel, 23
 - P25 Analysis displays, 350
 - PM display, 95
 - Pulsed RF displays, 306
 - RF Measurements displays, 178
 - Settling Time displays, 161
 - Signal Strength display, 110
 - WLAN Analysis displays, 214
 - Preset (File menu), 586
 - presets, 18
 - Presets, 567
 - 802.11ad/11ay, 216
 - Application, 13
 - configuring User, 15
 - DPX, 13
 - Main, 13
 - P25, 18
 - recalling, 14
 - Standards, 18
 - User, 13
 - WLAN, 18
 - Presets tab
 - Options control panel, 21
 - primary marker, 611
 - Print, 581
 - Print Preview, 581
 - Processing tab
 - LTE, 380
 - SEM display, 167
 - PSK, 611
 - Pulse measurements, 271
 - Pulse Statistics display, 286
 - Pulse Statistics display settings, 289
 - Pulse Table display, 282
 - Pulse Table display settings, 284
 - Pulse Trace display, 284
 - Pulse Trace display settings, 286
 - Pulse Width, 271
 - Pulse-Ogram settings, 282
 - Pulse-Pulse Frequency Difference, 36
 - Pulse-Pulse Phase Difference, 273
 - Pulse-ref Freq Difference, 272
 - Pulse-ref Phase Difference, 35
 - pulses
 - how many can be analyzed, 293
- Q**
- QAM, 611
 - Quadrature Error, 475
- R**
- Range file, 570
 - Ranges and Limits Tab
 - Spurious display, 133
 - RBW, 612
 - Channel Power & ACPR display, MCPR display, 116
 - Signal Strength display, 106
 - real-time analysis, 611
 - real-time bandwidth, 611
 - real-time seamless capture, 612
 - recalling Presets, 14
 - recalling waveform files, 568
 - Red background (cells), 125
 - red text
 - settling time measurements, 148
 - Ref
 - Audio Summary display, 446
 - Ref Channel tab
 - SEM display, 168
 - Ref Level
 - Vertical tab, 543
 - Ref level (Internal Settings tab), 537
 - Reference Filter
 - GP Digital Modulation displays, 483
 - reference level, 612
 - Reference tab
 - Spurious display, 131
 - Rel
 - Ranges and Limits table, 135
 - Rel Same
 - Ranges and Limits table, 135
 - Rel Start (dB)
 - Ranges and Limits table, 135
 - Rel Stop (dB)
 - Ranges and Limits table, 135
 - Relative power
 - Bluetooth, 34
 - Repeat, 541
 - Repetition Interval, 35
 - Repetition Rate, 271
 - Replay all selected records
 - Replay menu, 533
 - Replay control panel, 531
 - Replay current record
 - Replay menu, 533
 - Replay from selected
 - Replay menu, 533

- Replay menu, 533
 - Replay Speed tab, 532
 - Replay toolbar, 535
 - Replay menu, 533
 - Reset all scope settings to default values
 - Scope Settings tab, 546
 - Reset Equalization
 - Equalizer tab, 489
 - Reset layout
 - Ranges and Limits Tab, 134
 - residual FM (incidental FM), 612
 - residual response, 612
 - results
 - saving, 567
 - Resume, 541
 - Return loss measurements, 28
 - RF Channel Power
 - measurement, 99
 - RF I & Q vs. Time display, 59
 - RF I & Q vs. Time settings, 60
 - RF output power
 - P25, 33
 - Rho, 30
 - Ripple, 272
 - Ripple dB, 272
 - ripple measurement
 - calculation, 612
 - Ripple settings, 297
 - Rise Time, 271
 - RMS
 - Audio Summary display, 446
 - FM display, 32
 - PM display, 33
 - RMS Error Magnitude, 32
 - RMS Freq Error, 272
 - RMS FSK Err, 32
 - RMS Mag Err, 32
 - RMS Phase Error, 35
 - Run, 541
 - Run menu, 584
- S**
- S/N
 - Audio Summary display, 446
 - Sample Rate
 - Scope Settings tab, 546
 - Save
 - Ranges and Limits Tab, 134
 - Save and Export tab, 21
 - Options control panel, 22
 - Save As
 - Ranges and Limits table, 135
 - saved file types, 567
 - saving
 - acquisition data, 567
 - pictures, 567
 - presets, 18
 - results, 567
 - setups, 567
 - Saving
 - presets, 13
 - Saving and Recalling Data, 567
 - Scale tab
 - AM display, 78
 - Audio Analysis displays, 453
 - Bluetooth, 434
 - CCDF display, 139
 - FM display, 86
 - General Signal Viewing displays, 69
 - GP Digital Modulation displays, 498
 - LTE, 382
 - OFDM Analysis displays, 267
 - P25 Analysis displays, 347
 - PM display, 94
 - Pulsed RF displays, 304
 - RF Measurements displays, 177
 - SEM display, 171
 - Settling Time displays, 160
 - Signal Strength display, 109
 - Spectrogram display, 51
 - Spectrum display, 46
 - WLAN Analysis displays, 211
 - Scope Data tab, 580
 - Scope Settings tab, 546
 - Search control panel, 524
 - Search In, 520
 - secondary marker, 613
 - Security tab, 21
 - Options control panel, 22
 - Select all
 - Replay menu, 533
 - Select data records tab, 531
 - Select records from history
 - Replay menu, 533
 - selecting the input, 5
 - SEM display, 161
 - sensitivity, 614
 - Set to max BW, 61
 - Settings, 598
 - AM display, 74
 - Audio Spectrum display, 444
 - Audio Summary display, 446
 - BT 20dB BW, 425
 - BT CF Offset and Drift, 410
 - BT Constellation, 406
 - BT Eye Diagram, 408
 - BT Frequency Dev vs. Time, 423
 - BT Summary, 415
 - BT Symbol Table, 418
 - CCDF display, 138
 - Constellation display, 459
 - Cumulative Histogram display, 275
 - Cumulative Statistics Table display, 280
 - Demod I&Q vs Time display, 462
 - EVM vs. Time display, 463
 - Eye Diagram display, 466
 - FM display, 81
 - Frequency Deviation vs. Time, 468
 - Frequency Settling Time, 153
 - Frequency vs. Time, 56
 - LTE ACLR, 369
 - LTE Channel Spectrum, 371
 - Magnitude Error vs. Time, 470
 - MCPR, 114
 - Occupied Bandwidth, 124
 - OFDM Channel Response, 245
 - OFDM Constellation, 249
 - OFDM EVM, 250
 - OFDM Flatness, 252
 - OFDM Mag Error, 254

- OFDM Phase Error, 256
- OFDM Power, 258
- OFDM Summary, 260
- OFDM Symbol Table, 262
- Options control panel, 21
- P25 Constellation, 325
- P25 Eye Diagram, 327
- P25 Frequency Dev vs. Time, 339
- P25 Power vs Time, 330
- P25 Summary, 334
- P25 Symbol Table, 336
- Phase Error vs. Time, 472
- Phase Settling Time, 149
- Phase vs. Time, 58
- Pulse Statistics display, 289
- Pulse Table display, 284
- Pulse Trace display, 286
- Pulse-Ogram display, 282
- RF I & Q vs. Time, 60
- Signal Quality, 477
- Spectrogram display, 49
- Spectrum display, 45
- Spectrum Emission
 - Mask, 165
- Spurious display, 130
- Symbol Table display, 479
- Time Overview display, 39
- Trellis Diagram display, 481
- WLAN Channel
 - Response, 181
- WLAN Constellation, 185
- WLAN EVM, 187
- WLAN Mag Error, 189
- WLAN Phase Error, 191
- WLAN Power vs Time, 194
- WLAN Spectral Flatness, 196
- WLAN Summary, 201
- WLAN Symbol Table, 204
- Settled Frequency
 - definition, 141
- Settled Phase
 - definition, 141
- settling time
 - measuring, 150
- Settling Time, 141
 - definition, 141
- Settling Time decimal places
 - Settling Time displays, 161
- settling time measurement
 - text color, 148
- Setup Menu, 585
- setups
 - saving, 567
- shape factor (skirt selectivity), 614
- Show graticule
 - General Signal Viewing
 - Displays, 70
 - Pulsed RF displays, 306
 - Settling Time displays, 161
- Show Marker Readout in Graph
 - General Signal Viewing
 - Displays, 70
 - Pulsed RF displays, 306
 - RF Measurements
 - displays, 178
 - Settling Time displays, 161
 - Signal Strength display, 110
- Show recalled trace, 63
 - AM display, 76
 - FM display, 84
 - PM display, 91
 - Time Overview display, 41
- signal, 614
- Signal database, 561
- Signal Input, 543
- Signal Power
 - Audio Summary display, 446
- Signal Quality display, 472
- Signal quality measurements, 475
- Signal Quality settings, 477
- Signal standards, 561
- Signal Strength, 27
- Signal Strength display, 103
- Signal Strength Settings control
 - panel, 104
- Signal types, 561
- Simulation
 - GNSS, 554
- SINAD
 - Audio Summary display, 446
- Single, 584
- sluggish operation, 597
- span, 614
- span per division, 614
- Span/RBW Ratio
 - Spectrum display BW tab, 67
- spectrogram, 614
- Spectrogram display, 47
- Spectrogram display settings, 49
- spectrum, 615
- spectrum analysis, 615
- spectrum analyzer, 615
- Spectrum Center Frequency, 527
 - Frequency tab, 528
- Spectrum display, 43
- Spectrum display settings, 45
- Spectrum Emission Mask
 - display, 161
 - settings, 165
- Spectrum Monitor
 - Spectrogram, 52
- spectrum time, 615
- Spectrum Time tab, 527
- Spectrums/line, 49
- spot, 615
- spur, 615
- Spur
 - defining, 136
- Spurious, 125
- Spurious display settings, 130
- spurious response, 615
- Standard
 - Audio Filters tab, 451
- Standard Settings button, 482
- Standards
 - 802.11ad/11ay, 216
 - database, 561
 - how to set up database, 561
 - presets, 13
- Standards presets
 - P25, 18
 - WLAN, 18
- Start (Hz)
 - Ranges and Limits table, 134
- Status bar, 582
- Status Bar, 583
- Stop
 - Replay menu, 533
- Stop (Hz)
 - Ranges and Limits table, 134

- Summary
 - 802.11ad, 29
 - WLAN, 29
 - symbol maps, 499
 - Symbol Rate, 32
 - Symbol rate accuracy
 - P25, 33
 - Symbol Rate Error, 32
 - Symbol Table
 - 802.11ad, 29
 - WLAN, 29
 - Symbol Table display, 478
 - Symbol Table display
 - settings, 479
 - Sync Scope C1/C2 to Active Marker, 513
- T**
- Taps
 - Equalizer tab, 489
 - Taps/Symbol
 - Equalizer tab, 489
 - Target Reference
 - Frequency Settling Time, 155
 - Test For, 520
 - Test Patterns tab
 - P25 Analysis displays, 346
 - Test using a mask, 521
 - THD
 - Audio Summary display, 446
 - Threshld (dBm)
 - Ranges and Limits table, 135
 - Thunderstorm color scheme, 24
 - Time, 272
 - Time & Freq Scale tab
 - Spectrogram display, 51
 - time measurement, 615
 - Time Overview, 37
 - Time Overview display
 - settings, 39
 - Time Params tab
 - Settling Time displays, 156
 - time reference, 616
 - time scale status readout, 49
 - Time stamp, 550
 - GPS, PPS, IRIG-B, 550
 - TIQ acquisition data files, 22
 - TIQ acquisition data files
 - parameters, 22
 - TNHD
 - Audio Summary display, 446
 - TOFF
 - LTE, 34
 - Tolerance (+/-)
 - Frequency Settling Time, 155
 - Tools Menu, 586
 - Total AM
 - AM display, 32
 - Touch Screen Off, 5
 - Touch-screen Actions, 5
 - trace, 616
 - Trace 2
 - Constellation display, 497
 - Trace tab
 - AM display, 76
 - Bluetooth, 435
 - FM display, 84
 - GP Digital Modulation displays, 496
 - LTE, 392
 - OFDM Analysis displays, 267
 - P25 Analysis, 347
 - PM display, 91
 - Settling Time displays, 157
 - Time Overview display, 41
 - WLAN Analysis displays, 210
 - Traces tab
 - General Signal Viewing displays, 63
 - Pulse-Ogram display, 303
 - RF Measurements display, 174
 - Spectrogram display, 50
 - WLAN Channel Response display, 210
 - Traces tab - Math Trace
 - General Signal Viewing displays, 67
 - Traces Toolbar, 582
 - Transfer Again
 - Scope Data tab, 547
 - Transform Window
 - Spectrum display BW tab, 67
 - Transmitter frequency behavior
 - P25, 33
 - Transmitter power and encoder
 - attack time
 - P25, 33
 - Transmitter power and encoder
 - attack time with busy/idle
 - P25, 33
 - Transmitter throughput delay
 - P25, 33
 - Trellis Diagram display
 - settings, 481
 - Trig Meas tab
 - P25 Analysis displays, 349
 - Tune to a channel, 564
 - Tutorials
 - YouTube videos, 3
 - Types
 - how to set up signal database, 562
- U**
- Uniform (None) Filter Shape
 - Spectrum display BW tab, 67
 - Units tab, 530
 - Unwanted emissions (ACPR)
 - P25, 33
 - Uplink, 565
 - User Filters
 - file format, 505
 - loading, 504
 - User presets, 18
 - User Symbol Map, 492
- V**
- VBW, 121
 - LTE, 377
 - RF Measurements displays, 173
 - Spectrum display BW tab, 67
 - VBW (Hz)
 - Ranges and Limits table, 135
 - VBW On
 - Ranges and Limits table, 135
 - vector signal analyzer, 616
 - vertical scale factor, vertical display factor, 616

Vertical settings
 Scope Settings tab, 546
Vertical tab
 Acquire control panel, 543
Video tutorials, 3
View
 Basic Controls Toolbar, 582
 Full Screen, 581
 Markers Toolbar, 582
 Navigator View, 581
 Numeric keypad, 581
 Replay Toolbar, 582
 Status Bar, 582
 Traces Toolbar, 582
View Menu, 581
violation, 616

W
Waterfall
 Spectrogram/DPXogram, 51
Window menu, 587

Windows Event Viewer, 596
WLAN
 presets, 18
 video tutorials, 3
WLAN Channel Response
 display, 181
 settings, 183
WLAN Constellation
 display, 184
 settings, 185
WLAN EVM
 display, 186
 settings, 187
WLAN Mag Error
 display, 188
 settings, 189
WLAN Phase Error
 display, 191
WLAN Power vs Time
 display, 192
 settings, 194

WLAN Spectral Flatness
 display, 195
 settings, 196
WLAN Summary
 display, 197
 settings, 201
WLAN Symbol Table
 display, 202
 settings, 204

X

x dB BW Ref Power, 121
x dB Level, 125

Y

YouTube
 Tektronix channel, 3