

DDR Analysis Online Help



**DDR Analysis
Online Help**

Copyright © Tektronix. All rights reserved. Licensed software products are owned by Tektronix or its subsidiaries or suppliers, and are protected by national copyright laws and international treaty provisions.

Tektronix products are covered by U.S. and foreign patents, issued and pending. Information in this publication supersedes that in all previously published material. Specifications and price change privileges reserved.

TEKTRONIX and TEK are registered trademarks of Tektronix, Inc.

DDR Analysis Online Help Part Number, 076-0178-08, November 16, 2013.

Contacting Tektronix

Tektronix, Inc.
14150 SW Karl Braun Drive
P.O. Box 500
Beaverton, OR 97077
USA

For product information, sales, service, and technical support:

- In North America, call 1-800-833-9200.
- Worldwide, visit www.tektronix.com to find contacts in your area.

Table of Contents

General safety summary	xi
Introduction to the Application	
Welcome	1
Related Documentation	3
Conventions	4
Technical Support	4
Customer Feedback	5
Getting Started	
Product Description	7
DDRA Prerequisites	7
Requirements and Restrictions	7
Supported Probes	8
Installing the Application	9
About DDRA	10
Operating Basics	
About Basic Operations	
Starting the Application	11
Menu Controls	11
Virtual Keypad	12
Tips on the DDRA User Interface	12
Basic Oscilloscope Functions	
Application Directories	13
File Name Extensions	13
Returning to the Application	13
Control Panel	14
Saving and Recalling Setups	
Saving a Setup	15
Recalling a Saved Setup	15
Recalling the Default Setup	16
Limits	16
Search and Mark	17
Dynamic Limits	18
Setting up DDR for Analysis	
DDR Standards and their Measurements	19
Derating	27
About DDR Analysis	30

Step1: Generation, Rate and Levels	31
Step2: Interposer Filter.....	34
Step3: Measurements and Sources	35
Step4: Burst Detection Method	40
Step5: Burst Detection Settings.....	40
DQ/DQS Phase Alignment	41
Chip Select, Latency + DQ/DQS Phase Alignment.....	43
Logic State + Burst Latency	44
Visual Search.....	47
Step6: Thresholds and Scaling	51
Measurement Levels.....	55
Hints.....	56
Results as Statistics	57
Plots	58
Reports	58
Switching between the DDRA and DPOJET Applications	59
Salient Features of MSO-DDRA Integration	60

Tutorial

Introduction to the Tutorial	61
Setting Up the Oscilloscope	61
Starting the Application.....	61
Waveform Files	61
Recalling a Waveform File	62
Taking a Measurement	62

Parameters

About Parameters.....	67
Step1: Generation, Rate and Levels Parameters	68
Step2: Interposer Filter Parameters.....	69
Step3: Measurement and Sources Parameters.....	70
Step4: Burst Detection Method Parameters	71
Step5: Burst Detection Settings Parameters	71
Step6: Thresholds and Scaling Parameters	73

References

LPDDR Measurement Sources.....	75
LPDDR2 Measurement Sources	77
LPDDR3 Measurement Sources	82
DDR Measurement Sources	86
DDR2 Measurement Sources	89
DDR3 Measurement Sources	93

DDR3L Measurement Sources	97
DDR4 Measurement Sources	100
GDDR5 Measurement Sources	104
Measurement Range Limits	107
Dynamic Limits for LPDDR Measurements	108
Dynamic Limits for LPDDR2 Measurements	109
Dynamic Limits for LPDDR3 Measurements	110
Dynamic Limits for DDR Measurements	111
Dynamic Limits for DDR2 Measurements	112
Dynamic Limits for DDR3 Measurements	113
Dynamic Limits for DDR3L Measurements	114
Dynamic Limits for DDR4 Measurements	115
Vih/Vil Reference Levels	115
Using Digital Channels	118
Error Codes and Warnings	125

Algorithms

About Algorithms	131
Write Measurements	
tDQSS	131
Data Eye Width	132
Data Eye Height	133
Differential DQS Measurements	
Input Slew-Diff-Rise(DQS)	134
Input Slew-Diff-Fall(DQS)	134
tDH-Diff(base)	135
tDH-Diff(derated)	135
tDH-Diff(Vref-based)	135
tDS-Diff(base)	135
tDS-Diff(derated)	137
tDS-Diff(Vref-based)	137
tDQSH	138
tDQSL	138
tDSS-Diff	138
tDSH-Diff	139
tDQSS-Diff	139
Single Ended DQS	
Slew Rate-Hold-SE-Fall(DQS)	139
Slew Rate-Hold-SE-Rise(DQS)	139
Slew Rate-Setup-SE-Fall(DQS)	139
Slew Rate-Setup-SE-Rise(DQS)	140
tDS-SE(base)	140

tDIPW-SE.....	140
tDSS-SE.....	140
tDSH-SE.....	140
tDQSS-SE.....	141
tDH-SE(base).....	141
tDVAC(CK).....	141
tWPRE.....	142
tWPST.....	143
tWRPDE.....	143
tWRSRE.....	143
Read Measurements	
Differential DQS	
tDQSCK-Diff.....	144
tDQSQ-Diff.....	144
tAC-Diff.....	145
tQH.....	145
SRQdiff-Rise(DQS).....	146
SRQdiff-Fall(DQS).....	146
Single Ended DQS	
tDQSQ-SE.....	147
tDQSCK-SE.....	147
DDR2-tDQSCK.....	148
Slew Rate DQ	
SRQse-Fall(DQ).....	148
SRQse-Rise(DQ).....	149
tRDPDE.....	149
tRDSRE.....	149
tRPRE.....	150
tRPST.....	150
DQ Measurements	
Slew Rate-Hold-Fall(DQ).....	150
Slew Rate-Hold-Rise(DQ).....	150
Slew Rate-Setup-Fall(DQ).....	150
Slew Rate-Setup-Rise(DQ).....	151
Clock(Diff) Measurements	
SSC Downspread(CK).....	151
SSC Mod Freq(CK).....	151
SSC Profile(CK).....	151
tCH.....	151
tCK.....	152
tCL.....	152
tCH(abs).....	152

tCH(avg)	153
tCK(abs)	153
tCK(avg)	153
tCL(abs).....	154
tCL(avg)	154
tHP	154
tERR.....	155
tJIT(cc).....	156
tJIT(duty)	156
tJIT(per).....	157
VID(ac)	157
Input Slew-Diff-Rise(CK)	157
Input Slew-Diff-Fall(CK).....	158
Clock (Single Ended)	
AC-Overshoot(CK#)	158
AC-Overshoot(CK).....	158
AC-OvershootArea(CK#).....	159
AC-OvershootArea(CK)	160
AC-Undershoot(CK#).....	160
AC-Undershoot(CK)	161
AC-UndershootArea(CK#)	161
AC-UndershootArea(CK).....	162
CKslew-Fall(CK)	162
CKslew-Fall(CK#).....	162
CKslew-Rise(CK)	163
CKslew-Rise(CK#)	163
VIN(CK).....	163
VIN(CK#)	163
Vix(ac)CK	164
Vox(ac)CK.....	164
VSWING(MAX)CK#	164
VSWING(MAX)CK	165
VSEH(AC)CK	165
VSEH(AC)CK#.....	166
VSEH(CK#).....	166
VSEH(CK)	166
VSEL(AC)CK#	166
VSEL(AC)CK.....	167
VSEL(CK#)	167
VSEL(CK).....	167
DQS(Single Ended) Measurements	
Vix(ac)DQS	168

Vox(ac)DQS	168
AC-Overshoot(DQS)	168
AC-Overshoot(DQS#)	169
AC-OvershootArea(DQS#).....	169
AC-OvershootArea(DQS)	170
AC-Undershoot(DQS)	170
AC-Undershoot(DQS#)	171
AC-UndershootArea(DQS#)	171
AC-UndershootArea(DQS).....	172
WCK (Diff)	
SSC Downspread(WCK)	172
SSC Mod Freq(WCK).....	172
SSC Profile(WCK)	173
tDVAC(WCK)	173
tWCK	173
tWCK-DJ	173
tWCKH	173
tWCKHP.....	174
tWCKL.....	174
tWCK-Rise-Slew	174
tWCK-Fall-Slew	174
tWCK-RJ	174
tWCK-TJ	175
VWCK-Swing.....	175
WCK (Single Ended)	
VIN(WCK)	175
VIN(WCK#).....	175
Vix(ac)WCK	176
VOL(WCK)	176
VOH(WCK).....	176
VOL(WCK#).....	176
VOH(WCK#)	177
WCKslew-Fall(WCK)	177
WCKslew-Fall(WCK#).....	177
WCKslew-Rise(WCK).....	177
WCKslew-Rise(WCK#)	177
Address/Command Measurements	
AC-Overshoot	178
AC-OvershootArea	178
AC-Undershoot	179
AC-UndershootArea.....	179
Slew Rate-Hold-Fall(Addr/Cmd)	180

Slew Rate-Hold-Rise(Addr/Cmd).....	180
Slew Rate-Setup-Fall(Addr/Cmd)	180
Slew Rate-Setup-Rise(Addr/Cmd).....	180
tAH	181
tAPW.....	181
tAS	181
tCMDH	181
tCMDPW	181
tCMDS.....	182
tIS(base)	182
tIH(base).....	182
tIS(derated).....	182
tIH(derated).....	183
tIPW-High.....	183
tIPW-Low.....	183
Refresh	
tCKSRE.....	183
tCKSRX	183
tRFC.....	184
tREFTR(Read)	184
tREFTR(Write).....	184
tXSNRW.....	184
Power Down	
tPD	184
Active	
tRAS.....	185
tRC	185
tRCDRD	186
tRCDWR	186
Precharge	
tPPD.....	187
tRP(ACT).....	187
tRP(MRS)	188
tRP(REF)	188
tRP(SRE)	188
tRTPL	188

GPIB Commands

About the GPIB Program	189
GPIB Reference Materials.....	189
Argument Types	190
DDRA:ADDMeas.....	190

DDRA:ADDALLDiffdqs	192
DDRA:ADDALLSEdqs	192
DDRA:ADDALLSLewdq	193
DDRA:ADDALLTerr	193
DDRA:CLEARALLMeas	194
DDRA:LASTError?	194
DDRA:GENeration.....	195
DDRA:DATARate	196
DDRA:CUSTOMRate	197
DDRA:MEASType.....	198
DDRA:VDDMode.....	198
DDRA:VDD	199
DDRA:VREFMode	199
DDRA:VREF	200
DDRA:VIHACMin?	200
DDRA:VIHDCMin?	201
DDRA:VREFDC?	201
DDRA:VILDCMax?	202
DDRA:VILACMax?	202
DDRA:SOURCE?	203
DDRA:SOURCE:STROBE	203
DDRA:SOURCE:STROBebars	204
DDRA:SOURCE:DATA.....	205
DDRA:SOURCE:CLOCK	206
DDRA:SOURCE:CLOCKBar	207
DDRA:SOURCE:WCK.....	208
DDRA:SOURCE:WCKBar	209
DDRA:BURSTDETECTmethod.....	210
DDRA:BUS	211
DDRA:SYMBOLFile	212
DDRA:LOGICTrigger	212
DDRA:BURSTTolerance	213
DDRA:BURSTLAtency	213
DDRA:BURSTLEngth	214
DDRA:ALternatethresholds	215
DDRA:VERTicalscaling.....	216
DDRA:HORIZontalscaling	217
DDRA:CSSOURce.....	217
DDRA:CASMIN	218
DDRA:CASMAX	218
DDRA:CSLEvel	219
DDRA:CSMOde.....	219

DDRA:CSACTive.....	220
DDRA:VERsion?.....	220
DDRA:BURSTLevelmode.....	221
DDRA:STROBEHIGH.....	221
DDRA:STROBELOW.....	222
DDRA:STROBEMID.....	222
DDRA:DATALOW.....	223
DDRA:DATAHIGH.....	223
DDRA:DATAMID.....	224
DDRA:HYSTEREsis.....	224
DDRA:MARGIN.....	225
DDRA:DQDQSLEVELSTatus?.....	225
DDRA:VCENTDQ.....	226
DDRA:FLTtype.....	226
DDRA:PTYPDQS.....	227
DDRA:PTYPCLK.....	227
DDRA:PTYPWCK.....	228
DDRA:SEFLTFile.....	228
DDRA:DIFFFLTFile.....	229
DDRA:TCKAVGMIN.....	229
DDRA:TCKAVG.....	230

Index

General safety summary

Review the following safety precautions to avoid injury and prevent damage to this product or any products connected to it.

To avoid potential hazards, use this product only as specified.

Only qualified personnel should perform service procedures.

While using this product, you may need to access other parts of a larger system. Read the safety sections of the other component manuals for warnings and cautions related to operating the system.

To avoid fire or personal injury

Use proper power cord. Use only the power cord specified for this product and certified for the country of use.

Connect and disconnect properly. Do not connect or disconnect probes or test leads while they are connected to a voltage source.

Connect and disconnect properly. Connect the probe output to the measurement instrument before connecting the probe to the circuit under test. Connect the probe reference lead to the circuit under test before connecting the probe input. Disconnect the probe input and the probe reference lead from the circuit under test before disconnecting the probe from the measurement instrument.

Observe all terminal ratings. To avoid fire or shock hazard, observe all ratings and markings on the product. Consult the product manual for further ratings information before making connections to the product.

Do not operate without covers. Do not operate this product with covers or panels removed.

Do not operate with suspected failures. If you suspect that there is damage to this product, have it inspected by qualified service personnel.

Avoid exposed circuitry. Do not touch exposed connections and components when power is present.

Terms in this manual

These terms may appear in this manual:



WARNING. *Warning statements identify conditions or practices that could result in injury or loss of life.*



CAUTION. *Caution statements identify conditions or practices that could result in damage to this product or other property.*

Welcome

DDR (Dual Data Rate) is a dominant and fast-growing memory technology. It offers the high data transfer rates needed for virtually all computing applications, from consumer products to the most powerful servers. The high speeds of these signals require high performance measurement tools.

The DDRA application includes compliance measurements as part of our DDR Analysis solution. The DDR Analysis solution enables you to achieve new levels of productivity, efficiency, and measurement reliability. It requires the Jitter and Eye Diagram Analysis tool (Opt. DJA) and the Advanced Search and Mark capability (Opt. ASM).

Some of the DDRA features are:

- Provides debug, analysis, and compliance in one solution for multiple DDR standards such as [DDR \(see page 1\)](#), [DDR2 \(see page 2\)](#), [DDR3 \(see page 2\)](#), [DDR3L \(see page 2\)](#), [DDR4 \(see page 2\)](#), [LPDDR \(see page 2\)](#), [LPDDR2 \(see page 2\)](#), [LPDDR3 \(see page 2\)](#), [GDDR3 \(see page 2\)](#), and [GDDR5 \(see page 3\)](#).
- Enables analysis of compliance measurements either through the DDRA or DPOJET application for all bursts in an acquisition
- Differentiates data reads from writes, or analyzes signal integrity on the clock or on a data (DQ) line during Read or Write cycles, or measures Data to Strobe setup and hold during Write cycles
- Includes limit files to test measurement pass/fail status per standard, speed grades and speed bins. Supports non-standard speed grades
- Provides both single-ended and differential measurements on Data, Strobe, Clock, Address and Command signals
- Includes comprehensive measurement statistics
- Includes sophisticated graphical analysis tools such as Histograms, Time Trends, Spectrums, Bathtub Plots, and Real-Time Eye® diagrams with superimposition of the strobe eye with the data eye
- Produces consolidated reports automatically with pass/fail information, statistical measurement results, setup information, limits information, waveform path location, plots and user comments, if any.
- Automatically applies signal slew rate derating of measurement limits for Address/Command and data signals
- Dynamically normalizes limits for clock measurements such as tERR based on the measured tCK(avg)
- Logic state configuration using the DDRA user interface.

DDR

DDR is the DRAM (Dynamic Random Access Memory) technology responsible for increasing data transfer rates to meet high-speed requirements and data capacity of computer systems.

DDR2

DDR2 is the Double Data Rate 2 SDRAM and is widely available in products with data rates up to 1066MT/s.

DDR3

DDR3 DRAM memory is widely available in products and extends data rates to 1600 MT/s and faster rates to come.

DDR3L

DDR3L (low voltage) DRAM memory is widely available in products and extends data rates to 1600 MT/s and faster rates to come.

DDR4

DDR4 DRAM memory is widely available in products and extends data rates to 3200 MT/s and faster rates to come.

Low Power DDR

LPDDR (Low Power DDR) is an emerging technology for mobile phones and portable computing devices, driven by the need for faster operation with long battery life.

Low Power DDR2

LPDDR2 (Low Power DDR2) is an emerging technology for mobile phones and portable computing devices as it supports advanced power management. Includes a reduced interface voltage of 1.2 V from the 1.8 V specification as compared to LPDDR memory technology. This results in a power consumption reduced by over 50%.

Low Power DDR3

LPDDR3 (Low Power DDR3) is an emerging technology for mobile phones and portable computing devices as it supports advanced power management. Includes a reduced interface voltage of 1.2 V from the 1.8 V specification as compared to LPDDR memory technology. This results in a power consumption reduced by over 50%.

Graphic DDR3

GDDR3 (Graphic DDR) offers faster access and is used in graphics-intensive applications such as video cards and gaming systems.

GDDR5

GDDR5 (Graphic DDR) is a type of high performance dynamic random-access graphics card memory designed for applications requiring high bandwidth.

Related Documentation

Tektronix manuals are available at: www.tektronix.com/manuals and www.tektronix.com/software. Use the following table to determine the document that you need:

Table 1: List of reference documents

For information on	Refer to
■ Operating the Oscilloscope	Oscilloscope user manual. Oscilloscope user online help.
■ Software warranty	<i>Optional Applications Software on Windows-Based Oscilloscopes Installation Manual</i> , which is provided on the Optional Applications Software on Windows-Based Oscilloscopes DVD, in the Documents directory.
■ List of available applications	
■ Compatible oscilloscopes	
■ Relevant software and firmware version numbers	
■ Applying a new option key label	
■ Installing an application	
■ Enabling an application	
■ Downloading updates from the Tektronix Web site	



Conventions

Online Help uses the following conventions:

- When steps require a sequence of selections using the application interface, the “>” delimiter marks each transition between a menu and an option. For example, **Analyze > DDR Analysis**.
- The terms “DDR application” and “application” refer to DDRA.
- The term “DPOJET application” or “DPOJET” refers to Jitter and Eye Diagram Analysis Tool.
- The term “oscilloscope” refers to any product on which this application runs.
- The term “DUT” is an abbreviation for Device Under Test.
- The term “select” is a generic term that applies to the methods of choosing an option: with a mouse or with the touch screen.
- User interface screen graphics are taken from a DPO7000 series oscilloscope.

You can find a PDF (portable document format) file for this document in the Documents directory on the *Optional Applications Software on Windows-Based Oscilloscopes DVD*. The DVD booklet contains information on installing the application from the DVD and on how to apply a new label.

Table 2: Icon descriptions

Icon	Meaning
	This icon identifies important information.
	This icon identifies conditions or practices that could result in loss of data.
	This icon identifies additional information that will help you use the application more efficiently.

Technical Support

Tektronix welcomes your comments about products and services. Contact Tektronix through mail, telephone, or the Web site. Click [Contacting Tektronix](#) for more information. Tektronix also welcomes your feedback. Click [Customer feedback](#) for suggestions for providing feedback to Tektronix.

Customer Feedback

Tektronix values your feedback on our products. To help us serve you better, please send us your suggestions, ideas, or other comments you may have regarding the application or oscilloscope.

Direct your feedback via e-mail to

techsupport@tektronix.com

Or FAX at (503) 627-5695, and include the following information:

General Information

- Oscilloscope model number (for example: DPO7000C or DSA/DPO/MSO70000C/D/DX series) and hardware options, if any.
- Software version number.
- Probes used.

Application-specific Information

- Description of the problem such that technical support can duplicate the problem.
- If possible, save the oscilloscope and application setup files as `.set` and associated `.xml` files.
- If possible, save the waveform on which you are performing the measurement as a `.wfm` file.

Once you have gathered this information, you can contact technical support by phone or through e-mail. In the subject field, please indicate “DDRA Problem” and attach the `.set`, `.xml` and `.wfm` files to your e-mail. If there is any query related to the actual measurement results, then you can generate a `.mht` report and send it. If you need to send very large files, technical support can assist you to transfer the files via ftp (file transfer protocol).

The following items are important, but optional:

- Your name
- Your company
- Your mailing address
- Your phone number
- Your FAX number

Enter your suggestion. Please be as specific as possible.

Please indicate if you would like to be contacted by Tektronix regarding your suggestion or comments.

Product Description

DDR Analysis is a standard specific solution tool for Tektronix Performance Digital Oscilloscopes (DPO7000C or DSA/DPO/MSO70000C/D/DX series). DDR Analysis requires Jitter and Eye Diagram Analysis Tool (Opt.DJA) and the advanced Search and Mark capability (Opt. ASM).

The features of DDRA are:

- Provides debug, analysis, and compliance in one solution for multiple DDR standards such as [DDR \(see page 1\)](#), [DDR2 \(see page 2\)](#), [DDR3 \(see page 2\)](#), [DDR3L \(see page 2\)](#), [DDR4 \(see page 2\)](#), [LPDDR \(see page 2\)](#), [LPDDR2 \(see page 2\)](#), [LPDDR3 \(see page 2\)](#), [GDDR3 \(see page 2\)](#), and [GDDR5 \(see page 3\)](#).
- Identifies Read and/or Write operations automatically
- Custom data rates and input levels to tailor DDRA Read and/or Write burst identification
- Provides both single-ended and differential measurements on Data, Strobe, Clock, Address and Command signals
- Analyze compliance measurements either through DDRA or Jitter and Eye Diagram Analysis Tool
- Limit files to test measurement pass/fail status
- Automatically applies signal slew rate derating of measurement limits for Address/Command and data signals
- Preferences shortcut available for all DDRA steps. For more details, refer to the DPOJET online help.
- Logic state configuration using the DDRA user interface.

DDRA Prerequisites

To use the DDRA application on instruments using 32-bit operating systems, you need Opt. ASM (Advanced Search and Mark Tool) and DPOJET Advanced (Opt. DJA) enabled.

Requirements and Restrictions

DPOJET (DJA) is required to operate DDRA on your oscilloscope. Also refer to subsequent requirements for DPOJET.

Supported Probes

The application supports the following probes:

- TAP2500
- TAP1500
- TCP0030
- P6158
- P6101B
- P6246
- P6247 (DPO7254 only)
- P6248 (DPO7254 only)
- P6249
- P6150
- P6158
- P7240
- P7260
- P7330
- P7340A
- P7350
- P7360A
- P7380A
- P7313A
- P7513
- P7520A
- P7520
- P7500 Series TriMode

Installing the Application

Refer to the *Optional Applications Software on Windows-Based Oscilloscopes Installation Manual* for the following information:

- Software warranty.
- List of available applications, compatible oscilloscopes, and relevant software and firmware version numbers.
- Applying a new option installation key label.
- Installing an application.
- Enabling an application.
- Downloading updates from the Tektronix Web site.

You can find a PDF (portable document format) file for this document in the Documents directory on the *Optional Applications Software on Windows-Based Oscilloscopes DVD*. The DVD booklet contains information on how to install the application from the DVD and on how to apply a new option installation key label.

About DDRA

Click **Help > About DPOJET** to view DDRA application details such as the software released version number, application name and copyright.

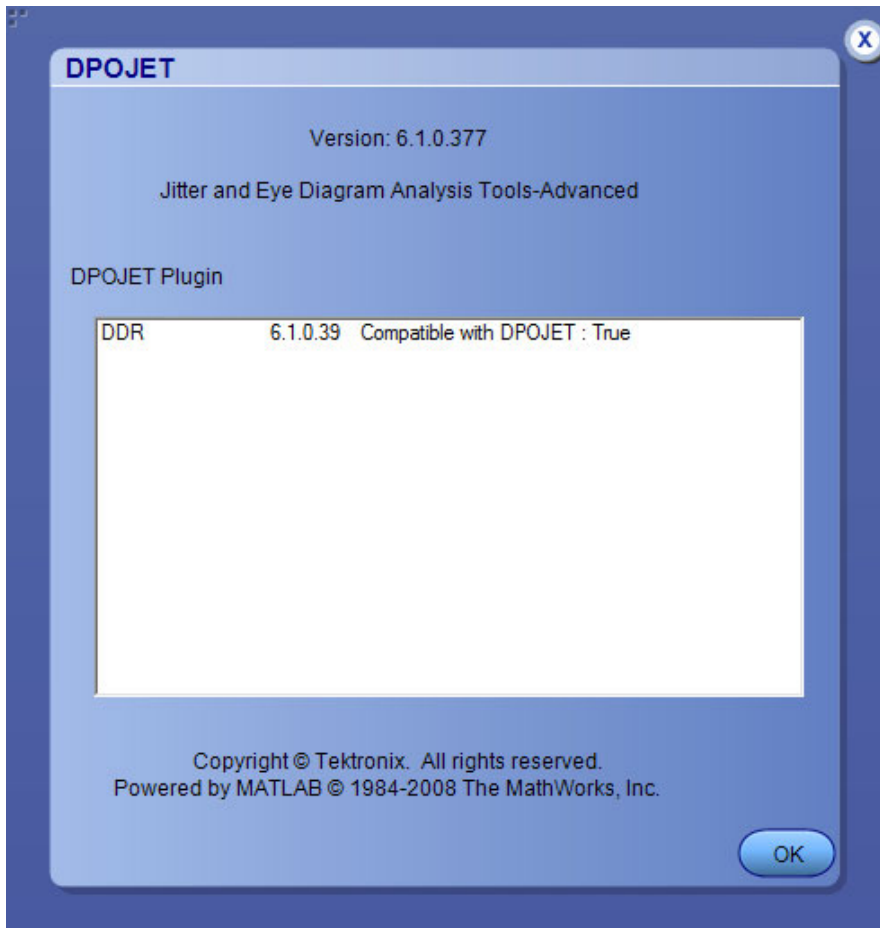





NOTE. The version displayed above is indicative only, the version number displayed will vary depending upon the exact version of the application installed.

Starting the Application

On the oscilloscope menu bar, click **Analyze > DDR Analysis** to open the application.

Menu Controls

Table 3: Application Menu Controls descriptions

Item	Description
Tab	Shortcut to a menu in the menu bar or a category of menu options; most tabs are short cuts.
Area	Visual frame with a set of related options.
Option button	Button that defines a particular command or task.
Field	Box that you can use to type in text, or to enter a value with the Keypad or a Multipurpose knob.
Check Boxes	Use to select configuration options or clear preferences.
Browse	Displays a window where you can look through a list of directories and files.
Command button	Button that initiates an immediate action such as Run command button  in the control panel.
Virtual Keypad icon 	Click to use on-screen keypad to enter alphanumeric values.
MP knob references (a or b)  	Identifiers that show which Multi Purpose Knob (MPK) may be used as an alternate means to control a parameter; turn the knob on the oscilloscope front panel to adjust the corresponding parameter. Also, the value can be entered directly on the MPK display component.



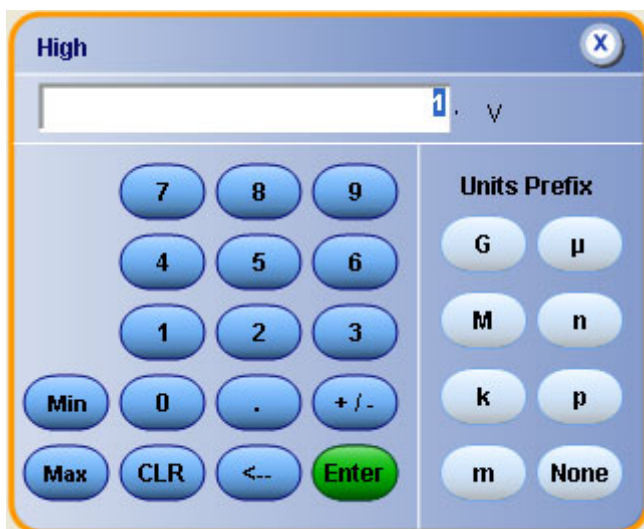

Virtual Keypad

Select the  icon and use the virtual keypad to enter alphanumeric values, such as reference voltage levels.



Tips on the DDRA User Interface

Here are some tips to help you with the application user interface:

- Use the Single button  to obtain a set of measurements from a single new waveform acquisition. Pushing the button again before processing has completed will interrupt the processing cycle.
- Use the Run button  to continuously acquire and accumulate measurements. If prior measurements have been acquired and have not been cleared, the new measurement are added to the existing set. Push the button again to interrupt the current acquisition.
- Use the Recalc button  to perform measurements on the waveform currently displayed on the oscilloscope without performing a new acquisition. This is useful if you wish to modify a configuration parameter and re-run the measurements on the current waveform.
- Use the Clear button  to clear all existing measurement results. Note that adding or deleting a measurement, or changing a configuration parameter of an existing measurement, will also cause measurements to be cleared. This is to prevent the accumulation of measurement statistics or sets of statistics that are not coherent.

Application Directories

The installation directory for DDRA executable files is `C:\Program Files\TekApplications\DDRA` and the installation directory for user files is `C:\TekApplications\DDRA` for oscilloscope running with Windows-XP operating system and `C:\Users\Public\Tektronix\TekApplications\DDRA` for oscilloscopes running with Windows7 operating system. During installation, the application sets up a limits folder in the user directory. This folder contains limit files for various DDR standards and speed grades.

For 64-bit systems, the DDRA installer copies the symbol files into the following location: `C:\Users\Public\Tektronix\TekScope\BusDecodeTables\DDR`. This is different from the default TekScope location at `C:\Users\[Username]\Tektronix\Tekscope\BusDecodeTables`.

File Name Extensions

Table 4: File name extensions

File Extension	Description
.csv	An ascii file containing Comma Separated Values. This file format may be read by any ascii text editor (such as Notepad) or may be imported into spreadsheets such as Excel.
.xml	An ascii file containing measurement setup information, limits or other data in Extensible Markup Language.
.set	A binary file containing oscilloscope setup information in a proprietary format.
.mht	An HTML archive file, compatible with common Windows applications; contains the full report, including text and graphics.
.wfm	A binary file containing an oscilloscope waveform record in a recallable, proprietary format.
.tsf	A symbol file containing various symbols for various logic trigger patterns.

Returning to the Application

When you access oscilloscope functions, the DDRA control windows may be replaced by the oscilloscope control windows or by the oscilloscope graticule. You can access oscilloscope functions in the following ways:

- From the menu bar on the oscilloscope, choose **Analyze > DDR Analysis**.
- Alternatively, you can switch between recently used control panels using the forward or backward arrows  on the right corner of the control panel.

Control Panel

The Control Panel appears on the right of the application window. Using this panel, you can start or stop the sequence of processes for the application and the oscilloscope to acquire information from the waveform. The controls are Clear, Recalc, Single, and Run. The following table describes each of these controls:

Item	Description
Clear	Clears the current result display and resets any statistical results and autoset ref levels. For any input sources that have reference level autoset enabled, clears the current ref levels so that they will be recalculated during the next acquisition.
Recalc	Runs the selected measurements on the currently displayed waveform(s), without first performing a new acquisition.
Single	Initiates a single new acquisition and runs the selected measurements.
Run	Initiates new acquisitions and runs the selected measurements repeatedly until Stop is clicked. For any non-live sources (Reference waveforms or Math waveforms not dependent on a live channel), only a single processing cycle will occur.
Show Plots	Displays the plot summary window when clicked. This button appears in the control panel only when one or more plots have been defined.
Advanced Setup DPOJET 	Transitions to the Jitter and Eye Diagram Analysis application when clicked, importing all currently defined DDRA measurements. This button appears in the control panel when you open the DDR analysis application. This is useful if you wish to add additional measurements not defined in DDRA, or wish to change measurement configurations to intentionally deviate from those recommended by DDRA.

Saving a Setup

The DDRA application state is automatically saved along with the oscilloscope state. To save the oscilloscope settings and the application state, follow these steps:

1. Click **File > Save As > Setup**.
2. In the file browser, select the directory to save the setup file.
3. Select or enter a file name. The application appends *_DDRA.xml and *_DPOJET.xml to store the DDR setup, and *.set to store the oscilloscope settings.
4. Click **Save**.

NOTE. *After the oscilloscope application is started, DDRA needs to be launched at least once before any saved DDRA configuration can be recalled.*

Recalling a Saved Setup

To recall a previously saved set of application and oscilloscope settings, do the following steps:

NOTE. *While recalling setup files with both DDRA and DPOJET saved settings, DDRA setup values get a higher precedence over DPOJET setup values. For example: Select a DPOJET measurement and a DDRA measurement, change the ref levels of DPOJET measurement and save the setup file. On recalling the setup file, you will see that the DPOJET ref level settings are overwritten by the DDRA measurement ref levels.*

1. Click **File > Recall..**
2. Click **Setup** in the left column if it is not already selected.
3. Select the directory in the file browser from which you wish to recall the setup file.
4. Select a .set file and click **Recall**.

NOTE. *Only .set files can be selected for recall; any corresponding *_DDRA.xml and *_DPOJET.xml file in the same directory will be recalled as well, if DDRA has been launched at least once since the oscilloscope application was started. If DDRA has not been launched at least once, the oscilloscope settings will be recalled but the DDRA configuration will be ignored.*

Recalling the Default Setup

To recall the default application and oscilloscope settings, click **File > Recall Default Setup**.

NOTE. *Recalling default setup sets the DDRA application to DDR3 generation and data rate, None.*

Limits

A limits file allows you to configure the limits used to determine Pass or Fail status for tests. Each limits file includes a list of one or more measurements, and the ranges of acceptable values for any or all statistics for each measurement that include combinations of all measurements and statistical characteristics, and an appropriate range of values for each combination.

The application provides preconfigured limits files for many combinations of standards and speed grades. You can create one by specifying limits for any of the result parameters such as Mean, Std Dev, Max, Min, peak-to-peak, population, MaxPosDelta and MinPosDelta. For each of these result parameters, you can specify the Upper Limit Equality (ULE), Lower Limit Equality (LLE), or Both. The measurement names in the limits file must be entered as mentioned in [About DDR Analysis](#).

To include Pass/Fail status in the result statistics, you can create a custom limits file in the following format using an XML editor or any other editor. If the file is created in any other editor such as Notepad, it should be saved in Unicode format.

The following is a sample of the limit file for DDR2 generation, the data rate being 667 MHz

```
<?xml version="1.0" encoding="utf-16" ?>
<Main>
<Measurement>
<NAME>DDR HoId-Di ff</NAME>
<STATS>
<STATS_NAME>Min</STATS_NAME>
<LIMIT>BOTH</LIMIT>
<ULE>175e-12</ULE>
<LLE>0</LLE>
</STATS>
</Measurement>
<Measurement>
<NAME>tdH-Di ff(base)</NAME>
<STATS>
<STATS_NAME>Min</STATS_NAME>
<LIMIT>BOTH</LIMIT>
<ULE>175e-12</ULE>
<LLE>0</LLE>
</STATS>
</Measurement>
</Main>
```

You can find limit files for various data rates of different DDR standards and speed bins at C:\TekApplications\DDRA\Limits.

NOTE. Base limit values change based on the selected AC configuration at Step 6 (see page 51). For DDR3 1333 MT/s and 1600 MT/s, AC 150 ref level are applied independent of the specified AC config.

Search and Mark

The data rate, generation, and measurement type selected in DDRA are also set in Advanced Search and Mark (ASM). Marks are available only for Read and Write bursts measurement type. You can configure Search using **Advance > Search > Configure**. The identified bursts are shown as small inverted marks (▣) in the oscilloscope display area. Each pair of marks specifies the start and stop of a burst. You can traverse from one mark to the other using the Mark Control window. For more details, refer to your oscilloscope online help.



Dynamic Limits

The application supports both static (predefined using limits file) and dynamic limits. Dynamic limits are available only for DDRA clock measurements. They are calculated using the result of other measurement(s).

The concept of dynamic limits is explained taking an example of a measurement, tCH(avg):

- If the dynamic limits of a measurement depend on the result of other measurement(s) that has not yet been calculated, the limit text field in the results panel shows “Derived...”. A tool tip displays the message “This limit is calculated based on measurement tCK(avg)”.

The screenshot shows the 'DDR Analysis' window with the 'Results' tab selected. The table displays the following data:

Description	Mean	Std Dev	Max	Min	p-p	Population	Max-cc	Min-cc
tCH(avg), CK								
Low Limit				Derived...				
High Limit			Derived...					
Pass Fail								
Current Acquisition			This limit is calculated based on tCK(avg)					

- On clicking Run/Single, the results are shown in the following figure:

The screenshot shows the 'DDR Analysis' window with the 'Results' tab selected. The table displays the following data:

Description	Mean	Std Dev	Max	Min	p-p	Population	Max-cc	Min-cc
tCH(avg), Ref1	499.31mt...	214.74utC...	499.94mt...	498.76mt...	1.1772mt...	10498	79.188utC...	-94.990utC...
Low Limit				470.00mt...				
High Limit			530.00mt...					
Pass Fail			Pass	530.00mtCK(avg) - This limit is calculated based on tCK(avg)	Pass			
Current Acquisition	499.31mt...	214.74utC...	499.94mt...	498.76mt...	1.1772mt...	10498	79.188utC...	-94.990utC...

- If there is an error in calculating dynamic limits, the limit text field displays “Error...” as shown. A tool tip displays the message “This limit is calculated based on measurement tCK(avg)”.

The screenshot shows the 'DDR Analysis' window with the 'Results' tab selected. The table displays the following data:

Description	Mean	Std Dev	Max	Min	p-p	Population	Max-cc	Min-cc
tCH(avg), CK						0		
Low Limit				Error...				
High Limit			Error...					
Pass Fail								
Current Acquisition			This limit is calculated based on tCK(avg)					

References

- [Dynamic Limits for LPDDR Measurements \(see page 108\)](#)
- [Dynamic Limits for LPDDR2 Measurements \(see page 109\)](#)
- [Dynamic Limits for DDR Measurements \(see page 111\)](#)
- [Dynamic Limits for DDR2 Measurements \(see page 112\)](#)
- [Dynamic Limits for DDR3 Measurements \(see page 113\)](#)

DDR Standards and their Measurements

The following table lists the measurements displayed for each DDR standard:

NOTE. For more details on the measurements, refer to the Algorithms section.

Measurements	DDR ⁺	DDR2	DDR3	DDR3L	DDR4	LPDDR ⁺⁺	LPDDR2	LPDDR3	GDDR3 ⁺	GDDR5
Write Bursts										
Data Eye Width	✓	✓	✓	✓	✓	✓	✓	✓	✓	✓
Data Eye Height	✓	✓	✓	✓	✓	✓	✓	✓	✓	✓
tWRSRE										✓
tWRPDE										✓
Differential DQS										
Input Slew-Diff-Fall(DQS)		✓	✓	✓			✓	✓		
Input Slew-Diff-Rise(DQS)		✓	✓	✓			✓	✓		
tDH-Diff(base)		✓	✓	✓		✓	✓			
tDH-Diff(derated)		✓	✓	✓			✓	✓		
tDH-Diff(Vref-based)							✓	✓		
tDQSH		✓	✓	✓	✓	✓	✓	✓		
tDQSL		✓	✓	✓	✓	✓	✓	✓		
tDS-Diff(base)		✓	✓	✓		✓	✓			
tDS-Diff(derated)		✓		✓			✓	✓		
tDS-Diff(Vref-based)							✓	✓		
tDSS-Diff	✓	✓	✓	✓	✓	✓	✓	✓		
tDQSS-Diff		✓	✓	✓	✓	✓	✓			
tDSH-Diff	✓	✓	✓	✓	✓	✓	✓	✓		
TdIPW-High					✓			✓		
TdIPW-Low					✓			✓		

Measurements	DDR ++	DDR2	DDR3	DDR3L	DDR4	LPDDR ++	LPDDR2	LPDDR3	GDDR3 +	GDDR5
VIHL-AC					✓					
SRIN_dIVW_Rise					✓					
SRIN_dIVW_Fall					✓					
tDVAC(DQS)			✓	✓	✓		✓	✓		
Single Ended DQS										
Slew Rate-Hold-SE-Fall(DQS)		✓								
Slew Rate-Hold-SE-Rise(DQS)		✓								
Slew Rate-Setup-SE-Fall(DQS)		✓								
Slew Rate-Setup-SE-Rise(DQS)		✓								
tDH-SE(base)	✓	✓				✓				
tDH-SE(derated)		✓								
tDIPW-SE	✓	✓	✓	✓		✓	✓			
tDS-SE(base)	✓	✓				✓				
tDS-SE(derated)		✓								
tDIPW-SE	✓	✓	✓			✓				
tDQSS-SE		✓	✓	✓		✓	✓			
tDSH-SE	✓	✓	✓	✓		✓				
tDSS-SE	✓	✓	✓	✓		✓				
Slew Rate DQ										
Slew Rate-Hold-Fall(DQ)		✓	✓	✓			✓	✓		
Slew Rate-Hold-Rise(DQ)		✓	✓	✓			✓	✓		
Slew Rate-Setup-Fall(DQ)		✓	✓	✓			✓	✓		
Slew Rate-Setup-Rise(DQ)		✓	✓	✓			✓	✓		
tDQSS								✓		
RX Mask					✓					
tWPRE	✓	✓	✓		✓	✓	✓	✓		
tWPST	✓	✓	✓		✓	✓	✓	✓		
Read Bursts										
Data Eye Width	✓	✓	✓	✓	✓	✓	✓	✓	✓	✓
Date Eye Height	✓	✓	✓	✓	✓	✓	✓	✓	✓	✓
tRDSRE										✓
tRDPDE										✓
Differential DQS										

Measurements	DDR +	DDR2	DDR3	DDR3L	DDR4	LPDDR ++	LPDDR2	LPDDR3	GDDR3 †	GDDR5
tAC-Diff	✓	✓				✓				
tDQCK-Diff	✓		✓	✓	✓	✓				
tDQS-Diff		✓	✓	✓	✓		✓	✓		
tDVAC(DQS)			✓	✓	✓		✓	✓		
tQH	✓	✓	✓	✓	✓	✓	✓	✓		
tQSL					✓			✓		
tLZ(DQS)					✓					
tHZ(DQS)					✓					
tQSH					✓			✓		
SRQdiff-Rise(DQS)			✓		✓		✓	✓		
SRQdiff-Fall(DQS)			✓		✓		✓	✓		
Single Ended DQS										
tDQCK-SE		✓								
tDQS-SE	✓	✓				✓				
Vox(ac)DQS		✓								
Slew Rate (DQ)										
SRQse-Fall(DQ)				✓	✓		✓	✓		
SRQse-Rise(DQ)				✓	✓		✓	✓		
tLZ(DQ)					✓					
tHZ(DQ)					✓					
tDQCK								✓		
tRPRE	✓	✓	✓		✓	✓	✓	✓		
tRPST	✓	✓	✓		✓	✓	✓	✓		
Clock (Diff) ‡										
tCH(abs)		✓	✓	✓	✓		✓	✓		
tCH(avg)		✓	✓	✓	✓		✓	✓		
tCK(abs)		✓	✓	✓	✓		✓	✓		
tCK(avg)		✓	✓	✓	✓		✓	✓		
tCL(abs)		✓	✓	✓	✓		✓	✓		
tCL(avg)		✓	✓	✓	✓		✓	✓		
tDVAC(CK)			✓	✓	✓		✓	✓		
tERR			✓	✓	✓		✓	✓		
(Includes measurements from tERR2 to 49per)										
tERR(11–50per)		✓		✓						
tERR(2per)		✓			✓					

Measurements	DDR ++	DDR2	DDR3	DDR3L	DDR4	LPDDR ++	LPDDR2	LPDDR3	GDDR3 +	GDDR5
tERR(3per)		✓			✓					
tERR(4per)		✓			✓					
tERR(5per)		✓			✓					
tERR(6–10per)		✓		✓						
tJIT(cc)		✓	✓	✓	✓		✓	✓		✓
tJIT(duty)		✓	✓	✓	✓		✓	✓		✓
tJIT(per)		✓	✓	✓	✓		✓	✓		
tHP		✓					✓			✓
VID(ac)	✓	✓				✓				
Input Slew-Diff-Rise(CK)	✓	✓	✓		✓	✓	✓	✓		
Input Slew-Diff-Fall(CK)	✓	✓	✓		✓	✓	✓	✓		
tDVAC(CK)					✓			✓		✓
tCK										✓
tCH										✓
tCL										✓
SSC Downspread (CK)										✓
SSC Mod Freq (CK)										✓
Clock (Single Ended)										
AC-Overshoot(CK#)	✓	✓	✓	✓	✓	✓	✓	✓		
AC-Overshoot(CK)	✓	✓	✓	✓	✓	✓	✓	✓		
ACOvershootArea(CK#)	✓	✓	✓	✓	✓	✓	✓	✓		
ACOvershootArea(CK)	✓	✓	✓	✓	✓	✓	✓	✓		
AC-Undershoot(CK#)	✓	✓	✓	✓	✓	✓	✓	✓		
AC-Undershoot(CK)	✓	✓	✓	✓	✓	✓	✓	✓		
AC-UndershootArea(CK#)	✓	✓	✓	✓	✓	✓	✓	✓		
AC-UndershootArea(CK)	✓	✓	✓	✓	✓	✓	✓	✓		
VIXCA							✓			
Vix(ac)CK	✓	✓	✓	✓	✓	✓		✓		✓
Vox(ac)CK		✓								
VSWING(MAX)CK		✓								
VSWING(MAX)CK#		✓								
VSEH(AC)CK			✓	✓			✓	✓		
VSEH(AC)CK#			✓	✓			✓	✓		
VSEH(CK#)			✓	✓	✓					
VSEH(CK)			✓	✓	✓					
VSEL(AC)CK			✓	✓			✓	✓		

Measurements	DDR ++	DDR2	DDR3	DDR3L	DDR4	LPDDR ++	LPDDR2	LPDDR3	GDDR3 +-	GDDR5
VSEL(AC)CK#			✓	✓			✓	✓		
VSEL(CK#)			✓	✓	✓					
VSEL(CK)			✓	✓	✓					
VIN(CK)										✓
VIN(CK#)										✓
CKSlew-Rise(CK)										✓
CKSlew-Rise(CK#)										✓
CKSlew-Fall(CK)										✓
CKSlew-Fall(CK#)										✓
DQS (Single Ended)										
AC-Overshoot(DQ)	✓	✓	✓	✓	✓	✓	✓	✓		
AC-Undershoot(DQ)	✓	✓	✓	✓	✓	✓	✓	✓		
AC-Overshoot(DQS#)	✓	✓	✓	✓	✓		✓	✓		
AC-Overshoot(DQS)	✓	✓	✓	✓	✓	✓	✓	✓		
AC-OvershootArea(DQ)	✓	✓	✓	✓	✓	✓	✓	✓		
AC-UndershootArea(DQ)	✓	✓	✓	✓	✓	✓	✓	✓		
AC-OvershootArea(DQS#)	✓	✓	✓	✓	✓		✓	✓		
AC-OvershootArea(DQS)	✓	✓	✓	✓	✓	✓	✓	✓		
AC-Undershoot(DQS#)	✓	✓	✓	✓	✓		✓	✓		
AC-Undershoot(DQS)	✓	✓	✓	✓	✓	✓	✓	✓		
AC-UndershootArea(DQS)	✓	✓	✓	✓	✓	✓	✓	✓		
AC-Under-shootArea(DQS#)	✓	✓	✓	✓	✓		✓	✓		
Vix(ac)DQS				✓	✓			✓		
VIXDQ							✓			
VSWING(MAX)DQS		✓								
VSWING(MAX)DQS#		✓								
VSEH(AC)DQS			✓	✓			✓	✓		
VSEH(AC)DQS#			✓	✓			✓	✓		
VSEH(DQS#)			✓	✓	✓					
VSEH(DQS)			✓	✓	✓					
VSEL(AC)DQS			✓	✓			✓	✓		
VSEL(AC)DQS#			✓	✓			✓	✓		
VSEL(DQS#)			✓	✓	✓					
VSEL(DQS)			✓	✓	✓					
DQS (Single Ended, Read)										

Measurements	DDR ++	DDR2	DDR3	DDR3L	DDR4	LPDDR ++	LPDDR2	LPDDR3	GDDR3 +	GDDR5
AC-OvershootArea(DQ)	✓	✓	✓	✓		✓	✓	✓		
AC-UndershootArea(DQ)	✓	✓	✓	✓		✓	✓	✓		
AC-Overshoot(DQ)	✓	✓	✓	✓		✓	✓	✓		
AC-Undershoot(DQ)	✓	✓	✓	✓		✓	✓	✓		
AC-OvershootArea(DQS)	✓	✓	✓	✓		✓	✓	✓		
AC-UndershootArea(DQS)	✓	✓	✓	✓		✓	✓	✓		
AC-Overshoot(DQS)	✓	✓	✓	✓		✓	✓	✓		
AC-Undershoot(DQS)	✓	✓	✓	✓		✓	✓	✓		
AC-OvershootArea(DQS#)	✓	✓	✓	✓			✓	✓		
AC-Under-shootArea(DQS#)	✓	✓	✓	✓			✓	✓		
AC-Overshoot(DQS#)	✓	✓	✓	✓			✓	✓		
AC-Undershoot(DQS#)	✓	✓	✓	✓			✓	✓		
Vox(ac)DQS		✓								
Address/Command										
AC-Overshoot	✓	✓	✓	✓	✓	✓	✓	✓		
AC-OvershootArea	✓	✓	✓	✓	✓	✓	✓	✓		
AC-Undershoot	✓	✓	✓	✓	✓	✓	✓	✓		
AC-UndershootArea	✓	✓	✓	✓	✓	✓	✓	✓		
InputSlew-Diff-Fall(CK)		✓	✓	✓			✓	✓		
InputSlew-Diff-Rise(CK)		✓	✓	✓			✓	✓		
Slew Rate-Hold-Fall(Addr/Cmd)		✓	✓	✓			✓	✓		
Slew Rate-Hold-Rise(Addr/Cmd)		✓	✓	✓			✓	✓		
Slew Rate-Setup-Fall(Addr/Cmd)		✓	✓	✓			✓	✓		
Slew Rate-Setup-Rise(Addr/Cmd)		✓	✓	✓			✓	✓		
tIH(base)	✓	✓	✓	✓		✓	✓			
tIH(base)CA								✓		
tIH(base)CS								✓		
tIH(derated)CA								✓		
tIH(derated)CS								✓		
tIPW-High(CA)								✓		
tIPW-High(CS)								✓		
tIPW-Low(CA)								✓		

Measurements	DDR ++	DDR2	DDR3	DDR3L	DDR4	LPDDR ++	LPDDR2	LPDDR3	GDDR3 ++	GDDR5
tIPW-Low(CS)								✓		
tIS(base)CA								✓		
tIS(base)CS								✓		
tIS(derated)CA								✓		
tIS(derated)CS								✓		
tIS(base)	✓	✓	✓	✓		✓	✓			
tIS(derated)		✓	✓	✓			✓			
tIH(derated)		✓	✓	✓			✓			
tIPW-High	✓	✓	✓	✓	✓	✓	✓			
tIPW-Low	✓	✓	✓	✓	✓	✓	✓			
tDIPW										✓
tCMDS										✓
tCMDH										✓
tCHDPW										✓
tAS										✓
tAH										✓
tAPW										✓
WCK (Differential)										
tWCK-Rise-Slew										✓
tWCK-Fall-Slew										✓
tWCK-TJ										✓
tWCK-DJ										✓
tWCK-RJ										✓
VWCK-Swing										✓
tDVAC(WCK)										✓
tWCK										✓
tWCKH										✓
tWCKL										✓
tWCKHP										✓
SSC Downspread (WCK)										✓
SSC Mod Freq (WCK)										✓
SSC Profile(WCK)										✓
WCK (Single Ended)										
VIN(WCK)										✓
VIN(WCK#)										✓
VIX(AC)WCK										✓

Measurements	DDR ++	DDR2	DDR3	DDR3L	DDR4	LPDDR ++	LPDDR2	LPDDR3	GDDR3 +-	GDDR5
VOL(WCK)										✓
VOH(WCK)										✓
VOL(WCK#)										✓
VOH(WCK#)										✓
WCKSlew-Rise(WCK)										✓
WCKSlew-Rise(WCK#)										✓
WCKSlew-Fall(WCK)										✓
WCKSlew-Fall(WCK#)										✓
Refresh										
tCKSRE										✓
tCKSRX										✓
tRFC										✓
tXSNRW										✓
tREFTR(Write)										✓
tREFTR(Read)										✓
Power Down										
tPD										✓
Active										
tRC										✓
tRAS										✓
tRCDRD										✓
tRCDWR										✓
Precharge										
tPPD										✓
tRP							✓			
tRP(ACT)			✓						✓	✓
tRP(MRS)		✓	✓							✓
tRP(REF)		✓								✓

Measurements	DDR †	DDR2	DDR3	DDR3L	DDR4	LPDDR ††	LPDDR2	LPDDR3	GDDR3 †	GDDR5
tRP(SRE)										↗
tRTPL										↗

‡ The clock measurements displayed for LPDDR and DDR standards are tCH, tCK, tHP, and tCL.

† The application displays a hint on selecting GDDR3 as the standard: "GDDR3 not completely supported. Some features may not function".

Derating

Signal slew rate derating is required to verify the setup and hold timing requirements on address/command and data signals. The base setup and hold limits are defined using input signals that have a 1.0 V/ns slew rate. To determine final pass/fail status, the limits must be adjusted based on the actual slew rates of the target signals, according to derating tables appearing in the DDR2 and DDR3 specifications.

DDR2 derated measurements for data signals are as follows:

- tDS-SE(derated)
- tDH-SE(derated)
- tDS-Diff(derated)
- tDH-Diff(derated)

DDR3 derated measurements are as follows:

- tDS-Diff(derated)
- tDH-Diff(derated)

The DDR2/DDR3 Address/Command derated measurements are as follows:

- tIH(derated)
- tIS(derated)

The derated value (Δ) is calculated as per the JEDEC standard using either the DDR Method or Nominal Method, depending on the user configuration.

Derating is explained taking an example of Setup(tIS) measurement. The same concept is applicable for other derated measurements.

When the nominal method is set, Setup(tIS) nominal slew rate for a rising signal is defined as the slew rate between the last crossing of $V_{REF(dc)}$ and the first crossing of $V_{IH(ac)min}$. Setup (tIS) nominal slew rate for

a falling signal is defined as the slew rate between the last crossing of $V_{REF(dc)}$ and the first crossing of $V_{IL(ac)max}$.

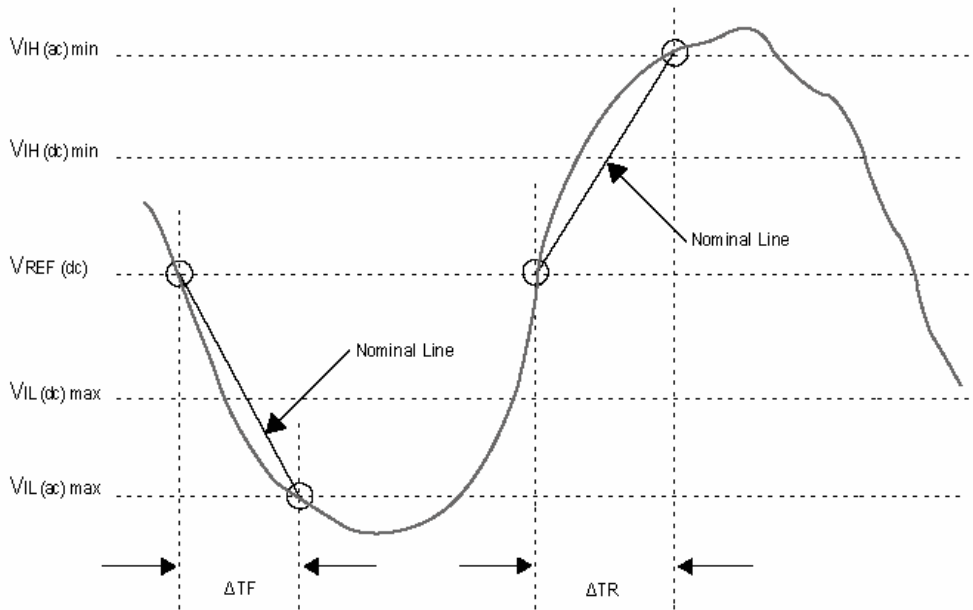

If the DDR Method is set, the application takes the maximum slope. This method is applicable if the actual signal is earlier than the nominal slew rate line.

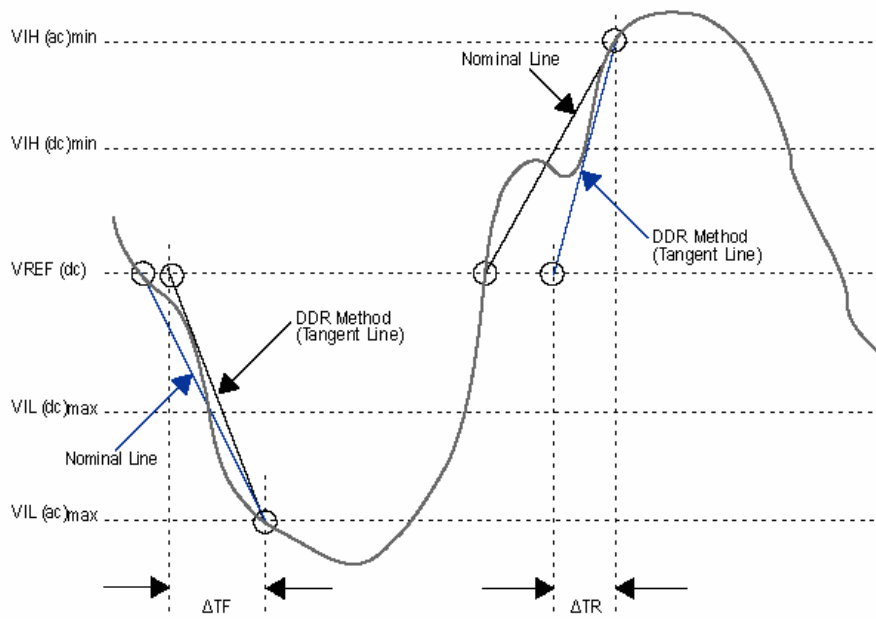

According to the specified reference levels, rise slew rate is always positive whereas fall slew rate is negative. A single slew rate value is obtained by averaging the absolute values of rise and fall slew rate. Using this value and a similarly-derived slew rate for the clock signal, the total setup time (tIS) is calculated by adding ΔtIS to the tIS(base)limit from the following table:

Table 5: Address/Command Setup and Hold Values

Units(ps)	DDR3–800	DDR3–1066	DDR3–1333	DDR3–1600	Units
tIS(base) AC 175	200	125	65	45	ps
tIS(base) AC150	350	275	190	170	ps
tH(base)	275	200	140	120	ps

NOTE. For DDR3 speeds 1333 and 1600 MT/s, the AC 150 reference levels are applied, though the default selection in the Step 6 (see page 51) is AC175.

ΔtIS is determined using the derating table (AC 175 (see page 53)), where the Y-axis represents the Address/Command slew rate and the X-axis, the clock differential value. By indexing the Address/Command value and Clock differential value, ΔtIS value is obtained from AC175 table.

The calculated slew rate is approximated to the derating table specified value (Example: 0.4 V/ns ≈ 1.0V/ns). For values greater than 4.0 V/ns, the table returns the base limit value.

For example: For a Clock differential value= 1.0 V/ns, Address/Command Slew Rate =1.0 V/ns, and AC 175 Threshold selected in Step 6 (see page 51), the resulting derated values are:

$$tIS_{\text{deratedlimit}} = tIS(\text{base})_{\text{limit}} + \Delta tIS.$$

$$tIS_{\text{deratedlimit}} = 200 + 40 = 240$$

The result statistics of the both tIS(base) and tIS(derated) are the same as shown in the following figure. In case of derating, the limit values get changed depending on the signal slew rate.

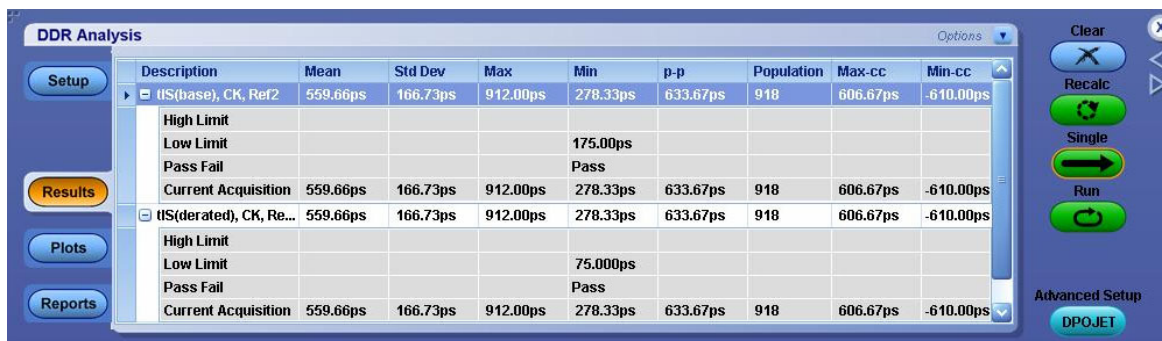

Reference

- [DDR3 Measurement Sources \(see page 100\)](#)
- [DDR2 Measurement Sources \(see page 89\)](#)

About DDR Analysis

The DDR Analysis window allows you to select various standards, set up and run a pre-configured measurement either through the DDRA or the DPOJET application.

Select **Analyze > DDR Analysis** to open the DDRA application.

The setup panel in the DDR Analysis application includes the following steps:

- [Generation, Rate and Levels \(see page 31\)](#)
- [Interposer Filter \(see page 34\)](#)
- [Measurements and Sources \(see page 35\)](#)
- [Burst Detection Method \(see page 40\)](#)
- [Burst Detection Settings \(see page 40\)](#)
- [Thresholds and Scaling \(see page 51\)](#)

NOTE. You can use the Next/Prev buttons or click directly on the step numbers to traverse through the steps in the DDR Analysis. The steps for which configuration is complete are denoted .

The setup panel displays hints to help you understand the configuration options wherever applicable.

You can run a set of measurement in either of the two ways:

- Click **Run** to start the acquisition sequence using the selected settings and to view the results in the DDRA window. This is the normal way to generate results.



- Click  to move to the DPOJET application, where you can add or modify measurements before sequencing. For more details, refer to the DPOJET Online Help. You need to



click  in the DPOJET application to return to the DDRA window. Alternatively, you can reselect **Analyze >DDR Analysis** from the menu bar.

Step1: Generation, Rate and Levels

Select the DDR generation, data rate and the voltage levels (if required). There are different [speed bins](#) for each standard data rate for specific DDR generations.

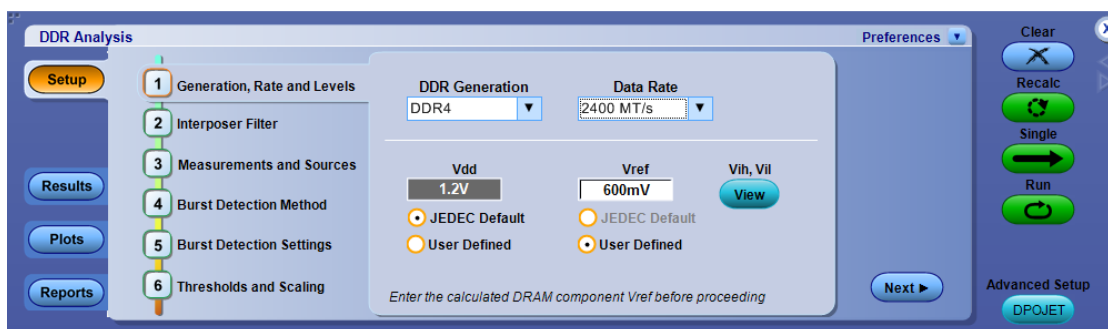

1. Select the DDR Generation from the drop-down list.
2. Select the Data Rate from the drop-down list. On selecting Custom, an edit box allows you to enter the value using the virtual keypad. Limit files are not defined for custom data rates for Pass/Fail status and as a result the application displays a hint at the bottom of the screen “Please provide a limits file under Jitter and Eye > Limits”. Note that selecting non-standard data rates in ASM (under Search > DDR Read or DDR Write), changes the data rate to “None” in DDRA.
3. Set the voltage levels:
 - If you select JEDEC Defaults, the application uses the nominal voltage levels according to the JEDEC specification.
 - If you select User Defined, enter the [Vdd \(see page 31\)](#) or [Vref \(see page 31\)](#) voltage values using the virtual keypad.
4. (Optional) Click **View** to view the [Vih \(see page 34\)](#) and [Vil \(see page 34\)](#) values calculated automatically based on the Vref value. To manually adjust the reference levels, go to [Step6 \(see page 51\)](#) of DDRA or use the DPOJET source configuration panel.

Vdd

Is the supply voltage for each DDR standard. Vdd is based on DDR generation.

Vref

Is the reference voltage for each DDR standard. Vref is calculated using Vdd, which in turn is based on DDR generation. In most cases, $V_{ref}=0.5V_{dd}$.

The following table lists the minimum and maximum values of Vdd and Vref in the **User Defined** mode for all DDR generations:

DDR Generations	Vdd			Vref		
	Default	Min	Max	Default	Min	Max
DDR‡	2.5 V	-6 V	6 V	1.25 V	-6 V	6 V
DDR2	1.8 V	-6 V	6 V	900 mV	-6 V	6 V
DDR3	1.5 V	-6 V	6 V	750 mV	-6 V	6 V
DDR3L	1.35 V	-6 V	6 V	675 mV	-6 V	6 V
DDR4	1.2 V	-6 V	6 V	600 mV	-6 V	6 V
LPDDR	1.8 V	-6 V	6 V	900 mV	-6 V	6 V
LPDDR2	1.2 V	-6 V	6 V	600 mV	-6 V	6 V
LPDDR3	1.2 V	-6 V	6 V	600 mV	-6 V	6 V
GDDR3	1.8 V	-6 V	6 V	900 mV	-6 V	6 V
GDDR5	1.5 V	-6 V	6 V	750 mV	-6 V	6 V

‡ DDR 400 MT/s has Vdd value set to 2.6 V and Vref Value set to 1.3 V.

NOTE. If you select *Manual Threshold Settings* in [Step 6](#) and then subsequently choose user-defined Vdd or Vref voltages in [Step 1](#), the following message is displayed “You have selected manual control of measurement thresholds in Step 6. Please verify that they are appropriate for these settings”. This is because the Vref voltage is normally used to determine the proper high, mid, and low thresholds. If these thresholds are under manual control, there is no point in manually setting Vref.

Vdd and Vref

The configured values of Vdd and Vref are used to calculate $V_{IH(ac)min}$, $V_{IH(dc)min}$, $V_{IL(dc)max}$ and $V_{IL(ac)max}$, which are applied on the input signal. These levels are further used for calculating Setup and Hold measurements.

For DDR2, the relationship between Vdd and Vref is as shown in the following tables:

Table 6: Input DC logic Level

Symbol	Parameter	Min	Max	Units
$V_{IH(dc)}$	DC input logic high	Vref+0.125	–	V
$V_{IL(dc)}$	DC input logic low	–0.3	Vref–0.125	V

Table 7: Input AC logic Level

Symbol	Parameter	DDR2–400, DDR2–533		DDR2–667,DDR2–800		Units
		Min	Max	Min	Max	
$V_{IH(ac)}$	AC input logic high	Vref+0.250	–	Vref+0.200	–	V
$V_{IL(ac)}$	AC input logic low	–	Vref–0.250	–	Vref+0.200	V

NOTE. Similar reference voltage levels are defined for DDR3 standard.

Speed Bins

For each DDR standard, the DDRA application automatically applies limits appropriate for the standard data rates without speed bins. Limit values are different for different speed bins. If you want to test according to a speed bin, you must manually configure the limit values from within DPOJET by manually overriding the limit file before running the measurements.

For more details, refer to the topic “**Limits**” of the DPOJET help.

The following table lists the speed bins available for which pre-configured limit files are provided:

DDR Generation	Speed bins
DDR-400	400A, 400B and 400C
DDR2	
DDR2-667	800C and 800D
DDR2-800	800C, 800D and 800E
DDR3	
DDR3-800	800D and 800E
DDR3-1066	1066E, 1066F and 1066G

DDR Generation	Speed bins
DDR3-1333	1333F*, 1333G, 1333H and 1333J*
DDR3-1600	1600G†, 1600H, 1600J and 1600K†

* 1333F and 1333J are optional

† 1600G and 1600K are optional

NOTE. You can find limit files for various speed bins at *C:\TekApplications\DDRA\Limits*. You need to manually select these limit files by clicking *Analyze > Jitter and Eye Analysis > Preferences > Limits*.

Vih
Is the input logic HIGH voltage.

Vil
Is the input logic LOW voltage.

Step2: Interposer Filter

Select interposer and its probing configuration for CLK and DQS signal. When interposer filters are applied, MATH cannot be used as the measurement source in Step 3. The filter file will be applied when the scope acquisition sample rate is supported in the filter file. You can also specify a user-defined filter file by selecting the “User Defined” option from the drop-down list.

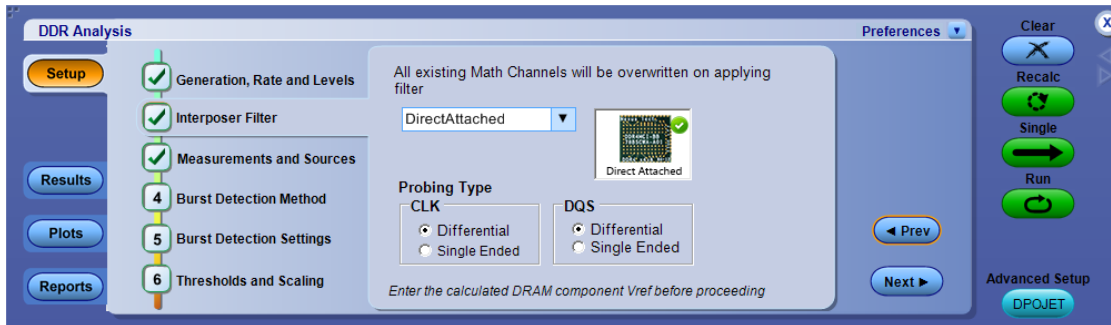

Step3: Measurements and Sources

Select measurements and their corresponding [sources \(see page 39\)](#) in this step. Measurement availability depends on the selected DDR standard. Select the **Measurement Type** (Read Bursts, Write Bursts, Clock(Diff), Clock(Single Ended), Address/Command, Address/Command, DQS(Single Ended), WCK(Single Ended), WCK(Diff), Refresh, Power Down, Active, or Precharge) from the drop-down list. WCK(Single Ended), WCK(Diff), Refresh, Power Down, Active, or Precharge are only available for GDDR5. Power Down, Active, and Precharge are only available 64-bit instruments. A message prompts you to select one or more measurements before moving to the next step.

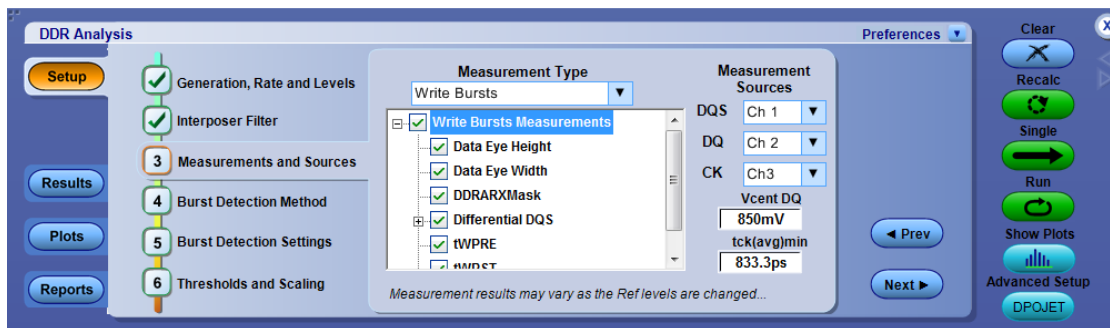

Measurement Type Reference Levels

The voltage reference levels for each measurement are automatically set to be consistent with JEDEC guidelines unless they are manually overridden. In cases where none of the chosen measurements have any applicable guidelines or manually set levels, DDRA will automatically choose reference levels based on the signal's maximum and minimum levels. DDRA displays a hint if both Single Ended DQS and Differential DQS measurements are selected at the same time, and measurements made with this configuration may not be accurate due to conflicting ref level requirements. When two or more measurements are selected in different sub-node categories under a Measurement Type the following precedence is set for measurement ref levels:

- Slew Rate ref levels
- Single Ended specific ref levels
- Differential specific ref levels

For Example: When Eye Width measurement is selected along with Differential DQS or Single Ended DQS or Slew Rate measurements, Eye measurement may not produce the expected results. This is because the actual mid level needed by Eye Width gets overwritten with SE levels and hence produces no results.

Tree Structure Flow

The measurement tree structure is as follows:

- The tree structure displays only those measurements appropriate for the selected measurement type.

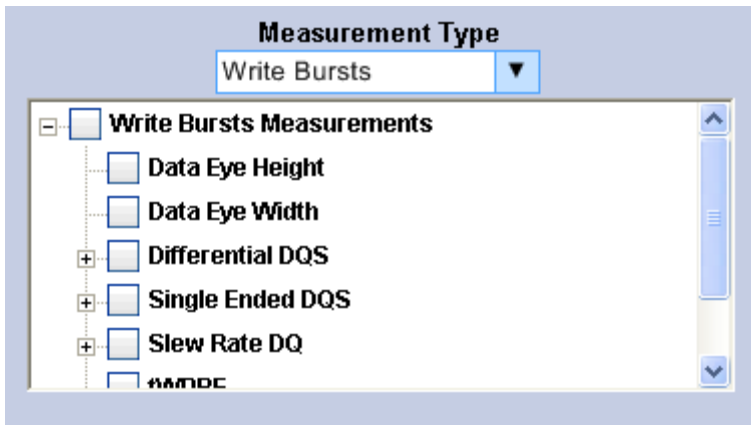

- All generations except GDDR3 display both parent and nested elements under measurement type (such as tERR) as shown:

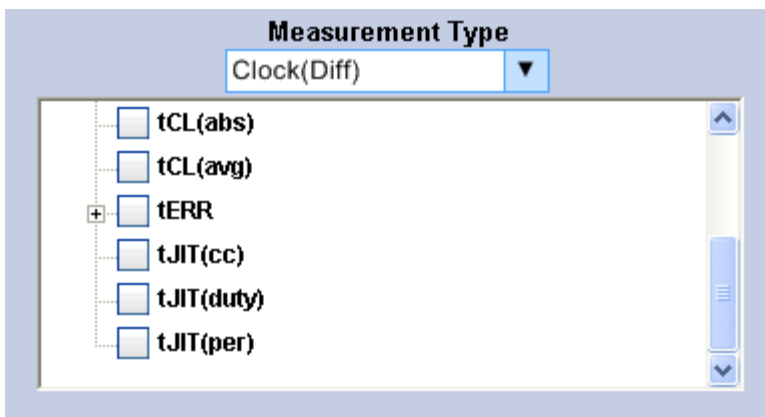

- Click to expand and show the elements within the parent element.
- Click to collapse and hide the elements within the parent element.

- Selecting the parent check box, selects all the children elements. Selecting all the children elements, selects the parent element.

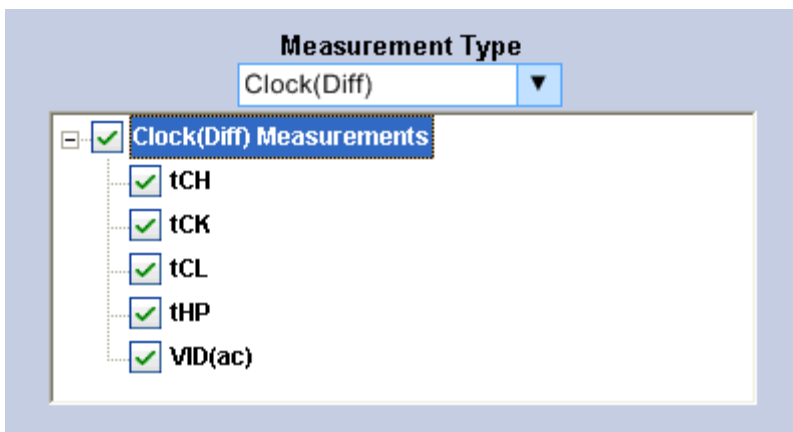

- Clearing the parent check box clears all the children elements.
- When the children include both checked and unchecked elements, the parent element becomes highlighted as shown:

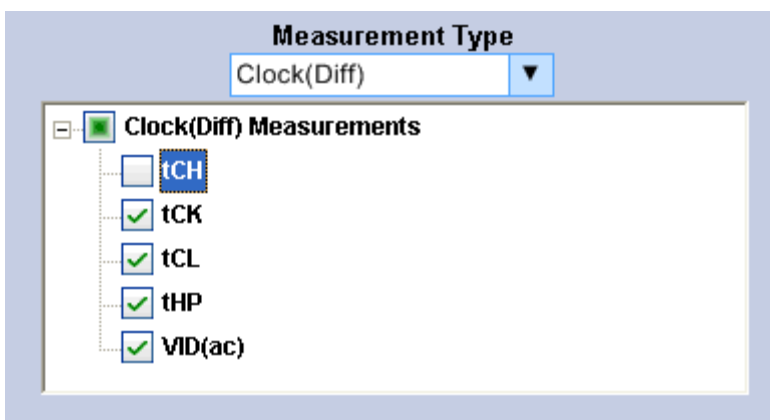

NOTE. *If you move to the next step without selecting any measurements, the application displays the message “Please select measurements in Step3”.*

Measurement Selection Based on Signal Type

The application adds the suffix SE (Single-ended) or Diff (Differential) for relevant measurements depending on the signal type.

- If your signal type is differential, the measurements with suffix **Diff** should be selected and those with SE should be deselected. The signal should be probed with a differential probe. If only one leg of a differential signal is probed (using a single-ended probe), the automatically-configured reference levels will not be correct. This can be resolved by using a Math waveform as the source, and defining the Math so that the single-ended signal is centered around 0 V. This will not be a proper JEDEC-compliant measurement but it will allow the measurements and/or eye diagram to function.
- If your signal type is single-ended, the measurements with suffix **SE** should be selected and those with Diff should be deselected. Some measurements on differential signals demand that the two legs of the differential signal be separately probed with single-ended probes. These measurements are placed in measurement types that segregate them from measurements made with a differential probe.

NOTE. The application displays a hint “Cannot select Diff and SE measurements at the same time” when measurements with suffix SE and Diff are selected together under Write Bursts.

Timing error (tERR) measurements

Timing error measurements for the DDR3 generation such as tERR(2per), tERR(3per) until tERR(50per) are grouped together and included as a nested element (tERR) under the parent element, Clock(Diff)measurements. Selecting tERR selects all the timing error measurements.

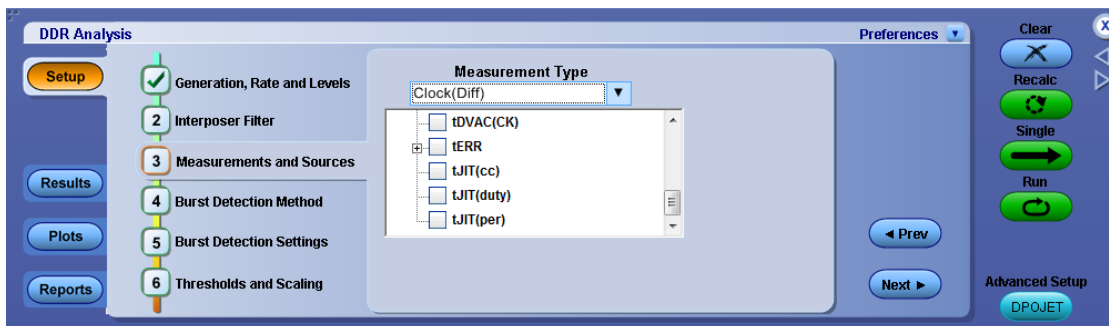

Sources

Select a measurement to view the sources available for the measurement. The sources are mutually exclusive. For each required signal, select the appropriate source. A tool tip displays the required sources for the selected measurement at the nodes of the measurement tree. A maximum of four analog sources are available at a time.

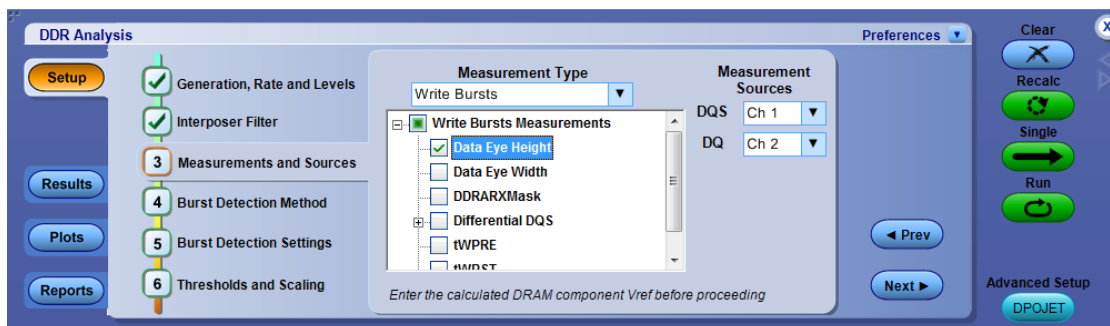

NOTE. If the same channels are used for DQ/DQS/Clock sources (Example: DQ=Ch1, DQS=Ch1), the application displays a hint “Cannot use the same waveform for different sources”. If Live and Ref channels are used together (Example: Ch1 for DQS and Ref2 for DQ), the application displays a hint “Cannot use Live and Ref waveforms together”.

Reference

- [Hints \(see page 56\)](#)
- [LPDDR Measurement Sources \(see page 75\)](#)
- [LPDDR2 Measurement Sources \(see page 77\)](#)
- [DDR Measurement Sources \(see page 86\)](#)
- [DDR2 Measurement Sources \(see page 89\)](#)
- [DDR3 Measurement Sources \(see page 100\)](#)
- [GDDR5 Measurement Sources \(see page 104\)](#)

Step4: Burst Detection Method

Burst Detection is based on the measurement type and generation, and is applicable only for Write Bursts, Read Bursts, and DQS(Single Ended) measurement types.

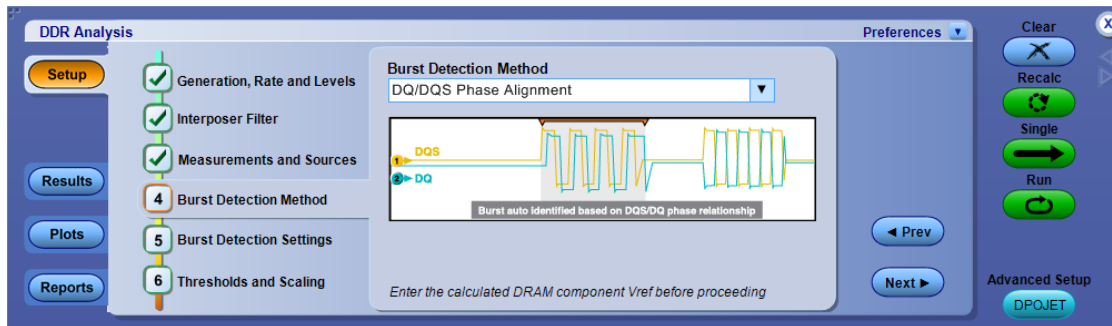

The application supports the following burst detection methods for DPO/DSA/MSO oscilloscopes:

- [DQ/DQS Phase Alignment \(see page 41\)](#)
- [Chip Select, Latency + DQ/DQS Phase Alignment \(see page 43\)](#)
- [Logic State + Burst Latency \(see page 44\)](#) (Available only for MSO series of oscilloscopes)
- [Visual Search \(see page 47\)](#)

Reference

- [Hints \(see page 56\)](#)

Step5: Burst Detection Settings

Displays the settings based on the burst detection method:

- [DQ/DQS Phase Alignment \(see page 41\)](#)
- [Chip Select, Latency+ DQ/DQS Phase Alignment \(see page 43\)](#)
- [Logic State + Burst Latency \(see page 44\)](#) (Available only for MSO series of oscilloscopes)

DQ/DQS Phase Alignment

Select the burst detection method as shown:

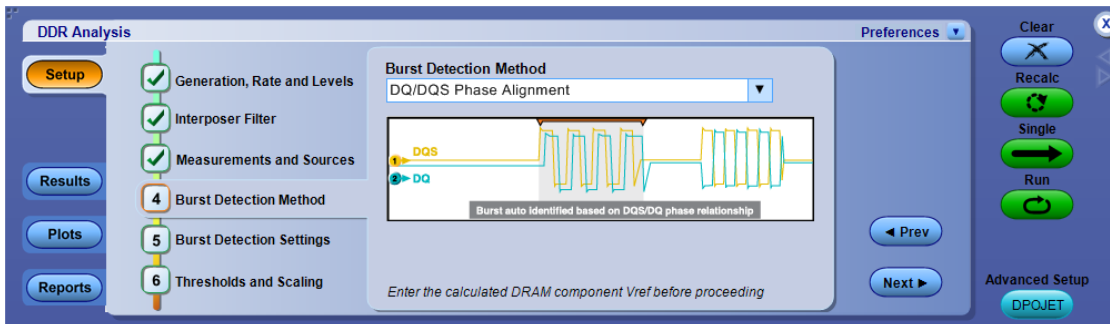

The DQ/DQS levels indicator shows "Auto" when both Strobe/Data and Edge detection hysteresis are set to Auto. If one of the options is Manual, then the DQ/DQS levels shows as Manual. Click **Settings** tab to set advanced burst detection parameters.

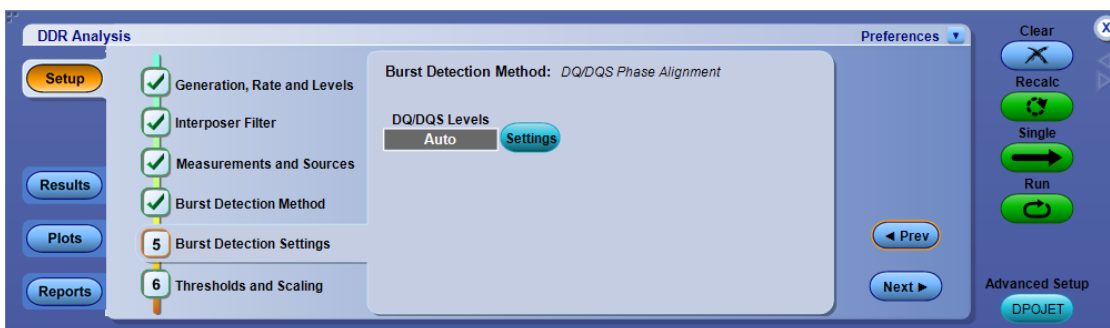

The burst detection settings panel controls how data bursts are identified within a waveform that includes tri-state levels. For appropriately-probed signals with good signal fidelity, no adjustment to the default values should be required. For signals with poor fidelity or unusual properties, burst detection can be improved by switching to Manual control and adjusting the detection levels.

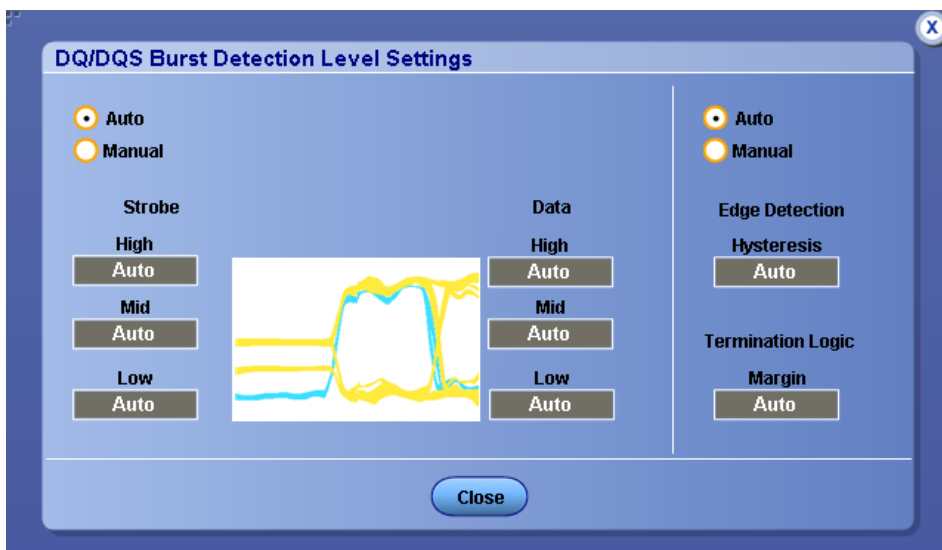

NOTE. The High/Mid/Low levels used for burst detection have no relationship to the reference levels used for measurement points. The measurement thresholds are defined in [Step 6 \(see page 51\)](#).

1. Select the type of burst detection level for the search.
 - If you select Auto, the application calculates these levels for you . It is recommended unless you find that manual levels are necessary for reliable detection.
 - If you select Manual, enter both the Strobe and Data reference levels for the signal (High, Mid, and Low). As you adjust the detection levels, observe the search-and-mark sprites that appear above the waveform. These sprites are dynamically updated as you adjust the levels, helping you to identify levels that properly delimit the selected burst type.
2. These settings need not be changed in most cases:
 - **Edge Detection Hysteresis:** This control configures the internal edge finder's hysteresis band which is used to detect read or write bursts. In the event of noisy inputs, it can be increased to correct marks which may be larger than appropriate.
 - **Termination Logic Margin:** This control can be increased to help in terminating marks on back-to-back writes in cases where otherwise a continuous strobe would cause a write-mark to merge two back-to-back writes.

Chip Select, Latency + DQ/DQS Phase Alignment

1. If you wish to filter the data bursts based on a CS Source signal, select the [CS Source \(see page 43\)](#) using the CS Source drop-down. Select [CS Active \(see page 43\)](#) and [CS Mode \(see page 44\)](#) as shown in the following figure. CS source is available only for Read and Write bursts measurements.



NOTE. If a CS source is selected, CS-DQS(Strobe) is used for signal separation otherwise DQS(Strobe)-DQ(Data) is used. You must configure DQ source to enable Search and Mark.

CS Source

CS Source is used as a logic input to select read or write bursts corresponding to the chip select signal. When a chip-select signal source other than none is specified, reads or writes will only be shown when the chip-select source is active.

CS Active

Selects whether the chip-select source logic is considered active high or active low.

CS Mode

CS Mode consists of two modes – Auto and Manual. CS Auto mode calculates the level automatically for you (as half the peak-to-peak voltage), while manual mode allows you to specify a CS level. In cases where an entire acquisition could occur with no transitions on the chip-select line, you must select the manual mode to set the correct logic level.

Logic State + Burst Latency

This burst detection method is available only on MSO series of oscilloscopes. You can configure the logic state, burst latency, tolerance, burst length, and DQ/DQS levels.

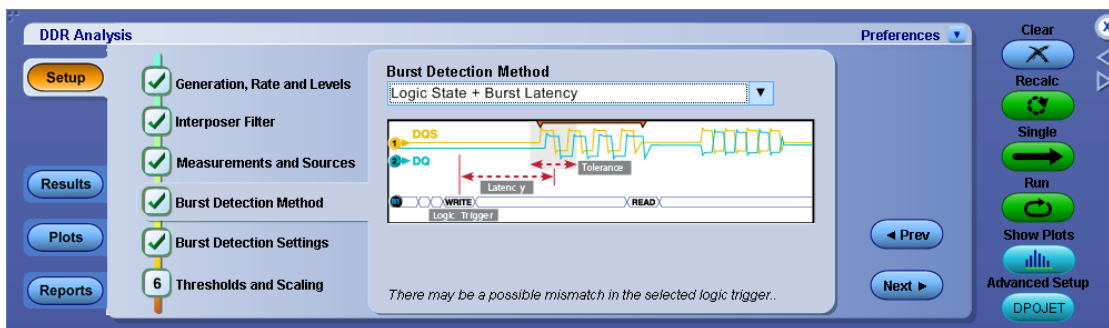

The DDRA application provides a shortcut, **Bus Setup**, to configure the bus in the oscilloscope bus setup window. Click **Bus Setup** in Step 5 to view the Bus setup screen as shown

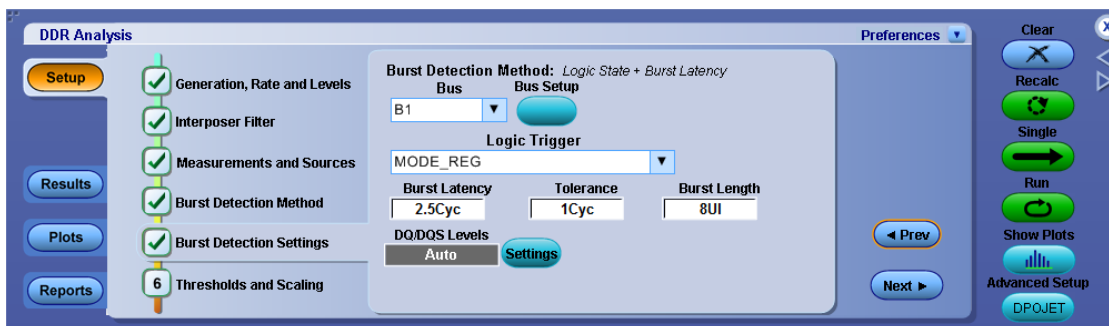

NOTE. For more details, refer to “Bus Setup Control Window (Select Tab)” section in your oscilloscope online help.

DDRA application lists the buses defined in the bus setup menu. For DDRA to use the logic bus for read/write burst detection, it must have an associated [symbol file \(see page 46\)](#).

By default, the DDRA application displays the symbol file that corresponds to the selected DDR generation in Step 1 (see page 31). Click **Browse** to select a symbol file of your choice. On selecting the symbol file, the Logic trigger lists the available patterns as shown. The symbol files per generation are located at C:\TekScope\busDecodeTables\DDR.

NOTE. For 64-bit systems, the DDRA installer copies the symbol files into the following location: C:\Users\Public\Tektronix\TekScope\BusDecodeTables\DDR. This is different from the default TekScope location at C:\Users\[Username]\Tektronix\Tekscope\BusDecodeTables.

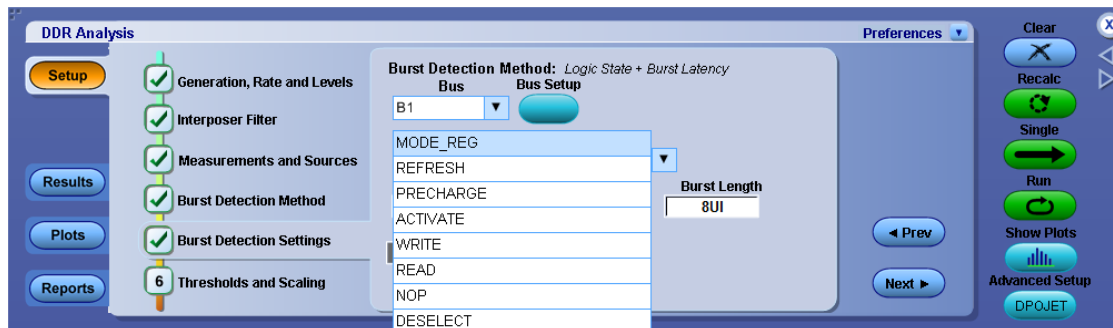

Edit/customize the symbols based on your requirements and save it in *.tsf format. Place the created symbol files for access at C:\TekScope\busDecodeTables\DDR. Use Bus setup config menu or browse (Step 5) to access the created symbol file. A sample file for DDR3 is as shown:

Symbol	Pattern
MOD_REG	0000
REFRESH	0001
PRECHARGE	0010
ACTIVATE	0011
WRITE	0100
READ	0101
NOP	0111
DESELECT	1XXX

The DDRA application displays a hint “There may be a possible mismatch in the selected logic trigger and the measurement type. Please verify before continuing” when you select a logic state of READ and the measurement type selected is WRITE or vice versa.

NOTE. Any change in the symbol file in the DDRA application, is reflected in the oscilloscope bus configuration menu. The symbols of interest for DDRA are READ and WRITE patterns.

Symbol File

Symbol files are files of alphanumeric symbol names and associated data values, and are used to map a group value to a text string. The oscilloscope displays the symbol in place of the numeric value. For more details on symbol file format, refer to your oscilloscope online help .

Specify the [Burst Latency, Tolerance \(see page 46\)](#), and [burst length \(see page 47\)](#) values.

CAS Min and Max

For READ commands, Read Latency (RL) is defined as the delay, in clock cycles, between the rising CLK edge that latches the READ command and the rising DQS edge signifying availability of the first data bit. The Read Latency is equal to the additive Latency and the CAS Latency ($RL = AL + CL$). CAS Min specifies the minimum time delay between the start of READ bus state and the initial rising DQS edge, for the first bit to be recognized. CAS Max specifies the maximum time delay between the end of the READ bus state and the initial rising DQS edge, for the first bit to be recognized. In the following figure, the actual READ latency is 2 and the CAS Min and CAS Max are set to 2. The green zone indicates where the initial rising DQS edge must be for burst recognition to occur.

For WRITE commands, Write Latency (WL) is defined as the delay, in clock cycles, between the rising CLK edge that latches the WRITE command and the rising DQS edge in the center of the first data bit. The Write Latency is equal to the Additive Latency and the CAS Write Latency ($WL = AL + CWL$). As with the READ case, the CAS Max and CAS Min parameters define a window following the WRITE bus state where the initial rising DQS edge must be for burst recognition to occur.

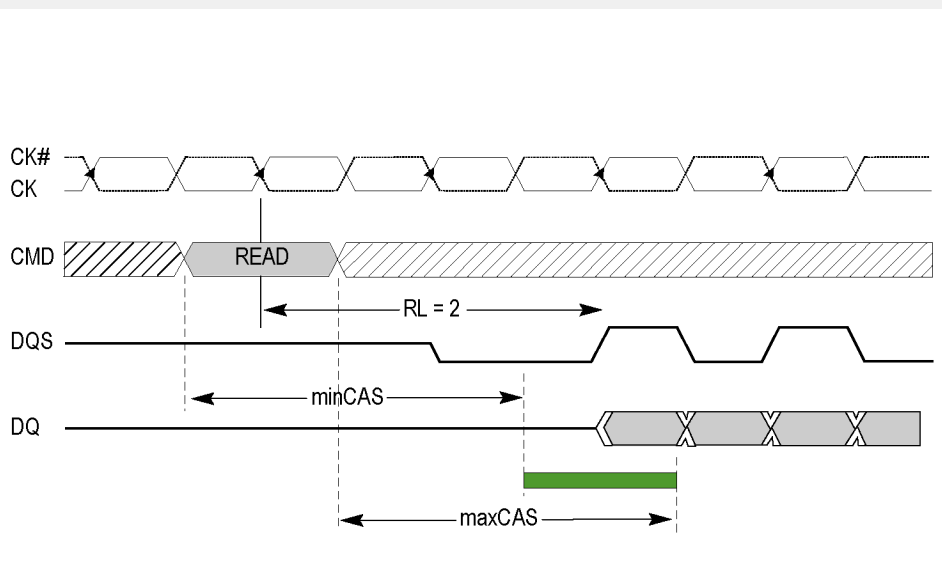

Burst Length

READ and WRITE operations are burst oriented, they start at a selected location, and continue for a burst length. Burst length, specified in cycles, determines where a read/write mark ends after the start of a read/write mark has been identified. Any change in DDR generation resets the burst length to 8.0.

Reference

- [Salient Features of MSO-DDR Integration \(see page 60\)](#)
- [Using Digital Channels \(see page 118\)](#)

Visual Search

Capturing and analyzing the right part of the waveform can require hours of collecting and sorting through the many acquisitions. The Visual Trigger feature in the oscilloscope makes the identification of the desired waveform events quick and easy by scanning through acquired analog waveforms and graphically comparing them to geometric shapes on the display. By discarding acquired waveforms which do not meet the graphical definition, Visual Triggering extends the trigger capabilities of the oscilloscope beyond the traditional hardware trigger system.

In DDR, Visual Trigger can be used to separate Read bursts from Write Bursts and mark them. By selecting the Visual Search option in Step4: Burst Detection Method, these marked bursts can be used for further debugging and analysis.

Marking Read/Write bursts using visual trigger

Visual Trigger can also be used to mark all bursts which have a specific property (for example, marking a Read burst that has a spike just before it comes out of tri-state or marking a Write burst with a known data pattern). The figure below shows Visual Trigger that was used to mark (green marks) Write bursts with a known data pattern.

Along with the Visual search mark, Advanced search and mark (another feature in Tektronix oscilloscopes) has also been used to mark all the Write bursts (pink marks). Visual trigger has been used to isolate a burst with a specific data pattern, which allows the marked burst to be used for further debugging and analysis.

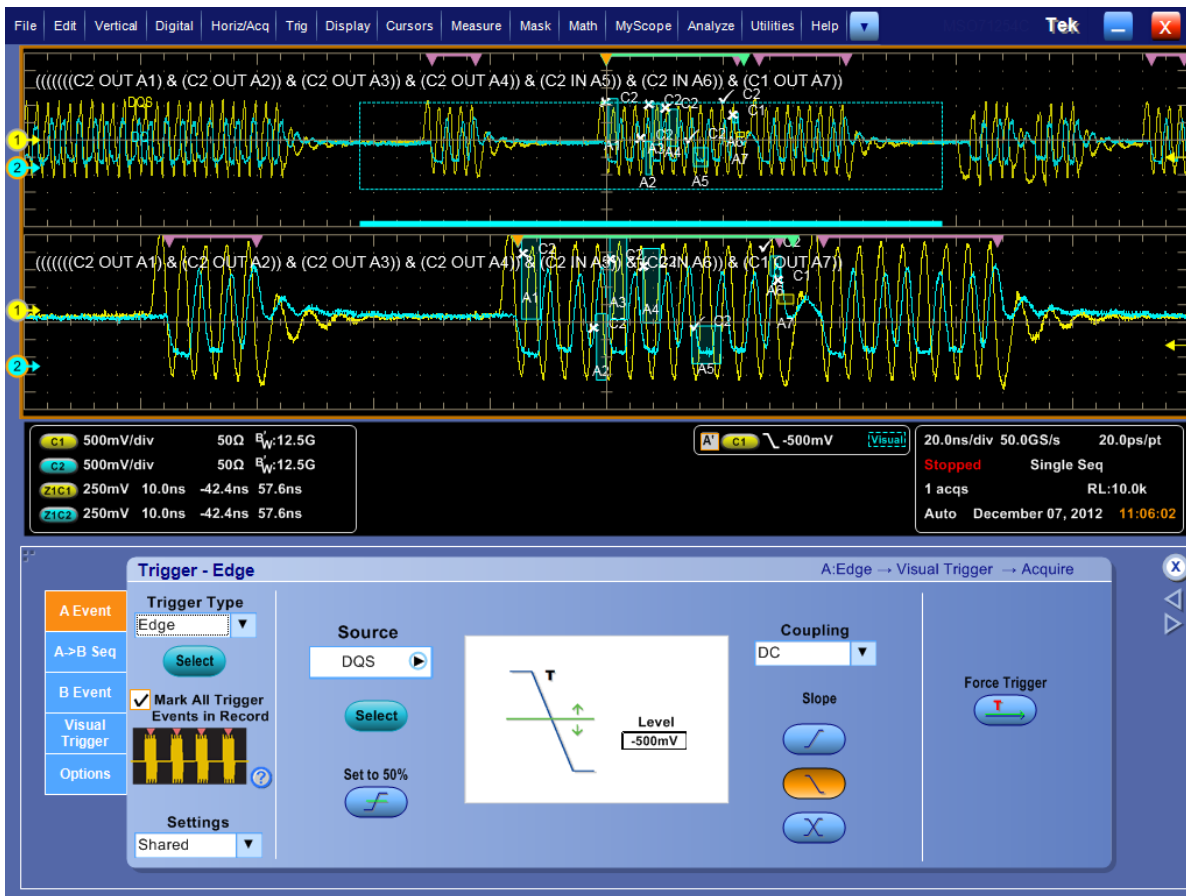

Isolating Read and Write bursts on the DDR3 bus using Visual trigger

DDR3 SDRAM is a high speed, dynamic random access memory internally configured as an eight bank DRAM. It can Read (fetch) and Write data as a burst operation. The burst length can be 4 clock cycles, 8 clock cycles, and can go up to 32 clock cycles so that it can fetch the data byte 1 to 8 bytes in a burst.

DDR3 defines the polarity of the Preamble different for Read and Write. For a Read burst, the Preamble would be negative polarity. For a Write burst, the Preamble would be positive polarity. For DDR3, the Read and Write Preamble widths are defined by parameters tRPRE and tWPRE in the JEDEC specification, and whose minimum value has been defined as 0.9 times that of the clock period.

Additionally, the phase between the Strobe signal (DQS) and Data Signals (DQ) are different for Read and Write. DQS and DQ are aligned for Read bursts and shifted by 90 degrees for Write bursts.

Isolating based on Preamble polarity and phase between DQS and DQ using Visual trigger

Figure 1 shows a screen capture of using Visual Trigger to isolate Read signals based on Preamble polarity and phase difference between the DQS and DQ signals. Channel 1 of the oscilloscope is DQS and Channel 2 is DQ. Areas A1 and A2 are set so that when a signal is captured, there is no DQS signal in these regions. This ensures that the captured signal is coming out of tri-state. Area A3 is set to select the negative polarity of the Preamble. Areas A4 and A5 are set so that the DQ signal does not enter these regions, making sure that the DQS and DQ are aligned.

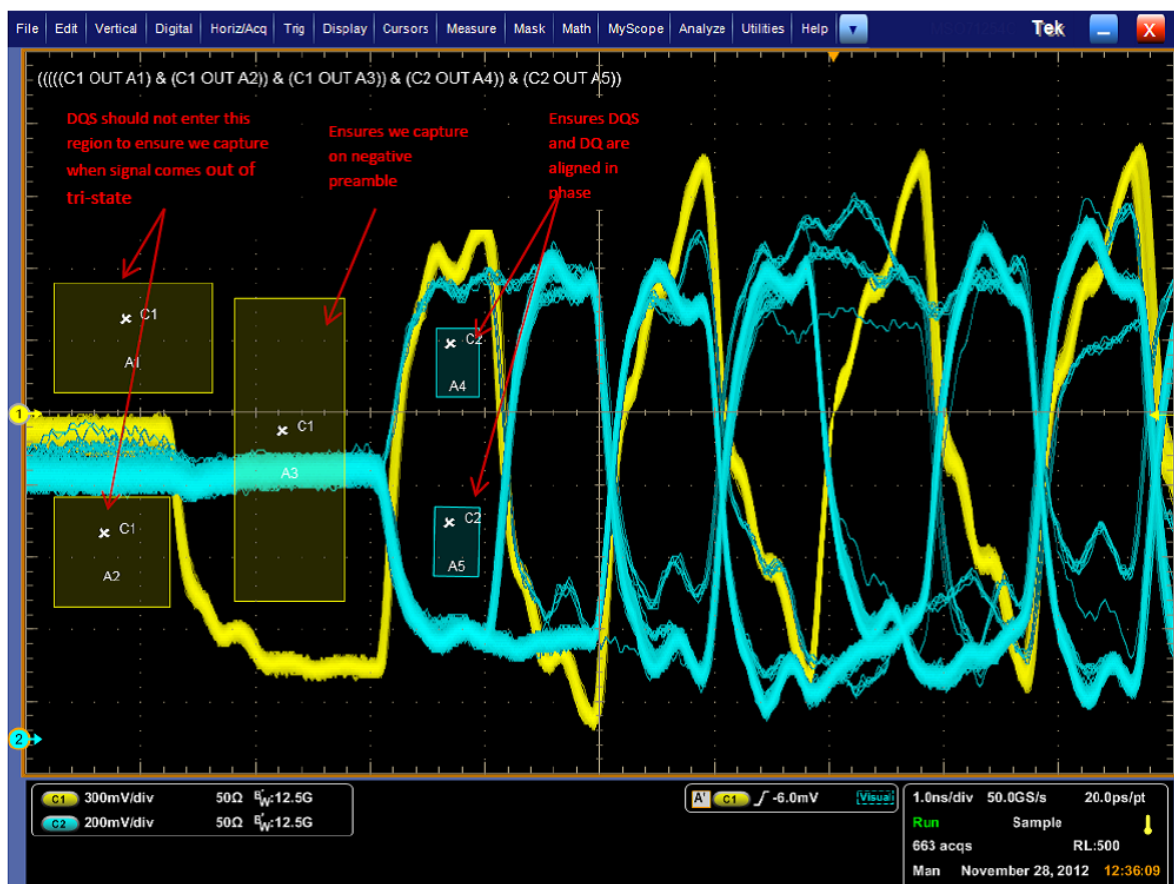

Read burst

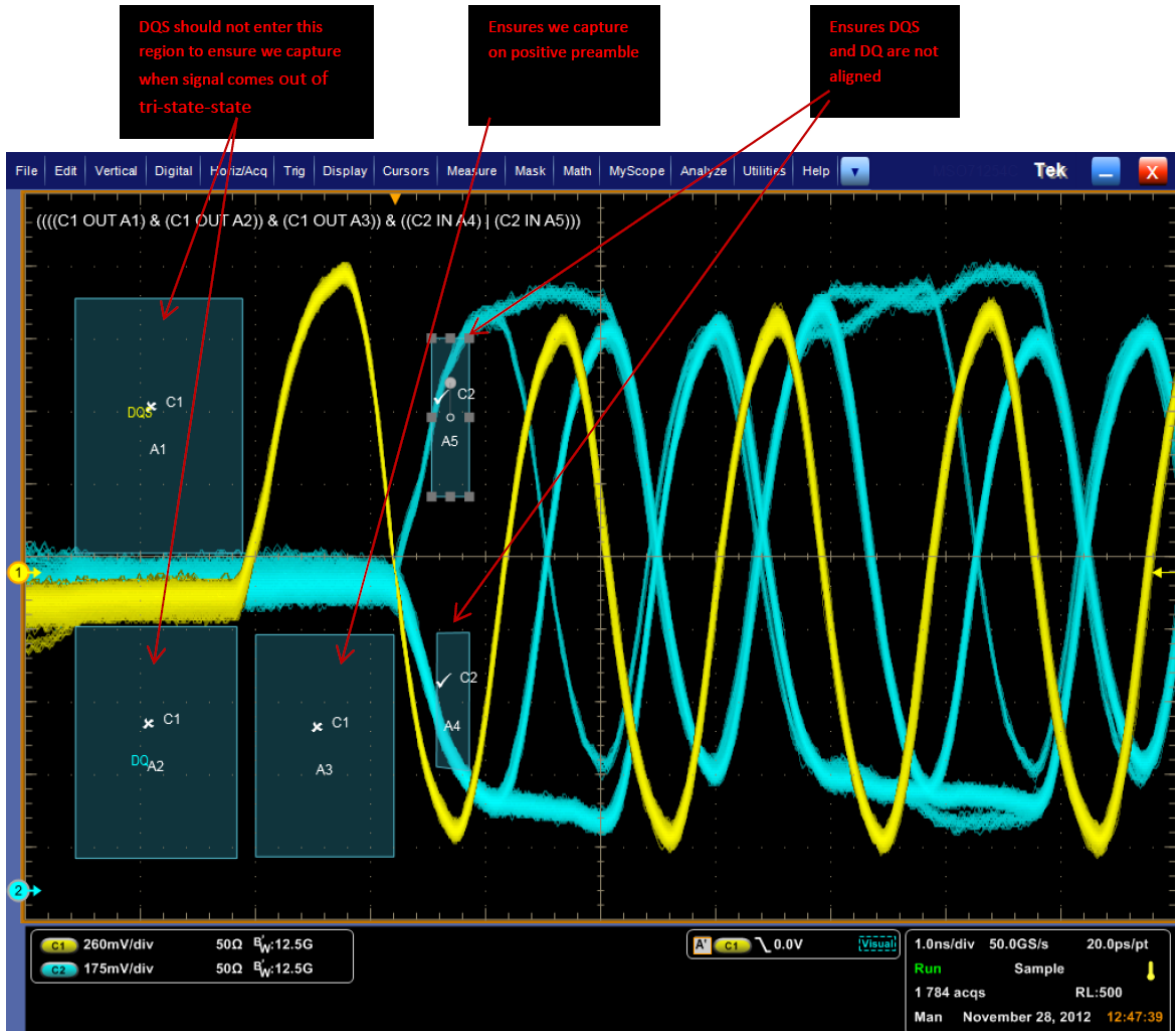

Write burst

Step6: Thresholds and Scaling

The left half of this panel controls selection of critical voltage thresholds used by the measurement algorithms. The right half determines whether scaling is automatically adjusted each time you sequence.

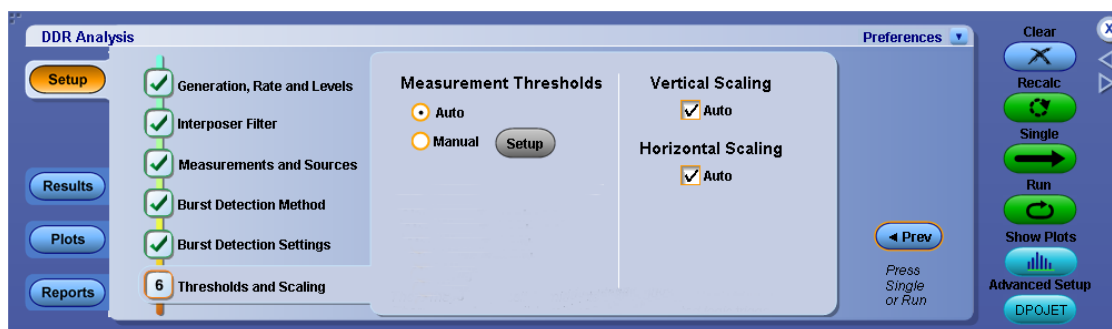

Measurement Thresholds

Select either Auto or Manual as the Measurement Threshold type.

- If you select Auto, the application calculates these levels for you based on the DDR generation and speed grade. It is recommended that you use this option.
- If you select Manual, set the [measurements levels](#) by clicking the **Setup** button.

For more details, refer to the topic “Ref Levels” of the DPOJET help.

NOTE. For every measurement selected in DDRA, appropriate reference levels are set in the DPOJET application. You can change these levels, if needed, from the DPOJET application.

Vertical Scaling

Selecting Auto performs autoset on the oscilloscope vertical settings only.

For more details, refer to the topic “Source Autoset” of the DPOJET help.

Horizontal Scaling

Selecting Auto performs autoset on the oscilloscope horizontal settings only.

For more details, refer to the topic “Source Autoset” of the DPOJET help.

NOTE. *If both Vertical and Horizontal are checked, the application performs autoset on both vertical and horizontal oscilloscope settings when Single/Run is selected.*

Alternate Thresholds

Alternate Thresholds only apply to the DDR3 Address and Command measurement type. It allows you to select derating values(Δ) from the derating tables— [AC 175 \(see page 53\)](#) and AC 150. The default is AC 175.

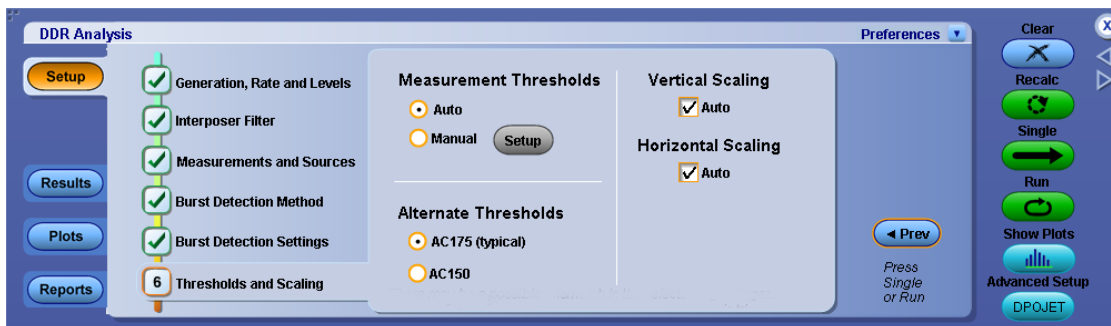

AC 175 . The AC 175 Threshold derating table is as follows:

Table 8: Derating Values for DDR3 800/1066/1333/1600 MT/s tIS/tIH

$\Delta tIS, \Delta tIH$ derating in ps AC/DC based
 AC 175 Threshold(VIH(ac))= VREF(dc)+175 mV, VIL(ac)=VREF(dc)-175 mV
 CK , CK# Differential Slew Rate

		4.0 V/ns		3.0 V/ns		2.0 V/ns		1.8 V/ns		1.6 V/ns		1.4 V/ns		1.2 V/ns		1.0 V/ns	
		$\Delta-$ t- I- S	$\Delta-$ t- I- H	$\Delta-$ t- I- S	$\Delta-$ t- I- H	$\Delta-$ t- I- S	$\Delta-$ t- I- H	$\Delta-$ t- I- S	$\Delta-$ t- I- H	$\Delta-$ t- I- S	$\Delta-$ t- I- H	$\Delta-$ t- I- S	$\Delta-$ t- I- H	$\Delta-$ t- I- S	$\Delta-$ t- I- H	$\Delta-$ t- I- S	$\Delta-$ t- I- H
		CMD/ ADDR Slew rate (v/ns)	2 . 0	8 8	5 0	8 8	5 0	8 8	5 0	9 6	5 8	1 0	6 6	1 1	7 4	1 2	8 4
	1 . 5	5 9	3 4	5 9	3 4	5 9	3 4	6 7	4 2	7 5	5 0	8 3	5 8	9 1	6 8	9 9	8 4
	1 . 0	0	0	0	0	0	0	8	8	1	1	2	2	3	3	4	5
	0 . 9	- 2	- 4	- 2	- 4	- 2	- 4	6	4	1	1	2	2	3	3	3	4
	0 . 8	- 6	- 1	- 6	- 1	- 6	- 1	2	-	1	6	1	1	2	2	3	4
	0 . 7	- 1	- 1	- 1	- 1	- 1	- 1	-	-	5	0	1	8	2	1	2	3
	0 . 6	- 1	- 2	- 1	- 2	- 1	- 2	-	-	-	-	7	-	1	8	2	2
	0 . 5	- 3	- 4	- 3	- 4	- 3	- 4	-	-	-	-	-	-	-	-	5	1
	0 . 4	- 6	- 6	- 6	- 6	- 6	- 6	-	-	-	-	-	-	-	-	-	-

AC 150 .

The AC 150 Threshold derating table is as follows:

Table 9: Derating Values for DDR3 800/1066/1333/1600 MT/s tIS/tIH

$\Delta tIS, \Delta tIH$ derating in ps AC/DC based
 AC 150 Threshold(VIH(ac))= VREF(dc)+150 mV, VIL(ac)=VREF(dc)-150 mV
 CK , CK# Differential Slew Rate

		4.0 V/ns		3.0 V/ns		2.0 V/ns		1.8 V/ns		1.6 V/ns		1.4 V/ns		1.2 V/ns		1.0 V/ns		
		Δ -	Δ -	Δ -	Δ -	Δ -	Δ -	Δ -	Δ -	Δ -	Δ -	Δ -	Δ -	Δ -	Δ -	Δ -	Δ -	
		tI-	tI-	tI-	tI-	tI-	tI-	tI-	tI-	tI-	tI-	tI-	tI-	tI-	tI-	tI-	tI-	
		S	H	S	H	S	H	S	H	S	H	S	H	S	H	S	H	
CM- D/A- DD- R S- lew rate (v/ ns)	2	7	5	7	5	7	5	8	5	9	6	9	7	1	8	1	1	
	.	5	0	5	0	5	0	3	8	1	6	9	4	0	4	1	0	
	0													7		5	0	
	1	5	3	5	3	5	3	5	4	6	5	7	5	8	6	9	8	
	.	0	4	0	4	0	4	8	2	6	0	4	8	2	8	0	4	
	5																	
	1	0	0	0	0	0	0	8	8	1	1	2	2	3	3	4	5	
	.									6	6	4	4	2	4	0	0	
	0	0	-	0	-	0	-	8	4	1	1	2	2	3	3	4	4	
	.		4		4		4			6	2	4	0	2	0	0	6	
9																		
0	0	-	0	-	0	-	8	-	1	6	2	1	3	2	4	4		
.		1		1		1		2	6		4	4	2	4	0	0		
8		0		0		0												
0	0	-	0	-	0	-	8	-	1	0	2	8	3	1	4	3		
.		1		1		1		8	6		4		2	8	0	4		
7		6		6		6												
0	-	-	-	-	-	-	7	-	1	-	2	-	3	8	3	2		
.	1	2	1	2	1	2		1	5	1	3	2	1		9	4		
6		6		6		6		8		0								
0	-	-	-	-	-	-	-	-	6	-	1	-	2	-	3	1		
.	1	4	1	4	1	4	2	3		2	4	1	2	6	0	0		
5		0		0		0		2		4		6						
0	-	-	-	-	-	-	-	-	-	-	-	-	7	-	1	-		
.	2	6	2	6	2	6	1	5	9	4	1	3		2	5	1		
4		0		0		0	7	2		4		6		6		0		

For DDR3 1866 and 2133 speeds, AC175 or AC150 default to AC135 settings.

Reference

- [Hints \(see page 56\)](#)

Measurement Levels

By definition, edges occur when a waveform crosses specified reference voltage levels. Reference voltage levels must be set so that the application can identify state transitions on a waveform. By default, the application automatically chooses reference voltage levels when necessary.

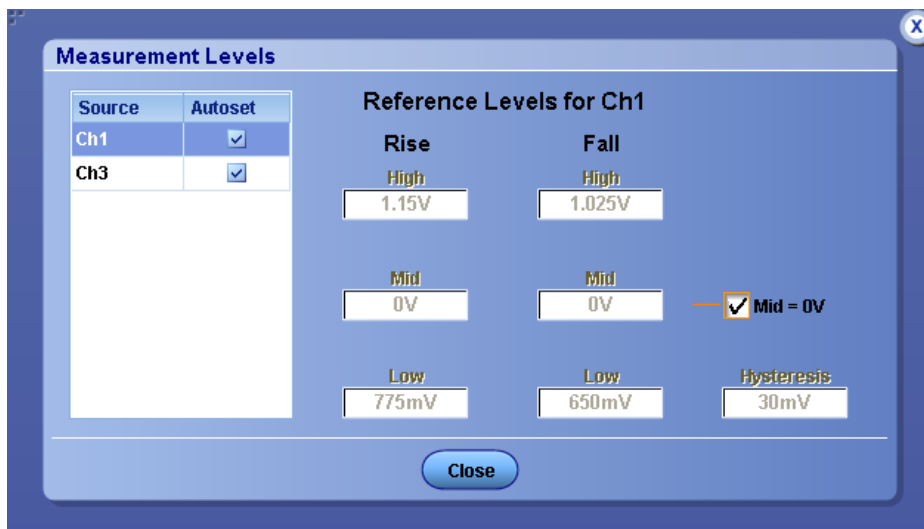

The DDR application uses three basic reference levels: High, Mid and Low. In addition, a hysteresis value defines a voltage band that prevents a noisy waveform from producing spurious edges. The reference levels and hysteresis are independently set for each source waveform, and are specified separately for rising versus falling transitions.

Item	Description
Measurement Reference Levels Setup (one level per source)	
Rise High	Sets the high threshold level for the rising edge of the source.
Rise Mid	Sets the middle threshold level for the rising edge of the source.
Rise Low	Sets the low threshold level for the rising edge of the source.
Fall High	Sets the high threshold level for the falling edge of the source.
Fall Mid	Sets the middle threshold level for the falling edge of the source.
Fall Low	Sets the low threshold level for the falling edge of the source.
Hysteresis	Sets the threshold margin to the reference level which the voltage must cross to be recognized as changing; the margin is the relative reference level plus or minus half the hysteresis; use to filter out spurious events.

Hints

The DDRA application displays the following hints at different steps:

Hint	Step	Description
Select a standard data rate in DDRA	1	Displayed when data rate is None. When you select a non standard data rate in ASM, the data rate is set to None in DDRA.
GDDR3 not completely supported. Some features may not function.	1	Displayed on selecting GDDR3 standard, which does not have standard data rates. Only Data Eye Width measurement is available for both Read and Write bursts.
Please provide a Limits file under Jitter and Eye > Limits	1	Displayed for custom data rates for which limits are not defined. You need to manually configure the limits.
Cannot use Live and Ref waveforms together.	3	Displayed on selecting both Live and Ref waveforms as source for DQ and DQS. Example: Data Eye Width measurement with sources as Ch1 for DQ and Ref1 for DQS.
Cannot use the same waveform for different sources.	3	Displayed on selecting the same source for DQ and DQS. Example: Data Eye Width using Ch3 for both DQ and DQS.
Cannot select Diff and SE measurements at the same time.	3	Displayed on selecting measurements with suffix SE and Diff. Example: DDR2, Write bursts, tDH-Diff and tDH-SE measurements.
Use unique sources that are either Live or Ref.	3	Displayed on selecting measurements which require DQ, DQS and Clock sources. Example: DDR3, 800MT/s, select all Read burst measurements.

Results as Statistics

Result statistics for most of the measurements show **Population** in terms of UI or transitions. According to the JEDEC specification, the analysis for most of the clock measurements is done for a 200-cycle moving window. However, for clock measurements such as tCL(avg) and tCH(avg), the population is shown as tCK(avg) units. For some measurements such as Data Eye Width, exactly one measurement occurs per acquisition. For such measurements, the population increases by one for each acquisition independent of the number of UI in the acquisition.

The screenshot shows the 'DDR Analysis' window with the following data:

Description	Pass/Fail	Mean	Std Dev	Max	Min	p-p	Population
IDH-Diff(derated), D...	Pass	583.36ps	26.602ps	655.27ps	516.52ps	138.75ps	8471
High Limit							
Low Limit	Pass				170.00ps		
Current Acquisition		583.36ps	26.602ps	655.27ps	516.52ps	138.75ps	8471
Data Eye Width, DO...		1.1276ns	0.0000s	1.1276ns	1.1276ns	0.0000s	1
IDQSH, DQS	Pass	1.2446ns	16.501ps	1.2968ns	1.1816ns	115.11ps	4741

For more details, refer to the topic “Viewing Statistical Results” of the DPOJET help.

Reference

- [Dynamic Limits \(see page 18\)](#)

Plots

The only measurement for which a plot is automatically configured is [Data Eye Width](#), which is available for both Read and Write bursts. However, plots may be added for other measurements through the plot panel. The plot selection and configuration methods are identical to those used for DPOJET. For more details, refer to the DPOJET help.

For acquisitions containing more than one read or write burst, time trend plots connect together all measurements within each burst with a continuous line, but do not draw lines between bursts. If a vertical cursor is placed where it does not intersect a line, the cursor annotation will read "NaN" (Not a Number).

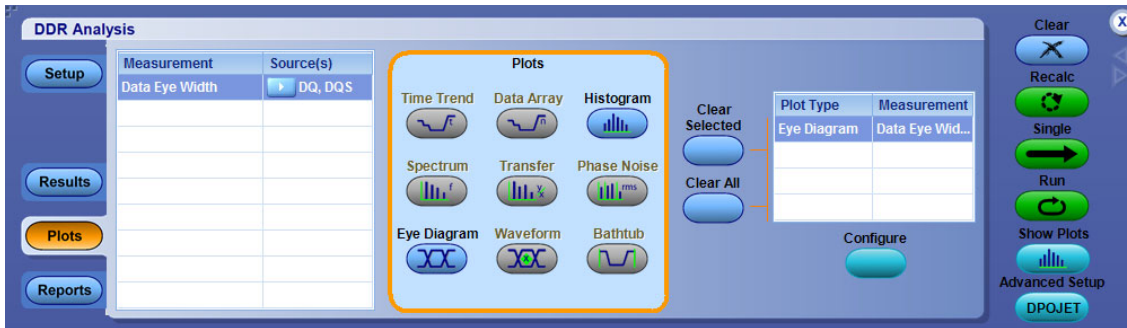

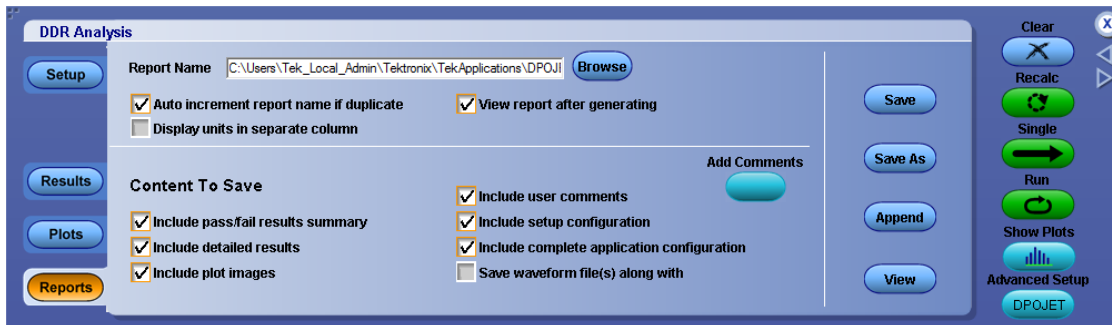

For more details, refer to the topic “About Configuring Plots” of the DPOJET help.

Reports



For more details, refer to the topic “About Reports” of the DPOJET help.

Switching between the DDRA and DPOJET Applications

For advanced analysis, click  to switch to the DPOJET application. Likewise, click  in the DPOJET application to revert to the DDRA application.

The transition behaves as follows:

- The application name in the title bar switches between **DDR Analysis** and **Jitter and Eye Diagram Analysis Tool**.
- Measurement name remains unchanged while traversing from DDRA to DPOJET.
- Within DPOJET, more measurements may be added to those automatically configured in DDRA. These measurements must be configured manually.
- Once in DPOJET, measurements automatically configured by DDRA may be reconfigured. (The measurements will generally no longer be JEDEC-compliant in this case.)
- Upon returning to DDRA, new or non-standard measurements will be retained.
- Measurement sequencing, results analysis and report generation can be done from either application.
- Any change in generation and measurement type in the DDRA deselects all the currently selected measurements.
- Switching back from DPOJET to DDRA, always resets focus to the Setup panel.
- DPOJET or DDRA application is always accessible from the oscilloscope menu bar, as an alternative to the quick navigation buttons.
- If DPOJET application is opened from the oscilloscope menu (Analyze > Jitter and Eye Diagram Analysis), the shortcut button to DDR Analysis is not shown. This shortcut only appears if DPOJET is entered from the DDRA interface.
- Any change in the reference voltage levels in DPOJET is reflected in DDRA Step 1, [Vih and Vil \(see page 115\)](#). Vih and Vil specify the static voltage reference levels of the measurements. You can modify these levels either in Step [6 \(see page 51\)](#) of DDRA or in the DPOJET source configuration screen.

Salient Features of MSO-DDRA Integration

The following are the salient features of MSO-DDR integration:

- Use the DDRA user interface for the required settings without exiting from the DDRA setup panel for digital configuration.
- Logic State burst detection method is more reliable than the conventional DQ/DQS Phase alignment.
- Digital configurations are available at Step 4 and Step 5 of the DDRA application. The Logic pattern or Logic state triggering is used on the digital control signals such as RAS, CAS, CS and WE, which identify the desired burst type.
- Symbol files per DDR generation are available.
- Identify marks using the specified digital control signals and Burst Latency and Tolerance values. The Burst Latency and Tolerance values are important to precisely mark the bursts.
- Change in DDR generation resets the burst length to 8.0.

Introduction to the Tutorial

This tutorial teaches how to set up the application, take measurements, and view results as plots or statistics.

Before you begin the tutorial, perform the following tasks:

- Set up the oscilloscope.
- Start the application.
- Recall the tutorial waveform.

Setting Up the Oscilloscope

The steps to set up the oscilloscope are:

- Click **File > Recall Default Setup** in the oscilloscope menu bar to recall the default settings.
- Press the individual CH1, CH2, CH3, and CH4 buttons as needed to add or remove active waveforms from the display.

Starting the Application

Click **Analyze > DDR Analysis** to open the application.

Waveform Files

The DDRA application provides the following waveforms at C:\TekApplications\DDRA\waveforms for oscilloscopes running the Windows-XP operating system and C:\Users\Public\Tektronix\TekApplications\DDRA\waveforms for oscilloscopes running the Windows7 operating system:

- DDR2_800_DQS_Write.wfm
- DDR2_800_DQ_Write.wfm
- DDR2_800_CLK.wfm

NOTE. *These waveforms have to be used only for Write bursts and CLK.*

Recalling a Waveform File

To recall a waveform file, follow these steps:

1. Click **File > Recall** in the oscilloscope menu bar to display the Recall dialog box.
2. Click Waveform icon in the left of the Recall dialog box.
3. Select Ref1, Ref2, Ref3, or Ref4 as the Destination option.
4. Browse to select the waveform. Use the keypad to edit the waveform file name.
5. Click **Recall**. The oscilloscope recalls and activates the Reference Waveform control window.
6. Click **On** to display the waveform.
7. Click  to return to the application. Alternatively, DDRA can also be accessed from **Analyze > DDR Analysis**.



Taking a Measurement

This tutorial uses the following example

DDR2 800MT/s, Write bursts - Differential measurements

Waveforms Used: DDR2_800_DQS_Write.wfm and DDR2_800_DQ_Write.wfm

1. To set the application to default values, click **File > Recall Default Setup**. This is not necessary if you have just started the application.
2. To view the DDRA application, select **Analyze > DDR Analysis**.
3. At Step 1, select the DDR2 standard and the data rate as 800 MT/s. The default voltage settings are retained as shown:

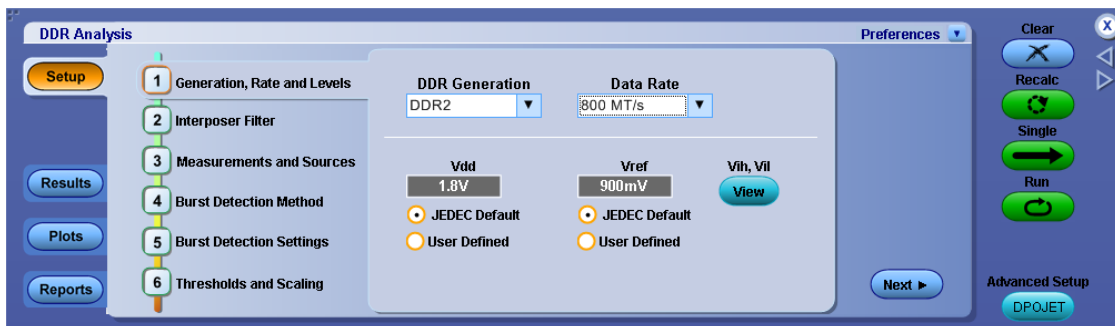

- At Step 2, select the filter and the probing type.

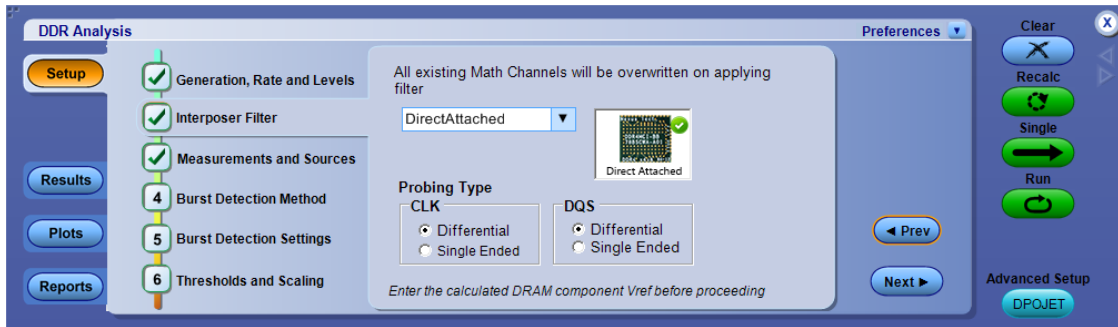

- At Step 3, select the measurements and the associated sources.

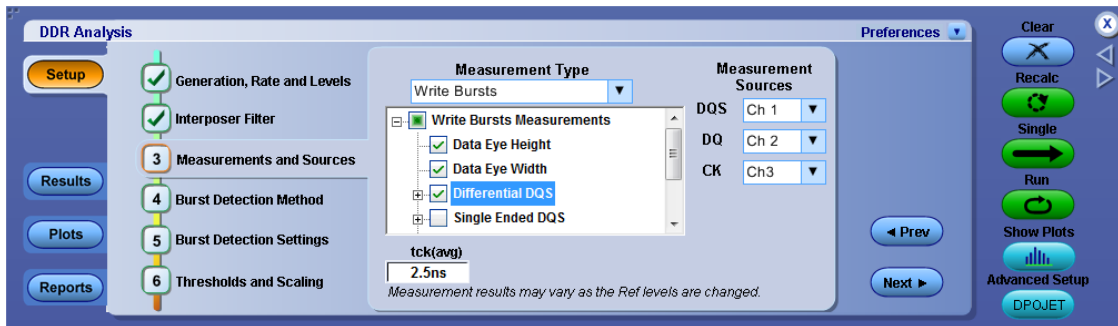

- At Step 4, select the burst detection method.

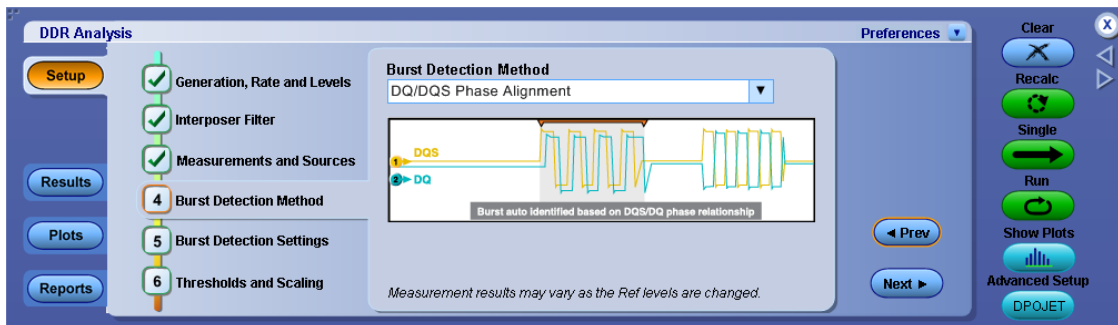

The selected data rate, generation, and measurement type are reflected in ASM on selection in DDRA. Marks are available only for Read and Write bursts measurement type. Configure Search using **Advance > Search > Configure**. The identified bursts are shown as small inverted marks (▲) in the oscilloscope display area. Each pair of marks specifies the start and stop of a burst. You can traverse from one mark to the other using the Mark Control window. For more details, refer to your oscilloscope online help.



NOTE. Logic state+ DQ/DQS Phase Alignment is available only for MSO series of oscilloscopes.

- At Step 5, select the burst detection settings based on the selected burst detection method as shown:

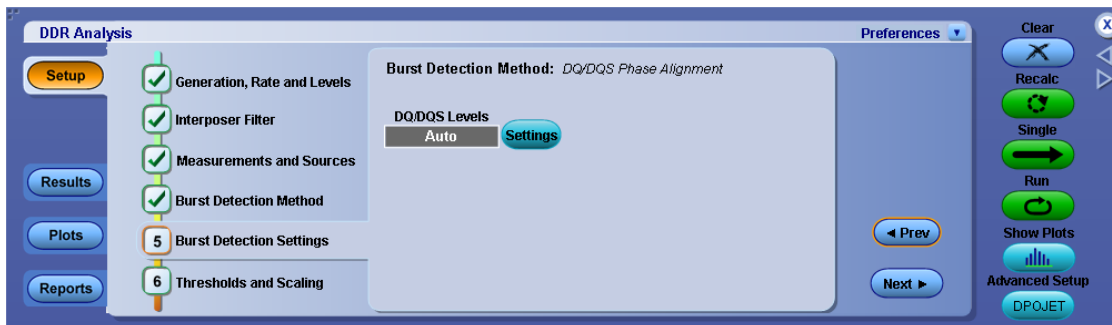

- At Step 6, retain the settings as shown:

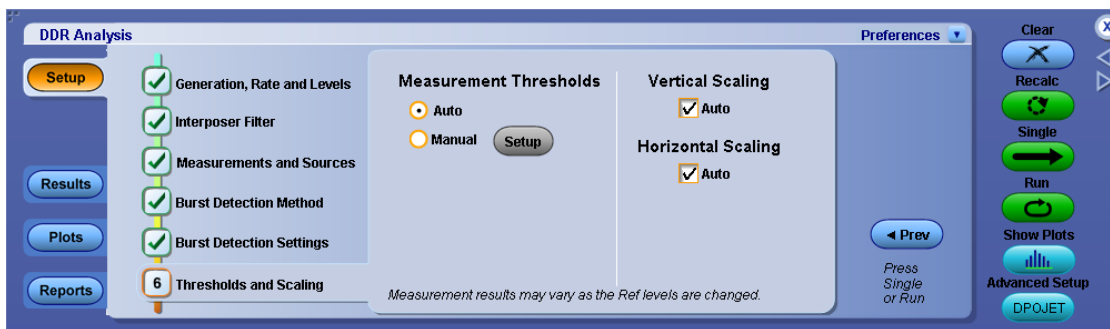

- Click **Single** to run the application. When complete, the result statistics with limits are shown in the results tab.

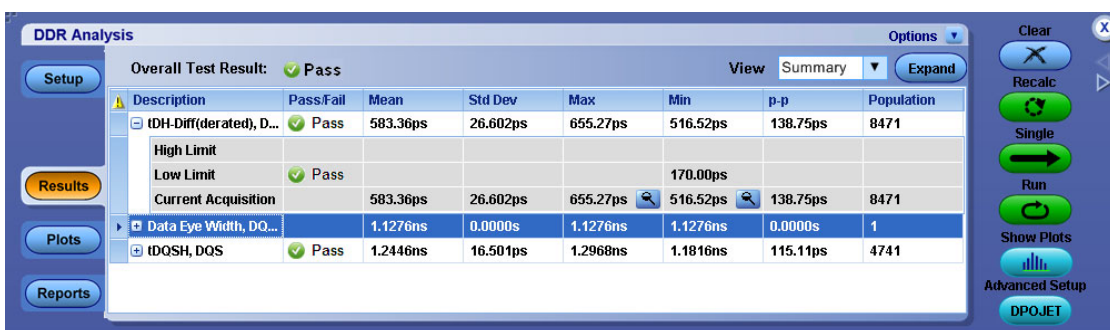

The eye diagram plot is displayed as shown:

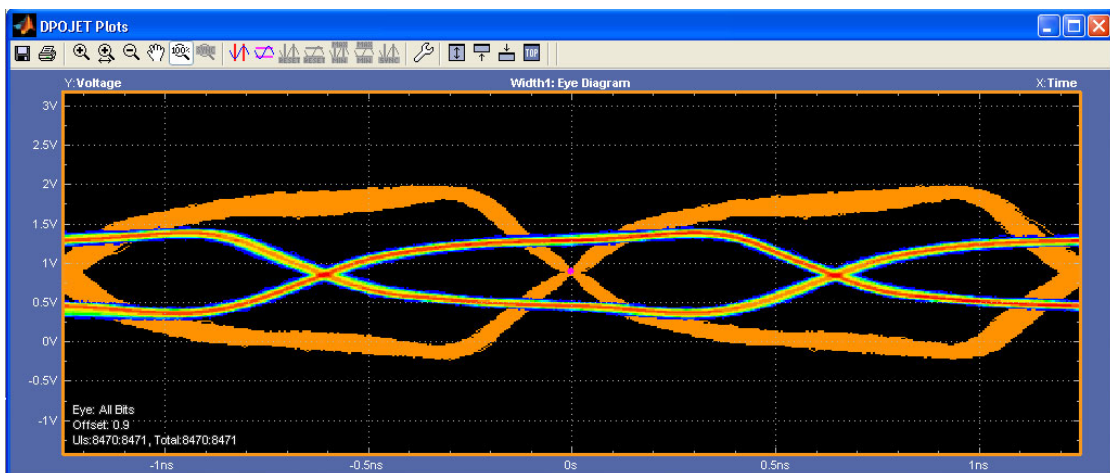

About Parameters

This section describes the DDRA application parameters and includes the menu default settings. Refer to the user manual of your oscilloscope for operating details of other controls, such as front-panel buttons.

The parameter tables list the selections or range of values available for each option, the incremental unit of numeric values, and the default selection or value.

Step1: Generation, Rate and Levels Parameters

Step1 includes the following parameters:

Table 10: Generation, rate and levels parameters

Option	Parameters	Default setting
DDR Generation	DDR, DDR2, DDR3, DDR3L, DDR4, LPDDR, LPDDR2, LPDDR3, GDDR3, and GDDR5	DDR3
Data Rate †	DDR: 200 MT/s, 266 MT/s, 333 MT/s, 400 MT/s, Custom and None	200 MT/s for DDR
	DDR2: 400 MT/s, 533 MT/s, 667 MT/s, 800 MT/s, 1066 MT/s, Custom and None	400 MT/s for DDR2
	DDR3: 800 MT/s, 1066 MT/s, 1333 MT/s, 1866 MT/s, 2133 MT/s, Custom and None	None for DDR3
	DDR3L: 800 MT/s, 1066 MT/s, 1333 MT/s, 1600 MT/s, Custom and None	800 MT/s for DDR3L
	DDR4: 1600 MT/s, 1866 MT/s, 2133 MT/s, 2400 MT/s, 2466 MT/s, 3200 MT/s, Custom and None	1600 MT/s for DDR4
	LPDDR: 200 MT/s, 266 MT/s, Custom and None	200 MT/s for LPDDR
	LPDDR2: 333 MT/s, 400 MT/s, 533 MT/s, 667 MT/s, 933 MT/s, 1066 MT/s, Custom and None	333 MT/s for LPDDR2
	LPDDR3: 333 MT/s, 800 MT/s, 1066 MT/s, 1200 MT/s, 1333 MT/s, 1466 MT/s, 1600 MT/s, Custom and None	333 MT/s for LPDDR3
	GDDR3: 500 MT/s, 600 MT/s, 700 MT/s, 800 MT/s, 900 MT/s, 1000 MT/s, Custom and None	500 MT/s for GDDR3
	GDDR5: 4000 MT/s, 4800 MT/s, 5000 MT/s, 5500 MT/s, Custom, and None	4000 MT/s for GDDR5
	Custom	800 MT/s
Vdd	JEDEC Default, User Defined	JEDEC Default
Vref	JEDEC Default, User Defined	JEDEC Default
DDR4Vref	JEDEC Default, User Defined	User Defined

† Data rate varies for different DDR standards.

Step2: Interposer Filter Parameters

Step2 includes the following parameters under Filter Type:

- None
- User Defined
- Direct Attached
- Socketed

Step2 includes the following parameters under Probing Type for CLK, WCK, and DQS signal types:

- Single Ended
- Differential

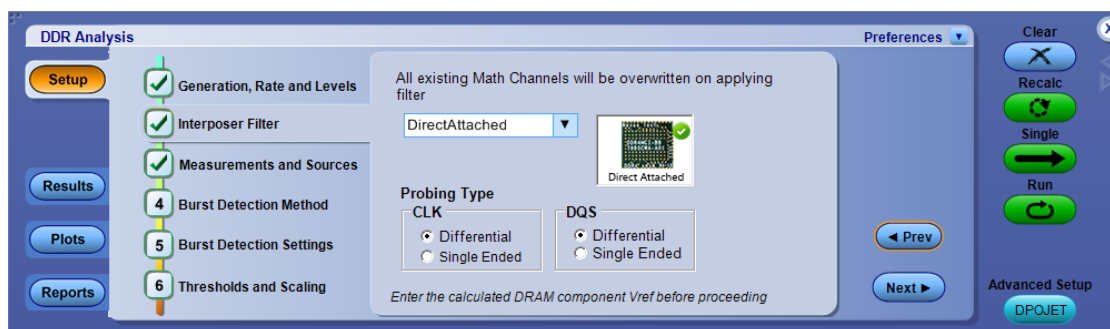

Step3: Measurement and Sources Parameters

Step3 includes the following parameters under Measurement Type:

- Read Bursts
- Write Bursts
- WCK(Single Ended) †
- WCK(Diff) †
- Clock(Diff)
- Clock(Single Ended)
- Address/Command
- Refresh †
- Power Down †
- Active †
- Precharge †
- DQS(Single Ended)
- DQS(Single Ended, Read)

The sources parameters are as shown in the following table:

Table 11: Sources parameters

Option	Parameters	Default setting
DQS(Strobe)	Ch1-Ch4, Ref1-Ref4, Math1-Math4	Ch1
DQS#(Strobe)	Ch1-Ch4, Ref1-Ref4, Math1-Math4	Ch3
DQ(Data)	Ch1-Ch4, Ref1-Ref4, Math1-Math4	Ch2
Addr/Cmd	Ch1-Ch4, Ref1-Ref4, Math1-Math4	Ch4
Clock	Ch1-Ch4, Ref1-Ref4, Math1-Math4	Ch3
Clock#	Ch1-Ch4, Ref1-Ref4, Math1-Math4	Ch4
WCK †	Ch1-Ch4, Ref1-Ref4, Math1-Math4	Ch1
WCK# †	Ch1-Ch4, Ref1-Ref4, Math1-Math4	Ch4
WE, CS, CAS, RAS, CKE †	D0-D15	None

† These measurement types and parameters are available for GDDR5 generation.

Step4: Burst Detection Method Parameters

Step4 has the following parameters:

- [DQ/DQS Phase Alignment](#) (see page 41)
- [Chip Select, Latency + DQ/DQS Phase Alignment](#) (see page 43)
- [Logic State + Burst Latency](#) (see page 44)
- [Visual Search](#) (see page 47)

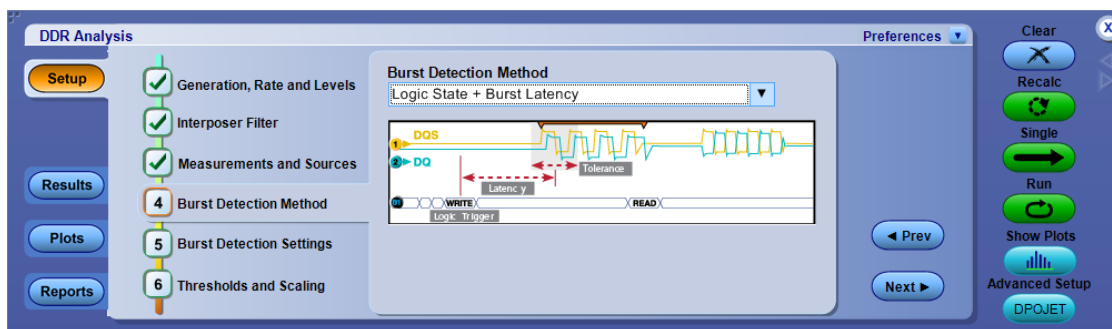

Step5: Burst Detection Settings Parameters

Step5 has the following parameters:

NOTE. The DQ/DQS Phase Alignment settings are same for Chip Select and Logic State Burst Detection methods.

Table 12: Burst detection parameters

Option	Parameters	Default setting
Chip Select, Latency + DQ/DQS Phase Alignment		
CS Source	None, Ch1-Ch4, Ref1-Ref4, Math1-Math4	None
CS Mode †	Auto, Manual	Auto
CAS Min(ui) †	0–1k	2.0
CS Active †	High, Low	Low
CS Level †	Left, Right	0.0 V
CAS Max(ui) †	0–1k	3.0
DQ/DQS Levels ‡	Auto, Manual	Auto

Table 12: Burst detection parameters (cont.)

Option	Parameters	Default setting
DQ/DQS Phase Alignment		
Strobe		
High	Auto, Manual	Auto
Mid	Auto, Manual	Auto
Low	Auto, Manual	Auto
Data		
High	Auto, Manual	Auto
Mid	Auto, Manual	Auto
Low	Auto, Manual	Auto
Edge Detection Hysteresis	Auto, Manual	Auto
Termination Logic Margin	Auto, Manual	Auto
LogicState + Burst Latency DQ/DQS Phase Alignment *		
Bus	B1–B16	None
Tolerance ‡	0–50 G	1Cyc
Burst Latency ‡	0–50 G	2.5Cyc
Burst Length	0–50 G(ui)	0.0
DQ/DQS Levels ‡	Auto, Manual	Auto
Logic Trigger ‡	MODE_REG, REFRESH, PRECHARGE, ACTIVATE, WRITE, READ, SRX, DESELECT, SRE, PDE	MODE_REG

† Available only when you select CS source.

* Available only for the MSO series of oscilloscopes.

‡ These measurement types and parameters are available for GDDR5 generation.

Step6: Thresholds and Scaling Parameters

Step6 has the following parameters:

Table 13: Thresholds and scaling parameters

Option	Parameters	Default setting
Measurement Thresholds	Auto, Manual	Auto
Vertical Scaling	Set, Clear	Clear
Horizontal Scaling	Set, Clear	Clear
Alternate Thresholds *	AC 175, AC 150	AC175
Measurement Levels		
Rise High	-20 V to 20 V	1 V
Rise Mid	-20 V to 20 V	0 V
Rise Low	-20 V to 20 V	-1 V
Fall High	-20 V to 20 V	1 V
Fall Mid	-20 V to 20 V	0 V
Fall Low	-20 V to 20 V	-1 V
Hysteresis	0 to 10 V	30 mV

* Available only for Address and Command Measurement type.

LPDDR Measurement Sources

The sources required for analysis may include DQS (Strobe), DQS# (Strobe), DQ (Data), Clock, Clock #, and Addr/Cmd. DQ and DQS can be either Single-Ended (SE) or Differential (Diff). Read and Write bursts have CS as an optional source.

The following table lists the sources required for each LPDDR measurement:

Table 14: LPDDR measurement sources

DDR measurements	DPOJET base measurement	Performed on	Additional required sources
Write Bursts			
Data Eye Width	Eye Width	DQS and DQ	None
Data Eye Height	Eye Height	DQS and DQ	None
tDQSS		Bus (B1) and DQS	DQ
Differential DQS			
tDH-Diff(base)	DDR Hold-Diff	DQS and DQ	None
tDQSH	Pos Width	DQS and DQ	None
tDQSL	Neg Width	DQS and DQ	None
tDS-Diff(base)	DDR Setup-Diff	DQS and DQ	None
tDSH-Diff	Hold	DQS and Clock	DQ †
tDSS-Diff	Setup	DQS and Clock	DQ †
Single Ended DQS			
tDH-SE	DDR Hold-SE	DQ and DQS	None
tDIPW-SE	Period	DQ	DQS †
tDSH-SE	Hold	DQS and Clock	DQ †
tDSS-SE	Setup	DQS and Clock	DQ †
tDS-SE	DDR Setup-SE	DQS and DQ	None
tWPRE	DDR tRPRE	DQS	DQ †
tWPST	DDR tPST	DQS	DQ †
Read Bursts			
Data Eye Width	Eye Width	DQS and DQ	None
Data Eye Height	Eye Height	DQS and DQ	None
Differential DQS			
tAC-Diff	DDR Setup-Diff	DQ and Clock	DQS †
tDQCK-Diff	Skew	DQS and Clock	DQ †
tQH	Hold	DQS and DQ	None
Single Ended DQS			
tDQSQ-SE	Setup	DQS and DQ	None
tRPRE	DDR tRPRE	DQS	DQ †

Table 14: LPDDR measurement sources (cont.)

DDR measurements	DPOJET base measurement	Performed on	Additional required sources
tRPST	DDR tRPST	DQS	DQ †
Clock (Diff)			
tCH	Pos Width	Clock	None
tCK	Period	Clock	None
tCL	Neg Width	Clock	None
tHP	Period	Clock	None
VID(ac)	DDR VID(ac)	Clock	None
Clock (Single Ended)			
AC-Overshoot(CK#)	Overshoot	Clock#	None
AC-Overshoot(CK)	Overshoot	Clock	None
AC-OvershootArea(CK#)	DDR Over Area	Clock#	None
AC-OvershootArea(CK)	DDR Over Area	Clock	None
AC-Undershoot(CK#)	Undershoot	Clock#	None
AC-Undershoot(CK)	Undershoot	Clock	None
AC-UndershootArea(CK#)	DDR Under Area	Clock#	None
AC-Undershoot Area(CK)	DDR Under Area	Clock	None
Vix(ac)CK	V-Diff-Xovr	Clock and Clock#	None
DQS (Single Ended)			
AC-OvershootArea(DQ)	DDR Over Area	DQ	DQS
AC-UndershootArea(DQ)	DDR Under Area	DQ	DQS
AC-Overshoot(DQ)	Overshoot	DQ	DQS
AC-Undershoot(DQ)	Undershoot	DQ	DQS
AC-Overshoot(DQS)	Overshoot	DQS	DQ †
AC-OvershootArea(DQS)	DDR Over Area	DQS	DQ †
AC-Undershoot(DQS)	Undershoot	DQS	DQ †
AC-UndershootArea(DQS)	DDR Under Area	DQS	DQ †
DQS (Single Ended, Read)			
AC-OvershootArea(DQ)	DDR Over Area	DQ	DQS
AC-UndershootArea(DQ)	DDR Under Area	DQ	DQS
AC-Overshoot(DQ)	Overshoot	DQ	DQS
AC-Undershoot(DQ)	Undershoot	DQ	DQS
AC-OvershootArea(DQS)	DDR Over Area	DQS	DQ
AC-UndershootArea(DQS)	DDR Under Area	DQS	DQ
AC-Overshoot(DQS)	Overshoot	DQS	DQ
AC-Undershoot(DQS)	Undershoot	DQS	DQ
Address/Command			
AC-Overshoot	Overshoot	Addr/Cmd	None

Table 14: LPDDR measurement sources (cont.)

DDR measurements	DPOJET base measurement	Performed on	Additional required sources
AC-Overshoot	DDR Over Area	Addr/Cmd	None
AC-Undershoot	Undershoot	Addr/Cmd	None
AC-UndershootArea	DDR Under Area	Addr/Cmd	None
tIH(base)	DDR Hold-Diff	Clock and Addr/Cmd	None
tIPW-High	High Time	Clock and Addr/Cmd	None
tIPW-Low	Low Time	Clock and Addr/Cmd	None
tIS(base)	DDR Setup-Diff	Clock and Addr/Cmd	None

† Required so that the Search-and-Mark feature can properly identify bursts

LPDDR2 Measurement Sources

The sources required for analysis may include DQS (Strobe), DQS# (Strobe), DQ (Data), Clock, Clock #, and Addr/Cmd. DQS and Clock can be either Single-Ended (SE) or Differential (Diff). Read and Write bursts have CS as an optional source.

The following table lists the sources required for each LPDDR2 measurement:

Table 15: LPDDR2 measurement sources

DDR measurements	DPOJET base measurement	Performed on	Additional required sources
Write Bursts			
Data Eye Width	Eye Width	DQS and DQ	None
Data Eye Height	Eye Height	DQS and DQ	None
tDQSS		DQS and Bus (B1)	DQ
Single Ended DQS			
tDIPW-SE	Period	DQ	DQS
Differential DQS			
InputSlew-Diff-Fall(DQS)	Fall Slew Rate	DQS and DQ	None
InputSlew-Diff-Rise(DQS)	Rise Slew Rate	DQ and DQS	None
tDH-Diff(base)	DDR Hold-Diff	DQ	DQS †
tDH-Diff(derated)	DDR Hold-Diff	DQS and DQ	None
tDH-Diff(Vref-based)	Hold	DQS and DQ	None
tDQSH	Positive Width	DQS	DQ †
tDQSL	Negative Width	DQS	DQ †
tDS-Diff(base)	DDR Setup-Diff	DQS and DQ	None
tDS-Diff(derated)	DDR Setup-Diff	DQS and Clock	DQ †
tDS-Diff(Vref-based)	Setup	DQS	DQ †

Table 15: LPDDR2 measurement sources (cont.)

DDR measurements	DPOJET base measurement	Performed on	Additional required sources
tDSH-Diff	Hold	DQS and Clock	DQ ‡
tDSS-Diff	Setup	DQS and Clock	DQ ‡
tDVAC(DQS)	Time Outside Level	DQS	DQ
Slew Rate DQ			
Slew Rate-Hold-Fall(DQ)	Fall Slew Rate	DQ	DQS ‡
Slew Rate-Hold-Rise(DQ)	Rise Slew Rate	DQ	DQS ‡
Slew Rate-Setup-Fall(DQ)	Fall Slew Rate	DQ	DQS ‡
Slew Rate-Setup-Rise(DQ)	Rise Slew Rate	DQ	DQS ‡
tWPRE	DDR tRPRE	DQS	DQ ‡
tWPST	DDRTPST	DQS	DQ ‡
Read Bursts			
Differential DQS			
SRQdiff-Fall(DQS)	Fall Slew Rate	DQS	DQ ‡
SRQdiff-Rise(DQS)	Rise Slew Rate	DQS	DQ ‡
tDQSQ-Diff	Setup	DQS and DQ	None
tDVAC(DQS)	Time Outside Level	DQS	DQ
tQH	Hold	DQS and DQ	None
Slew Rate DQ			
SRQse-Fall(DQ)	Fall Slew Rate	DQ	DQS ‡
SRQse-Rise(DQ)	Rise Slew Rate	DQ	DQS ‡
tRPRE	DDR tRPRE	DQS	DQ ‡
tRPST	DDRTPST	DQS	DQ ‡
Clock (Diff)			
tCH(abs)	Pos Width	Clock	None
tCH(avg)	DDR tCH(avg)	Clock	None
tCK(abs)	Period	Clock	None
tCK(avg)	DDR tCK(avg)	Clock	None
tCL(abs)	Neg Width	Clock	None
tCL(avg)	DDR tCL(avg)	Clock	None
tDVAC(CK)	Time Outside Level	CK	None
tERR	DDR tERR	Clock	None
tJIT(cc)	CC-Period	Clock	None
tJIT(duty)	DDR tJIT(duty)	Clock	None
tJIT(per)	DDR tJIT(per)	Clock	None
tHP	Period	Clock	None
Clock (Single Ended)			

Table 15: LPDDR2 measurement sources (cont.)

DDR measurements	DPOJET base measurement	Performed on	Additional required sources
AC-OverShoot(CK#)	OverShoot	Clock#	None
AC-OverShoot(CK)	OverShoot	Clock	None
AC-OvershootArea(CK#)	DDR Over Area	Clock#	None
AC-OvershootArea(CK)	DDR Over Area	Clock	None
AC-UnderShoot(CK#)	UnderShoot	Clock#	None
AC-UnderShoot(CK)	UnderShoot	Clock	None
AC-UndershootArea(CK#)	DDR Under Area	Clock#	None
AC-UndershootArea(CK)	DDR Under Area	Clock	None
VIXCA	DDR3 Vix(ac)	CK, CK#	None
VSEH(AC)CK	Cycle Max	Clock	None
VSEH(AC)CK#	Cycle Max	Clock#	None
VSEL(AC)CK	Cycle Min	Clock	None
VSEL(AC)CK#	Cycle Min	Clock#	None
DQS (Single Ended)			
AC-OvershootArea(DQ)	DDR Over Area	DQ	DQS
AC-UndershootArea(DQ)	DDR Under Area	DQ	DQS
AC-OverShoot(DQ)	OverShoot	DQ	DQS
AC-UnderShoot(DQ)	UnderShoot	DQ	DQS
AC-OverShoot(DQS#)	OverShoot	DQS#	DQ, DQS
AC-OverShoot(DQS)	OverShoot	DQS	DQ †
AC-OvershootArea(DQS#)	DDR Over Area	DQS#	DQ, DQS
AC-OvershootArea(DQS)	DDR Over Area	DQS	DQ †
AC-UnderShoot(DQS#)	UnderShoot	DQS#	DQ, DQS
AC-UnderShoot(DQS)	UnderShoot	DQS	DQ †
AC-Under-shootArea(DQS#)	DDR Under Area	DQS#	DQ, DQS
AC-UndershootArea(DQS)	DDR Under Area	DQS	DQ †
VIXDQ	DDR3 Vix(ac)	DQS, DQS#	DQ
VSEH(AC)DQS	Cycle Max	DQS	DQ †
VSEH(AC)DQS#	Cycle Max	DQS#	DQ †
VSEL(AC)DQS	Cycle Min	DQS	DQ †
VSEL(AC)DQS#	Cycle Min	DQS#	DQ †
DQS (Single Ended, Read)			
AC-OvershootArea(DQ)	DDR Over Area	DQ	DQS
AC-UndershootArea(DQ)	DDR Under Area	DQ	DQS
AC-Overshoot(DQ)	Overshoot	DQ	DQS
AC-Undershoot(DQ)	Undershoot	DQ	DQS

Table 15: LPDDR2 measurement sources (cont.)

DDR measurements	DPOJET base measurement	Performed on	Additional required sources
AC-OvershootArea(DQS)	DDR Over Area	DQS	DQ
AC-UndershootArea(DQS)	DDR Under Area	DQS	DQ
AC-Overshoot(DQS)	Overshoot	DQS	DQ
AC-Undershoot(DQS)	Undershoot	DQS	DQ
AC-OvershootArea(DQS#)	DDR Over Area	DQS#	DQ, DQS
AC-Under-shootArea(DQS#)	DDR Under Area	DQS#	DQ, DQS
AC-Overshoot(DQS#)	Overshoot	DQS#	DQ, DQS
AC-Undershoot(DQS#)	Undershoot	DQS#	DQ, DQS
Precharge			
tRTP	tCMD-CMD	Bus, CK	None
tRP	tCMD-CMD	Bus, CK	None
Active			
tRAS	tCMD-CMD	Bus, CK	None
tRC	tCMD-CMD	Bus, CK	None
tRCDRD	tCMD-CMD	Bus, CK	None
tRCDWR	tCMD-CMD	Bus, CK	None
Address/Command			
AC-OverShoot	OverShoot	Addr/Cmd	None
AC-OvershootArea	DDR Over Area	Addr/Cmd	None
AC-UnderShoot	UnderShoot	Addr/Cmd	None
AC-UndershootArea	DDR Under Area	Addr/Cmd	None
InputSlew-Diff-Fall(CK)	Fall Slew Rate	Clock	None
InputSlew-Diff-Rise(CK)	Rise Slew Rate	Clock	None
Slew Rate-Hold-Fall(Addr/Cmd)	Fall Slew Rate	Addr/Cmd	None
Slew Rate-Hold-Rise(Addr/Cmd)	Rise Slew Rate	Addr/Cmd	None
Slew Rate-Setup-Fall(Addr/Cmd)	Fall Slew Rate	Addr/Cmd	None
Slew Rate-Setup-Rise(Addr/Cmd)	Rise Slew Rate	Addr/Cmd	None
tIH(base)	DDR Hold-Diff	Clock and Addr/Cmd	None
tIH(derated)	DDR Hold-Diff	Clock and Addr/Cmd	None
tIPW-High	High Time	Clock and Addr/Cmd	None
tIPW-Low	Low Time	Clock and Addr/Cmd	None

Table 15: LPDDR2 measurement sources (cont.)

DDR measurements	DPOJET base measurement	Performed on	Additional required sources
tIS(base)	DDR Setup-Diff	Clock and Addr/Cmd	None
tIS(derated)	DDR Setup-Diff	Clock and Addr/Cmd	None

‡ Required so that the Search-and-Mark feature can properly identify bursts

LPDDR3 Measurement Sources

The sources required for analysis may include DQS (Strobe), DQS# (Strobe), DQ (Data) , Clock, Clock #, and Addr/Cmd. DQ and DQS can be either Single-Ended (SE) or Differential (Diff). Read and Write bursts have CS as an optional source.

The following table lists the sources required for each LPDDR3 measurement:

Table 16: LPDDR3 measurement sources

DDR measurements	DPOJET base measurement	Performed on	Additional required sources
Write Bursts			
Data Eye Width	Eye Width	DQS and DQ	None
Data Eye Height	Eye Height	DQS and DQ	None
tDQSS	DDR tDQSS	DQS and Bus (B1)	DQ
tWPRE	DDR tRPRE	DQS	DQ ‡
tWPST	DDR tPST	DQS	DQ ‡
Differential DQS			
InputSlew-Diff-Fall(DQS)	Fall Slew Rate	DQS	DQ ‡
InputSlew-Diff-Rise(DQS)	Rise Slew Rate	DQS	DQ ‡
tDH-Diff(base)	DDR Hold-Diff	DQS and DQ	None
tDH-Diff(derated)	DDR Hold-Diff	DQS and DQ	None
tDH-Diff(Vref-based)	Hold	DQS and DQ	None
tDQSH	Positive Width	DQS and DQ	None
tDQSL	Negative Width	DQS and DQ	None
tDS-Diff(base)	DDR Setup-Diff	DQS and DQ	None
tDS-Diff(derated)	DDR Setup-Diff	DQS and DQ	None
tDS-Diff(Vref-based)	Setup	DQS and DQ	None
tDSH-Diff	Hold	DQS and Clock	DQ ‡
tDSS-Diff	Setup	DQS and Clock	DQ ‡
tDVAC(DQS)	Time Outside Level	DQS	DQ ‡
TdIPW-High	Positive Width	DQ	DQS ‡
TdIPW-Low	Negative Width	DQ	DQS ‡
Slew Rate DQS			
Slew Rate-Hold-Fall(DQ)	Fall Slew Rate	DQ	DQS ‡
Slew Rate-Hold-Rise(DQ)	Rise Slew Rate	DQ	DQS ‡
Slew Rate-Setup-Fall(DQ)	Fall Slew Rate	DQ	DQS ‡
Slew Rate-Setup-Rise(DQ)	Rise Slew Rate	DQ	DQS ‡

Table 16: LPDDR3 measurement sources (cont.)

DDR measurements	DPOJET base measurement	Performed on	Additional required sources
Read Bursts			
Data Eye Width	Eye Width	DQS and DQ	None
Data Eye Height	Eye Height	DQS and DQ	None
tRPRE	DDR tRPRE	DQS	DQ ‡
tRPST	DDR tRPST	DQS	DQ ‡
tDQSK	DDR2tDQSK	DQS and Clock	DQ ‡
Differential DQS			
SRQdiff-Fall(DQS)	Fall Slew Rate	DQS	DQ ‡
SRQdiff-Rise(DQS)	Rise Slew Rate	DQS	DQ ‡
tDQSQ-Diff	Setup	DQS and DQ	None
tDVAC(DQS)	Time Outside Level	DQS	DQ ‡
tAC-Diff	DDR Setup-Diff	DQ and Clock	DQS ‡
tDQSK-Diff	Skew	DQS and Clock	DQ ‡
tQH	Hold	DQS and DQ	None
tQSH	Positive Width	DQS	DQ ‡
tQSL	Negative Width	DQS	DQ ‡
Slew Rate DQ			
SRQse-Fall(DQ)	Fall Slew Rate	DQ	DQS ‡
SRQse-Rise(DQ)	Rise Slew Rate	DQ	DQS ‡
Clock (Diff)			
tCH(abs)	Positive Width	Clock	None
tCH(avg)	DDR tCH(avg)	Clock	None
tCK(abs)	Period	Clock	None
tCK(avg)	DDR tCK(avg)	Clock	None
tCL(abs)	Negative Width	Clock	None
tCL(avg)	DDR tCL(avg)	Clock	None
tDVAC(CK)	Time Outside Level	CK	None
tERR	DDR tERR	Clock	None
tJIT(cc)	CC-Period	Clock	None
tJIT(duty)	DDR tJIT(duty)	Clock	None
tJIT(per)	DDR tJIT(per)	Clock	None
InputSlew-Diff-Fall(CK)	Fall Slew Rate	Clock	None
InputSlew-Diff-Rise(CK)	Rise Slew Rate	Clock	None

Table 16: LPDDR3 measurement sources (cont.)

DDR measurements	DPOJET base measurement	Performed on	Additional required sources
Clock (Single Ended)			
AC-OverShoot(CK#)	OverShoot	Clock#	None
AC-OverShoot(CK)	OverShoot	Clock	None
AC-OvershootArea(CK#)	DDR Over Area	Clock#	None
AC-OvershootArea(CK)	DDR Over Area	Clock	None
AC-UnderShoot(CK#)	UnderShoot	Clock#	None
AC-UnderShoot(CK)	UnderShoot	Clock	None
AC-UndershootArea(CK#)	DDR Under Area	Clock#	None
AC-UndershootArea(CK)	DDR Under Area	Clock	None
Vix(ac)CK	V-Diff-Xovr	Clock and Clock#	None
VSEH(AC)CK#	Cycle Max	Clock#	None
VSEH(AC)CK	Cycle Max	Clock	None
VSEL(AC)CK#	Cycle Min	Clock#	None
VSEL(AC)CK	Cycle Min	Clock	None
DQS (Single Ended)			
AC-OvershootArea(DQ)	DDR Over Area	DQ	DQS
AC-UndershootArea(DQ)	DDR Under Area	DQ	DQS
AC-OverShoot(DQ)	OverShoot	DQ	DQS
AC-UnderShoot(DQ)	UnderShoot	DQ	DQS
AC-OverShoot(DQS#)	OverShoot	DQS#	DQ, DQS
AC-OverShoot(DQS)	OverShoot	DQS	DQ ‡
AC-OvershootArea(DQS#)	DDR Over Area	DQS#	DQ, DQS
AC-OvershootArea(DQS)	DDR Over Area	DQS	DQ ‡
AC-UnderShoot(DQS#)	UnderShoot	DQS#	DQ, DQS
AC-UnderShoot(DQS)	UnderShoot	DQS	DQ ‡
AC-Under-shootArea(DQS#)	DDR Under Area	DQS#	DQ, DQS
AC-UndershootArea(DQS)	DDR Under Area	DQS	DQ ‡
Vix(ac)DQS	DDR3 Vix(ac)	DQS	DQ ‡
VSEH(AC)DQS#	Cycle Max	DQS#	DQ ‡
VSEH(AC)DQS	Cycle Max	DQS	DQ ‡
VSEL(AC)DQS#	Cycle Min	DQS#	DQ ‡
VSEL(AC)DQS	Cycle Min	DQS	DQ ‡

Table 16: LPDDR3 measurement sources (cont.)

DDR measurements	DPOJET base measurement	Performed on	Additional required sources
DQS (Single Ended, Read)			
AC-OvershootArea(DQ)	DDR Over Area	DQ	DQS
AC-UndershootArea(DQ)	DDR Under Area	DQ	DQS
AC-Overshoot(DQ)	Overshoot	DQ	DQS
AC-Undershoot(DQ)	Undershoot	DQ	DQS
AC-OvershootArea(DQS)	DDR Over Area	DQS	DQ
AC-UndershootArea(DQS)	DDR Under Area	DQS	DQ
AC-Overshoot(DQS)	Overshoot	DQS	DQ
AC-Undershoot(DQS)	Undershoot	DQS	DQ
AC-OvershootArea(DQS#)	DDR Over Area	DQS#	DQ, DQS
AC-Under-shootArea(DQS#)	DDR Under Area	DQS#	DQ, DQS
AC-Overshoot(DQS#)	Overshoot	DQS#	DQ, DQS
AC-Undershoot(DQS#)	Undershoot	DQS#	DQ, DQS
Address/Command			
AC-OverShoot	OverShoot	Addr/Cmd	None
AC-OvershootArea	DDR Over Area	Addr/Cmd	None
AC-UnderShoot	UnderShoot	Addr/Cmd	None
AC-UndershootArea	DDR Under Area	Addr/Cmd	None
Slew Rate-Hold-Fall(Addr/Cmd)	Fall Slew Rate	Addr/Cmd	None
Slew Rate-Hold-Rise(Addr/Cmd)	Rise Slew Rate	Addr/Cmd	None
Slew Rate-Setup-Fall(Addr/Cmd)	Fall Slew Rate	Addr/Cmd	None
Slew Rate-Setup-Rise(Addr/Cmd)	Rise Slew Rate	Addr/Cmd	None
tIH(base)	DDR Hold-Diff	Clock and Addr/Cmd	None
tIH(base)CA	DDR Hold-Diff	Clock and Addr/Cmd	None
tIH(base)CS	DDR Hold-Diff	Clock and Addr/Cmd	None
tIH(derated)	DDR Hold-Diff	Clock and Addr/Cmd	None
tIH(derated)CA	DDR Hold-Diff	Clock and Addr/Cmd	None
tIH(derated)CS	DDR Hold-Diff	Clock and Addr/Cmd	None
tIPW-High	High Time	Clock and Addr/Cmd	None
tIPW-High(CA)	High Time	Addr/Cmd	None
tIPW-High(CS)	High Time	Addr/Cmd	None
tIPW-Low	Low Time	Clock and Addr/Cmd	None
tIPW-Low(CA)	Low Time	Addr/Cmd	None

Table 16: LPDDR3 measurement sources (cont.)

DDR measurements	DPOJET base measurement	Performed on	Additional required sources
tIPW-Low(CS)	Low Time	Addr/Cmd	None
tIS(base)CA	DDR Setup-Diff	Clock and Addr/Cmd	None
tIS(base)CS	DDR Setup-Diff	Clock and Addr/Cmd	None
tIH(derated)CA	DDR Setup-Diff	Clock and Addr/Cmd	None
tIH(derated)CS	DDR Setup-Diff	Clock and Addr/Cmd	None

‡ Required so that the Search-and-Mark feature can properly identify bursts

DDR Measurement Sources

The sources required for analysis may include DQS(Strobe), DQ(Data), DQS# (Strobe), Clock, Clock#, and Addr/Cmd. DQ and DQS can be either Single-Ended (SE) or Differential (Diff). CS Source is available, as appropriate, as an optional qualifier.

The following table lists the sources required for each DDR measurement:

Table 17: DDR measurement sources

DDR measurements	DPOJET base measurement	Performed on	Additional required sources
Write Bursts			
Data Eye Width	Eye Width	DQS and DQ	None
Data Eye Height	Eye Height	DQS and DQ	None
Differential DQS			
tDSH-Diff	Hold	DQS and Clock	DQ †
tDSS-Diff	Setup	DQS and Clock	DQ †
Single Ended DQS			
tDH-SE	DDR Hold-SE	DQS and DQ	None
tDIPW-SE	Period	DQ	DQS †
tDSH-SE	Hold	DQS and Clock	DQ †
tDS-SE	DDR Setup-SE	DQS and DQ	None
tDSS-SE	Setup	DQS and Clock	DQ †
tWPRE	DDR tRPRE	DQS	DQ †
tWPST	DDR tPST	DQS	DQ †
Read Bursts			
Data Eye Width	Eye Width	DQS and DQ	None
Data Eye Height	Eye Height	DQS and DQ	None
Differential DQS			
tAC-Diff	DDR Setup-Diff	DQ and Clock	DQS †

Table 17: DDR measurement sources (cont.)

DDR measurements	DPOJET base measurement	Performed on	Additional required sources
tDQSCK-Diff	Skew	DQS and Clock	DQ †
tQH	Hold	DQS and DQ	None
Single Ended DQS			
tDQSQ-SE	Setup	DQS and DQ	None
tRPRE	DDR tRPRE	DQS	DQ †
tRPST	DDR tRPST	DQS	DQ †
Clock (Diff)			
tCH	Pos Width	Clock	None
tCK	Period	Clock	None
tCL	Neg Width	Clock	None
tHP	Period	Clock	None
VID(ac)	DDR VID(ac)	Clock	None
Clock (Single Ended)			
AC-Overshoot(CK#)	Overshoot	Clock#	None
AC-Overshoot(CK)	Overshoot	Clock	None
AC-OvershootArea(CK#)	DDR Over Area	Clock#	None
AC-OvershootArea(CK)	DDR Over Area	Clock	None
AC-Undershoot(CK#)	Undershoot	Clock#	None
AC-Undershoot(CK)	Undershoot	Clock	None
AC-UndershootArea(CK#)	DDR Under Area	Clock#	None
AC-UndershootArea(CK)	DDR Under Area	Clock	None
Vix(ac)CK	V-Diff-Xovr	Clock and Clock#	None
DQS (Single Ended)			
AC-OvershootArea(DQ)	DDR Over Area	DQ	DQS
AC-UndershootArea(DQ)	DDR Under Area	DQ	DQS
AC-Overshoot(DQ)	Overshoot	DQ	DQS
AC-Undershoot(DQ)	Undershoot	DQ	DQS
AC-Overshoot(DQS#)	Overshoot	DQS#	DQ, DQS
AC-Overshoot(DQS)	Overshoot	DQS	DQ †
AC-OvershootArea(DQS#)	DDR Over Area	DQS#	DQ, DQS
AC-OvershootArea(DQS)	DDR Over Area	DQS	DQ †
AC-Undershoot(DQS#)	Undershoot	DQS#	DQ, DQS
AC-Undershoot(DQS)	Undershoot	DQS	DQ †
AC-Under-shootArea(DQS#)	DDR Under Area	DQS#	DQ, DQS
AC-UndershootArea(DQS)	DDR Under Area	DQS	DQ †
Vix(ac)DQS	V-Diff-Xovr	DQS and DQS#	DQ †

Table 17: DDR measurement sources (cont.)

DDR measurements	DPOJET base measurement	Performed on	Additional required sources
DQS (Single Ended, Read)			
AC-OvershootArea(DQ)	DDR Over Area	DQ	DQS
AC-UndershootArea(DQ)	DDR Under Area	DQ	DQS
AC-Overshoot(DQ)	Overshoot	DQ	DQS
AC-Undershoot(DQ)	Undershoot	DQ	DQS
AC-OvershootArea(DQS)	DDR Over Area	DQS	DQ
AC-UndershootArea(DQS)	DDR Under Area	DQS	DQ
AC-Overshoot(DQS)	Overshoot	DQS	DQ
AC-Undershoot(DQS)	Undershoot	DQS	DQ
AC-OvershootArea(DQS#)	DDR Over Area	DQS#	DQ, DQS
AC-Under-shootArea(DQS#)	DDR Under Area	DQS#	DQ, DQS
AC-Overshoot(DQS#)	Overshoot	DQS#	DQ, DQS
AC-Undershoot(DQS#)	Undershoot	DQS#	DQ, DQS
Address/Command			
AC-Overshoot	Overshoot	Addr/Cmd	None
AC-OvershootArea	DDR Over Area	Addr/Cmd	None
AC-Undershoot	Undershoot	Addr/Cmd	None
AC-UndershootArea	DDR Under Area	Addr/Cmd	None
tIH(base)	DDR Hold-Diff	Clock and Addr/Cmd	None
tIPW-High	High Time	Clock and Addr/Cmd	None
tIPW-Low	Low Time	Clock and Addr/Cmd	None
tIS(base)	DDR Setup-Diff	Clock and Addr/Cmd	None

† Required so that the Search-and-Mark feature can properly identify bursts

DDR2 Measurement Sources

The sources required for analysis may include DQS(Strobe), DQ(Data), DQS# (Strobe), Clock, Clock#, CS Source, and Addr/Cmd. DQ and DQS can be either Single-Ended (SE) or Differential (Diff). Read and Write bursts have CS as an optional source.

The following table lists the sources required for each DDR2 measurement:

Table 18: DDR2 measurement sources

DDR measurements	DPOJET base measurement	Performed on	Additional required sources
Write Bursts			
Data Eye Width	Eye Width	DQS and DQ	None
Data Eye Height	Eye Height	DQS and DQ	None
Differential DQS			
InputSlew-Diff-Fall(DQS)	Fall Slew Rate	DQS	DQ †
InputSlew-Diff-Rise(DQS)	Rise Slew Rate	DQS	DQ †
tDH-Diff(base)	DDR Hold-Diff	DQS and DQ	None
tDH-Diff(derated)	DDR Hold-Diff	DQS	None
tDQSH	Pos Width	DQS	DQ †
tDQSL	Neg Width	DQS and DQ	DQ †
tDQSS-Diff	Skew	DQS and Clock	DQ †
tDS-Diff(base)	DDR Setup-Diff	DQS and DQ	None
tDS-Diff(derated)	DDR Setup-Diff	DQS and DQ	None
tDSH-Diff	Hold	DQS and Clock	DQ †
tDSS-Diff	Setup	DQS and Clock	DQ †
tDVAC(DQS)	Time Outside Level	DQS	DQ
Single Ended DQS			
Slew Rate-Setup-SE-Fall(DQS)	Fall Slew Rate	DQS	DQ †
Slew Rate-Setup-SE-Rise(DQS)	Rise Slew Rate	DQS	DQ †
Slew Rate-Hold-SE-Fall(DQS)	Fall Slew Rate	DQS	DQ †
Slew Rate-Hold-SE-Rise(DQS)	Rise Slew Rate	DQS	DQ †
tDH-SE(base)	DDR Hold-SE	DQS and DQ	None
tDH-SE(derated)	DDR Hold-SE	DQS and DQ	None
tDIPW-SE	Period	DQ	DQS
tDQSS-SE	Skew	DQS and Clock	DQ †
tDSH-SE	Hold	DQS and Clock	DQ †

Table 18: DDR2 measurement sources (cont.)

DDR measurements	DPOJET base measurement	Performed on	Additional required sources
tDS-SE(base)	DDR Setup-SE	DQS and DQ	None
tDS-SE(derated)	DDR Setup-SE	DQS and DQ	None
tDSS-SE	Setup	DQS and Clock	DQ †
Slew Rate DQ			
Slew Rate-Setup-Fall(DQ)	Fall Slew Rate	DQ	DQS †
Slew Rate-Setup-Rise(DQ)	Rise Slew Rate	DQ	DQS †
Slew Rate-Hold-Fall(DQ)	Fall Slew Rate	DQ	DQS †
Slew Rate-Hold-Rise(DQ)	Rise Slew Rate	DQ	DQS †
tWPRE	DDR tRPRE	DQS	DQ †
tWPST	DDR tPST	DQS	DQ †
Read Bursts			
Data Eye Width	Eye Width	DQS and DQ	None
Data Eye Height	Eye Height	DQS and DQ	None
Differential DQS			
tAC-Diff	DDR Setup-Diff	DQ and Clock	DQS †
tDQSQ-Diff	Setup	DQS and DQ	None
tQH	Hold	DQS and DQ	None
tDVAC(DQS)	Time Outside Level	DQS	DQ
Single Ended DQS			
tDQCK-SE	Skew	DQS and Clock	None
tDQSQ-SE	Setup	DQ and DQS	None
tRPRE	DDR tRPRE	DQS	DQ †
tWPRE	DDR tPST	DQS	DQ †
Vox(ac)DQS	V-Diff-Xovr	DQS, DQS#	DQ
Clock (Diff)			
tCH(abs)	Pos Width	Clock	None
tCH(avg)	DDR tCH(avg)	Clock	None
tCK(abs)	Period	Clock	None
tCK(avg)	DDR tCK(avg)	Clock	None
tCL(abs)	Neg Width	Clock	None
tCL(avg)	DDR tCL(avg)	Clock	None
tDVAC(CK)	Time Outside Level	CK	None
tERR(11-50per)	DDR tERR(m-n)	Clock	None
tERR(2per)	DDR tERR(n)	Clock	None
tERR(3per)	DDR tERR(n)	Clock	None
tERR(4per)	DDR tERR(n)	Clock	None
tERR(5per)	DDR tERR(n)	Clock	None

Table 18: DDR2 measurement sources (cont.)

DDR measurements	DPOJET base measurement	Performed on	Additional required sources
tERR(6–10per)	DDR tERR(m–n)	Clock	None
tHP	Period	Clock	None
tJIT(cc)	CC–Period	Clock	None
tJIT(duty)	DDR tJIT(duty)	Clock	None
tJIT(per)	DDR tJIT(per)	Clock	None
VID(ac)	DDR VID(ac)	Clock	None
Clock (Single Ended)			
AC-Overshoot(CK#)	Overshoot	Clock#	None
AC-Overshoot(CK)	Overshoot	Clock	None
AC-OvershootArea(CK#)	DDR Over Area	Clock	None
AC-OvershootArea(CK)	DDR Over Area	Clock	None
AC-Undershoot(CK#)	Undershoot	Clock#	None
AC-Undershoot(CK)	Undershoot	Clock	None
AC-UndershootArea(CK#)	DDR Under Area	Clock	None
AC-UndershootArea(CK)	DDR Under Area	Clock	None
Vix(ac)CK	V–Diff–Xovr	Clock and Clock#	None
Vox(ac)CK	V–Diff–Xovr	Clock and Clock#	None
VSWING(MAX)CK	Cycle Pk-Pk	Clock	None
VSWING(MAX)CK#	Cycle Pk-Pk	Clock	None
DQS (Single Ended)			
AC-Overshoot(DQ)	Overshoot	DQ	DQS
AC-Undershoot(DQ)	Undershoot	DQ	DQS
AC-OvershootArea(DQ)	DDR Over Area	DQ	DQS
AC-UndershootArea(DQ)	DDR Under Area	DQ	DQS
AC-Overshoot(DQS)	Overshoot	DQS	DQ
AC-Undershoot(DQS)	Undershoot	DQS	DQ
AC-OvershootArea(DQS)	DDR Over Area	DQS	DQ
AC-UndershootArea(DQS)	DDR Under Area	DQS	DQ
AC-Overshoot(DQS#)	Overshoot	DQS#	DQ, DQS
AC-Undershoot(DQS#)	Undershoot	DQS#	DQ, DQS
AC-OvershootArea(DQS#)	DDR Over Area	DQS#	DQ, DQS
AC-Under-shootArea(DQS#)	DDR Under Area	DQS#	DQ, DQS
Vix(ac)DQS	V–Diff–Xovr	DQS	DQ †
VSWING(MAX)DQS	Cycle Pk-Pk	DQS	DQ †
VSWING(MAX)DQS#	Cycle Pk-Pk	DQS#	DQ †
DQS (Single Ended, Read)			

Table 18: DDR2 measurement sources (cont.)

DDR measurements	DPOJET base measurement	Performed on	Additional required sources
AC-Overshoot(DQ)	Overshoot	DQ	DQS
AC-Undershoot(DQ)	Undershoot	DQ	DQS
AC-OvershootArea(DQ)	DDR Over Area	DQ	DQS
AC-UndershootArea(DQ)	DDR Under Area	DQ	DQS
AC-Overshoot(DQS#)	Overshoot	DQS#	DQ, DQS
AC-Overshoot(DQS)	Overshoot	DQS	DQ †
AC-OvershootArea(DQS#)	DDR Over Area	DQS#	DQ, DQS
AC-OvershootArea(DQS)	DDR Over Area	DQS	DQ †
AC-Undershoot(DQS#)	Undershoot	DQS#	DQ, DQS
AC-Undershoot(DQS)	Undershoot	DQS	DQ †
AC-Under-shootArea(DQS#)	DDR Under Area	DQS#	DQ, DQS
AC-UndershootArea(DQS)	DDR Under Area	DQS	DQ †
Vox(ac)DQS	V-Diff-Xovr	DQS, DQS#	DQ
Precharge			
tRP(MRS)	tCMD-CMD	Bus, CK	None
tRP(REF)	tCMD-CMD	Bus, CK	None
Address/Command Measurements			
AC-Overshoot	Overshoot	Addr/Cmd	None
AC-OvershootArea	DDR Over Area	Addr/Cmd	None
AC-Undershoot	Undershoot	Addr/Cmd	None
AC-UndershootArea	DDR Under Area	Addr/Cmd	None
InputSlew-Diff-Fall(CK)	Fall Slew Rate	Clock	None
InputSlew-Diff-Rise(CK)	Rise Slew Rate	Clock	None
Slew Rate-Hold-Fall(Addr/Cmd)	Fall Slew Rate	Addr/Cmd	None
Slew Rate-Hold-Rise(Addr/Cmd)	Rise Slew Rate	Addr/Cmd	None
Slew Rate-Setup-Fall(Addr/Cmd)	Fall Slew Rate	Addr/Cmd	None
Slew Rate-Setup-Rise(Addr/Cmd)	Rise Slew Rate	Addr/Cmd	None
tIH(base)	DDR Hold-Diff	Clock and Addr/Cmd	None
tIH(derated)	DDR Hold-Diff	Clock and Addr/Cmd	None
tIPW-High	High Time	Clock and Addr/Cmd	None
tIPW-Low	Low Time	Clock and Addr/Cmd	None

Table 18: DDR2 measurement sources (cont.)

DDR measurements	DPOJET base measurement	Performed on	Additional required sources
tIS(base)	DDR Setup-Diff	Clock and Addr/Cmd	None
tIS(derated)	DDR Setup-Diff	Clock and Addr/Cmd	None

† Required so that the Search-and-Mark feature can properly identify bursts

DDR3 Measurement Sources

The sources required for analysis may include DQS(Strobe), DQ(Data), DQS# (Strobe), Clock, Clock#, and Addr/Cmd. DQ and DQS can be either Single-Ended (SE) or Differential (Diff). CS Source is available, as appropriate, as an optional qualifier.

The following table lists the sources required for each DDR3 measurement:

Table 19: DDR3 measurement sources

DDR measurements	DPOJET base measurement	Performed on	Additional required sources
Write Bursts			
Data Eye Width	Eye Width	DQS and DQ	None
Data Eye Height	Eye Height	DQS and DQ	None
Differential DQS			
InputSlew-Diff-Fall(DQS)	Fall Slew Rate	DQS	DQ †
InputSlew-Diff-Rise(DQS)	Rise Slew Rate	DQS	DQ †
tDH-Diff(base)	DDR Hold-Diff	DQS and DQ	None
tDH-Diff(derated)	DDR Hold-Diff	DQS and DQ	None
tDQSH	Pos Width	DQS	DQ †
tDQSL	Neg Width	DQS	DQ †
tDQSS-Diff	Skew	DQS and Clock	DQ †
tDS-Diff(base)	DDR Setup-Diff	DQS and DQ	None
tDS-Diff(derated)	DDR Setup-Diff	DQ and DQS	None
tDSH-Diff	Hold	DQS and Clock	DQ †
tDSS-Diff	Setup	DQS and Clock	DQ †
tDVAC(DQS)	Time Outside Level	DQS	DQ
Single Ended DQS			
tDIPW-SE	Period	DQ	DQS †
tDQSS-SE	Skew	DQS and Clock	DQ †
tDSH-SE	Hold	DQS and Clock	DQ †
tDSS-SE	Setup	DQS and Clock	DQ †
Slew Rate DQ			

Table 19: DDR3 measurement sources (cont.)

DDR measurements	DPOJET base measurement	Performed on	Additional required sources
Slew Rate-Hold-Rise(DQ)	Rise Slew Rate	DQ	DQS ‡
Slew Rate-Hold-Fall(DQ)	Fall Slew Rate	DQ	DQS ‡
Slew Rate-Setup-Rise(DQ)	Rise Slew Rate	DQ	DQS ‡
Slew Rate-Setup-Fall(DQ)	Fall Slew Rate	DQ	DQS ‡
tWPRE	DDR tWPRE	DQS	DQ ‡
tWPST	DDR tPST	DQS	DQ ‡
Read Bursts			
Data Eye Width	Eye Width	DQS and DQ	None
Data Eye Height	Eye Height	DQS and DQ	None
Differential DQS			
SRQdiff-Fall(DQS)	Fall Slew Rate	DQS	DQ ‡
SRQdiff-Rise(DQS)	Rise Slew Rate	DQS	DQ ‡
tDQCK-Diff	Skew	DQS and Clock	DQ ‡
tDQSQ-Diff	Setup	DQS and DQ	None
tQH	Hold	DQ and DQS	None
tDVAC(DQS)	Time Outside Level	DQS	DQ
tRPRE	DDR tRPRE	DQS	DQ ‡
tPST	DDR tPST	DQS	DQ ‡
Clock (Diff)			
tCH(abs)	Pos Width	Clock	None
tCH(avg)	DDR tCH(avg)	Clock	None
tCK(abs)	Period	Clock	None
tCK(avg)	DDR tCK(avg)	Clock	None
tCL(abs)	Neg Width	Clock	None
tCL(avg)	DDR tCL(avg)	Clock	None
tDVAC(CK)	Time Outside Level	CK	None
tERR	DDR tERR	Clock	None
tJIT(cc)	CC-Period	Clock	None
tJIT(duty)	DDR tJIT(duty)	Clock	None
tJIT(per)	DDR tJIT(per)	Clock	None
Clock (Single Ended)			
AC-Overshoot(CK#)	Overshoot	Clock#	None
AC-Overshoot(CK)	Overshoot	Clock	None
AC-OvershootArea(CK#)	DDR Over Area	Clock#	None
AC-OvershootArea(CK)	DDR Over Area	Clock	None
AC-Undershoot(CK#)	Undershoot	Clock#	None
AC-Undershoot(CK)	Undershoot	Clock	None

Table 19: DDR3 measurement sources (cont.)

DDR measurements	DPOJET base measurement	Performed on	Additional required sources
AC-UndershootArea(CK#)	DDR Under Area	Clock#	None
AC-UndershootArea(CK)	DDR Under Area	Clock	None
Vix(ac)CK	DDR3 Vix(ac)CK	Clock	None
VSEH(AC)CK#	Cycle Max	Clock#	None
VSEH(AC)CK	Cycle Max	Clock	None
VSEH(CK#)	Cycle Max	Clock#	None
VSEH(CK)	Cycle Max	Clock	None
VSEL(AC)CK#	Cycle Min	Clock#	None
VSEL(AC)CK	Cycle Min	Clock	None
VSEL(CK#)	Cycle Min	Clock#	None
VSEL(CK)	Cycle Min	Clock	None
DQS (Single Ended)			
AC-OvershootArea(DQ)	DDR Over Area	DQ	DQS
AC-UndershootArea(DQ)	DDR Under Area	DQ	DQS
AC-Overshoot(DQ)	Overshoot	DQ	DQS
AC-Undershoot(DQ)	Undershoot	DQ	DQS
AC-Overshoot(DQS#)	Overshoot	DQS#	DQ, DQS
AC-Overshoot(DQS)	Overshoot	DQS	DQ †
AC-OvershootArea(DQS#)	DDR Over Area	DQS#	DQ, DQS
AC-OvershootArea(DQS)	DDR Over Area	DQS	DQ †
AC-Undershoot(DQS#)	Undershoot	DQS#	DQ, DQS
AC-Undershoot(DQS)	Undershoot	DQS	DQ †
AC-Under-shootArea(DQS#)	DDR Under Area	DQS#	DQ, DQS
AC-UndershootArea(DQS)	DDR Under Area	DQS	DQ †
Vix(ac)DQS	DDR3 Vix(ac)	DQS	DQ †
VSEH(AC)DQS#	Cycle Max	DQS#	DQ †
VSEH(AC)DQS	Cycle Max	DQS	DQ †
VSEH(DQS#)	Cycle Max	DQS#	DQ †
VSEH(DQS)	Cycle Max	DQS	DQ †
VSEL(AC)DQS#	Cycle Min	DQS#	DQ †
VSEL(AC)DQS	Cycle Min	DQS	DQ †
VSEL(DQS#)	Cycle Min	DQS#	DQ †
VSEL(DQS)	Cycle Min	DQS	DQ †
DQS (Single Ended, Read)			
AC-OvershootArea(DQ)	DDR Over Area	DQ	DQS
AC-UndershootArea(DQ)	DDR Under Area	DQ	DQS

Table 19: DDR3 measurement sources (cont.)

DDR measurements	DPOJET base measurement	Performed on	Additional required sources
AC-Overshoot(DQ)	Overshoot	DQ	DQS
AC-Undershoot(DQ)	Undershoot	DQ	DQS
AC-OvershootArea(DQS)	DDR Over Area	DQS	DQ
AC-UndershootArea(DQS)	DDR Under Area	DQS	DQ
AC-Overshoot(DQS)	Overshoot	DQS	DQ
AC-Undershoot(DQS)	Undershoot	DQS	DQ
AC-OvershootArea(DQS#)	DDR Over Area	DQS#	DQ, DQS
AC-Under-shootArea(DQS#)	DDR Under Area	DQS#	DQ, DQS
AC-Overshoot(DQS#)	Overshoot	DQS#	DQ, DQS
AC-Undershoot(DQS#)	Undershoot	DQS#	DQ, DQS
Precharge			
tRP(ACT)	tCMD-CMD	Bus, CK	None
tRP(MRS)	tCMD-CMD	Bus, CK	None
Address/Command Measurements			
AC-Overshoot	Overshoot	Addr/Cmd	None
AC-OvershootArea	DDR Over Area	Addr/Cmd	None
AC-Undershoot	Undershoot	Addr/Cmd	None
AC-UndershootArea	DDR Under Area	Addr/Cmd	None
InputSlew-Diff-Fall(CK)	Fall Slew Rate	Clock	None
InputSlew-Diff-Rise(CK)	Rise Slew Rate	Clock	None
Slew Rate-Hold-Fall(Addr/Cmd)	Fall Slew Rate	Addr/Cmd	None
Slew Rate-Hold-Rise(Addr/Cmd)	Rise Slew Rate	Addr/Cmd	None
Slew Rate-Setup-Fall(Addr/Cmd)	Fall Slew Rate	Addr/Cmd	None
Slew Rate-Setup-Rise(Addr/Cmd)	Rise Slew Rate	Addr/Cmd	None
tIH(base)	DDR Hold-Diff	Clock and Addr/Cmd	None
tIH(derated)	DDR Hold-Diff	Clock and Addr/Cmd	None
tIPW-High	High Time	Addr/Cmd	None
tIPW-Low	Low Time	Addr/Cmd	None
tIS(base)	DDR Setup-Diff	Clock and Addr/Cmd	None
tIS(derated)	DDR Setup-Diff	Clock and Addr/Cmd	None

‡ Required so that the Search-and-Mark feature can properly identify bursts

DDR3L Measurement Sources

The sources required for analysis may include DQS (Strobe), DQS# (Strobe), DQ (Data), Clock, Clock #, and Addr/Cmd. DQ and DQS can be either Single-Ended (SE) or Differential (Diff). Read and Write bursts have CS as an optional source.

The following table lists the sources required for each DDR3L measurement:

Table 20: DDR3L measurement sources

DDR measurements	DPOJET base measurement	Performed on	Additional required sources
Write Bursts			
Data Eye Width	Eye Width	DQS and DQ	None
Data Eye Height	Eye Height	DQS and DQ	None
tWPRE	DDR tRPRE	DQS	DQ ‡
tWPST	DDR tPST	DQS	DQ ‡
Differential DQS			
InputSlew-Diff-Fall(DQS)	Fall Slew Rate	DQS	DQ ‡
InputSlew-Diff-Rise(DQS)	Rise Slew Rate	DQS	DQ ‡
tDH-Diff(base)	DDR Hold-Diff	DQS and DQ	None
tDH-Diff(derated)	DDR Hold-Diff	DQS and DQ	None
tDQSH	Positive Width	DQS and DQ	None
tDQSL	Negative Width	DQS and DQ	None
tDQSS-Diff	Skew	DQS and Clock	DQ ‡
tDS-Diff(base)	DDR Setup-Diff	DQS and DQ	None
tDS-Diff(derated)	DDR Setup-Diff	DQS and DQ	None
tDSH-Diff	Hold	DQS and Clock	DQ ‡
tDSS-Diff	Setup	DQS and Clock	DQ ‡
tDVAC(DQS)	Time Outside Level	DQS	DQ ‡
Single Ended DQS			
tDIPW-SE	Period	DQ	DQS ‡
tDQSS-SE	Skew	DQS and Clock	DQ ‡
tDSH-SE	Hold	DQS and Clock	DQ ‡
tDSS-SE	Setup	DQS and Clock	DQ ‡
Slew Rate DQ			
Slew Rate-Hold-Rise(DQ)	Rise Slew Rate	DQ	DQS ‡
Slew Rate-Hold-Fall(DQ)	Fall Slew Rate	DQ	DQS ‡
Slew Rate-Setup-Rise(DQ)	Rise Slew Rate	DQ	DQS ‡
Slew Rate-Setup-Fall(DQ)	Fall Slew Rate	DQ	DQS ‡
Read Bursts			

Table 20: DDR3L measurement sources (cont.)

DDR measurements	DPOJET base measurement	Performed on	Additional required sources
Data Eye Width	Eye Width	DQS and DQ	None
Data Eye Height	Eye Height	DQS and DQ	None
tRPRE	DDR tRPRE	DQS	DQS ‡
tRPST	DDR tRPST	DQS	DQS ‡
Differential DQS			
SRQdiff-Fall(DQS)	Fall Slew Rate	DQS	DQ ‡
SRQdiff-Rise(DQS)	Rise Slew Rate	DQS	DQ ‡
tDQSK-Diff	Skew	DQS and Clock	DQ ‡
tDQSQ-Diff	Setup	DQS and DQ	None
tQH	Hold	DQS and DQ	None
tDVAC(DQS)	Time Outside Level	DQS	DQ ‡
tAC-Diff	DDR Setup-Diff	DQ and Clock	DQS ‡
Slew Rate DQ			
SRQse-Fall(DQ)	Fall Slew Rate	DQ	DQS ‡
SRQse-Rise(DQ)	Rise Slew Rate	DQ	DQS ‡
Clock (Diff)			
tCH(abs)	Positive Width	Clock	None
tCH(avg)	DDR tCH(avg)	Clock	None
tCK(abs)	Period	Clock	None
tCK(avg)	DDR tCK(avg)	Clock	None
tCL(abs)	Negative Width	Clock	None
tCL(avg)	DDR tCL(avg)	Clock	None
tDVAC(CK)	Time Outside Level	CK	None
tERR	DDR tERR	Clock	None
tJIT(cc)	CC-Period	Clock	None
tJIT(duty)	DDR tJIT(duty)	Clock	None
tJIT(per)	DDR tJIT(per)	Clock	None
Clock (Single Ended)			
AC-Overshoot(CK#)	Overshoot	Clock#	None
AC-Overshoot(CK)	Overshoot	Clock	None
AC-OvershootArea(CK#)	DDR Over Area	Clock#	None
AC-OvershootArea(CK)	DDR Over Area	Clock	None
AC-Undershoot(CK#)	Undershoot	Clock#	None
AC-Undershoot(CK)	Undershoot	Clock	None
AC-UndershootArea(CK#)	DDR Under Area	Clock#	None
AC-UndershootArea(CK)	DDR Under Area	Clock	None
Vix(ac)CK	V-Diff-Xovr	Clock and Clock#	None

Table 20: DDR3L measurement sources (cont.)

DDR measurements	DPOJET base measurement	Performed on	Additional required sources
VSEH(AC)CK#	Cycle Max	Clock#	None
VSEH(AC)CK	Cycle Max	Clock	None
VSEH(CK#)	Cycle Max	Clock#	None
VSEH(CK)	Cycle Max	Clock	None
VSEL(AC)CK#	Cycle Min	Clock#	None
VSEL(AC)CK	Cycle Min	Clock	None
VSEL(CK#)	Cycle Min	Clock#	None
VSEL(CK)	Cycle Min	Clock	None
DQS (Single Ended)			
AC-OvershootArea(DQ)	DDR Over Area	DQ	DQS
AC-UndershootArea(DQ)	DDR Under Area	DQ	DQS
AC-Overshoot(DQ)	Overshoot	DQ	DQS
AC-Undershoot(DQ)	Undershoot	DQ	DQS
AC-Overshoot(DQS#)	Overshoot	DQS#	DQ, DQS
AC-Overshoot(DQS)	Overshoot	DQS	DQ ‡
AC-OvershootArea(DQS#)	DDR Over Area	DQS#	DQ, DQS
AC-OvershootArea(DQS)	DDR Over Area	DQS	DQ ‡
AC-Undershoot(DQS#)	Undershoot	DQS#	DQ, DQS
AC-Undershoot(DQS)	Undershoot	DQS	DQ ‡
AC-Under-shootArea(DQS#)	DDR Under Area	DQS#	DQ, DQS
AC-UndershootArea(DQS)	DDR Under Area	DQS	DQ ‡
Vix(ac)DQS	DDR3 Vix(ac)	DQS	DQ ‡
VSEH(AC)DQS#	Cycle Max	DQS#	DQ ‡
VSEH(AC)DQS	Cycle Max	DQS	DQ ‡
VSEH(DQS#)	Cycle Max	DQS#	DQ, DQS
VSEH(DQS)	Cycle Max	DQS	DQ ‡
VSEL(AC)DQS#	Cycle Min	DQS#	DQ ‡
VSEL(AC)DQS	Cycle Min	DQS	DQ ‡
VSEL(DQS#)	Cycle Min	DQS#	DQ, DQS
VSEL(DQS)	Cycle Min	DQS	DQ ‡
DQS (Single Ended, Read)			
AC-OvershootArea(DQ)	DDR Over Area	DQ	DQS
AC-UndershootArea(DQ)	DDR Under Area	DQ	DQS
AC-Overshoot(DQ)	Overshoot	DQ	DQS
AC-Undershoot(DQ)	Undershoot	DQ	DQS
AC-OvershootArea(DQS)	DDR Over Area	DQS	DQ

Table 20: DDR3L measurement sources (cont.)

DDR measurements	DPOJET base measurement	Performed on	Additional required sources
AC-UndershootArea(DQS)	DDR Under Area	DQS	DQ
AC-Overshoot(DQS)	Overshoot	DQS	DQ
AC-Undershoot(DQS)	Undershoot	DQS	DQ
AC-Overshoot(DQS#)	Overshoot	DQS#	DQ, DQS
AC-OvershootArea(DQS#)	DDR Over Area	DQS#	DQ, DQS
AC-Undershoot(DQS#)	Undershoot	DQS#	DQ, DQS
AC-Under-shootArea(DQS#)	DDR Under Area	DQS#	DQ, DQS
Address/Command Measurements			
AC-Overshoot	Overshoot	Addr/Cmd	None
AC-OvershootArea	DDR Over Area	Addr/Cmd	None
AC-Undershoot	Undershoot	Addr/Cmd	None
AC-UndershootArea	DDR Under Area	Addr/Cmd	None
Slew Rate-Hold-Fall(Addr/Cmd)	Fall Slew Rate	Addr/Cmd	None
Slew Rate-Hold-Rise(Addr/Cmd)	Rise Slew Rate	Addr/Cmd	None
Slew Rate-Setup-Fall(Addr/Cmd)	Fall Slew Rate	Addr/Cmd	None
Slew Rate-Setup-Rise(Addr/Cmd)	Rise Slew Rate	Addr/Cmd	None
tIH(base)	DDR Hold-Diff	Clock and Addr/Cmd	None
tIH(derated)	DDR Hold-Diff	Clock and Addr/Cmd	None
tIPW-High	High Time	Clock and Addr/Cmd	None
tIPW-Low	Low Time	Clock and Addr/Cmd	None
tIS(base)	DDR Setup-Diff	Clock and Addr/Cmd	None
tIS(derated)	DDR Setup-Diff	Clock and Addr/Cmd	None

‡ Required so that the Search-and-Mark feature can properly identify bursts

DDR4 Measurement Sources

The sources required for analysis may include DQS (Strobe), DQS# (Strobe), DQ (Data), Clock, Clock #, and Addr/Cmd. DQ and DQS can be either Single-Ended (SE) or Differential (Diff). Read and Write bursts have CS as an optional source.

The following table lists the sources required for each DDR4 measurement:

Table 21: DDR4 measurement sources

DDR measurements	DPOJET base measurement	Performed on	Additional required sources
Write Bursts			
Data Eye Width	Eye Width	DQS and DQ	None
Data Eye Height	Eye Height	DQS and DQ	None
RX Mask	Mask Hits	DQS and DQ	None
tWPRE	DDR tRPRE	DQS	DQ ‡
tWPST	DDR tPST	DQS	DQ ‡
Differential DQS			
tDVAC(DQS)	DDR Hold-Diff	DQS and DQ	None
tDQSH	Positive Width	DQS and DQ	None
tDQSL	Negative Width	DQS and DQ	None
tDQSS-Diff	Time Outside Level	DQS	DQ ‡
tDS-Diff(base)	DDR Setup-Diff	DQS and DQ	None
tDSH-Diff	Hold	DQS and Clock	DQ ‡
tDSS-Diff	Setup	DQS and Clock	DQ ‡
SRIN_dIVW_Fall	Fall Slew Rate	DQ	DQS ‡
SRIN_dIVW_Rise	Rise Slew Rate	DQ	DQS ‡
TdIPW-High	Positive Width	DQ	DQS ‡
TdIPW-Low	Negative Width	DQ	DQS ‡
VIHL_AC	Cycle Pk-Pk	DQ	DQS ‡
Read Bursts			
Data Eye Width	Eye Width	DQS and DQ	None
Data Eye Height	Eye Height	DQS and DQ	None
tRPRE	DDR tRPRE	DQS	DQ ‡
tRPST	DDR tRPST	DQS	DQ ‡
Differential DQS			
tDQSCK-Diff	Skew	DQS and Clock	DQ ‡
tQH	Hold	DQS and DQ	None
SRQdiff-Fall(DQS)	Fall Slew Rate	DQS	DQ ‡
SRQdiff-Rise(DQS)	Rise Slew Rate	DQS	DQ ‡
tDQSQ-Diff	Setup	DQS and DQ	None
tDVAC(DQS)	Time Outside Level	DQS	DQ ‡
tHZ(DQ)	DDR tHZDQ	Clock and DQ	DQS ‡
tLZ(DQ)	DDR tLZDQ	Clock and DQ	DQS ‡
tQSH	Positive Width	DQS	DQ ‡
tQSL	Negative Width	DQS	DQ ‡

Table 21: DDR4 measurement sources (cont.)

DDR measurements	DPOJET base measurement	Performed on	Additional required sources
Single Ended DQS			
tHZ(DQS)	DDR tHZDQ	Clock and DQS	DQ ‡
tLZ(DQS)	DDR tLZDQ	Clock and DQS	DQ ‡
Slew Rate DQ			
SRQse-Fall(DQ)	Fall Slew Rate	DQ	DQS ‡
SRQse-Rise(DQ)	Rise Slew Rate	DQ	DQS ‡
Clock (Diff)			
tCH(abs)	Positive Width	Clock	None
tCH(avg)	DDR tCH(avg)	Clock	None
tCK(abs)	Period	Clock	None
tCK(avg)	DDR tCK(avg)	Clock	None
tCL(abs)	Negative Width	Clock	None
tCL(avg)	DDR tCL(avg)	Clock	None
tDVAC(CK)	Time Outside Level	CK	None
tERR	DDR tERR	Clock	None
tJIT(cc)	CC-Period	Clock	None
tJIT(duty)	DDR tJIT(duty)	Clock	None
tJIT(per)	DDR tJIT(per)	Clock	None
Clock (Single Ended)			
AC-Overshoot(CK#)	Overshoot	Clock#	None
AC-Overshoot(CK)	Overshoot	Clock	None
AC-OvershootArea(CK#)	DDR Over Area	Clock#	None
AC-OvershootArea(CK)	DDR Over Area	Clock	None
AC-Undershoot(CK#)	Undershoot	Clock#	None
AC-Undershoot(CK)	Undershoot	Clock	None
AC-UndershootArea(CK#)	DDR Under Area	Clock#	None
AC-UndershootArea(CK)	DDR Under Area	Clock	None
Vix(ac)CK	V-Diff-Xovr	Clock and Clock#	None
VSEH(CK#)	Cycle Max	CK#	None
VSEH(CK)	Cycle Max	CK	None
VSEL(CK#)	Cycle Min	CK#	None
VSEL(CK)	Cycle Min	CK	None
DQS (Single Ended)			
AC-OvershootArea(DQ)	DDR Over Area	DQ	DQS
AC-UndershootArea(DQ)	DDR Under Area	DQ	DQS
AC-Overshoot(DQ)	Overshoot	DQ	DQS
AC-Undershoot(DQ)	Undershoot	DQ	DQS

Table 21: DDR4 measurement sources (cont.)

DDR measurements	DPOJET base measurement	Performed on	Additional required sources
AC-Overshoot(DQS#)	Overshoot	DQS#	DQ, DQS
AC-Overshoot(DQS)	Overshoot	DQS	DQ ‡
AC-OvershootArea(DQS#)	DDR Over Area	DQS#	DQ, DQS
AC-OvershootArea(DQS)	DDR Over Area	DQS	DQ ‡
AC-Undershoot(DQS#)	Undershoot	DQS#	DQ, DQS
AC-Undershoot(DQS)	Undershoot	DQS	DQ ‡
AC-Under-shootArea(DQS#)	DDR Under Area	DQS#	DQ, DQS
AC-UndershootArea(DQS)	DDR Under Area	DQS	DQ ‡
VSEH(DQS#)	Cycle Max	DQS#	DQ, DQS
VSEH(DQS)	Cycle Max	DQS	DQ ‡
VSEL(DQS#)	Cycle Min	DQS#	DQ, DQS
VSEL(DQS)	Cycle Min	DQS	DQ ‡
Address/Command Measurements			
AC-Overshoot	Overshoot	Addr/Cmd	None
AC-OvershootArea	DDR Over Area	Addr/Cmd	None
AC-Undershoot	Undershoot	Addr/Cmd	None
AC-UndershootArea	DDR Under Area	Addr/Cmd	None
tIPW-High	High Time	Clock and Addr/Cmd	None
tIPW-Low	Low Time	Clock and Addr/Cmd	None

‡ Required so that the Search-and-Mark feature can properly identify bursts

GDDR5 Measurement Sources

The sources required for analysis may include DQ, WCK, WCK#, CK, CK#, WE, CS, CAS, RAS, CKE, and Addr/Cmd.

The following table lists the sources required for each GDDR5 measurement:

Table 22: GDDR5 measurement sources

DDR measurements	DPOJET base measurement	Performed on	Additional required sources
Write Bursts			
Data Eye Width	Eye Width	DQ and WCK	None
Data Eye Height	Eye Height	DQ and WCK	None
tWRPDE	tBurstToCMD	CK	WE, CS, CAS, RAS, CKE
tWRSRE	tBurstToCMD	CK	WE, CS, CAS, RAS, CKE
Read Bursts			
Data Eye Height	Eye Height	DQ and WCK	None
Data Eye Width	Eye Width	DQ and WCK	None
tRDPDE	tBurstToCMD	CK	WE, CS, CAS, RAS, CKE
tRDSRE	tBurstToCMD	CK	WE, CS, CAS, RAS, CKE
WCK (Single Ended)			
Vin(WCK#)	High-Low	WCK#	None
VIN(WCK)	High-Low	WCK	None
Vix(ac)WCK	V-Diff-Xovr	WCK, WCK#	None
VOH(WCK#)	High	WCK#	None
VOH(WCK)	High	WCK	None
VOL(WCK#)	Low	WCK#	None
VOL(WCK)	Low	WCK	None
WCK Slew-Fall(WCK#)	Fall Slew Rate	WCK#	None
WCK Slew-Fall(WCK)	Fall Slew Rate	WCK	None
WCK Slew-Rise(WCK#)	Rise Slew Rate	WCK#	None
WCK Slew-Rise(WCK)	Rise Slew Rate	WCK	None
WCK (Diff)			
SSC Downspread(WCK)	SSC-Freq-DEV	WCK	None
SSC Mod Freq(WCK)	SSC-MOD-FREQ	WCK	None
SSC Profile(WCK)	SSC-PROFILE	WCK	None
tDVAC(WCK)	Time Outside Level	WCK	None
tJIT(cc)	CC-Period	WCK	None
tJIT(per)	DDR tJIT(per)	WCK	None
tWCK	Period	WCK	None

Table 22: GDDR5 measurement sources (cont.)

DDR measurements	DPOJET base measurement	Performed on	Additional required sources
tWCK-DJ	TJ@BER	WCK	None
tWCK-Fall-Slew	Fall Slew Rate	WCK	None
tWCKH	Positive and Negative Width	WCK	None
tWCKHP	Period	WCK	None
tWCKL	Positive and Negative Width	WCK	None
tWCK-Rise-Slew	Rise Slew Rate	WCK	None
tWCK-RJ	RJ	WCK	None
tWCK-TJ	TJ@BER	WCK	None
VWCK-SWING	High-Low	WCK	None
Clock(Diff)			
SSC Downspread(CK)	SSC-FREQ-DEV	CK	None
SSC Mod Freq(CK)	SSC-MOD-FREQ	CK	None
SSC Profile(CK)	SSC-PROFILE	CK	None
tCH	Pos Width	CK	None
tCK	Period	CK	None
tCL	Neg Width	CK	None
tDVAC(CK)	Time Outside Level	CK	None
tHP	Period	CK	None
tJIT(cc)	CC-Period	CK	None
tJIT(per)	DDR tJIT(per)	CK	None
Clock(Single Ended)			
CKslew-Fall(CK#)	Fall Slew Rate	CK#	None
CKslew-Fall(CK)	Fall Slew Rate	CK	None
CKslew-Rise(CK#)	Rise Slew Rate	CK#	None
CKslew-Rise(CK)	Rise Slew Rate	CK	None
VIN(CK#)	High-Low	CK#	None
VIN(CK)	High-Low	CK	None
Vix(ac)CK	V-Diff-Xovr	CK and CK#	None
Address/Command Measurements			
tAH	Hold	CK, Addr./Cmd	None
tAPW	Period	Addr/Cmd	None
tAS	Setup	CK, Addr./Cmd	None
tCMDH	Hole	CK, Addr./Cmd	None
tCMDPW	Period	CK, Addr./Cmd	None
tCMDS	Setup	CK, Addr./Cmd	None

Table 22: GDDR5 measurement sources (cont.)

DDR measurements	DPOJET base measurement	Performed on	Additional required sources
Refresh			
tCKSRE	tCKSRE	CK	WE, CS, CAS, RAS, CKE
tCKSRX	tCKSRX	CK	WE, CS, CAS, RAS, CKE
tREFTR(Read)	tCMD-CMD	CK	WE, CS, CAS, RAS, CKE
tREFTR(Write)	tCMD-CMD	CK	WE, CS, CAS, RAS, CKE
tRFC	tCMD-CMD	CK	WE, CS, CAS, RAS, CKE
tXSNRW	tCMD-CMD	CK	WE, CS, CAS, RAS, CKE
Power Down			
tPD	tCMD-CMD	CK	WE, CS, CAS, RAS, CKE
Active			
tRAS	tCMD-CMD	CK	WE, CS, CAS, RAS, CKE
tRC	tCMD-CMD	CK	WE, CS, CAS, RAS, CKE
tRCDRD	tCMD-CMD	CK	WE, CS, CAS, RAS, CKE
tRCDWR	tCMD-CMD	CK	WE, CS, CAS, RAS, CKE
Precharge			
tPPD	tCMD-CMD	CK	WE, CS, CAS, RAS, CKE
tRP(ACT)	tCMD-CMD	CK	WE, CS, CAS, RAS, CKE
tRP(MRS)	tCMD-CMD	CK	WE, CS, CAS, RAS, CKE
tRP(REP)	tCMD-CMD	CK	WE, CS, CAS, RAS, CKE
tRP(SRE)	tCMD-CMD	CK	WE, CS, CAS, RAS, CKE
tRTPL	tCMD-CMD	CK	WE, CS, CAS, RAS, CKE

Measurement Range Limits

The following tables lists the measurement range limits of DDR measurements for different data rates:

NOTE. *Measurement Range Limits are provided for each measurement under the General configure tab of the DPOJET application. These range limits are always ON (OFF is disabled) for two source measurements such as Skew, Setup, Hold and others. The range limits are used by the algorithms to associate valid edge of first source to the valid edge of the second source.*

Data Rate	1 UI	2 UI
200 MT/s	5 ns	10 ns
266 MT/s	3.7594 ns	7.5188 ns
333 MT/s	3.003 ns	6.006 ns
370 MT/s	2.702 ns	5.404 ns
400 MT/s	2.5 ns	5 ns
533 MT/s	1.875 ns	3.75 ns
667 MT/s	1.4995 ns	2.999 ns
800 MT/s	1.25 ns	2.5 ns
1333 MT/s	0.75 ns	1.5 ns
1600 MT/s	0.625 ns	1.25 ns
1866 MT/s	0.535 ns	1.071 ns
2133 MT/s	0.468 ns	0.937 ns

The following measurements have different range limits as shown:

Table 23: Measurement range limits

Measurement	Maximum	Minimum
tDQSK-Diff	UI	-UI
tDQSQ-Diff	UI / 2	-UI / 2
tAC-Diff	UI / 2	-UI / 2
tDQSK-SE	UI	-UI
tDQSQ-SE	UI / 2	-UI / 2
tDH-Diff(base)	UI	0
tDH-Diff(derated)	UI	0
tDQSS-Diff	UI	-UI
tDS-Diff(base)	UI	0
tDS-Diff(derated)	UI	0
tDSH-Diff	2 UI	0

Table 23: Measurement range limits (cont.)

Measurement	Maximum	Minimum
tDSS-Diff	2 UI	0
tDQSS-SE	UI	- UI
tDSH-SE	2 UI	0
tDSS-SE	2 UI	0
tDH-SE(base)	UI	0
tDH-SE(derated)	UI	0
tDS-SE(base)	UI	0
tDS-SE(derated)	UI	0
tIH(base)	2 UI	0
tIH(derated)	2 UI	0
tIS(base)	2 UI	0
tIS(derated)	2 UI	0
tQH	1.5 UI	UI / 2

Dynamic Limits for LPDDR Measurements

The following table lists the dynamic limits for LPDDR measurements, which are common for all LPDDR data rates. For more details, refer to the LPDDR JEDEC standard specification mentioned in the application *readme.txt*.

NOTE. *Dynamic limits are the same for all LPDDR data rates.*

Table 24: Dynamic limits for LPDDR

Measurement	Dynamic limits		
	Min	Max	Units
tCH	0.45	0.55	tCK
tCL	0.45	0.55	tCK
Vix(ac)CK	0.4 * Vdd	0.6 * Vdd	-
Vix(ac)DQS	0.4 * Vdd	0.6 * Vdd	-
Vid(ac)	0.6 * Vdd	*Vdd+0.6	-

Dynamic Limits for LPDDR2 Measurements

The following table lists the dynamic limits for LPDDR2 measurements. For more details, refer to the LPDDR2 JEDEC standard specification mentioned in the application *readme.txt*.

NOTE. Refer to the standard specific JEDEC document for derated measurements such as *tIS(derated)*, *tIH(derated)*, *tDS-Diff(derated)*, and *tDH-Diff(derated)* for calculating dynamic limits.

Table 25: Dynamic limits for LPDDR2

Measurement	Data rate (MT/s)	Dynamic limits		
		Min	Max	Units
tCH(avg)		0.45	0.55	tCK(avg)
tCL(avg)		0.45	0.55	tCK(avg)
tCH(abs)		0.43	0.57	tCK(avg)
tCL(abs)		0.43	0.57	tCK(avg)
tERR(13–50) ‡		$(1 + 0.68\ln(n)) * tJIT(per)min$	$(1 + 0.68\ln(n)) * tJIT(per)max$	ps
VSEH(AC)DQS	1066 to 466 MT/s	$(VDDQ / 2) + 0.220$	–	V
	400 to 200 MT/s	$(VDDQ / 2) + 0.300$	–	V
VSEH(AC)DQS#	1066 to 466 MT/s	$(VDDQ / 2) + 0.220$	–	V
	400 to 200 MT/s	$(VDDQ / 2) + 0.300$	–	V
VSEH(AC)CK	1066 to 466 MT/s	$(VDDQ / 2) + 0.220$	–	V
	400 to 200 MT/s	$(VDDQ / 2) + 0.300$	–	V
VSEH(AC)CK#	1066 to 466 MT/s	$(VDDQ / 2) + 0.220$	–	V
	400 to 200 MT/s	$(VDDQ / 2) + 0.300$	–	V
VSEL(AC)DQS	1066 to 466 MT/s	–	$(VDDQ / 2) - 0.220$	V
	400 to 200 MT/s	–	$(VDDQ / 2) - 0.300$	V
VSEL(AC)DQS#	1066 to 466 MT/s	–	$(VDDQ / 2) - 0.220$	V
	400 to 200 MT/s	–	$(VDDQ / 2) - 0.300$	V
VSEL(AC)CK	1066 to 466 MT/s	–	$(VDDQ / 2) - 0.220$	V
	400 to 200 MT/s	–	$(VDDQ / 2) - 0.300$	V
VSEL(AC)CK#	1066 to 466 MT/s	–	$(VDDQ / 2) - 0.220$	V
	400 to 200 MT/s	–	$(VDDQ / 2) - 0.300$	V

‡ Includes measurements from tERR13per to tERR50per

Dynamic Limits for LPDDR3 Measurements

The following table lists the dynamic limits for LPDDR3 measurements. For more details, refer to the LPDDR3 JEDEC standard specification mentioned in the application *readme.txt*.

NOTE. Refer to the standard specific JEDEC document for derated measurements such as $tIS(\text{derated})$, $tIH(\text{derated})$, $tDS\text{-Diff}(\text{derated})$, and $tDH\text{-Diff}(\text{derated})$ for calculating dynamic limits.

Table 26: Dynamic limits for LPDDR3

Measurement	Data rate (MT/s)	Dynamic limits		
		Min	Max	Units
tCH(avg)		0.45	0.55	tCK(avg)
tCL(avg)		0.45	0.55	tCK(avg)
tCH(abs)		0.43	0.57	tCK(avg)
tCL(abs)		0.43	0.57	tCK(avg)
tERR(13–50) ‡		$(1 + 0.68\ln(n)) \cdot tJIT(\text{per})\text{min}$	$(1 + 0.68\ln(n)) \cdot tJIT(\text{per})\text{max}$	ps
VSEH(DQS)		$(VDDQ / 2) + 0.150$	–	V
VSEH (DQS#)		$(VDDQ / 2) + 0.150$	–	V
VSEH(CK)		$(VDDQ / 2) + 0.150$	–	V
VSEH(CK#)		$(VDDQ / 2) + 0.150$	–	V
VSEL(DQS)		–	$(VDDQ / 2) + 0.150$	V
VSEL(DQS#)		–	$(VDDQ / 2) + 0.150$	V
VSEL(CK)		–	$(VDDQ / 2) + 0.150$	V
VSEL(CK#)		–	$(VDDQ / 2) + 0.150$	V
VSEH(AC)DQS		$(VDDQ / 2) + 0.150$	–	V
VSEH(AC)DQS#		$(VDDQ / 2) + 0.150$	–	V
VSEH(AC)CK		$(VDDQ / 2) + 0.150$	–	V
VSEH(AC)CK#		$(VDDQ / 2) + 0.150$	–	V
VSEL(AC)DQS		–	$(VDDQ / 2) - 0.150$	V
VSEL(AC)DQS#		–	$(VDDQ / 2) - 0.150$	V
VSEL(AC)CK		–	$(VDDQ / 2) - 0.150$	V
VSEL(AC)CK#		–	$(VDDQ / 2) - 0.150$	V

‡ Includes measurements from tERR13per to tERR50per

Dynamic Limits for DDR Measurements

The following table lists the dynamic limits for DDR measurements, which are common for all DDR data rates. For more details, refer to the DDR JEDEC standard specification mentioned in the application *readme.txt*.

NOTE. *Dynamic limits are the same for all DDR data rates.*

Table 27: Dynamic limits for DDR

Measurement	Dynamic limits		
	Min	Max	Units
tCH	0.45	0.55	tCK
tCL	0.45	0.55	tCK
Vix(ac)CK	$0.5 \cdot V_{dd} - 0.2$	$0.5 \cdot V_{dd} + 0.2$	–
Vix(ac)DQS	$0.5 \cdot V_{dd} - 0.2$	$0.5 \cdot V_{dd} + 0.2$	–
Vid(ac)	0.7	$V_{dd} + 0.6$	–

Dynamic Limits for DDR2 Measurements

The following table lists the dynamic limits for DDR2 measurements. For more details, refer to the DDR2 JEDEC standard specification mentioned in the application *readme.txt*.

NOTE. *Dynamic limits are the same for all DDR2 data rates except for those data rates specifically mentioned in the table.*

Table 28: Dynamic limits for DDR2

Measurement	Data rate (MT/s)	Dynamic limits		
		Min	Max	Units
tCH(avg)	667, 800	0.48	0.52	tCK(avg)
tCL(avg)	667, 800	0.48	0.52	tCK(avg)
tCH(abs)		0.45	0.55	–
tCL(abs)		0.45	0.55	–
tIPW		0.6	NA	–
Vix(ac)CK		$0.5 \times V_{dd} - 0.175$	$0.5 \times V_{dd} + 0.175$	–
Vix(ac)DQS		$0.5 \times V_{dd} - 0.175$	$0.5 \times V_{dd} + 0.175$	–
Vox(ac)CK		$0.5 \times V_{dd} - 0.125$	$0.5 \times V_{dd} + 0.125$	–
Vox(ac)DQS		$0.5 \times V_{dd} - 0.125$	$0.5 \times V_{dd} + 0.125$	–
Vid(ac)		0.5	V _{dd}	–

Dynamic Limits for DDR3 Measurements

The following table lists the dynamic limits for DDR3 measurements. For more details, refer to the DDR3 JEDEC standard specification mentioned in the application *readme.txt*.

NOTE. *Dynamic limits are the same for all DDR3 data rates.*

Table 29: Dynamic limits for DDR3

Measurement	Dynamic limits		
	Min	Max	Units
tCH(avg)	$0.47 * tCK(avg)$	$0.53 * tCK(avg)$	tCK(avg)
tCL(avg)	$0.47 * tCK(avg)$	$0.53 * tCK(avg)$	tCK(avg)
tCH(abs)	$0.43 * tCK(avg)$	NA	tCK(avg)
tCL(abs)	$0.43 * tCK(avg)$	NA	tCK(avg)
VSEH(DQS)	$(VDDQ / 2) + 0.175$	–	V
VSEH (DQS#)	$(VDDQ / 2) + 0.175$	–	V
VSEH(CK)	$(VDDQ / 2) + 0.175$	–	V
VSEH(CK#)	$(VDDQ / 2) + 0.175$	–	V
VSEL(DQS)	–	$(VDDQ / 2) - 0.175$	V
VSEL(DQS#)	–	$(VDDQ / 2) - 0.175$	V
VSEL(CK)	–	$(VDDQ / 2) - 0.175$	V
VSEL(CK#)	–	$(VDDQ / 2) - 0.175$	V
VSEH(AC)DQS	$(VDDQ / 2) + 0.175$	–	V
VSEH(AC)DQS#	$(VDDQ / 2) + 0.175$	–	V
VSEH(AC)CK	$(VDDQ / 2) + 0.175$	–	V
VSEH(AC)CK#	$(VDDQ / 2) + 0.175$	–	V
VSEL(AC)DQS	–	$(VDDQ / 2) - 0.175$	V
VSEL(AC)DQS#	–	$(VDDQ / 2) - 0.175$	V
VSEL(AC)CK	–	$(VDDQ / 2) - 0.175$	V
VSEL(AC)CK#	–	$(VDDQ / 2) - 0.175$	V

† Includes measurements from tERR13per to tERR50per

Dynamic Limits for DDR3L Measurements

The following table lists the dynamic limits for DDR3L measurements.

NOTE. *Dynamic limits are the same for all DDR3L data rates.*

Table 30: Dynamic limits for DDR3L

Measurement	Dynamic limits		
	Min	Max	Units
tCH(avg) †	$0.47 * tCK(avg)$	$0.53 * tCK(avg)$	tCK(avg)
tCL(avg) †	$0.47 * tCK(avg)$	$0.53 * tCK(avg)$	tCK(avg)
tCH(abs) †	$0.43 * tCK(avg)$	NA	tCK(avg)
tCL(abs) †	$0.43 * tCK(avg)$	NA	tCK(avg)
VSEH(DQS) †	$(VDDQ / 2) + 0.175$	–	V
VSEH (DQS#) †	$(VDDQ / 2) + 0.175$	–	V
VSEH(CK) †	$(VDDQ / 2) + 0.175$	–	V
VSEH(CK#) †	$(VDDQ / 2) + 0.175$	–	V
VSEL(DQS) †	–	$(VDDQ / 2) - 0.175$	V
VSEL(DQS#) †	–	$(VDDQ / 2) - 0.175$	V
VSEL(CK) †	–	$(VDDQ / 2) - 0.175$	V
VSEL(CK#) †	–	$(VDDQ / 2) - 0.175$	V
VSEH(AC)DQS †	$(VDDQ / 2) + 0.175$	–	V
VSEH(AC)DQS# †	$(VDDQ / 2) + 0.175$	–	V
VSEH(AC)CK †	$(VDDQ / 2) + 0.175$	–	V
VSEH(AC)CK#	$(VDDQ / 2) + 0.175$	–	V
VSEL(AC)DQS	–	$(VDDQ / 2) - 0.175$	V
VSEL(AC)DQS#	–	$(VDDQ / 2) - 0.175$	V
VSEL(AC)CK	–	$(VDDQ / 2) - 0.175$	V
VSEL(AC)CK#	–	$(VDDQ / 2) - 0.175$	V

† Supported in DDRA application but not called out JEDEC.

Dynamic Limits for DDR4 Measurements

The following table lists the dynamic limits for DDR4 measurements. For more details, refer to the DDR4 JEDEC standard specification mentioned in the application *readme.txt*.

NOTE. *Dynamic limits are the same for all DDR4 data rates.*

Table 31: Dynamic limits for DDR4

Measurement	Dynamic limits		
	Min	Max	Units
tCH(avg)	$0.48 * tCK(avg)$	$0.52 * tCK(avg)$	tCK(avg)
tCL(avg)	$0.48 * tCK(avg)$	$0.52 * tCK(avg)$	tCK(avg)
tCH(abs)	$0.45 * tCK(avg)$	NA	tCK(avg)
tCL(abs)	$0.45 * tCK(avg)$	NA	tCK(avg)
VSEH(DQS)	$(VDDQ / 2) + 0.175$	–	V
VSEH (DQS#)	$(VDDQ / 2) + 0.175$	–	V
VSEH(CK)	$(VDDQ / 2) + 0.175$	–	V
VSEH(CK#)	$(VDDQ / 2) + 0.175$	–	V
VSEL(DQS)	–	$(VDDQ / 2) - 0.175$	V
VSEL(DQS#)	–	$(VDDQ / 2) - 0.175$	V
VSEL(CK)	–	$(VDDQ / 2) - 0.175$	V
VSEL(CK#)	–	$(VDDQ / 2) - 0.175$	V

Vih/Vil Reference Levels

On clicking the View button, the VIH(ac)min, VIH(dc)min, VIL(ac)max, VIL(dc)max and VREF(dc) values are as shown based on the Vref voltage.

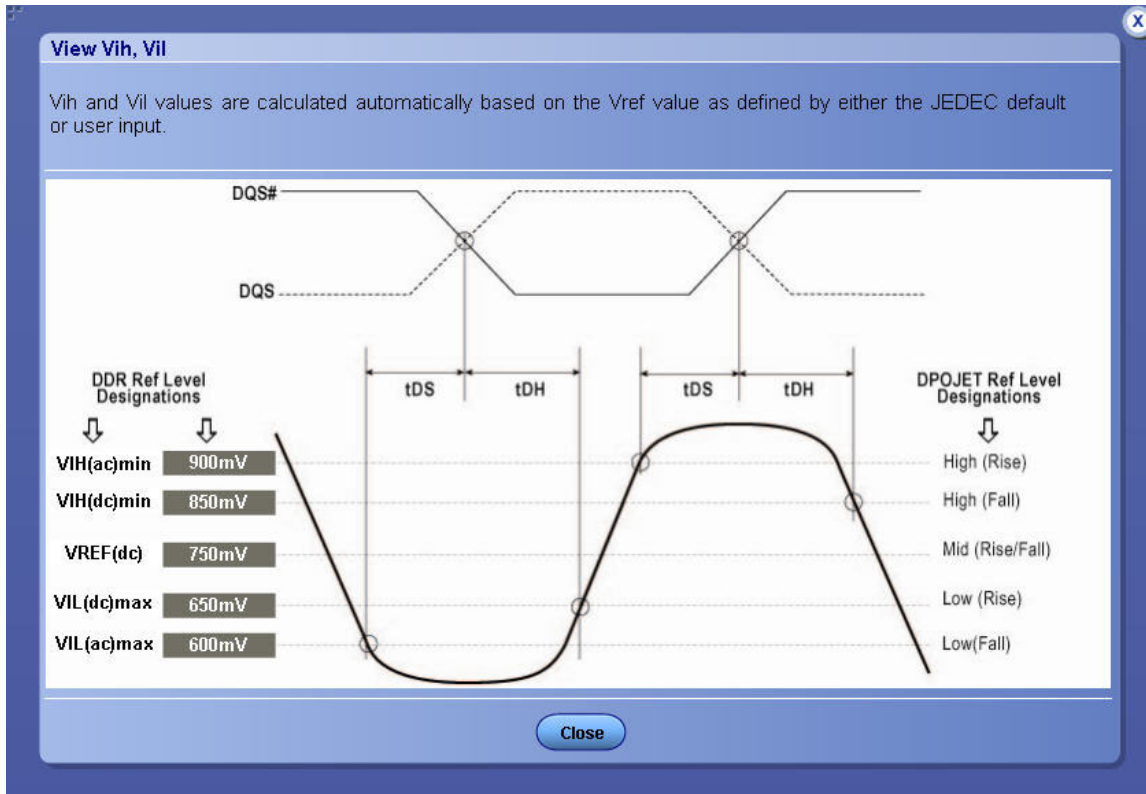

The following table lists the Vih and Vil values for all the DDR generations except GDDR3 and data rate:

Table 32: VIH and VIL values for DDR generations

Genera- tion	Data rate	VIH(ac)min	VIH(dc)min	VREF(dc)	VIL(dc) max	VIL(ac)max
DDR	200 MT/s	1.56 V	1.4 V	1.25 V	1.1 V	940 mV
	266 MT/s	1.56 V	1.4 V	1.25 V	1.1 V	940 mV
	333 MT/s	1.56 V	1.4 V	1.25 V	1.1 V	940 mV
	400 MT/s	1.61 V	1.45 V	1.3 V	1.15 V	990 mV
DDR2	400 MT/s	1.15 V	1.025 V	900 mV	775 mV	650 mV
	533 MT/s	1.15 V	1.025 V	900 mV	775 mV	650 mV
	667 MT/s	1.1 V	1.025 V	900 mV	775 mV	700 mV
	800 MT/s	1.1 V	1.025 V	900 mV	775 mV	700 mV
DDR3	800 MT/s	925 mV	850 mV	750 mV	650 mV	575 mV
	1066 MT/s	925 mV	850 mV	750 mV	650 mV	575 mV
	1333 MT/s	925 mV	850 mV	750 mV	650 mV	575 mV
	1600 MT/s	925 mV	850 mV	750 mV	650 mV	575 mV
	1866 MT/s	885 mV	850 mV	750 mV	650 mV	615 mV
	2133 MT/s	885 mV	850 mV	750 mV	650 mV	615 mV

Table 32: VIH and VIL values for DDR generations (cont.)

Genera- tion	Data rate	VIH(ac)min	VIH(dc)min	VREF(dc)	VIL(dc) max	VIL(ac)max
DDR3L	800 MT/s	835 mV	765 mV	675 mV	585 mV	515 mV
	1066 MT/s	835 mV	765 mV	675 mV	585 mV	515 mV
	1333 MT/s	835 mV	765 mV	675 mV	585 mV	515 mV
	1600 MT/s	835 mV	765 mV	675 mV	585 mV	515 mV
DDR4	1600 MT/s	735 mV	700 mV	600 mV	500 mV	465 mV
	1866 MT/s	735 mV	700 mV	600 mV	500 mV	465 mV
	2133 MT/s	735 mV	700 mV	600 mV	500 mV	465 mV
	2400 MT/s	735 mV	700 mV	600 mV	500 mV	465 mV
	2666 MT/s	735 mV	700 mV	600 mV	500 mV	465 mV
	3200 MT/s	735 mV	700 mV	600 mV	500 mV	465 mV
GDDR5	4000 MT/s	900 mV	850 mV	750 mV	650 mV	600 mV
	4800 MT/s	900 mV	850 mV	750 mV	650 mV	600 mV
	5000 MT/s	900 mV	850 mV	750 mV	650 mV	600 mV
	5500 MT/s	900 mV	850 mV	750 mV	650 mV	600 mV
LPDDR	200 MT/s	1.44 V	1.26 V	900 mV	540 mv	360 mV
	266 MT/s	1.44 V	1.26 V	900 mV	540 mv	360 mV
	333 MT/s	1.44 V	1.26 V	900 mV	540 mv	360 mV
	370 MT/s	1.44 V	1.26 V	900 mV	540 mv	360 mV
	400 MT/s	1.44 V	1.26 V	900 mV	540 mv	360 mV
LPDDR2	333 MT/s	900 mV	800 mV	600 mV	400 mV	300 mV
	400 MT/s	900 mV	800 mV	600 mV	400 mV	300 mV
	533 MT/s	820 mV	730 mV	600 mV	470 mV	380 mV
	667 MT/s	820 mV	730 mV	600 mV	470 mV	380 mV
	800 MT/s	820 mV	730 mV	600 mV	470 mV	380 mV
	933 MT/s	900 mV	800 mV	600 mV	400 mV	300 mV
	1066 MT/s	820 mV	730 mV	600 mV	470 mV	380 mV
LPDDR3	333 MT/s	750 mV	700 mV	600 mV	500 mV	450 mV
	800 MT/s	750 mV	700 mV	600 mV	500 mV	450 mV
	1066 MT/s	750 mV	700 mV	600 mV	500 mV	450 mV
	1200 MT/s	750 mV	700 mV	600 mV	500 mV	450 mV
	1333 MT/s	750 mV	700 mV	600 mV	500 mV	450 mV
	1466 MT/s	750 mV	700 mV	600 mV	500 mV	450 mV
	1600 MT/s	750 mV	700 mV	600 mV	500 mV	450 mV

Using Digital Channels

You must do the following steps when you select “Logic State+DQ/DQS Phase Alignment” burst detection method in an MSO oscilloscope. The DDR3 signal is an example here, but a few settings must be changed for other DDR standards. Using appropriate label names for digital signals (such as RS, CAS, CS and WE) helps in defining the sources in a bus.



NOTE. Refer “Setting Up Digital Channels” in your oscilloscope user manual for more details on how to set up digital channels.

Calculating Digital Channel Threshold

Follow the steps to calculate the digital channel threshold:

1. View the analog equivalent of the input digital signal (refer “Viewing Analog Characteristics of Digital Waveforms” in the MSO oscilloscope user manual).

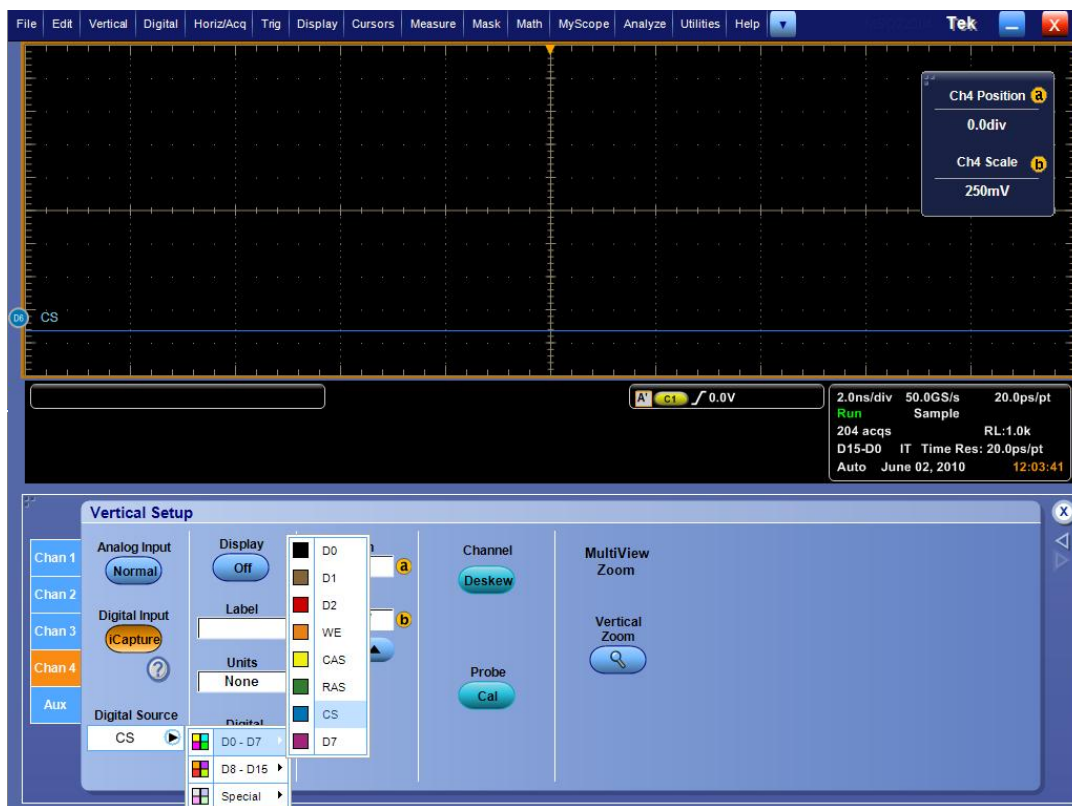

2. Measure the thresholds for the CS signal as shown in an example:
 - Measure the Min, and Pk-Pk on the analog waveform and calculate the threshold value approximately as follows:

$$\text{Threshold Value} = \text{Min} + 50\% \text{ of Pk-Pk.}$$
 - For example: If the measured Min value is 450 mV and Pk-Pk is 666 mV, using the above formula, the threshold value is set to 750 mV.
3. Enter the calculated threshold value in the Digital setup dialog box under Threshold.



NOTE. Thresholds are DUT specific. Carry out the same procedure for every DUT under test.

Configuring Sources for a Bus

The steps to configure source for a bus are:

1. Set up the bus (refer to “Set Up a Parallel Bus” in your MSO oscilloscope user manual)
2. Add sources to the bus. Ensure that the order of sources (MSB to LSB) is in sync with the sources mentioned in the corresponding symbol file.

For example: DDR3 symbol file specifies the following:

SYMBOL	MSB -> LSB
READ	0101
WRITE	0100

Set up the sources for these symbols as shown in the following figure:



Configuring Burst Latency and Tolerance

The following example shows how Burst Latency and Tolerance values are calculated using DDR3 1066 READ burst signal:

NOTE. Burst Latency and Tolerance values are specific to a DUT and should be computed for each DUT under test.

1. [Set up digital channels \(see page 118\)](#) and [configure the bus \(see page 120\)](#). Connect DQ/DQS to Ch1/Ch2 sources. Press **Single** on the oscilloscope front panel for signal acquisition.
2. Locate the READ burst and place the cursor in the centre of the burst. Place the second cursor on the first rising edge of the DQS signal as shown in the following figure:



- Note the time difference between the two cursors. In this example, it is 10.24 ns (called t_1) as shown in the following figure.
- Place the cursors on two consecutive rising/falling edges of the DQS signal as shown:



5. Note the time difference between the two cursors. It is 1.92 ns (called t_2) as shown in the above figure.
6. Calculate CAS Min using the equation:

$$\text{CAS Min} = t_1/t_2 - 0.5$$
 In the above example, CAS Min = $(10.24/1.92) - 0.5 \sim 5$ (approximately)
7. Calculate CAS Max using the equation:

$$\text{CAS Min} = t_1/t_2 + 0.5$$
 In the above example, CAS Min = $(10.24/1.92) + 0.5 \sim 6$ (approximately)
8. Configure CAS Min and Max values in DDRA as shown:



Providing inaccurate CAS Min and MAX values can result in an offset in Mark start/end calculations which in turn provides inaccurate measurement results. An example of incorrect CAS Min\Max values. is as follows:



NOTE. You can perform the above steps once and then save the setup. Setup files help to recall the settings corresponding to a particular DUT.

Error Codes and Warnings

Code	Description
E102	File does not exist.
E103	DPOJET is not able to open the help file. In order to use the help file, please reinstall DPOJET.
E104	Mask Hits measurement requires an Eye diagram plot but no more plots can be assigned. Please remove a plot before adding a Mask Hits measurement.
E105	The maximum number of plots you can select is 4.
E106	No Spectrum plot data is available.
E202	The upper range must be greater than the lower range.
E400	A measurement failed to complete successfully.
W410	Number of edges are not sufficient for a measurement.

Code	Description
E411	In at least one zone, there are too few edges to complete a measurement.
E424	No edges or UI of the required type were found in the waveform. If this is not a clock signal, check the Vref threshold and record length.
E425	No transitions of the selected Bit Type were found in the waveform.
E500	The record lengths of the source waveforms differ. Please configure for sources with equivalent record lengths.
E1001	Vertical Autoset Failed: Signal on Source x has extreme offset.
E1002	Vertical Autoset Failed: Amplitude of Source x is too small.
E1003	Vertical Autoset Failed: Amplitude or DC offset of Source x is too high.
E1004	Vertical Autoset Failed: No signal on Source x.
E1005	Vertical Autoset Failed: Signal on Source x exceeds top of scale.
E1006	Vertical Autoset Failed: Signal on Source x exceeds bottom of scale.
E1007	Vertical Autoset Failed: Signal on Source x is clipped on top.
E1008	Vertical Autoset Failed: Signal on Source x is clipped on bottom.
E1009	Vertical Autoset Failed: Measurement error (ISDB error code = 6) on Source x.
E1010	Vertical Autoset Failed: Measurement error (ISDB error code = 7) on Source x.
W1011	A change to Source x vertical settings caused overload disconnect. Original settings are restored and Source x is reconnected. Ignore oscilloscope message.
E1012	Vertical Autoset Failed: None of the selected measurements use live sources (Ch1-Ch4). Horizontal autoset works for live sources only.
E1013	Vertical Autoset Failed: Invalid signal on Source x.
E1020	Horizontal Autoset Failed: None of the selected measurements use live sources (Ch1-Ch4). Horizontal autoset works for live sources only.
E1021	Horizontal Autoset Failed: On Source x, cannot determine resolution of rising/falling edges.
E1022	Horizontal Autoset Failed: Horizontal resolution is at the maximum.
E1026	Horizontal Autoset Failed: Source amplitude too low.
E1027	Horizontal Autoset Failed: Signal is clipped at the top - positive clipping.
E1028	Horizontal Autoset Failed: Signal is clipped at the bottom - negative clipping.
E1029	Horizontal Autoset Failed: Signal frequency is extremely low.
E1035	Oscilloscope has gone into invalid state. Please restart the system.
E1040	Autoset Failed: None of the live sources (Ch1-Ch4) selected.
W1051	Ref Level Autoset: Waveform for the source x is clipped.
W1053	Ref Level Autoset: Source amplitude is extremely low.
E1054	Ref Level Autoset: Error in setting reference levels.
E1055	Ref Level Autoset Failed: No waveform to measure.
E1056	Ref Level Autoset: Unstable Histogram for waveform on source x.
E1057	Ref Level Autoset: No selected source.
E1058	Ref Level Autoset Failed: Invalid signal on source x.
E1059	Ref Level Autoset Error: Source x is not defined.

Code	Description
E1061	Since Digital Filters (DSP) are enabled, maximum sampling rate has been retained. To enable adaptive use of lower sampling rate, please choose Analog Only under Vertical . Bandwidth Enhanced.
E1062	The maximum Record Length (RL) in autoset is restricted to 25M, set the RL manually for >25M.
E1063	The minimum Record Length (RL) in autoset is restricted to 500K, set the RL manually for <500K.
E2001	The maximum number of measurements has been reached.
E2002	All the refs are used as sources by the measurements. Export to Ref is not possible.
E2003	Ref 'x' is already used as a measurement source.
E2004	Ref 'x' is already used as a destination for other measurement.
E2005	No measurement(s) are selected. Export to Ref is not possible.
E2006	No results available to export to ref.
E2007	There are no time trend results for the selected measurement(s).
E2008	No ref destination is selected. Results will not be exported to ref.
E3001	Could not open or create a log file. Please ensure that you have read/write permission to access log folders and files.
E3002	The specified path is invalid (for example: The specified path is not mapped to a drive).
E3003	The specified path, file name or both exceed the system defined length. For Example: On Windows-based platforms, the path name must be less than 248 characters and file names less than 260 characters.
E3004	The specified path directory is read-only or is not empty.
E3005	Please ensure that the file is currently not in use by other process and/or has not exceeded the file size limit.
E3006	Invalid filename: Check whether the file name contains a colon (:) in the middle of the string.
E3007	Select at least one measurement from the table before you save.
E3008	There are currently no results to save. Please run a measurement.
E3009	Current statistics is successfully saved at C:\TekApplications\DPOJET\Log\Statistics.
E3010	Access to file/directory denied. Please ensure that the file/directory has read/write permissions.
E3011	Mask Hits Measurements will not be selected as this feature is not available for Mask Hits measurement.
E3012	Folder does not exist.
E4000	Not enough data points. Unable to render plot(s).
E4001	Internal measurement error. Please remove a measurement and try again.
E4002	Not enough data points for spectrum computation.
E4003	Due to high memory usage, only a portion of the waveform could be processed. Please reduce your record length or the number of measurements.
E4004	An error occurred in the edge extraction process.
E4005	Qualifier: The record length and sample interval must match across the waveforms.

Code	Description
E4006	A maximum of 4096 qualifier zones is supported. The entire waveform will not be processed and hence partial measurement results are available.
E4007	Logic Qualifier enabled and no qualifier zones found.
W4008	The configured Ref voltage for Overshoot must be greater than or equal to the mid autoset ref levels.
W4009	The configured Ref voltage for Undershoot must be lesser than or equal to the mid autoset ref levels.
E4013	The configured Ref voltage must be greater than or equal to the mid autoset ref levels.
E4014	The configured Ref voltage must be lesser than or equal to the mid autoset ref levels.
E4015 †OMING	One or more qualifier zones had too few edges for measurement calculation.
E4016	Not enough edges in the waveform for measurement calculation.
E4017	Qualifier not enabled and hence no qualifier zones found. Please enable the qualifier.
E4018	The preamble is incomplete in all the qualifier zones.
E4019 †	The preamble is incomplete in one or more qualifier zones.
E4020	The postamble is incomplete in all the qualifier zones.
E4021	The postamble is incomplete in one or more qualifier zones. Displays the zone number (x) for which the preamble/postamble fails.
E4022 †	Not enough samples present in the qualifier zones. Please increase the sampling rate and reacquire the waveform.
E4023	The configured ref levels are not correct. The high ref level should be \geq Mid and Mid should be \geq Low for both Rise and Fall slopes. Reconfigure the ref levels and run the measurement.
E4024	Could not compute proper High and Low values.
W4025	The signal does not cross the configured Ref Voltage and hence the result shows zero population. Please adjust the Ref voltage value.
E4027	From Symbol not found in the acquisition.
E4028	To Symbol not found in the acquisition.
E4029	The configured High Ref voltage must be \geq to the mid autoset ref levels.
E4030	The configured Low Ref voltage must be \leq to the mid autoset ref levels.
E4031	The configured High Ref voltage must be \geq to the mid autoset ref levels and the configured Low Ref voltage must be \leq to the mid autoset ref levels.
E5005 ¹	Occurs while running setup. Please make sure you have finished any previous setup and closed other applications
W5005	The path or file name exceeds the system limit of 260 characters.
E9004	Derating will not be applied to the limits as Slew Rate measurements failed.
W9005	Derating value calculated using single Slew Rate measurement value.
W9006	Derating value cannot be computed since the calculated Slew Rate is not present in the derating table †.
E9007	Derating Error*.

* Slew Rate measurements used to calculate the derated value failed to Run as there are no sufficient edges on the Rise and Fall slopes of the waveform.

- Base measurement limits are not defined as per the specification.
- † Signal Slew Rate value is outside the derating table (Ex: If DDR2-800 MT/s tDS derating with a differential probe has a DQS differential slew rate of 0.65 V/ns, this warning message is displayed as the derating table definition starts from 0.8 V/ns).
Derating value is "not supported" (TBD) in the specification (Ex: If the DQS differential slew rate is 2.0 V/ns and the DQ slew rate is 0.7 V/ns, then the value is "-"(TBD).
Derating will not be applied for the above cases and the base limit will be displayed in the results table.
 - ‡ Displays the zone number (x) for which the preamble/postamble fails.
 - 1 This error occurs during DPOJET installation on a DPO/MSO series of oscilloscopes. Delete the Installshield folder under C:\Program files\Common Files and delete all files and folders under C:\Windows\Temp folder. Restart the installation again.

About Algorithms

The DDRA application can take measurements by selecting either Clock, Strobe, Data or CS Source as sources. The number of waveforms used by the application depends on the type of measurement being taken.

Oscilloscope Setup Guidelines

For all measurements, use the following guidelines to set up the oscilloscope:

- The signal is any channel, reference, or math waveform.
- The vertical scale for the waveform must be set so that the waveform does not exceed the vertical range of the oscilloscope.
- The sample rate must be set to capture sufficient waveform detail and avoid aliasing.
- Longer record lengths increase measurement accuracy but the oscilloscope takes longer to measure each waveform.

Search and Mark Algorithms

DDR search algorithms look for patterns in data (DQ) to determine start and end of bursts. All searches use histogram analysis around edges found in the waveform, where edges are determined using the supplied min/max/mid levels. These levels and the speed grade are configurable in the DDRA application's first and fifth steps.

DDR search operates by scanning through both DQ and DQS and measuring peak to peak voltage and mid-levels. The mid-level detected on DQS is then used with a 10% hysteresis band to extract the edges from the DQS signal. These edges are stored and are then used for bit rate estimation.

All DDR searches use waveform shape expectations to determine start or stop of a Read and Write burst. The application will scan for first the start of any burst, followed by that burst's termination condition. Once a start condition has been found, only the termination condition will be searched for until the end-of-record.

tDQSS

tDQSS is different from the tDQSS-Diff supported for other generations like DDR2, DDR3. tDQSS measures the time taken from the WRITE event in the DDR bus to the first DQS latching transition. This measurement has two sources. One bus source (B1) and a DQS source (analog). Additionally we need a DQ source for DDR Write burst detection.

Measurement internally sets up a Bus search to look for WRITE events. For every WRITE event in the bus search output, the algorithm finds and associates the first rising edge of DQS within the DDR Write burst.

This measurement is available only on 64-bit MSO instruments. Measurement gets selected only if there is a bus source configured.

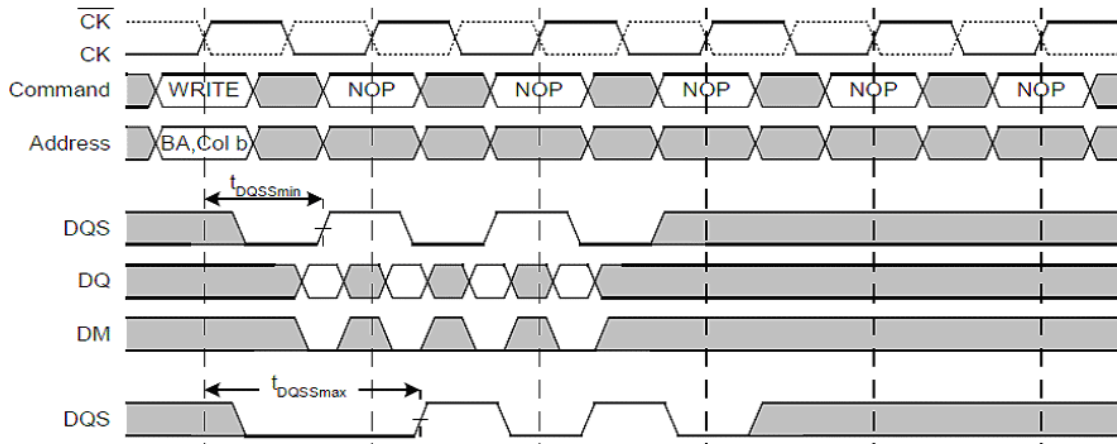

Data Eye Width

Data Eye Width is common for both Read and Write bursts. The type of burst is determined by the ASM settings. If a waveform contains multiple bursts of the same kind, the Data Eye Width is calculated and respective Eye Diagram rendered for all bursts within one acquisition. It uses the DPOJET measurement, Eye width with eye diagram plot enabled. Set DQ to Data signal and DQS to explicit clock edge.

By default, the DQS eye will be rendered under the DQ eye in an orange monochrome color. The DQS eye can be turned off from the Eye diagram plot configuration panel. For Write bursts, the DQS eye is offset from the Data eye (crossing in the center), whereas eye diagrams overlap for Read bursts. The relative positions of the eye diagrams can be controlled using the Ref Clock alignment property on the Eye diagram plot configuration panel. The left and center options indicate where the DQS crossing shall be located so that Data Eye will maintain its normal position. Left is suitable for Read bursts and center for Write bursts. Use Auto to automatically determine the offset property.

For more details, refer to the topic “Eye Width” of the DPOJET help.

Data Eye Height

Data Eye Height is common for both Read and Write bursts. The type of burst is determined by the ASM settings. If a waveform contains multiple bursts of the same kind, the Data Eye Height is calculated and the Eye Diagram rendered for all bursts within one acquisition. Set DQ to Data signal and DQS to explicit clock edge.

By default, the DQS eye will be rendered under the DQ eye in orange monochrome color. The DQS eye can be turned off from the Eye diagram plot configuration panel. For Write bursts, the DQS eye is offset from the Data eye (crossing in the center), whereas eye diagrams overlap for Read bursts. The relative positions of the eye diagrams might be controlled using the Ref Clock alignment property on the Eye diagram plot configuration panel. The left and center options indicate where the DQS crossing shall be located so that Data Eye will maintain its normal position. Left is suitable for Read bursts and center for Write bursts. Use Auto to automatically determine the offset property.

NOTE. *When you select “Vertical Scale to Data” in the eye diagram plot configuration, it is possible that the DQS signal can be clipped both at the top and bottom of the eye diagram. The Eye diagram is enabled only when you select the Eye Width measurement along with Eye Height. The Eye diagram plot is disabled when you select only Eye Height.*

For more details, refer to the topic “Eye Height” of the DPOJET help.

Input Slew-Diff-Rise(DQS)

Input Slew-Diff-Rise(DQS) measures slew rate on differential DQS signals between the rising edges from low to high.

Input Slew-Diff-Rise(DQS) uses the DPOJET measurement, Rise Slew Rate.

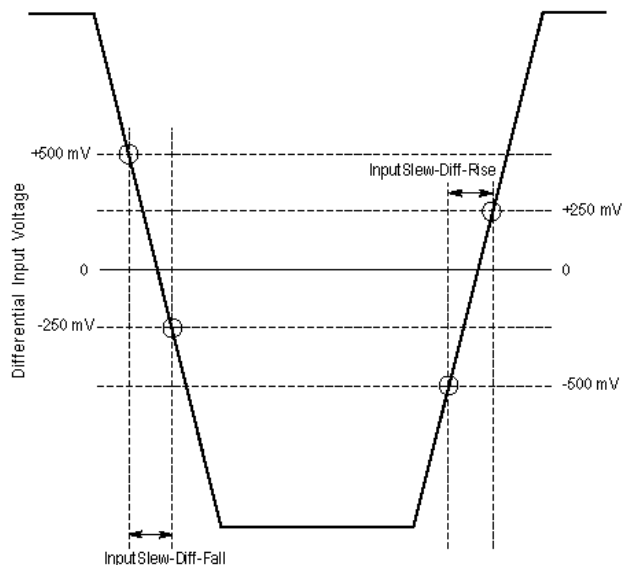

NOTE. The above figure is applicable for all DDR2 Slew Rate(Diff) measurements.

For more details, refer to the topic “Rise Slew Rate” of the DPOJET help.

Input Slew-Diff-Fall(DQS)

Input Slew-Diff-Fall(DQS) measures slew rate on differential DQS signals between the falling edges from high to low.

Input Slew-Diff-Fall(DQS) uses the DPOJET measurement, Fall Slew Rate.

For more details, refer to the topic “Fall Slew Rate” of the DPOJET help.

tDH-Diff(base)

tDH-Diff(base) is defined as the input hold time between Data (DQ) and Differential Strobe (DQS) signal. It is the elapsed time taken from the mid-level of the DQS signal to the specific level ($V_{IH(dc)}$ and $V_{IL(dc)}$, where $V_{IH(dc)}$ is on a falling slope of DQ signal and $V_{IL(dc)}$ is on a rising slope of the DQ signal). This measurement requires you to set up correct reference levels for DQS and DQ signals for different speeds. The DDRA application will set up these levels automatically when “JEDEC Default” mode is selected. When “User Defined” mode is selected, then these reference levels are calculated based on your input for V_{ref} and V_{dd} .

tDH-Diff(base) uses the DPOJET measurement, DDR-Hold-Diff.

For more details, refer to the topic “DDR-Hold-Diff” of the DPOJET help.

tDH-Diff(derated)

Derating limits are calculated by adding the tDH(base) limit and $\Delta t_{DH}(\text{derating})$ value. Δt_{DH} for a rising signal is defined as the slew rate between the last crossing of $V_{IL(dc)max}$ and the first crossing of $V_{REF(dc)}$, and for a falling signal is defined as the slew rate between the last crossing of $V_{IH(dc)min}$ and the first crossing of $V_{REF(dc)}$.

tDH-Diff(derated) uses the DPOJET measurement, DDR-Hold-Diff, to calculate the base value.

For more details, refer to the topic “DDR-Hold-Diff” of the DPOJET help.

tDH-Diff(Vref-based)

tDH-Diff(Vref-based) is defined as the elapsed time from V_{ref} of the DQS signal to the V_{ref} of the DQ signal. This is the only tDH measurement that does not use the V_{ih} and V_{il} thresholds.

tDH-Diff(derated) uses the DPOJET measurement, Hold.

For more details, refer to the topic “Hold” of the DPOJET help.

tDS-Diff(base)

tDS-Diff(base) is defined as the input setup time between DQ and differential DQS signal. It is the elapsed time taken from the mid-level of the DQS signal to the specific level ($V_{IH(ac)}$ and $V_{IL(ac)}$, where $V_{IH(ac)}$ is on a falling slope of DQ signal and $V_{IL(ac)}$ is on a rising slope of the DQ signal).

tDS-Diff(base) uses the DPOJET measurement, DDR Setup-Diff.

For more details, refer to the topic “DDR-Setup-Diff” of the DPOJET help.

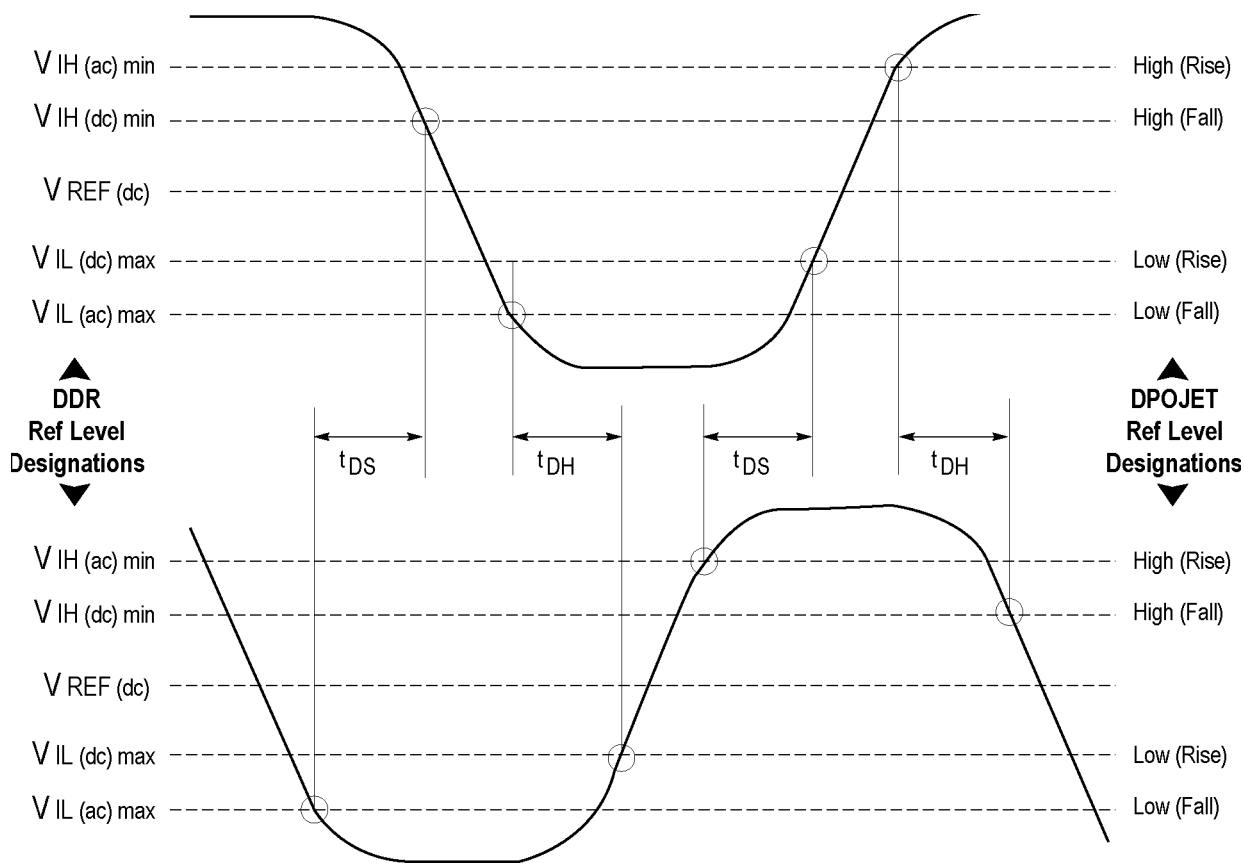

The configured values of Vdd and Vref are used to calculate $V_{IH(ac)min}$, $V_{IH(dc)min}$, $V_{IL(dc)max}$ and $V_{IL(ac)max}$, which are applied on the input signal. These levels are further used for calculating Setup and Hold measurements.

The relationship between Vdd and Vref for DDR2 standard is as shown in the following tables. For other DDR standards, please refer to their JEDEC specifications.

Table 33: Input DC logic Level

Symbol	Parameter	Min	Max	Units
$V_{IH(dc)}$	DC input logic high	$V_{ref}+0.125$	–	V
$V_{IL(dc)}$	DC input logic low	–0.3	$V_{ref}-0.125$	V

Table 34: Input AC logic Level

Symbol	Parameter	DDR2-400, DDR2-533		DDR2-667,DDR2-800		Units
		Min	Max	Min	Max	
$V_{IH(ac)}$	AC input logic high	Vref+0.250	x	Vref+0.200	–	V
$V_{IL(ac)}$	AC input logic low	–	Vref-0.250	–	Vref+0.200	V

tDS-Diff(derated)

Derating limits are calculated by adding the tDS(base) limit and ΔtDS (derating) value.. ΔtDS for a rising signal is defined as the slew rate between the last crossing of $V_{REF(dc)}$ and the first crossing of $V_{IH(ac)min}$, and for a falling signal is defined as the slew rate between the last crossing of $V_{REF(dc)}$ and the first crossing of $V_{IL(ac)max}$ and the first crossing of $V_{IL(ac)max}$.

tDS-Diff(derated) uses the DPOJET measurement, DDR-Setup-Diff, to calculate the base value.

For more details, refer to the topic “DDR-Setup-Diff” of the DPOJET help.

tDS-Diff(Vref-based)

tDS-Diff(Vref-based) is defined as the elapsed time from Vref of the DQ signal to the Vref of the DQS signal. This is the only tDS measurement that does not use Vih and Vil thresholds.

tDS-Diff(Vref-based) uses the DPOJET measurement, Setup.

For more details, refer to the topic “Setup” of the DPOJET help.

tDQSH

tDQSH is the high pulse width on the DQS(Strobe) input. Amount of time the waveform remains above the mid reference voltage level.

tDQSH uses the DPOJET measurement, Pos Width.

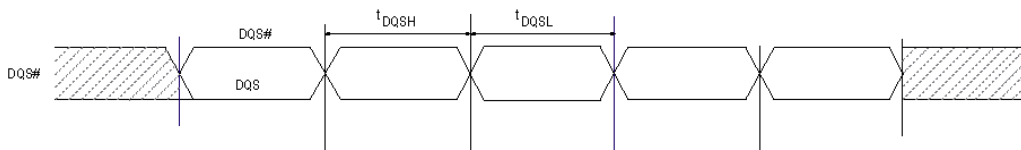

For more details, refer to the topic “Positive and Negative Width” of the DPOJET help.

tDQSL

tDQSL is the low pulse width on the DQS(Strobe) input. Amount of time the waveform remains below the mid reference voltage level.

tDQSL uses the DPOJET measurement, Neg Width.

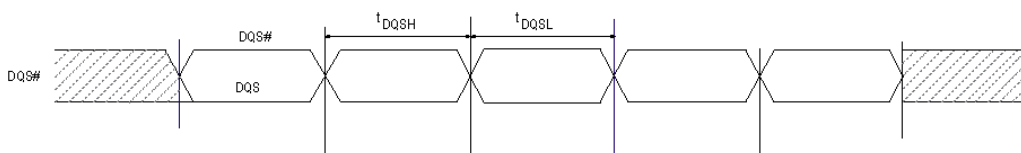

For more details, refer to the topic “Positive and Negative Width” of the DPOJET help.

tDSS-Diff

tDSS-Diff is defined as the elapsed setup time from the DQS falling edge to the clock rising edge.

tDSS-Diff uses the DPOJET measurement, Setup.

For more details, refer to the topic “Setup” of the DPOJET help.

tDSH-Diff

tDSH-Diff is defined as the elapsed time from the clock rising edge to the DQS falling edge.

tDSH-Diff uses the DPOJET measurement, Hold.

For more details, refer to the topic “Hold” of the DPOJET help.

tDQSS-Diff

tDQSS-Diff is defined as the elapsed time from the DQS rising edge to the clock rising edge.

tDQSS-Diff uses the DPOJET measurement, Skew.

For more details, refer to the topic “Skew” of the DPOJET help.

Slew Rate-Hold-SE-Fall(DQS)

Slew Rate-Hold-SE-Fall(DQS) measures the slew rate on the DQS-SE signal between the falling edge from V_{REF} to $V_{IL(ac)max}$.

Slew Rate-Hold-SE-Fall(DQS) uses the DPOJET measurement, Fall Slew Rate.

For more details, refer to the topic “Fall Slew Rate” of the DPOJET help.

Slew Rate-Hold-SE-Rise(DQS)

Slew Rate-Hold-SE-Rise(DQS) measures the slew rate on the DQS-SE signal between the rising edge from V_{REF} to $V_{IH(ac)min}$.

Slew Rate-Hold-SE-Rise(DQS) uses the DPOJET measurement, Rise Slew Rate.

For more details, refer to the topic “Rise Slew Rate” of the DPOJET help.

Slew Rate-Setup-SE-Fall(DQS)

Slew Rate-Setup-SE-Fall(DQS) measures the slew rate on the DQS-SE signal between the falling edge from V_{REF} to $V_{IL(ac)max}$.

Slew Rate-Setup-SE-Fall(DQS) uses the DPOJET measurement, Fall Slew Rate.

For more details, refer to the topic “Fall Slew Rate” of the DPOJET help.

Slew Rate-Setup-SE-Rise(DQS)

Slew Rate-Setup-SE-Rise(DQS) measures the slew rate on the DQS-SE signal between the rising edge from V_{REF} to $V_{IH(ac)min}$.

Slew Rate-Setup-SE-Rise(DQS) uses the DPOJET measurement, Rise Slew Rate.

For more details, refer to the topic “Rise Slew Rate” of the DPOJET help.

tDS-SE(base)

tDS-SE(base) is the input setup time between DQ and single-ended DQS signal. It is the elapsed time between $V_{IH(dc)min}$ of DQS and $V_{IL(ac)max}$ of DQ.

tDS-SE(base) uses the DPOJET measurement, DDR-Setup-SE.

For more details, refer to the topic “DDR-Setup-SE” of the DPOJET help.

tDIPW-SE

tDIPW-SE is defined as the input pulse width on the DQ or DBI# signal.

tDIPW-SE uses the DPOJET measurement, High Time.

For more details, refer to the topic “High Time” of the DPOJET help.

tDSS-SE

tDSS-SE is defined as the elapsed setup time from the DQS falling edge to the clock rising edge.

tDSS-SE uses the DPOJET measurement, Setup.

For more details, refer to the topic “Setup” of the DPOJET help.

tDSH-SE

tDSH-SE is defined as the elapsed time from the clock rising edge to the DQS falling edge.

tDSH-SE uses the DPOJET measurement, Hold.

For more details, refer to the topic “Hold” of the DPOJET help.

tDQSS-SE

tDQSS-SE is defined as the elapsed time from the DQS rising edge to the clock rising edge.

tDQSS-SE uses the DPOJET measurement, Skew.

For more details, refer to the topic “Skew” of the DPOJET help.

tDH-SE(base)

tDH-SE(base) is defined as the input hold time between DQ and single-ended DQS signal.

tDH-SE(base) uses the DPOJET measurement, DDR-Hold-SE.

For more details, refer to the topic “DDR-Hold-SE” of the DPOJET help.

tDVAC(CK)

tDVAC(CK) is defined as the allowed time before ring back of CK below VIDCK/WCK (AC) reference levels.

tDVAC(CK) uses the DPOJET measurement, Time Outside Level. tDVAC(CK) is used for GDDR5 generation.

For more details, refer to the topic “Time Outside Level” of the DPOJET help.

tWPRE

tWPRE is defined as the elapsed time on a DQS signal between tWPRE_begin and tWPRE_end. This measurement is common for all DDR generation except DDR3.

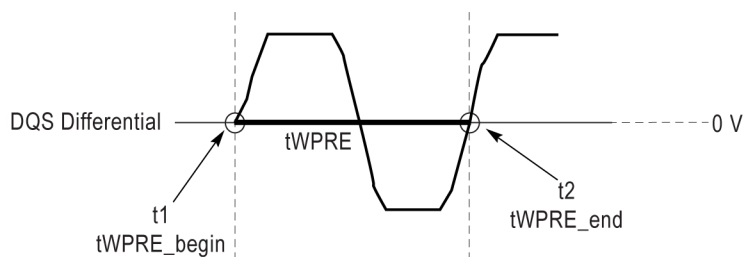

tWPRE uses the DPOJET measurement, DDR tRPRE for DDR, DDR2, LPDDR and LPDDR2 generations.

For more details, refer to the topic “DDR tRPRE” of the DPOJET help.

For DDR3 generation, tWPRE is based on the DPOJET measurement, DDR tWPRE.

For more details, refer to the topic “DDR tWPRE” of the DPOJET help.

tWPST

tWPST is defined as the elapsed time between tWPST_begin and tWPST_end.

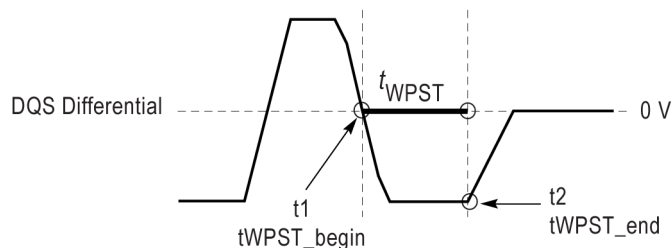

tWPST uses the DPOJET measurement, DDR tPST.

The application calculates this measurement using the following equation:

$$tWPST = t_{2(n)} - t_{1(n)}$$

For more details, refer to the topic “DDR tPST” of the DPOJET help.

tWRPDE

tWRPDE measures the elapsed time between the WRITE and POWERDOWN ENTRY commands.

This measurement is available for GDDR5 generation.

tWRPDE uses the DPOJET measurement, tBurstToCMD. This measurement will appear under WRITE measurement type.

For more details, refer to the topic “tBurstToCMD” of the DPOJET help.

tWRSRE

tWRSRE measures the elapsed time between the WRITE and SELF REFRESH commands.. This measurement is available for both DDR2 and DDR3 generation.

tWRSRE uses the DPOJET measurement, tBurstToCMD. This measurement will appear under WRITE measurement type.

For more details, refer to the topic “tBurstToCMD” of the DPOJET help.

tDQSCK-Diff

tDQSCK-Diff is the DQS output access time from CK or CK#.

tDQSCK-Diff uses the DPOJET measurement, Skew.

The application calculates this measurement using the following equation:

$$Skew = T_n - T_{DQS(n)}$$

for mid level

Where:

T_n specifies the clock edges.

$T_{DQS(n)}$ specifies the DQS edges.

The edge locations are determined by the mid-reference voltage levels. This is a skew measurement between the rising edge of DQS and the rising edge of clock.

For more details, refer to the topic “Skew” of the DPOJET help.

NOTE. The JEDEC standard specifies that tDQSCK is the actual position of a rising strobe edge relative to CK, CK#. Hence, DQS should be in phase with CK. When DQS and CK are not in phase, there could be possibility of probe polarity interchange. You can overcome this by changing the edge direction to “Opposite as From” under edges configure tab for Skew measurements.

For more details, refer to the topic “Configuring Edges for Skew Measurement” of the DPOJET help.

tDQSQ-Diff

tDQSQ-Diff is the DQS-DQ skew for DQS and associated DQ signals. Set JEDEC standard reference levels for DQ.

tDQSQ-Diff uses the DPOJET measurement, Setup.

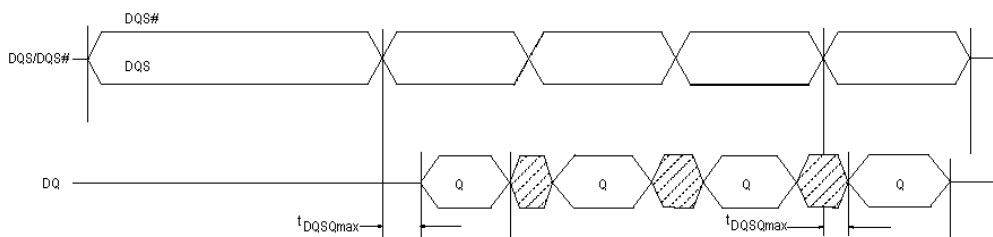

For more details, refer to the topic “Setup” of the DPOJET help.

tAC-Diff

tAC-Diff is the DQ output access time from CK or CK#. Set DQ as the clock source and DQS as the differential source. Set appropriate reference levels for DQ.

tAC-Diff uses the DPOJET measurement, DDR-Setup-Diff.

For more details, refer to the topic “DDR-Setup-Diff” of the DPOJET help.

tQH

tQH is the elapsed time between when the clock waveform crosses its own voltage reference level and the designated edge of a data waveform.

tQH uses the DPOJET measurement, Hold.

For more details, refer to the topic “Hold” of the DPOJET help.

SRQdiff-Rise(DQS)

SRQdiff-Rise(DQS) measures slew rate on differential DQS signals between the rising edges from low to high.

SRQdiff-Rise(DQS) uses the DPOJET measurement, Rise Slew Rate.

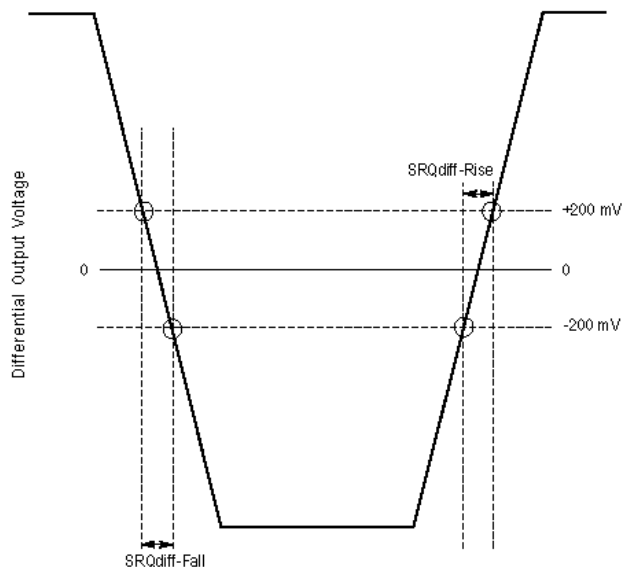

NOTE. The above figure is applicable for all DDR3 Slew Rate(Diff) measurements.

For more details, refer to the topic “Rise Slew Rate” of the DPOJET help.

SRQdiff-Fall(DQS)

SRQdiff-Fall(DQS) measures slew rate on differential DQS signals between the falling edges from high to low.

SRQdiff-Fall(DQS) uses the DPOJET measurement, Fall Slew Rate.

For more details, refer to the topic “Fall Slew Rate” of the DPOJET help.

tDQSQ-SE

vtDQSQ-SE is the skew measured between DQS and DQ single-ended signals.

tDQSQ-SE uses the DPOJET measurement, Setup.

For more details, refer to the topic “Setup” of the DPOJET help.

tDQSCK-SE

tDQSCK-SE is the DQS output access time from CK or CK#. DQS is a single-ended source and special [reference levels \(see page 115\)](#) are available. Clock is a differential source.

tDQSCK-SE uses the DPOJET measurement, Skew.

The application calculates this measurement using the following equation:

$$Skew = T_n - T_{DQS(n)}$$

for mid level

Where:

T_n specifies the clock edges.

$T_{DQS(n)}$ specifies the DQS edges.

The edge locations are determined by the mid-reference voltage levels. This is a skew measurement between the rising edge of DQS and the rising edge of clock.

For more details, refer to the topic “Skew” of the DPOJET help.

DDR2-tDQSCK

tDQSCK is measured between the rising edge of clock before or after DQS Preamble time.

For more details, refer to the topic DDR2-tDQSCK of the DPOJET help.

In the following screen capture, only DQS edge is considered after preamble region for all the respective (READ or WRITE) bursts in the acquisitions.

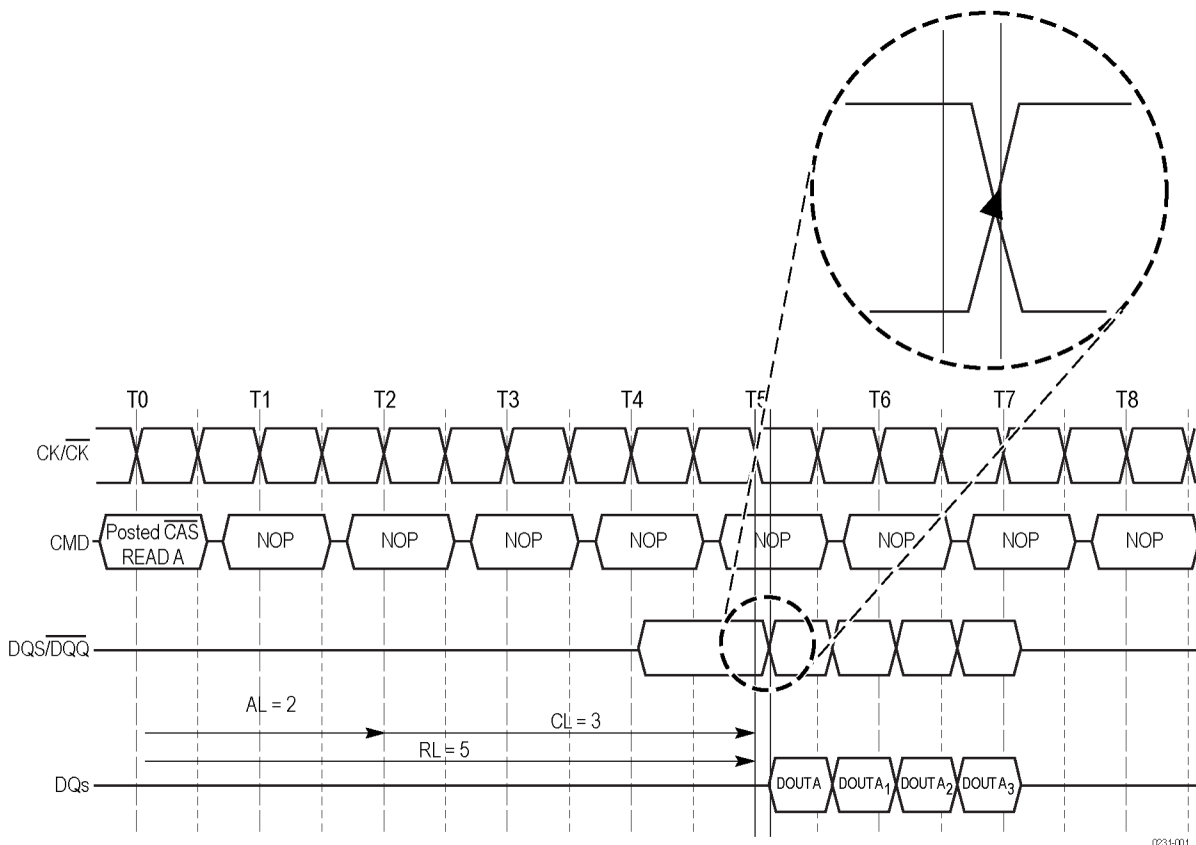

SRQse-Fall(DQ)

SRQse-Fall(DQ) is defined as the single-ended output slew rate for falling edge and is measured between $V_{OL(AC)}$ to $V_{OH(AC)}$.

The application calculates this measurement using the following equation:

$$SlewRate = (V_{OH(AC)} - V_{OL(AC)}) / \Delta t_{Fse}$$

Where:

$V_{OH(AC)}$ is the AC output high measurement level for output slew rate.

$V_{OL(AC)}$ is the AC output low measurement level for output slew rate.

SRQse-Rise(DQ)

SRQse-Rise(DQ) is defined as the single-ended output slew rate for rising edge and is measured between $V_{OH(AC)}$ to $V_{OL(AC)}$.

$$SlewRate = (V_{OL(AC)} - V_{OH(AC)}) / \Delta TRse$$

Where:

$V_{OH(AC)}$ is the AC output high measurement level for output slew rate.

$V_{OL(AC)}$ is the AC output low measurement level for output slew rate.

tRDPDE

tRDPDE measures the elapsed time between the READ and POWERDOWN ENTRY commands.

tRDPDE uses the DPOJET measurement, tBurstToCMD. This measurement will appear under READ measurement type and available for GDDR5 generation only.

For more details, refer to the topic “tBurstToCMD” of the DPOJET help.

tRDSRE

tRDSRE measures the elapsed time between the READ and SELF REFRESH commands.

tRDSRE uses the DPOJET measurement, tBurstToCMD. This measurement will be available for GDDR5 generation only.

For more details, refer to the topic “tBurstToCMD” of the DPOJET help.

tRPRE

DDR tRPRE is defined as the differential pulse width(DQS) for READ preamble.

tRPRE uses the DPOJET measurement, DDR tRPRE.

For more details, refer to the topic “DDR tRPRE” of the DPOJET help.

tRPST

tRPST is defined as the differential pulse width for READ preamble.

tRPST uses the DPOJET measurement, DDR tRPST.

For more details, refer to the topic “DDR tRPST” of the DPOJET help.

Slew Rate-Hold-Fall(DQ)

Slew Rate-Hold-Fall(DQ) measures the slew rate on the DQ signal between the falling edge from V_{REF} to $V_{IL(ac)max}$. This measurement is available for both DDR2 and DDR3 generation.

Slew Rate-Hold-Fall(DQ) uses the DPOJET measurement, Fall Slew Rate.

For more details, refer to the topic “Fall Slew Rate” of the DPOJET help.

Slew Rate-Hold-Rise(DQ)

Slew Rate-Hold-Rise(DQ) measures the slew rate on the DQ signal between the rising edge from V_{REF} to $V_{IH(ac)min}$. This measurement is available for both DDR2 and DDR3 generation.

Slew Rate-Hold-Rise(DQ) uses the DPOJET measurement, Rise Slew Rate.

For more details, refer to the topic “Rise Slew Rate” of the DPOJET help.

Slew Rate-Setup-Fall(DQ)

Slew Rate-Setup-Fall(DQ) measures the slew rate on the DQ signal between the falling edge from V_{REF} to $V_{IL(ac)max}$. This measurement is available for both DDR2 and DDR3 generation.

Slew Rate-Setup-Fall(DQ) uses the DPOJET measurement, Fall Slew Rate.

For more details, refer to the topic “Fall Slew Rate” of the DPOJET help.

Slew Rate-Setup-Rise(DQ)

Slew Rate-Setup-Rise(DQ) measures the slew rate on the DQ signal between the rising edge from V_{REF} to $V_{IH(ac)min}$. This measurement is available for both DDR2 and DDR3 generation.

Slew Rate-Setup-Rise(DQ) uses the DPOJET measurement, Rise Slew Rate.

For more details, refer to the topic “Rise Slew Rate” of the DPOJET help.

SSC Downspread(CK)

SSC Downspread(CK) measures the SSC downspread for the clock.

SSC Downspread(CK) uses the DPOJET measurement, SSC-FREQ-DEV.

For more details, refer to the topic “SSC-FREQ-DEV” of the DPOJET help.

SSC Mod Freq(CK)

SSC Mod Freq(CK) measures the SSC modulation frequency for the clock.

SSC Mod Freq(CK) uses the DPOJET measurement, SSC-MOD-FREQ.

For more details, refer to the topic “SSC-MOD-FREQ” of the DPOJET help.

SSC Profile(CK)

SSC Profile(CK) measures the SSC profile.

SSC Profile(CK) uses the DPOJET measurement, SSC-PROFILE.

For more details, refer to the topic “SSC-PROFILE” of the DPOJET help.

tCH

tCH is the high pulse width on the clock signal. It is the amount of time the waveform remains above the mid reference voltage level.

tCH uses the DPOJET measurement, Pos Width.

For more details, refer to the topic “Positive and Negative Width” of the DPOJET help.

tCK

tCK is the absolute clock period. It is the elapsed time between consecutive rising crossings of the mid reference CK voltage level.

tCK uses the DPOJET measurement, Period.

For more details, refer to the topic “Period” of the DPOJET help.

tCL

tCL is the low pulse width on the clock signal. It is the amount of time the waveform remains below the mid reference voltage level.

tCL uses the DPOJET measurement, Neg Width.

For more details, refer to the topic “Positive and Negative Width” of the DPOJET help.

tCH(abs)

tCH(abs) is the high pulse width on the clock signal. It is the amount of time the waveform remains above the mid reference voltage level.

tCH(abs) uses the DPOJET measurement, Pos Width.

For more details, refer to the topic “Positive and Negative Width” of the DPOJET help.

tCH(avg)

tCH(avg) is the average width of the high-half cycle calculated across a sliding 200-cycle window of clock cycles.

tCH(avg) uses the DPOJET measurement, DDR tCH(avg).

The application calculates this measurement using the following equation:

$$tCH(avg) = \left(\frac{\sum_{j=1}^N tCH_j}{N} \right) / (N \times tCK(avg))$$

Where:

$N=200$, which is configurable.

tCK(abs)

tCK(abs) is the absolute clock period. It is the elapsed time between consecutive rising crossings of the mid reference CK voltage level.

tCK(abs) uses the DPOJET measurement, Period.

For more details, refer to the topic “Period” of the DPOJET help.

tCK(avg)

tCK(avg) is calculated as the average clock period across a sliding 200-cycle window of low pulses.

tCK(avg) uses the DPOJET measurement, DDR tCK(avg).

The application calculates this measurement using the following equation:

$$tCK(avg) = \left(\frac{\sum_{j=1}^{200} tCK_j}{N} \right) / N$$

Where:

$N=200$, which is configurable.

Range: $200 \leq N \leq 1M$

tCL(abs)

tCL(abs) is the low pulse width on the clock signal. It is the amount of time the waveform remains below the mid reference voltage level.

tCL(abs) uses the DPOJET measurement, Neg Width.

For more details, refer to the topic “Positive and Negative Width” of the DPOJET help.

tCL(avg)

tCL(avg) is defined as the average low pulse width calculated across 200-cycle window of consecutive low pulses.

tCL(avg) uses the DPOJET measurement, DDR tCL(avg).

The application calculates this measurement using the following equation:

$$tCL(avg) = \left(\sum_{j=1}^N tCL_j \right) / (N \times tCK(avg))$$

Where:

$N=200$, which is configurable.

Range: $200 \leq N \leq 1M$

tHP

tHP is the minimum of the absolute half period of the actual input clock. It is similar to DPOJET's Period measurement where the edge type is clock with edges selection set to both. Only the minimum result statistics will be compared with the limit values for PASS/FAIL status.

The application calculates this measurement using the following equation:

$$tHP = \text{Min}(tCH(abs), tCL(abs))$$

Where:

$tCH(abs)$ is the minimum of the actual instantaneous clock high time.

$tCL(abs)$ is the minimum of the actual instantaneous clock low time.

tERR

tERR (Timing error) is the time difference between the sum of tCK transitions for a 200-cycle window to n times tCK(avg). The calculated value represents the accumulated error across many cycles (n). The number of cycles to be used is defined by n , which is configurable.

The application calculates this measurement using the following equation:

$$tERR(nper) = \left(\sum_{j=1}^{i+n-1} tCK_j \right) - n \times tCK(avg)$$

Where:

For tERR(nper):

$n=2$ for *tERR(2 per)*

$n=3$ for *tERR(3 per)*

$n=4$ for *tERR(4 per)*

$n=5$ for *tERR(5 per)*

$n=6$ for *tERR(6 per)*

.

.

.

.

$n=49$ for *tERR(49 per)*

For tERR(m-nper):

$6 \leq n \leq 10$ for *tERR(6–10 per)*

$11 \leq n \leq 50$ for *tERR(11–50 per)*

$13 \leq n \leq 50$ for *tERR(13–50 per)*

tJIT(cc)

tJIT(cc) is the difference in period measurements from one cycle to the next; that is, the first difference of the Period measurement.

tJIT(cc) uses the DPOJET measurement, CC-Period.

The application calculates this measurement using the following equation:

$$tJIT(cc) = \text{Max of } |tCK_{i+1} - tCK_i|$$

tJIT(duty)

tJIT(duty) is the largest elapsed time between the tCH from tCH(avg) or tCL from tCL(avg) for a 200-cycle window. This value represents the maximum of the accumulated value across a 200-cycle moving window.

tJIT(duty) uses the DPOJET measurement, DDR tJIT(duty).

The application calculates this measurement using the following equation:

$$tJIT(duty) = \text{Min/max of } \{tJIT(CH), tJIT(CL)\}$$

Where:

$$tJIT(CH) = \{tCH_i - tCH(avg)\}$$

$$tJIT(CL) = \{tCL_i - tCL(avg)\}$$

Where:

i=1 to 200

tJIT(per)

tJIT(per) is the largest elapsed time between the tCK from tCK(avg) for a 200-cycle window. This value represents the maximum of the accumulated value across a 200-cycle moving window.

tJIT(per) uses the DPOJET measurement, DDR tJIT(per).

The application calculates this measurement using the following equation:

$$tJIT(per) = \text{Min/max of } \{tCK_i - tCK(avg)\}$$

Where:

i=1 to 200

VID(ac)

VID(ac) is defined as the magnitude of the difference between the input voltage on CK and the input voltage on CK#.

VID(ac) uses the DPOJET measurement, DDR VID(ac).

For more details, refer to the topic “DDR VID(ac)” of the DPOJET help.

Input Slew-Diff-Rise(CK)

Input Slew-Diff-Rise(CK) measures slew rate on differential CK signals between the rising edges from low to high. The clock differential voltage varies from 500 mV to –250 mV.

Input Slew-Diff-Rise(CK) uses the DPOJET measurement, Rise Slew Rate.

NOTE. *This measurements is common for both Clock(Diff) and Address/Command measurement types.*

For more details, refer to the topic “Rise Slew Rate” of the DPOJET help.

Input Slew-Diff-Fall(CK)

Input Slew-Diff-Fall(CK) measures slew rate on differential CK signals between falling edges from clock high to low. The clock differential voltage varies from +500 mV to -250 mV.

Input Slew-Diff-Fall(CK) uses the DPOJET measurement, Fall Slew Rate.

For more details, refer to the topic “Fall Slew Rate” of the DPOJET help.

AC-Overshoot(CK#)

AC-Overshoot(CK#) is the positive-going amplitude, for each waveform event that exceeds the Vdd reference level on the CK# signal.

AC-Overshoot(CK#) uses the DPOJET measurement, Overshoot.

NOTE. *If the input waveform never exceeds Vdd, the measurement will return a population of 0 events.*

For more details, refer to the topic “Overshoot” of the DPOJET help.

AC-Overshoot(CK)

AC-Overshoot(CK) is the positive-going amplitude, for each waveform event that exceeds the Vdd reference level on the CK signal.

AC-Overshoot(CK) uses the DPOJET measurement, Overshoot.

NOTE. *If the input waveform never exceeds Vdd, the measurement will return a population of 0 events.*

For more details, refer to the topic “Overshoot” of the DPOJET help.

AC-OvershootArea(CK#)

AC-OvershootArea(CK#) is defined as the triangular area obtained by considering the voltage value closest to the maximum peak point on the CK# signal. The triangular area is obtained using the Overshoot width and the amplitude. The units for OvershootArea is V-ns.

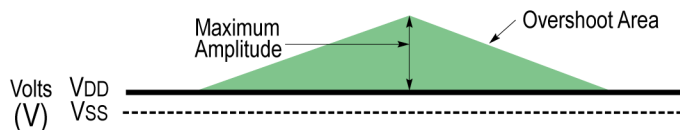

AC-OvershootArea(CK#) uses the DPOJET measurement, DDR Over Area.

$$\text{OvershootArea} = 0.5 * \text{Base} * \text{Height}$$

Where:

Base is the overshoot width.

Height is the overshoot amplitude.

For more details, refer to the topic “DDR Over Area” of the DPOJET help.

AC-OvershootArea(CK)

AC-OvershootArea(CK) is defined as the triangular area obtained by considering the voltage value closest to the maximum peak point on the CK signal. The triangular area is obtained using the Overshoot width and the amplitude. The units for OvershootArea is V-ns.

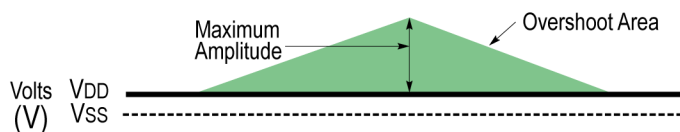

AC-OvershootArea(CK) uses the DPOJET measurement, DDR Over Area.

$$\text{OvershootArea} = 0.5 * \text{Base} * \text{Height}$$

Where:

Base is the overshoot width.

Height is the overshoot amplitude.

AC-Overshoot(CK) uses the DPOJET measurement, DDR Over Area.

For more details, refer to the topic “DDR Over Area” of the DPOJET help.

AC-Undershoot(CK#)

AC-Undershoot(CK#) is the negative-going amplitude (expressed as a positive number), for each waveform event that goes below the Vss reference level on the CK# signal.

AC-Undershoot(CK#) uses the DPOJET measurement, Undershoot.

NOTE. *If the input waveform never goes below Vss, the measurement will return a population of 0 events.*

For more details, refer to the topic “Undershoot” of the DPOJET help.

AC-Undershoot(CK)

AC-Undershoot(CK) is the negative-going amplitude (expressed as a positive number), for each waveform event that goes below the V_{SS} reference level on the CK signal.

AC-Undershoot(CK) uses the DPOJET measurement, Undershoot.

NOTE. *If the input waveform never goes below V_{SS}, the measurement will return a population of 0 events.*

For more details, refer to the topic “Undershoot” of the DPOJET help.

AC-UndershootArea(CK#)

AC-UndershootArea(CK#) is defined as the inverted triangular area obtained by considering the voltage value closest to the maximum peak point on the CK# signal. The triangular area is obtained using the undershoot width and the amplitude. The units for UndershootArea is V-ns.

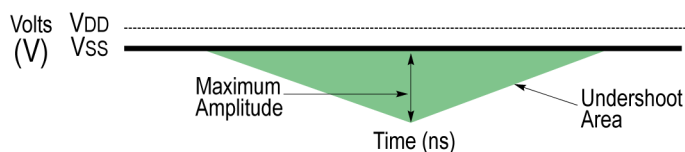

AC-UndershootArea(CK#) uses the DPOJET measurement, DDR Under Area.

$$\text{UndershootArea} = 0.5 * \text{Base} * \text{Height}$$

Where:

Base is the undershoot width.

Height is the undershoot amplitude.

For more details, refer to the topic “DDR Under Area” of the DPOJET help.

AC-UndershootArea(CK)

AC-UndershootArea(CK) is defined as the inverted triangular area obtained by considering the voltage value closest to the maximum peak point on the CK signal. The triangular area is obtained using the undershoot width and the amplitude. The units for UndershootArea is V-ns.

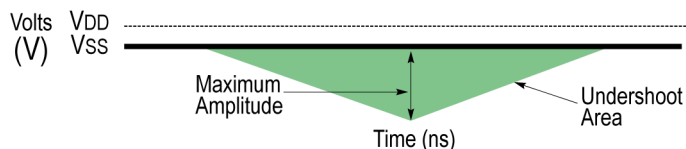

AC-UndershootArea(CK) uses the DPOJET measurement, DDR Under Area.

$$\text{UndershootArea} = 0.5 * \text{Base} * \text{Height}$$

Where:

Base is the undershoot width.

Height is the undershoot amplitude.

For more details, refer to the topic “DDR Under Area” of the DPOJET help.

CKslew-Fall(CK)

CKslew-Fall(CK) measures the single ended CD fall slew rate.

CKslew-Fall(CK) uses the DPOJET measurement, Fall Slew Rate.

For more details, refer to the topic “Fall Slew Rate” of the DPOJET help.

CKslew-Fall(CK#)

CKslew-Fall(CK#) measures the single ended CD fall slew rate.

CKslew-Fall(CK#) uses the DPOJET measurement, Fall Slew Rate.

For more details, refer to the topic “Fall Slew Rate” of the DPOJET help.

CKslew-Rise(CK)

CKslew-Rise(CK) measures the single ended CK rise slew rate.

CKslew-Rise(CK) uses the DPOJET measurement, Rise Slew Rate.

For more details, refer to the topic “Rise Slew Rate” of the DPOJET help.

CKslew-Rise(CK#)

CKslew-Rise(CK#) measures the single ended CK# rise slew rate.

CKslew-Rise(CK#) uses the DPOJET measurement, Rise Slew Rate.

For more details, refer to the topic “Rise Slew Rate” of the DPOJET help.

VIN(CK)

VIN(CK) measures the single ended CK clock input voltage level.

VIN(CK) uses the DPOJET measurement, High-Low.

For more details, refer to the topic “High-Low” of the DPOJET help.

VIN(CK#)

VIN(CK#) measures the single ended CK# clock input voltage level.

VIN(CK#) uses the DPOJET measurement, High-Low.

For more details, refer to the topic “High-Low” of the DPOJET help.

Vix(ac)CK

Vix(ac)CK is defined as the cross-point voltage for differential input signals measured across the clock signal.

Vix(ac)CK uses the DPOJET measurement, V-Diff-Xovr.

For more details, refer to the topic “V-Diff-Xovr” of the DPOJET help.

For DDR3 generation, the measurement uses DPOJET measurement, DDR3 Vix(ac).

For more details, refer to the topic “DDR3 Vix(ac)” of the DPOJET help.

Vox(ac)CK

Vox(ac)CK is defined as the cross-point voltage for differential input signals measured across the clock signal.

Vox(ac)CK uses the DPOJET measurement, V-Diff-Xovr.

For more details, refer to the topic “V-Diff-Xovr” of the DPOJET help.

VSWING(MAX)CK#

VSWING(MAX)CK# is defined as the maximum input voltage on the clock signal (CK#). Available only for DDR2 generation.

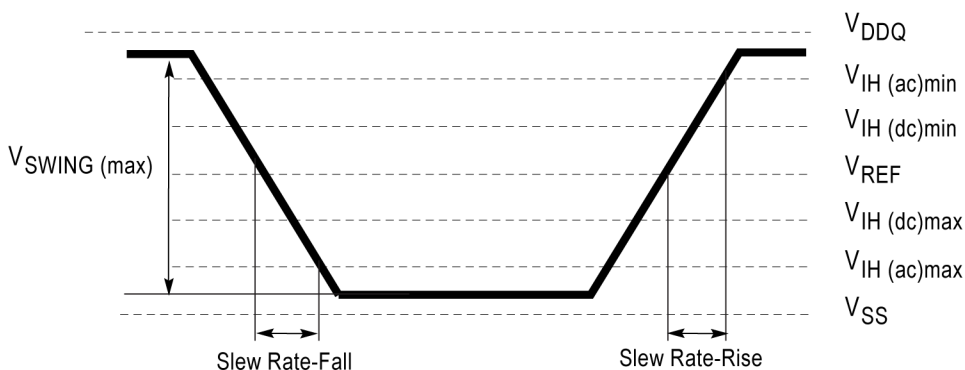

VSWING(MAX)CK# uses the DPOJET measurement, Cycle Pk-Pk.

For more details, refer to the topic “Cycle Pk-Pk” of the DPOJET help.

VSWING(MAX)CK

VSWING(MAX)CK is defined as the maximum input voltage on the clock signal (CK). Available only for DDR2 generation.

VSWING(MAX)CK uses the DPOJET measurement, Cycle Pk-Pk.

For more details, refer to the topic “Cycle Pk-Pk” of the DPOJET help.

VSEH(AC)CK

VSEH(AC)CK is defined as the single-ended high level voltage for the CK signal. Available only for LPDDR2 and DDR3 generation.

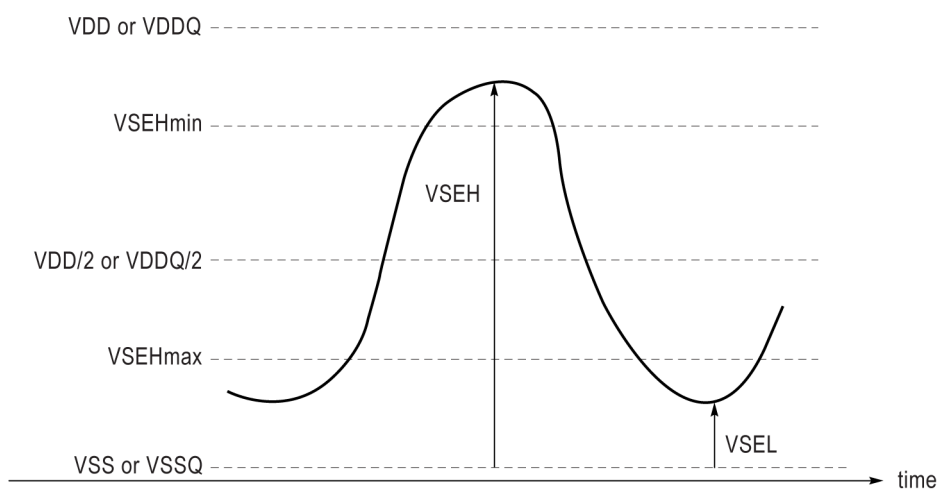

NOTE. The same illustration is applicable for other measurements such as $VSEH(AC)CK\#$, $VSEH(CK\#)$, $VSEH(CK)$, $VSEL(AC)CK\#$, $VSEL(AC)CK\#$, $VSEL(AC)CK$, $VSEL(CK\#)$, and $VSEL(CK)$.

VSEH(AC)CK uses the DPOJET measurement, Cycle Max.

For more details, refer to the topic “Cycle Max” of the DPOJET help.

VSEH(AC)CK#

VSEH(AC)CK# is defined as the single-ended high level voltage for the CK# signal. Available only for LPDDR2 and DDR3 generation.

VSEH(AC)CK# uses the DPOJET measurement, Cycle Max.

For more details, refer to the topic “Cycle Max” of the DPOJET help.

VSEH(CK#)

VSEH(CK#) is defined as the single-ended high level voltage for the CK# signal. Available only for DDR3 generation.

VSEH(CK#) uses the DPOJET measurement, Cycle Max.

For more details, refer to the topic “Cycle Max” of the DPOJET help.

VSEH(CK)

VSEH(CK) is defined as the single-ended high level voltage for the CK signal. Available only for DDR3 generation.

VSEH(CK) uses the DPOJET measurement, Cycle Max.

For more details, refer to the topic “Cycle Max” of the DPOJET help.

VSEL(AC)CK#

VSEL(AC)CK is defined as the single-ended low level voltage for the CK# signal. Available only for LPDDR2 and DDR3 generation.

VSEL(AC)CK# uses the DPOJET measurement, Cycle Min.

For more details, refer to the topic “Cycle Min” of the DPOJET help.

VSEL(AC)CK

VSEL(AC)CK is defined as the single-ended low level voltage for the CK signal. Available only for LPDDR2 and DDR3 generation.

VSEL(AC)CK uses the DPOJET measurement, Cycle Min.

For more details, refer to the topic “Cycle Min” of the DPOJET help.

VSEL(CK#)

VSEL(CK#) is defined as the single-ended low level voltage for the CK# signal. Available only for DDR3 generation.

VSEH(CK) uses the DPOJET measurement, Cycle Min.

For more details, refer to the topic “Cycle Min” of the DPOJET help.

VSEL(CK)

VSEL(CK) is defined as the single-ended low level voltage for the CK signal. Available only for DDR3 generation.

VSEH(CK) uses the DPOJET measurement, Cycle Min.

For more details, refer to the topic “Cycle Min” of the DPOJET help.

Vix(ac)DQS

Vix(ac)DQS is defined as the cross-point voltage for differential input signals measured across the DQS signal.

Vix(ac)DQS uses the DPOJET measurement, V-Diff-Xovr.

For more details, refer to the topic “V-Diff-Xovr” of the DPOJET help.

For DDR3 generation, the measurement uses DPOJET measurement, DDR3 Vix(ac).

For more details, refer to the topic “DDR3 Vix(ac)” of the DPOJET help.

Vox(ac)DQS

Vox(ac)DQS is defined as the cross-point voltage for differential input signals measured across the DQS signal.

Vox(ac)DQS uses the DPOJET measurement, V-Diff-Xovr.

For more details, refer to the topic “V-Diff-Xovr” of the DPOJET help.

AC-Overshoot(DQS)

AC-Overshoot(DQS) is the positive-going amplitude, for each waveform event that exceeds the Vdd reference voltage level on the DQS signal.

AC-Overshoot(DQS) uses the DPOJET measurement, Overshoot.

NOTE. *If the input waveform never exceeds the specified reference level, the measurement will return a population of 0 events.*

For more details, refer to the topic “Overshoot” of the DPOJET help.

AC-Overshoot(DQS#)

AC-Overshoot(DQS#) is the positive-going amplitude, for each waveform event that exceeds the Vdd reference level on the DQS# signal.

AC-Overshoot(DQS#) uses the DPOJET measurement, Overshoot.

NOTE. *If the input waveform never exceeds the specified reference level, the measurement will return a population of 0 events.*

For more details, refer to the topic “Overshoot” of the DPOJET help.

AC-OvershootArea(DQS#)

AC-OvershootArea(DQS#) is defined as the triangular area obtained by considering the voltage value closest to the maximum peak point on the DQS# signal. The triangular area is obtained using the overshoot width and the amplitude. The units for OvershootArea is V-ns.

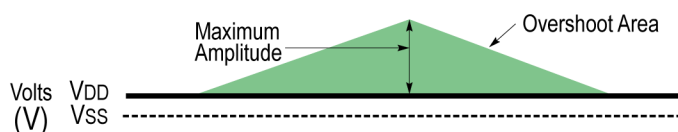

AC-OvershootArea(DQS#) uses the DPOJET measurement, DDR Over Area.

$$\text{OvershootArea} = 0.5 * \text{Base} * \text{Height}$$

Where:

Base is the overshoot width.

Height is the overshoot amplitude.

For more details, refer to the topic “DDR Over Area” of the DPOJET help.

AC-OvershootArea(DQS)

AC-OvershootArea(DQS) is defined as the triangular area obtained by considering the voltage value closest to the maximum peak point on the CK# signal. The triangular area is obtained using the overshoot width and the amplitude. The units for OvershootArea is V-ns.

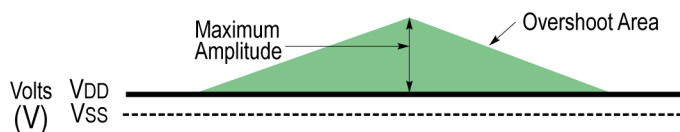

AC-OvershootArea(DQS) uses the DPOJET measurement, DDR Over Area.

$$\text{OvershootArea} = 0.5 * \text{Base} * \text{Height}$$

Where:

Base is the overshoot width.

Height is the overshoot amplitude.

For more details, refer to the topic “DDR Over Area” of the DPOJET help.

AC-Undershoot(DQS)

AC-Undershoot(DQS) is the negative-going amplitude (expressed as a positive number), for each waveform event that goes below the VSS reference level on the DQS signal.

AC-Undershoot(DQS) uses the DPOJET measurement, Undershoot.

NOTE. *If the input waveform never goes below the specified reference level, the measurement will return a population of 0 events.*

For more details, refer to the topic “Undershoot” of the DPOJET help.

AC-Undershoot(DQS#)

AC-Undershoot(DQS#) is the negative-going amplitude (expressed as a positive number), for each waveform event that goes below the reference level on the DQS# signal.

AC-Undershoot(DQS#) uses the DPOJET measurement, Undershoot.

NOTE. *If the input waveform never goes below the specified reference level, the measurement will return a population of 0 events.*

For more details, refer to the topic “Undershoot” of the DPOJET help.

AC-UndershootArea(DQS#)

AC-UndershootArea(DQS#) is defined as the inverted triangular area obtained by considering the voltage value closest to the maximum peak point on the DQS# signal. The triangular area is obtained using the undershoot width and the amplitude. The units for UndershootArea is V-ns.

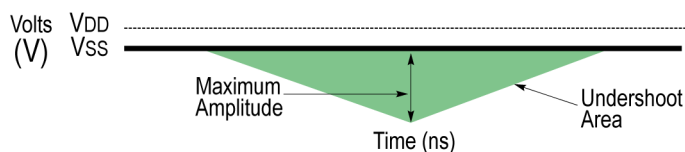

AC-UndershootArea(DQS#) uses the DPOJET measurement, DDR Under Area.

$$\text{UndershootArea} = 0.5 * \text{Base} * \text{Height}$$

Where:

Base is the undershoot width.

Height is the undershoot amplitude.

For more details, refer to the topic “DDR Under Area” of the DPOJET help.

AC-UndershootArea(DQS)

AC-UndershootArea(DQS) is defined as the inverted triangular area obtained by considering the voltage value closest to the maximum peak point on the DQS signal. The triangular area is obtained using the undershoot width and the amplitude. The units for UndershootArea is V-ns.

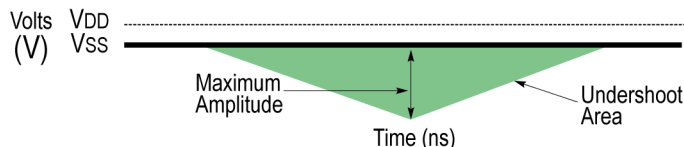

AC-UndershootArea(DQS) uses the DPOJET measurement, DDR Under Area.

$$\text{UndershootArea} = 0.5 * \text{Base} * \text{Height}$$

Where:

Base is the undershoot width.

Height is the undershoot amplitude.

For more details, refer to the topic “DDR Under Area” of the DPOJET help.

SSC Downspread(WCK)

SSC Downspread(WCK) measures the SSC downspread for WCK.

SSC Downspread(WCK) uses the DPOJET measurement, SSC-FREQ-DEV.

For more details, refer to the topic “SSC-FREQ-DEV” of the DPOJET help.

SSC Mod Freq(WCK)

SSC Mod Freq(WCK) measures the SSC modulation frequency for WCK.

SSC Mod Freq(WCK) uses the DPOJET measurement, SSC-MOD-FREQ.

For more details, refer to the topic “SSC-MOD-FREQ” of the DPOJET help.

SSC Profile(WCK)

SSC Profile(WCK) measures the SSC profile.

SSC Profile(WCK) uses the DPOJET measurement, SSC-PROFILE.

For more details, refer to the topic “SSC-PROFILE” of the DPOJET help.

tDVAC(WCK)

tDVAC(WCK) is defined as the allowed time before ring back of WCK below VIDCK/WCK (AC) reference levels.

tDVAC(WCK) uses the DPOJET measurement, Time Outside Level.

For more details, refer to the topic “Time Outside Level” of the DPOJET help. tDVAC(WCK) is used for GDDR5 generation.

tWCK

tWCK measures the WCK clock cycle time.

tWCK uses the DPOJET measurement, Period.

For more details, refer to the topic “Period” of the DPOJET help.

tWCK-DJ

tWCK-DJ is defined as the WCK diff deterministic jitter.

tWCK-DJ uses the DPOJET measurement, DJ.

For more details, refer to the topic “DJ” of the DPOJET help.

tWCKH

tWCKH measures the WCK clock high-level width.

tWCKH uses the DPOJET measurement, Positive and Negative Width.

For more details, refer to the topic “Positive and Negative Width” of the DPOJET help.

tWCKHP

tWCKHP measures the minimum WCK clock half period.

tWCKHP uses the DPOJET measurement, Period.

For more details, refer to the topic “Period” of the DPOJET help.

tWCKL

tWCKL measures the WCK clock low-level width.

tWCKL uses the DPOJET measurement, Positive and Negative Width.

For more details, refer to the topic “Positive and Negative Width” of the DPOJET help.

tWCK-Rise-Slew

tWCK-Rise-Slew measures the WCK diff rise slew rate.

tWCK-Rise-Slew uses the DPOJET measurement, Rise Slew Rate.

For more details, refer to the topic “Rise Slew Rate” of the DPOJET help.

tWCK-Fall-Slew

tWCK-Fall-Slew measures the WCK diff fall slew rate.

tWCK-Fall-Slew uses the DPOJET measurement, Fall Slew Rate.

For more details, refer to the topic “Fall Slew Rate” of the DPOJET help.

tWCK-RJ

tWCK-RJ is defined as the WCK diff random jitter.

tWCK-RJ uses the DPOJET measurement, RJ.

For more details, refer to the topic “RJ” of the DPOJET help.

tWCK-TJ

tWCK-TJ is defined as the WCK diff total jitter.

tWCK-TJ uses the DPOJET measurement, TJ@BER.

For more details, refer to the topic “TJ@BER” of the DPOJET help.

VWCK-Swing

VWCK-Swing is defined as the WCK differential logic high voltage.

VWCK-Swing uses the DPOJET measurement, High-Low.

For more details, refer to the topic “High-Low” of the DPOJET help.

VIN(WCK)

VIN(WCK) measures the single ended WCK clock input voltage level.

VIN(WCK) uses the DPOJET measurement, High-Low.

For more details, refer to the topic “High-Low” of the DPOJET help.

VIN(WCK#)

VIN(WCK#) measures the single ended WCK clock input voltage level.

VIN(WCK#) uses the DPOJET measurement, High-Low.

For more details, refer to the topic “High-Low” of the DPOJET help.

Vix(ac)WCK

Vix(ac)WCK is defined as the cross-point voltage for differential input signals measured across the clock signal.

Vix(ac)WCK uses the DPOJET measurement, V-Diff-Xovr.

For more details, refer to the topic “V-Diff-Xovr” of the DPOJET help.

For DDR3 generation, the measurement uses DPOJET measurement, DDR3 Vix(ac).

For more details, refer to the topic “DDR3 Vix(ac)” of the DPOJET help.

VOL(WCK)

VOL(WCK) measures the single ended logic low voltage of the WCK signal.

VOL(WCK) uses the DPOJET measurement, Low.

For more details, refer to the topic “Low” of the DPOJET help.

VOH(WCK)

VOH(WCK) measures the single ended logic high voltage of the WCK signal.

VOH(WCK) uses the DPOJET measurement, High.

For more details, refer to the topic “High” of the DPOJET help.

VOL(WCK#)

VOL measures the single ended logic low voltage of the WCK# signal.

VOL uses the DPOJET measurement, Low.

For more details, refer to the topic “Low” of the DPOJET help.

VOH(WCK#)

VOH measures the single ended logic high voltage of the WCK# signal.

VOH uses the DPOJET measurement, High.

For more details, refer to the topic “High” of the DPOJET help.

WCKslew-Fall(WCK)

WCKslew-Fall(WCK) measures the single ended WCK fall slew rate.

WCKslew-Fall(WCK) uses the DPOJET measurement, Fall Slew Rate.

For more details, refer to the topic “Fall Slew Rate” of the DPOJET help.

WCKslew-Fall(WCK#)

WCKslew-Fall(WCK#) measures the single ended WCK# fall slew rate.

WCKslew-Fall(WCK#) uses the DPOJET measurement, Fall Slew Rate.

For more details, refer to the topic “Fall Slew Rate” of the DPOJET help.

WCKslew-Rise(WCK)

WCKslew-Rise(WCK) measures the single ended WCK rise slew rate.

WCKslew-Rise(WCK) uses the DPOJET measurement, Rise Slew Rate.

For more details, refer to the topic “Rise Slew Rate” of the DPOJET help.

WCKslew-Rise(WCK#)

WCKslew-Rise(WCK#) measures the single ended WCK rise slew rate.

WCKslew-Rise(WCK#) uses the DPOJET measurement, Rise Slew Rate.

For more details, refer to the topic “Rise Slew Rate” of the DPOJET help.

AC-Overshoot

AC-Overshoot is the maximum positive-going amplitude relative to V_{DD}, for each waveform event that exceeds the V_{DD} reference voltage level.

AC-Overshoot uses the DPOJET measurement, Overshoot.

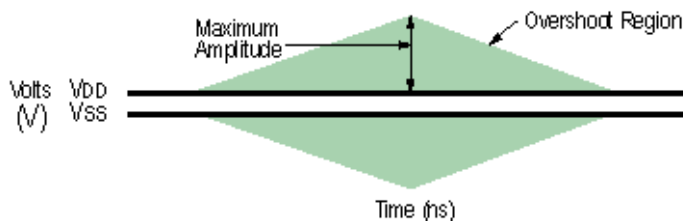

AC-OvershootArea

AC-OvershootArea is defined as the triangular area obtained by considering the voltage value closest to the maximum peak point. The triangular area is obtained using the overshoot width and the amplitude. The units for OvershootArea is V-ns.

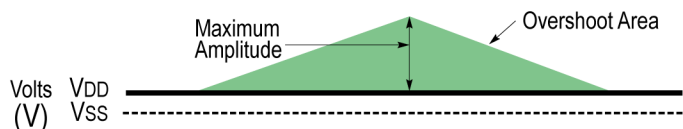

AC-OvershootArea uses the DPOJET measurement, DDR Over Area.

$$\text{OverShoot Area} = 0.5 * \text{Base} * \text{Height}$$

Where:

Base is the overshoot width.

Height is the overshoot amplitude.

For more details, refer to the topic “DDR Over Area” of the DPOJET help.

AC-Undershoot

AC-Undershoot is the negative-going amplitude (expressed as a positive number) relative to V_{SS}, for each waveform event that goes below the V_{SS} reference voltage level.

AC-Undershoot uses the DPOJET measurement, Undershoot.

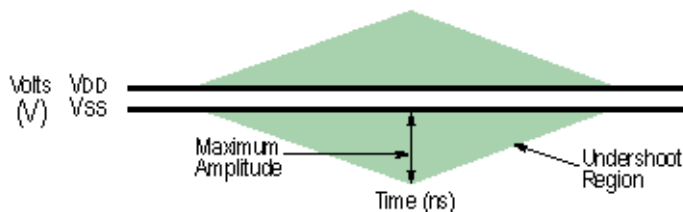

AC-UndershootArea

AC-UndershootArea is defined as the inverted triangular area obtained by considering the voltage value closest to the maximum peak point. The triangular area is obtained using the undershoot width and the amplitude. The units for UndershootArea is V-ns.

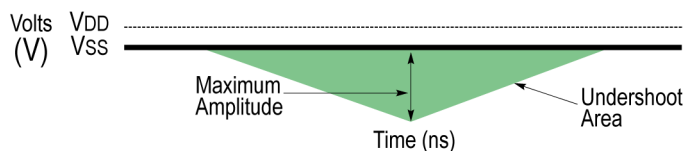

AC-UndershootArea uses the DPOJET measurement, DDR UnderArea.

The application calculates this measurement using the following equation:

$$\text{UnderShoot Area} = 0.5 * \text{Base} * \text{Height}$$

Where:

Base is the undershoot width.

Height is the undershoot amplitude.

For more details, refer to the topic “DDR Under Area” of the DPOJET help.

Slew Rate-Hold-Fall(Addr/Cmd)

Slew Rate-Hold-Fall(Addr/Cmd) measures the slew rate on the Addr/Cmd signal between the falling edge from V_{REF} to $V_{IL(ac)max}$. This measurement is available for DDR2, DDR3, and LPDDR2 generation.

Slew Rate-Hold-Fall(Addr/Cmd) uses the DPOJET measurement, Fall Slew Rate.

For more details, refer to the topic “Fall Slew Rate” of the DPOJET help.

Slew Rate-Hold-Fall(DQ) measures the slew rate on the DQ signal between the falling edge from V_{REF} to $V_{IL(ac)max}$. This measurement is available for both DDR2 and DDR3 generation.

Slew Rate-Hold-Rise(Addr/Cmd)

Slew Rate-Hold-Rise(Addr/Cmd) measures the slew rate on the Addr/Cmd signal between the rising edge from V_{REF} to $V_{IH(ac)min}$. This measurement is available for DDR2, DDR3, and LPDDR2 generation.

Slew Rate-Hold-Rise(Addr/Cmd) uses the DPOJET measurement, Rise Slew Rate.

For more details, refer to the topic “Rise Slew Rate” of the DPOJET help.

Slew Rate-Setup-Fall(Addr/Cmd)

Slew Rate-Setup-Fall(Addr/Cmd) measures the slew rate on the Addr/Cmd signal between the falling edge from V_{REF} to $V_{IL(ac)max}$. This measurement is available for DDR2, DDR3, and LPDDR2 generation.

Slew Rate-Setup-Fall(Addr/Cmd) uses the DPOJET measurement, Fall Slew Rate.

For more details, refer to the topic “Fall Slew Rate” of the DPOJET help.

Slew Rate-Setup-Rise(Addr/Cmd)

Slew Rate-Setup-Rise(Addr/Cmd) measures the slew rate on the Addr/Cmd signal between the rising edge from V_{REF} to $V_{IH(ac)min}$. This measurement is available for DDR2, DDR3, and LPDDR2 generation.

Slew Rate-Setup-Rise(Addr/Cmd) uses the DPOJET measurement, Rise Slew Rate.

For more details, refer to the topic “Rise Slew Rate” of the DPOJET help.

tAH

tAH measures the address input hold time.

tAH uses the DPOJET measurement, Hold.

For more details, refer to the topic “Hold” of the DPOJET help.

tAPW

tAPW measures the address input pulse width.

tAPW uses the DPOJET measurement, Period.

For more details, refer to the topic “Period” of the DPOJET help.

tAS

tAS measures the address input setup time.

tAS uses the DPOJET measurement, Setup.

For more details, refer to the topic “Setup” of the DPOJET help.

tCMDH

tCMDH measures the command input hold time.

tCMDH uses the DPOJET measurement, Hold.

For more details, refer to the topic “Hold” of the DPOJET help.

tCMDPW

tCMDPW measures the command input pulse width.

tCMDPW uses the DPOJET measurement, Period.

For more details, refer to the topic “Period” of the DPOJET help.

tCMDS

tCMDS measures the command input setup time.

tCMDS uses the DPOJET measurement, Setup.

For more details, refer to the topic “Setup” of the DPOJET help.

tIS(base)

tIS(base) is the input setup time measured on an address and command signal to the clock signal.

tIS(base) uses the DPOJET measurement, DDR Setup-Diff.

For more details, refer to the topic “DDR-Setup-Diff” of the DPOJET help.

tIH(base)

tIH(base) is the input hold time measured on an address and command signal to the clock signal.

tIH(base) uses the DPOJET measurement, DDR Hold-Diff.

For more details, refer to the topic “DDR Hold-Diff” of the DPOJET help.

tIS(derated)

Derating limits are calculated by adding the tIS(base) limit and ΔtIS (derating) value. ΔtIS for a rising signal is defined as the slew rate between the last crossing of $V_{REF(dc)}$ and the first crossing of $V_{IH(ac)min}$, and for a falling signal is defined as the slew rate between the last crossing of $V_{REF(dc)}$ and the first crossing of $V_{il(ac)max}$.

tIS(derated) uses the DPOJET measurement, DDR Setup-Diff.

$$tIS = tIS(base) + \Delta tIS$$

For more details, refer to the topic “DDR-Setup-Diff” of the DPOJET help.

tIH(derated)

Derating limits are calculated by adding the tIH(base) limit and $\Delta tIH(\text{derating})$ value. ΔtIH for a rising signal is defined as the slew rate between the last crossing of $V_{IL(dc)max}$ and the first crossing of $V_{REF(dc)}$, and for a falling signal is defined as the slew rate between the last crossing of $V_{IH(dc)min}$ and the first crossing of $V_{REF(dc)}$.

tIH(derated) uses the DPOJET measurement, DDR Hold-Diff.

For more details, refer to the topic “DDR-Hold-Diff” of the DPOJET help.

tIPW-High

tIPW-High is the high input pulse width measured on an address and command signal.

tIPW-High uses the DPOJET measurement, High Time.

For more details, refer to the topic “High Time” of the DPOJET help.

tIPW-Low

tIPW-Low is the low input pulse width measured on an address and command signal.

tIPW-Low uses the DPOJET measurement, Low Time.

For more details, refer to the topic “Low Time” of the DPOJET help.

tCKSRE

tCKSRE measures the valid CK clocks required before self refresh exit.

tCKSRE uses the DPOJET measurement, tCKSRE.

For more details, refer to the topic “tCKSRE” of the DPOJET help.

tCKSRX

tCKSRX measures the valid CK clocks required before self refresh exit.

tCKSRX uses the DPOJET measurement, tCKSRX.

For more details, refer to the topic “tCKSRX” of the DPOJET help.

tRFC

tRFC measures the refresh command period.

tRFC uses the DPOJET measurement, tCMD-CMD.

For more details, refer to the topic “tCMD-CMD” of the DPOJET help.

tREFTR(Read)

tREFTR(Read) measures the refresh to RDTR command delay.

tREFTR(Read) uses the DPOJET measurement, tCMD-CMD.

For more details, refer to the topic “tCMD-CMD” of the DPOJET help.

tREFTR(Write)

tREFTR(Write) measures the refresh to WRTR command delay.

tREFTR(Write) uses the DPOJET measurement, tCMD-CMD.

For more details, refer to the topic “tCMD-CMD” of the DPOJET help.

tXSNRW

tXSNRW measures the exit self refresh to non-read.write command delay.

tXSNRW uses the DPOJET measurement, tCMD-CMD.

For more details, refer to the topic “tCMD-CMD” of the DPOJET help.

tPD

tPD measures the minimum power-down entry to exit time.

tPD uses the DPOJET measurement, tCMD-CMD.

For more details, refer to the topic “tCMD-CMD” of the DPOJET help.

tRAS

tRAS measures the time elapsed from the ACTIVE to PRECHARGE command. This measurement is available for the GDDR5 generation only.

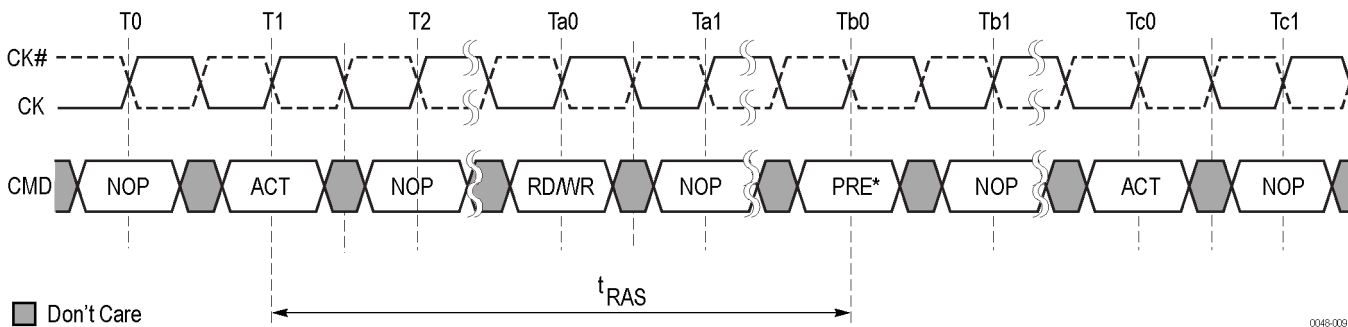

0048-009

tRAS uses the DPOJET measurement, tCMDtoCMD.

For more details, refer to the topic “tCMDtoCMD” of the DPOJET help.

tRC

tRC measures the time elapsed from the ACTIVE to ACTIVE command. This measurement is available for GDDR5 generation only.

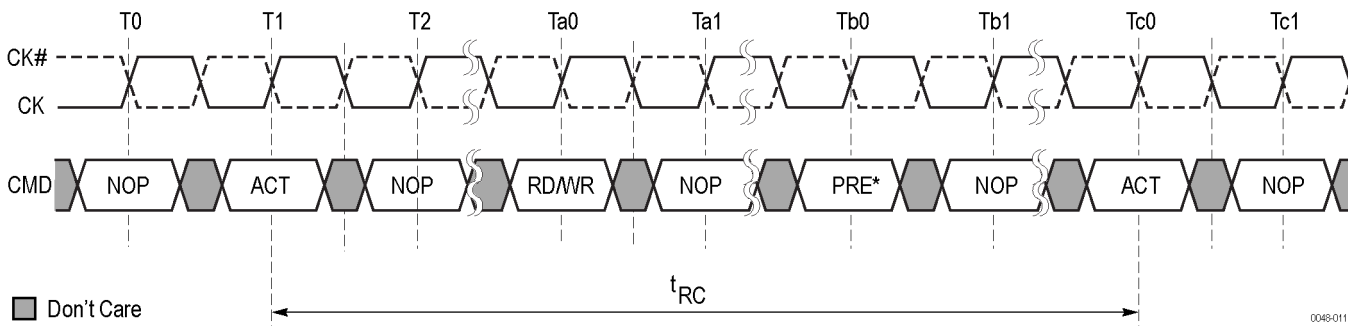

0048-011

tRC uses the DPOJET measurement, tCMDtoCMD.

For more details, refer to the topic “tCMDtoCMD” of the DPOJET help.

tRCDRD

tRCDRD measures the time elapsed between the ACTIVE and READ commands. This measurement is available for GDDR5 generation only.

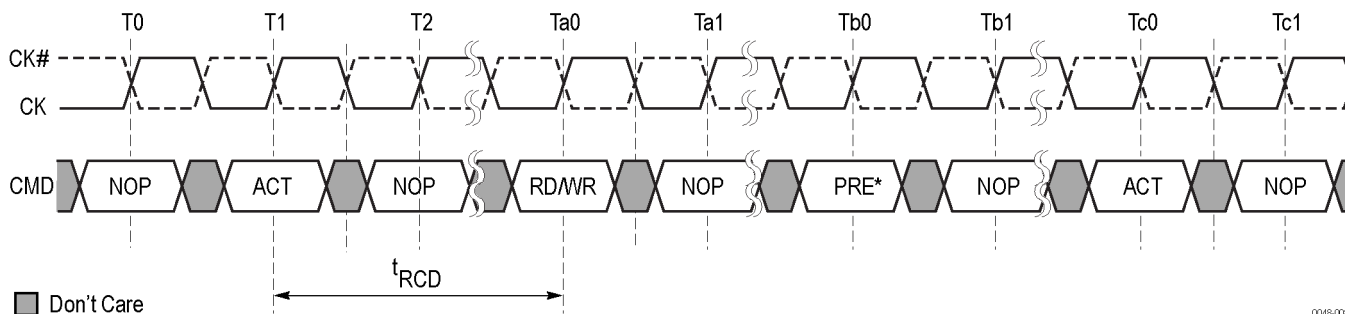

tRCDRD uses the DPOJET measurement, tCMDtoCMD.

For more details, refer to the topic “tCMDtoCMD” of the DPOJET help.

tRCDWR

tRCDWR measures the time elapsed between the ACTIVE and WRITE commands. This measurement is available for GDDR5 generation only.

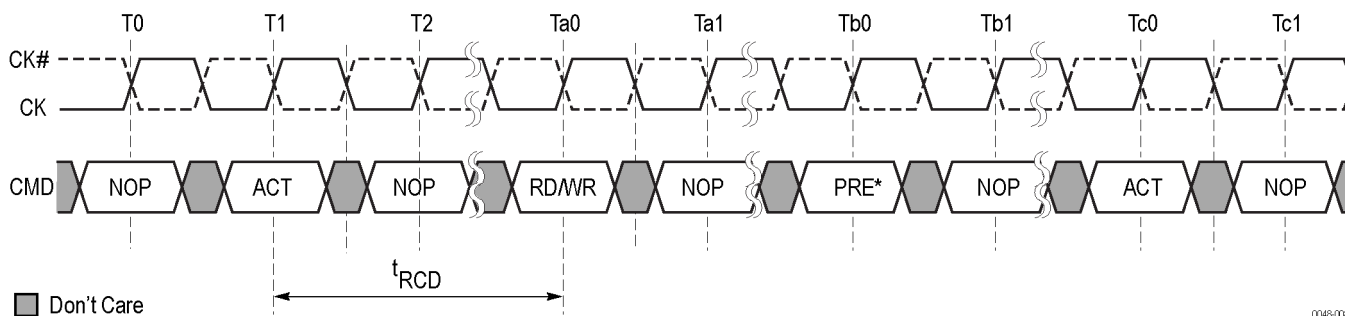

tRCDWR uses the DPOJET measurement, tCMDtoCMD.

For more details, refer to the topic “tCMDtoCMD” of the DPOJET help.

tPPD

tPPD measures the elapsed time between the PRECHARGE and next PRECHARGE commands.

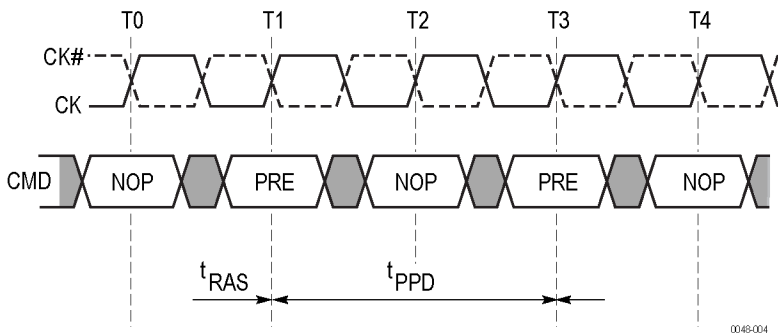

tPPD uses the DPOJET measurement, tCMDtoCMD. This measurement will be available for GDDR5 generation only.

For more details, refer to the topic “tCMDtoCMD” of the DPOJET help.

tRP(ACT)

tRP(ACT) measures the PRECHARGE command period from PRECHARGE to ACTIVE commands..

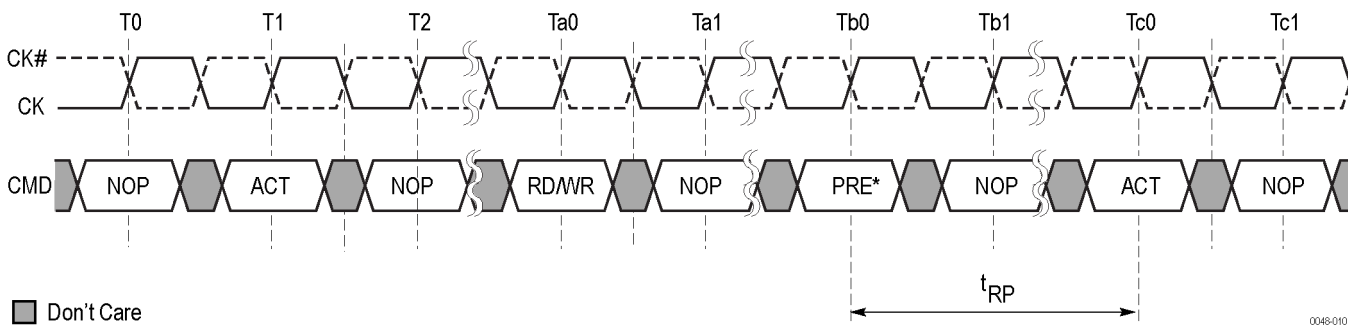

tRP(ACT) uses the DPOJET measurement, tCMDtoCMD. This measurement will be available for GDDR5 generation only.

For more details, refer to the topic “tCMDtoCMD” of the DPOJET help.

tRP(MRS)

tRP(MRS) measures the PRECHARGE command period from PRECHARGE to MRS (Mode Register Set) commands.

tRP(MRS) uses the DPOJET measurement, tCMDtoCMD. This measurement will be available for GDDR5 generation only.

For more details, refer to the topic “tCMDtoCMD” of the DPOJET help.

tRP(REF)

tRP(REF) measures the precharge command period.

tRP(REF) uses the DPOJET measurement, tCMD-CMD.

For more details, refer to the topic “tCMD-CMD” of the DPOJET help.

tRP(SRE)

tRP(SRE) measures the PRECHARGE command period from PRECHARGE to SELF REFRESH.

tRP(SRE) uses the DPOJET measurement, tCMD-CMD.

For more details, refer to the topic “tCMD-CMD” of the DPOJET help.

tRTPL

tRTPL measures the READ to PRECHARGE command delay same bank with bank groups enabled.

tRTPL uses the DPOJET measurement, tCMD-CMD.

For more details, refer to the topic “tCMD-CMD” of the DPOJET help.

About the GPIB Program

You can use remote GPIB commands to communicate with the DDRA application. Query measurement results using DPOJET commands. Sequence commands using DPOJET commands. Setup reports, logging, statistics, and limits using DPOJET commands. An example of a GPIB program is included with the DPOJET application in C:\Users\Public\Tektronix\TekApplications\DPOJET\Examples.

The example shows how a GPIB program executes the DPOJET application to do the following tasks:

1. Start the application.
2. Recall a setup.
3. Take a measurement.
4. View measurement results and plots.
5. Exit the application.

NOTE. *Commands are not case and space sensitive. Your program will operate correctly even if you do not follow the capitalization and spacing precisely.*

GPIB Reference Materials

To use GPIB commands with your oscilloscope, you can refer to the following materials:

- The GPIB Program Example in C:\TekApplications\DPOJET\Examples for guidelines to use while designing a GPIB program.
- The Parameters topics for range of values, minimum units and default values of parameters.
- The programmer information in the online help of your oscilloscope.

Argument Types

The syntax shows the format that the instrument returns in response to a query. This is also the preferred format when sending the command to the instrument though any of the formats are accepted. This documentation represents these arguments as follows:

Table 35: Argument types

Symbol	Meaning
<NR1>	Signed integer value.
<NR2>	Floating point value without an exponent.
<NR3>	Floating point value with an exponent.
double	Double precision floating point with exponent.

DDRA:ADDMeas

This command selects the specified measurement in DDRA.

NOTE. *If there is an error, the DDRA:LASTError? query returns measurement does not exist under the generation or measurement type selected*

Syntax

```
DDRA:ADDMeas {TCKABS | TCHABS | TCLABS | THP | TJITDUTY | TJITPER | TJITCC
| VIDAC | SRQDIFFRISEDQS | SRQDIFFFALLDQS | SRQDIFFRISECK | SRQSERISEDQ |
SRQSEFALLDQ | SRQDIFFFALLCK | INPUTSLEWDIFFRISEDQS | INPUTSLEWDIFFFALLDQS
| INPUTSLEWDIFFRISECK | INPUTSLEWDIFFFALLCK | TQH | TISBASE | TISDERATED |
TIHBASE | TIHDERATED | TDQSK | TDQSKDIFF | TDSSSE | TDSSDIFF | TDSHSE |
TDSHDIFF | TDQSSSE | TDQSSDIFF | TIPWHIGH | TIPWLOW | TDIPWSE | TDHSEBASE
| TDHSEDERATED | TDSSEBASE | TDSSEDERATED | TSDIFFBASE | TSDIFFDERATED
| TDHDIFFBASE | TDHDIFFDERATED | TDQSQSE | TDQSQDIFF | TACDIFF | TDQSH
| TDQSL | TCKAVG | TCLAVG | TCHAVG | TERR2PER | TERR3PER | TERR4PER |
TERR5PER | TERR6TO10PER | TERR11TO50PER | DATAEYEWIDTH | VIXACDQS | VIXACCK
| VIXACWCK | VOXACDQS | VOXACCK | ACOVRSHOOT | ACUNDSHOOT | ACOVRSHOOTDQS
| ACOVRSHOOTDQSBAR | ACUNDSHOOTC | ACOVRSHOOTCKBAR | ACUNDSHOOTDQS |
ACUNDSHOOTDQSBAR | ACUNDSHOOTCK | ACUNDSHOOTCKBAR | SETUPFALLADDRCMD |
SETUPRISEADDRCMD | SLEWFALLCK | SLEWRISECK | HOLDFALLADDRCMD | HOLDRISEADDRCMD
| SETUPFALLDQ | SETUPRISEDQ | SLEWSETUPFALLDQ | SLEWSETUPRISEDQ |
SLEWSETUPSEFALLDQS | SLEWSETUPSERISEDQS | SLEWDIFFFALLDQS | SLEWDIFFRISEDQS |
HOLDFALLDQ | HOLDRISEDQ | SLEHOLDFALLDQ | SLEWHOLDRISEDQ | SLEWHOLDSEFALLDQS
| SLEWHOLDSERISEDQS | SETUPSEFALLDQ | SETUPSERISEDQ | HOLDSEFALLDQ |
HOLDSERISEDQ | SLEWSEFALLDQS | SLEWSERISEDQS | TERR6PER | TERR7PER | TERR8PER
```

| TERR9PER | TERR10PER | TERR11PER | TERR12PER | TERR13PER | TERR14PER |
 TERR15PER | TERR16PER | TERR17PER | TERR18PER | TERR19PER | TERR20PER |
 TERR21PER | TERR22PER | TERR23PER | TERR24PER | TERR25PER | TERR26PER |
 TERR27PER | TERR28PER | TERR29PER | TERR30PER | TERR31PER | TERR32PER |
 TERR33PER | TERR34PER | TERR35PER | TERR36PER | TERR37PER | TERR38PER |
 TERR39PER | TERR40PER | TERR41PER | TERR42PER | TERR43PER | TERR44PER |
 TERR45PER | TERR46PER | TERR47PER | TERR48PER | TERR49PER | TERR50PER | TCK
 | TH | TCL | TDSSE | TDHSE | TRPRE | TWPRE | TWPST | TRPST | VSWINGMAXDQS |
 VSWINGMAXDQSBAR | VSWINGMAXCK | VSWINGMAXCKBAR | DATAEYEHEIGHT | VSEHDQS |
 VSEHDQSBAR | VSEHCK | VSEHCKBAR | VSELDQS | VSELDQSBAR | VSELCK | VSELCKBAR |
 VSEHACDQ | VSEHACDQSBAR | VSEHACCK | VSEHACCKBAR | VSELACDQS | VSELACDQSBAR
 | VSELACCK | VSELACCKBAR | SLEWHOLD FALLADDRCMD | SLEWHOLDRISEADDRCMD
 | SLEWSETUP FALLADDRCMD | SLEWSETUPRISEADDRCMD | ACOVRSHOOTAREACKBAR |
 ACOVRSHOOTAREACK | ACOVRSHOOTAREADQSBAR | ACOVRSHOOTAREADQS | ACOVRSHOOTAREA
 | ACUNDSHOOTAREACKBAR | ACUNDSHOOTAREACK | CKSLEWRRISECK | CKSLEWFALLCK |
 CKSLEWRRISECKBAR | CKSLEWFALLCKBAR | ACUNDSHOOTAREADQSBAR | ACUNDSHOOTAREADQS
 | ACUNDSHOOTAREA | TSDIFFVREFBASED | TDHDIFFVREFBASED | VINCK | VINCKBAR
 | VINWCK | VINWCKBAR | TCMDS | TCM DH | TAS | TAH | TCMDPW | TAPW |
 WCKSLEWRRISEWCK | WCKSLEWRRISEWCKBAR | WCKSLEWFALLWCL | WCKSLEWFALLWCKBAR |
 TWCK | TWCKHP | TWCKL | TWCKH | TDVACWCK | SSCDOWNSPREADWCK | SSCMODFREQWCK |
 TDVACCCK | SSCDOWNSPREADCK | SSCMIDFREQCK | SSCPROVILECK | SSCPROVILEWCK | TRC
 | TRAS | TRCDRD | TRCDWR | TRTPL | TPPD | TRPREF | TRPSRE | TRPMRS | TRPACT
 | TRFC | TCKSRE | TCKSRX | TXSNRW | TREFTRWRITE | TREFTRREAD | TPD | TWSRE
 | TWRPDE | TRDSRE | TRDPDE | VMAXAC | VMINAC | TDQRRISESLEW | TDQFALLSLEW |
 TDQQTJ | TDQDJ | TDQRJ | VDQVOH | VDQVOL | TDQHP | TWCKRISESLEW | TWCKFALLSLEW
 | TWCKTJ | TWCKDJ | TWCKRJ | VOHWCK | VOHWCKBAR | VOLWCK | VOLWCKBAR |
 VWCKSWING | VIXDQ | VIXCA | ACOVRSHOOTAREADQ | ACUNDSHOOTAREADQ | ACOVRSHOOTDQ
 | ACUNDSHOOTDQ | TDVACDQS | TDVACDQSBAR | TDVACDQ | TDVACADDRCMD | TRP |
 TDQSS | TDVACADDRCMD | TRP | TDQSS | TDIPWHigh | TDIPWLow | VIH LAC | SRINrise
 | SRINfall | TQSH | TQSL | TIPWHIGHCA | TIPWLOWCA | TIPWHIGHCS | TIPWLOWCS
 | TISDERATEDCS | TISDERATEDCA | TISBASECS | TISBASECA | TIHDERATEDCS |
 TIHDERATEDCA | TIHBASECS | TIHBASECA | TLZDQ | THZDQ | TLZDQS | THZDQS | TWR |
 TWTR | TCCDRD | TCCDWR | DDRARXMASK | TRTP | CLOCKKEYWIDTH | CLOCKKEYDIAGRAM}

Inputs

See syntax for measurement options.

Outputs

None

DDRA:ADDALLDiffdqs

This command adds all the measurements listed under the differential DQS node.

NOTE. *If there is an error, the DDRA:LASTError? query returns measurement group does not exist under the generation or measurement type selected.*

Syntax

DDRA:ADDALLDiffdqs

Inputs

None

Outputs

None

DDRA:ADDALLSEdqs

This command adds all the measurements listed under the Single-Ended DQS node.

NOTE. *If there is an error, the DDRA:LASTError? query returns measurement group does not exist under the generation or measurement type selected.*

Syntax

DDRA:ADDALLSEdqs

Inputs

None

Outputs

None

DDRA:ADDALLSLewdq

This command adds all the measurements listed under the Slew-Rate DQ node.

NOTE. *If there is an error, the DDRA:LASTError? query returns measurement group does not exist under the generation or measurement type selected.*

Syntax

DDRA:ADDALLSLewdq

Inputs

None

Outputs

None

DDRA:ADDALLTerr

This command adds all the measurements listed under the Terr node.

NOTE. *If there is an error, the DDRA:LASTError? query returns measurement group does not exist under the generation or measurement type selected.*

Syntax

DDRA:ADDALLTerr

Inputs

None

Outputs

None

DDRA:CLEARALLMeas

This command clears the entire list of defined measurements in DDRA.

Syntax

DDRA: CLEARALLMeas

Inputs

None

Outputs

None

DDRA:LASTError?

This query command returns a string containing the last DDRA error. If no errors have occurred since startup or since the last call to :DDRA:LASTError?, this command returns an empty string.

Syntax

DDRA: HORIZontalscaling?

Inputs

None

Outputs

String containing the last error.

DDRA:GENeration

This command sets or queries the standard DDR generation.

Syntax

```
DDRA:GENeration {DDR | DDR2 | DDR3 | DDR3L | DDR4 | LPDDR | LPDDR2 | LPDDR3  
| GDDR3 | GDDR5}
```

```
DDRA:GENeration?
```

Inputs

```
{DDR | DDR2 | DDR3 | DDR3L | DDR4 | LPDDR | LPDDR2 | LPDDR3 | GDDR3 | GDDR5}
```

Outputs

```
{DDR | DDR2 | DDR3 | DDR3L | DDR4 | LPDDR | LPDDR2 | LPDDR3 | GDDR3 | GDDR5}
```

DDRA:DATARate

This command sets or queries the standard data rate for a particular DDR generation.

NOTE. *If there is an error, the DDRA:LASTError? query returns invalid data rate value, for the generation selected.*

Syntax

```
DDRA:DATARate {"200" | "266" | "333" | "400" | "533" | "667" | "800" | "933" |  
"1066" | "1333" | "1466" | "1600" | "1866" | "2133" | "2400" | "2666" | "3200"  
| "370" | "500" | "600" | "700" | "800" | "900" | "1000" | "4000" | "4800" |  
"5000" | "5500" | "CUSTOM"}
```

```
DDRA:DATARate?
```

Inputs

String.

Outputs

The current data rate. A query for DDRA:LASTError returns Invalid data rate value, for the generation selected.

DDRA:CUSTOMRate

This command sets or queries the custom data rate for a particular DDR generation.

NOTE. *If there is an error, the DDRA:LASTError? query returns set the data rate to custom.*

Syntax

DDRA:CUSTOMRate <NR3>

DDRA:CUSTOMRate?

Inputs

<NR3>

Outputs

<NR3>

DDRA:MEASType

This command sets or queries the measurement type for a particular DDR generation.

Syntax

```
DDRA:MEASType {WRITEbursts | READbursts | CKDiff | CKSE | DQSSE | ADDR CMD |  
WCKDiff | WCKSE | REFRESH | PRECHARGE | POWERDown | ACTive | DQSSERead}
```

```
DPOJET:MEASType?
```

Inputs

```
{WRITEbursts | READbursts | CKDiff | CKSE | DQSSE | ADDR CMD | WCKDiff | WCKSE  
| REFRESH | PRECHARGE | POWERDown | ACTive | DQSSERead}
```

Outputs

The selected measurement type.

DDRA:VDDMode

This command sets or queries the VDD mode for a particular DDR generation.

Syntax

```
DDRA:VDDMode {JEDEC | Manual}
```

```
DDRA:VDDMode?
```

Inputs

```
{JEDEC | Manual}
```

Outputs

The currently selected VDD mode {JEDEC | Manual}.

DDRA:VDD

This command sets or queries the user-defined VDD value for a particular DDR generation.

NOTE. *If there is an error, the DDRA:LASTError? query returns select user defined mode to configure Vdd/Vref value.*

Syntax

DDRA:VDD <NR3>

DDRA:VDD?

Inputs

<NR3>

Outputs

<NR3>

DDRA:VREFMode

This command sets or queries the Vref mode for a particular DDR generation.

Syntax

DDRA:VREFMode {JEDEC | Manual}

DDRA:VREFMode?

Inputs

{JEDEC | Manual}

Outputs

The currently selected Vref mode {JEDEC | Manual}.

DDRA:VREF

This command sets or queries the user-defined Vref value for a particular DDR generation.

NOTE. *If there is an error, the DDRA:LASTError? query returns select user defined mode to configure Vdd/Vref value.*

Syntax

DDRA:VREF <NR3>

DDRA:VREF?

Inputs

<NR3>

Outputs

<NR3>

DDRA:VIHACMin?

This query-only command returns the VIHACMin value.

Syntax

DDRA:VIHACMin?

Inputs

None.

Outputs

<NR3>

DDRA:VIHDCMin?

This query-only command returns the VIHDCMin value.

Syntax

DDRA:VIHDCMin?

Inputs

None

Outputs

<NR3>

DDRA:VREFDC?

This query-only command returns the VREFDC value.

Syntax

DDRA:VREFDC?

Inputs

None

Outputs

<NR3>

DDRA:VILDCMax?

This query-only command returns the VILDCMax value.

Syntax

DDRA:VILDCMax?

Inputs

None

Outputs

<NR3>

DDRA:VILACMax?

This query-only command returns the VILACMax value.

Syntax

DDRA:VILACMax?

Inputs

None

Outputs

<NR3>

DDRA:SOURCE?

This branch-query command returns the sources selected for the measurement.

Syntax

DDRA:SOURCE?

Inputs

None

Outputs

String

DDRA:SOURCE:STROBE

This command sets or queries the sources for the strobe source type.

NOTE. *If there is an error, the DDRA:LASTError? query returns select a measurement and set the applicable source type.*

Syntax

DDRA:SOURCE:STROBE {CH1 | CH2 | CH3 | CH4 | MATH1 | MATH2 | MATH3 | MATH4 |
REF1 | REF2 | REF3 | REF4}

DDRA:SOURCE:STROBE?

Inputs

{CH1 | CH2 | CH3 | CH4 | MATH1 | MATH2 | MATH3 | MATH4 | REF1 | REF2 | REF3 |
REF4}

Outputs

{CH1 | CH2 | CH3 | CH4 | MATH1 | MATH2 | MATH3 | MATH4 | REF1 | REF2 | REF3 |
REF4}

DDRA:SOURCE:STRObebar

This command sets or queries the sources for the strobe bar source type.

NOTE. *If there is an error, the DDRA:LASTError? query returns select a measurement and set the applicable source type.*

Syntax

```
DDRA:SOURCE:STRObebar {CH1 | CH2 | CH3 | CH4 | MATH1 | MATH2 | MATH3 | MATH4  
| REF1 | REF2 | REF3 | REF4}
```

```
DDRA:SOURCE:STRObebar?
```

Inputs

```
{CH1 | CH2 | CH3 | CH4 | MATH1 | MATH2 | MATH3 | MATH4 | REF1 | REF2 | REF3 |  
REF4}
```

Outputs

```
{CH1 | CH2 | CH3 | CH4 | MATH1 | MATH2 | MATH3 | MATH4 | REF1 | REF2 | REF3 |  
REF4}
```

DDRA:SOURCE:DATA

This command sets or queries the sources for the data source type.

NOTE. *If there is an error, the DDRA:LASTError? query returns select a measurement and set the applicable source type.*

Syntax

```
DDRA:SOURCE:DATA {CH1 | CH2 | CH3 | CH4 | MATH1 | MATH2 | MATH3 | MATH4 | REF1  
| REF2 | REF3 | REF4}
```

```
DDRA:SOURCE:DATA?
```

Inputs

```
{CH1 | CH2 | CH3 | CH4 | MATH1 | MATH2 | MATH3 | MATH4 | REF1 | REF2 | REF3 |  
REF4}
```

Outputs

```
{CH1 | CH2 | CH3 | CH4 | MATH1 | MATH2 | MATH3 | MATH4 | REF1 | REF2 | REF3 |  
REF4}
```

DDRA:SOURCE:CLOCK

This command sets or queries the sources for the clock source type.

NOTE. *If there is an error, the DDRA:LASTError? query returns select a measurement and set the applicable source type.*

Syntax

DDRA:SOURCE:CLOCK {CH1 | CH2 | CH3 | CH4 | MATH1 | MATH2 | MATH3 | MATH4 |
REF1 | REF2 | REF3 | REF4}

DDRA:SOURCE:CLOCK?

Inputs

{CH1 | CH2 | CH3 | CH4 | MATH1 | MATH2 | MATH3 | MATH4 | REF1 | REF2 | REF3 |
REF4}

Outputs

{CH1 | CH2 | CH3 | CH4 | MATH1 | MATH2 | MATH3 | MATH4 | REF1 | REF2 | REF3 |
REF4}

DDRA:SOURCE:CLOCKBar

This command sets or queries the sources for the clock bar source type.

NOTE. *If there is an error, the DDRA:LASTError? query returns select a measurement and set the applicable source type.*

Syntax

```
DDRA:SOURCE:CLOCKBar {CH1 | CH2 | CH3 | CH4 | MATH1 | MATH2 | MATH3 | MATH4  
| REF1 | REF2 | REF3 | REF4}
```

```
DDRA:SOURCE:CLOCKBar?
```

Inputs

```
{CH1 | CH2 | CH3 | CH4 | MATH1 | MATH2 | MATH3 | MATH4 | REF1 | REF2 | REF3 |  
REF4}
```

Outputs

```
{CH1 | CH2 | CH3 | CH4 | MATH1 | MATH2 | MATH3 | MATH4 | REF1 | REF2 | REF3 |  
REF4}
```

DDRA:SOURCE:WCK

This command sets or queries the sources for the WCK source type.

NOTE. *If there is an error, the DDRA:LASTError? query returns select a measurement and set the applicable source type.*

Syntax

DDRA:SOURCE:WCK {CH1 | CH2 | CH3 | CH4 | MATH1 | MATH2 | MATH3 | MATH4 | REF1
| REF2 | REF3 | REF4}

DDRA:SOURCE:WCK?

Inputs

{CH1 | CH2 | CH3 | CH4 | MATH1 | MATH2 | MATH3 | MATH4 | REF1 | REF2 | REF3 |
REF4}

Outputs

{CH1 | CH2 | CH3 | CH4 | MATH1 | MATH2 | MATH3 | MATH4 | REF1 | REF2 | REF3
| REF4}.

DDRA:SOURCE:WCKBar

This command sets or queries the sources for the WCK bar source type.

NOTE. *If there is an error, the DDRA:LASTError? query returns select a measurement and set the applicable source type.*

Syntax

```
DDRA:SOURCE:WCKBar {CH1 | CH2 | CH3 | CH4 | MATH1 | MATH2 | MATH3 | MATH4 |  
REF1 | REF2 | REF3 | REF4}
```

```
DDRA:SOURCE:WCKBar?
```

Inputs

```
{CH1 | CH2 | CH3 | CH4 | MATH1 | MATH2 | MATH3 | MATH4 | REF1 | REF2 | REF3 |  
REF4}
```

Outputs

```
{CH1 | CH2 | CH3 | CH4 | MATH1 | MATH2 | MATH3 | MATH4 | REF1 | REF2 | REF3  
| REF4}.
```

DDRA:BURSTDETECTmethod

This command sets or queries the Burst Detection method used for the measurement.

NOTE. *If there is an error, the DDRA:LASTError? query returns select a measurement and set the applicable source type.*

Syntax

```
DDRA:BURSTDETECTmethod {DQDQS | CHIPselectd | LOGICstate | VISUALSEARCH | NONE}
```

```
DDRA:BURSTDETECTmethod?
```

Inputs

```
{DQDQS | CHIPselectd | LOGICstate | VISUALSEARCH | NONE}
```

Outputs

```
{DQDQS | CHIPselectd | LOGICstate | VISUALSEARCH | NONE}
```

DDRA:BUS

This command sets or queries the Bus to be used for the measurements. The bus needs to be configured before being selected.

NOTE. *If there is an error, the DDRA:LASTError? query returns select a measurement, before selecting a bus.*

Syntax

DDRA:BUS {bus_name}

DDRA:BUS?

Inputs

String

Outputs

String

DDRA:SYMBOLFile

This command sets or queries the symbol file used for the selected bus. Select and configure the bus before selecting a symbol file for the particular bus.

NOTE. *If there is an error, the DDRA:LASTError? query returns a bus has to be selected and configured.*

Syntax

DDRA:SYMBOLFile {file_name}

DDRA:SYMBOLFile?

Inputs

String

Outputs

String

DDRA:LOGICTrigger

This command sets or queries the symbol that needs to be triggered for the selected bus. Select and configure the bus before selecting a symbol for the particular bus.

NOTE. *If there is an error, the DDRA:LASTError? query returns a bus has to be selected and configured.*

Syntax

DDRA:LOGICTrigger {READ | WRITE | ...}

DDRA:LOGICTrigger?

Inputs

<string> {READ | WRITE | ...}

Outputs

<string> {READ | WRITE | ...}

DDRA:BURSTTolerance

This command sets or queries the burst tolerance required for the selected bus. Select and configure the bus before setting the burst tolerance.

NOTE. *If there is an error, the DDRA:LASTError? query returns a bus has to be selected and configured.*

Syntax

DDRA:BURSTTolerance <NR3>

DDRA:BURSTTolerance?

Inputs

<NR3>

Outputs

<NR3>

DDRA:BURSTLAtency

This command sets or queries the Burst Latency required for the selected bus. Select and configure the bus before setting the burst latency.

NOTE. *If there is an error, the DDRA:LASTError? query returns a bus has to be selected and configured.*

Syntax

DDRA:BURSTLAtency <NR3>

DDRA:BURSTLAtency?

Inputs

<NR3>

Outputs

<NR3>.

DDRA:BURSTLength

This command sets or queries the burst length required for the selected bus. Select and configure the bus before setting the burst length.

NOTE. *If there is an error, the DDRA:LASTError? query returns a bus has to be selected and configured.*

Syntax

DDRA:BURSTLength <NR3>

DDRA:BURSTLength?

Inputs

<NR3>

Outputs

<NR3>

DDRA:ALternatethresholds

This command sets or queries the alternate thresholds for the measurements selected in a particular generation.

NOTE. *If there is an error, the DDRA:LASTError? query returns alternate threshold is not supported for the generation selected select a measurement, before selecting the alternate threshold.*

Syntax

```
DDRA:ALternatethresholds {AC175 | AC150 | AC225 | AC300}
```

```
DDRA:ALternatethresholds?
```

Inputs

```
{AC175 | AC150 | AC225 | AC300}
```

Outputs

```
{AC175 | AC150 | AC225 | AC300}
```

DDRA:VERTicalscaling

This command sets or queries the vertical scaling enabled or disabled for the measurements selected in a particular generation.

NOTE. *If there is an error, the DDRA:LASTError? query returns select a measurement, before selecting any of the scaling method.*

Syntax

DDRA:VERTicalscaling {0 | 1}

DDRA:VERTicalscaling?

Inputs

{0 | 1}

Outputs

{0 | 1}

DDRA:HORizontalscaling

This command sets or queries the horizontal scaling enabled or disabled for the measurements selected in a particular Generation.

NOTE. *If there is an error, the DDRA:LASTError? query returns select a measurement, before selecting any of the scaling method.*

Syntax

```
DDRA:HORizontalscaling {0 | 1}
```

```
DDRA:HORizontalscaling?
```

Inputs

```
{0 | 1}
```

Outputs

```
{0 | 1}
```

DDRA:CSSOURce

This command sets or queries the sources for the chip select source type..

Syntax

```
DDRA:CSSOURce {CH1 | CH2 | CH3 | CH4 | MATH1 | MATH2 | MATH3 | MATH4 | REF1  
| REF2 | REF3 | REF4}
```

```
DDRA:CSSOURce?
```

Inputs

```
{CH1 | CH2 | CH3 | CH4 | MATH1 | MATH2 | MATH3 | MATH4 | REF1 | REF2 | REF3 |  
REF4}
```

Outputs

```
{CH1 | CH2 | CH3 | CH4 | MATH1 | MATH2 | MATH3 | MATH4 | REF1 | REF2 | REF3 |  
REF4}
```

DDRA:CASMIN

This command sets or queries the CAS Min value for the chip select burst detection method.

Syntax

DDRA:CASMIN <NR3>

DDRA:CASMIN?

Inputs

<NR3>

Outputs

<NR3>

DDRA:CASMAX

This command sets or queries the CAS Max value for the chip select burst detection method.

Syntax

DDRA:CASMAX <NR3>

DDRA:CASMAX?

Inputs

<NR3>

Outputs

<NR3>

DDRA:CSLevel

This command sets or queries the chip select level.

Syntax

```
DDRA:CSLevel <NR3>
```

```
DDRA:CSLevel?
```

Inputs

```
<NR3>
```

Outputs

```
<NR3>
```

DDRA:CSMode

This command sets or queries the chip select mode.

Syntax

```
DDRA:CSMode {AUTO | MANUAL}
```

```
DDRA:CSMode?
```

Inputs

```
{AUTO | MANUAL}
```

Outputs

```
{AUTO | MANUAL}
```

DDRA:CSACTive

This command sets or queries the chip select active mode.

Syntax

DDRA:CSACTive {L | H}

DDRA:CSACTive?

Inputs

{L | H}

Outputs

{L | H}

DDRA:VERsion?

This command queries the DDRA Version.

Syntax

DDRA:VERsion?

Outputs

String

DDRA:BURSTLevelmode

This command sets or queries the burst level mode for the DQ and DQS settings.

Syntax

```
DDRA:BURSTLevelmode {AUTO | MANUAL}
```

```
DDRA:BURSTLevelmode?
```

Inputs

```
{AUTO | MANUAL}
```

Outputs

```
{AUTO | MANUAL}
```

DDRA:STROBEHIGH

This command sets or queries the strobe high value for the DQ and DQS settings.

Syntax

```
DDRA:STROBEHIGH <NR3>
```

```
DDRA:STROBEHIGH?
```

Inputs

```
<NR3>
```

Outputs

```
<NR3>
```

DDRA:STROBELOW

This command sets or queries the strobe low value for the DQ and DQS settings.

Syntax

DDRA:STROBELOW <NR3>

DDRA:STROBELOW?

Inputs

<NR3>

Outputs

<NR3>

DDRA:STROBEMID

This command sets or queries the strobe mid value for the DQ and DQS settings.

Syntax

DDRA:STROBEMID <NR3>

DDRA:STROBEMID?

Inputs

<NR3>

Outputs

<NR3>

DDRA:DATALOW

This command sets or queries the data low value for the DQ and DQS settings.

Syntax

```
DDRA:DATALOW <NR3>
```

```
DDRA:DATALOW?
```

Inputs

```
<NR3>
```

Outputs

```
<NR3>
```

DDRA:DATAHIGH

This command sets or queries the data high value for the DQ and DQS settings.

Syntax

```
DDRA:DATAHIGH <NR3>
```

```
DDRA:DATAHIGH?
```

Inputs

```
<NR3>
```

Outputs

```
<NR3>
```

DDRA:DATAMID

This command sets or queries the data mid value for the DQ and DQS settings.

Syntax

DDRA:DATAMID <NR3>

DDRA:DATAMID?

Inputs

<NR3>

Outputs

<NR3>

DDRA:HYSTEREsis

This command sets or queries the edge detection hysteresis value for the DQ and DQS settings.

Syntax

DDRA:HYSTEREsis <NR3>

DDRA:HYSTEREsis?

Inputs

<NR3>

Outputs

<NR3>

DDRA:MARGIN

This command sets or queries the termination logic margin value for the DQ and DQS settings.

Syntax

```
DDRA:MARGIN <NR3>
```

```
DDRA:MARGIN?
```

Inputs

```
<NR3>
```

Outputs

```
<NR3>
```

DDRA:DQDQSLEVELSTatus?

This command queries the DQ and DQS level status.

Syntax

```
DDRA:DQDQSLEVELSTatus?
```

Outputs

```
{AUTO | MANUAL
```

DDRA:VCENTDQ

This command sets or queries VCENTDQ.

Syntax

```
DDRA:VCENTDQ<NR3>
```

```
DDRA:VCENTDQ?
```

Inputs

```
<NR3>
```

Outputs

```
<NR3>
```

DDRA:FLTtype

This command sets or queries the interposer filter type.

Syntax

```
DDRA:FLTtype {None | USERDefined | DIRECTAttached | Socketed}
```

```
DDRA:FLTtype?
```

Inputs

```
{None | USERDefined | DIRECTAttached | Socketed}
```

Outputs

```
{None | USERDefined | DIRECTAttached | Socketed}
```

DDRA:PTYPDQS

This command sets or queries the probing type for DQS Signal.

Syntax

```
DDRA:PTYPDQS {DIFFerential | SINGLEended}
```

```
DDRA:PTYPDQS?
```

Inputs

```
{DIFFerential | SINGLEended}
```

Outputs

```
{DIFFerential | SINGLEended}
```

DDRA:PTYPCLK

This command sets or queries the probing type for Clock Signal.

Syntax

```
DDRA:PTYPCLK {DIFFerential | SINGLEended}
```

```
DDRA:PTYPCLK?
```

Inputs

```
{DIFFerential | SINGLEended}
```

Outputs

```
{DIFFerential | SINGLEended}
```

DDRA:PTYPWCK

This command sets or queries the probing type for WCK Signal.

Syntax

```
DDRA:PTYPWCK {DIFFerential | SINGLEended}
```

```
DDRA:PTYPWCK?
```

Inputs

```
{DIFFerential | SINGLEended}
```

Outputs

```
{DIFFerential | SINGLEended}
```

DDRA:SEFLTFile

This command sets or queries the Single Ended interposer filter file used for the User Defined filter type.

Syntax

```
DDRA:SEFLTFile {file_name}
```

```
DDRA:SEFLTFile?
```

Inputs

```
string
```

Outputs

```
string
```

DDRA:DIFFFLTFile

This command sets or queries the Differential interposer filter file used for the User Defined filter type.

Syntax

```
DDRA:DIFFFLTFile {file_name}
```

```
DDRA:DIFFFLTFile?
```

Inputs

```
string
```

Outputs

```
string
```

DDRA:TCKAVGMIN

This command sets or queries TCKAVGMIN.

Syntax

```
DDRA:TCKAVGMIN<NR3>
```

```
DDRA:TCKAVGMIN?
```

Inputs

```
<NR3>
```

Outputs

```
<NR3>
```

DDRA:TCKAVG

This command sets or queries TCKAVG.

Syntax

DDRA:TCKAVG<NR3>

DDRA:TCKAVG?

Inputs

<NR3>

Outputs

<NR3>

Index

A

About DDRA, 10
 AC 150, 54
 AC 175, 53
 AC-Overshoot, 178
 AC-Overshoot(CK), 159
 AC-Overshoot(CK#), 158
 AC-Overshoot(DQS), 168
 AC-Overshoot(DQS#), 169
 AC-OvershootArea, 178
 AC-OvershootArea(CK), 160
 AC-OvershootArea(CK#), 159
 AC-OvershootArea(DQS), 170
 AC-OvershootArea(DQS#), 169
 AC-Undershoot, 179
 AC-Undershoot(CK), 161
 AC-Undershoot(CK#), 160
 AC-Undershoot(DQS), 170
 AC-Undershoot(DQS#), 171
 AC-UndershootArea, 179
 AC-UndershootArea(DQS), 172
 AC-UndershootArea(DQS#), 171
 Address/Command, 24
 Algorithms, 131
 Alternate Thresholds, 52
 Argument Types, 190

B

Browse, 11

C

Check Boxes, 11
 Chip Select, 43
 CKslew-Fall(CK), 162
 CKslew-Fall(CK#), 162
 CKslew-Rise(CK), 163
 CKslew-Rise(CK#), 163
 Clock(Diff), 21
 Clock(Single Ended), 22
 Command button, 11
 Control Panel
 Advanced Setup DPOJET, 14
 Clear, 14

Recalc, 14
 Run, 14
 Show Plots, 14
 Single, 14
 Conventions, 4
 Customer Feedback, 5

D

D, 18
 Data Eye Height, 133
 Data Eye Width
 superimposed eye, 132
 Data Rate, 68
 DDR, 4
 DDR Analysis, 30
 DDR Generation, 68
 DDR Method, 27
 DDR104, 128
 DDR105, 128
 DDR106, 128
 DDR107, 128
 DDR2-tDQSK, 148
 DDRA, 4
 DDRA Prerequisites, 7
 Derating, 182
 Directories, 13
 64-bit systems, 13
 DPOJET, 4
 DQ/DQS Phase Alignment, 41
 DQS(Single Ended), 23
 DUT, 4
 Dynamic Limits, 18
 Dynamic Limits for DDR, 111
 Dynamic Limits for DDR2, 112
 Dynamic Limits for DDR3, 113
 Dynamic Limits for DDR3L, 114
 Dynamic Limits for DDR4, 115
 Dynamic Limits for LPDDR, 108
 Dynamic Limits for
 LPDDR2, 109
 Dynamic Limits for
 LPDDR3, 110

E

E1001, 126
 E1002, 126
 E1003, 126
 E1004, 126
 E1005, 126
 E1006, 126
 E1007, 126
 E1008, 126
 E1009, 126
 E1010, 126
 E1012, 126
 E1013, 126
 E102, 125
 E1020, 126
 E1021, 126
 E1022, 126
 E1026, 126
 E1027, 126
 E1028, 126
 E1029, 126
 E103, 125
 E1035, 126
 E104, 125
 E1040, 126
 E105, 125
 E1054, 126
 E1055, 126
 E1056, 126
 E1057, 126
 E1058, 126
 E1059, 126
 E106, 125
 E1061, 127
 E1062, 127
 E1063, 127
 E2001, 127
 E2002, 127
 E2003, 127
 E2004, 127
 E2005, 127
 E2006, 127
 E2007, 127
 E2008, 127

- E202, 125
E3001, 127
E3002, 127
E3003, 127
E3004, 127
E3005, 127
E3006, 127
E3007, 127
E3008, 127
E3010, 127
E3011, 127
E3012, 127
E400, 125
E4000, 127
E4001, 127
E4002, 127
E4003, 127
E4004, 127
E4005, 127
E4006, 128
E4007, 128
E4027, 128
E4028, 128
E4029, 128
E4030, 128
E4031, 128
E411, 126
E424, 126
E425, 126
E500, 126
- F**
File Name
 .csv, 13
 .mht, 13
 .set, 13
 .wfm, 13
- G**
Generations
 DDR, 7
 DDR2, 7
 DDR3, 7
 GDDR3, 7
 LPDDR, 7
GPIB Commands
 DDRA: GENeration, 195
- DDRA:ADDALLD-
 iffdqs, 192
DDRA:ADDALLSEdqs, 192
DDRA:ADDALL-
 SLewdq, 193
DDRA:ADDALLTerr, 193
DDRA:ADDMeas, 190
DDRA:ALTernatethresh-
 olds, 215
DDRA:BURSTDETECT-
 method, 210
DDRA:BURSTLATency, 213
DDRA:BURSTLEngth, 214
DDRA:BURSTToler-
 ance, 213
DDRA:BUS, 211
DDRA:CASMAX, 218
DDRA:CASMIN, 218
DDRA:CLEAR-
 ALLMeas, 194
DDRA:CSACTive, 220
DDRA:CSLEvel, 219
DDRA:CSMOde, 219
DDRA:CSSOURce, 217
DDRA:CUSTOMRate, 197
DDRA:DATAHIGH, 223
DDRA:DATALOW, 223
DDRA:DATAMID, 224
DDRA:DATARate, 196
DDRA:DIFFFLTFile, 229
DDRA:DQDQSLEVELSTA-
 tus, 225
DDRA:FLTtype, 226
DDRA:HORizontalscal-
 ing, 217
DDRA:HYSTEREsis, 224
DDRA:LOGICTrigger, 212
DDRA:MARGIN, 225
DDRA:PTYPCLK, 227
DDRA:PTYPDQS, 227
DDRA:PTYPWCK, 228
DDRA:SEFLTFile, 228
DDRA:SOURCE?, 203
DDRA:SOURCE:CLOCK-
 , 206
DDRA:SOURCE:CLOCK-
 Bar, 207
DDRA:SOURCE:DATA, 205
- DDRA:SOURCE:STROBE-
 , 203
DDRA:SOURCE:WCK, 208
DDRA:SOURCE:WCK-
 Bar, 209
DDRA:STRObebar, 204
DDRA:STROBEHIGH, 221
DDRA:STROBELOW, 222
DDRA:STROBEMID, 222
DDRA:SYMBOLFile, 212
DDRA:TCKAVG, 230
DDRA:TCKAVGMIN, 229
DDRA:VCENTDQ, 226
DDRA:VDD, 199
DDRA:VDDMode, 198
DDRA:VERsion, 220
DDRA:VERTicalscal-
 ing, 216
DDRA:VIHACMin, 200
DDRA:VIHDCMin, 201
DDRA:VILACMax, 202
DDRA:VILDCMax, 202
DDRA:VREF, 200
DDRA:VREFDC, 201
DDRA:VREFMode, 199
DPOJET:MEAS<x>:RE-
 SULTs?, 194
DPOJET:MEASType, 198
GPIB Program, 189
GPIB Reference Materials, 189
- H**
Hints, 56
- I**
Input Slew-Diff-Fall(CK), 158
Input Slew-Diff-Fall(DQS), 134
Input Slew-Diff-Rise(CK), 157
Input Slew-Diff-Rise(DQS), 134
- L**
Limits, 16
Logic State, 44
- M**
Measurement Levels, 55

Measurement Sources

- DDR, 86
- DDR2, 89
- DDR3, 93
- DDR3L, 97
- DDR4, 100
- GDDR5, 104
- LPDDR, 75
- LPDDR2, 77
- LPDDR3, 82

Measurement Type

- Active, 35
- Address/Command, 35
- Clock (Single Ended), 35
- Clock(Diff), 35
- DQS(Single Ended), 35
- Power Down, 35
- Precharge, 35
- Read Bursts, 35
- Refresh, 35
- Slew Rate(Diff), 35
- WCK(Diff), 35
- WCK(Single Ended), 35
- Write Bursts, 35

N

- nominal metho, 27
- Nominal Method, 27

O

- Opt. ASM, 1
- Oscilloscope model number, 5
- Overshoot, 178

P

- Parameters, 67
- Plots, 58
- probes, 8

R

- Read Bursts, 20
- Recalling a Default Setup, 16
- Ref Levels Setup, 55
- Related Documentation, 3
- Reports, 58
- Requirements, 7

Results, 57

S

- Safety Summary, xi
- Saving a Setup, 15
- Search and Mark, 1
- Slew Rate-Hold-
 - Fall(Addr/Cmd), 180
- Slew Rate-Hold-Fall(DQ), 150
- Slew Rate-Hold-
 - Rise(Addr/Cmd), 180
- Slew Rate-Hold-Rise(DQ), 150
- Slew Rate-Hold-SE-
 - Fall(DQS), 139
- Slew Rate-Hold-SE-
 - Rise(DQS), 139
- Slew Rate-Setup-
 - Fall(Addr/Cmd), 180
- Slew Rate-Setup-Fall(DQ), 150
- Slew Rate-Setup-
 - Rise(Addr/Cmd), 180
- Slew Rate-Setup-Rise(DQ), 151
- Slew Rate-Setup-SE-
 - Fall(DQS), 139
- Slew Rate-Setup-SE-
 - Rise(DQS), 140
- Speed Bins, 33
- SRQdiff-Fall(DQS), 146
- SRQdiff-Rise(DQS), 146
- SRQse-Fall(DQ), 148
- SRQse-Rise(DQ), 149
- SSC Downspread(CK), 151
- SSC Downspread(WCK), 172
- SSC Mod Freq(CK), 151
- SSC Mod Freq(WCK), 172
- SSC Profile(CK), 151
- SSC Profile(WCK), 173
- Step1, 31
- Step2, 34
- Step4, 40
- Step5, 40
- Step6, 51
- Symbol file, 45

T

- tAC-Diff, 145
- tAH, 181

- tAPW, 181
- tAS, 181
- tCH, 151
- tCH(abs), 152
- tCH(avg), 153
- tCK, 152
- tCK(abs), 153
- tCK(avg), 153
- tCKSRE, 183
- tCKSRX, 183
- tCL, 152
- tCL(abs), 154
- tCL(avg), 154
- tCMDH, 181
- tCMDPW, 181
- tCMDS, 182
- tDH-Diff(base), 135
- tDH-Diff(derated), 135
- tDH-Diff(Vref-based), 135
- tDH-SE(base), 141
- tDIPW-SE, 140
- tDQSCK-Diff, 144
- tDQSCK-SE, 147
- tDQSH, 138
- tDQSL, 138
- tDQSQ-Diff, 144
- tDQSQ-SE, 147
- tDQSS-Diff, 139
- tDQSS-SE, 141
- tDS-Diff(base), 135
- tDS-Diff(derated), 137
- tDS-Diff(Vref-based), 137
- tDS-SE(base), 140
- tDSH-Diff, 139
- tDSH-SE, 140
- tDSS-Diff, 138
- tDSS-SE, 140
- tDVAC(CK), 141
- tDVAC(WCK), 173
- tERR
 - tERR(m-nper), 155
 - tERR(nper), 155
- tHP, 154
- tIH(base), 182
- tIH(derated), 183
- tIPW-High, 183
- tIPW-Low, 183
- tIS(base), 182

tIS(derated), 182
tJIT(cc), 156
tJIT(duty), 156
tJIT(per), 157
tPD, 184
tPPD, 187
tQH, 145
tRAS, 185
tRC, 185
tRCDRD, 186
tRCDWR, 186
tRDPDE, 149
tRDSRE, 149
tREFTR(Read), 184
TREFTR(Write), 184
tRFC, 184
tRP(ACT), 187
tRP(MRS), 188
tRP(REF), 188
tRP(SRE), 188
tRPRE, 150
tRPST, 150
tRTPL, 188
tWCK, 173
tWCK-DJ, 173
tWCK-Fall-Slew, 174
tWCK-Rise-Slew, 174
tWCK-RJ, 174
tWCK-TJ, 175
tWCKH, 173

tWCKHP, 174
tWCKL, 174
tWPRE, 142
tWPST, 143
tWRPDE, 143
tWRSRE, 143
tXSNRW, 184

U

Undershoot, 179

V

Vdd and Vref, 33
VID(ac), 157
VIN(CK), 163
VIN(CK#), 163
VIN(WCK), 175
VIN(WCK#), 175
Virtual Keypad, 12
Vix(ac)CK, 164
Vix(ac)DQS, 168
Vix(ac)WCK, 176
VOH, 176
VOH(WCK), 176
VOH(WCK#), 177
VOL, 176
VOL(WCK), 176
VOL(WCK#), 176
Vox(ac)CK, 164

Vox(ac)DQS, 168
VSEH(AC)CK, 165
VSEH(AC)CK#, 166
VSEH(CK), 166
VSEH(CK#), 166
VSEL(AC)CK, 167
VSEL(AC)CK#, 166
VSEL(CK), 167
VSEL(CK#), 167
VSWING(MAX)CK, 165
VSWING(MAX)CK#, 164
VWCK-Swing, 175

W

W1011, 126
W1051, 126
W1053, 126
W4008, 128
W4009, 128
W410, 125
WCKslew-Fall(WCK), 177
WCKslew-Fall(WCK#), 177
WCKslew-Rise(WCK), 177
WCKslew-Rise(WCK#), 177
Write Bursts, 19

X

XML, 16