

Technical Reference



InfiniBand Serial Data Compliance and Analysis Application Methods of Implementation (MOI) 071-2043-00

Copyright © Tektronix. All rights reserved. Licensed software products are owned by Tektronix or its suppliers and are protected by United States copyright laws and international treaty provisions.

Tektronix products are covered by U.S. and foreign patents, issued and pending. Information in this publication supercedes that in all previously published material. Specifications and price change privileges reserved.

TEKTRONIX, TEK and RT-Eye are registered trademarks of Tektronix, Inc.

Contacting Tektronix

Tektronix, Inc.
14200 SW Karl Braun Drive or P.O. Box 500
Beaverton, OR 97077 USA

For product information, sales, service, and technical support:

- In North America, call 1-800-833-9200.
- Worldwide, visit www.tektronix.com to find contacts in your area.

Table of Contents

1	Introduction to RT-Eye InfiniBand Compliance Module.....	1
2	Background on InfiniBand Compliance Testing	1
2.1	Compliance Statements and Test Definitions (TDs).....	1
2.2	Integrator List Tests for InfiniBand	4
3	InfiniBand Driver Compliance Measurements (MOIs)	5
3.1	Required Equipment	5
3.2	Connecting to the driver under test	5
3.2.1	SMA Connection	6
3.2.2	ECB pad connection.....	7
4	Configuring a Device Under Test (DUT) for Compliance Measurements	7
5	Initial Oscilloscope Setup	8
6	Running the RT-Eye Software	9
6.1	DC Common Mode Measurement MOI.....	10
6.2	AC Common Mode Measurement MOI.....	11
6.3	Transmitter Peak-Peak Measurement MOI	12
6.4	Rise/Fall Time Measurements	14
6.5	Driver Jitter Measurements.....	15
6.6	Combining Driver Measurements.....	17
7	InfiniBand Cable Measurements.....	17
7.1	Required Equipment	17
7.2	Connecting to the Driver Under Test.....	18
7.3	Configuring the Device Under Test (DUT) for Compliance Measurements.....	18
7.4	Initial Oscilloscope Setup	18
7.5	Running the RT-Eye Software	18
7.6	Cable Connected Minimum Differential Voltage	19
7.7	Combining Cable Measurements	20
8	Giving a Device an ID.....	20
9	Creating a Compliance Report.....	20
10	Appendix A – Measurement Algorithms.....	21

1 Introduction to RT-Eye InfiniBand Compliance Module

This document provides the procedures for making InfiniBand compliance measurements with Tektronix TDS/CSA7000, DSA/DPO 70000 and TDS6000 series real time oscilloscopes (4 GHz models and above). The InfiniBand Compliance Module (Opt. IBA) is an optional software plug-in to the RT-Eye Serial Data Compliance and Analysis application (Opt. RTE). The InfiniBand Compliance module provides Amplitude, Timing, and Jitter measurements described in the electrical specification sections of the InfiniBand Architecture Specification.

The IBTA-CIWG (InfiniBand Trade Association - Compliance and Interoperability Working Group) has defined a suite of electrical measurements that InfiniBand devices must pass to qualify for the InfiniBand Integrators List (IL). Manufacturers periodically perform these measurements on their InfiniBand devices at InfiniBand plugfests. The RT-Eye InfiniBand Compliance Module automates and provides Pass/Fail limit testing on many of these required IL measurements, as well as additional measurements that appear in the electrical specification.

In the subsequent sections, step-by-step procedures are described to help you perform these measurements on your InfiniBand devices. Measurements that are required to qualify for the IL are noted as such and appear in the **IBTA CIWG Subgroup Method of Implementation (MOI)** document available for download to IBTA members at www.infinibandta.com.

2 Background on InfiniBand Compliance Testing

2.1 Compliance Statements and Test Definitions (TDs)

Compliance statements appear in the InfiniBand architecture specification.

Chapter 6 - driver characteristics compliance statement are as follows:

C6-7: All output ports SHALL comply with the parameters and notes of the Table 16 Driver Characteristics using appropriate parameters as noted.

From compliance statements, the CIWG-PHY (Compliance and Interoperability Working Group – Physical Layer Subgroup) has developed Test Definitions (TDs) for measurements in Table 16. Test Definition assertions that have been given the following designations.

Table 1 – Chapter 6 Driver Test Definitions (TDs) from Table 16 of the Specification

CIWG-PHY TD Assertion	Measurement	Symbol in Chap. 6, Table 16	Min	Max
V2c6-007#01	Common Mode Voltage	V_{CM}	0.5V	1.0V
V2c6-007#02	Pk-Pk Differential Voltage	V_{diff}	Table19 ¹	1.6V
V2c6-007#03	Disable Mode Output pk-pk	$V_{disable}$	0	85mV
V2c6-007#03	Disable Mode Output max	$V_{disable}$	0	1.6V
V2c6-007#04	Standby Mode Output pk-pk	$V_{standby}$	0	85mV
V2c6-007#04	Standby Mode Output max	$V_{standby}$	0	1.6V
V2c6-007#05	Driver Rise/Fall Time (20-80%)	t_{DRF}	100ps	
	AC Common Mode Voltage	V_{ACCM}		25mV
V2c6-007#14	Driver Total Jitter	J_T		Table19*
V2c6-007#14	Driver Deterministic I Jitter	J_D		0.17UI

¹ Minimum Differential Pk-Pk Voltage and Jitter @ 10^{-12} BER is dependent on Table 19 in Chapter 6 of the InfiniBand specification. Test Points (compliance points) are defined based on where in the system the measurement is being made.

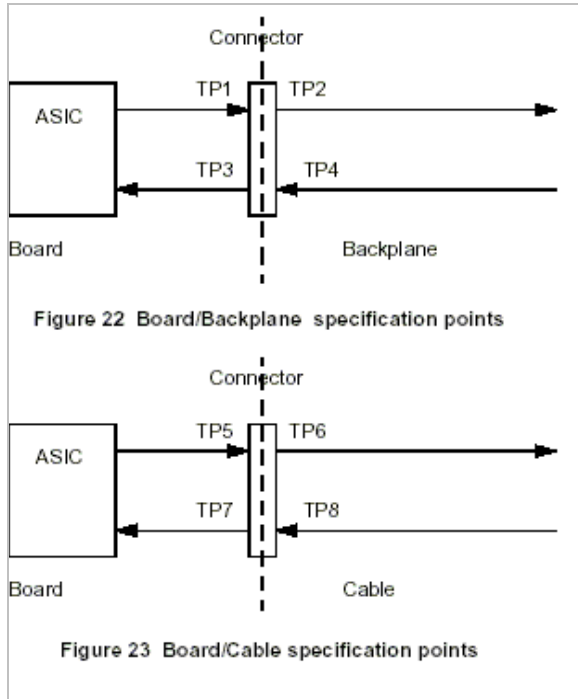

Figure 1 – Compliance Points from InfiniBand Specification

Chapter 7 Cable characteristics compliance statement is as follows:

C7-16: Cable assemblies to be used for InfiniBand **shall** meet the electrical requirements listed in Table 30 for all link widths for port type 1.

Table 2 – Chapter 7 Cable Test Definitions (TDs) from Table 30 of the Specification

CIWG-PHY TD Assertion	Measurement	Symbol in	Min	Max
V2c7-002#09	Cable Connector Near End Cross Talk			
V2c7-002#010	Cable Assembly Min Differential Voltage	VCout	316mV	
V2c07-016#01 V2c07-016#02	Cable Differential Impedance	Zdca(nom)		
V2c07-016#05	Cable Connection Jitter	Jca		.25UI

2.2 Integrator List Tests for InfiniBand

Table 3 shows the measurements that are available in the RT-Eye InfiniBand Compliance Module and how they map to electrical measurements in Chapter 6 and Chapter 7 of the InfiniBand Architecture Specification. Also shown is whether or not the measurement is an Integrator List (IL) test. IL tests are required to have your device certified as InfiniBand compliant. Other measurements are useful, but not required.

Table 3 – RT-Eye Measurements Mapped to Chapter 6 and Chapter 7 Measurements

Measurement	Integrator List Tests	Available in RT-Eye InfiniBand Compliance Module
Electrical Driver Measurements (Chapter 6 of IBA Specification)		
Waveform Eye Height	Yes	Yes
Waveform Eye Width	No	Yes
Common Mode DC Voltage	No	Yes
Common Mode AC Voltage	No	Yes
Transmitter Peak-Peak Voltage	Yes	Yes
Transmitter Transition Time (20-80 Rise/FallTime)	Yes	Yes
Driver Total Jitter @ e ⁻¹² BER	Yes	Yes
Electrical Cable Measurements (Chapter 7 of IBA Specification)		
Cable Connected Eye Height	No	Yes
Cable Connected Eye Width	No	Yes
Cable Connection Jitter (TIE)	Yes	Yes
Cable Connector Minimum Differential Voltage	Yes	Yes
Cable Connector Near End CrossTalk	Yes	No (Use TDS8000 series sampling oscilloscopes)
Cable Differential Impedance	Yes	

3 InfiniBand Driver Compliance Measurements (MOIs)

This section applies Methods of Implementation (MOI) to the Test Definitions as they relate to Tektronix real-time oscilloscopes, probing solutions, and RT-Eye Serial Compliance and Analysis software.

3.1 Required Equipment

The following equipment is required to take the measurements in this document.

- TDS/CSA7404 or TDS6000 series oscilloscope equipped with TDS RT-Eye software (Opt. RTE) and InfiniBand Compliance Module (IBA).
- Probes – probing configuration is MOI specific. Refer to each MOI for proper probe configuration.
- InfiniBand breakout cable (available from Fujikura Ltd.)

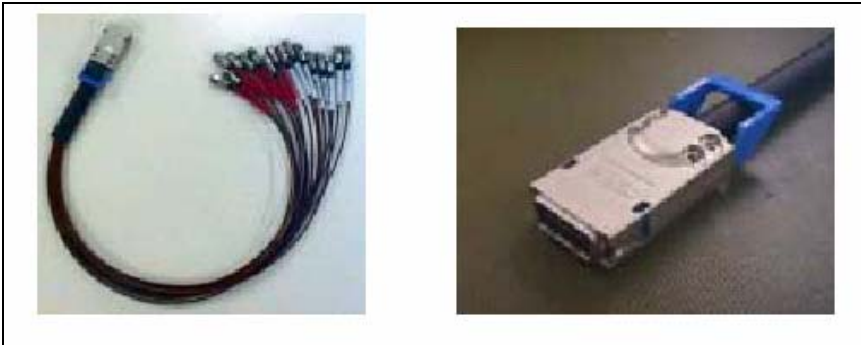

Figure 2 - Fujikura InfiniBand 4X Break-out harness

3.2 Connecting to the driver under test

The first step is to probe the link. Connect your probes based on one of the four methods described below.

Table 4 – Probing Configurations for an InfiniBand Link

		Probing Configurations			Captured Waveforms		System Specifications				
		Probe	Break Serial Link	Channels Used	Differential Mode	Common Mode	TDS6604		TDS/CSA7404		
								Band Width	Rise* Time (20-80)	Band Width	Rise* Time (20-80)
SMA Connection	A	2 x TCA-SMA	Y	2	Pseudo	AC	6GHz	53ps	4GHz	75ps	
	B	1 x P7350SMA	Y	1	True	No	5GHz	65ps	4GHz	75ps	
ECB Pad Connection	C	2 x P7260	Y/N	2	Pseudo	AC/DC	6GHz	53ps	4GHz	75ps	
		2 x P7350	Y/N	2	Pseudo	AC/DC	5GHz	65ps	4GHz	75ps	
		2 x P7240	Y/N	2	Pseudo	AC/DC	na	na	4GHz	75ps	
	D	1 x P7350	Y/N	1	True	No	5GHz	65ps	4GHz	75ps	

*Typical

3.2.1 SMA Connection

1. **Two TCA-SMA inputs using SMA cables (Ch1 and Ch3)**

The differential signal is created by the RT-Eye SW from the math waveform Ch1-Ch3. The Common mode AC measurement is also available in this configuration from the common mode waveform $(Ch1+Ch3)/2$. This probing technique requires breaking the link and terminating into the $50\ \Omega$ /side termination into the oscilloscope. While in this mode, the InfiniBand SerDes will transmit the 320 bit Jitter test pattern designed to maximize data dependent jitter. Ch-Ch deskew is required using this technique because two channels are used.

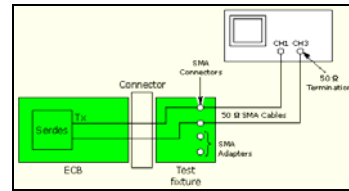

Probe Configuration A
SMA Pseudo-differential

2. **One P7350SMA differential active probe (Ch1)**

The differential signal is measured across the termination resistors inside the P7350SMA probe. This probing technique requires breaking the link. While in this mode, the InfiniBand SerDes will transmit the 320 bit Jitter test pattern designed to maximize data dependent jitter. Matched cables are provided with the P7350 probe to avoid introducing de-skew into the system. Only one channel of the oscilloscope is used.

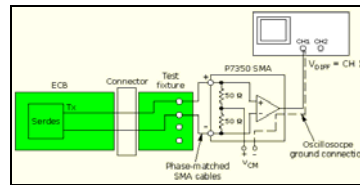

Probe Configuration B
SMA Input Differential Probe

3.2.2 ECB pad connection

3. Two P7260 single ended active probes (Ch1 and Ch3)

The differential signal is created by the RT-Eye SW from the math waveform Ch1-Ch3. The Common mode AC measurement is also available in this configuration from the common mode waveform $(Ch1+Ch3)/2$. This probing technique can be used for either a live link that is transmitting data, or a link terminated into a “dummy load.” In both cases, the single ended signals should be probed as close as possible to the termination resistors on both sides with the shortest ground connection possible. Ch-Ch skew is required using this technique because two channels are used.

4. One Differential probe

The differential signal is measured directly across the termination resistors. This probing technique can be used for either a live link that is transmitting data, or a link terminated into a “dummy load.” In both cases, the signals should be probed as close as possible to the termination resistors. A single channel of the oscilloscope is used, so de-skew is not necessary. Two P7350 differential probes can be used to create probing configuration shown in configuration “C” above.

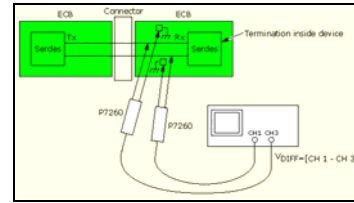

Probe Configuration C

Two Single Ended Active Probes

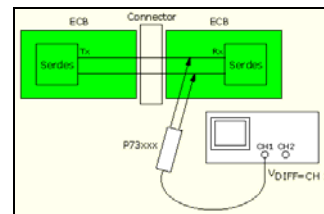

Probe Configuration D

One Differential Active Probe

4 Configuring a Device Under Test (DUT) for Compliance Measurements

To perform compliance measurements on an InfiniBand link, it is required that the link be configured to generate Back to Back TS1 (BTBTS1) test pattern. The following describes various methods of obtaining a TS1 signal out of ones HCA/TCA.

Beacon Method. The InfiniBand beacon signal is the default signal which is broadcast on a repeating basis when there is no form of link established. The Beacon is comprised of 100 mSec of sleep state followed by 1 mSec of TS1's back to back. A simple edge trigger on an instrument is capable of triggering on the leading edge of this 1 mSec interval of TS1's. It is recommended however that one use a delayed trigger of at least 50 uSec ensure the RC ramping found on the leading edge of this TS1 beacon be excluded from any measurements. The trigger menu setup from TDS oscilloscopes to establish this delay is shown in Figure 3.

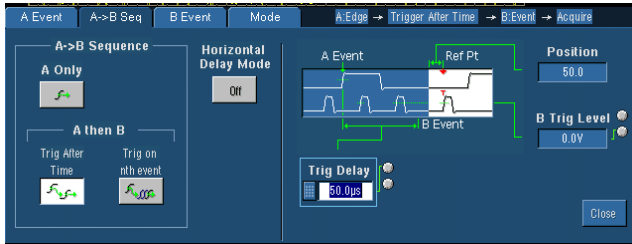

Figure 3 – Beacon method

Loop-Back Method. This method loops back the transmit line from an un-used lane into the receive lane 0 (Figure 4). This results in a periodic (100 mSec) link state training machine stimulus into IbtXIn(0) which triggers a state change into the LTSM's "configuration" state. The LTSM will broadcast 100 mSec of TS1's in a back to back form. This is the simplest method for generating the BTBTS1 pattern.

Note: The LTSM's Config.RcvrCfg state generally cycles back around immediately into the Config.debounce state in this configuration with no non-deterministic intervals introduced. Some systems handle the transition through the LinkDown Default Idle state differently, and this transition can lead to a short non-deterministic delay of ~30mSec before recycling into the Config.debounce state. In these systems use the Instruments timeout trigger capability (dial in 10mSec timeout) combined with a trigger delay to ensure this region of non-deterministic pre Donfig.debounce idle state does not appear in the region of data over which jitter computations would occur. Failure to do this can result in an "insufficient number of pattern repeats" warning.



Figure 4 – Loop back method

5 Initial Oscilloscope Setup

After hooking up to the DUT with the proper probing configuration for the test, press the DEFAULT front-panel button and then the AUTOSET button to display the serial data bit stream.

6 Running the RT-Eye Software

- 1. Go to File > Run Application > RT-Eye Serial Compliance and Analysis.

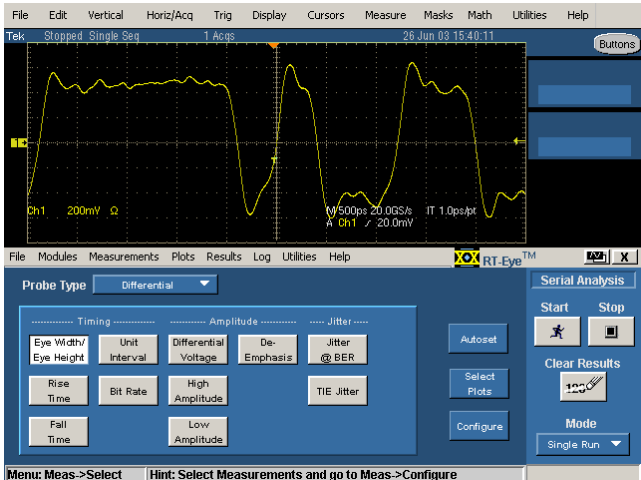

Figure 5 – Default menu of the RT-Eye software

Figure 5 shows the oscilloscope display. The default mode of the software is the **Serial Analysis** module (Opt. RTE). This software is intended for generalized Serial Data analysis on 8B/10B encoded copper links.

- 2. Select the InfiniBand Compliance Module from the Modules pull down list.

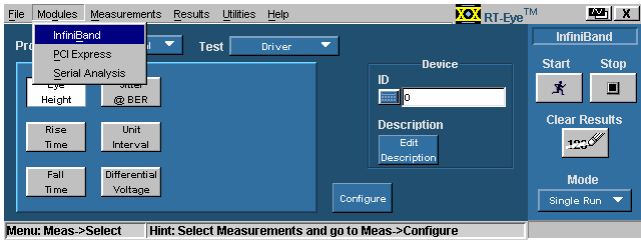

Figure 6 – Choosing the InfiniBand Compliance Module

Note: If InfiniBand does not appear in the list, the InfiniBand Compliance Module (Opt. IBA) has not been installed.

The rest of this document details use of the RT-Eye InfiniBand Compliance Module to perform electrical compliance measurements.

Online Help is available under the Help Menu for the software when it's in the Serial Analysis Module. For information not contained in this document, refer to the RT-Eye online help or the printable format.

6.1 DC Common Mode Measurement MOI

This test checks DC common mode voltage from the driver using Tektronix real-time oscilloscope, probes, and RT-Eye compliance software. This test checks the common mode voltage level of the transmitter output signal, is defined for a single physical bit lane, and must be repeated for each bit lane of each port on the DUT.

- TD Assertion covered: V2c6-007.
- V_{CM} is defined in Vol. 2, Section 6.4, table Differential Output DC Characteristics, Maximum $V_{CM}=1.0V$ and Minimum $V_{CM}=0.50V$.
- Integrator List Test: No.
- DUT Signaling: The test is performed on the TS1 ordered-sets captured by the oscilloscope while the DUT is in the Polling Active state described in section 3.3
- Probing Configuration: Probe Configuration C - Use two P7260 or two P7240 active probes.
- Test Procedure is as follows:
 - Connect the probe for the positive leg of the differential to Ch1 and the negative leg to Ch3.
 - In the RT-Eye InfiniBand compliance module, select **Single Ended** as the Probe Type.
 - Select **CM Voltage** as the measurement.
 - Select the **Configure** Button to access the Configuration menu.
 - Select the **Source** Tab and set up that menu as follows:
 - o Live as the Source Type.
 - o Select Ch1, Ch3 as the D+, D-.
- Select the **Start** button.

The RT-Eye application gives measurement results along with a Pass /Fail indication of the measurement. See Figure 7.

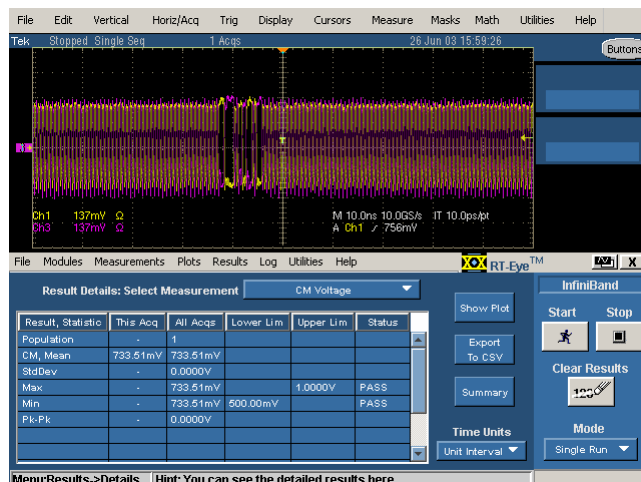

Figure 7 - Result of the DC Common Mode Measurement

6.2 AC Common Mode Measurement MOI

This test checks the AC common mode voltage from the driver using a Tektronix real-time oscilloscope and RT-Eye software. This test checks the common mode voltage level of the transmitter output signal, is defined for a single physical bit lane, and must be repeated for each bit lane of each port on the DUT.

- TD Assertion covered: None.
- V_{CM} is defined in Vol. 2, Section 6.4, table Differential Output DC Characteristics, Maximum V_{ACCM} = 25 mV RMS.
- Integrator List Test: No.
- DUT Signaling: The test is performed on the TS1 ordered-sets captured by the oscilloscope while the DUT is in the Polling Active state described in section 3.3.
- Probing Configurations (from section 3.2):
 - Configuration A – Use TCA-SMA connectors with blocking capacitors.
 - Configuration C - Use two P7260 or two P7240 active probes.
- Test Procedure as follows:
 - Connect the probe for the positive leg of the differential to Ch1 and the negative leg to Ch3.
 - In the RT-Eye InfiniBand compliance module, select Single Ended as the Probe Type.
 - Select AC CM Voltage as the measurement.
 - Select the Configure button to access the Configuration menus.
 - Select the Source tab and set up that menu as follows:
 - o Live as the Source Type.
 - o Select Ch1, Ch3 as the D+, D-.
 - Select the **Start** button.

The RT-Eye application gives measurement results along with a Pass /Fail indication of the measurement. See Figure 8.

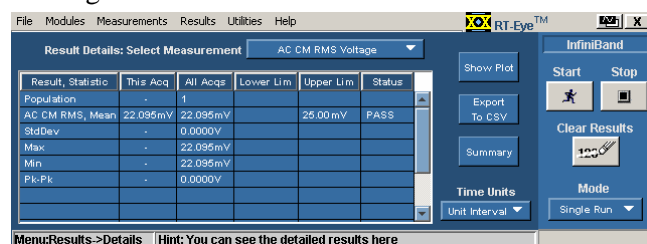

Figure 8 - Result of AC Common Mode Measurement

6.3 Transmitter Peak-Peak Measurement MOI

This test checks the Pk-Pk voltage from the driver using a Tektronix real-time oscilloscope and RT-Eye software. This test checks the Pk-Pk differential voltage level of the transmitter output signal, is defined for a single physical bit lane, and must be repeated for each bit lane of each port on the DUT. An eye diagram is displayed to give additional information on the health of the transmitter.

- TD Assertion covered: V2c6-007#02
- Vdiff is defined in Vol. 2, Section 6.4, table Differential Output Differential Pk-Pk Voltage Characteristics.
Maximum Vdiff = 1.6 V Pk-Pk, Minimum Vdiff is dependent on the test point.

Table 5 – Chapter 6 Test Point Descriptions, from Table 19 of the Specification*

Test point	Description	Unsigned Waveform Amplitude (IEEE181)	Eye Width
TP1	Transmitted signal at the board side of the backplane connector	.800	250 ps
TP2	Transmitted signal at the backplane side of the backplane connector	.750	240 ps
TP3	Received signal at the board side of the connector	.316	150 ps
TP4	Received signal at the backplane side of the connector	.335	160 ps
TP5	Transmitted signal at the board side of the cable connector	.890	250 ps
TP6	Transmitted signal at the cable side of the cable connector	.820	240 ps
TP7	Received signal at the board side of the cable connector	.282	150 ps
TP8	Received signal at the cable side of the cable connector	.300	160 ps
TP9	Transmitted signal at the board side of the pluggable interface socket	.890	296 ps
TP10	Received signal at the board side of the pluggable interface socket	.282	126 ps
* Measurements will require de-embedding or other compensation technique for properties of measurement fixtures and test equipment.			

- Integrator List Test: Yes
- DUT Signaling: The test is performed on the TS1 ordered-sets captured by the oscilloscope while the DUT is in the Polling Active state described in section 3.3.
- Probing Configurations (from section 3.2):
 - Configuration A – Use TCA-SMA connectors with blocking capacitors.
 - Configuration B – Use P7350SMA probe (recommended).
- Connect via port breakout (Fujikura fixture in 4X case) to SMA inputs of probe configuration.

- Test Procedure is as follows:
 - Connect the SMA connectors from the Break-out Harness to Ch1 and Ch3 of the oscilloscope, or to Ch1 depending on the probe configuration used.
 - In the RT-Eye InfiniBand compliance module, select Single Ended as the Probe Type if using probe configuration (A), or Differential as the Probe Type if using probe configuration (B).
 - Select Eye Height and Differential Voltage as the measurements.
 - Select the Configure button to access the Configuration menus.
 - Select the Source tab and set up that menu as follows:
 - o Live as the Source Type.
 - o Select Ch1, Ch3 as the D+, D- if using probe configuration (A) or select Ch1 if using probe configuration (B).
 - Select the **Start** button.

The RT-Eye application gives measurement results along with a Pass /Fail indication of the measurement. See Figure 9.

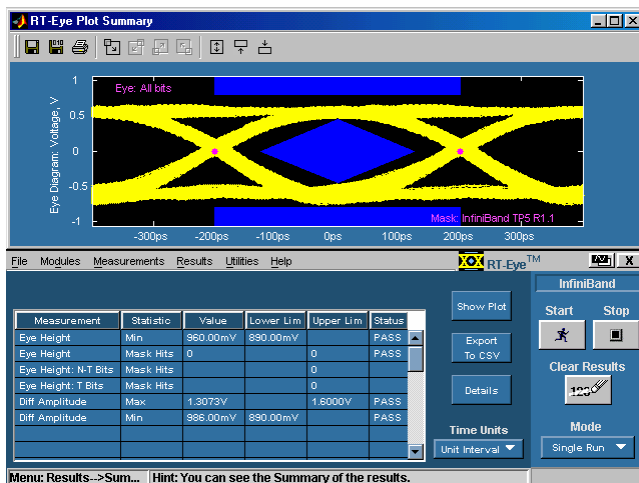

Figure 9 - Result of the Differential Amplitude Measurement

The last two lines report Pass/Fail on Min and Max of Diff Voltage Pk-Pk. The waveform is also compared to a waveform mask where the vertical and horizontal dimensions are defined by amplitude and jitter eye width. Note that the Lower Limit on the voltage is listed as 986 mV. The specification indicates 890 mV as the lower limit to TP5. Care should be taken to properly account and compensate for (Instruments external attenuation menu) for all line losses between the test-point and the instrument inputs.

The signal tested in this example exhibited 989 mV Pk-Pk amplitude. The measurement is a cycle-cycle differential voltage measurement on a 101 or a 010 bit combination. Note that this voltage is higher than the measured Eye Height in the eye diagram (960 mV).

This is typical, since the eye diagram adds a “smearing affect” that hides the true minimum differential Pk-Pk number. If you select the Details button in the RT-Eye software, it can be seen that the Min and Max Pk-Pk measurement were derived from 23,283 valid measurements within the real time acquisition. See Figure 10.

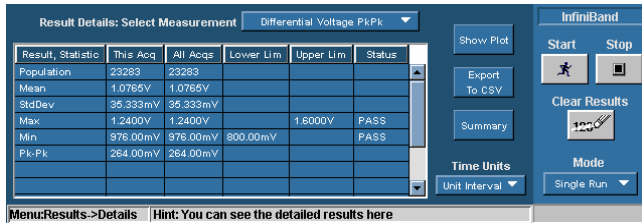

Figure 10 - Details View of Pk-Pk measurement

6.4 Rise/Fall Time Measurements

This test checks the Transition Times from the driver using Tektronix real-time oscilloscope and RT-Eye software. This test checks the 20-80% Rise/Fall times of the transmitter output signal and compares them against the specified limits. This test is defined for a single physical bit lane and must be repeated for each bit lane of each port on the DUT.

- TD Assertion covered: V2c6-007#05
- tDRF is defined in Vol. 2, Section 6.4, Table 16 of the specification, Characteristics
Minimum tDRF = 100 ps.
- Integrator List Test: Yes
- DUT Signaling: The test is performed on the TS1 ordered-sets captured by the oscilloscope while the DUT is in the Polling Active state described in section 3.3.
- Probing Configurations (from section 3.2):
- Configuration A – Use TCA-SMA connectors with blocking capacitors.
- Configuration B – Use P7350SMA probe (recommended).
- Connect via port breakout (Fujikura fixture in 4X case) to SMA inputs of probe configuration.
- Test Procedure is as follows:
 - Connect the SMA connectors from the Break-out Harness to Ch1 and Ch3 of the oscilloscope, or to Ch1 depending on the probe configuration used.
 - In the RT-Eye InfiniBand compliance module, select **Single Ended** as the Probe Type if using probe configuration (A) or **Differential** as the Probe Type if using probe configuration (B).
 - Select **Eye Height** and **Differential Voltage** as the measurements.
 - Select the **Configure** button to access the Configuration menus.
 - Select the **Source** tab and set up that menu as follows:
 - o Live as the Source Type.
 - o Select Ch1, Ch3 as the D+, D- option if using probe configuration (A), or select Ch1 if using probe configuration (B).

- Select the **Meas Params** tab and set up that menu as follows:
 - TP6 (Transmitted signal at the cable side of the cable connector) as the Test Point.
 - Stand By or Disable as the Differential Voltage Mode.
- Select the **Start** button.

The RT-Eye application gives measurement results along with a Pass /Fail indication of the measurement. See Figure 11.

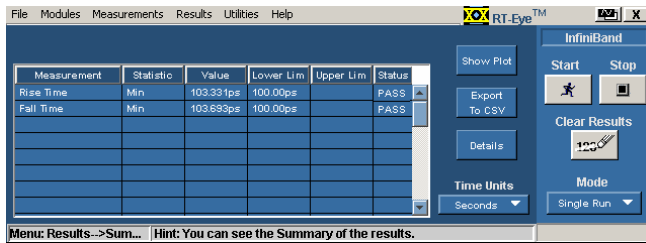

Figure 11 - Results of Transition Time Test

6.5 Driver Jitter Measurements

This test checks the Total Jitter from the driver using Tektronix real-time oscilloscope and RT-Eye software. This test checks the values of Total Jitter @ 10^{-12} BER and Deterministic Jitter and compares them against the specified limits. This test is defined for a single physical bit lane and must be repeated for each bit lane of each port on the DUT.

- TD Assertion covered: V2c6-007#14
- Total Jitter (J_T) and Deterministic Jitter (J_D) for the driver are defined in Vol. 2, Section 6.4, Table 16 Driver Characteristics. Jitter Eye Opening at different compliance points are defined in Table 5.
- Integrator List Test: Yes
- DUT Signaling: The test is performed on the TS1 ordered-sets captured by the oscilloscope while the DUT is in the Polling Active state described in section 3.3.
- Probing Configurations (from section 3.2):
 - Configuration A – Use TCA-SMA connectors with blocking capacitors.
 - Configuration B – Use P7350SMA probe (recommended).
- Connect via port breakout (Fujikura fixture in 4X case) to SMA inputs of probe configuration.
- Test Procedure is as follows:
 - Connect the SMA connectors from the Break-out Harness to Ch1 and Ch3 of the oscilloscope, or to Ch1 depending on the probe configuration used.
 - In the RT-Eye InfiniBand compliance module, select **Single Ended** as the Probe Type if using probe configuration (A) or **Differential** as the Probe Type if using probe configuration (B).
 - Select **Jitter @ BER** as the measurement.
 - Select the **Configure** button to access the Configuration menus.

- Select the **Source** tab and set up that menu as follows:
 - o Live as the Source Type.
 - o Select Ch1, Ch3 as the D+, D- option if using probe configuration (A), or select Ch1 if using probe configuration (B).
- Select the **Meas Params** tab and set up that menu as follows:
 - o TP6 (Transmitted signal at the cable side of the cable connector) as the Test Point.
 - o Stand By or Disable as the Differential Voltage Mode.
- Select the **Start** button.

The RT-Eye application gives measurement results along with a Pass /Fail indication of the measurement. See Figure 12.

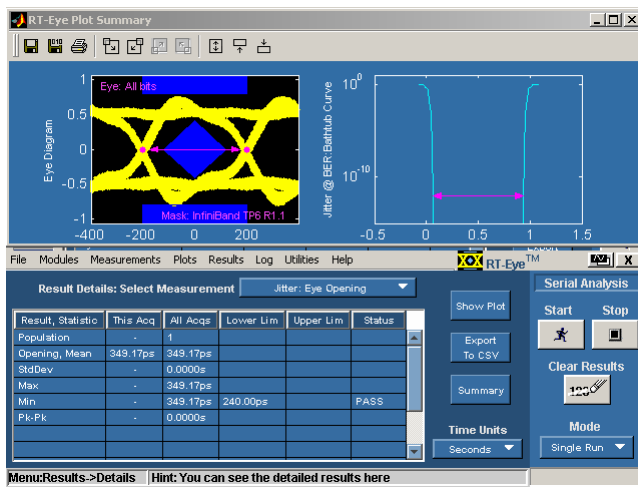

Figure 12 - Results of the Jitter Eye Opening @ 10⁻¹² BER Measurement

The results of the Total Jitter can be directly compared to Table 5, where:

$$\text{Total Jitter} + \text{Jitter Eye Opening} = 400\text{ps (1UI)}$$

Deterministic Jitter can be viewed by selecting it in the Measurement Details menu as shown in Figure 13.

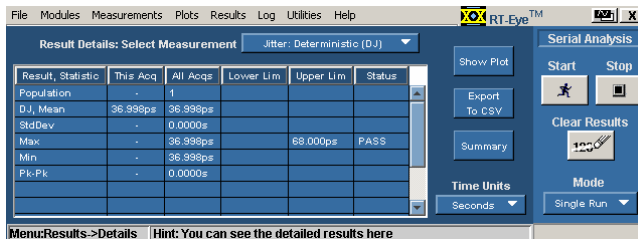

Figure 13 – Deterministic jitter results

6.6 Combining Driver Measurements

Using the RT-Eye InfiniBand Compliance Module (Opt. IBA), all measurements can be made in a single acquisition. Measurements that can be combined into a single acquisition are as follows:

- Eye Height/Eye Width
- Rise Time/Fall Time
- Unit Interval
- Jitter @ BER (RJ, DJ, TJ, and Jitter Eye Opening)
- Differential Voltage

7 InfiniBand Cable Measurements

7.1 Required Equipment

The following equipment is required to make the measurements in this document.

- TDS/CSA7404 or TDS6000 series oscilloscope equipped with TDS RT-Eye software (Opt. RTE) and InfiniBand Compliance Module (IBA).
- DTG5000 series or AWG710 signal generator
- Probes – Probing configuration is MOI specific. Refer to each MOI for proper probe configuration.
- InfiniBand cable test fixture (available from Gore; see Figure 14)

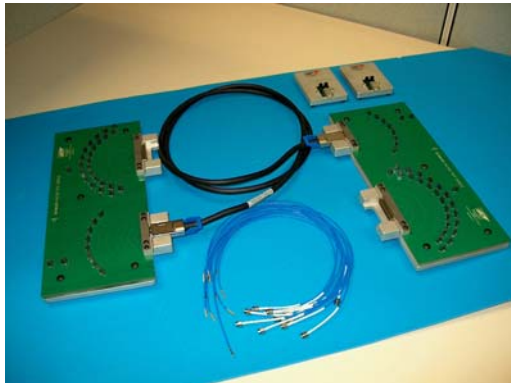

Figure 14 – Gore cable test fixture

7.2 Connecting to the Driver Under Test

The connection method to the Device Under test is shown in Figure 15.

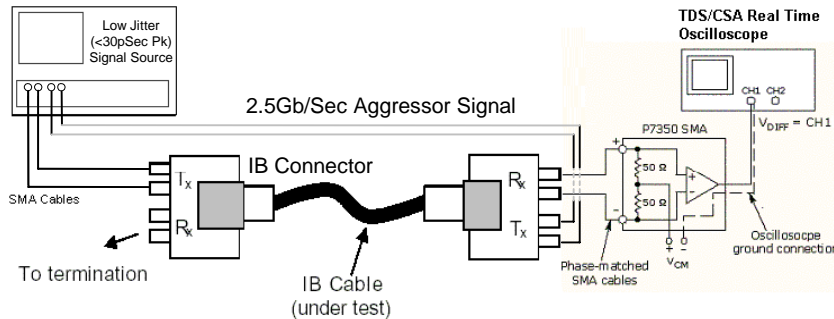

Figure 15 – Test Setup for IB cable testing

This test setup shows the use of a P7350SMA Differential Active probe with SMA inputs. Alternatively, each leg of the differential signal being tested can be connected to Ch1 and Ch3 of the oscilloscope and the measurement can be made in a pseudo-differential manner.

7.3 Configuring the Device Under Test (DUT) for Compliance Measurements

The signal generator is setup to transmit a repeating CJTPAT (Compliance Jitter Test Pattern).

7.4 Initial Oscilloscope Setup

After connecting to the DUT with the proper probing configuration for the test, press the DEFAULT front-panel button and then the AUTOSET button to display the serial data bit stream.

7.5 Running the RT-Eye Software

Go to File > Run Application > RT-Eye Serial Compliance and Analysis. The result should be similar to Figure 3.

7.6 Cable Connected Minimum Differential Voltage

This test checks cable assembly minimum differential voltage using Tektronix real-time oscilloscope and signal source. This test checks the minimum differential output voltage peak to peak of the Cable connector output signal. This test is defined for a single physical bit lane and must be repeated for each bit lane on the DUT(differential pair of cable).

- TD Assertion covered: V2c7-002#010
- Total Jitter (J_T) and Deterministic Jitter (J_D) for the driver are defined in Vol. 2, Section 6.4, Table 16 Driver Characteristics. Jitter Eye Opening at different compliance points are defined in Table 19 of the specification.

Notes:

- The test applies to the cable connector and to the cable assembly (ambiguously defined in the InfiniBand Architecture Specification 1.1)
- Required instruments:
 - Oscilloscope: TDS6604, TDS7404 or CSA7404 with SM option
 - Signal source: Arbitrary Waveform Generator AWG610, AWG710, or DTG5000 Series.
 - Differential Amplitude = 1 Vpp
 - V_{Cout} (peak-peak), minimum differential output Voltage (peak-peak) limits defined in Vol.2, Section 7.9.2, table Cable assembly electrical performance requirements.
 - V_{meas} is the minimum differential voltage measured at the center of the eye Diagram (Eye Height).
 - Test must be performed on each lane on the DUT.
- Integrator List Test: Yes
- DUT Signaling: The test is performed on the CJTPAT Ordered Sets captured by the oscilloscope. The voltage measurement is taken for 1 Vpp Fibre Channel CJTPAT stimulus for 1000 waveforms or equivalent.
- Probing Configurations (from section 3.2):
 - Configuration A – Use TCA-SMA connectors with blocking capacitors.
 - Configuration B – Use P7350SMA probe (recommended).
- Connect via port breakout (Fujikura fixture in 4X case) to SMA inputs of probe configuration.
- Test Procedure:
 - Connect SMA connectors from Break-out Harness to Ch1 and Ch3 of the oscilloscope, or to Ch1 depending on the probe configuration used.
 - In the RT-Eye InfiniBand compliance module, select Single Ended as the Probe Type if using probe configuration (A) or Differential as the Probe Type if using probe configuration (B).
 - Select Eye Width/Eye Height as the measurement.
 - Select the Configure button to access the Configuration menus.

- Select the Source tab and set up that menu as follows:
 - o Live as the Source Type.
 - o Select Ch1, Ch3 as the D+, D- if using probe configuration (A) or select Ch1 if using probe configuration (B).
- Select the **Start** button.

The RT-Eye application gives measurement results along with a Pass /Fail indication of the measurement. See Figure 16.



Figure 16 - Results of the Cable Connected Minimum Differential test

7.7 Combining Cable Measurements

Using the RT-Eye InfiniBand Compliance Module (Opt. IBA). All measurements can be made in a single acquisition. Measurements that can be combined into a single acquisition are as follows:

8 Giving a Device an ID

The InfiniBand Compliance Module provides a graphical user interface for entering a Device ID and Description. Data entered here will appear on the compliance report and is recommended for device tracking.

9 Creating a Compliance Report

To create a compliance report, select **Utilities > Reports**. The Report Generator utility can create a complete report of the compliance test.

10 Appendix A – Measurement Algorithms

This section is under development.

