

DPODSPT
DisplayPort Source Compliance Test Automation
Software for DPO70000 and DSA70000 Series Oscilloscopes
Instructions



077-0186-01

Tektronix

DPODSPT
DisplayPort Source Compliance Test Automation
Software for DPO70000 and DSA70000 Series Oscilloscopes
Instructions

Revision A

www.tektronix.com

077-0186-01

Tektronix

Copyright © Tektronix. All rights reserved. Licensed software products are owned by Tektronix or its subsidiaries or suppliers, and are protected by national copyright laws and international treaty provisions.

Tektronix products are covered by U.S. and foreign patents, issued and pending. Information in this publication supersedes that in all previously published material. Specifications and price change privileges reserved.

TEKTRONIX and TEK are registered trademarks of Tektronix, Inc.

DPODSPT DisplayPort Transmitter Compliance Test Automation Software Version 1.2

Acknowledgements: iTextSharp Library Copyright © 1997-2007 by Bruno Lowagie. The iTextSharp Library is freely available at <http://itextsharp.sourceforge.net>

Contacting Tektronix

Tektronix, Inc.
14200 SW Karl Braun Drive
P.O. Box 500
Beaverton, OR 97077
USA

For product information, sales, service, and technical support:

- In North America, call 1-800-833-9200.
- Worldwide, visit www.tektronix.com to find contacts in your area.



Table of Contents

Prerequisites 1

Instrument Connection 1

About the Application Software 2

Compliance Testing 13

Oscilloscope Probe or Cable Calibration 14

Prerequisites

- Tektronix DPO70804/B, DSA70804/B, DPO71254/B, DSA71254/B, DPO71604/B, DSA71604/B, DPO72004/B, or DSA72004/B oscilloscope.
- A minimum of 20 minutes warm-up time for the oscilloscope.
- Run SPC (Signal Path Compensation) to assure accuracy of the acquisition system. Remove all probes from the oscilloscope before running SPC.
- Perform deskew to compensate for skew between measurement channels. Note that it is critical to select **Off** for the **Display Only** control in the deskew setup window to include the deskew data with saved waveforms.
- Terminate all unused connections on the DisplayPort test fixture with 50 Ω terminators.
- Up-to-date versions of the TekScope and DPOJET applications are required to ensure best operation of this software. The readme file for DPODSPT has information on the required versions. Ensure that these versions (or later) are installed on your oscilloscope; update them from www.tektronix.com if necessary.
- 10 GB available hard drive space recommended.

NOTE. *A secondary monitor is recommended (but not required) to display the oscilloscope application and DisplayPort application simultaneously on separate monitors, for ease of use.*

Instrument Connection

The DPODSPT software can perform testing on a DisplayPort source device-under-test (DUT) or on stored waveforms. Direct connection to the DUT requires at least one skew-matched pair of SMA cables, two or more TCA-SMA connectors, and the DisplayPort test fixture. The test fixture is available from Tektronix as part number ET-DP-TPA-STX.

Differential probes P7380SMA or P7313SMA can also be used, and include their own phase-matched SMA cable sets. If probes are not used, phase-matched SMA cable sets are available from Tektronix as part number 174-4944-01.

Connect oscilloscope channels CH1 and CH2 to the DisplayPort lane to be tested. You can optionally connect oscilloscope channels CH3 and CH4 to another DisplayPort lane for inter-pair lane skew testing. Any unused connections on the DisplayPort test fixture must be terminated with 50 Ω terminators.

Tx Test Solution - Hardware

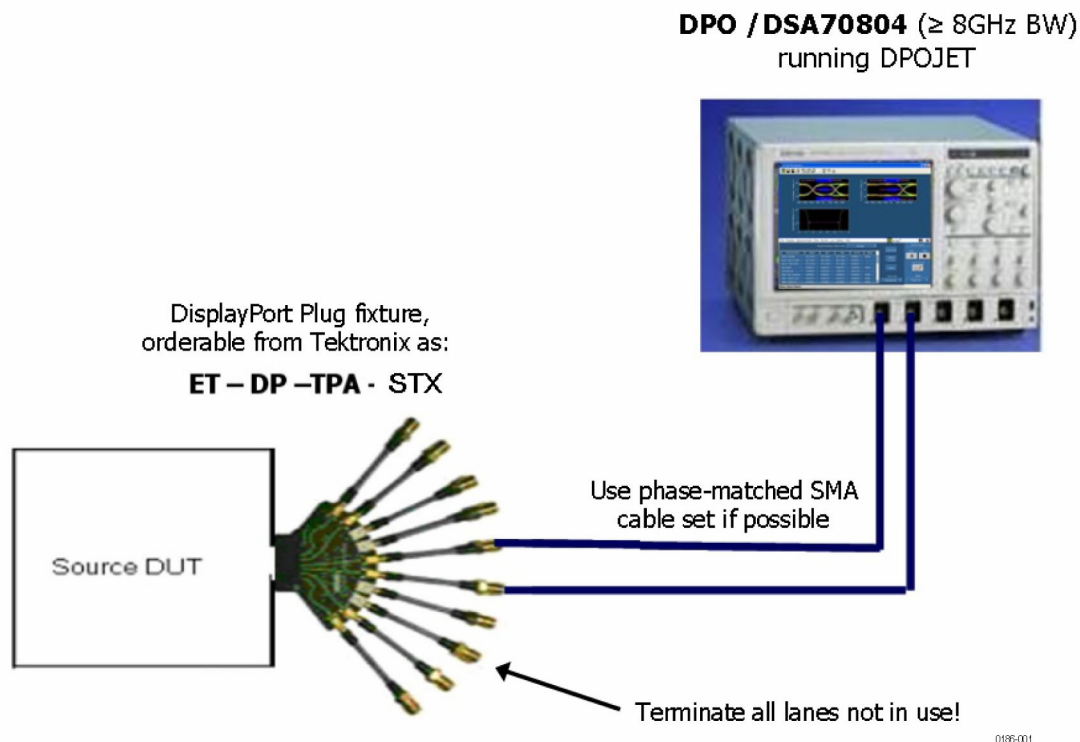

Figure 1: Transmitter test setup for compliance test using matched SMA Cable set

About the Application Software

The DPODSPT application software uses five tabs to set up and run the DisplayPort source testing.

Configure Tab

The Configure tab shows the test setup controls. It shows information about the connection between the oscilloscope and the DUT, shows which lane(s) are assigned to which oscilloscope channels, and sets the signal types available for the compliance tests. Selections in the Supported Signal Types fields determines the list of available and/or applicable tests on the Select tab.

The Configure tab also lets you select saved waveform files to test, in place of a connected DUT. Selecting the **Verbose Logging /Reporting** check box at the bottom of the screen generates a detailed log file and adds additional screen shot information to the test report.

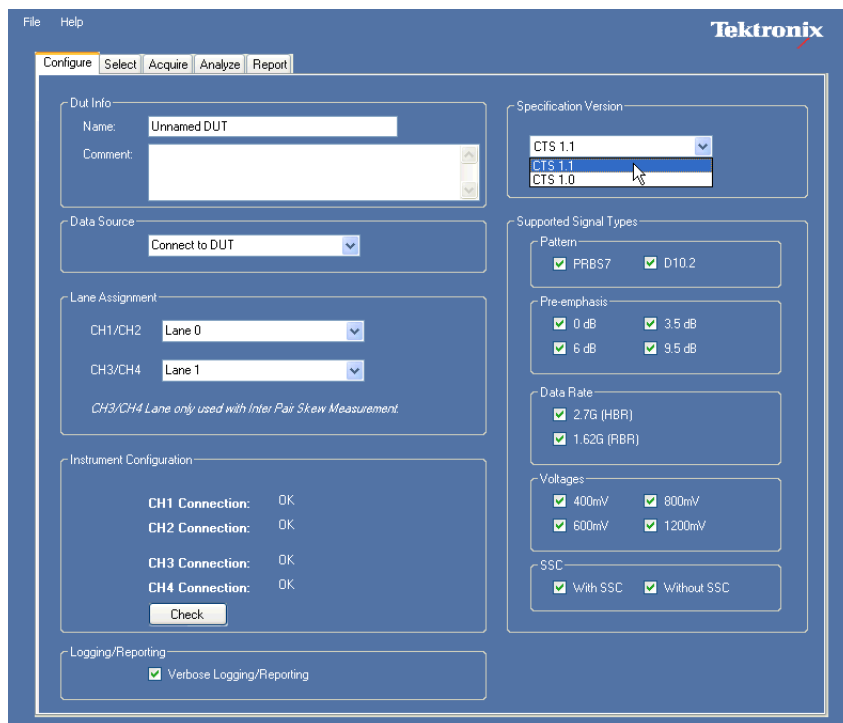

Figure 2: The Configure tab

Select the DisplayPort test version from the list in the **Specification Version** pane.

Use the Supported Signal Types check boxes to set which type of signals are available for compliance testing. For example, selecting the 0dB and 3.5dB check boxes in the Preemphasis group lets the application know that the DUT will generate signals with these parameters and to make these test signals available in the test suite (as listed in the Select tab). Similarly, if the DUT does not support signals with SSC, you would clear the With SSC check box to bypass tests that require SSC.

Use the Configure tab to enter a DUT name and test comments. The application creates a data file folder using the text in the DUT Name field for the folder name. The DUT name and comments are saved in the test report, along with waveforms and other data files from the test run.

NOTE. *If you use the same DUT name for successive test runs, the previous test result data is overwritten.*

Select Tab The Select tab lists the available tests.

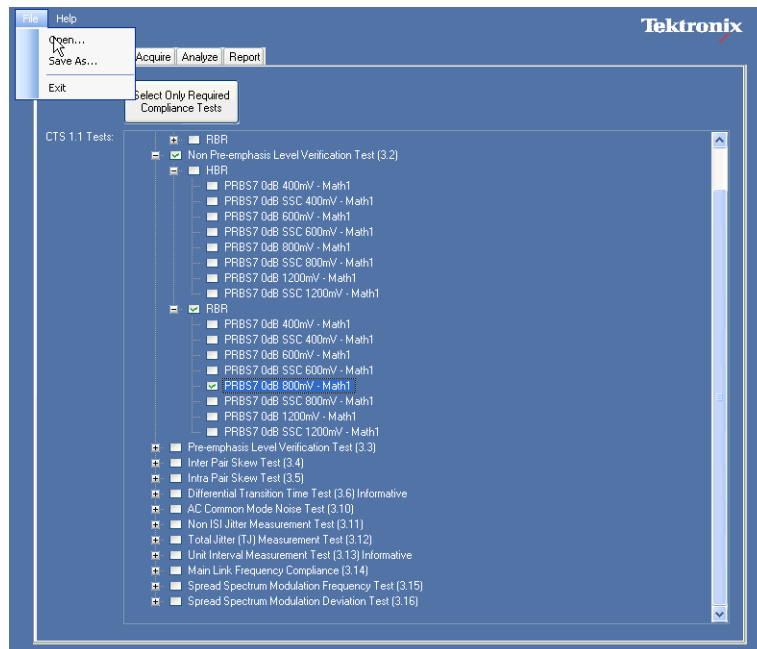

Figure 3: The Select tab

You can expand the tree of tests to select tests for a specific type of signal (such as PRBS7 signal of 400 mV amplitude and with 3.5 dB of pre-emphasis). You can select or deselect all the tests of a branch by selecting or clearing the higher-level check box. When selected tests require additional tests that are not already selected, the application automatically selects the required tests.

The available selections can include tests that are not required for compliance. Click the **Select Only Required Compliance Tests** button to limit the measurement set to just those tests required to meet compliance requirements.

To save a test selection, select **File > Save As**. To recall a previously saved test selection, select **File > Open**.

NOTE. *Some of the signals can support multiple tests. The list of signals to be acquired does not show duplication of signals when used for multiple measurements.*

When you start the acquisition by clicking the Acquire button, a pop-up message box, as shown in figure 5, displays the signal being acquired. Attributes of the signal to be acquired are displayed.

There are four buttons in the Acquire tab:

Abort Tests. Click this button to abort the entire test session. No acquisition takes place.

Skip. Click this button to stop acquiring the current signal and move (skip) to the next signal type in the list. Measurements that depend on the skipped signal type will not be performed.

Check Signal. Click this button to manually validate the signal (show the required and actual attributes of the signal acquired). If they do not match, the application displays an alert message.

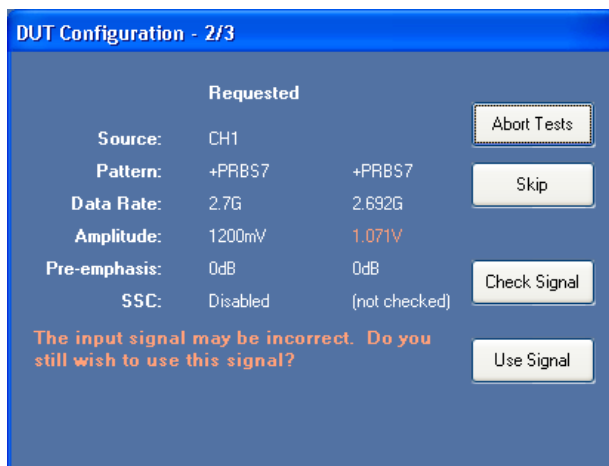

Figure 5: Acquire tab, Check Signal results

Use Signal. Click this button to acquire and use the acquired signal for the test. In this case, signal validation takes place by default. If there is a mismatch between the required and acquired signal attributes, a warning screen allows you to change the DUT output signal or use the existing signal.

NOTE. *Validation of the signal acquired against what is required happens by default for all the acquisitions. The Check Signal button is provided to manually perform and display a signal validation.*

Acquire Tab (if using DP-AUX Control)

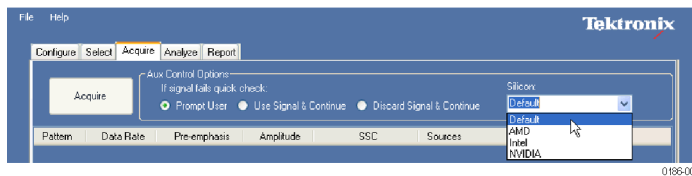

Figure 6: Acquire tab, DP-AUX connected

When the Tektronix DP-AUX DisplayPort AUX Control is used, the Acquire tab displays AUX Control Options. You can select which actions occur with signals that do not pass the signal quick check:

- **Use Signal & Continue:** Uses the signal and continues without prompting
- **Prompt User:** Prompts you with each failed signal
- **Discard Signal & Continue:** Discards the signal and continues without prompting (continues with accepted signals)

There is also a Silicon selection, the contents of which are determined by the connected DP-AUX Control board. DisplayPort Tx reads which Silicon the DP-AUX Control board supports and that list is used to populate this drop down list.

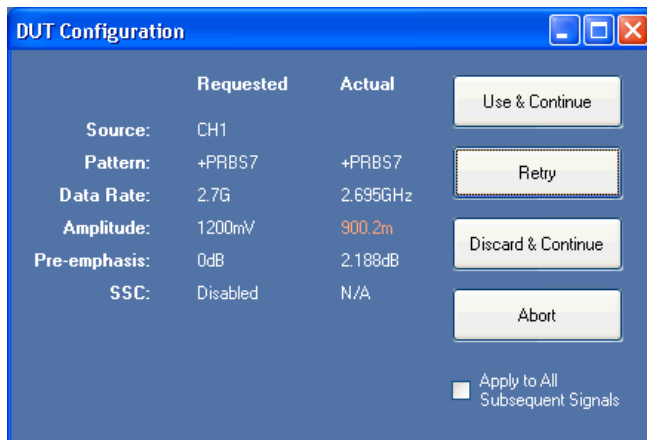

Figure 7: DUT Configuration dialog box

The DUT Configuration dialog box also changes when a DP-AUX Control is being used. If you chose **Prompt the user** from the Aux Control Options area on the Acquire tab, and the DUT Configuration dialog is displayed, then you can change your previous selection by checking the box for **Apply to All Subsequent Signals** and selecting either **Use & Continue** or **Discard & Continue** buttons.

Acquire Tab (if using previously-stored waveforms)

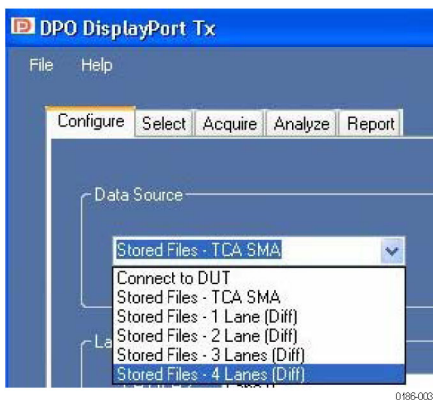

Figure 8: Stored Files drop-down menu

If you selected the data source as Stored Files rather than Connect to DUT in the Configure tab, the Acquire tab shows a different set of choices. Instead of the Acquire button, the Acquire tab displays two buttons: Load Individual Files and Load All From Directory.

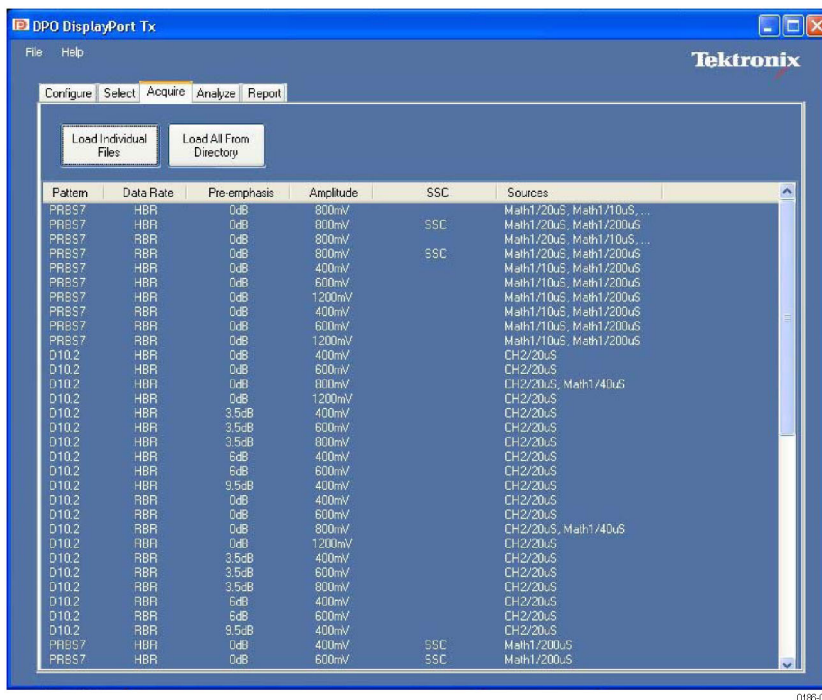

Figure 9: Load Stored Files opening screen

Click the Load Individual Files button to open a pop-up window that shows a description of the first signal type needed. Press the Read Waveform button and then navigate to and select the file to load. The waveform file must meet the signal conditions for the listed signal type.

If a large collection of waveform files have been saved, the **Load All From Directory** button can help automate and speed testing. Clicking this button opens a dialog box with which you navigate to and select the folder where a collection of waveform files are stored. The application then attempts to perform all the selected tests using the waveform files in selected folder.

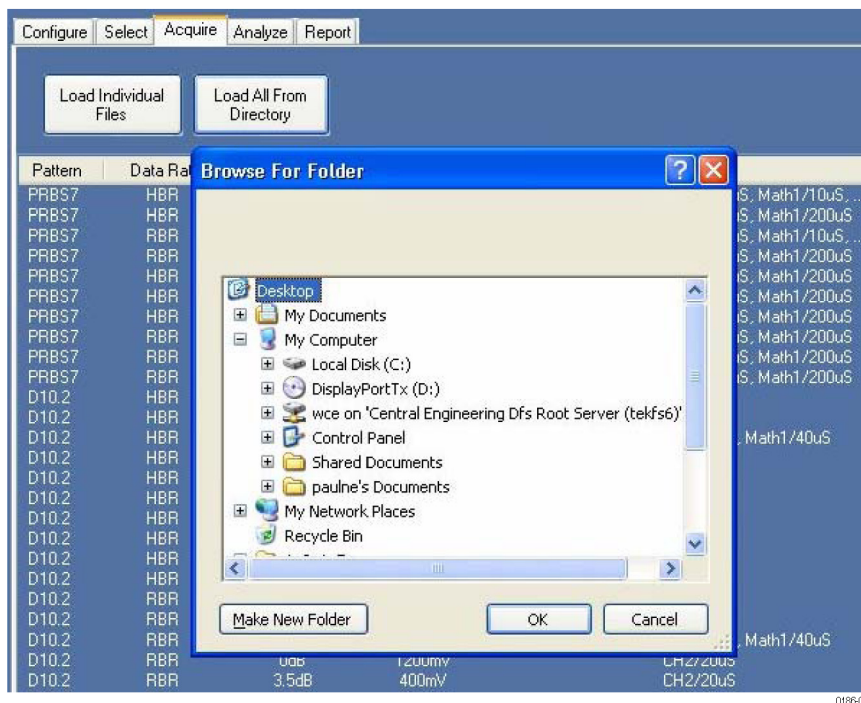

Figure 11: Load All From Directory dialog box

Analyze Tab

The application automatically opens the Analyze tab when it has completed acquiring signals (as set in the Acquire tab). This tab displays the sequence of tests to automatically execute after all the necessary signals are acquired, as well as a test progress indicator. You can automatically save the test sequence steps to a log file by checking the **Verbose Logging /Reporting** check box on the **Configure** tab.

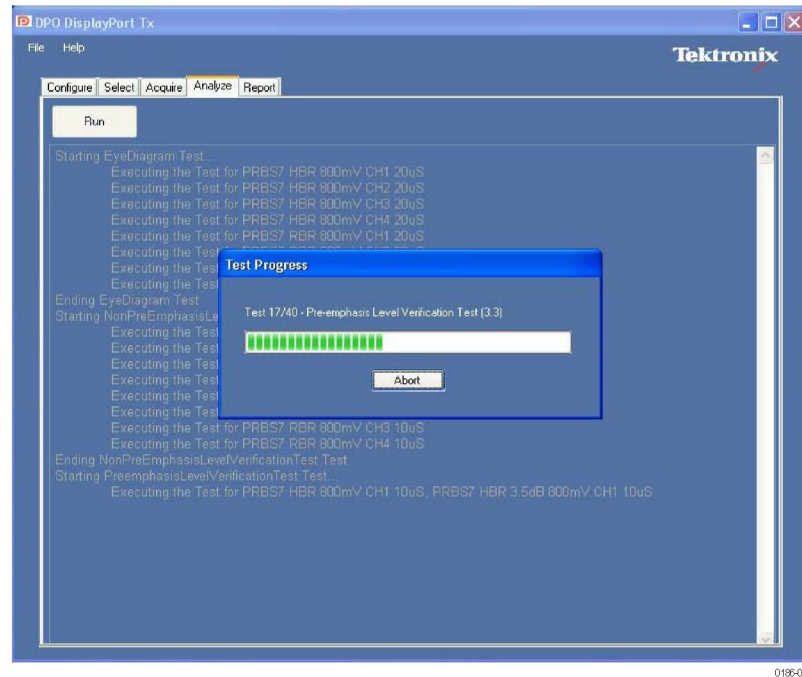

Figure 12: Analyze screen showing test progress indicator

NOTE. Tests are automatically executed at the end of the acquisition process. The **Run** button lets you rerun the tests with already acquired signals.

Report Tab

The application automatically opens the Report tab when it has completed testing signals in the Analyze tab. The Report tab displays the results of the tests executed. The report data is saved in the data file folder associated with this test session, as both a PDF and .csv format file.

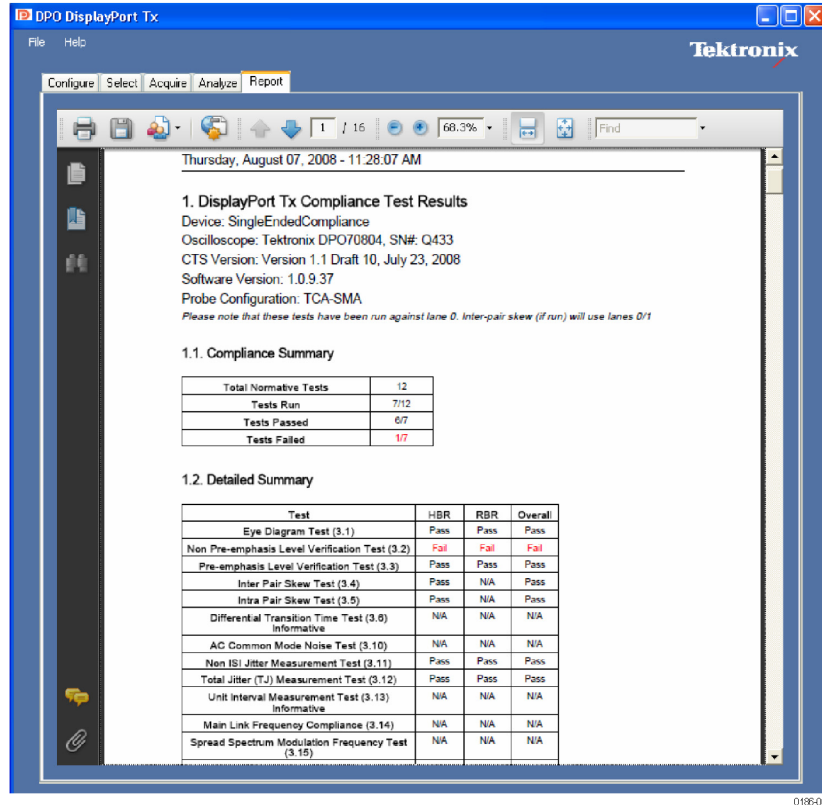

Figure 13: The Report tab.

The PDF report includes:

- Date and time of the test session (from the system clock)
- The version of the DPODSPT Software
- The version of the Compliance test specification (CTS) to which this test session conforms
- Device / DUT name and User comments (as entered in the Select Tab)
- Compliance test summary
- Detailed test summary
- Individual test results with necessary graphic(s) / plot(s)

NOTE. *The PDF report, .csv report, log file and waveforms used for the tests are saved in the folder specified by the DUT name (c:\Program Files\TekApplications\DPODSPT\DUT-Name-Field-Text).*

Compliance Testing

1. Set up the application, test equipment, and DUT. (See page 1, *Instrument Connection.*) (See page 1, *Prerequisites.*)
2. Start the **DPODSPT** application (from the Analyze menu in the oscilloscope main control menu). The application will automatically detect what is connected to each oscilloscope input channel - either a differential probe or TCA-SMA adapter. The “Lane Assignment” section of the Configure tab will show the input configuration.
3. If using TCA-SMA connections, configure the lane assignment for the oscilloscope channels.
4. In the **Configure** tab:
 - Set the parameters for the DUT signals.
 - Enter the DUT name. The DUT name is assigned to the folder where all the waveforms (used for the tests), log file, and final test report (PDF file) are saved.
 - Enter a comment in the **User Comment** field (optional). The comment text is added to the PDF test report.
 - Select the **Verbose Logging/Reporting** check box to automatically log the sequence of operation/test execution.
5. In the **Select** tab:
 - Select the tests to run.
 - Optionally save this test setup or recall a saved setup.
6. In the **Acquire** tab:
 - Click the **Acquire** button to start acquiring signal(s). The signals are validated against the signals required for running the specified tests.
 - Click the **Use Signal** button on the **DUT Configuration** dialog box when you find the signal acquired is correct.
 - If the signal acquired is not what is required for the test, recheck your DUT settings and connections, and validate the new signal by clicking the **Check Signal** button. Once you have the correct signal, click the **Use Signal** button to continue to the next acquisition. If signal problems cannot be resolved, click the **Skip** button.

- Keep changing the DUT settings and connections to acquire appropriate test signals as prompted by the **Acquisition Status** dialog box.
 - If you are using the optional Tektronix DP-AUX Control device, specify what the software should do with "check signal" failures.
7. Once all the signals are acquired, the application will automatically start running the tests. If tests do not automatically start running, click the **Run** button in the **Analyze** tab. Test execution progress is shown in a status window. Once the tests are executed, the report is shown in the **Report** tab. The waveforms and report are stored in the specified folder.

Oscilloscope Probe or Cable Calibration

Before beginning any test or data acquisition, you must warm up the oscilloscope, run a signal path compensation (SPC) operation, and deskew the test cables or probes you are using for the DUT test. Signal Path Compensation compensates the signal pathways for gain and offset errors. Cable deskew compensates for timing differences between any two cables or probes. This section includes the procedure for running a SPC and deskewing the cables/probes.

The DSA/DPO70000 series oscilloscope must be calibrated (SPC and deskew) manually after a minimum 20-minute warm-up period or whenever a new measurement session is going to begin.

These calibrations are not permanent. It is recommended that you perform a signal path compensation once a week and whenever the ambient temperature of the oscilloscope has changed by more than 5 °C. It is recommended that you perform a cable deskew before starting any new measurement session using the oscilloscope and cables.

Signal Path Compensation

Use the following procedure to run the signal path compensation (SPC) utility:

1. Disconnect all input cables to the oscilloscope channels.
2. Install Tektronix TCA-SMA (or TCA-292MM) input adapters in all four channels, and make sure that nothing is connected to the SMA inputs. The adapters prevent transient voltages from leaking into the input amplifiers and analog to digital converters that could adversely affect the quality of the calibration routine.
3. Select **Utilities > Instrument Calibration** in the DPO/DSA70000 application.
4. Click the **Calibrate** button. It takes about 10 minutes to get the SPC calibration result. The final status should be **Pass**.

Cable Deskewing

Use the following procedure to compensate for timing differences between SMA cables and input channels. Perform this procedure on each pair of cables you will use for DUT testing.

1. Connect TCA-SMA TekConnect adapters to all four channels of the oscilloscope.
2. Press the **Default Setup** front-panel button.
3. Connect the SMA cables to channels Ch1, Ch2, Ch3 and Ch4. Use a torque-wrench to tighten the connections to 7-10 in lbs.
4. Select the **Ch1** and **Ch2** front panel channel button to activate those channels.
5. Deselect channels **Ch3** and **Ch4** (verify that they are not active/selected).
6. Connect a power splitter to the **Fast Edge** output connector.

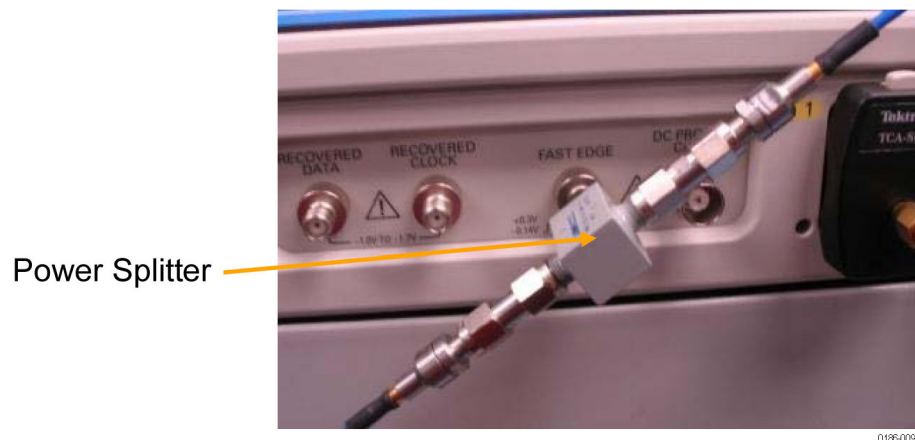

Figure 14: Cable deskew connections

7. Connect the cables from **Ch1** and **Ch2** to the power splitter outputs.
8. Press the **Autoset** front-panel button. Click **OK** on the confirmation window.
9. Adjust the **Vertical Scale** (increase it without any clipping) and **Position** controls for each channel so that the signals overlap and are centered on the display.
10. Select **Horiz/Acq > Horizontal/Acquisition Setup** from the oscilloscope menu bar.
11. Click the **Acquisition** tab.
12. Select **Average** acquisition mode.
13. Set the **# of Wfms** field to **16**.

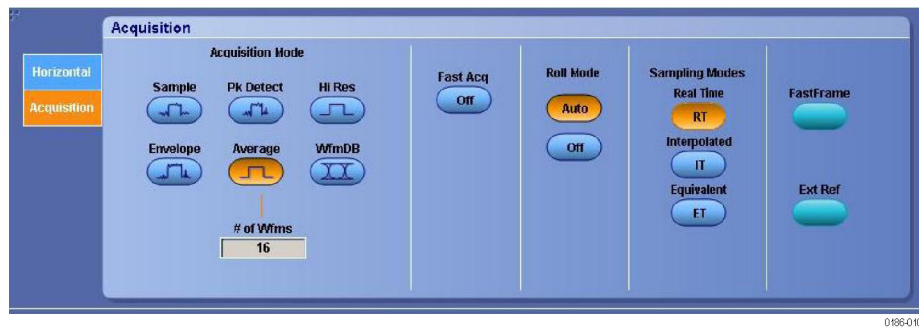

Figure 15: Setting Average mode

14. Adjust the **Horizontal Position** so that a rising edge is triggered at the center of the display.
15. Adjust the horizontal **Scale** (Lower time/pt) so that the differences in the channel delays are clearly visible. (See Figure 16.)

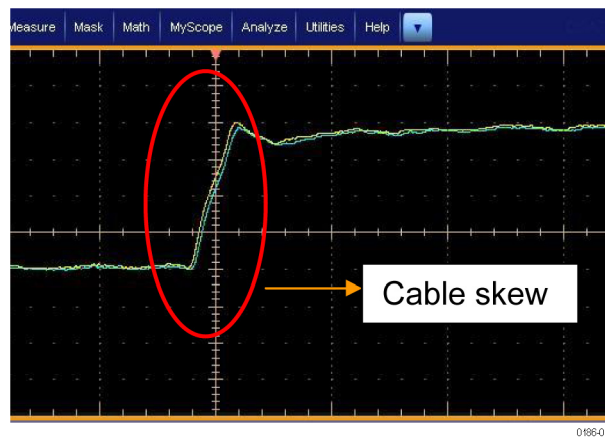

Figure 16: Visible cable skew

16. Adjust the horizontal **Position** again so that the first rising edge is exactly at the center of the display. The short length (electrical length) cable is connected to this channel.
17. Select **Vertical > Deskew** from the oscilloscope menu to open the Deskew control window.
18. Select **Ch2**.
19. Adjust the deskew time for Ch2 so that its signal aligns with Ch1.



Figure 17: Cable skew adjusted

20. Remove the cable attached to **Ch2** from the power splitter. Keep the other end of the cable attached to the oscilloscope input.
21. Repeat steps 3 to 20, connecting the cable from **Ch3** to the deskew attachment. Make sure to deselect Ch2 and select Ch3.
22. Repeat steps 3 to 20, connecting the cable from **Ch4** to the deskew attachment. Make sure to deselect Ch3 and select Ch4.
23. The deskew procedure is complete when Ch2, Ch3, and Ch4 have all been deskewed to Ch1. Take care to leave the cable and oscilloscope connections undisturbed for the duration of testing on the DisplayPort source device.

NOTE. If you are using differential probes instead of direct SMA cable connections to the oscilloscope, perform the procedure with the cables connected to the + input side of each probe.