

**MSO70000/C, DSA70000B/C,  
DPO70000B/C, DPO7000,  
MSO5000, and DPO5000  
Series Oscilloscopes  
Specifications and Performance Verification  
Technical Reference**



077-0063-05

**Tektronix**



**MSO70000/C, DSA70000B/C,  
DPO70000B/C, DPO7000,  
MSO5000, and DPO5000  
Series Oscilloscopes  
Specifications and Performance Verification  
Technical Reference**

**Revision A**

This document applies to firmware version 5.2.0 and above.

**Warning**

The servicing instructions are for use by qualified personnel only. To avoid personal injury, do not perform any servicing unless you are qualified to do so. Refer to all safety summaries prior to performing service.

[www.tektronix.com](http://www.tektronix.com)

077-0063-05

**Tektronix**

Copyright © Tektronix. All rights reserved. Licensed software products are owned by Tektronix or its subsidiaries or suppliers, and are protected by national copyright laws and international treaty provisions.

Tektronix products are covered by U.S. and foreign patents, issued and pending. Information in this publication supersedes that in all previously published material. Specifications and price change privileges reserved.

TEKTRONIX and TEK are registered trademarks of Tektronix, Inc.

Pinpoint, TekLink, and RT-Eye are registered trademarks of Tektronix, Inc.

## **Contacting Tektronix**

Tektronix, Inc.  
14150 SW Karl Braun Drive  
P.O. Box 500  
Beaverton, OR 97077  
USA

For product information, sales, service, and technical support:

- In North America, call 1-800-833-9200.
- Worldwide, visit [www.tektronix.com](http://www.tektronix.com) to find contacts in your area.

## Warranty

Tektronix warrants that this product will be free from defects in materials and workmanship for a period of one (1) year from the date of shipment. If any such product proves defective during this warranty period, Tektronix, at its option, either will repair the defective product without charge for parts and labor, or will provide a replacement in exchange for the defective product. Parts, modules and replacement products used by Tektronix for warranty work may be new or reconditioned to like new performance. All replaced parts, modules and products become the property of Tektronix.

In order to obtain service under this warranty, Customer must notify Tektronix of the defect before the expiration of the warranty period and make suitable arrangements for the performance of service. Customer shall be responsible for packaging and shipping the defective product to the service center designated by Tektronix, with shipping charges prepaid. Tektronix shall pay for the return of the product to Customer if the shipment is to a location within the country in which the Tektronix service center is located. Customer shall be responsible for paying all shipping charges, duties, taxes, and any other charges for products returned to any other locations.

This warranty shall not apply to any defect, failure or damage caused by improper use or improper or inadequate maintenance and care. Tektronix shall not be obligated to furnish service under this warranty a) to repair damage resulting from attempts by personnel other than Tektronix representatives to install, repair or service the product; b) to repair damage resulting from improper use or connection to incompatible equipment; c) to repair any damage or malfunction caused by the use of non-Tektronix supplies; or d) to service a product that has been modified or integrated with other products when the effect of such modification or integration increases the time or difficulty of servicing the product.

THIS WARRANTY IS GIVEN BY TEKTRONIX WITH RESPECT TO THE PRODUCT IN LIEU OF ANY OTHER WARRANTIES, EXPRESS OR IMPLIED. TEKTRONIX AND ITS VENDORS DISCLAIM ANY IMPLIED WARRANTIES OF MERCHANTABILITY OR FITNESS FOR A PARTICULAR PURPOSE. TEKTRONIX' RESPONSIBILITY TO REPAIR OR REPLACE DEFECTIVE PRODUCTS IS THE SOLE AND EXCLUSIVE REMEDY PROVIDED TO THE CUSTOMER FOR BREACH OF THIS WARRANTY. TEKTRONIX AND ITS VENDORS WILL NOT BE LIABLE FOR ANY INDIRECT, SPECIAL, INCIDENTAL, OR CONSEQUENTIAL DAMAGES IRRESPECTIVE OF WHETHER TEKTRONIX OR THE VENDOR HAS ADVANCE NOTICE OF THE POSSIBILITY OF SUCH DAMAGES.

[W2 – 15AUG04]



---

# Table of Contents

General Safety Summary .....	vi
<b>Specifications (MSO70000/C Series, DSA/DPO70000B/C Series, and DPO7000 Series)</b>	
Specifications (MSO70000/C Series, DSA/DPO70000B/C Series, and DPO7000 Series) .....	1-1
<b>Specifications (MSO/DPO5000 Series)</b>	
Specifications (MSO/DPO5000 Series) .....	2-1
<b>Performance Verification (MSO70000/C Series, DSA/DPO70000B/C Series, and DPO7000 Series)</b>	
Performance Verification (MSO70000/C Series, DSA/DPO70000B/C Series, and DPO7000 Series) .	3-1
Conventions .....	3-2
Brief Procedures (MSO70000/C Series, DSA/DPO70000B/C Series, and DPO7000 Series) .....	3-4
Self Tests .....	3-4
Functional Tests .....	3-5
Verify All Analog Input Channels .....	3-6
Verify the Time Base .....	3-9
Verify the A (Main) and B (Delayed) Trigger Systems .....	3-12
Verify the File System .....	3-13
Verify the Digital Channels (MSO70000 Series Only) .....	3-15
Performance Tests (MSO70000/C Series, DSA/DPO70000B/C Series, and DPO7000 Series) .....	3-18
Prerequisites .....	3-18
Equipment Required .....	3-19
Test Record .....	3-22
Signal Acquisition System Checks .....	3-42
Check DC Voltage Measurement Accuracy .....	3-42
Check DC Gain Accuracy, $\geq 4$ GHz models .....	3-48
Check Offset Accuracy $\geq 4$ GHz models .....	3-56
Check Analog Bandwidth, $< 3.5$ GHz models .....	3-60
Check Channel Bandwidth, $\geq 3.5$ GHz models .....	3-65
Check Input Resistance, $\geq 4$ GHz models .....	3-71
Time Base System Checks .....	3-73
Check Timebase and Delay Time Accuracy and Reference .....	3-73
Check Delta Time Measurement Accuracy, $< 4$ GHz models .....	3-76
Check Delta Time Measurement Accuracy, $\geq 4$ GHz models .....	3-80

Trigger System Checks.....	3-85
Check Time Qualified Trigger Accuracy.....	3-85
Check Sensitivity, Edge Trigger, DC Coupled.....	3-89
Output Signal Checks .....	3-98
Check Aux Trigger Out .....	3-98
Check Probe Compensation or Fast Edge Output .....	3-100
Serial Trigger Checks (Optional on Some Models).....	3-104
Check Serial Trigger Baud Rate Limits .....	3-104
Check Serial Trigger Clock Recovery Range.....	3-110
Sine Wave Generator Leveling Procedure .....	3-114

## Performance Verification (MSO/DPO5000 Series)

Performance Verification (MSO/DPO5000 Series).....	4-1
Test Record.....	4-2
Performance Tests (MSO/DPO5000 Series).....	4-25
Prerequisites.....	4-25
Self Test.....	4-26
Check Input Impedance (Resistance).....	4-27
Check DC Balance.....	4-28
Check DC Gain Accuracy .....	4-30
Check Offset Accuracy.....	4-33
Check Analog Bandwidth.....	4-35
Check Random Noise, Sample Acquisition Mode .....	4-38
Check Sample Rate and Delay Time Accuracy .....	4-40
Check Delta Time Measurement Accuracy .....	4-42
Check Digital Threshold Accuracy (MSO5000 only) .....	4-44
Check Trigger Out.....	4-47



---

# List of Figures

Figure 3-1: Toolbar and menu bar (< 4 GHz models shown).....	3-3
Figure 3-2: Universal test hookup for functional tests - Ch 1 shown.....	3-6
Figure 3-3: Channel button location.....	3-7
Figure 3-4: Setup for time base test.....	3-10
Figure 3-5: Setup for trigger test.....	3-12
Figure 3-6: Setup for the file system test.....	3-14
Figure 3-7: Setup for the digital channels test.....	3-15
Figure 3-8: Initial test hookup.....	3-43
Figure 3-9: Measurement of DC accuracy at maximum offset and position.....	3-46
Figure 3-10: Measurement of DC gain accuracy.....	3-55
Figure 3-11: Initial test hookup.....	3-56
Figure 3-12: Measurement of offset accuracy.....	3-58
Figure 3-13: Initial test hookup.....	3-61
Figure 3-14: Measurement of analog bandwidth.....	3-63
Figure 3-15: Initial test hookup.....	3-66
Figure 3-16: Measurement of analog bandwidth.....	3-69
Figure 3-17: Initial test hookup.....	3-71
Figure 3-18: Initial test hookup.....	3-73
Figure 3-19: Initial test hookup.....	3-74
Figure 3-20: Final test hookup.....	3-75
Figure 3-21: Delta time accuracy test hookup.....	3-76
Figure 3-22: Delta time accuracy test hookup.....	3-80
Figure 3-23: Initial test hookup.....	3-85
Figure 3-24: Measurement of time accuracy for pulse and glitch triggering.....	3-86
Figure 3-25: Initial test hookup.....	3-90
Figure 3-26: Measurement of trigger sensitivity - 50 MHz results shown.....	3-92
Figure 3-27: Initial test hookup.....	3-98
Figure 3-28: Measurement of trigger out limits.....	3-99
Figure 3-29: Initial test hookup.....	3-100
Figure 3-30: Measurement of probe compensator frequency.....	3-101
Figure 3-31: Subsequent test hookup.....	3-102
Figure 3-32: Measurement of probe compensator amplitude.....	3-102
Figure 3-33: Initial test hookup.....	3-104
Figure 3-34: Isolated 0 triggering.....	3-107
Figure 3-35: Isolated 1 triggering.....	3-109
Figure 3-36: Initial test hookup.....	3-110
Figure 3-37: Clock recovery.....	3-113
Figure 3-38: Sine wave generator leveling equipment setup.....	3-114
Figure 3-39: Equipment setup for maximum amplitude.....	3-116

## List of Tables

Table 1-1: Channel input and vertical specifications, all MSO70000/C, DSA/DPO70000B/C, and DPO7000 Series models .....	1-1
Table 1-2: Horizontal and acquisition system specifications, all MSO70000/C, DSA/DPO70000B/C, and DPO7000 Series models .....	1-34
Table 1-3: Trigger specifications, all MSO70000/C, DSA/DPO70000B/C, and DPO7000 Series models.....	1-41
Table 1-4: Serial Trigger specifications, all MSO70000/C and DSA/DPO70000B/C Series models (optional on DPO7000 models) .....	1-48
Table 1-5: Digital acquisition specifications (MSO70000/C Series) .....	1-51
Table 1-6: Input/output port specifications, all MSO70000/C, DSA/DPO70000B/C, and DPO7000 Series models.....	1-52
Table 1-7: Data storage specifications, all MSO70000/C, DSA/DPO70000B/C, and DPO7000 Series models.....	1-56
Table 1-8: Power source specification, all MSO70000/C, DSA/DPO70000B/C, and DPO7000 Series models.....	1-56
Table 1-9: Mechanical specifications, all MSO70000/C, DSA/DPO70000B/C, and DPO7000 Series models.....	1-57
Table 1-10: Environmental specifications, all MSO70000/C, DSA/DPO70000B/C, and DPO7000 Series models.....	1-58
Table 2-1: Analog channel input and vertical specification.....	2-1
Table 2-2: Horizontal and acquisition system specifications .....	2-9
Table 2-3: Trigger specifications.....	2-11
Table 2-4: Digital acquisition specifications, MSO5000 Series .....	2-15
Table 2-5: P6616 Digital Probe specifications .....	2-15
Table 2-6: Display specifications .....	2-16
Table 2-7: Input/Output port specifications.....	2-16
Table 2-8: Data storage specifications.....	2-17
Table 2-9: Power source specifications .....	2-17
Table 2-10: Environmental specifications .....	2-17
Table 2-11: Mechanical specifications .....	2-18
Table 3-1: Vertical settings .....	3-8
Table 3-2: Test equipment .....	3-19
Table 3-3: Test record.....	3-23
Table 3-4: DC voltage measurement accuracy .....	3-44
Table 3-5: Gain accuracy .....	3-49
Table 3-6: Offset accuracy.....	3-57
Table 3-7: Analog bandwidth, < 3.5 GHz models .....	3-62
Table 3-8: Channel bandwidth $\geq 4$ GHz models.....	3-67
Table 3-9: Channel bandwidth 3.5 GHz model .....	3-67

---

Table 3-10: Delta time measurement settings .....	3-78
Table 3-11: Delta time measurement settings .....	3-81
Table 3-12: Trigger settings for $\geq 4$ GHz models .....	3-95
Table 3-13: Serial pattern data .....	3-105
Table 3-14: Word recognizer data .....	3-108
Table 3-15: Clock recovery input frequencies and baud rates .....	3-112
Table 4-1: Required equipment .....	4-1
Table 4-2: Gain expected worksheet .....	4-32
Table 4-3: Maximum bandwidth frequency worksheet .....	4-37

## General Safety Summary

Review the following safety precautions to avoid injury and prevent damage to this product or any products connected to it.

To avoid potential hazards, use this product only as specified.

*Only qualified personnel should perform service procedures.*

While using this product, you may need to access other parts of a larger system. Read the safety sections of the other component manuals for warnings and cautions related to operating the system.

### To Avoid Fire or Personal Injury

**Use proper power cord.** Use only the power cord specified for this product and certified for the country of use.

**Connect and disconnect properly.** Do not connect or disconnect probes or test leads while they are connected to a voltage source.

**Ground the product.** This product is grounded through the grounding conductor of the power cord. To avoid electric shock, the grounding conductor must be connected to earth ground. Before making connections to the input or output terminals of the product, ensure that the product is properly grounded.

**Observe all terminal ratings.** To avoid fire or shock hazard, observe all ratings and markings on the product. Consult the product manual for further ratings information before making connections to the product.

The inputs are not rated for connection to mains or Category II, III, or IV circuits.

Connect the probe reference lead to earth ground only.

**Power disconnect.** The power cord disconnects the product from the power source. Do not block the power cord; it must remain accessible to the user at all times.

**Do not operate without covers.** Do not operate this product with covers or panels removed.

**Do not operate with suspected failures.** If you suspect that there is damage to this product, have it inspected by qualified service personnel.

**Avoid exposed circuitry.** Do not touch exposed connections and components when power is present.

**Do not operate in wet/damp conditions.**

**Do not operate in an explosive atmosphere.**

**Keep product surfaces clean and dry.**

**Provide proper ventilation.** Refer to the manual's installation instructions for details on installing the product so it has proper ventilation.

**Terms in This Manual** These terms may appear in this manual:

 **WARNING.** *Warning statements identify conditions or practices that could result in injury or loss of life.*







 **CAUTION.** *Caution statements identify conditions or practices that could result in damage to this product or other property.*

**Symbols and Terms on the Product**

These terms may appear on the product:

- DANGER indicates an injury hazard immediately accessible as you read the marking.
- WARNING indicates an injury hazard not immediately accessible as you read the marking.
- CAUTION indicates a hazard to property including the product.

The following symbol(s) may appear on the product:

						
CAUTION Refer to Manual	WARNING High Voltage	Protective Ground (Earth) Terminal	Earth Terminal	Chassis Ground	Mains Disconnected OFF (Power)	Mains Connected ON (Power)

Standby



---

# **Specifications (MSO70000/C Series, DSA/DPO70000B/C Series, and DPO7000 Series)**





# Specifications (MSO70000/C Series, DSA/DPO70000B/C Series, and DPO7000 Series)

This chapter contains the specifications for the instrument. All specifications are guaranteed unless labeled "typical." Typical specifications are provided for your convenience but are not guaranteed. Specifications that are marked with the ✓ symbol are checked in this manual. All specifications apply to all models unless noted otherwise.

≥ 4 GHz models specifications apply to MSO70000, MSO70000C, DSA70000B, DSA70000C, DPO70000B, and DPO70000C Series instruments unless noted otherwise.

< 4 GHz models specifications apply to the DPO7000 Series instruments unless noted otherwise.

To meet specifications, the following conditions must be met:

- The instrument must have been calibrated in an ambient temperature between 18 °C and 28 °C (64 °F and 82 °F).
- The instrument must be operating within the environmental limits. (See page 1-58.)
- The instrument must be powered from a source that meets the specifications. (See page 2-17.)
- The instrument must have been operating continuously for at least 20 minutes within the specified operating temperature range.
- You must perform the Signal Path Compensation procedure after the 20-minute warm-up period. See the online help for instructions on how to perform signal path compensation. If the ambient temperature changes more than 5 °C, repeat the procedure.

**Table 1-1: Channel input and vertical specifications, all MSO70000/C, DSA/DPO70000B/C, and DPO7000 Series models**

Characteristic	Description
Number of channels	Four channels, all identical
Input connector	
≥ 4 GHz models	TekConnect. Power supply compatible with VPI.
< 4 GHz models	BNC and VPI probe
Input coupling	
≥ 4 GHz models	DC 50 Ω and GND. GND coupling disconnects the input connector from all channel input circuitry and connects a ground reference to the channel input circuitry.
< 4 GHz models	DC, AC, or GND. GND coupling approximates ground reference by measuring an unused preamplifier input that has been connected to ground. The signal being measured is not disconnected from the channel input load.

**Table 1-1: Channel input and vertical specifications, all MSO70000/C, DSA/DPO70000B/C, and DPO7000 Series models (cont.)**

Characteristic	Description
✓ Input resistance, ≥ 4 GHz models	
100 mV FS to 995 mV FS:	50 Ω ±1.5% at 25 °C (77 °F) 50 Ω ± 2% over 10 to 45 °C (50 to 113 °F), type tested
1 V FS to 5 V FS:	50 Ω ±2.2 Ω over 10 to 45 °C (50 to 113 °F), type tested
Input impedance, DC coupled, < 4 GHz models	
1 MΩ, DC coupled	1 MΩ ± 1% in parallel with 13 pF ± 2 pF
50 Ω, DC coupled	50 Ω ± 1%, typical
Maximum input voltage, ≥ 4 GHz models	<1 V <sub>RMS</sub> for <1.0 V/Full Scale settings <5.0 V <sub>RMS</sub> for ≥ 1.0 V/Full Scale settings
Maximum input voltage, < 4 GHz models	
1 MΩ – DC coupled, 1 MΩ – AC coupled, or GND coupled	150 V. Derate at 20 dB/decade to 9 V <sub>RMS</sub> above 200 kHz. The maximum input voltage at the BNC, between center conductor and ground is 400 V peak. The RMS voltage is limited to <150 V for arbitrary waveshapes including DC. The maximum pulse width for impulses with peaks over 150 V is 50 μs. Example: At 0 V to 400 V peak, rectangular wave, the duty factor is 14%. The maximum transient withstand voltage is ± 800 V peak.
50Ω	5 V RMS, with peaks ≤ ± 24 V
Input VSWR, typical	
≥ 4 GHz models	<i>VSWR &lt; 1 V/Full Scale</i> <i>VSWR ≥ 1 V/Full Scale</i>
Input Frequency	
<2.5 GHz	1.25      1.2
<6 GHz	1.5      1.2
<14 GHz	2.1      1.5
<15 GHz	2.5      1.5
<20 GHz	3.2      1.9
	Measured with a TekConnect SMA adapter and a network analyzer
< 4 GHz models	f <sub>in</sub> <3.5 GHz      3.0 f <sub>in</sub> <2.5 GHz      2.0 f <sub>in</sub> <2 GHz      1.5 f <sub>in</sub> <1 GHz      1.2
Number of digitized bits	8 bits
Digitizer nonlinearity, typical	< 1.0 DL (digitization level), differential; < 1 DL integral, independently based

**Table 1-1: Channel input and vertical specifications, all MSO70000/C, DSA/DPO70000B/C, and DPO7000 Series models (cont.)**

Characteristic	Description		
Sensitivity range			
≥ 4 GHz models, 50 Ω	100 mV/Full Scale to 5 V/Full Scale. Below 100 mV/Full Scale, Full Scale (FS) is software zoom.		
< 4 GHz models, 50 Ω	1 mV/div to 1 V/division, in a 1-2-5 sequence Fine adjustment available with ≥1% resolution		
< 4 GHz models, 1 MΩ	1 mV/div to 10 V/division, in a 1-2-5 sequence Fine adjustment available with ≥1% resolution		
✓ DC gain accuracy, sample or average acquisition mode, ≥ 4 GHz models	± 2%		
DC gain accuracy, sample or average acquisition mode, < 4 GHz models	± 1.0% with 0 V net offset Add 0.5% for ranges <2 mV/div Add 1.5% x   net offset/Max offset   for ranges <5 mV/div Add 0.5% x   net offset/Max offset   for ranges ≥ 5 mV/div Add 0.5% for ranges ≥ 1 V/div in 1 MΩ coupling and with net offset >10 V		
✓ DC voltage measurement accuracy, ≥ 4 GHz models	<i>Gain setting</i>	<i>DC measurement accuracy</i>	
	Average acquisition mode (≥16 averages)	100 mV/FS to 995 mV/FS	±[2%   reading - net offset   + 0.35%   net offset   +1.5 mV + 0.014 FS]
		1 V/FS to 5 V/FS	±[2%   reading - net offset   + 0.35%   net offset   +7.5 mV + 0.014 FS]
Delta voltage measurement between any two averages of ≥16 waveforms acquired under the same setup and ambient conditions	100 mV/FS to 5 V/FS	±[2%   reading   + 0.008 FS]	

**Table 1-1: Channel input and vertical specifications, all MSO70000/C, DSA/DPO70000B/C, and DPO7000 Series models (cont.)**

<b>Characteristic</b>	<b>Description</b>
✓ DC voltage measurement accuracy, < 4 GHz models	<i>DC accuracy (in volts)</i>
Average acquisition mode (≥16 averages)	$\pm(\text{DC Gain Accuracy} \times  \text{reading} - (\text{offset} - \text{position})  + \text{offset accuracy} + 0.1 \text{ division})$
Delta voltage measurement between any two averages of ≥16 waveforms acquired with the same setup and ambient conditions	$\pm(\text{DC Gain Accuracy} \times  \text{reading}  + 0.05 \text{ division})$
Sample acquisition mode, typical	$\pm(\text{DC Gain Accuracy} \times  \text{reading} - (\text{offset} - \text{position})  + \text{offset accuracy} + 0.15 \text{ division} + 0.6 \text{ mV})$
Delta voltage measurement between any two samples acquired with the same setup and ambient conditions, typical	$\pm(\text{DC Gain Accuracy} \times  \text{reading}  + 0.15 \text{ division} + 1.2 \text{ mV})$ Convert offset, position and the constant offset term to volts by multiplying by the appropriate volts/div. Specification applies to any sample and to the High, Low, Max, Min, Mean, Cycle Mean, RMS, and Cycle RMS measurements. Delta volts specification applies to subtractive calculations involving two of these measurements. Delta volts specification applies to the Positive Overshoot, Negative Overshoot, peak-peak, and amplitude measurements.
Position range	$\pm 5 \text{ divisions}$

Table 1-1: Channel input and vertical specifications, all MSO70000/C, DSA/DPO70000B/C, and DPO7000 Series models (cont.)

Characteristic	Description																																																							
Offset range ≥ 4 GHz models	Offset is reduced to allow for position control according to the following formulas: 10 mV/div to 99.5 mV/div: Offset range = $\pm(0.5\text{ V} - (\text{V/div setting} \times 5\text{ div}))$ 100 mV/div to 500 mV/div: Offset range = $\pm(2.5\text{ V} - (\text{V/div setting} \times 5\text{ div}))$																																																							
	<table border="1"> <thead> <tr> <th>SCALE range</th> <th>Offset range</th> </tr> </thead> <tbody> <tr><td>10 mV/div</td><td><math>\pm 0.450\text{ V}</math></td></tr> <tr><td>12 mV/div</td><td><math>\pm 0.440\text{ V}</math></td></tr> <tr><td>14 mV/div</td><td><math>\pm 0.430\text{ V}</math></td></tr> <tr><td>16 mV/div</td><td><math>\pm 0.420\text{ V}</math></td></tr> <tr><td>18 mV/div</td><td><math>\pm 0.410\text{ V}</math></td></tr> <tr><td>19.9 mV/div</td><td><math>\pm 0.4005\text{ V}</math></td></tr> <tr><td>20 mV/div</td><td><math>\pm 0.400\text{ V}</math></td></tr> <tr><td>30 mV/div</td><td><math>\pm 0.350\text{ V}</math></td></tr> <tr><td>40 mV/div</td><td><math>\pm 0.300\text{ V}</math></td></tr> <tr><td>49.8 mV/div</td><td><math>\pm 0.251\text{ V}</math></td></tr> <tr><td>50 mV/div</td><td><math>\pm 0.250\text{ V}</math></td></tr> <tr><td>60 mV/div</td><td><math>\pm 0.200\text{ V}</math></td></tr> <tr><td>70 mV/div</td><td><math>\pm 0.150\text{ V}</math></td></tr> <tr><td>80 mV/div</td><td><math>\pm 0.100\text{ V}</math></td></tr> <tr><td>90 mV/div</td><td><math>\pm 0.050\text{ V}</math></td></tr> <tr><td>99.5 mV/div</td><td><math>\pm 0.0025\text{ V}</math></td></tr> <tr><td>100 mV/div</td><td><math>\pm 2.00\text{ V}</math></td></tr> <tr><td>120 mV/div</td><td><math>\pm 1.90\text{ V}</math></td></tr> <tr><td>140 mV/div</td><td><math>\pm 1.80\text{ V}</math></td></tr> <tr><td>160 mV/div</td><td><math>\pm 1.70\text{ V}</math></td></tr> <tr><td>180 mV/div</td><td><math>\pm 1.60\text{ V}</math></td></tr> <tr><td>200 mV/div</td><td><math>\pm 1.50\text{ V}</math></td></tr> <tr><td>248 mV/div</td><td><math>\pm 1.260\text{ V}</math></td></tr> <tr><td>250 mV/div</td><td><math>\pm 1.250\text{ V}</math></td></tr> <tr><td>300 mV/div</td><td><math>\pm 1.00\text{ V}</math></td></tr> <tr><td>400 mV/div</td><td><math>\pm 0.50\text{ V}</math></td></tr> <tr><td>500 mV/div</td><td><math>\pm 0.00\text{ V}</math></td></tr> </tbody> </table>	SCALE range	Offset range	10 mV/div	$\pm 0.450\text{ V}$	12 mV/div	$\pm 0.440\text{ V}$	14 mV/div	$\pm 0.430\text{ V}$	16 mV/div	$\pm 0.420\text{ V}$	18 mV/div	$\pm 0.410\text{ V}$	19.9 mV/div	$\pm 0.4005\text{ V}$	20 mV/div	$\pm 0.400\text{ V}$	30 mV/div	$\pm 0.350\text{ V}$	40 mV/div	$\pm 0.300\text{ V}$	49.8 mV/div	$\pm 0.251\text{ V}$	50 mV/div	$\pm 0.250\text{ V}$	60 mV/div	$\pm 0.200\text{ V}$	70 mV/div	$\pm 0.150\text{ V}$	80 mV/div	$\pm 0.100\text{ V}$	90 mV/div	$\pm 0.050\text{ V}$	99.5 mV/div	$\pm 0.0025\text{ V}$	100 mV/div	$\pm 2.00\text{ V}$	120 mV/div	$\pm 1.90\text{ V}$	140 mV/div	$\pm 1.80\text{ V}$	160 mV/div	$\pm 1.70\text{ V}$	180 mV/div	$\pm 1.60\text{ V}$	200 mV/div	$\pm 1.50\text{ V}$	248 mV/div	$\pm 1.260\text{ V}$	250 mV/div	$\pm 1.250\text{ V}$	300 mV/div	$\pm 1.00\text{ V}$	400 mV/div	$\pm 0.50\text{ V}$	500 mV/div
SCALE range	Offset range																																																							
10 mV/div	$\pm 0.450\text{ V}$																																																							
12 mV/div	$\pm 0.440\text{ V}$																																																							
14 mV/div	$\pm 0.430\text{ V}$																																																							
16 mV/div	$\pm 0.420\text{ V}$																																																							
18 mV/div	$\pm 0.410\text{ V}$																																																							
19.9 mV/div	$\pm 0.4005\text{ V}$																																																							
20 mV/div	$\pm 0.400\text{ V}$																																																							
30 mV/div	$\pm 0.350\text{ V}$																																																							
40 mV/div	$\pm 0.300\text{ V}$																																																							
49.8 mV/div	$\pm 0.251\text{ V}$																																																							
50 mV/div	$\pm 0.250\text{ V}$																																																							
60 mV/div	$\pm 0.200\text{ V}$																																																							
70 mV/div	$\pm 0.150\text{ V}$																																																							
80 mV/div	$\pm 0.100\text{ V}$																																																							
90 mV/div	$\pm 0.050\text{ V}$																																																							
99.5 mV/div	$\pm 0.0025\text{ V}$																																																							
100 mV/div	$\pm 2.00\text{ V}$																																																							
120 mV/div	$\pm 1.90\text{ V}$																																																							
140 mV/div	$\pm 1.80\text{ V}$																																																							
160 mV/div	$\pm 1.70\text{ V}$																																																							
180 mV/div	$\pm 1.60\text{ V}$																																																							
200 mV/div	$\pm 1.50\text{ V}$																																																							
248 mV/div	$\pm 1.260\text{ V}$																																																							
250 mV/div	$\pm 1.250\text{ V}$																																																							
300 mV/div	$\pm 1.00\text{ V}$																																																							
400 mV/div	$\pm 0.50\text{ V}$																																																							
500 mV/div	$\pm 0.00\text{ V}$																																																							

**Table 1-1: Channel input and vertical specifications, all MSO70000/C, DSA/DPO70000B/C, and DPO7000 Series models (cont.)**

<b>Characteristic</b>	<b>Description</b>	
< 4 GHz models, 50 Ω coupling	<i>SCALE range</i>	<i>Offset range</i>
	1 mV/div to 50 mV/div	±1.0 V
	50.5 mV/div to 99.5 mV/div	±1.5 V - 10 divisions
	100 mV/div to 500 mV/div	±10 V
	505 mV/div to 1 V/div	±15 V - 10 divisions
< 4 GHz models, 1 MΩ coupling	<i>SCALE range</i>	<i>Offset range</i>
	1 mV/div to 50 mV/div	±1 V
	50.5 mV/div to 99.5 mV/div	±1.5 V - 10 divisions
	100 mV/div to 500 mV/div	±10 V
	505 mV/div to 995 mV/div	±15 V - 10 divisions
	1.0 V/div to 5 V/div	±100 V
	5.05 V/div to 10 V/div	±150 V - 10 divisions
Offset accuracy	<i>Net offset = offset - ( position × volts/division).</i>	
✍ ≥ 4 GHz models	<i>SCALE range</i>	<i>Offset accuracy</i>
	10 mV/div to 99.5 mV/div	±(0.35% ×   net offset   + 1.5 mV + 1% x Full Scale)
	100 mV/div to 0.5 V/div	±(0.35% ×   net offset   + 7.5 mV + 1% x Full Scale)
< 4 GHz models	<i>SCALE range</i>	<i>Offset accuracy</i>
	1 mV/div to 9.95 mV/div	±(0.2% ×   net offset   + 1.5 mV + 0.1 div × V/div setting)
	10 mV/div to 99.5 mV/div	±(0.35% ×   net offset   + 1.5 mV + 0.1 div × V/div setting)
	100 mV/div to 1 V/div	±(0.35% ×   net offset   + 15 mV + 0.1 div × V/div setting)
	1.01 V/div to 10 V/div	±(0.25% ×   net offset   + 150 mV + 0.1 div × V/div setting)

**Table 1-1: Channel input and vertical specifications, all MSO70000/C, DSA/DPO70000B/C, and DPO7000 Series models (cont.)**

Characteristic	Description		
✓ Analog Bandwidth, $\geq 4$ GHz models	DC 50 $\Omega$ coupling, full bandwidth, TCA-292mm or TCA-N adapter, operating ambient temperature 15 °C to 40 °C (59 °F to 104 °F).  Enhanced bandwidth only applies to full scale (FS) settings of 100 mV, 200 mV, 500 mV, 1 V, and 2.5 V. Enhanced bandwidth of 4 GHz, 6 GHz, and 8 GHz is only available at 25 GS/s and 50 GS/s.  Use the Temperature variation table to determine the amount of performance derating above the temperature limit.		
<i>Instrument</i>	<i>BW Settings</i>	<i>Bandwidth</i>	Temp Constraint
MSO/DSA/DPO72004C	20 GHz BWE 20 mV, 50 mV, 100 mV, and 250 mV/div	DC to >20 GHz	<30 °C
	20 GHz BWE 100 mV full scale (10 mV/div)	DC to >18 GHz	<30 °C
	No BWE	DC to >16 GHz, typical	<30 °C
MSO/DSA/DPO71604C	BWE	DC to >16 GHz	<30 °C
	No BWE	DC to >16 GHz, typical	<30 °C
MSO/DSA/DPO71254C	BWE	DC to >12.5 GHz	<30 °C
	No BWE	DC to >12.5 GHz	<30 °C
MSO70804, DSA/DPO70804B	BWE	DC to >8 GHz	<45 °C
	No BWE	DC to >8 GHz	<45 °C
MSO70604, DSA/DPO70604B	BWE	DC to >6 GHz	<45 °C
	No BWE	DC to >6 GHz	<45 °C
MSO70404, DSA/DPO70404B	BWE	DC to >4 GHz	<45 °C
	No BWE	DC to >4 GHz	<45 °C
Typical temperature variation			
	<i>Frequency</i>	<i>TC, (dB/°C)</i>	
	DC — 11 GHz	0	
	12.5 GHz	- 0.02	
	16 GHz	- 0.04	
	18 GHz	- 0.09	
	20 GHz	- 0.09	

**Table 1-1: Channel input and vertical specifications, all MSO70000/C, DSA/DPO70000B/C, and DPO7000 Series models (cont.)**

<b>Characteristic</b>	<b>Description</b>	
Analog bandwidth, with P7313 active probe, $\geq 4$ GHz models	MSO/DSA/DPO72004C, MSO/DSA/DPO71604C	DC >12.5 GHz, typical
	MSO/DSA/DPO71254C	DC >11 GHz, typical
	MSO70804, DSA/DPO70804B	DC >8 GHz, typical
	MSO70604, DSA/DPO70604B	DC >6 GHz, typical
	MSO70404, DSA/DPO70404B	DC >4 GHz, typical
✓ Analog bandwidth, 50 $\Omega$ DC coupled, <4 GHz models	Full bandwidth, operating ambient of $\leq 30$ °C (86 °F), derated by 1% for each °C above 30 °C (86 °F) Note: The DPO7354 is guaranteed 3.5 GHz bandwidth with BWE On and can be verified with a 4-division sine wave. Typical bandwidth when measured with an 8-division sine wave is 3 GHz.	
<i>Instrument</i>	<i>SCALE range</i>	<i>Bandwidth</i>
DPO7354	10 mV/div to 1 V/div	DC to 3.5 GHz, BWE on DC to 2.5 GHz, BWE off
	5 mV/div to 9.99 mV/div	DC to 2.0 GHz
	2 mV/div to 4.99 mV/div	DC to 500 MHz, typical
	1 mV/div to 1.99 mV/div	DC to 200 MHz, typical
DPO7254	10 mV/div to 1 V/div	DC to 2.5 GHz
	5 mV/div to 9.99 mV/div	DC to 2.0 GHz
	2 mV/div to 4.99 mV/div	DC to 500 MHz, typical
	1 mV/div to 1.99 mV/div	DC to 200 MHz, typical
DPO7104	5 mV/div to 1 V/div	DC to 1.0 GHz
	2 mV/div to 4.99 mV/div	DC to 500 MHz, typical
	1 mV/div to 1.99 mV/div	DC to 200 MHz, typical
DPO7054	5 mV/div to 1 V/div	DC to 500 MHz
	2 mV/div to 4.99 mV/div	DC to 400 MHz, typical
	1 mV/div to 1.99 mV/div	DC to 200 MHz, typical
Analog bandwidth, 1 M $\Omega$ DC coupled, < 4 GHz models	Full bandwidth, operating ambient temperature of $\leq 30$ °C (86 °F), derated by 1% for each °C above 30 °C (86 °F)	
	<i>SCALE range</i>	<i>Bandwidth</i>
	5 mV/div to 10 V/div	DC to 500 MHz, typical
	2 mV/div to 4.98 mV/div	DC to 350 MHz, typical
	1 mV/div to 1.99 mV/div	DC to 175 MHz, typical



**Table 1-1: Channel input and vertical specifications, all MSO70000/C, DSA/DPO70000B/C, and DPO7000 Series models (cont.)**

Characteristic	Description	
Analog bandwidth with TAP2500 VPI probe, typical, DPO7254	Full bandwidth, operating ambient of $\leq 30\text{ }^{\circ}\text{C}$ ( $86\text{ }^{\circ}\text{F}$ ), derated by 1% for each $^{\circ}\text{C}$ above $30\text{ }^{\circ}\text{C}$ ( $86\text{ }^{\circ}\text{F}$ )	
	<i>SCALE range</i>	<i>Bandwidth</i>
	$\geq 100\text{ mV/div}$	DC to 2.5 GHz
	50 mV/div to 99.5 mV/div	DC to 2.0 GHz
	20 mV/div to 49.8 mV/div	DC to 500 MHz
	10 mV/div to 19.9 mV/div	DC to 200 MHz
Analog bandwidth with X10 passive probe, typical, < 4 GHz models	Full bandwidth, operating ambient of $\leq 30\text{ }^{\circ}\text{C}$ ( $86\text{ }^{\circ}\text{F}$ ), derated by 1% for each $^{\circ}\text{C}$ above $30\text{ }^{\circ}\text{C}$ ( $86\text{ }^{\circ}\text{F}$ )	
	<i>SCALE range</i>	<i>Bandwidth</i>
	5 mV/div to 10 V/div	DC to 500 MHz
	2 mV/div to 4.98 mV/div	DC to 300 MHz
	1 mV/div to 1.99 mV/div	DC to 175 MHz
Analog bandwidth selections, < 4 GHz models	20 MHz, 250 MHz, and Full	
Lower frequency limit, AC coupled, < 4 GHz models	10 Hz when 1 M $\Omega$ , AC coupled. The limit is reduced by a factor of 10 when 10X, passive probes are used.	
Upper frequency limit, 250 MHz bandwidth limited, < 4 GHz models	250 MHz	
Upper frequency limit, 20 MHz bandwidth limited, < 4 GHz models	20 MHz	
Passband flatness, BWE, typical	Use the Temperature variation table to determine the amount of performance derating above the temperature limit.	
	Step settings	Temperature constraint
	100 mVFS, 200 mVFS, 500 m VFS, 1 VFS, and 2.5 VFS	At 25 $^{\circ}\text{C}$
	$\pm 0.5\text{ dB}$ from DC to 50% of nominal bandwidth.	
	$\pm 1.5\text{ dB}$ from 50% to 80% of nominal bandwidth.	
Non-step settings		
	$\pm 1.0\text{ dB}$ from DC to 50% of nominal bandwidth	
	$\pm 2.0\text{ dB}$ from 50% to 80% of nominal bandwidth.	

**Table 1-1: Channel input and vertical specifications, all MSO70000/C, DSA/DPO70000B/C, and DPO7000 Series models (cont.)**

Characteristic	Description			
MSO70804, DSA/DPO70804B, MSO70604, DSA/DPO70604B, MSO70404, DSA/DPO70404B	Step settings			10 °C to 40 °C
	± 0.5 dB from DC to 50% of nominal bandwidth.			
	± 1 dB from 50% to 80% of nominal bandwidth.			
	Typical temperature variation			
	<i>Frequency</i>	<i>TC, (dB/°C)</i>		
	DC — 11 GHz	0		
	12.5 GHz	- 0.02		
	16 GHz	- 0.04		
	18 GHz	- 0.09		
	20 GHz	- 0.09		
Calculated rise time, 50 Ω, typical ≥ 4 GHz models				
	<i>DSP On</i>		<i>DSP Off</i>	
	<i>10% - 90%</i>	<i>20% - 80%</i>	<i>10% - 90%</i>	<i>20% - 80%</i>
MSO/DSA/DPO72004C at 20 GHz	19.0 ps	14 ps	NA	NA
MSO/DSA/DPO72004C at 18 GHz	22 ps	15 ps	NA	NA
MSO/DSA/DPO71604C	24.5 ps	17 ps	30 ps	20 ps
MSO/DSA/DPO71254C	32.0 ps	22 ps	33 ps	23 ps
MSO70804, DSA/DPO70804B	49 ps	34 ps	47 ps	32 ps
MSO70604, DSA/DPO70604B	65 ps	45 ps	62 ps	43 ps
MSO70404, DSA/DPO70404B	98 ps	68 ps	93 ps	65 ps

**Table 1-1: Channel input and vertical specifications, all MSO70000/C, DSA/DPO70000B/C, and DPO7000 Series models (cont.)**

Characteristic	Description
Calculated rise time, 50 $\Omega$ , typical < 4 GHz models	10% - 90%
<b>DPO7354</b>	
1 mV/div - 1.99 mV/div	1.2 ns
2 mV/div - 4.99 mV/div	650 ps
5 mV/div - 9.9 mV/div	180 ps
10 mV/div - 1 V/div, BWE off	145 ps
10 mV/div - 1 V/div, BWE on	115 ps (signals limited to 4 vertical divisions)
<b>DPO7254</b>	
1 mV/div - 1.99 mV/div	1.2 ns
2 mV/div - 4.99 mV/div	650 ps
5 mV/div - 9.9 mV/div	180 ps
10 mV/div - 1 V/div	160 ps
<b>DPO7104</b>	
1 mV/div - 1.99 mV/div	1.2 ns
2 mV/div - 4.99 mV/div	580 ps
5 mV/div - 9.9 mV/div	300 ps
10 mV/div - 1 V/div	300 ps
<b>DPO7054</b>	
1 mV/div - 1.99 mV/div	1.2 ns
2 mV/div - 4.99 mV/div	680 ps
5 mV/div - 9.9 mV/div	460 ps
10 mV/div - 1 V/div	460 ps

**Table 1-1: Channel input and vertical specifications, all MSO70000/C, DSA/DPO70000B/C, and DPO7000 Series models (cont.)**

Characteristic	Description			
Step response settling time, typical, ≥ 4 GHz models	The time by which the step response enters and stays below the indicated % error. Step transition occurs at the 50% amplitude point of the step leading edge.			
	<b>DSP off</b>			
<i>Instrument</i>	<i>Gain setting (FS)</i>	<i>± Step amplitude</i>	<i>Settling Error</i>	<i>Time</i>
MSO/DSA/DPO72004C	100 mV	≤ 100% FS,	< 9%	150 ps
	200 mV	≤ 50% FS	< 5.5%	400 ps
	500 mV	overdrive	< 2.5%	3 ns
	1 V		< 0.15%	1 ms
	2 V			
	5 V			
MSO/DSA/DPO71604C	100 mV	≤ 100% FS,	< 9%	150 ps
	200 mV	≤ 50% FS	< 5.5%	400 ps
	500 mV	overdrive	< 2.5%	3 ns
	1 V		< 0.15%	1 ms
	2 V			
	5 V			
MSO/DSA/DPO71254C	100 mV	≤ 100% FS,	< 9%	150 ps
	200 mV	≤ 50% FS	< 5.5%	400 ps
	500 mV	overdrive	< 2.5%	3 ns
	1 V		< 0.15%	1 ms
	2 V			
	5 V			
MSO70804, DSA/DPO70804B	100 mV	≤ 100% FS,	< 6%	150 ps
	200 mV	≤ 50% FS	< 3%	600 ps
	500 mV	overdrive	< 2.5%	3 ns
	1 V		< 0.15%	1 ms
	2 V			
	5 V			
MSO70604, DSA/DPO70604B	100 mV	≤ 100% FS,	< 6%	200 ps
	200 mV	≤ 50% FS	< 3%	800 ps
	500 mV	overdrive	< 2.5%	3 ns
	1 V		< 0.15%	1 ms
	2 V			
	5 V			
MSO70404, DSA/DPO70404B	100 mV	≤ 100% FS,	< 6%	300 ps
	200 mV	≤ 50% FS	< 3%	1.2 ns
	500 mV	overdrive	< 2.5%	3 ns
	1 V		< 0.15%	1 ms
	2 V			
	5 V			

**Table 1-1: Channel input and vertical specifications, all MSO70000/C, DSA/DPO70000B/C, and DPO7000 Series models (cont.)**

Characteristic	Description			
	DSP on			
Instrument	Gain setting (FS)	$\pm$ Step amplitude	Settling Error	
			Amount	Time
MSO/DSA/DPO72004C	100 mV	$\leq 100\%$ FS,	<6%	100 ps
	200 mV	$\leq 50\%$ FS	<3%	400 ps
	500 mV	overdrive	<2.5%	3 ns
	1 V		<0.15%	1 ms
	2 V			
	5 V			
MSO/DSA/DPO71604C	100 mV	$\leq 100\%$ FS,	<6%	100 ps
	200 mV	$\leq 50\%$ FS	<3%	400 ps
	500 mV	overdrive	<2.5%	3 ns
	1 V		<0.15%	1 ms
	2 V			
	5 V			
MSO/DSA/DPO71254C	100 mV	$\leq 100\%$ FS,	<6%	100 ps
	200 mV	$\leq 50\%$ FS	<3%	400 ps
	500 mV	overdrive	<2.5%	3 ns
	1 V		<0.15%	1 ms
	2 V			
	5 V			
MSO70804, DSA/DPO70804B	100 mV	$\leq 100\%$ FS,	<6%	150 ps
	200 mV	$\leq 50\%$ FS	<3%	600 ps
	500 mV	overdrive	<2.5%	3 ns
	1 V		<0.15%	1 ms
	2 V			
	5 V			
MSO70604, DSA/DPO70604B	100 mV	$\leq 100\%$ FS,	<6%	200 ps
	200 mV	$\leq 50\%$ FS	<3%	800 ps
	500 mV	overdrive	<2.5%	3 ns
	1 V		<0.15%	1 ms
	2 V			
	5 V			
MSO70404, DSA/DPO70404B	100 mV	$\leq 100\%$ FS,	<6%	300 ps
	200 mV	$\leq 50\%$ FS	<3%	1.2 ns
	500 mV	overdrive	<2.5%	3 ns
	1 V		<0.15%	1 ms
	2 V			
	5 V			

**Table 1-1: Channel input and vertical specifications, all MSO70000/C, DSA/DPO70000B/C, and DPO7000 Series models (cont.)**

Characteristic	Description						
Pulse response, peak detect, or envelope mode, typical	Sample rate setting			Minimum pulse width			
< 4 GHz models	≤ 10 GS/s			1 ÷ (sample rate) or 100 ps			
	40 MS/s			1 ÷ (sample rate) or 25 ps			
	This instrument uses analog peak detection for pulse capture in Peak Detect or Envelope mode at sample rates of 125 MS per second and slower. At faster sample rates the instrument uses conventional sampling.						
	The minimum single pulse widths for 50% or greater amplitude capture for pulses greater than 2 divisions in magnitude.						
Effective bits, typical	Nine division sine wave input at the indicated frequency, sampled at 500 mV FS and maximum sample rate						
≥ 4 GHz models	Enhanced bandwidth						
Input frequency	MSO72004C, DSA72004C, DPO72004C	MSO71604C, DSA71604C, DPO71604C	MSO71254C, DSA71254C, DPO71254C	MSO70804, DSA70804B, DPO70804B	MSO70604, DSA70604B, DPO70604B	MSO70404, DSA70404B, DPO70404B	
		20 GHz	16 GHz	12.5 GHz	8 GHz	6 GHz	4.0 GHz
	50 GS/s	100 GS/s					
10 MHz	5.0 bits	5.3 bits	5.7 bits	5.9 bits	5.7 bits	5.8 bits	6.0 bits
1 GHz	5.0 bits	5.3 bits	5.6 bits	5.8 bits	5.7 bits	5.8 bits	5.9 bits
2 GHz	4.9 bits	5.2 bits	5.6 bits	5.7 bits	5.7 bits	5.7 bits	5.8 bits
3 GHz	4.9 bits	5.2 bits	5.5 bits	5.6 bits	5.5 bits	5.6 bits	5.7 bits
4 GHz	4.8 bits	5.1 bits	5.5 bits	5.6 bits	5.5 bits	5.6 bits	5.7 bits
5 GHz	4.8 bits	5.1 bits	5.4 bits	5.5 bits	5.5 bits	5.5 bits	
6 GHz	4.7 bits	5.0 bits	5.3 bits	5.4 bits	5.4 bits	5.4 bits	
7 GHz	4.3 bits	4.6 bits	5.1 bits	5.5 bits	5.4 bits		
8 GHz	3.9 bits	4.2 bits	4.4 bits	5.6 bits	5.3 bits		
9 GHz	3.2 bits	3.5 bits	5.1 bits	5.6 bits			
10 GHz	2.8 bits	3.1 bits	5.5 bits	5.6 bits			
11 GHz	3.9 bits	4.2 bits	5.4 bits	5.6 bits			
12 GHz	4.8 bits	5.1 bits	5.4 bits	5.6 bits			
13 GHz	4.5 bits	4.8 bits	5.2 bits				
14 GHz	4.4 bits	4.7 bits	5.1 bits				
15 GHz	4.5 bits	4.8 bits	5.1 bits				
16 GHz	4.5 bits	4.8 bits	5.1 bits				
17 GHz	4.4 bits	4.4 bits					
18 GHz	4.5 bits	4.5 bits					
19 GHz	4.6 bits	4.6 bits					
20 GHz	4.8 bits	5.1 bits					

**Table 1-1: Channel input and vertical specifications, all MSO70000/C, DSA/DPO70000B/C, and DPO7000 Series models (cont.)**

Without enhanced bandwidth						
Input frequency	MSO72004C, DSA72004C, DPO72004C	MSO71604C, DSA71604C, DPO71604C	MSO71254C, DSA71254C, DPO71254C	MSO70804, DSA70804B, DPO70804B	MSO70604, DSA70604B, DPO70604B	MSO70404, DSA70404B, DPO70404B
10 MHz	5.4 bits	5.4 bits	5.6 bits	5.6 bits	5.7 bits	5.8 bits
1 GHz	5.4 bits	5.4 bits	5.5 bits	5.6 bits	5.7 bits	5.8 bits
2 GHz	5.3 bits	5.3 bits	5.4 bits	5.4 bits	5.6 bits	5.7 bits
3 GHz	5.3 bits	5.3 bits	5.4 bits	5.4 bits	5.5 bits	5.6 bits
4 GHz	5.2 bits	5.2 bits	5.3 bits	5.3 bits	5.4 bits	5.5 bits
5 GHz	5.2 bits	5.2 bits	5.3 bits	5.2 bits	5.3 bits	
6 GHz	5.0 bits	5.0 bits	5.2 bits	5.2 bits	5.3 bits	
7 GHz	4.8 bits	4.8 bits	5.1 bits	5.2 bits		
8 GHz	4.4 bits	4.4 bits	5.0 bits	5.2 bits		
9 GHz	4.1 bits	4.1 bits	5.0 bits			
10 GHz	4.0 bits	4.0 bits	5.1 bits			
11 GHz	4.1 bits	4.1 bits	5.2 bits			
12 GHz	3.8 bits	3.8 bits	5.1 bits			
13 GHz	4.1 bits	4.1 bits				
14 GHz	4.7 bits	4.7 bits				
15 GHz	4.7 bits	4.7 bits				
16 GHz	4.7 bits	4.7 bits				
Effective bits, typical <4 GHz models	Effective bits for a 450 mV sine wave input at the indicated frequency, sampled at the given sample rate and BWE settings. All measurements are made at 50 mV/div with a 20K record length.					
DPO7354	3 GHz sine wave leveled to 6 divisions on screen and 3.5 GHz sine wave leveled to 4 divisions on screen due to slew rate limiting.					
Enhanced bandwidth						
40 GS/s						
Analog bandwidth setting						
Input Frequency	3.5 GHz	3.0 GHz	2.5 GHz	2.0 GHz	1.0 GHz	0.5 GHz
10 MHz	5.9 bits	6.1 bits	6.2 bits	6.4 bits	6.8 bits	7.1 bits
510 MHz	5.9 bits	6.0 bits	6.1 bits	6.4 bits	6.8 bits	7.1 bits
1010 MHz	5.6 bits	5.7 bits	5.8 bits	6.1 bits	6.8 bits	
1510 MHz	5.6 bits	5.8 bits	6.2 bits	6.3 bits		
2010 MHz	5.8 bits	6.0 bits	6.1 bits	6.3 bits		
2510 MHz	5.7 bits	5.7 bits	5.9 bits			
3010 MHz	5.7 bits	5.8 bits				
3510 MHz	5.6 bits					

**Table 1-1: Channel input and vertical specifications, all MSO70000/C, DSA/DPO70000B/C, and DPO7000 Series models (cont.)**

20 GS/s						
Analog bandwidth setting						
Input Frequency	3.5 GHz	3.0 GHz	2.5 GHz	2.0 GHz	1.0 GHz	0.5 GHz
10 MHz	5.8 bits	6.0 bits	6.2 bits	6.3 bits	6.7 bits	7.0 bits
510 MHz	5.8 bits	6.0 bits	6.1 bits	6.3 bits	6.7 bits	7.0 bits
1010 MHz	5.6 bits	5.6 bits	5.7 bits	6.0 bits	6.7 bits	
1510 MHz	5.6 bits	5.8 bits	6.1 bits	6.2 bits		
2010 MHz	5.8 bits	6.0 bits	6.1 bits	6.2 bits		
2510 MHz	5.6 bits	5.7 bits	5.8 bits			
3010 MHz	5.7 bits	5.7 bits				
3510 MHz	5.5 bits					
10 GS/s						
Analog bandwidth setting						
Input Frequency	3.5 GHz	3.0 GHz	2.5 GHz	2.0 GHz	1.0 GHz	0.5 GHz
10 MHz	5.8 bits	5.9 bits	6.1 bits	6.2 bits	6.7 bits	7.0 bits
510 MHz	5.7 bits	5.9 bits	6.0 bits	6.2 bits	6.7 bits	7.0 bits
1010 MHz	5.5 bits	5.6 bits	5.7 bits	6.0 bits	6.7 bits	
1510 MHz	5.5 bits	5.7 bits	6.0 bits	6.1 bits		
2010 MHz	5.6 bits	5.8 bits	6.0 bits	6.1 bits		
2510 MHz	5.5 bits	5.6 bits	5.7 bits			
3010 MHz	5.6 bits	5.7 bits				
3510 MHz	5.4 bits					
Without enhanced bandwidth						
40 GS/s						
Analog bandwidth setting						
Input Frequency	2.5 GHz	0.5 GHz	0.25 GHz	0.02 GHz		
10 MHz	5.9 bits	6.3 bits	6.5 bits	6.6 bits		
510 MHz	5.8 bits	6.3 bits				
1010 MHz	5.6 bits					
1510 MHz	5.6 bits					
2010 MHz	5.1 bits					
2510 MHz	4.6 bits					



**Table 1-1: Channel input and vertical specifications, all MSO70000/C, DSA/DPO70000B/C, and DPO7000 Series models (cont.)**

20 GS/s				
Analog bandwidth setting				
Input Frequency	2.5 GHz	0.5 GHz	0.25 GHz	0.02 GHz
10 MHz	5.9 bits	6.3 bits	6.5 bits	6.6 bits
510 MHz	5.8 bits	6.3 bits		
1010 MHz	5.6 bits			
1510 MHz	5.6 bits			
2010 MHz	5.2 bits			
2510 MHz	4.6 bits			
10 GS/s				
Analog bandwidth setting				
Input Frequency	2.5 GHz	0.5 GHz	0.25 GHz	0.02 GHz
10 MHz	5.9 bits	6.3 bits	6.5 bits	6.6 bits
510 MHz	5.8 bits	6.3 bits		
1010 MHz	5.6 bits			
1510 MHz	5.7 bits			
2010 MHz	5.7 bits			
2510 MHz	5.5 bits			

DPO7254

Enhanced bandwidth

40 GS/s				
Analog bandwidth setting				
Input Frequency	2.5 GHz	2.0 GHz	1.0 GHz	0.5 GHz
10 MHz	6.2 bits	6.4 bits	6.9 bits	7.2 bits
510 MHz	6.1 bits	6.3 bits	6.9 bits	7.2 bits
1010 MHz	5.9 bits	6.1 bits	6.9 bits	
1510 MHz	6.1 bits	6.4 bits		
2010 MHz	6.1 bits	6.3 bits		
2510 MHz	5.6 bits			

**Table 1-1: Channel input and vertical specifications, all MSO70000/C, DSA/DPO70000B/C, and DPO7000 Series models (cont.)**

20 GS/s				
Analog bandwidth setting				
Input Frequency	2.5 GHz	2.0 GHz	1.0 GHz	0.5 GHz
10 MHz	6.1 bits	6.3 bits	6.8 bits	7.1 bits
510 MHz	6.1 bits	6.3 bits	6.8 bits	7.1 bits
1010 MHz	5.8 bits	6.1 bits	6.8 bits	
1510 MHz	6.0 bits	6.3 bits		
2010 MHz	6.1 bits	6.3 bits		
2510 MHz	5.6 bits			
10 GS/s				
Analog bandwidth setting				
Input Frequency	2.5 GHz	2.0 GHz	1.0 GHz	0.5 GHz
10 MHz	6.1 bits	6.4 bits	6.9 bits	7.2 bits
510 MHz	6.1 bits	6.3 bits	6.9 bits	7.2 bits
1010 MHz	5.7 bits	6.1 bits	6.9 bits	
1510 MHz	5.9 bits	6.4 bits		
2010 MHz	6.0 bits	6.3 bits		
2510 MHz	5.5 bits			
Without enhanced bandwidth				
40 GS/s				
Analog bandwidth setting				
Input Frequency	2.5 GHz	0.5 GHz	0.25 GHz	0.02 GHz
10 MHz	5.9 bits	6.3 bits	6.5 bits	6.6 bits
510 MHz	5.9 bits	6.3 bits		
1010 MHz	5.6 bits			
1510 MHz	5.6 bits			
2010 MHz	5.2 bits			
2510 MHz	4.5 bits			

**Table 1-1: Channel input and vertical specifications, all MSO70000/C, DSA/DPO70000B/C, and DPO7000 Series models (cont.)**

20 GS/s				
Analog bandwidth setting				
Input Frequency	2.5 GHz	0.5 GHz	0.25 GHz	0.02 GHz
10 MHz	5.9 bits	6.3 bits	6.5 bits	6.6 bits
510 MHz	5.9 bits	6.3 bits		
1010 MHz	5.6 bits			
1510 MHz	5.6 bits			
2010 MHz	5.2 bits			
2510 MHz	4.5 bits			
10 GS/s				
Analog bandwidth setting				
Input Frequency	2.5 GHz	0.5 GHz	0.25 GHz	0.02 GHz
10 MHz	5.9 bits	6.3 bits	6.5 bits	6.6 bits
510 MHz	5.9 bits	6.3 bits		
1010 MHz	5.6 bits			
1510 MHz	5.7 bits			
2010 MHz	5.8 bits			
2510 MHz	5.5 bits			

DPO7104

Enhanced bandwidth

20 GS/s		
Analog bandwidth setting		
Input Frequency	1.0 GHz	0.5 GHz
10 MHz	6.7 bits	7.2 bits
510 MHz	6.7 bits	7.2 bits
1010 MHz	6.7 bits	
10 GS/s		
Analog bandwidth setting		
Input Frequency	1.0 GHz	0.5 GHz
10 MHz	6.6 bits	7.1 bits
510 MHz	6.5 bits	7.1 bits
1010 MHz	6.5 bits	

**Table 1-1: Channel input and vertical specifications, all MSO70000/C, DSA/DPO70000B/C, and DPO7000 Series models (cont.)**

5 GS/s				
Analog bandwidth setting				
Input Frequency	1.0 GHz	0.5 GHz		
10 MHz	6.4 bits	7.0 bits		
510 MHz	6.4 bits	7.0 bits		
1010 MHz	6.3 bits			
Without enhanced bandwidth				
20 GS/s				
Analog bandwidth setting				
Input Frequency	1.0 GHz	0.5 GHz	0.25 GHz	0.02 GHz
10 MHz	6.4 bits	6.4 bits	6.6 bits	6.7 bits
510 MHz	6.1 bits	6.4 bits		
1010 MHz	5.7 bits			
10 GS/s				
Analog bandwidth setting				
Input Frequency	1.0 GHz	0.5 GHz	0.25 GHz	0.02 GHz
10 MHz	6.4 bits	6.4 bits	6.6 bits	6.7 bits
510 MHz	6.3 bits	6.4 bits		
1010 MHz	6.3 bits			
5 GS/s				
Analog bandwidth setting				
Input Frequency	1.0 GHz	0.5 GHz	0.25 GHz	0.02 GHz
10 MHz	6.4 bits	6.4 bits	6.6 bits	6.7 bits
510 MHz	6.3 bits	6.4 bits		
1010 MHz	6.3 bits			
DPO7054				
Enhanced bandwidth		Without enhanced bandwidth		
10 GS/s				
Analog bandwidth setting				
Input Frequency	0.5 GHz	0.5 GHz	0.25 GHz	0.02 GHz
10 MHz	6.8 bits	6.5 bits	6.6 bits	6.7 bits
510 MHz	6.8 bits	6.4 bits		

**Table 1-1: Channel input and vertical specifications, all MSO70000/C, DSA/DPO70000B/C, and DPO7000 Series models (cont.)**

5 GS/s						
Analog bandwidth setting						
Input Frequency	0.5 GHz		0.5 GHz	0.25 GHz	0.02 GHz	
10 MHz	6.7 bits		6.5 bits	6.6 bits	6.7 bits	
510 MHz	6.7 bits		6.4 bits			
2.5 GS/s						
Analog bandwidth setting						
Input Frequency	0.5 GHz		0.5 GHz	0.25 GHz	0.02 GHz	
10 MHz	6.5 bits		6.5 bits	6.6 bits	6.7 bits	
510 MHz	6.4 bits		6.4 bits			
Noise, typical						
≥ 4 GHz models						
Without enhanced bandwidth						
Gain setting	MSO72004C, DSA72004C, DPO72004C	MSO71604C, DSA71604C, DPO71604C	MSO71254C, DSA71254C, DPO71254C	MSO70804, DSA70804B, DPO70804B	MSO70604, DSA70604B, DPO70604B	MSO70404, DSA70404B, DPO70404B
10 mV	0.87 mV	0.87 mV	0.67 mV	0.58 mV	0.53 mV	0.50 mV
15 mV	1.06 mV	1.06 mV	0.84 mV	0.74 mV	0.73 mV	0.69 mV
20 mV	1.21 mV	1.21 mV	0.98 mV	0.90 mV	0.86 mV	0.86 mV
30 mV	1.82 mV	1.82 mV	1.49 mV	1.34 mV	1.25 mV	1.25 mV
40 mV	2.29 mV	2.29 mV	1.80 mV	1.76 mV	1.67 mV	1.67 mV
50 mV	2.78 mV	2.78 mV	2.29 mV	2.02 mV	2.02 mV	2.02 mV
60 mV	3.35 mV	3.35 mV	2.78 mV	2.52 mV	2.46 mV	2.46 mV
70 mV	3.92 mV	3.92 mV	3.27 mV	3.02 mV	2.90 mV	2.90 mV
80 mV	4.49 mV	4.49 mV	3.76 mV	3.52 mV	3.34 mV	3.34 mV
90 mV	5.14 mV	5.14 mV	4.25 mV	3.87 mV	3.78 mV	3.78 mV
100 mV	6.48 mV	6.48 mV	4.89 mV	4.50 mV	4.28 mV	4.28 mV
200 mV	11.47 mV	11.47 mV	8.98 mV	8.80 mV	8.36 mV	8.36 mV
250 mV	14.04 mV	14.04 mV	11.07 mV	10.81 mV	10.34 mV	10.34 mV
300 mV	16.61 mV	16.61 mV	13.15 mV	12.82 mV	12.32 mV	12.32 mV
400 mV	21.83 mV	21.83 mV	19.01 mV	17.36 mV	16.91 mV	16.91 mV
450 mV	24.41 mV	24.41 mV	21.30 mV	19.44 mV	18.97 mV	18.97 mV
500 mV	26.99 mV	26.99 mV	23.59 mV	21.51 mV	21.02 mV	21.02 mV

**Table 1-1: Channel input and vertical specifications, all MSO70000/C, DSA/DPO70000B/C, and DPO7000 Series models (cont.)**

	Enhanced bandwidth, sample rates less than 100 GS/s.							
	20 GHz	19 GHz	18 GHz	17 GHz	16 GHz	15 GHz	14 GHz	13 GHz
MSO72004C, MSO71604C, MSO71254C, DSA72004C, DSA71604C, DSA71254C, DPO72004C, DPO71604C, DPO71254C where applicable								
Gain setting								
10 mV	NA	NA	1.09 mV	0.70 mV	0.61 mV	0.59 mV	0.58 mV	0.58 mV
15 mV	NA	NA	1.06 mV	0.93 mV	0.81 mV	0.79 mV	0.77 mV	0.73 mV
20 mV	2.17 mV	1.67 mV	1.34 mV	1.09 mV	0.96 mV	0.92 mV	0.87 mV	0.84 mV
30 mV	3.06 mV	2.35 mV	1.90 mV	1.57 mV	1.36 mV	1.31 mV	1.28 mV	1.26 mV
40 mV	3.84 mV	3.10 mV	2.53 mV	2.08 mV	1.80 mV	1.67 mV	1.63 mV	1.59 mV
50 mV	3.68 mV	3.10 mV	2.61 mV	2.29 mV	2.12 mV	2.02 mV	1.92 mV	1.85 mV
60 mV	4.41 mV	3.70 mV	3.13 mV	2.78 mV	2.56 mV	2.46 mV	2.35 mV	2.27 mV
70 mV	5.15 mV	4.30 mV	3.65 mV	3.27 mV	2.99 mV	2.90 mV	2.79 mV	2.69 mV
80 mV	5.88 mV	4.90 mV	4.16 mV	3.76 mV	3.43 mV	3.34 mV	3.23 mV	3.10 mV
90 mV	6.21 mV	5.31 mV	4.57 mV	4.16 mV	3.76 mV	3.59 mV	3.51 mV	3.39 mV
100 mV	10.86 mV	8.35 mV	7.98 mV	5.32 mV	4.77 mV	4.50 mV	4.26 mV	4.22 mV
200 mV	19.19 mV	15.54 mV	12.66 mV	10.28 mV	9.10 mV	8.70 mV	8.23 mV	7.96 mV
250 mV	21.74 mV	17.87 mV	14.82 mV	12.26 mV	10.88 mV	10.51 mV	9.95 mV	9.62 mV
300 mV	24.29 mV	20.20 mV	16.88 mV	14.24 mV	12.66 mV	12.32 mV	11.68 mV	11.27 mV
400 mV	29.40 mV	24.86 mV	21.17 mV	18.26 mV	16.28 mV	15.98 mV	15.19 mV	15.34 mV
450 mV	31.95 mV	27.20 mV	23.29 mV	20.25 mV	18.06 mV	17.80 mV	16.92 mV	17.09 mV
500 mV	34.50 mV	29.53 mV	25.41 mV	22.23 mV	19.85 mV	19.61 mV	18.66 mV	18.83 mV

**Table 1-1: Channel input and vertical specifications, all MSO70000/C, DSA/DPO70000B/C, and DPO7000 Series models (cont.)**

MSO72004C, MSO71604C, MSO71254C, DSA72004C, DSA71604C, DSA71254C, DPO72004C, DPO71604C, DPO71254C where applicable	12.5 GHz	12 GHz	11 GHz	10 GHz	9 GHz	8 GHz	7 GHz	6 GHz
Gain setting								
10 mV	0.55 mV	0.53 mV	0.51 mV	0.49 mV	0.46 mV	0.45 mV	0.43 mV	0.40 mV
15 mV	0.72 mV	0.71 mV	0.68 mV	0.65 mV	0.63 mV	0.60 mV	0.57 mV	0.54 mV
20 mV	0.82 mV	0.81 mV	0.78 mV	0.75 mV	0.71 mV	0.67 mV	0.63 mV	0.60 mV
30 mV	1.24 mV	1.20 mV	1.16 mV	1.10 mV	1.03 mV	0.99 mV	0.95 mV	0.89 mV
40 mV	1.55 mV	1.49 mV	1.43 mV	1.39 mV	1.33 mV	1.27 mV	1.18 mV	1.10 mV
50 mV	1.80 mV	1.78 mV	1.72 mV	1.65 mV	1.57 mV	1.48 mV	1.41 mV	1.31 mV
60 mV	2.23 mV	2.18 mV	2.12 mV	1.99 mV	1.89 mV	1.79 mV	1.71 mV	1.60 mV
70 mV	2.67 mV	2.58 mV	2.51 mV	2.34 mV	2.21 mV	2.11 mV	2.01 mV	1.88 mV
80 mV	3.10 mV	2.98 mV	2.90 mV	2.78 mV	2.61 mV	2.49 mV	2.37 mV	2.25 mV
90 mV	3.35 mV	3.27 mV	3.14 mV	3.02 mV	2.86 mV	2.74 mV	2.61 mV	2.45 mV
100 mV	4.09 mV	4.05 mV	3.94 mV	3.73 mV	3.55 mV	3.36 mV	3.18 mV	2.99 mV
200 mV	7.76 mV	7.47 mV	7.16 mV	6.93 mV	6.55 mV	6.33 mV	5.94 mV	5.51 mV
250 mV	9.37 mV	9.03 mV	8.68 mV	8.35 mV	7.92 mV	7.63 mV	7.20 mV	6.68 mV
300 mV	10.98 mV	10.58 mV	10.19 mV	9.76 mV	9.30 mV	8.93 mV	8.46 mV	7.84 mV
400 mV	15.16 mV	14.79 mV	14.29 mV	13.60 mV	13.01 mV	12.40 mV	11.81 mV	11.07 mV
450 mV	16.88 mV	16.47 mV	15.93 mV	15.12 mV	14.50 mV	13.80 mV	13.17 mV	12.34 mV
500 mV	18.60 mV	18.15 mV	17.56 mV	16.65 mV	15.98 mV	15.20 mV	14.53 mV	13.61 mV

**Table 1-1: Channel input and vertical specifications, all MSO70000/C, DSA/DPO70000B/C, and DPO7000 Series models (cont.)**

MSO72004C, MSO71604C, MSO71254C, DSA72004C, DSA71604C, DSA71254C, DPO72004C, DPO71604C, DPO71254C where applicable	5 GHz	4 GHz	3 GHz	2 GHz	1 GHz	500 MHz
Gain setting						
10 mV	0.37 mV	0.34 mV	0.31 mV	0.26 mV	0.20 mV	0.17 mV
15 mV	0.51 mV	0.48 mV	0.44 mV	0.39 mV	0.34 mV	0.27 mV
20 mV	0.57 mV	0.53 mV	0.48 mV	0.44 mV	0.37 mV	0.31 mV
30 mV	0.84 mV	0.77 mV	0.69 mV	0.61 mV	0.52 mV	0.44 mV
40 mV	1.06 mV	0.98 mV	0.88 mV	0.78 mV	0.66 mV	0.57 mV
50 mV	1.22 mV	1.10 mV	1.03 mV	0.91 mV	0.76 mV	0.68 mV
60 mV	1.49 mV	1.35 mV	1.24 mV	1.09 mV	0.91 mV	0.82 mV
70 mV	1.76 mV	1.59 mV	1.45 mV	1.27 mV	1.06 mV	0.95 mV
80 mV	2.08 mV	1.96 mV	1.76 mV	1.51 mV	1.22 mV	1.10 mV
90 mV	2.29 mV	2.08 mV	1.88 mV	1.63 mV	1.35 mV	1.22 mV
100 mV	2.77 mV	2.65 mV	2.38 mV	2.02 mV	1.57 mV	1.31 mV
200 mV	5.28 mV	4.90 mV	4.43 mV	4.12 mV	3.42 mV	2.88 mV
250 mV	6.34 mV	5.83 mV	5.33 mV	4.87 mV	4.07 mV	3.49 mV
300 mV	7.40 mV	6.77 mV	6.22 mV	5.63 mV	4.72 mV	4.10 mV
400 mV	10.37 mV	9.51 mV	8.83 mV	7.86 mV	6.63 mV	5.86 mV
450 mV	11.53 mV	10.54 mV	9.81 mV	8.68 mV	7.34 mV	6.53 mV
500 mV	12.68 mV	11.57 mV	10.80 mV	9.51 mV	8.06 mV	7.20 mV



**Table 1-1: Channel input and vertical specifications, all MSO70000/C, DSA/DPO70000B/C, and DPO7000 Series models (cont.)**

MSO70804, MSO70604, MSO70404, DSA70804B, DSA70604B, DSA70404B, DPO70804B, DPO70604B, DPO70404B, where applicable	8 GHz	7 GHz	6 GHz	5 GHz	4 GHz	3 GHz	2 GHz	1 GHz	500 MHz
Gain setting									
10 mV	0.54 mV	0.51 mV	0.48 mV	0.45 mV	0.42 mV	0.40 mV	0.37 mV	0.32 mV	0.24 mV
15 mV	0.73 mV	0.69 mV	0.64 mV	0.60 mV	0.55 mV	0.50 mV	0.46 mV	0.39 mV	0.32 mV
20 mV	0.86 mV	0.80 mV	0.77 mV	0.72 mV	0.68 mV	0.60 mV	0.55 mV	0.46 mV	0.40 mV
30 mV	1.34 mV	1.25 mV	1.16 mV	1.07 mV	0.98 mV	0.89 mV	0.78 mV	0.67 mV	0.57 mV
40 mV	1.67 mV	1.58 mV	1.50 mV	1.41 mV	1.32 mV	1.14 mV	1.01 mV	0.88 mV	0.76 mV
50 mV	1.94 mV	1.85 mV	1.76 mV	1.67 mV	1.58 mV	1.41 mV	1.23 mV	1.01 mV	0.92 mV
60 mV	2.41 mV	2.29 mV	2.17 mV	2.04 mV	1.91 mV	1.70 mV	1.50 mV	1.23 mV	1.10 mV
70 mV	2.87 mV	2.73 mV	2.58 mV	2.41 mV	2.23 mV	1.99 mV	1.76 mV	1.44 mV	1.28 mV
80 mV	3.34 mV	3.17 mV	2.99 mV	2.77 mV	2.55 mV	2.29 mV	2.02 mV	1.65 mV	1.45 mV
90 mV	3.70 mV	3.56 mV	3.34 mV	3.12 mV	2.90 mV	2.55 mV	2.24 mV	1.89 mV	1.67 mV
100 mV	4.28 mV	3.99 mV	3.83 mV	3.46 mV	3.38 mV	3.00 mV	2.59 mV	2.03 mV	1.65 mV
200 mV	8.36 mV	8.09 mV	7.48 mV	6.95 mV	6.60 mV	5.80 mV	5.08 mV	4.19 mV	3.66 mV
250 mV	10.23 mV	9.86 mV	9.20 mV	8.61 mV	8.18 mV	7.21 mV	6.32 mV	5.20 mV	4.61 mV
300 mV	12.10 mV	11.62 mV	10.92 mV	10.27 mV	9.75 mV	8.62 mV	7.55 mV	6.21 mV	5.56 mV
400 mV	16.61 mV	15.90 mV	14.99 mV	14.18 mV	12.97 mV	11.50 mV	10.07 mV	8.28 mV	7.50 mV
450 mV	18.57 mV	17.75 mV	16.78 mV	15.91 mV	14.55 mV	12.92 mV	11.31 mV	9.29 mV	8.46 mV
500 mV	20.53 mV	19.60 mV	18.58 mV	17.65 mV	16.13 mV	14.34 mV	12.55 mV	10.31 mV	9.41 mV

**Table 1-1: Channel input and vertical specifications, all MSO70000/C, DSA/DPO70000B/C, and DPO7000 Series models (cont.)**

MSO72004C, DSA72004C, DPO72004C	Enhanced bandwidth, at 100 GS/s. (For all settings below 17 GHz, the noise specifications at 100 GS/s are the same as for sample rates less than 100 GS/s.)					
Gain setting	20 GHz	19 GHz	18 GHz	17 GHz		
10 mV	N/A	N/A	0.665 mV	0.981 mV		
15 mV	N/A	N/A	0.8835 mV	0.954 mV		
20 mV	1.736 mV	1.4195 mV	1.0355 mV	1.206 mV		
30 mV	2.448 mV	1.9975 mV	1.4195 mV	1.71 mV		
40 mV	3.072 mV	2.635 mV	1.976 mV	2.277 mV		
50 mV	2.944 mV	2.635 mV	2.175 mV	2.349 mV		
60 mV	3.528 mV	3.145 mV	2.641 mV	2.817 mV		
70 mV	4.12 mV	3.655 mV	3.1065 mV	3.285 mV		
80 mV	4.704 mV	4.165 mV	3.572 mV	3.744 mV		
90 mV	4.968 mV	4.5135 mV	3.952 mV	4.113 mV		
100 mV	8.688 mV	7.095 mV	5.054 mV	7.182 mV		
200 mV	15.352 mV	13.209 mV	9.766 mV	11.394 mV		
250 mV	17.392 mV	15.1895 mV	11.647 mV	13.338 mV		
300 mV	19.432 mV	17.17 mV	13.528 mV	15.192 mV		
400 mV	23.52 mV	21.131 mV	17.347 mV	19.053 mV		
450 mV	25.56 mV	23.12 mV	19.235 mV	20.961 mV		
500 mV	27.6 mV	25.1005 mV	21.1185 mV	22.869 mV		
Noise, typical < 4 GHz models DPO7354	Nondeterministic fluctuation in the displayed signal.					
Enhanced bandwidth 40 GS/s						
Step gain	3.5 GHz	3.0 GHz	2.5 GHz	2.0 GHz	1.0 GHz	0.5 GHz
500 mV	23.5 mV	20.2 mV	18.9 mV	16.5 mV	12.2 mV	9.7 mV
200 mV	10.9 mV	9.2 mV	8.1 mV	7.05 mV	5.3 mV	4.1 mV
100 mV	6.6 mV	5.4 mV	4.9 mV	4.2 mV	3.05 mV	2.35 mV
50 mV	2.35 mV	2.1 mV	1.9 mV	1.7 mV	1.3 mV	1.0 mV
20 mV	1.03 mV	0.89 mV	0.811 mV	0.72 mV	0.53 mV	0.43 mV
10 mV	0.61 mV	0.55 mV	0.47 mV	0.42 mV	0.3 mV	0.23 mV
5 mV	0.41 mV	0.415 mV	0.41 mV	0.4 mV	0.21 mV	0.16 mV
2 mV	0.19 mV	0.19 mV	0.19 mV	0.19 mV	0.185 mV	0.185 mV
1 mV	0.12 mV	0.12 mV	0.12 mV	0.12 mV	0.12 mV	0.12 mV

**Table 1-1: Channel input and vertical specifications, all MSO70000/C, DSA/DPO70000B/C, and DPO7000 Series models (cont.)**

20 GS/s						
Step gain	3.5 GHz	3.0 GHz	2.5 GHz	2.0 GHz	1.0 GHz	0.5 GHz
500 mV	24.3 mV	21.6 mV	19.1 mV	16.7 mV	12.4 mV	9.9 mV
200 mV	11.1 mV	9.3 mV	8.4 mV	7.1 mV	5.35 mV	4.2 mV
100 mV	6.65 mV	5.5 mV	4.95 mV	4.25 mV	3.1 mV	2.4 mV
50 mV	2.45 mV	2.2 mV	1.95 mV	1.8 mV	1.35 mV	1.1 mV
20 mV	1.055 mV	0.93 mV	0.83 mV	0.75 mV	0.55 mV	0.435 mV
10 mV	0.625 mV	0.55 mV	0.475 mV	0.425 mV	0.31 mV	0.24 mV
5 mV	0.415 mV	0.415	0.415 mV	0.415 mV	0.215 mV	0.16 mV
2 mV	0.19 mV	0.19 mV	0.19 mV	0.19 mV	0.185 mV	0.185 mV
1 mV	0.12 mV	0.12 mV	0.12 mV	0.12 mV	0.12 mV	0.12 mV
10 GS/s						
Step gain	3.5 GHz	3.0 GHz	2.5 GHz	2.0 GHz	1.0 GHz	0.5 GHz
500 mV	25.8 mV	22.2 mV	20.0 mV	17.7 mV	13.2 mV	10.4 mV
200 mV	11.7 mV	9.9 mV	8.7 mV	7.5 mV	5.5 mV	4.3 mV
100 mV	6.9 mV	5.6 mV	5.0 mV	4.3 mV	3.2 mV	2.4 mV
50 mV	2.6 mV	2.3 mV	2.05 mV	1.85 mV	1.4 mV	1.15 mV
20 mV	1.11 mV	0.99 mV	0.87 mV	0.77 mV	0.58 mV	0.45 mV
10 mV	0.65 mV	0.55 mV	0.49 mV	0.43 mV	0.32 mV	0.25 mV
5 mV	0.415 mV	0.42 mV	0.42 mV	0.42 mV	0.22 mV	0.16 mV
2 mV	0.19 mV	0.19 mV	0.19 mV	0.19 mV	0.185 mV	0.185 mV
1 mV	0.12 mV	0.12 mV	0.12 mV	0.12 mV	0.12 mV	0.12 mV
Without enhanced bandwidth						
40 GS/s						
Step gain	2.5 GHz	0.5 GHz	0.25 GHz	0.02 GHz		
500 mV	23.5 mV	16.3 mV	14.5 mV	14.0 mV		
200 mV	10.7 mV	6.9 mV	6.1 mV	5.8 mV		
100 mV	6.3 mV	3.8 mV	3.2 mV	3.0 mV		
50 mV	2.4 mV	1.75 mV	1.6 mV	1.5 mV		
20 mV	1.07 mV	0.7 mV	0.63 mV	0.595 mV		
10 mV	0.61 mV	0.38 mV	0.32 mV	0.3 mV		
5 mV	0.41 mV	0.24 mV	0.18 mV	0.151 mV		
2 mV	0.19 mV	0.18 mV	0.115 mV	0.065 mV		
1 mV	0.12 mV	0.12 mV	0.115 mV	0.045 mV		

**Table 1-1: Channel input and vertical specifications, all MSO70000/C, DSA/DPO70000B/C, and DPO7000 Series models (cont.)**

20 GS/s				
Step gain	2.5 GHz	0.5 GHz	0.25 GHz	0.02 GHz
500 mV	23.0 mV	16.3 mV	14.5 mV	14.0 mV
200 mV	10.5 mV	6.9 mV	6.1 mV	5.8 mV
100 mV	6.25 mV	3.8 mV	3.2 mV	3.0 mV
50 mV	2.4 mV	1.75 mV	1.6 mV	1.5 mV
20 mV	1.04 mV	0.7 mV	0.63 mV	0.595 mV
10 mV	0.605 mV	0.38 mV	0.32 mV	0.3 mV
5 mV	0.4 mV	0.24 mV	0.18 mV	0.151 mV
2 mV	0.19 mV	0.18 mV	0.115 mV	0.065 mV
1 mV	0.12 mV	0.12 mV	0.115 mV	0.045 mV
10 GS/s				
Step gain	2.5 GHz	0.5 GHz	0.25 GHz	0.02 GHz
500 mV	22.8 mV	16.3 mV	14.5 mV	14.0 mV
200 mV	10.4 mV	6.9 mV	6.1 mV	5.8 mV
100 mV	6.15 mV	3.8 mV	3.2 mV	3.0 mV
50 mV	2.4 mV	1.75 mV	1.6 mV	1.5 mV
20 mV	1.035 mV	0.7 mV	0.63 mV	0.595 mV
10 mV	0.59 mV	0.38 mV	0.32 mV	0.3 mV
5 mV	0.395 mV	0.24 mV	0.18 mV	0.151 mV
2 mV	0.19 mV	0.18 mV	0.115 mV	0.065 mV
1 mV	0.12 mV	0.12 mV	0.115 mV	0.045 mV
DPO7254				
Enhanced bandwidth				
40 GS/s				
Step gain	2.5 GHz	2.0 GHz	1.0 GHz	0.5 GHz
500 mV	19.7 mV	16.2 mV	12.1 mV	9.9 mV
200 mV	8.71 mV	6.97 mV	4.97 mV	4.0 mV
100 mV	5.23 mV	4.25 mV	2.97 mV	2.36 mV
50 mV	2.0 mV	1.64 mV	1.23 mV	1.03 mV
20 mV	0.866 mV	0.707 mV	0.528 mV	0.431 mV
10 mV	0.523 mV	0.425 mV	0.297 mV	0.236 mV
5 mV	0.343 mV	0.349 mV	0.21 mV	0.154 mV
2 mV	0.135 mV	0.135 mV	0.135 mV	0.135 mV
1 mV	0.095 mV	0.095 mV	0.095 mV	0.095 mV

**Table 1-1: Channel input and vertical specifications, all MSO70000/C, DSA/DPO70000B/C, and DPO7000 Series models (cont.)**

20 GS/s				
Step gain	2.5 GHz	2.0 GHz	1.0 GHz	0.5 GHz
500 mV	19.5 mV	16.1 mV	12.0 mV	9.8 mV
200 mV	8.7 mV	7.05 mV	5.1 mV	4.0 mV
100 mV	5.15 mV	4.2 mV	2.95 mV	2.35 mV
50 mV	2.0 mV	1.65 mV	1.25 mV	1.05 mV
20 mV	0.855 mV	0.71 mV	0.52 mV	0.425 mV
10 mV	0.515 mV	0.42 mV	0.295 mV	0.235 mV
5 mV	0.34 mV	0.345 mV	0.21 mV	0.155 mV
2 mV	0.135 mV	0.135 mV	0.135 mV	0.135 mV
1 mV	0.095 mV	0.095 mV	0.095 mV	0.095 mV
10 GS/s				
Step gain	2.5 GHz	2.0 GHz	1.0 GHz	0.5 GHz
500 mV	20.2 mV	16.7 mV	12.5 mV	10.3 mV
200 mV	8.9 mV	7.3 mV	5.3 mV	4.16 mV
100 mV	5.3 mV	4.3 mV	3.05 mV	2.4 mV
50 mV	2.1 mV	1.7 mV	1.3 mV	1.1 mV
20 mV	0.88 mV	0.74 mV	0.55 mV	0.435 mV
10 mV	0.52 mV	0.43 mV	0.3 mV	0.24 mV
5 mV	0.345 mV	0.33 mV	0.21 mV	0.155 mV
2 mV	0.135 mV	0.135 mV	0.135 mV	0.135 mV
1 mV	0.095 mV	0.095 mV	0.095 mV	0.095 mV
Without enhanced bandwidth				
40 GS/s				
Step gain	2.5 GHz	0.5 GHz	0.25 GHz	0.02 GHz
500 mV	22.7 mV	16.4 mV	15.0 mV	14.5 mV
200 mV	9.84 mV	6.97 mV	6.2 mV	5.8 mV
100 mV	5.89 mV	3.74 mV	3.2 mV	2.9 mV
50 mV	2.31 mV	1.69 mV	1.55 mV	1.45 mV
20 mV	0.964 mV	0.697 mV	0.63 mV	0.59 mV
10 mV	0.574 mV	0.379 mV	0.325 mV	0.295 mV
5 mV	0.4 mV	0.231 mV	0.175 mV	0.145 mV
2 mV	0.19 mV	0.195 mV	0.12 mV	0.065 mV
1 mV	0.12 mV	0.12 mV	0.12 mV	0.045 mV

**Table 1-1: Channel input and vertical specifications, all MSO70000/C, DSA/DPO70000B/C, and DPO7000 Series models (cont.)**

20 GS/s				
Step gain	2.5 GHz	0.5 GHz	0.25 GHz	0.02 GHz
500 mV	21.8 mV	16.0 mV	15.0 mV	14.5 mV
200 mV	9.6 mV	6.8 mV	6.2 mV	5.8 mV
100 mV	5.7 mV	3.65 mV	3.2 mV	2.9 mV
50 mV	2.25 mV	1.65 mV	1.55 mV	1.45 mV
20 mV	0.94 mV	0.68 mV	0.63 mV	0.49 mV
10 mV	0.56 mV	0.37 mV	0.325 mV	0.295 mV
5 mV	0.38 mV	0.225 mV	0.175 mV	0.145 mV
2 mV	0.19 mV	0.195 mV	0.12 mV	0.065 mV
1 mV	0.12 mV	0.12 mV	0.12 mV	0.045 mV
10 GS/s				
Step gain	2.5 GHz	0.5 GHz	0.25 GHz	0.02 GHz
500 mV	21.8 mV	16.0 mV	15.0 mV	15.5 mV
200 mV	9.6 mV	6.8 mV	6.2 mV	5.8 mV
100 mV	5.65 mV	3.65 mV	3.2 mV	2.9 mV
50 mV	2.2 mV	1.65 mV	1.55 mV	1.45 mV
20 mV	0.94 mV	0.68 mV	0.63 mV	0.59 mV
10 mV	0.56 mV	0.37 mV	0.325 mV	0.295 mV
5 mV	0.37 mV	0.225 mV	0.175 mV	0.145 mV
2 mV	0.19 mV	0.195 mV	0.12 mV	0.065 mV
1 mV	0.12 mV	0.12 mV	0.12 mV	0.045 mV

DPO7104

20 GS/s

	Enhanced bandwidth		Without enhanced bandwidth			
Step gain	1.0 GHz	0.5 GHz	1.0 GHz	0.5 GHz	0.025 GHz	0.02 GHz
500 mV	13.2 mV	9.7 mV	16.2 mV	15.2 mV	14.0 mV	13.3 mV
200 mV	5.57 mV	3.93 mV	6.8 mV	6.3 mV	5.7 mV	5.3 mV
100 mV	3.27 mV	2.24 mV	3.7 mV	3.4 mV	3.0 mV	2.8 mV
50 mV	1.36 mV	0.98 mV	1.7 mV	1.6 mV	1.45 mV	1.4 mV
20 mV	0.574 mV	0.408 mV	0.7 mV	0.64 mV	0.58 mV	0.55 mV
10 mV	0.328 mV	0.232 mV	0.38 mV	0.35 mV	0.3 mV	0.285 mV
5 mV	0.229 mV	0.16 mV	0.25 mV	0.21 mV	0.17 mV	0.14 mV
2 mV	0.135 mV	0.135 mV	0.15 mV	0.15 mV	0.1 mV	0.065 mV
1 mV	0.095 mV	0.095 mV	0.11 mV	0.11 mV	0.11 mV	0.04 mV

**Table 1-1: Channel input and vertical specifications, all MSO70000/C, DSA/DPO70000B/C, and DPO7000 Series models (cont.)**

10 GS/s						
	Enhanced bandwidth		Without enhanced bandwidth			
Step gain	1.0 GHz	0.5 GHz	1.0 GHz	0.5 GHz	0.025 GHz	0.02 GHz
500 mV	14.7 mV	10.3 mV	16.2 mV	15.2 mV	14.0 mV	13.3 mV
200 mV	6.09 mV	4.34 mV	6.8 mV	6.3 mV	5.7 mV	5.3 mV
100 mV	3.55 mV	2.38 mV	3.7 mV	3.4 mV	3.0 mV	2.8 mV
50 mV	1.53 mV	1.05 mV	1.7 mV	1.6 mV	1.45 mV	1.4 mV
20 mV	0.625 mV	0.441 mV	0.7 mV	0.64 mV	0.58 mV	0.55 mV
10 mV	0.350 mV	0.24 mV	0.38 mV	0.35 mV	0.3 mV	0.285 mV
5 mV	0.236 mV	0.16 mV	0.25 mV	0.21 mV	0.17 mV	0.14 mV
2 mV	0.135 mV	0.135 mV	0.15 mV	0.15 mV	0.1 mV	0.065 mV
1 mV	0.095 mV	0.095 mV	0.11 mV	0.11 mV	0.11 mV	0.04 mV

5 GS/s						
	Enhanced bandwidth		Without enhanced bandwidth			
Step gain	1.0 GHz	0.5 GHz	1.0 GHz	0.5 GHz	0.025 GHz	0.02 GHz
500 mV	15.9 mV	10.7 mV	16.2 mV	16.2 mV	14.0 mV	13.3 mV
200 mV	6.71 mV	4.48 mV	6.8 mV	6.3 mV	5.7 mV	5.3 mV
100 mV	3.74 mV	2.46 mV	3.7 mV	3.4 mV	3.0 mV	2.8 mV
50 mV	1.68 mV	1.1 mV	1.7 mV	1.6 mV	1.45 mV	1.4 mV
20 mV	0.682 mV	0.454 mV	0.7 mV	0.64 mV	0.58 mV	0.550 mV
10 mV	0.378 mV	0.247 mV	0.38 mV	0.35 mV	0.3 mV	0.285 mV
5 mV	0.241 mV	0.16 mV	0.25 mV	0.21 mV	0.17 mV	0.14 mV
2 mV	0.135 mV	0.135 mV	0.15 mV	0.15 mV	0.1 mV	0.065 mV
1 mV	0.095 mV	0.095 mV	0.11 mV	0.11 mV	0.11 mV	0.04 mV

DPO7054

10 GS/s						
	Enhanced bandwidth		Without enhanced bandwidth			
Step gain	0.5 GHz		0.5 GHz	0.025 GHz	0.02 GHz	
500 mV	11.9 mV		15.1 mV	14.0 mV	13.2 mV	
200 mV	5.0 mV		6.35 mV	5.7 mV	5.4 mV	
100 mV	2.75 mV		3.4 mV	2.95 mV	2.75 mV	
50 mV	1.2 mV		1.6 mV	1.45 mV	1.38 mV	
20 mV	0.5 mV		0.645 mV	0.58 mV	0.55 mV	
10 mV	0.28 mV		0.34 mV	0.3 mV	0.277 mV	
5 mV	0.185 mV		0.21 mV	0.165 mV	0.141 mV	
2 mV	0.11 mV		0.13 mV	0.1 mV	0.062 mV	
1 mV	0.09 mV		0.096 mV	0.097 mV	0.04 mV	

**Table 1-1: Channel input and vertical specifications, all MSO70000/C, DSA/DPO70000B/C, and DPO7000 Series models (cont.)**

5 GS/s				
	Enhanced bandwidth	Without enhanced bandwidth		
Step gain	0.5 GHz	0.5 GHz	0.025 GHz	0.02 GHz
500 mV	13.0 mV	15.1 mV	14.0 mV	13.2 mV
200 mV	5.35 mV	6.35 mV	5.7 mV	5.4 mV
100 mV	2.95 mV	3.4 mV	2.95 mV	2.75 mV
50 mV	1.35 mV	1.6 mV	1.45 mV	1.38 mV
20 mV	0.54 mV	0.645 mV	0.58 mV	0.55 mV
10 mV	0.3 mV	0.34 mV	0.3 mV	0.277 mV
5 mV	0.19	0.21 mV	0.165 mV	0.141 mV
2 mV	0.11 mV	0.13 mV	0.1 mV	0.062 mV
1 mV	0.09 mV	0.096 mV	0.097 mV	0.04 mV
2.5 GS/s				
	Enhanced bandwidth	Without enhanced bandwidth		
Step gain	0.5 GHz	0.5 GHz	0.025 GHz	0.02 GHz
500 mV	15.0 mV	15.1 mV	14.0 mV	13.2 mV
200 mV	6.2 mV	6.35 mV	5.7 mV	5.4 mV
100 mV	3.35 mV	3.4 mV	2.95 mV	2.75 mV
50 mV	1.56 mV	1.6 mV	1.45 mV	1.38 mV
20 mV	0.63 mV	0.645 mV	0.58 mV	0.55 mV
10 mV	0.375 mV	0.34 mV	0.3 mV	0.277 mV
5 mV	0.205 mV	0.21 mV	0.165 mV	0.141 mV
2 mV	0.11 mV	0.13 mV	0.1 mV	0.062 mV
1 mV	0.09 mV	0.096 mV	0.097 mV	0.04 mV
Channel-to-channel crosstalk (channel isolation)				
≥ 4 GHz models, typical	Input frequency range (up to the rated bandwidth). Assumes two channels with the same scale and bandwidth settings		Isolation	
	0 to 10 GHz		≥ 120:1	
	> 10 GHz to 12 GHz		≥ 80:1	
	> 12 GHz to 15 GHz		≥ 50:1	
	> 15 GHz to 20 GHz		≥ 25:1	
< 4 GHz models, typical	RMS voltage ratio of ≥ 100:1 at ≤ 100 MHz and ≥ 30:1 at > 100 MHz up to 2.5 GHz, and ≥ 20:1 above 2.5 GHz			
Delay between channels, full bandwidth, equivalent time, typical, ≥ 4 GHz models	≤ 100 ps between any two channels with the same scale and coupling settings. ≤ 50 ps delay change when enabling and disabling Channel Equalization (DSP matching).			
Delay between channels, typical, < 4 GHz models	≤ 100 ps between any two channels with the same scale and coupling settings with input impedance set to 50Ω, DC coupling and scale set at or above 10 mV/div.			



**Table 1-1: Channel input and vertical specifications, all MSO70000/C, DSA/DPO70000B/C, and DPO7000 Series models (cont.)**

Internal probe power, < 4 GHz models	50 W maximum		
Probe power per probe < 4 GHz models	<i>Voltage</i>	<i>Maximum Amperage</i>	<i>Voltage Tolerance</i>
	5 V	50 mA	± 5%
	12 V	2 A	±10%

**Table 1-2: Horizontal and acquisition system specifications, all MSO70000/C, DSA/DPO70000B/C, and DPO7000 Series models**

<b>Characteristic</b>	<b>Description</b>		
Real-time sample rate range	<i>Number of channels acquired</i>	<i>Sample rate, maximum</i> (Standard) (Option 2SR)	
MSO70804, MSO70604, MSO70404, DSA70804B, DSA70604B, DSA70404B, DPO70804B, DPO70604B, DPO70404B	All channels	Up to 25 GS/s	
MSO72004C, MSO71604C, MSO71254C, DSA72004C, DSA71604C, DSA71254C, DPO72004C, DPO71604C, DPO71254C	All channels	Up to 50 GS/s	
	Two channels	Up to 100 GS/s	
DPO7354 and DPO7254	1	40 GS/s	
	2	20 GS/s	
	3 or 4	10 GS/s	
DPO7104	1	20 GS/s	
	2	10 GS/s	
	3 or 4	5 GS/s	
DPO7054	1	10 GS/s	20 GS/s
	2	5 GS/s	10 GS/s
	3 or 4	2.5 GS/s	5 GS/s
Equivalent-time sample rate or interpolated waveform rate range	Equivalent-time acquisition can be enabled or disabled. When disabled, waveforms are interpolated at the fastest time base settings.		
≥ 4 GHz models	Up to 5 TS/s and 0.2 ps trigger placement resolution		
< 4 GHz models	Up to 4 TS/s		
Maximum record length, sample mode, ≥ 4 GHz models	The maximum record length depends on the installed record length options. Maximum record length is less in serial trigger mode, hi-res mode, or when using the FIR filter.		
	Standard on MSO70000/C Series, DSA70000B/C Series, and DPO70000B/C Series	12,500,000 points	
	Option 2XL installed, standard on DSA70000/B Series	31,250,000 points	
	Option 5XL installed	62,500,000 points (all channels)	
	Option 10XL installed	125,000,000 points (all channels)	
	Option 20XL installed	250,000,000 points (all channels)	

**Table 1-2: Horizontal and acquisition system specifications, all MSO70000/C, DSA/DPO70000B/C, and DPO7000 Series models (cont.)**

<b>Characteristic</b>	<b>Description</b>	
Maximum record length, sample mode, < 4 GHz models	The maximum record length depends on the number of active channels and the record length options installed. Maximum record length is less in serial trigger mode, hi-res mode or when using the FIR filter.	
Standard, DPO7354 and DPO7254	10 GS/s	12,500,000 points (3 or 4 channels)
	20 GS/s or less	25,000,000 points (2 channels)
	40 GS/s or less	50,000,000 points (1 channel)
DPO7104	5 GS/s	12,500,000 points (3 or 4 channels)
	10 GS/s or less	25,000,000 points (2 channels)
	20 GS/s or less	50,000,000 points (1 channel)
DPO7054	2.5 GS/s	12,500,000 points (3 or 4 channels)
	5 GS/s or less	25,000,000 points (2 channels)
	10 GS/s or less	50,000,000 points (1 channel)
Option 2RL installed, DPO7354 and DPO7254	10 GS/s	25,000,000 points (3 or 4 channels)
	20 GS/s or less	50,000,000 points (2 channels only)
	40 GS/s or less	125,000,000 points (1 channel only)
DPO7104	5 GS/s	25,000,000 points (3 or 4 channels)
	10 GS/s or less	50,000,000 points (2 channels only)
	20 GS/s or less	125,000,000 points (1 channel only)
DPO7054	2.5 GS/s	25,000,000 points (3 or 4 channels)
	5 GS/s or less	50,000,000 points (2 channels only)
	10 GS/s or less	125,000,000 points (1 channel only)
Option 5RL installed, DPO7354 and DPO7254	10 GS/s	50,000,000 points (3 or 4 channels)
	20 GS/s or less	125,000,000 points (2 channels only)
	40 GS/s or less	250,000,000 points (1 channel only)
DPO7104	5 GS/s	50,000,000 points (3 or 4 channels)
	10 GS/s or less	125,000,000 points (2 channels only)
	20 GS/s or less	250,000,000 points (1 channel only)
DPO7054	2.5 GS/s	50,000,000 points (3 or 4 channels)
	5 GS/s or less	125,000,000 points (2 channels only)
	10 GS/s or less	250,000,000 points (1 channel only)
Option 10RL installed, DPO7354 and DPO7254	10 GS/s	125,000,000 points (3 or 4 channels)
	20 GS/s or less	250,000,000 points (2 channels only)
	40 GS/s or less	500,000,000 points (1 channel only)
Maximum record length, HiRes mode	Half the record length of sample mode	
Seconds/division range		
≥ 4 GHz models	Fastest sweep speed is 20 ps per division	
< 4 GHz models	Fastest sweep speed is 25 ps per division	
Acquisition update rate, typical		
≥ 4 GHz models	Fast Acquisition on: 300,000 waveforms per second maximum	
< 4 GHz models	Fast Acquisition on: 250,000 waveforms per second maximum	

**Table 1-2: Horizontal and acquisition system specifications, all MSO70000/C, DSA/DPO70000B/C, and DPO7000 Series models (cont.)**

Characteristic	Description
Time base delay time range	5 ns to 250 s
Internal time-base reference frequency	10 MHz Electronically adjustable over about $\pm 5$ ppm.
✓ Long term sample rate accuracy	
< 4 GHz models	$\pm 2.5$ ppm initial accuracy. Aging < 1 ppm per year. Applies only when using the internal reference.
$\geq 4$ GHz models	$\pm 1.5$ ppm initial accuracy. Aging < 1 ppm per year. Applies only when using the internal reference.
Aperture uncertainty, typical	
$\geq 4$ GHz models	<p>Measured at the maximum BWE enabled bandwidth.</p> <p>Total:</p> <ul style="list-style-type: none"> <li>&lt;250 fs rms for record durations less than 10 <math>\mu</math>s</li> <li>&lt;350 fs rms for record durations less than 100 <math>\mu</math>s</li> <li>&lt;650 fs rms for record durations less than 1 ms</li> <li>&lt;15 parts/trillion for record durations less than 60 s</li> </ul> <p>&lt;2 ps peak-to-peak for record durations less than 10 <math>\mu</math>s                      &lt;3 ps peak-to-peak for record durations less than 100 <math>\mu</math>s                      &lt;4 ps peak-to-peak for record durations less than 1 ms</p> <p>This assumes either internal reference, or external reference in low (stable) mode. For external reference in high (tracking) mode, the input reference must be low noise, and the edge slew rate must exceed 1.5 V/ns to achieve the above approximate jitter results. For the general case, external reference in high (tracking) mode, the specification is:</p> <ul style="list-style-type: none"> <li>&lt;250 fs rms for record durations less than 2 <math>\mu</math>s</li> </ul> <p>You can approach the performance of internal reference using a clean reference signal with input slew rate exceeding 1.5 V/ns. This is most easily achieved either with a square wave meeting that slew rate or using a 100 MHz sine wave (<math>\approx 2 V_{p-p}</math>). This is required for the best possible performance in synchronous sampling applications.</p>
<4 GHz models	<p>Total:</p> <ul style="list-style-type: none"> <li>&lt;1 ps rms for record durations less than 10 <math>\mu</math>s.</li> <li>&lt;2.5 ps rms for record durations less than 30 ms.</li> <li>&lt;65 parts/trillion for record durations less than 10 s.</li> </ul>

**Table 1-2: Horizontal and acquisition system specifications, all MSO70000/C, DSA/DPO70000B/C, and DPO7000 Series models (cont.)**

Characteristic	Description
Jitter noise floor, typical, $\geq 4$ GHz models	Applies to time periods as long as 10.0 $\mu$ s. Typical jitter noise floor is measured at the maximum, BWE enabled bandwidth:
	MSO72004C, DSA72004C, DPO72004C at 20 GHz 400 fs
	MSO72004C, DSA72004C, DPO72004C, MSO71604C, DSA71604C, DPO71604C at 16 GHz 300 fs
	MSO71254C, DSA71254C, DPO71254C at 12.5 GHz 300 fs
	MSO70804, DSA70804B, DPO70804B MSO70604, DSA70604B, DPO70604B MSO70404, DSA70404B, DPO70404B 450 fs
	Calculate the jitter noise floor (JNF) for a given instrument setting using the following formula: FS = full-scale setting (volts) A = signal amplitude as a fraction of full-scale $t_{rm} = 10 - 90\%$ displayed (or measured) rise time (seconds) N = input-referred noise (volts rms) $t_j$ = short term aperture uncertainty (seconds rms)
	$JNF = \sqrt{\left[ \frac{N}{FS \times A} \times t_{rm} \right]^2 + t_j^2} \quad (\text{seconds rms})$
Timebase stability (sample rate jitter or jitter noise floor), typical, $< 4$ GHz models	Total: $< 1.0$ ps rms for record durations less than 10 $\mu$ s $< 2.5$ ps rms for record durations less than 30 ms $< 65$ parts/trillion for record durations less than 10 s
Timebase jitter with External Reference, typical, $\geq 4$ GHz models	$= < 3$ ps <sub>RMS</sub> at 100 ms delay

**Table 1-2: Horizontal and acquisition system specifications, all MSO70000/C, DSA/DPO70000B/C, and DPO7000 Series models (cont.)**

Characteristic	Description
<p>✓ Delta time measurement accuracy, ≥ 4 GHz models</p>	<p>The formula to calculate the maximum delta-time measurement accuracy (<math>DTA_{max}</math>) for a given instrument setting and input signal is given below (assumes insignificant signal content above Nyquist and insignificant error due to aliasing, overdrive recovery and overdrive interpolation):</p> <p><math>SR_1</math> = slew rate around 1st point in measurement (1<sup>st</sup> edge)  <math>SR_2</math> = slew rate around 2nd point in measurement (2<sup>nd</sup> edge)  <math>F_N</math> = 1.3 for instrument bandwidth ≤9 GHz; 1.5 for instrument bandwidth ≥10 GHz  <math>N_{typ}</math> = typical input-referred noise spec (volts rms)  TBA = timebase accuracy (1.5 ppm)  <math>t_{reading}</math> = delta-time measurement (seconds)  Peak-peak based on statistical accumulation of 1000 waveforms.</p> $DTA_{MAXpk-pk} = 10 \times \sqrt{(N_{typ} \times F_N)^2 \left\{ \left[ \frac{1}{SR_1} \right]^2 + \left[ \frac{1}{SR_2} \right]^2 \right\} + 1ps^2 + (2 \times 10^{-9} \times t_{reading})^2} + TBA \times t_{reading} \quad (seconds \text{ } pk-pk)$ <p>RMS is guaranteed regardless of data-gathering duration.</p> $DTA_{MAXrms} = \sqrt{(N_{typ} \times F_N)^2 \times \left\{ \left[ \frac{1}{SR_1} \right]^2 + \left[ \frac{1}{SR_2} \right]^2 \right\} + 1ps^2 + (2 \times 10^{-9} \times t_{reading})^2} + TBA \times t_{reading} \quad (seconds \text{ } rms)$ <p>The term under the square-root sign is the stability and is due to time interval error (TIE). The errors due to this term occur throughout a single-shot measurement. The second term is due to both the absolute center-frequency accuracy and the center-frequency stability of the timebase and varies between multiple single-shot measurements over the observation interval (the amount of time from the first single-shot measurement to the final single-shot measurement). The observation interval may not exceed 1 year.</p> <p>Test frequency = 0.621 × bandwidth. Test amplitude = 80% full scale.</p>
<p>MSO/DSA/DPO72004C at 50 GS/s, BWE off</p>	<p>1.280 ps rms, 12.80 ps<sub>p-p</sub>, &lt;10 ns pulse width, 10 mV/div, amplitude = 80% FS  1.172 ps rms, 11.72 ps pk-pk, &lt;10 ns pulse width, 50 mV/div, amplitude = 80% FS  1.186 ps rms, 11.86 ps pk-pk, &lt;10 ns pulse width, 100 mV/div, amplitude = 80% FS</p>
<p>MSO/DSA/DPO71604C at 50 GS/s, BWE off</p>	<p>1.280 ps rms, 12.80 ps pk-pk, &lt;10 ns pulse width, 10 mV/div, amplitude = 80% FS  1.172 ps rms, 11.72 ps pk-pk, &lt;10 ns pulse width, 50 mV/div, amplitude = 80% FS  1.186 ps rms, 11.86 ps pk-pk, &lt;10 ns pulse width, 100 mV/div, amplitude = 80% FS</p>

**Table 1-2: Horizontal and acquisition system specifications, all MSO70000/C, DSA/DPO70000B/C, and DPO7000 Series models (cont.)**

<b>Characteristic</b>	<b>Description</b>
MSO/DSA/DPO71254C at 50 GS/s, BWE off	1.304 ps rms, 13.04 ps pk-pk, <10 ns pulse width, 10 mV/div, amplitude = 80% FS
	1.201 ps rms, 12.01 ps pk-pk, <10 ns pulse width, 50 mV/div, amplitude = 80% FS
	1.205 ps rms, 12.05 ps pk-pk, <10 ns pulse width, 100 mV/div, amplitude = 80% FS
MSO70804 and DSA/DPO70804B at 25 GS/s, BWE off	1.462 ps rms, 14.62 ps pk-pk, <10 ns pulse width, 10 mV/div, amplitude = 80% FS
	1.295 ps rms, 12.95 ps pk-pk, <10 ns pulse width, 50 mV/div, amplitude = 80% FS
	1.336 ps rms, 13.36 ps pk-pk, <10 ns pulse width, 100 mV/div, amplitude = 80% FS
MSO70604 and DSA/DPO70604B at 25 GS/s, BWE off	1.625 ps rms, 16.25 ps pk-pk, <10 ns pulse width, 10 mV/div, amplitude = 80% FS
	1.427 ps rms, 14.27 ps pk-pk, <10 ns pulse width, 50 mV/div, amplitude = 80% FS
	1.463 ps rms, 14.63 ps pk-pk, <10 ns pulse width, 100 mV/div, amplitude = 80% FS
MSO70404 and DSA/DPO70404B at 25 GS/s, BWE off	2.022 ps rms, 20.22 ps pk-pk, <10 ns pulse width, 10 mV/div, amplitude = 80% FS
	1.762 ps rms, 17.62 ps pk-pk, <10 ns pulse width, 50 mV/div, amplitude = 80% FS
	1.821 ps rms, 18.21 ps pk-pk, <10 ns pulse width, 100 mV/div, amplitude = 80% FS
MSO/DSA/DPO72004C at 50 GS/s, 20 GHz, BWE on	1.260 ps rms, 12.60 ps pk-pk, <10 ns pulse width, 50 mV/div, amplitude = 80% FS
	1.432 ps rms, 14.32 ps pk-pk, <10 ns pulse width, 100 mV/div, amplitude = 80% FS
MSO/DSA/DPO72004C at 50 GS/s, 18 GHz, BWE on	1.336 ps rms, 13.36 ps pk-pk, <10 ns pulse width, 10 mV/div, amplitude = 80% FS
	1.182 ps rms, 11.82 ps pk-pk, <10 ns pulse width, 50 mV/div, amplitude = 80% FS
	1.234 ps rms, 12.34 ps pk-pk, <10 ns pulse width, 100 mV/div, amplitude = 80% FS
MSO/DSA/DPO72004C, MSO/DSA/DPO71654C at 50 GS/s, 16 GHz, BWE on	1.219 ps rms, 12.19 ps pk-pk, <10 ns pulse width, 10 mV/div, amplitude = 80% FS
	1.154 ps rms, 11.54 ps pk-pk, <10 ns pulse width, 50 mV/div, amplitude = 80% FS
	1.159 ps rms, 11.59 ps pk-pk, <10 ns pulse width, 100 mV/div, amplitude = 80% FS
MSO/DSA/DPO72004C, MSO/DSA/DPO71654C, MSO/DSA/DPO71254C at 50 GS/s, 12.5 GHz, BWE on	1.333 ps rms, 13.33 ps pk-pk, <10 ns pulse width, 10 mV/div, amplitude = 80% FS
	1.212 ps rms, 12.12 ps pk-pk, <10 ns pulse width, 50 mV/div, amplitude = 80% FS
	1.228 ps rms, 12.287 ps pk-pk, <10 ns pulse width, 100 mV/div, amplitude = 80% FS
MSO70804, DSA/DPO70804B at 25 GS/s, 8 GHz, BWE on	1.354 ps rms, 13.54 ps pk-pk, <10 ns pulse width, 10 mV/div, amplitude = 80% FS
	1.235 ps rms, 12.35 ps pk-pk, <10 ns pulse width, 50 mV/div, amplitude = 80% FS
	1.241 ps rms, 12.41 ps pk-pk, <10 ns pulse width, 100 mV/div, amplitude = 80% FS

**Table 1-2: Horizontal and acquisition system specifications, all MSO70000/C, DSA/DPO70000B/C, and DPO7000 Series models (cont.)**

Characteristic	Description
MSO70804, DSA/DPO70804B, MSO70604, DSA/DPO70604B at 25 GS/s, 6 GHz, BWE on	1.445 ps rms, 14.45 ps pk-pk, <10 ns pulse width, 10 mV/div, amplitude = 80% FS 1.295 ps rms, 12.95 ps pk-pk, <10 ns pulse width, 50 mV/div, amplitude = 80% FS 1.329 ps rms, 13.29 ps pk-pk, <10 ns pulse width, 100 mV/div, amplitude = 80% FS
MSO70804, DSA/DPO70804B, MSO70604, DSA/DPO70604B, MSO70404, DSA/DPO70404B at 25 GS/s, 4 GHz, BWE on	1.674 ps rms, 16.74 ps pk-pk, <10 ns pulse width, 10 mV/div, amplitude = 80% FS 1.437 ps rms, 14.37 ps pk-pk, <10 ns pulse width, 50 mV/div, amplitude = 80% FS 1.478 ps rms, 14.78 ps pk-pk, <10 ns pulse width, 100 mV/div, amplitude = 80% FS
✓ Delta Time Measurement Accuracy, < 4 GHz models	For signals having amplitude greater than 5 divisions, reference level = 50%, filter set to $\sin(x)/x$ , acquired at 10 mV/div or greater. The displayed risetime/sample interval must be greater than 1.4 but less than 4. Extra error will occur for two channel measurements due to channel to channel skew. Peak specification is based on statistical accumulation of 1000 waveforms.
	Single shot, sample or HiRes, full bandwidth $(0.06/\text{sample rate} + 2.5 \text{ ppm} \times  \text{reading} )$ RMS $\pm (0.30/(\text{sample rate}) + (2.5 \text{ ppm} \times  \text{reading} ))$ peak
	Average Mode, $\geq 100$ averages, full bandwidth selected. $\pm (2.5 \text{ ppm} \times  \text{reading}  + 4 \text{ ps})$



**Table 1-3: Trigger specifications, all MSO70000/C, DSA/DPO70000B/C, and DPO7000 Series models**

Characteristic	Description																			
Trigger jitter, DC coupled, A edge, random holdoff, typical	≥ 4 GHz models	100 fs using enhanced trigger placement. 1 ps rms for low frequency, fast rise time signal, A edge, time holdoff = 30 μs																		
	< 4 GHz models	1.5 ps rms for low frequency, fast rise time signal (DPO7104 and DPO7054: 3 ps total trigger jitter.)																		
✓ Edge trigger sensitivity, DC coupled, typical	All sources, positive or negative edge, for vertical scale settings ≥10 mV/div and ≤1 V/div																			
	≥ 4 GHz models	<table border="1"> <thead> <tr> <th>Trigger Source</th> <th>Sensitivity</th> </tr> </thead> <tbody> <tr> <td rowspan="5">A Event trigger</td> <td>≤ 4%FS from DC to 50 MHz</td> </tr> <tr> <td>≤ 10%FS at 4 GHz</td> </tr> <tr> <td>≤ 15%FS at 6 GHz</td> </tr> <tr> <td>≤ 20%FS at 8 GHz</td> </tr> <tr> <td>≤ 50%FS at 11 GHz</td> </tr> <tr> <td colspan="2">20%FS from DC to 20 GHz (typical, enhanced trigger on, auto mode only for frequencies above 8 GHz)</td> </tr> <tr> <td rowspan="4">B Event trigger</td> <td>≤ 4%FS from DC to 50 MHz</td> </tr> <tr> <td>≤ 10%FS at 4 GHz</td> </tr> <tr> <td>≤ 15%FS at 6 GHz</td> </tr> <tr> <td>≤ 50%FS at 9 GHz</td> </tr> <tr> <td colspan="2">20%FS from DC to 20 GHz (typical, enhanced trigger on, auto mode only for frequencies above 6 GHz)</td> </tr> <tr> <td>Auxiliary input</td> <td>250 mV from DC to 50 MHz, increasing to 350 mV at 1 GHz</td> </tr> </tbody> </table>	Trigger Source	Sensitivity	A Event trigger	≤ 4%FS from DC to 50 MHz	≤ 10%FS at 4 GHz	≤ 15%FS at 6 GHz	≤ 20%FS at 8 GHz	≤ 50%FS at 11 GHz	20%FS from DC to 20 GHz (typical, enhanced trigger on, auto mode only for frequencies above 8 GHz)		B Event trigger	≤ 4%FS from DC to 50 MHz	≤ 10%FS at 4 GHz	≤ 15%FS at 6 GHz	≤ 50%FS at 9 GHz	20%FS from DC to 20 GHz (typical, enhanced trigger on, auto mode only for frequencies above 6 GHz)		Auxiliary input
Trigger Source	Sensitivity																			
A Event trigger	≤ 4%FS from DC to 50 MHz																			
	≤ 10%FS at 4 GHz																			
	≤ 15%FS at 6 GHz																			
	≤ 20%FS at 8 GHz																			
	≤ 50%FS at 11 GHz																			
20%FS from DC to 20 GHz (typical, enhanced trigger on, auto mode only for frequencies above 8 GHz)																				
B Event trigger	≤ 4%FS from DC to 50 MHz																			
	≤ 10%FS at 4 GHz																			
	≤ 15%FS at 6 GHz																			
	≤ 50%FS at 9 GHz																			
20%FS from DC to 20 GHz (typical, enhanced trigger on, auto mode only for frequencies above 6 GHz)																				
Auxiliary input	250 mV from DC to 50 MHz, increasing to 350 mV at 1 GHz																			
< 4 GHz models	<table border="1"> <thead> <tr> <th>Trigger Source</th> <th>Sensitivity</th> </tr> </thead> <tbody> <tr> <td rowspan="3">Main and Delayed trigger</td> <td>≤ 0.7 div from DC to 50 MHz</td> </tr> <tr> <td>≤ 1.2 div at 2.5 GHz</td> </tr> <tr> <td>≤ 2.5 div at 3.5 GHz with BWE on</td> </tr> <tr> <td rowspan="2">Auxiliary input</td> <td>1 MΩ: 250 mV from DC to 50 MHz, increasing to 350 mV at 250 MHz</td> </tr> <tr> <td>50 Ω: 150 mV from DC to 50 MHz, increasing to 200 mV at 1.8 GHz</td> </tr> <tr> <td>Video trigger, Ch1 - Ch4</td> <td>0.6 to 2.5 divisions of video sync tip</td> </tr> </tbody> </table>		Trigger Source	Sensitivity	Main and Delayed trigger	≤ 0.7 div from DC to 50 MHz	≤ 1.2 div at 2.5 GHz	≤ 2.5 div at 3.5 GHz with BWE on	Auxiliary input	1 MΩ: 250 mV from DC to 50 MHz, increasing to 350 mV at 250 MHz	50 Ω: 150 mV from DC to 50 MHz, increasing to 200 mV at 1.8 GHz	Video trigger, Ch1 - Ch4	0.6 to 2.5 divisions of video sync tip							
	Trigger Source	Sensitivity																		
	Main and Delayed trigger	≤ 0.7 div from DC to 50 MHz																		
		≤ 1.2 div at 2.5 GHz																		
≤ 2.5 div at 3.5 GHz with BWE on																				
Auxiliary input	1 MΩ: 250 mV from DC to 50 MHz, increasing to 350 mV at 250 MHz																			
	50 Ω: 150 mV from DC to 50 MHz, increasing to 200 mV at 1.8 GHz																			
Video trigger, Ch1 - Ch4	0.6 to 2.5 divisions of video sync tip																			

**Table 1-3: Trigger specifications, all MSO70000/C, DSA/DPO70000B/C, and DPO7000 Series models (cont.)**

Edge trigger sensitivity, not DC coupled, typical	All sources, positive or negative edge, for vertical scale settings $\geq 10$ mV/div and $\leq 1$ V/div	
$\geq 4$ GHz models	<i>Trigger Coupling</i>	<i>Sensitivity</i>
	NOISE REJ	15%FS from DC to 50 MHz 35%FS at 3 GHz 50%FS at 5 GHz
	AC	Same as DC-coupled limits for frequencies $> 100$ Hz, attenuates signals $< 100$ Hz
	HF REJ	Same as DC-coupled limits for frequencies $< 20$ kHz, attenuates signals $> 20$ kHz
	LF REJ	Same as DC-coupled limits for frequencies $> 200$ kHz, attenuates signals $< 200$ kHz
$< 4$ GHz models	<i>Trigger coupling</i>	<i>Sensitivity</i>
	NOISE REJ	3 the DC-coupled limits
	AC	Same as DC-coupled limits for frequencies $> 100$ Hz, attenuates signals $< 100$ Hz
	HF REJ	Same as DC-coupled limits for frequencies $< 20$ kHz, attenuates signals $> 20$ kHz
	LF REJ	Same as DC-coupled limits for frequencies $> 200$ kHz, attenuates signals $< 200$ kHz
Trigger level or threshold range		
$\geq 4$ GHz models	<i>Trigger Source</i>	<i>Range</i>
	Any channel	$+120\%$ FS from center of screen
	Auxiliary input	$\pm 5.0$ V
	Line	0 V, Not settable
$< 4$ GHz models	<i>Trigger Source</i>	<i>Sensitivity</i>
	Any channel	$\pm 12$ divisions from center of screen
	Auxiliary input	$\pm 5$ V
	Line	Not settable
Trigger level or threshold accuracy, typical	Edge trigger, DC coupled	
$\geq 4$ GHz models	<i>Trigger Source</i>	<i>Accuracy</i>
	Channel 1, 2, 3, or 4	$\pm [(2\%   \text{trigger level} - \text{net offset}  ) + (3.5\% \text{ FS}) + \text{offset accuracy}]$
	Auxiliary	Not specified
$< 4$ GHz models	<i>Trigger Source</i>	<i>Accuracy</i>
	Channel 1, 2, 3, or 4	$\pm [(2\%   \text{deflection}  ) + (0.7 \text{ divisions} \times \text{volts/division}) + \text{offset accuracy}]$
	Auxiliary	Not specified

**Table 1-3: Trigger specifications, all MSO70000/C, DSA/DPO70000B/C, and DPO7000 Series models (cont.)**

Trigger position error, typical	Edge trigger, DC coupling, for signals having a slew rate at the trigger point of $\geq 0.5$ divisions/ns			
$\geq 4$ GHz models	<i>Acquisition mode</i>		<i>Trigger Position Error</i>	
	Sample, Average		$\pm$ (1 waveform interval + 50 ps)	
< 4 GHz models	<i>Acquisition mode</i>		<i>Trigger Position Error</i>	
	Sample, Average		$\pm$ (1 waveform interval + 200 ps)	
	Peak Detect, Envelope		$\pm$ (2 waveform intervals + 200 ps)	
Time range for time-qualified triggers				
$\geq 4$ GHz models	Setup/Hold Violation			
	Setup time	-100 ns to +100 ns		
	Hold time	-1 ns to +100 ns		
	Setup + hold time	500 ps minimum		
	Timeout	400 ps to 1 s		
	Time qualified window, outside >t	600 ps to 1 s		
< 4 GHz models	All other types			
	300 ps to 1 s			
✓ Time-qualified trigger timer accuracy	For Glitch, Width, Time qualified runt, Transition, or Setup/hold violation types			
$\geq 4$ GHz models	<i>Time range</i>		<i>Accuracy</i>	
	Glitch and width triggering (300 ps to 1.0 ns typical)			
	<300 ns to 1.01 $\mu$ s		$\pm$ (3% of setting + 80 ps)	
	1.02 $\mu$ s to 1 s		$\pm$ (TB accuracy + 100 ns)	
	Other time-qualified types (300 ps to 1.0 ns typical)			
	<300 ps to 1.01 $\mu$ s		$\pm$ (5% of setting + 200 ps)	
< 4 GHz models	1.02 $\mu$ s to 1 s		$\pm$ (TB accuracy + 20 ns)	
	<1 $\mu$ s (<2 ns typical)		$\pm$ (20% of setting + 0.5 ns)	
	1 $\mu$ s to 1 s		$\pm$ (0.01% of setting + 100 ns)	
Width and glitch trigger sensitivity, typical				
$\geq 4$ GHz models	15% x FS from DC to 1 GHz, not violating the minimum timing requirements for each type (for vertical settings from 10 mV/div to 1 V/div at the input connector)			
< 4 GHz models	1.0 division from DC to 1 GHz (at input connector)			
Width and glitch trigger, minimum timing requirements, $\geq 4$ GHz models	For vertical scale settings 10 mV/div and 1 V/div			
	<i>Minimum pulse width</i>	<i>Minimum rearm time</i>	<i>Setup time</i>	<i>Hold time</i>
Width and glitch types	150 ps	300 ps	N.A.	N.A.
Logic qualified width and glitch types	150 ps	300 ps	20 ps	40 ps

**Table 1-3: Trigger specifications, all MSO70000/C, DSA/DPO70000B/C, and DPO7000 Series models (cont.)**

Width and glitch trigger, minimum timing requirements, <4 GHz models	For vertical scale settings 10 mV/div and 1 V/div			
	<i>Minimum pulse width</i>	<i>Minimum rearm time</i>	<i>Setup time</i>	<i>Hold time</i>
Width type	225 ps	250 ps	N.A.	N.A.
Logic qualified width type	190 ps	250 ps	40 ps	175 ps
Glitch type	170 ps	250 ps	N.A.	N.A.
Logic qualified glitch type	100 ps	250 ps	40 ps	60 ps
Runt trigger sensitivity, typical				
≥4 GHz models	15% x FS from DC to 1 GHz, not violating the minimum timing requirements for each type (for vertical settings from 10 mV/div to 1 V/div at the input connector)			
<4 GHz models	1.0 division (at input connector)			
Runt trigger, minimum timing requirements, ≥4 GHz models	A runt event occurs at the end of the runt whether or not the runt was time qualified. Logic qualified runt triggers require that the logic condition be true during the entire duration of the runt plus some minimum amount of time after the runt event occurred.			
	<i>Minimum pulse time</i>	<i>Minimum rearm time</i>	<i>Setup time</i>	<i>Hold time</i>
Runt type	200 ps	300 ps	N.A.	N.A.
Logic qualified runt type	200 ps	300 ps	300 ps	300 ps
Time qualified runt type	476 ps	510 ps	N.A.	N.A.
Time and logic qualified runt type	520 ps	360 ps	160 ps	105 ps
Runt trigger, minimum timing requirements, < 4 GHz models	A runt event occurs at the end of the runt whether or not the runt was time qualified. Logic qualified runt triggers require that the logic condition be true during the entire duration of the runt plus some minimum amount of time after the runt event occurred.			
	<i>Minimum pulse time</i>	<i>Minimum rearm time</i>	<i>Setup time</i>	<i>Hold time</i>
Runt type	225 ps	250 ps	N.A.	N.A.
Time qualified runt type	360 ps	450 ps	N.A.	N.A.
Logic qualified runt type	Runt width + 150 ps	250 ps	160 ps	-16 ps
Time and logic qualified runt type	Runt width + 330 ps	250 ps	160 ps	175 ps
Pattern and state trigger sensitivity, DC coupled, typical ≥ 4 GHz models	15% x FS from DC to 1 GHz, not violating the minimum timing requirements for each type (for vertical settings from 10 mV/div to 1 V/div at input connector)			
Logic and state trigger sensitivity, DC coupled, typical <4 GHz models	1.0 division from DC to 1 GHz (for vertical settings from 10 mV/div to 1 V/div at input connector)			

**Table 1-3: Trigger specifications, all MSO70000/C, DSA/DPO70000B/C, and DPO7000 Series models (cont.)**

Logic and state trigger, minimum timing requirements, typical <4 GHz models	Minimum duration of logic state: 100 ps (10 GB/s). The minimum duration of the logic pattern includes delay mismatch between channels.			
	<i>Minimum pulse width</i>	<i>Rearm time</i>		
Logic type	100 ps (10 GB/s)	100 ps		
State type	500 ps	500 ps		
Time qualified logic type	300 ps	500 ps		
Video-type trigger formats and field rates, <4 GHz models	Triggers from negative sync composite video, field 1 or field 2 for interlaced systems, any field, specific line, or any line for interlaced or non-interlaced systems. Supported systems include NTSC, PAL, SECAM, and HDTV 1080/24sF, 1080p/25, 1080i/50, 1080i/60, 1080p/24, 720p/60, 480p/60.			
Timeout trigger, minimum timing requirements, ≥4 GHz models	Timeout event occurs after the signal has stayed in some state the minimum amount of time. Setup and hold times are how long before and after the timeout event the logic level must remain valid in order to generate a trigger.			
	<i>Minimum pulse width</i>	<i>Minimum rearm time</i>	<i>Setup time</i>	<i>Hold time</i>
Timeout type	N.A.	300 ps + pulse width	N.A.	N.A.
Logic qualified timeout type	N.A.	300 ps + pulse width	50 ps	50 ps
Timeout trigger, minimum timing requirements, <4 GHz models	Timeout event occurs after the signal has stayed in some state the minimum amount of time. Setup and hold times are how long before and after the timeout event the logic level must remain valid in order to generate a trigger.			
	<i>Maximum ignored pulse width</i>	<i>Minimum rearm time</i>	<i>Setup time</i>	<i>Hold time</i>
Timeout type	300 ps	500 ps + pulse width	N.A.	N.A.
Logic qualified timeout type	300 ps	500 ps + pulse width	200 ps	200 ps
Window trigger, minimum timing requirements, ≥ 4 GHz models				
	<i>Minimum pulse width</i>	<i>Minimum rearm time</i>	<i>Setup time</i>	<i>Hold time</i>
Window enters	150 ps	500 ps	N.A.	N.A.
Window exits	500 ps	150 ps	N.A.	N.A.
Logic qualified window enters	150 ps	500 ps	N.A.	N.A.
Logic qualified window exits	500 ps	150 ps	N.A.	N.A.
Window inside >t	N.A.	500 ps	N.A.	N.A.
Window outside >t	N.A.	150 ps	N.A.	N.A.

**Table 1-3: Trigger specifications, all MSO70000/C, DSA/DPO70000B/C, and DPO7000 Series models (cont.)**

Window trigger, minimum timing requirements, <4 GHz models				
	<i>Minimum pulse width</i>	<i>Minimum rearm time</i>	<i>Setup time</i>	<i>Hold time</i>
Window	225 ps	300 ps	N.A.	N.A.
Logic qualified window	190 ps	300 ps	-20 ps	0 ps
Transition trigger, minimum timing requirements, ≥4 GHz models				
The transition trigger event occurs at the end of the transition. The logic condition must be valid at the moment the transition event occurs minus the setup time plus the hold time. Rearm time is the time below the lower threshold and the time above the upper threshold. Neither time can be violated.				
	<i>Minimum pulse width</i>	<i>Minimum rearm time</i>	<i>Setup time</i>	<i>Hold time</i>
Transition type	0 ps	500 ps	N.A.	N.A.
Logic qualified transition type	0 ps	500 ps	50 ps	50 ps
Transition trigger, minimum timing requirements, <4 GHz models				
The transition trigger event occurs at the end of the transition. The logic condition must be valid at the moment the transition event occurs minus the setup time plus the hold time.				
	<i>Minimum pulse width</i>	<i>Minimum rearm time</i>	<i>Setup time</i>	<i>Hold time</i>
Transition type	0 ps	225 ps	N.A.	N.A.
Logic qualified transition type	330 ps	225 ps	225 ps	175 ps
Transition trigger, delta time range				
	1 ns to 1 s			
Setup/Hold violation trigger, setup and hold time ranges				
	<i>Minimum</i>	<i>Maximum</i>		
Setup time	-100 ns	100 ns		
Hold time	-1 ns	102 ns		
Setup + hold time	500 ps			
Setup/hold time violation trigger, minimum clock pulse widths, typical				
	Minimum time from active clock edge to inactive edge		Minimum time from inactive clock edge to active edge	
≥ 4 GHz models	Hold times ≥ 0: Hold time + 550 ps		500 ps	
	Hold times <0: Hold time + 1.6 ns		500 ps	
< 4 GHz models	Hold times ≥ 0: Hold time + 500 ps		500 ps	
	Hold times <0: Hold time + 1.5 ns			

**Table 1-3: Trigger specifications, all MSO70000/C, DSA/DPO70000B/C, and DPO7000 Series models (cont.)**

Pattern and State trigger, minimum timing requirements, typical, $\geq 4$ GHz models	The transition trigger event occurs at the end of the transition. The logic condition must be valid at the moment the transition event occurs minus the setup time plus the hold time.			
	<i>Minimum pulse width</i>	<i>Minimum rearm time</i>	<i>Setup time</i>	<i>Hold time</i>
Pattern type	150 ps	200 ps	N.A.	N.A.
Time qualified pattern type	150 ps	300 ps	N.A.	N.A.
State type	1.7 GHz	N.A.	25 ps	100 ps
Period trigger sensitivity, typical				
$\geq 4$ GHz models	1.5 divisions (at input connector)			
$< 4$ GHz models	1.0 division (at input connector)			
B trigger after events, minimum timing requirements, typical, $\geq 4$ GHz models	<i>Minimum pulse width</i>	<i>Maximum counting frequency</i>	<i>Minimum time between channels</i>	
	140 ps	3.5 GHz	1 ns	
$< 4$ GHz models	<i>Minimum pulse width</i>	<i>Minimum time between channels</i>		
	200 ps	1 ns		
B trigger after events, event counter range				
$\geq 4$ GHz models	1 to 2,000,000,000			
$< 4$ GHz models	1 to 10,000,000			
B trigger after time, time delay range				
$\geq 4$ GHz models	3.2 ns to 3 Ms			
$< 4$ GHz models	5 ns to 250 s			
Variable A event trigger holdoff range	250 ns to 12 s + random holdoff			
Lowest frequency for successful Set Level to 50%, typical	50 Hz			
Trigger Jitter (RMS)				
$\geq 4$ GHz models	100 fs using enhanced Trigger placement. 1.0 ps RMS (typical) for low frequency, fast rise time signal, A edge, time holdoff = 30 $\mu$ s.			
$< 4$ GHz models	1.5 ps RMS (typical)			

**Table 1-4: Serial Trigger specifications, all MSO70000/C and DSA/DPO70000B/C Series models (optional on DPO7000 models)**

Characteristic	Description
Low speed serial trigger, ≥ 4 GHz models	
Number of bits	128 bits
Baud rate limits	10 Mbits/s
High speed serial trigger number of bits	
≥ 4 GHz models	64 bits for NRZ data rates ≤ 1.25 GBaud 40 bits for 8b/10b data rates between 1.25 GBd and 6.25 GBd
< 4 GHz models	64 bits
High speed serial trigger, serial word recognizer position accuracy	
≥ 4 GHz models	± 200 ps
< 4 GHz models	<i>Acquisition mode</i>
	Sample, Average ± (1 waveform interval + 200 ps)
	Peak Detect, Envelope ± (2 waveform intervals + 200 ps)
Serial trigger decoding types	
≥ 4 GHz models	≤ 1.25 GB: NRZ 1.25 GB to 6.25 GB: 8B10B
< 4 GHz models	NRZ
Serial trigger baud rate limits	
≥ 4 GHz models, typical	Up to 1.25 GBd, NRZ NRZ 8B10B encoded data at the following bit rates 1.25 GBd, 1.50 GBd, 1.57 GBd, 2.00 GBd, 2.125 GBd, 2.50 GBd, 3.00 GBd, 3.125 GBd, 4.25 GBd, 4.80 GBd, 5.00 GBd, 6.00 GBd, 6.25 GBd
✔ < 4 GHz models	Up to 1.25 GBd (Option PTM adds protocol trigger to DPO7000 Series)
Error detection jitter tolerance	≤ 0.4 UI of total jitter on the signal.



**Table 1-4: Serial Trigger specifications, all MSO70000/C and DSA/DPO70000B/C Series models (optional on DPO7000 models) (cont.)**

Characteristic	Description																																						
Clock recovery frequency range																																							
≥ 4 GHz models, typical	1.5 MBaud to 3.125 GBaud. Above 1250 MHz, the clock is only available internally as a trigger source. Below 1250 MHz, the clock is also available at the recovered clock output along with regenerated data.																																						
✎ < 4 GHz models	1.5 MBaud to 1.25 GBaud.																																						
Clock recovery jitter, typical																																							
≥ 4 GHz models	< 0.25% bit period + 2 ps rms for PRBS data patterns with 50% transition density. < 0.25% bit period + 1.5 ps rms for repeating 0011 data patterns.																																						
	<table border="1"> <thead> <tr> <th rowspan="2"><i>Bit rate</i></th> <th rowspan="2"><i>Pattern</i></th> <th colspan="2"><i>Jitter (ps rms)</i></th> </tr> <tr> <th>PRBS</th> <th>0011</th> </tr> </thead> <tbody> <tr> <td>3.125 GBd</td> <td>00110011</td> <td>2.8 ps</td> <td>2.3 ps</td> </tr> <tr> <td>2.74 GBd</td> <td>00110011</td> <td>2.9 ps</td> <td>2.4 ps</td> </tr> <tr> <td>2.35 GBd</td> <td>00110011</td> <td>3.1 ps</td> <td>2.6 ps</td> </tr> <tr> <td>2.34 GBd</td> <td>00110011</td> <td>3.1 ps</td> <td>2.6 ps</td> </tr> <tr> <td>1.95 GBd</td> <td>00110011</td> <td>3.3 ps</td> <td>2.8 ps</td> </tr> <tr> <td>1.57 GBd</td> <td>00110011</td> <td>3.6 ps</td> <td>3.1 ps</td> </tr> <tr> <td>100 MBd</td> <td>00110011</td> <td>27 ps</td> <td>27 ps</td> </tr> <tr> <td>10 MBd</td> <td>00110011</td> <td>252 ps</td> <td>252 ps</td> </tr> </tbody> </table>	<i>Bit rate</i>	<i>Pattern</i>	<i>Jitter (ps rms)</i>		PRBS	0011	3.125 GBd	00110011	2.8 ps	2.3 ps	2.74 GBd	00110011	2.9 ps	2.4 ps	2.35 GBd	00110011	3.1 ps	2.6 ps	2.34 GBd	00110011	3.1 ps	2.6 ps	1.95 GBd	00110011	3.3 ps	2.8 ps	1.57 GBd	00110011	3.6 ps	3.1 ps	100 MBd	00110011	27 ps	27 ps	10 MBd	00110011	252 ps	252 ps
<i>Bit rate</i>	<i>Pattern</i>			<i>Jitter (ps rms)</i>																																			
		PRBS	0011																																				
3.125 GBd	00110011	2.8 ps	2.3 ps																																				
2.74 GBd	00110011	2.9 ps	2.4 ps																																				
2.35 GBd	00110011	3.1 ps	2.6 ps																																				
2.34 GBd	00110011	3.1 ps	2.6 ps																																				
1.95 GBd	00110011	3.3 ps	2.8 ps																																				
1.57 GBd	00110011	3.6 ps	3.1 ps																																				
100 MBd	00110011	27 ps	27 ps																																				
10 MBd	00110011	252 ps	252 ps																																				
< 4 GHz models	20 psRMS + 1.25% Unit interval RMS for PRBS data patterns. 20 psRMS + 1.25% Unit interval RMS for repeating 0011 data patterns. (Transition density of 50%). Jitter increases by 1.4 every time the transition density is reduced by half.  28 psRMS + 1.25% Unit interval RMS for 25% transition density. 30 psRMS + 1.25% Unit interval RMS for 12.5% transition density.																																						
Clock recovery tracking/acquisition range, typical																																							
≥ 4 GHz models	± 2% of requested baud																																						
< 4 GHz models	± 5% of requested baud																																						
Minimum signal amplitude needed for clock recovery, typical																																							
≥ 4 GHz models	1 division peak-peak up to 1.25 GBd 1.5 divisions peak-peak above 1.25 GBd Tri-level signals need 50% more pk-pk amplitude																																						
< 4 GHz models	1 division peak-peak up to 1.25 GBd 50% more peak-to-peak amplitude is required for tri-level signals.																																						
Serial interface triggering standards supported, < 4 GHz models	I <sup>2</sup> C, CAN, SPI, USB1.1, RS232																																						

**Table 1-4: Serial Trigger specifications, all MSO70000/C and DSA/DPO70000B/C Series models (optional on DPO7000 models) (cont.)**

<b>Characteristic</b>	<b>Description</b>
TekLink trigger jitter, typical ≥ 4 GHz models	RMS jitter between the master and slave instruments: <500 ps rms
TekLink FastAcq acquisition update rate ≥ 4 GHz models	150,000 waveforms per second

**Table 1-5: Digital acquisition specifications (MSO70000/C Series)**

Characteristic	Description
Minimum signal amplitude	300 mV p-p; logic threshold centered in dynamic range of signal; f ≤1.5 GHz for P6780 f ≤350 MHz for P6717
Minimum detectable pulse width (mainframe and logic probe), typical	<400 ps
Number of probe channels	17
Number of digital acquisition channels	16
Digital channel resolution	1 bit, either a 0 or a 1
Logic threshold range	-2 V to +5 V
with P6780 probe	-2 V to +4.5 V
with P6717 probe	-1.5 V to +4.0 V
Logic threshold resolution	5 mV
Logic threshold accuracy (with probe attached), typical	≤3% of threshold setting ±75 mV
Single acquisition displayed timing uncertainty between digital channels with P6780 probe, typical	
Without deskew	160 ps
After deskew	80 ps
Number of digital channels available for analog acquisition	4. Any of the 16 acquisition channels + clock qualifier channel can be displayed in place of any analog channel on the instrument
iCapture bandwidth with general purpose probe, typical	>300 MHz
iCapture bandwidth with solder-in differential probe, typical	>2.5 GHz
iCapture rise time with solder-in differential probe, typical	≤200 ps
Position range of analog iCapture channels	±5 divisions
iCapture DC analog accuracy (mainframe and probe)	±(5% of reading +0.2 division)
Gain ranges of analog channels with probe	250 mV/div, 375 mV/div, 750 mV/div, 1.25 V/div, 1.88 V/div, 3.75 V/div
Digital channel comparison values	0, 1, or don't care
Word Recognizer trigger functions	
Combinational trigger	AND, NAND, OR, NOR
Edge qualified combinational trigger	AND, NAND, OR, NOR qualified on the rising or falling edge, or either edge of CQ, the qualifying channel
Trigger toggle rate, typical	≥1.5 GHz
Single channel trigger jitter, typical	5 ps rms for A event edge trigger using low frequency, fast rise time signal

**Table 1-5: Digital acquisition specifications (MSO70000/C Series) (cont.)**

Characteristic	Description
Low speed serial trigger threshold accuracy, typical	$\pm(3\%$ of setting $\pm 125$ mV) relative to the probe tip input $+20$ mV/ $^{\circ}$ C from the operating temperature at which SPC was run
Low speed serial trigger threshold range	-2 to +4.5 V with DI probe -1.5 to +4 V with GP probe
Maximum low speed serial trigger toggle rate	I <sup>2</sup> C: 3.4 MHz SPI: 4.25 MHz
Maximum digital acquisition sample rate	12.5 GS/s
Maximum record length, sample mode	The maximum record length depends on the number of active channels and the installed record length options. The maximum record length is less in serial trigger mode, hi-res mode, or when using the FIR filter.
Standard	12.5 GS/s or less 10,000,000 points (all channels)
Option 2XL installed	12.5 GS/s or less 20,000,000 points (all channels)
Option 5XL installed	12.5 GS/s or less 50,000,000 points (all channels)
Option 10XL installed	12.5 GS/s or less 125,000,000 points (all channels)
Option 20XL installed	12.5 GS/s or less 250,000,000 points (all channels)

**Table 1-6: Input/output port specifications, all MSO70000/C, DSA/DPO70000B/C, and DPO7000 Series models**

Characteristic	Description						
Auxiliary Trigger input characteristics and range							
$\geq 4$ GHz models	50 $\Omega$ , $\pm 5$ V (DC plus peak AC)						
$< 4$ GHz models	50 $\Omega$ , $\pm 5\%$ ; maximum input voltage $\pm 5$ V (DC + peak AC) 1 M $\Omega$ , $\pm 5\%$ , 150 V CAT1. Derate at 20 dB/decade to 9 V RMS above 200 kHz						
Auxiliary Output logic polarity and functionality	Default output is A trigger low true (a negative edge when the A trigger event occurs). You can also program the output to A trigger high true, B trigger low or high true, disabled, force high, and force low.						
Auxiliary Output logic levels, typical	<table border="0"> <thead> <tr> <th><math>V_{out}</math> high</th> <th><math>V_{out}</math> low (true)</th> </tr> </thead> <tbody> <tr> <td><math>\geq 2.5</math> V into 1 M<math>\Omega</math> load,</td> <td><math>\leq 0.7</math> V into 1 M<math>\Omega</math> load</td> </tr> <tr> <td><math>\geq 1.0</math> V into 50 <math>\Omega</math> load to ground</td> <td><math>\leq 0.25</math> V into 50 <math>\Omega</math> load to ground</td> </tr> </tbody> </table>	$V_{out}$ high	$V_{out}$ low (true)	$\geq 2.5$ V into 1 M $\Omega$ load,	$\leq 0.7$ V into 1 M $\Omega$ load	$\geq 1.0$ V into 50 $\Omega$ load to ground	$\leq 0.25$ V into 50 $\Omega$ load to ground
$V_{out}$ high	$V_{out}$ low (true)						
$\geq 2.5$ V into 1 M $\Omega$ load,	$\leq 0.7$ V into 1 M $\Omega$ load						
$\geq 1.0$ V into 50 $\Omega$ load to ground	$\leq 0.25$ V into 50 $\Omega$ load to ground						
CH3 output voltage, typical < 4 GHz models	50 mV/div $\pm 20\%$ into a 1 M $\Omega$ load 25 mV/div $\pm 20\%$ into a 50 $\Omega$ load						
Serial data output baud rate range, $\geq 4$ GHz models	Fbaud < 1250 MB. Output swing of 1010 repeating pattern at this baud will be at least 200 mV into 50 $\Omega$ .						
High speed serial clock output frequency range, $\geq 4$ GHz models	Peak-to-peak output swing at 625 MHz is at least 200 mV p-p into 50 $\Omega$ . Higher frequencies are further attenuated by approximately 6 dB per octave above 625 MHz. Use AC or DC coupled 50 $\Omega$ termination; AC coupling the clock provides about 10% more amplitude.						

**Table 1-6: Input/output port specifications, all MSO70000/C, DSA/DPO70000B/C, and DPO7000 Series models (cont.)**

Characteristic	Description
High speed serial data and clock output voltages, typical, $\geq 4$ GHz models	Voh = -1.0 V Vol = -1.7 V Assumes a load impedance greater than 1 k $\Omega$ . (50 $\Omega$ source termination.) If a 50 $\Omega$ or 75 $\Omega$ load is used, either use a DC blocking capacitor in series with the signal or reference the termination to about -1.3 V. The signal amplitude will be correspondingly reduced.
High speed serial data output latency, typical, $\geq 4$ GHz models	11 ns $\pm$ 4 ns, plus 35.5 clock cycles
✓ Probe Compensation output step amplitude and offset	
$\geq 4$ GHz models	440 mV $\pm$ 22% into a 50 $\Omega$ load (Vol = -0.2 V to 0 V, Voh = 0.2 V to 0.4 V, typical) 810 mV $\pm$ 22% into a 10 k $\Omega$ load, (Vol = -0.4 V to 0 V, Voh = 0.4 V to 0.8 V)
$< 4$ GHz models	1 V $\pm$ 1.5% into a $\geq 100$ k $\Omega$ load (Vol = -1.0 V, Voh = 0 V typical) Add 0.05%/°C for temperatures greater than or less than 25 °C
Probe Compensation output step frequency	
$\geq 4$ GHz models	1 kHz $\pm$ 20%
$< 4$ GHz models	1 kHz $\pm$ 5%
Probe Calibration output step rise time, typical	
$\geq 4$ GHz models	300 ps (10% to 90%) directly into an input channel. To deskew a probe, use a 50 $\Omega$ terminator in series with the deskew fixture to minimize HF aberrations.
$< 4$ GHz models	$\leq 350$ ps at 1 V, into a $\geq 20$ K $\Omega$ load to ground. $\leq 1$ ns at 2 V, into a 50 $\Omega$ load to ground. To deskew a probe, use a 50 $\Omega$ terminator in series with the deskew fixture to minimize HF aberrations.
Probe Calibration output step aberrations, typical	$\leq \pm 1\%$ after the first 500 ns following the square wave transition. To deskew a probe, use a 50 $\Omega$ terminator in series with the deskew fixture to minimize HF aberrations.
Jitter of internal Probe Calibration trigger, typical	5 ps RMS

**Table 1-6: Input/output port specifications, all MSO70000/C, DSA/DPO70000B/C, and DPO7000 Series models (cont.)**

Characteristic	Description	
External reference, typical	Run SPC whenever the external reference is more than 0.1% (1000 ppm) different than the nominal reference or the reference at which SPC was last run. The timebase changes in correspondence to the fluctuations in the external reference.	
Input frequency	≥ 4 GHz models: 10 MHz < 4 GHz models: 10 MHz	
Input sensitivity	≥ 4 GHz models: ≥ 200 mV <sub>p-p</sub> < 4 GHz models: ≥ 1.5 V <sub>p-p</sub>	
Input voltage, maximum	7 V <sub>p-p</sub>	
Input impedance	≥ 4 GHz models: 1.5 kΩ, C <sub>in</sub> = 40 pF, measured at >100 kHz < 4 GHz models: 385 Ω, C <sub>in</sub> = 137 pF, measured at 10 MHz	
Input frequency variation tolerance	≥ 4 GHz models: Low (stable) jitter mode: ± 100 ppm High (tracking) jitter mode: ± 1% Running SPC is required whenever the external reference is more than 0.1% (1000 ppm) different from the nominal reference frequency or reference at which SPC was last run. < 4 GHz models: 9.8 MHz to 10.2 MHz	
Internal reference output		
Frequency	≥ 4 GHz models: 10 MHz < 4 GHz models: 10 MHz available at AUXOUT	
Output voltage, typical	> 750 mV peak-peak into 50 Ω	
≥ 4 GHz models	> 1.5 V peak-peak into 1 M Ω (internally AC coupled).	
< 4 GHz models	<i>V<sub>out high</sub></i> ≥2.5 V into open circuit, ≥1.0 V into 50 Ω load to ground	<i>V<sub>out low (true)</sub></i> ≤0.7 V with ≤4 mA sink, ≤0.25 V into 50 Ω load to ground

**Table 1-6: Input/output port specifications, all MSO70000/C, DSA/DPO70000B/C, and DPO7000 Series models (cont.)**

<b>Characteristic</b>	<b>Description</b>
Input and output ports	
Scope XGA Video port, DSA70000B, DPO70000B, and DPO7000 models	15 pin D-sub female connector
VGA Video output port, DSA70000B, DPO70000B, and DPO7000 models	15 pin D-Sub female connector
DVI-I Video port, MSO70000/C and DSA/DPO70000C models	A female Digital Visual Interface (DVI-I) compatible port
Parallel port (IEEE 1284), DSA/DPO70000B and DPO7000 models	25 pin D-Sub connector, supports the following modes: standard (output only) bidirectional (PS-2 compatible) bidirectional enhanced parallel port (IEEE 1284 standard, mode 1 or mode 2, v 1.7) bidirectional high-speed extended capabilities port (ECP)
Passive eSATA Port, MSO70000/C and DSA/DPO70000C models	Instrument must be powered down to make connection
Serial port, DSA/DPO70000B, and DPO7000 models	9 pin D-Sub COM1 port, uses NS16C550-compatible UARTS, transfer speeds up to 115.2 kb/s
COM1 and COM2 serial ports, MSO70000/C and DSA/DPO70000C models	9 pin D-Sub ports, use NS16C550-compatible UARTS, transfer speeds up to 115.2 kb/s
Keyboard and Mouse ports	PS-2 compatible, instrument must be powered down to make connection
LAN port	RJ-45 connector, supports 10 base-T, 100 base-T, and Gigabit Ethernet
External audio ports	External audio jacks for microphone input and line output
USB ports	Four side or rear panel and 1 front panel USB 2.0 connectors
GPIB port	IEEE 488.2 standard interface, listener or controller

**Table 1-7: Data storage specifications, all MSO70000/C, DSA/DPO70000B/C, and DPO7000 Series models**

Characteristic	Description
Hard disk	The 2.5-inch SATA hard disk drive capacity is $\geq 160$ GB. Waveforms and setups are stored on the hard disk.

**Table 1-8: Power source specification, all MSO70000/C, DSA/DPO70000B/C, and DPO7000 Series models**

Characteristic	Description
Power consumption	
$\geq 4$ GHz models	$< 1200$ VA
$< 4$ GHz models	550 Watts maximum
Source voltage and frequency	
$\geq 4$ GHz models	100 to 240 $V_{RMS}$ , 50 Hz to 60 Hz, 115 V $\pm 10\%$ , 400 Hz CAT II
$< 4$ GHz models	100 V to 240 $V_{RMS} \pm 10\%$ , 47 Hz to 63 Hz 115 V $\pm 10\%$ , 400 Hz
Value probe interface (VPI), $< 4$ GHz models	Probe interface allows installing, powering, compensating and controlling a wide range of probes offering a variety of features.



**Table 1-9: Mechanical specifications, all MSO70000/C, DSA/DPO70000B/C, and DPO7000 Series models**

Characteristic	Description	
<b>Weight</b>		
< 4 GHz models Benchtop configuration	14.0 kg (31 lbs) instrument only	
	21.8 kg (48 lbs) when packaged for domestic shipment	
Rackmount kit	0.9 kg (2 lbs)	
	2.2 kg (5 lbs) kit packaged for domestic shipment	
≥ 4 GHz non-MSO models, Benchtop configuration	23 kg (50.6 lbs) oscilloscope only	
	37 kg (81.4 lbs) packaged for domestic shipment	
MSO70000C Series, Benchtop configuration	25.0 kg (55 lbs) instrument only	
	39 kg (86 lbs) when packaged for domestic shipment	
Rackmount kit, ≥4 GHz models	2.04 kg (4.5 lbs) rackmount kit	
	3.4 kg (7.5 lbs) kit packaged for domestic shipment	
<b>Dimensions</b>		
< 4 GHz models Benchtop configuration	With front cover and feet	Without front cover and feet
	295.4 mm (11.6 in) height	278 mm (10.95 in) height
	468.6 mm (18.4 in) width	450.8 mm (17.75 in) width
	318 mm (12.5 in) depth	308.6 mm (12.15 in) depth
< 4 GHz models Rackmount configuration	311.15 mm (12.25 in) height	
	482.6 mm (19.0 in) width	
	520.7 mm (20.5 in) depth	
≥ 4 GHz models Benchtop configuration	With front cover	Without front cover
	278 mm (10.95 in) height	277 mm (10.9 in) height
	330 mm (13 in) with feet extended	330 mm (13 in) with feet extended
	451 mm (17.75 in) width	451 mm (17.75 in) width
	442 mm (17.4 in) depth	432 mm (17.02 in) depth
≥ 4 GHz models Rackmount configuration	With rack handles	Without rack handles
	267 mm (10.5 in) height	267 mm (10.5 in) height
	502 mm (19.75 in) width	482 mm (19 in) width
	489 mm (19.4 in) depth	442 mm (17.4 in) depth
<b>Cooling</b>		
Required clearances	Fan-forced air circulation with no air filter	
	Top	0 mm (0 in)
	Bottom	6.35 mm (0.25 in) minimum or 0 mm (0 in) when standing on feet, flip stands down
	Left side	76 mm (3 in)
	Right side	76 mm (3 in) ≥4 GHz models 0 mm (0 in) ≤ 4 GHz models
	Rear	0 mm (0 in) on rear feet
Construction material	Chassis parts are constructed of aluminum alloy, front panel is constructed of plastic laminate, circuit boards are constructed of glass laminate	

**Table 1-10: Environmental specifications, all MSO70000/C, DSA/DPO70000B/C, and DPO7000 Series models**

Characteristic	Description
Temperature, < 4 GHz models	
operating	+5 °C to +45 °C (41 °F to +113 °F), with noncondensing conditions
Nonoperating	-40 °C to +71 °C (-40 °F to +160 °F), with 15 °C/hour maximum gradient, without disk media installed in disk drives
Temperature, ≥ 4 GHz models	
operating	+5 °C to +45 °C (41 °F to +113 °F), with 11 °C per hour maximum gradient, noncondensing, derated 1 °C per 300 meters (984.25 feet) above 1500 meters (4921.25 feet) altitude
Nonoperating	-20 °C to +60 °C (-4 °F to +140 °F), with 20 °C/hour maximum gradient, without disk media installed in disk drives
Humidity, < 4 GHz models	
operating	8% to 80% relative humidity with a maximum wet-bulb temperature of +29 °C (84 °F) at or below +45 °C (113 °F), noncondensing Upper limit derated to 30% relative humidity at +45 °C (+113 °F)
Nonoperating	5% to 90% relative humidity with a maximum wet-bulb temperature of +29 °C (84 °F) at or below +60 °C (140 °F), noncondensing Upper limit derated to 20% relative humidity at +60 °C (+140 °F)
Humidity, ≥ 4 GHz models	
Humidity, operating	8% to 80% relative humidity at up to +32 °C (+90 °F) 5% to 45% relative humidity above +32 °C (+90 °F) up to +45 °C (+113 °F), noncondensing, and is limited by a maximum wet-bulb temperature of +29.4 °C (+85 °F) (derates relative humidity to 32% at +45 °C (+113 °F))
Nonoperating	5% to 95% relative humidity at up to +30 °C (+86 °F), 5% to 45% relative humidity above +30 °C (+86 °F), up to +60 °C (+140 °F), noncondensing, and is limited by a maximum wet-bulb temperature of +29.4 °C (+85 °F) (derates relative humidity to 11% at +60 °C (+140 °F))
Altitude	
< 4 GHz models: operating	Up to 3,000 meters (9,843 feet)
Nonoperating	Up to 12,192 meters (40,000 feet)
≥ 4 GHz models: operating	Up to 3,000 meters (9,843 feet), derate maximum operating temperature by 1 °C per 300 meters (984.25 feet) above 1500 meters (4921.25 feet) altitude
Nonoperating	Up to 12,000 meters (39,370 feet)

---

# Specifications (MSO/DPO5000 Series)



# Specifications (MSO/DPO5000 Series)

This chapter contains specifications for the MSO5000 and DPO5000 series oscilloscopes. All specifications are guaranteed unless noted as "typical." Typical specifications are provided for your convenience but are not guaranteed. Specifications that are marked with the ✓ symbol are checked in *Performance Verification*.

All specifications apply to all MSO5000 and DPO5000 models unless noted otherwise. To meet specifications, two conditions must first be met:

- The oscilloscope must have been operating continuously for twenty minutes within the operating temperature range specified.
- You must perform the Signal Path Compensation (SPC) operation before evaluating the instrument's performance to the specifications. (See page 4-26, *Self Test*.) If the operating temperature changes by more than 10 °C (18 °F), perform the SPC operation again.

**Table 2-1: Analog channel input and vertical specification**

Characteristic	Description	
Number of input channels	4 analog channels, digitized simultaneously	
Input coupling	DC or AC	
Input resistance selection	1 MΩ or 50 Ω 250 kΩ selectable for performance verification.	
✓ Input impedance, DC coupled	1 MΩ	1 MΩ ±1%
	50 Ω	50 Ω ±1%
	MSO5204, DPO5204	VSWR ≤1.5:1 from DC to 2 GHz, typical
	MSO5104, DPO5104	VSWR ≤1.5:1 from DC to 1 GHz, typical
	MSO5054, DPO5054	VSWR ≤1.5:1 from DC to 500 MHz, typical
	MSO5034, DPO5034	VSWR ≤1.5:1 from DC to 350 MHz, typical
Input Capacitance, 1 MΩ DC coupled	13 pF ± 2 pF	

**Table 2-1: Analog channel input and vertical specification (cont.)**

Characteristic	Description		
Maximum input voltage	1 M $\Omega$	300 V <sub>RMS</sub> with peaks $\leq \pm 425$ V at the BNC Installation Category II For <100 mV/div, derate at 20 dB/decade above 100 kHz to 30 V <sub>RMS</sub> at 1 MHz, 10 dB/decade above 1 MHz For $\geq 100$ mV/div, derate at 20 dB/decade above 3 MHz to 30 V <sub>RMS</sub> at 30 MHz, 10 dB/decade above 30 MHz	
	50 $\Omega$	5 V <sub>RMS</sub> with peaks $\leq \pm 20$ V (DF $\leq 6.25\%$ ) Overvoltage trip is intended to protect against overloads that might damage termination resistors. A sufficiently large impulse might cause damage regardless of the overvoltage protection circuitry because of the finite time required to detect and respond.	
✓ DC Balance	0.1 div with the input DC 50 $\Omega$ coupled and 50 $\Omega$ terminated 0.2 div at 1 mV/div with the input DC 50 $\Omega$ coupled and 50 $\Omega$ terminated 0.2 div with the input DC 1 M $\Omega$ coupled and 50 $\Omega$ terminated		
Number of digitized bits	8 bits Displayed vertically with 25 digitization levels (DL) per division, 10.24 divisions dynamic range. "DL" is the abbreviation for "digitization level." A DL is the smallest voltage level change that can be resolved by an 8-bit A-D Converter. This value is also known as the LSB (least significant bit).		
Sensitivity range (coarse)	1 M $\Omega$	1 mV/div to 10 V/div in a 1-2-5 sequence	
	50 $\Omega$	1 mV/div to 1 V/div in a 1-2-5 sequence	
Sensitivity range (fine)	1 M $\Omega$	1 mV/div to 5 V/div	<-50% to >+50% of selected setting
		10 V/div	<-50% to 0%
	50 $\Omega$	1 mV/div to 500 mV/div	<-50% to >+50% of selected setting
		1 V/div	<-50% to 0%
	Allows continuous adjustment from 1 mV/div to 10 V/div		Allows continuous adjustment from 1 mV/div to 1 V/div
Sensitivity resolution (fine), typical	$\leq 1\%$ of current setting		
✓ DC gain accuracy	For 50 $\Omega$ , 1 M $\Omega$ , TPP0500, and TPP1000 path: $\pm 1.5\%$ , derated at 0.100%/°C above 30 °C $\pm 2.0\%$ , derated at 0.100%/°C above 30 °C, 1 mV/Div setting $\pm 3.0\%$ variable gain, derated at 0.100%/°C above 30 °C		

**Table 2-1: Analog channel input and vertical specification (cont.)**

Characteristic	Description	Offset range		
Offset ranges, minimum	<i>Volts/div setting</i>	1 M $\Omega$ input	50 $\Omega$ input	
		1 mV/div to 50 mV/div	$\pm 1$ V	$\pm 1$ V
		50.5 mV/div to 99.5 mV/div	$\pm 0.5$ V	$\pm 0.5$ V
		100 mV/div to 500 mV/div	$\pm 10$ V	$\pm 10$ V
		505 mV/div to 995 mV/div	$\pm 5$ V	$\pm 5$ V
		1 V/div to 5 V/div	$\pm 100$ V	$\pm 5$ V
		5.05 V/div to 10 V/div	$\pm 50$ V	Not applicable
		For 50 $\Omega$ path, 1 V/div is the maximum vertical setting. The input signal cannot exceed Max Input Voltage for the 50 $\Omega$ input path. Refer to the Max Input Voltage specification for more information.		
Position range	$\pm 5$ divisions			
↗ Offset accuracy	$\pm [0.005 \times   \text{offset} - \text{position}   + \text{DC Balance}]$ Both the position and constant offset term must be converted to volts by multiplying by the appropriate volts/div term.			
Number of Waveforms for Average Acquisition Mode	2 to 10,000 waveforms Default of 16 waveforms			
DC voltage measurement accuracy	Average of $\geq 16$ waveforms	$\pm [\text{DC Gain Accuracy} \times   \text{reading} - (\text{offset} - \text{position})   + \text{offset accuracy} + 0.1 \text{ division}]$ Refer to DC Gain Accuracy for temperature derating information.		
	Average acquisition mode Delta Volts between any two averages of $\geq 16$ waveforms acquired with the same oscilloscope setup and ambient conditions	$\pm [\text{DC gain accuracy} \times   \text{reading}   + 0.05 \text{ div}]$ Refer to DC Gain Accuracy for temperature derating information.		
Note: Offset, position, and the constant offset term must be converted to volts by multiplying by the appropriate volts/div term. The basic accuracy specification applies directly to any sample and to the following measurements: High, Low, Max, Min, Mean, Cycle Mean, RMS, and Cycle RMS. The delta volt accuracy specification applies to subtractive calculations involving two of these measurements. The delta volts (difference voltage) accuracy specification applies directly to the following measurements: Positive Overshoot, Negative Overshoot, Peak-to-Peak, and Amplitude.				

**Table 2-1: Analog channel input and vertical specification (cont.)**

Characteristic	Description		
Sample acquisition mode, typical	<i>Measurement type</i>		<i>DC Accuracy (in volts)</i>
	Any sample	±[DC gain accuracy ×   reading - (offset - position)   + offset accuracy + 0.15 div + 0.6 mV] Refer to DC Gain Accuracy for temperature derating information.	
	Delta volts between any two samples acquired with the same oscilloscope setup and ambient conditions	±[DC gain accuracy ×   reading   + 0.15 div + 1.2 mV] Refer to DC Gain Accuracy for temperature derating information.	
	Offset, position, and the constant offset term must be converted to volts by multiplying by the appropriate volts/div term.		
Analog bandwidth selections	20 MHz, 250 MHz, and Full		
✓ Analog bandwidth, 50 Ω, DC coupled	Full bandwidth, with amplitude tolerance of -3 dB and operating temperatures of ≤30 °C (86 °F). Reduce the bandwidth by 1% for each °C above 30 °C.		
	<i>Instrument</i>	<i>SCALE range</i>	<i>Bandwidth</i>
	MSO5204, DPO5204	10 mV/div — 1 V/div	DC to 2.00 GHz
		5 mV/div — 9.98 mV/div	DC to 1.50 GHz
		2 mV/div — 4.98 mV/div	DC to 350 MHz
		1 mV/div — 1.99 mV/div	DC to 175 MHz
	MSO5104, DPO5104	5 mV/div — 1 V/div	DC to 1.00 GHz
		2 mV/div — 4.98 mV/div	DC to 350 MHz
		1 mV/div — 1.99 mV/div	DC to 175 MHz
	MSO5054, DPO5054	5 mV/div — 1 V/div	DC to 500 MHz
		2 mV/div — 4.98 mV/div	DC to 350 MHz
		1 mV/div — 1.99 mV/div	DC to 175 MHz
	MSO5034, DPO5034	2 mV/div — 1 V/div	DC to 350 MHz
		1 mV/div — 1.99 mV/div	DC to 175 MHz



**Table 2-1: Analog channel input and vertical specification (cont.)**

<b>Characteristic</b>	<b>Description</b>		
✓ Analog bandwidth, 1 M $\Omega$ , DC coupled	Full bandwidth, with amplitude tolerance of -3 dB and operating temperatures of $\leq 30$ °C (86 °F). Reduce the bandwidth by 1% for each °C above 30 °C.		
	<i>Instrument</i>	<i>SCALE range</i>	<i>Bandwidth</i>
	MSO5204, DPO5204,	5 mV/div — 10 V/div	DC to 500 MHz
	MSO5104, DPO5104	2 mV/div — 4.98 mV/div	DC to 350 MHz
		1 mV/div — 1.99 mV/div	DC to 175 MHz
	MSO5054, typical	5 mV/div — 10 V/div	DC to 500 MHz
	DPO5054, typical	2 mV/div — 4.98 mV/div	DC to 350 MHz
		1 mV/div — 1.99 mV/div	DC to 175 MHz
	MSO5034, typical	5 mV/div — 10 V/div	DC to 350 MHz
	DPO5034, typical	2 mV/div — 4.98 mV/div	DC to 350 MHz
		1 mV/div — 1.99 mV/div	DC to 175 MHz
	The MSO/DPO5204 and MSO/DPO5104 models have separate 50 $\Omega$ and 1 M $\Omega$ analog paths, so they must be tested at both settings. All other models have one analog path, so the analog path is fully tested with the 50 $\Omega$ termination.		
	Analog bandwidth with TPP0500 and TPP1000 probe, typical	Full bandwidth, with amplitude tolerance of -3 dB and operating temperatures of $\leq 30$ °C (86 °F). Reduce the bandwidth by 1% for each °C above 30 °C.	
<i>Instrument</i>		<i>SCALE range</i>	<i>Bandwidth</i>
MSO5204, DPO5204,		50 mV/div — 100 V/div	DC to 1 GHz (TPP1000 probe)
MSO5104, DPO5104		20 mV/div — 49.8 mV/div	DC to 500 MHz (TPP0500 probe)
		10 mV/div — 19.9 mV/div	DC to 350 MHz
MSO5054, DPO5054		10 mV/div — 19.9 mV/div	DC to 175 MHz
		50 mV/div — 100 V/div	DC to 500 MHz
		20 mV/div — 49.8 mV/div	DC to 350 MHz
		10 mV/div — 19.9 mV/div	DC to 175 MHz
MSO5034, DPO5034		50 mV/div — 100 V/div	DC to 350 MHz
		20 mV/div — 49.8 mV/div	DC to 350 MHz
		10 mV/div — 19.9 mV/div	DC to 175 MHz
Lower frequency limit, AC coupled, typical		< 10 Hz when AC, 1 M $\Omega$ coupled The AC coupled lower frequency limits are reduced by a factor of 10 when 10X passive probes are used.	

**Table 2-1: Analog channel input and vertical specification (cont.)**

<b>Characteristic</b>	<b>Description</b>				
Upper frequency limit, 250 MHz bandwidth limited, typical	250 MHz, ±20%				
Upper frequency limit, 20 MHz bandwidth limited, typical	20 MHz, ±20%				
Calculated rise time, typical	Calculated Rise Time at 350/BW (MHz). The formula is calculated by measuring -3 dB bandwidth of the oscilloscope. The formula accounts for the rise time contribution of the oscilloscope independent of the rise time of the signal source.				
	<i>Instrument</i>	50 Ω 10 mV/div to 1 V/div	50 Ω 5 mV/div to 9.98 mV/div	50 Ω 2 mV/div to 4.99 mV/div	50 Ω 1 mV/div to 1.99 mV/div
	MSO5204, DPO5204	175 ps	233 ps	1 ns	2 ns
	<i>Instrument</i>		50 Ω 5 mV/div to 1 V/div	50 Ω 2 mV/div to 4.99 mV/div	50 Ω 1 mV/div to 1.99 mV/div
	MSO5104, DPO5104		350 ps	1 ns	2 ns
	MSO5054, DPO5054		700 ps	1 ns	2 ns
	MSO5034, DPO5034		1 ns	1 ns	2 ns
	<i>Instrument</i>		<i>TPP1000 probe</i> 50 mV/div to 100 mV/div	<i>TP1000 probe</i> 20 mV/div to 49.8 mV/div	<i>TPP1000 probe</i> 10 mV/div to 19.9 mV/div
	MSO5204, DPO5204		350 ps	1 ns	2 ns
	MSO5104, DPO5104		350 ps	1 ns	2 ns
	MSO5054, DPO5054		700 ps	1 ns	2 ns
	MSO5034, DPO5034		1 ns	1 ns	2 ns
	<i>Instrument</i>		<i>TPP0500 probe</i> 50 mV/div to 10 V/div	<i>TPP0500 probe</i> 20 mV/div to 49.8 mV/div	<i>TPP0500 probe</i> 10 mV/div to 19.9 mV/div
	MSO5204, DPO5204		700 ps	1 ns	2 ns
	MSO5104, DPO5104		700 ps	1 ns	2 ns
	MSO5054, DPO5054		700 ps	1 ns	2 ns
	MSO5034, DPO5034		1 ns	1 ns	2 ns

**Table 2-1: Analog channel input and vertical specification (cont.)**

Peak Detect or Envelope mode pulse response, typical	<i>Instrument (Sample Rate Maximum)</i>		<i>Minimum pulse width</i>		
	MSO5204, DPO5204, MSO5104, DPO5104		>100 ps		
		MSO5054, DPO5054, MSO5034, DPO5034		>200 ps	
Effective bits, typical	Specifications are valid at maximum per channel sample rate and at 1k record length.				
	<i>Model</i>	<i>Input frequency</i>		<i>Effective bits</i>	
	MSO5204, DPO5204	4.9 MHz		6.0 bits	
		2 GHz		6.0 bits	
	MSO5104, DPO5104	4.9 MHz		6.0 bits	
		1 GHz		6.0 bits	
	MSO5054, DPO5054	4.9 MHz		6.0 bits	
		500 MHz		6.0 bits	
	MSO5034, DPO5034	4.9 MHz		6.0 bits	
		350 MHz		6.0 bits	
✓ Random Noise, Sample Acquisition Mode	<i>Instrument</i>	<i>Bandwidth limit</i>	<i>RMS noise</i>		
			<i>1 M<math>\Omega</math></i>	<i>50 <math>\Omega</math></i>	
	MSO5204, DPO5204	Full Bandwidth	$\leq(180 \mu\text{V} + 8.0\% \text{ of Volts/div setting})$		$\leq(150 \mu\text{V} + 6.0\% \text{ of Volts/div setting})$
		250 MHz bandwidth	$\leq(120 \mu\text{V} + 5.0\% \text{ of Volts/div setting})$		$\leq(75 \mu\text{V} + 4.0\% \text{ of Volts/div setting})$
		20 MHz bandwidth	$\leq(120 \mu\text{V} + 5.0\% \text{ of Volts/div setting})$		$\leq(75 \mu\text{V} + 4.0\% \text{ of Volts/div setting})$
	MSO5104, DPO5104	Full Bandwidth	$\leq(150 \mu\text{V} + 8.0\% \text{ of Volts/div setting})$		$\leq(75 \mu\text{V} + 6.0\% \text{ of Volts/div setting})$
		250 MHz bandwidth	$\leq(100 \mu\text{V} + 5.0\% \text{ of Volts/div setting})$		$\leq(50 \mu\text{V} + 4.0\% \text{ of Volts/div setting})$
		20 MHz bandwidth	$\leq(100 \mu\text{V} + 5.0\% \text{ of Volts/div setting})$		$\leq(50 \mu\text{V} + 4.0\% \text{ of Volts/div setting})$
	MSO5054, DPO5054	Full Bandwidth	$\leq(130 \mu\text{V} + 8.0\% \text{ of Volts/div setting})$		$\leq(130 \mu\text{V} + 8.0\% \text{ of Volts/div setting})$
		250 MHz bandwidth	$\leq(100 \mu\text{V} + 6.0\% \text{ of Volts/div setting})$		$\leq(100 \mu\text{V} + 6.0\% \text{ of Volts/div setting})$
		20 MHz bandwidth	$\leq(100 \mu\text{V} + 4.0\% \text{ of Volts/div setting})$		$\leq(100 \mu\text{V} + 4.0\% \text{ of Volts/div setting})$
	MSO5034, DPO5034	Full Bandwidth	$\leq(130 \mu\text{V} + 8.0\% \text{ of Volts/div setting})$		$\leq(130 \mu\text{V} + 8.0\% \text{ of Volts/div setting})$
		250 MHz bandwidth	$\leq(100 \mu\text{V} + 6.0\% \text{ of Volts/div setting})$		$\leq(100 \mu\text{V} + 6.0\% \text{ of Volts/div setting})$
		20 MHz bandwidth	$\leq(100 \mu\text{V} + 4.0\% \text{ of Volts/div setting})$		$\leq(100 \mu\text{V} + 4.0\% \text{ of Volts/div setting})$

**Table 2-1: Analog channel input and vertical specification (cont.)**

Delay between channels, full bandwidth, typical	<p>≤100 ps between any two channels with input impedance set to 50 Ω, DC coupling, with equal volts/division setting or above 10 mV/div</p> <p>All settings in the instrument can be manually time aligned using the Probe Deskew function from -125 ns to +125 ns with a resolution of 20 ps</p>		
Deskew range	-125 ns to +125 ns with a resolution of 20 ps		
Crosstalk (channel isolation), typical	≥100:1 at ≤100 MHz and ≥30:1 at >100 MHz up to the rated bandwidth for any two channels having equal Volts/Div settings		
TekVPI Interface	<p>The probe interface allows installing, powering, compensating, and controlling a wide range of probes offering a variety of features.</p> <p>The interface is available on all front panel inputs including Aux In. Aux In only provides 1 MΩ input impedance and does not offer 50 Ω as the other input channels do.</p>		
Total probe power	<p>Five TekVPI-compliant probe interfaces (one per channel)</p> <p>12 W maximum internal probe power</p> <p>Provision for 50 W external probe power from rear panel</p>		
Probe power per channel	<i>Voltage</i>	<i>Max Amperage</i>	<i>Voltage Tolerance</i>
	5 V	50 mA (250 mW)	±5%
	12 V	2 A (24 W)	±10%

**Table 2-2: Horizontal and acquisition system specifications**

Characteristic	Description					
Sample rate	<i>Instrument</i>	<i>Maximum sample rate</i>			<i>Number of channels</i>	
	MSO5204, DPO5204, MSO5104, DPO5104	10 GS/s			1 or 2	
		5 GS/s			3 or 4	
	MSO5054, DPO5054, MSO5034, DPO5034	5 GS/s			1 – 4	
Record length						
Analog channels	<i>Option</i>	<i>Number of Channels</i>	<i>2 GHz</i>	<i>1 GHz</i>	<i>500 MHz</i>	<i>350 MHz</i>
Standard		3 or 4	12.5 M	12.5 M	12.5 M	12.5 M
		1 or 2	25 M	25 M	12.5 M	12.5 M
Option 2RL		3 or 4	25 M	25 M	25 M	25 M
		1 or 2	50 M	50 M	25 M	25 M
Option 5RL		3 or 4	50 M	50 M	50 M	50 M
		1 or 2	125 M	125 M	50 M	50 M
Option 10RL		3 or 4	125 M	125 M	125 M	125 M
		1 or 2	250 M	250 M	125 M	125 M
Record Length	The record length ranges for a standard instrument are the same as for the analog channel specification table (above).					
Digital channels	The record length ranges for an instrument with an option are the same as for the analog channel specifications, up to 40M.					
Seconds/Division range	<i>Record length</i>					
	<i>1 K</i>	<i>10 K</i>	<i>&gt;10 K</i>			
	200 ps – 40 s	200 ps – 400 s	200 ps – 1.00 ks			
Maximum update rate	Maximum triggered acquisition rate: >250,000 wfm/s					
Aperture Uncertainty	$\leq(3 \text{ ps} + 0.1 \text{ ppm} \times \text{record duration})_{\text{RMS}}$ , for records having $\leq 1$ minute duration					
✓ Long-term sample rate and delay time accuracy	$\pm 5$ ppm over any $\geq 1$ ms time interval					

**Table 2-2: Horizontal and acquisition system specifications (cont.)**

Characteristic	Description
<p>✓ Delta-time measurement accuracy</p>	<p>The formula to calculate the delta-time measurement accuracy (<math>DTA_{max}</math>) for a given instrument setting and input signal is given below (assumes insignificant signal content above Nyquist and insignificant error due to aliasing):</p> <p><math>SR_1</math> = slew rate around 1st point in measurement (1<sup>st</sup> edge)  <math>SR_2</math> = slew rate around 2nd point in measurement (2<sup>nd</sup> edge)  <math>N</math> =input-referred noise (<math>V_{RMS}</math>)  <math>TBA</math> = time base accuracy (5 ppm)  <math>t_p</math> = delta-time measurement duration (seconds)  <math>RD</math> = (record length)/(sample rate)  <math>t_{sr} = 1/(\text{sample rate})</math>                      assume edge shape that results from Gaussian filter response</p> $DTA_{pk-pk} = \frac{\pm 5 \times \sqrt{2 \left[ \frac{N}{SR_1} \right]^2 + 2 \left[ \frac{N}{SR_2} \right]^2 + (3ps + 1 \times 10^{-7} \times RD)^2 + 2t_{sr} + TBA \times t_p}}{}$ <hr/> $DTA_{rms} = \frac{\sqrt{2 \left[ \frac{N}{SR_1} \right]^2 + 2 \left[ \frac{N}{SR_2} \right]^2 + (3ps + 1 \times 10^{-7} \times RD)^2 + \left( \frac{2 \times t_{sr}}{\sqrt{12}} \right)^2 + TBA \times t_p}}{}$ <hr/> <p>The term under the square-root sign is the stability and is due to TIE (Time Interval Error). The errors due to this term occur throughout a single-shot measurement. The second term is due to both the absolute center-frequency accuracy and the center-frequency stability of the time base and varies between multiple single-shot measurements over the observation interval (the amount of time from the first single-shot measurement to the final single-shot measurement). The observation interval may not exceed 1 year.</p>

Table 2-3: Trigger specifications

Characteristic	Description		
Aux In (External) trigger input impedance, typical	1 M $\Omega$ $\pm$ 1% in parallel with 13 pF $\pm$ 2 pF		
Aux In (External) trigger maximum input voltage	The maximum input voltage at the BNC 300 V <sub>RMS</sub> Installation Category II Derate at 20 dB/decade above 3 MHz to 30 V <sub>RMS</sub> at 30 MHz, 10 dB/decade above 30 MHz.		
Aux In (External) trigger bandwidth, typical	250 MHz $\pm$ 20%		
Trigger bandwidth, Edge, typical	MSO5204, DPO5204	2 GHz	
	MSO5104, DPO5104	1 GHz	
	MSO5054, DPO5054	500 MHz	
	MSO5034, DPO5034	350 MHz	
Trigger bandwidth, Pulse and Logic, typical	MSO5204, DPO5204	1 GHz	
	MSO5104, DPO5104	1 GHz	
	MSO5054, DPO5054	500 MHz	
	MSO5034, DPO5034	350 MHz	
Edge-type trigger sensitivity, DC coupled, typical	Models	<i>Trigger Source</i>	<i>Sensitivity</i>
	MSO5204, DPO5204 MSO5104, DPO5104	Any input channel	50 $\Omega$ path: 0.40 div from DC to 50 MHz, increasing to 1 div at oscilloscope bandwidth
	MSO5054, DPO5054 MSO5034, DPO5034	Any input channel	50 $\Omega$ path: 1 mV/div to 4.98 mV/div – 0.75 div from DC to 50 MHz, increasing to 1.3 div at oscilloscope bandwidth. $\geq$ 5 mV/div 0.040 div from DC to 50 MHz, increasing to 1 div at oscilloscope bandwidth.
	All models	Any input channel	1 M $\Omega$ path: 1 mV/div to 4.98 mV/div – 0.75 div from DC to 50 MHz, increasing to 1.3 div at oscilloscope bandwidth. $\geq$ 5 mV/div 0.040 div from DC to 50 MHz, increasing to 1 div at oscilloscope bandwidth.
	All models	Aux in (External)	200 mV from DC to 50 MHz, increasing to 500 mV at 250 MHz
	All models	Line	Fixed
Trigger jitter	$\leq$ 10 pS <sub>RMS</sub> for edge-type trigger		
	$\leq$ 100 pS <sub>RMS</sub> for non edge-type trigger modes		

**Table 2-3: Trigger specifications (cont.)**

<b>Characteristic</b>	<b>Description</b>			
Edge-type trigger sensitivity, not DC coupled, typical	<i>Trigger Coupling</i>		<i>Typical Sensitivity</i>	
	AC Coupling	1 div for frequencies above 45 Hz. Attenuates signals below 45 Hz.		
	NOISE REJ	2.5 times the DC-coupled limits		
	HF REJ	1.0 times the DC-coupled limit from DC to 50 kHz. Attenuates signals above 50 kHz		
	LF REJ	1.5 times the DC-coupled limits for frequencies above 50 kHz. Attenuates signals below 50 kHz		
Video-type trigger formats and field rates	Triggers from negative sync composite video, field 1 or field 2 for interlaced systems, on any field, specific line, or any line for interlaced or non-interlaced systems. Supported systems include NTSC, PAL, and SECAM.			
Video-type trigger sensitivity, typical	<i>Delayed and main trigger</i>			
	<i>Source</i>		<i>Sensitivity</i>	
	Any input channel	0.6 to 2.5 divisions of video sync tip		
	Aux In (External)	Video not supported through Aux In (External) input		
Lowest frequency for successful operation of "Set Level to 50%" function, typical	45 Hz			
Logic-type or logic qualified trigger or events-delay sensitivities, DC coupled, typical	1.0 division from DC to maximum bandwidth			
Pulse-type runt trigger sensitivities, typical	1.0 division from DC to maximum bandwidth			
Pulse-type trigger width and glitch sensitivities, typical	1.0 division			
Logic-type triggering, minimum logic or rearm time, typical	For all vertical settings, the minimums are:			
	<i>Trigger type</i>	<i>Pulse width</i>	<i>Re-arm time</i>	<i>Time between channels</i>
	Logic	Not applicable	2 ns	1 ns
	Time Qualified Logic	4 ns	2 ns	1 ns
	For logic, time between channels refers to the length of time a logic state derived from more than one channel must exist to be recognized. For events, the time is the minimum time between a main and delayed event that will be recognized if more than one channel is used.			
Minimum clock pulse widths for setup/hold time violation trigger, typical	<i>For all vertical settings</i>			
	<i>Clock active</i>		<i>Clock inactive</i>	
	User hold time + 2.5 ns	2 ns		
	An active pulse width is the width of the clock pulse from its active edge to its inactive edge. An inactive pulse width is the width of the pulse from its inactive edge to its active edge. The User hold time is the number selected by the user.			



Table 2-3: Trigger specifications (cont.)

Characteristic	Description		
Setup/hold violation trigger, setup and hold time ranges	<i>Feature</i>	<i>Min</i>	<i>Max</i>
	Setup time	-0.5 ns	1.0 ms
	Hold time	1 ns	1.0 ms
	Setup + Hold time	0.5 ns	2.0 ms
	Input coupling on clock and data channels must be the same. For Setup time, positive numbers mean a data transition before the clock. For Hold time, positive numbers mean a data transition after the clock edge. Setup + Hold time is the algebraic sum of the Setup Time and Hold Time that you programmed.		
Pulse type trigger, minimum pulse, rearm time, transition time	<i>Pulse class</i>	<i>Minimum pulse width</i>	<i>Minimum rearm time</i>
	Glitch	4 ns	2 ns + 5% of glitch width setting
	Runt	4 ns	2 ns
	Time-qualified runt	4 ns	8.5 ns + 5% of width setting
	Width	4 ns	2 ns + 5% of width upper limit setting
	Slew rate (transition time)	4 ns	8.5 ns + 5% of delta time setting
	For the trigger class width and the trigger class runt, the pulse width refers to the width of the pulse being measured. The rearm time refers to the time between pulses. For trigger class runt, pulse width refers to the width of the pulse being measured. Rearm time refers to the time between pulses. For the trigger class slew rate, the pulse width refers to the delta time being measured. The rearm time refers to the time it takes the signal to cross the two trigger thresholds again.		
Transition time trigger, delta time range	4 ns to 8 s		
Time range for glitch, width, timeout, or time-qualified runt	4 ns to 8 s		
Time Accuracy for Glitch, Timeout, or Width Triggering	<i>Time Range</i>	<i>Accuracy</i>	
	1 ns to 500 ns	±(20% of setting + 0.5 ns)	
	520 ns to 1 s	±(0.01% of setting + 100 ns)	
B trigger after events, minimum pulse width and maximum event frequency, typical	4 ns, 500 MHz		
B trigger, minimum time between arm and trigger, typical	4 ns		
	For trigger after time, this is the time between the end of the time period and the B trigger event. For trigger after events, this is the time between the last A trigger event and the first B trigger event.		
B trigger after time, time range	4 ns to 8 seconds		
B trigger after events, event range	1 to 4,000,000 events		

**Table 2-3: Trigger specifications (cont.)**

<b>Characteristic</b>	<b>Description</b>	
Trigger level ranges	<i>Source</i>	<i>Range</i>
	Any input channel	±8 divisions from center of screen ±8 divisions from 0 V when vertical LF reject trigger coupling is selected
	Aux In (External)	±8 V
	Line	Not applicable
	Line trigger level is fixed at about 50% of the line voltage. This specification applies to logic and pulse thresholds.	
Trigger level accuracy, DC coupled	<i>Source</i>	<i>Range</i>
	Any input channel	±0.20 div
	Aux In (External)	±(10% of setting + 25 mV)
	Line	Not applicable
	For signals having rise and fall times ≥10 ns.	
Trigger holdoff range	20 ns minimum to 8 s maximum	
Maximum serial trigger bits	128 bits	
Standard serial bus interface triggering		
I <sup>2</sup> C	<b>Address Triggering:</b> 7 and 10 bit user specified address, as well as General Call, START byte, HS-mode, EEPROM, and CBUS <b>Data Trigger:</b> 1 to 5 bytes of user specified data <b>Trigger On:</b> Start, Repeated Start, Stop, Missing Ack, Address, Data, or Address and Data <b>Maximum Data Rate:</b> 10 Mbps	
SPI	<b>Data Trigger:</b> 1 to 16 bytes of user-specified data <b>Trigger On:</b> SS Active, MOSI, MISO, or MOSI and MISO <b>Maximum Data Rate:</b> 10 Mbps	
RS-232	<b>Bit Rate:</b> 50 bps to 10 Mbps <b>Data Bits:</b> 7, 8, or 9 <b>Parity:</b> None, Odd, or Even <b>Trigger On:</b> Tx Start Bit, Rx Start Bit, Tx End of Packet, Rx End of Packet, Tx Data, Rx Data, Tx Parity Error, or Rx Parity Error <b>End of Packet:</b> 00 (NUL), 0A (LF), 0D (CR), 20 (SP), FF	
USB	<b>Data Rates Supported:</b> HS to 480 Mbs, Full to 12 Mbs, Low to 1.5 Mbs <b>Trigger On:</b> Sync, Reset, Suspend, Resume, End of Packet, Token (Address) Packet, Data Packet, Handshake Packet, Special Packet, Error	

**Table 2-4: Digital acquisition specifications, MSO5000 Series**

Characteristic	Description
Threshold voltage range	-40 V to +40 V
Digital channel timing resolution	2 ns main memory, 60.6 ps for MagniVu memory
✓ Logic threshold accuracy	$\pm(100 \text{ mV} + 3\% \text{ of threshold setting after calibration})$ Requires valid SPC. (See page 4-26, <i>Self Test</i> .)
Minimum detectable pulse width	1 ns Using MagniVu memory. Requires the use of 342-1140-00 ground clip per channel.

**Table 2-5: P6616 Digital Probe specifications**

Characteristic	Description
Number of channels	16 digital inputs
Input resistance, Typical	100 k $\Omega$ to ground
Input capacitance, Typical	3.0 pF Measured at the podlet input. Requires the use of 342-1140-00 ground clip per channel
Minimum input signal swing	400 mV <sub>p-p</sub> Requires the use of 342-1140-00 ground clip per channel
Maximum input signal swing	30 V <sub>p-p</sub> for $f_{in} \leq 200 \text{ MHz}$ (centered around the DC threshold voltage) at the P6616 probe tip. 10 V <sub>p-p</sub> for $f_{in} > 200 \text{ MHz}$ (centered around the DC threshold voltage) at the P6616 probe tip. Failure to meet this input signal requirement will compromise the AC performance of the digital channel. It might also damage the input circuitry. See the Absolute maximum input voltage specification.
Maximum Input Toggle Rate	500 MHz Maximum frequency sine wave input that can accurately be reproduced as a logic square wave. Requires the use of a 342-1140-00 ground clip on each channel. This is the maximum frequency at the minimum swing amplitude. Higher toggle rates can be achieved with higher amplitudes.
Absolute maximum input voltage	$\pm 42 \text{ V}$ peak at the P6616 input (not at the instrument input) Probe input voltages beyond this limit could permanently damage the instrument and the P6616 probe.
Channel-to-channel skew	200 ps Digital channel to digital channel only. This is the propagation path skew and ignores skew contributions due to threshold inaccuracies (see Threshold accuracy) and sample binning (see Digital channel timing resolution). Factory calibration/deskew is required to achieve this number.

Table 2-6: Display specifications

Characteristic	Description
Display type	Display area: 210.4 mm (8.28 in) (H) x 157.8 mm (6.21 in) (V), 264 mm (10.4 in) diagonal, 6-bit RGB full color, XGA (1024 x 768) TFT liquid crystal display (LCD).
Display resolution	1024 X 768 XGA display resolution
Luminance, Typical	400 cd/m <sup>2</sup>
Waveform display color scale	The TFT display can support up to 262,144 colors. A subset of these colors are used for the oscilloscope display, all of which are fixed colors and not changeable by the user.

Table 2-7: Input/Output port specifications

Characteristic	Description
Ethernet interface	Standard on all models: 10/100/1000 Mbps
GPIO interface	Available as an optional accessory that connects to the USB Device and USB Host ports with the TEK-USB-488 GPIO to USB Adapter The control interface is incorporated into the instrument user interface.
Video signal output	A 15 pin D-sub, VGA-type connector, supporting a minimum resolution range of 640X480 to 1280X1024.
USB interface	1 USB device connector (2.0 Full Speed), on the instrument rear panel. 6 USB host connectors (2.0 HS), two on the instrument front and four on the rear.
Probe compensator output voltage and frequency, typical	Output voltage 0 V to 2.5 V $\pm$ 1% behind 1 k $\Omega$ $\pm$ 2%
	Frequency 1 kHz $\pm$ 25%
✓ Auxiliary output (AUX OUT) Trigger Out or Reference Clock Out	You can set the Auxiliary output to Trigger Out or Reference Clock Out. Reference Clock Out: Outputs the 10 MHz oscilloscope reference clock. Trigger Out: A HIGH to LOW transition indicates that the trigger occurred.
	<i>Trigger output logic levels</i>
	<i>Characteristic</i>
	<i>Limits</i>
Vout (HI)	$\geq$ 2.5 V open circuit
	$\geq$ 1.0 V into a 50 $\Omega$ load to ground
Vout (LO)	$\leq$ 0.7 V into a load of $\leq$ 4 mA
	$\leq$ 0.25 V into a 50 $\Omega$ load to ground
External Reference nominal input frequency	10 MHz You must select either the internal reference (default) or 10 MHz external.
External Reference input frequency variation tolerance	9.9 MHz to 10.1 MHz You must run SPC whenever the external reference is more than 0.2% (2000 ppm) different than the nominal reference frequency or reference at which SPC was last run. (See page 4-26, <i>Self Test</i> .) The time base changes in correspondence to the fluctuations in the external reference.
External Reference input sensitivity	Vin 1.5V <sub>p-p</sub> for input frequencies between 9.9 MHz and 10.1 MHz
External Reference input maximum input signal	7 V <sub>p-p</sub>
External Reference input impedance	Rin = 1.5 k $\Omega$ $\pm$ 20% in parallel with 15 pF $\pm$ 5 pF at 10 MHz

**Table 2-7: Input/Output port specifications (cont.)**

Characteristic	Description
Keyboard and Mouse ports	PS-2 compatible, instrument must be powered down to make connection
External audio ports	External audio jacks for microphone input and line output

**Table 2-8: Data storage specifications**

Characteristic	Description
Nonvolatile memory retention time, typical	No time limit for front-panel settings, saved waveforms, setups, and calibration constants
Real-time clock	A programmable clock providing time in years, months, days, hours, minutes, and seconds
Hard disk drive	The 2.5-inch SATA hard disk drive capacity is $\geq 160$ GB. Waveforms and setups are stored on the hard disk.

**Table 2-9: Power source specifications**

Characteristic	Description
Source voltage	100 V to 240 V $\pm 10\%$
Source frequency	(85 to 264 V) 45 Hz to 66 Hz (100 V to 132 V) 360 Hz to 440 Hz
Fuse rating	T6.3AH, 250 Vac The fuse cannot be replaced by the user.

**Table 2-10: Environmental specifications**

Characteristic	Description
Temperature	Operating: +5 °C to +50 °C (32 °F to +122 °F) Nonoperating: -20 °C to +60 °C (-4 °F to +140 °F)
Humidity	Operating: 8% to 90% relative humidity with a maximum wet bulb temperature of 29 °C at or below +50 °C (upper limit derates to 20.6% relative humidity at +50 °C). Non-condensing. Nonoperating: 5% to 98% relative humidity with a maximum wet bulb temperature of 40 °C at or below +60 °C (upper limit derates to 29.8% relative humidity at +60 °C). Non-condensing.
Altitude	Operating: 3,000 m (9,843 ft) Nonoperating: 9,144 m (30,000 ft)

**Table 2-11: Mechanical specifications**

<b>Characteristic</b>	<b>Description</b>
Dimensions	<p><i>Benchtop configuration (oscilloscope only)</i></p> <p>Height:</p> <p>9.3 in (236 mm) Feet folded in, handle folded down</p> <p>9.8 in (249 mm) Feet Folded out, handle folded down</p> <p>13.5 in (343 mm) Feet Folded in, handle folded up</p> <p>14.0 in (356 mm) Feet Folded out, handle folded up</p> <p>Width:</p> <p>17.3 in (439 mm) from handle hub to handle hub.</p> <p>Depth:</p> <p>8.0 in (203 mm) from back of feet to front of knobs.</p> <p>8.9 in (226 mm) from back of feet to front of front cover</p> <p>8.5 in (216 mm) from handle back to front of knobs.</p> <p><i>Box Dimensions:</i></p> <p>Height: 19.6 in (498 mm)</p> <p>Width: 18.0 in (457 mm)</p> <p>Length: 22.6 in (574 mm)</p> <p><i>Rackmount configuration (5U Rack Sizes)</i></p> <p>Height: 8.6 in ( 218 mm)</p> <p>Width: 19.2 in (488 mm) from outside of handle to outside of handle.</p> <p>Depth: 15.1 in (384 mm) from outside of handle to back of slide.</p>
Weight	<p>14.9 lbs (6.8 kg), standalone instrument, without front cover</p> <p>22.2 lbs (10.0 kg), instrument with rackmount, without front cover</p> <p>27.5 lbs (12.5kg), when packaged for domestic shipment, without rackmount</p>
Clearance Requirements	<p>Top: 0 in (0 mm)</p> <p>Bottom: 0 in (0 mm), on feet, with flip stands down</p> <p>Left side: 2 in (50.8 mm)</p> <p>Right side: 0 in (0 mm)</p> <p>Rear: 2 in (50.8 mm)</p>
Cooling	Fan-forced air circulation with no air filter.
Construction material	Chassis parts are constructed of aluminum alloy, front panel is constructed of plastic laminate, circuit boards are constructed of glass laminate.

---

# **Performance Verification (MSO70000/C Series, DSA/DPO70000B/C Series, and DPO7000 Series)**





---

# Performance Verification (MSO70000/C Series, DSA/DPO70000B/C Series, and DPO7000 Series)

Two types of Performance Verification procedures can be performed on these products: *Brief Procedures* and *Performance Tests*. You may not need to perform all of these procedures, depending on what you want to accomplish.

If you are not familiar with operating this instrument, read the instrument user manual or explore the online help.

- To rapidly confirm that the instrument functions and was adjusted properly, perform only the brief procedures under *Self Tests*.

Advantages. These procedures are quick to do, require no external equipment or signal sources, and perform extensive functional and accuracy testing to provide high confidence that the instrument will perform properly. They can be used as a quick check before making a series of important measurements.

- To further check functionality, first do the *Self Tests* just mentioned; then do the brief procedures under *Functional Tests*.

Advantages. These procedures require minimal additional time to perform, require no additional equipment other than cables and adapters, and these procedures more completely test the internal hardware of the instrument. They can be used to quickly determine if the instrument is suitable for putting into service, such as when it is first received.

- If more extensive confirmation of performance is desired, perform the *Performance Tests* after performing the *Functional* and *Self Tests* mentioned above. (See page 3-18, *Performance Tests (MSO70000/C Series, DSA/DPO70000B/C Series, and DPO7000 Series)*.)

Advantages. These procedures add direct checking of the warranted specifications that are marked with the ✓ symbol. These procedures require specific test equipment. (See Table 3-2.)

## Conventions

Throughout these procedures the following conventions apply:

- Each test procedure uses the following general format:
  - Title of Test
  - Equipment Required
  - Prerequisites
  - Procedure
- Each procedure consists of as many steps, substeps, and subparts as required to do the test. Steps, substeps, and subparts are sequenced as follows:
  1. First Step
    - a. First Substep
      - First Subpart
      - Second Subpart
    - b. Second Substep
  2. Second Step
- In steps and substeps, the lead-in statement in italics instructs you what to do, while the instructions that follow tell you how to do it, as in the example step below:

*Initialize the instrument:* Push the front-panel **Default Setup** button.
- **STOP.** The **STOP** notation at the left is accompanied by information you must read to do the procedure properly.
- The term "toolbar" refers to a row of buttons at the top of the display. The term "menu bar" refers to a row of menus at the top of the display. You can switch between toolbar and menu bar operating modes by using the menu at the top right of the toolbar or menu bar. (See Figure 3-1.)
- Item numbers in the equipment required lists refer to the equipment. (See Table 3-2 on page 3-19.)



**Figure 3-1: Toolbar and menu bar (< 4 GHz models shown)**

- The procedures assume you have connected a mouse to the instrument so you can click on the screen controls. If you have not connected a mouse, you can use the touch screen to operate the screen controls.

## Brief Procedures (MSO70000/C Series, DSA/DPO70000B/C Series, and DPO7000 Series)

The *Self Tests* use internal routines to confirm basic functionality and proper adjustment. No test equipment is required to do these test procedures.

The *Functional Tests* utilize the probe-compensation output at the front panel as a test-signal source for further verifying that the instrument functions properly. A BNC cable and an adaptor or a probe, depending on your instrument model are required to do these test procedures.

### Self Tests

This procedure uses internal routines to verify that the instrument functions and was adjusted properly. No test equipment or hookups are required.

Equipment required	Prerequisites
None	Power on the instrument and allow a 20 minute warm-up before doing this procedure.

1. *Verify that internal diagnostics pass:* Do the following substeps to verify passing of internal diagnostics.
  - a. *Display the System diagnostics menu:*

If the instrument is in toolbar mode, put the instrument into menu bar mode.

Pull down the **Utilities** menu and select **Instrument Diagnostics**. . . . This displays the diagnostics control window.
  - b. *Run the System Diagnostics:*
    - First disconnect any input signals from all four channels.
    - Click the **Run** button in the diagnostics control window.
  - c. *Wait:* The internal diagnostics do an exhaustive verification of proper instrument function. This verification may take several minutes. When the verification is finished, the resulting status will appear in the diagnostics control window.
  - d. *Verify that no failures are found and reported on-screen.* All tests should pass.

e. *Run the signal-path compensation routine:*

Pull down the **Utilities** menu and select **Instrument Calibration**. . . .  
This displays the instrument calibration control window.

If required because the instrument is in service mode, select the **Signal Path** button under Calibration Area.

Click the **Run SPC (Calibrate)** on some instruments) button to start the routine.

f. *Wait:* Signal-path compensation may take five to fifteen minutes to run.

g. *Confirm signal-path compensation returns passed status:* Verify that the word **Pass** appears in the instrument calibration control window.

2. *Return to regular service:* Click the **X** (close) button to exit the instrument calibration control window.

## Functional Tests

The purpose of these procedures is to confirm that the instrument functions properly. The only equipment required is a BNC or SMA cable and an adapter or the instrument probe. If you need to store settings during these procedures, access the local C: drive and store them in the TekScope > Setups directory.

**STOP.** These procedures verify functions; that is, they verify that the instrument features operate. They do not verify that they operate within limits.

Therefore, when the instructions in the functional tests that follow call for you to verify that a signal appears on-screen "that is about five divisions in amplitude" or "has a period of about six horizontal divisions," etc., do NOT interpret the quantities given as limits. Operation within limits is checked in Performance Tests. (See page 3-18, *Performance Tests (MSO70000/C Series, DSA/DPO70000B/C Series, and DPO7000 Series)*.)

**STOP.** DO NOT make changes to the front-panel settings that are not called out in the procedures. Each verification procedure will require you to set the instrument to certain default settings before verifying functions. If you make changes to these settings, other than those called out in the procedure, you may obtain invalid results. In this case, just redo the procedure from step 1.

When you are instructed to press a front-panel or screen button, the button may already be selected (its label will be highlighted). If this is the case, it is not necessary to press the button.

## Verify All Analog Input Channels

### Equipment required

- < 4 GHz models: One precision 50  $\Omega$  coaxial cable (Item 4)
- < 4 GHz models: One BNC to Minigrabber adapter (item 18)
- $\geq$  4 GHz models: One SMA cable (item 21)
- $\geq$  4 GHz models: One adapter (item 19)

### Prerequisites

None

1. *Initialize the instrument:* Push the front-panel **Default Setup** button.
2. *Hook up the signal source:* Connect the equipment as shown in the following figure to the channel input you want to test (beginning with Ch 1).

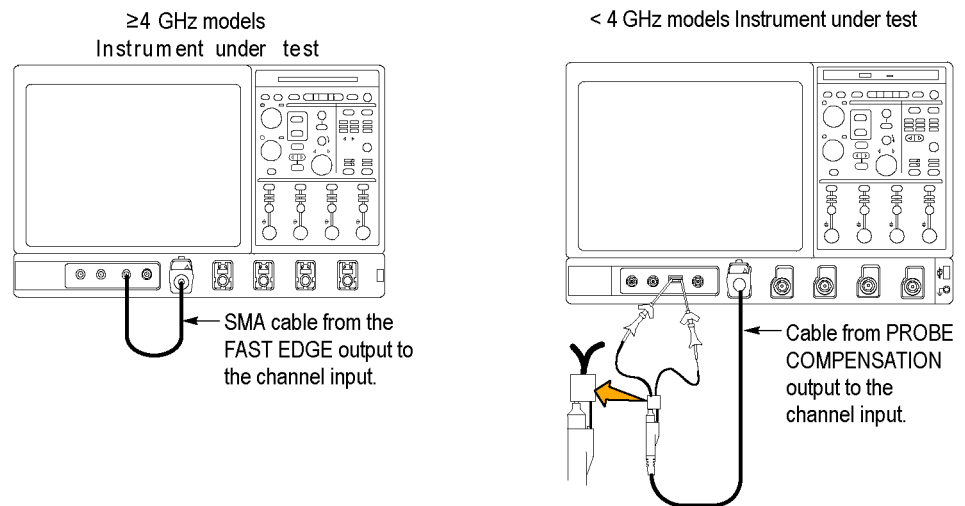
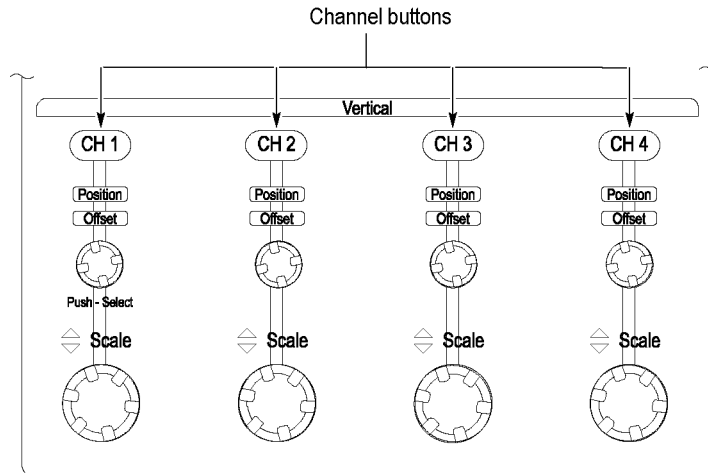

Figure 3-2: Universal test hookup for functional tests - Ch 1 shown

3. *Turn off all channels:* If any of the front-panel channel buttons are lighted, push those buttons to turn off the displayed channels as shown in the following figure.



**Figure 3-3: Channel button location**

4. *Select the channel to test:* Push the channel button for the channel you are currently testing. The button lights and the channel display comes on.
5. *Set up the instrument:*

---

**NOTE.** *If the AutoSet Undo window appears, click the X.*

---

- Push the front panel **Autoset** button. This sets the horizontal and vertical scale and vertical offset for a usable display and sets the trigger source to the channel you are testing.
- Pull down the **Vertical** menu, select Vertical Setup. Confirm that the Ch1 Offset is about **0.0 mV**.

6. *Verify that the channel is operational:* Confirm that the following statements are true.
  - Verify that the vertical scale readout and the waveform amplitude for the channel under test. (See Table 3-1.)

**Table 3-1: Vertical settings**

<b>Setting</b>	<b>&lt; 4 GHz models</b>	<b>≥ 4 GHz models</b>
	<b>Without probe</b>	<b>Without probe</b>
Scale	500 mV	100 mV
Waveform amplitude	2 divisions	4 divisions

- The front-panel vertical **Position** knob (for the channel you are testing) moves the signal up and down the screen when rotated.
  - Turning the vertical **Scale** knob counterclockwise (for the channel you are testing) decreases the amplitude of the waveform on-screen, turning the knob clockwise increases the amplitude, and returning the knob to the original scale setting returns the original amplitude for that scale setting. (See Table 3-1.)
7. *Verify that the channel acquires in all acquisition modes:* Pull down the **Horiz/Acq** menu to select **Horizontal/Acquisition Setup**. . . . Click the



**Acquisition** tab in the control window that displays. Click each of the acquisition modes and confirm that the following statements are true.

- Sample mode displays an actively acquiring waveform on-screen. (Note that there is a small amount of noise present on the square wave).
- Peak Detect mode displays an actively acquiring waveform on-screen with the noise present in Sample mode "peak detected".
- Hi Res mode displays an actively acquiring waveform on-screen with the noise that was present in Sample mode reduced.
- Average mode displays an actively acquiring waveform on-screen with the noise reduced.
- Envelope mode displays an actively acquiring waveform on-screen with the noise displayed.

---

**NOTE.** *Default setup enables enhanced triggering. Enhanced triggering can cause a slower acquisition rate that can be noticed in waveform database mode. As waveform database mode acquires 100,000 samples, the display intensity will increase, be cleared, and then the process will start over. When enhanced triggering is turned off, and with the specified settings and input signal, the display reaches full intensity right away.*

---

- Waveform Database mode displays an actively acquiring waveform on-screen with the noise displayed.
8. *Test all channels:* Repeat steps 2 through 7 until all four input channels are verified.
  9. *Remove the test hookup:* Disconnect the equipment from the instrument.

## Verify the Time Base

Equipment required	Prerequisites
< 4 GHz models: One precision 50 $\Omega$ coaxial cable (Item 4)	None
< 4 GHz models: One BNC to Minigrabber adapter (item 18)	
$\geq$ 4 GHz models: One SMA cable (item 21)	
$\geq$ 4 GHz models: One adapter (item 19)	

1. *Initialize the instrument:* Push the front-panel **Default Setup** button.
2. *Hook up the signal source:* Connect the probe compensation or fast edge output to the Ch 1 input as shown in the following figure.

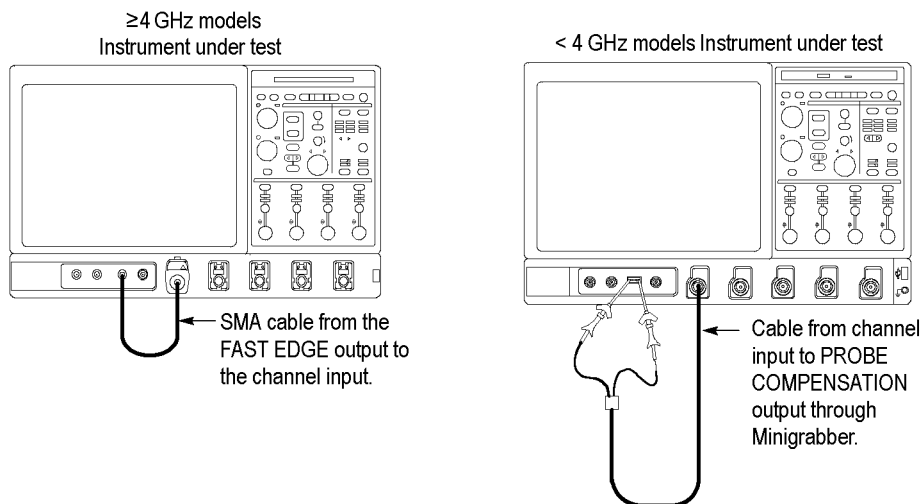

**Figure 3-4: Setup for time base test**

3. *Set up the instrument:* Push the front panel **Autoset** button.
4. Set the **Vertical Scale** to **200 mV** per division.
5. *Set the time base:* Set the horizontal **Scale** to **200  $\mu\text{s}/\text{div}$** . The time-base readout is displayed at the bottom of the graticule.
6. *Verify that the time base operates:* Confirm the following statements.
  - One period of the square-wave signal is about five horizontal divisions on-screen for the 200  $\mu\text{s}/\text{div}$  horizontal scale setting.
  - Rotating the horizontal **Scale** knob clockwise expands the waveform on-screen (more horizontal divisions per waveform period), counterclockwise rotation contracts it, and returning the horizontal scale to 200  $\mu\text{s}/\text{div}$  returns the period to about five divisions.
  - The horizontal **Position** knob positions the signal left and right on-screen when rotated.

7. *Verify horizontal delay:*
  - a. *Center a rising edge on screen:*
    - Set the horizontal **Position** knob so that the rising edge where the waveform is triggered is lined up with the center horizontal graticule.
    - Change the horizontal **Scale** to **20  $\mu\text{s}/\text{div}$** . The rising edge of the waveform should remain near the center graticule and the falling edge should be off screen.
  - b. *Turn on and set horizontal delay:*
    - Pull down the **Horiz/Acq** menu to select **Horizontal/Acquisition Setup** . . .
    - Click the **Horizontal** tab in the control window that displays.
    - Click the **Delay Mode** button to turn delay on.
    - Double click the **Horiz Delay** control in the control window to display the pop-up keypad. Click the keypad buttons to set the horizontal delay to **1 ms** and then click the **ENTER** key.
  - c. *Verify the waveform:* Verify that a rising edge of the waveform is within a few divisions of center screen.
  - d. *Adjust the horizontal delay:* Rotate the upper multipurpose knob to change the horizontal delay setting. Verify that the rising edge shifts horizontally. Rotate the front-panel horizontal **Position** knob. Verify that this knob has the same effect (it also adjusts delay, but only when delay mode is on).
  - e. *Verify the delay toggle function:*
    - Rotate the front-panel horizontal **Position** knob to center the rising edge horizontally on the screen.
    - Change the horizontal **Scale** to **50 ns/div** (< 4 GHz models) or **40 ns/div** ( $\geq$  4 GHz models). The rising edge of the waveform should remain near the center graticule.
    - Readjust the delay setting to position the rising edge 2 divisions to the right of the center graticule line.
    - Push the front-panel **Delay** button several times to toggle delay off and on and back off again. Verify that the display switches quickly between two different points in time (the rising edge shifts horizontally on the display).
8. *Remove the test hookup:* Disconnect the test hookup from the instrument.

## Verify the A (Main) and B (Delayed) Trigger Systems

Equipment required	Prerequisites
< 4 GHz models: One precision 50 $\Omega$ coaxial cable (Item 4)	None
< 4 GHz models: One BNC to Minigrabber adapter (item 18)	
$\geq$ 4 GHz models: One SMA cable (item 21)	
$\geq$ 4 GHz models: One adapter (item 19)	

1. *Initialize the instrument:* Push the front-panel **Default Setup** button.
2. *Hook up the signal source:* Connect the probe compensation or fast edge output to the Ch 1 input as shown in the following figure.

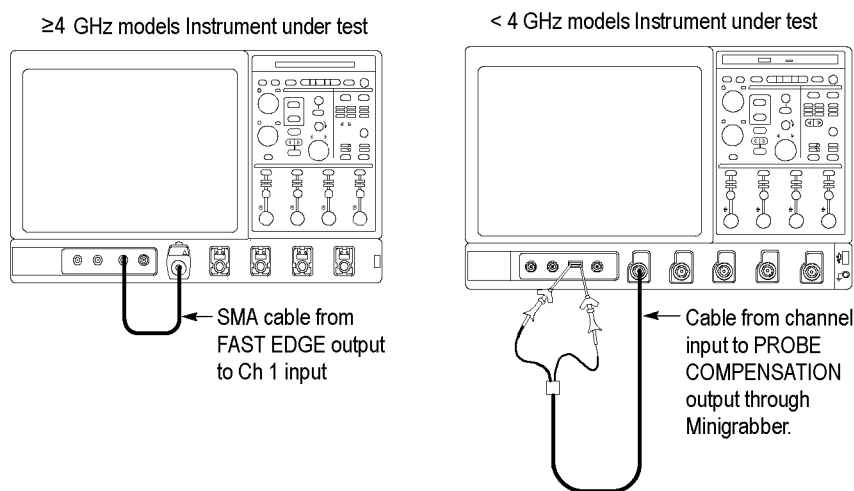

**Figure 3-5: Setup for trigger test**

3. *Set up the instrument:* Push the front-panel **Autoset** button.
4. Set the **Vertical Scale** to **200 mV** per division.
5. *Verify that the main trigger system operates:* Confirm that the following statements are true.
  - The trigger level readout for the A (main) trigger system changes with the trigger-**Level** knob.
  - The trigger-**Level** knob can trigger and untrigger the square-wave signal as you rotate the knob. (Leave the signal untriggered).
  - Pushing the front-panel trigger **Level** knob sets the trigger level to the 50% amplitude point of the signal and triggers the signal that you just left untriggered. (Leave the signal triggered.)

6. *Verify that the delayed trigger system operates:*
  - a. *Set up the delayed trigger:*

Pull down the **Trig** menu and select **A – B Trigger Sequence**. . . . This displays the A →B Sequence tab of the trigger setup control window.

Click the **Trig After Time** button under A Then B.

Click the **B Trig Level** control in the control window.

Set the front-panel trigger mode to **Norm**.
  - b. *Confirm that the following statements are true:*
    - The trigger-level readout for the B trigger system changes as you turn the lower multipurpose knob.
    - As you rotate the lower multipurpose knob, the square-wave signal can become triggered and untriggered. (Leave the signal triggered.)
  - c. *Verify the delayed trigger counter:*
    - Double click the **Trig Delay** control to pop up a numeric keypad for that control.
    - Click the keypad to enter a trigger delay time of **1 second** (click 1 and None) and then click **Enter**.
    - Verify that the trigger **Ready** indicator on the front panel flashes about once every second as the waveform is updated on-screen.
7. *Remove the test hookup:* Disconnect the test hookup from the instrument.

## Verify the File System

Equipment required	Prerequisites
< 4 GHz models: One precision 50 Ω coaxial cable (Item 4)	None
< 4 GHz models: One BNC to Minigrabber adapter (item 18)	
≥ 4 GHz models: One SMA cable (item 21)	
≥ 4 GHz models: One adapter (item 19)	

1. *Initialize the instrument:* Push the front-panel **Default Setup** button.
2. *Hook up the signal source:* Connect the probe compensation or fast edge output to the Ch 1 input as shown in the following.

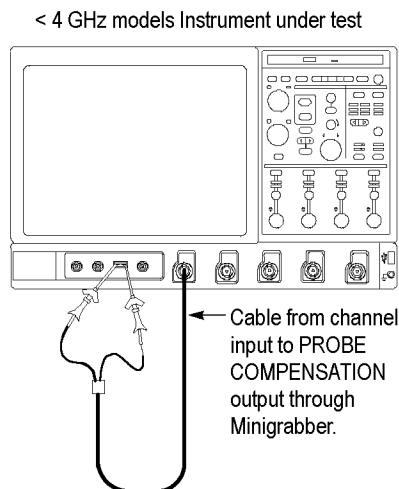

**Figure 3-6: Setup for the file system test**

3. *Set up the instrument:* Push the front panel **Autoset** button.
4. Set the **Vertical Scale** to **200 mV** per division.
5. *Set the time base:* Set the horizontal **Scale** to **1 ms/div**. The time-base readout is displayed at the bottom of the graticule.
6. *Save the settings:*
  - a. Pull down the **File** menu to select **Save As. . . >Setup. . .**. This displays the instrument Save As control window.
  - b. Note the default location and file name and then click the **Save** button to save the setup to the default file name and location.
7. *Change the settings again:* Set the horizontal **SCALE** to **200  $\mu$ s/div**.
8. *Verify the file system works:*
  - a. Pull down the **File** menu to select **Recall**. This displays the instrument Recall control window.
  - b. Click Recall **What > Setup**.
  - c. Locate and then double click the setup file that you previously stored.
  - d. Verify that the instrument retrieved the saved setup. Do this by noticing the horizontal **SCALE** is again 1 ms and the waveform shows ten cycles just as it did when you saved the setup.
9. *Remove the test hookup:* Disconnect the test hookup from the instrument.

## Verify the Digital Channels (MSO70000 Series Only)

### Equipment required

MSO70000 Series models: One precision 50  $\Omega$  coaxial cable (item 4)  
 MSO70000 Series models: One probe tip adapter (item 30)  
 MSO70000 Series models: One SMA adapter (item 17)  
 MSO70000 Series models: One logic probe (item 31)

### Prerequisites

None

1. *Hook up the signal source:* Connect the probe compensation or fast edge output to the D0 input as shown in the following figure.

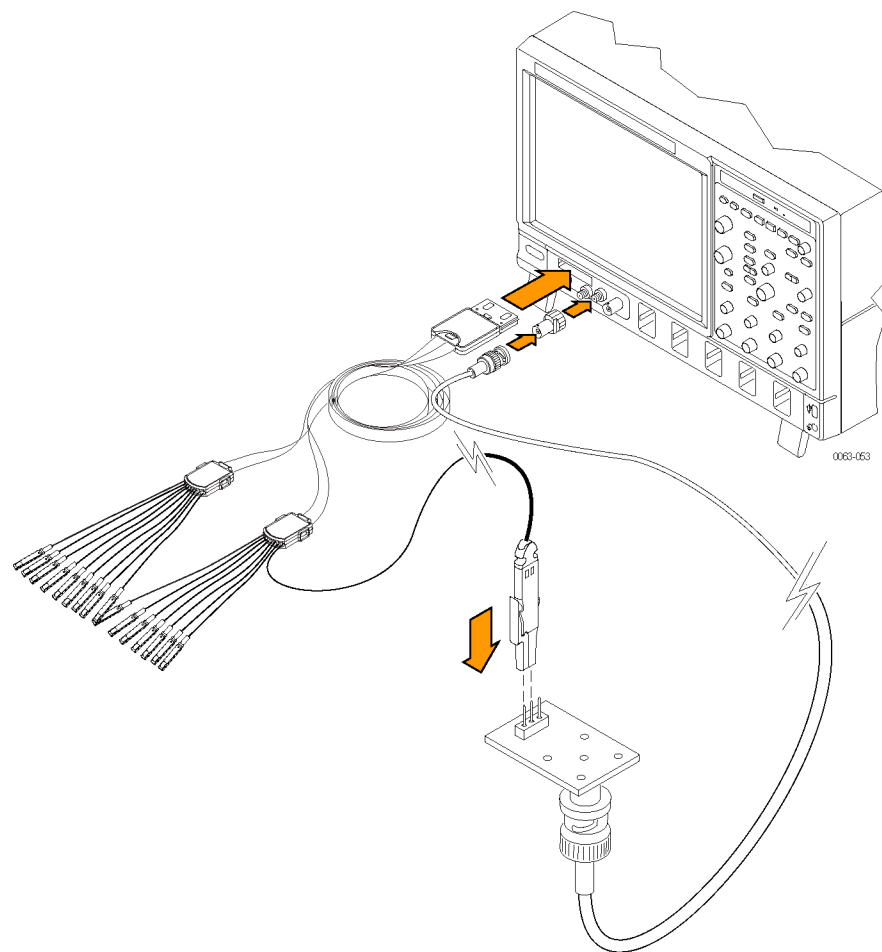

**Figure 3-7: Setup for the digital channels test**

2. *Set up the instrument:* Push the front panel **Default Setup** button.
3. Set the Horizontal Scale to **1 ms/div**.

4. *Initialize the instrument:* Pull down the **Digital** menu and select **Digital Setup**. This displays the instrument Digital Setup control window.
5. Press the **D0** button.
6. Double click **Global Threshold**. Use the keypad to enter **200 mV**. Press the **Apply** button.
7. Pull down the **Vertical** menu and select **Vertical Setup**.
8. Press Digital input **iCapture**.
9. From the Digital Source list select **D0**.
10. Pull down the **Trig** menu and select **A Event (Main) Trigger Setup**.
11. From the Source list select **D0**.
12. Verify that the both the iCapture and the digital channel are triggered.

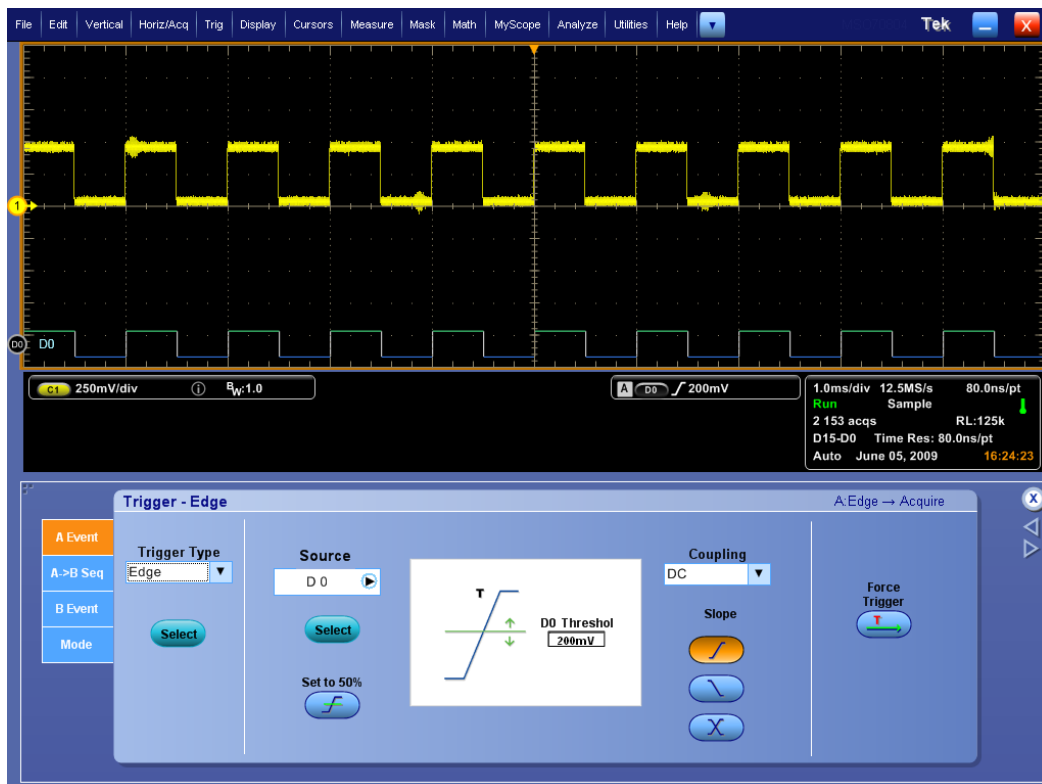

13. Rotate the Vertical **SCALE** knob counter clockwise.
14. Verify that the displayed amplitude of channel 1 is reduced.
15. Rotate the Vertical **SCALE** knob clockwise, back to its original setting.
16. Verify that the displayed amplitude of channel 1 returns to about 1.75 divisions (420 mV).



17. Rotate the Vertical **Position** knob counter clockwise.
18. Verify that the displayed position of channel 1 moves lower on the display.
19. Rotate the Vertical **Position** knob clockwise, back to its original setting.
20. Pull down the **Digital** menu and select **Digital Setup**.
21. Double click the **D0 Position** and enter **-1.66** and press Enter.
22. Verify that the displayed position of digital channel moves up on the display.
23. Repeat steps 1 through 22, replacing D0 with the digital channel number of the next channel you want to verify.
24. *Remove the test hookup:* Disconnect the test hookup from the instrument.

## Performance Tests (MSO70000/C Series, DSA/DPO70000B/C Series, and DPO7000 Series)

This section contains a collection of manual procedures for checking that the instrument performs as warranted.

The procedures are arranged in logical groupings: *Signal Acquisition System Checks*, *Time Base System Checks*, *Triggering System Checks*, *Output Ports Checks*, and *Serial Trigger Checks*. They check all the characteristics that are designated as checked in *Specifications*. (The characteristics that are checked appear with a ✓ in *Specifications*).

**STOP.** These procedures extend the confidence level provided by the basic procedures. The basic procedures should be done first, then these procedures performed if desired.

### Prerequisites

The tests in this section comprise an extensive, valid confirmation of performance and functionality when the following requirements are met:

- The cabinet must be installed on the instrument.
- You must have performed and passed the procedures under *Self Tests*, and those under *Functional Tests*. (See page 3-5, *Functional Tests*.)
- A signal-path compensation must have been done within the recommended calibration interval and at a temperature within  $\pm 5$  °C ( $\pm 9$  °F) of the present operating temperature. (If at the time you did the prerequisite *Self Tests*, the temperature was within the limits just stated, consider this prerequisite met). A signal-path compensation must have been done at an ambient humidity within 25% of the current ambient humidity and after having been at that humidity for at least 4 hours.
- The instrument must have been last adjusted at an ambient temperature between +18 °C (+64 °F) and +28 °C (+82 °F), must have been operating for a warm-up period of at least 20 minutes, and must be operating at an ambient temperature as listed in the specifications. (See Table 1-10 on page 1-58.) (The warm-up requirement is usually met in the course of meeting the Self Tests and Functional Tests prerequisites listed above).
- Support sensor, probe, and adapter setups to avoid stress or torque when connected to the device under test (DUT).

## Equipment Required

Procedures starting on (See page 3-42.), use external, traceable signal sources to directly check warranted characteristics. The following table lists the required equipment.

**Table 3-2: Test equipment**

	Minimum requirements	Example	Purpose
1. Attenuator, 10X (two required)	Ratio: 10X; impedance 50 $\Omega$ ; connectors: female input, male output	BNC $\leq$ 2 GHz Tektronix part number 011-0059-03 SMA $\leq$ 18 GHz Tektronix part number 015-1003-00	Signal attenuation, bandwidth, trigger sensitivity
2. Attenuator, 5X	Ratio: 5X; impedance 50 $\Omega$ ; connectors: female input, male output	BNC $\leq$ 2 GHz Tektronix part number 011-0060-02 SMA $\leq$ 18 GHz Tektronix part number 015-1002-01	Signal attenuation, bandwidth, trigger sensitivity
3. Termination, 50 $\Omega$ (three required)	Impedance 50 $\Omega$ ; connectors: female BNC input, male BNC output	Tektronix part number 011-0049-02 (1 GHz)	Signal termination for channel delay test, trigger sensitivity
4. Cable, Precision 50 $\Omega$ Coaxial (three required)	50 $\Omega$ , 36 in, male-to-male BNC connectors	Tektronix part number 012-0482-00	Signal interconnection, Trigger out, time qualified trigger, timebase delay time, baud rate limit, bandwidth, input resistance, delta time, clock recovery, generator leveling
5. Connector, Dual-Banana (two required)	Female BNC-to-dual banana	Tektronix part number 103-0090-00	Various accuracy tests, input resistance
6. Generator, DC Calibration	Variable amplitude to $\pm 7$ V; accuracy to 0.1%	Fluke 9500B <sup>1</sup>	Checking DC offset, gain, measurement accuracy, probe compensation out, and maximum input voltage
7. Generator, Calibration	500 mV square wave calibrator amplitude; accuracy to 0.25%	Fluke 9500B <sup>1</sup>	To check accuracy of signal out, trigger out
8. Timer-counter	10 MHz and 100 MHz, 1 s gate	Advantest R5360	Checking long-term sample rate and delay time accuracy

	Minimum requirements	Example	Purpose
9. Generator, Sine-Wave	Instrument bandwidth $\leq 3$ GHz: 5 kHz to at least the instrument bandwidth. Variable amplitude from 60 mV to $2 V_{p-p}$ into 50 $\Omega$ . Frequency error $< 2.0\%$	Fluke 9500B <sup>1</sup>	Checking analog bandwidth, trigger sensitivity, sample-rate, external clock, trigger sensitivity, time qualified trigger, baud rate limit, clock recovery, and delay-time accuracy
	Instrument bandwidth $> 3$ GHz: 50 MHz to at least the instrument bandwidth. Variable amplitude from 60 mV to $2.0 V_{p-p}$ into 50 $\Omega$ . Frequency error $< 2.0\%$	Anritsu MG3692B or MG3694B Synthesized CW Generator with options 2x (step attenuator), 3 (low noise $> 2$ GHz), 4 (10 MHz to 2 GHz low phase noise), 15 (high power), and 16 (high stability)	
10. Meter, Level and Power Sensor	Frequency range: 50 MHz to the instrument bandwidth. Amplitude range: 6 mV <sub>p-p</sub> to $2 V_{p-p}$	Rohde & Schwarz NRVS and NRV-Z15 (40 GHz)	Checking analog bandwidth and Trigger Sensitivity
11. Splitter, Power	Instrument bandwidth $\leq 3$ GHz: Frequency range: DC to 18 GHz. Tracking: $< 2.0\%$	Agilent part number 11667A	Checking trigger sensitivity and analog bandwidth
	Instrument bandwidth $> 3$ GHz: Frequency range: DC to 40 GHz. Tracking: $< 2.0\%$	Anritsu K241C (40 GHz)	
12. Cable	2.92 mm male-to-female	Gore PhaseFlex cable ELOCQ0CP0360 (40 GHz)	Checking analog bandwidth
13. Adapter	K male-to-male DC to 40 GHz	Anritsu K220B	Checking analog bandwidth
14. Adapter (four required)	Male N-to-female BNC	Tektronix part number 103-0045-00	Checking analog bandwidth
15. Adapter	Female N-to-male BNC	Tektronix part number 103-0058-00 (4 GHz)	Checking analog bandwidth
16. Adapter (three required)	SMA female-to-female	Tektronix part number 015-1012-00 (18 GHz)	Checking trigger sensitivity
17. Adapter (three required)	SMA male-to-female BNC	Tektronix part number 015-1018-00	Checking the delay between channels, delta time
18. Adapter	BNC to Minigrabber	Tektronix part number 013-0342-xx	Checking probe compensation output
19. Adapter (four required)	SMA male-to-BNC female	TCA-BNC or TCA-292mm and, if required, SMA male-to-BNC female adapter (Tektronix part number 015-0554-00 (4 GHz) or 015-1018-00)	Signal interconnection, measurement accuracy, delay time, time qualified trigger, trigger sensitivity, DC gain, offset, bandwidth, input resistance, probe compensation out, baud rate limit, clock recovery
20. Pulse Generator	250 MHz, $\leq 150$ ps rise time, 5 V out	Fluke 9500B <sup>1,2</sup>	Used to test delta time measurement accuracy

	Minimum requirements	Example	Purpose
21. Cable, Coaxial (three required)	50 $\Omega$ , 20 in, male-to-male SMA connectors	Tektronix part number 174-1427-00	Used to test delta time measurement accuracy, probe compensation out, trigger sensitivity
22. Adapter	SMA "T", male to 2 SMA female	Tektronix part number 015-1016-00 (18 GHz)	Used to test delta time measurement accuracy
23. Adapter	SMA female to BNC male	Tektronix part number 015-0572-00 (4 GHz)	Used to test delta time measurement accuracy and trigger sensitivity
24. Adapter	BNC male to female elbow	Tektronix part number 103-0031-00	Used to test delta time measurement accuracy
25. Termination	Short circuit, SMA connector, female	Tektronix part number 015-1021-00 (18 GHz)	Used to test delta time measurement accuracy
26. Attenuator, 2X	Ratio: 2X; impedance 50 $\Omega$ ; connectors: female BNC input, male BNC output	Tektronix part number 011-0069-02 (2 GHz)	Used to test delta time measurement accuracy, pulse trigger accuracy, time qualified trigger, trigger sensitivity, and channel isolation
27. Digital Multimeter	Ohms: <60 Ohms	Keithley 2700	Checking input impedance
28. Cable, coaxial	50 $\Omega$ , 39.37 in (1.0 m), male-to-male SMA connectors 50 $\Omega$ , 60 in (1.5 m), male-to-male SMA connectors	Tektronix part number 174-1341-00 Tektronix part number 174-1428-00	Checking analog bandwidth and delta time measurement accuracy. Checking $\geq$ 4 GHz models serial trigger baud rate limits
29. Mouse or keyboard		Tektronix part numbers: 119-6298-xx (mouse) 119-6297-xx (keyboard)	Used to input test selections
30. Probe tip adapter	BNC female to square pin adapter, 50 $\Omega$	Tektronix part number 067-1734-00	Checking digital channels
31. Logic probe	P6717 or P6780 Logic Probe	Tektronix part P6717 or P6780	Checking digital channels

<sup>1</sup> Fluke 9500B/1100, 9500B/3200, or 9500B/2200 and an output head (9510 or 9530) appropriate for the bandwidth of the instrument being tested.

<sup>2</sup> For Delta Time Measurement Accuracy, use a Fluke 9500B or a pulse generator with the specified rise time. (See Table 3-10 on page 3-78.)

## Test Record

Photocopy this table and use it to record the performance test results for your instrument.

**Table 3-3: Test record**

Instrument Serial Number:

Certificate Number:

Temperature:

RH %:

Date of Calibration:

Technician:

<b>Instrument performance test</b>	<b>Minimum</b>	<b>Incoming</b>	<b>Outgoing</b>	<b>Maximum</b>
<b>DC voltage measurement accuracy (averaged), <math>\geq 4</math> GHz models</b>				
Ch1 10 mV Vert scale setting, -5 Div position setting, +0.45 V offset	+ 524.75 mV	_____	_____	+ 535.25 mV
Ch1 10 mV Vert scale setting, +5 Div position setting, -0.45 V offset	- 535.25 mV	_____	_____	- 524.75 mV
Ch1 20 mV Vert scale setting, -5 Div position setting, +0.4 V offset	+ 552.75 mV	_____	_____	+ 567.25 mV
Ch1 20 mV Vert scale setting, +5 Div position setting, -0.4 V offset	- 567.25 mV	_____	_____	- 552.75 mV
Ch1 50 mV Vert scale setting, -5 Div position setting, +0.25 V offset	+ 636.75 mV	_____	_____	+ 663.25 mV
Ch1 50 mV Vert scale setting, +5 Div position setting, -0.25 V offset	- 663.25 mV	_____	_____	- 636.75 mV
Ch1 100 mV Vert scale setting, -5 Div position setting, +2.0 V offset	+ 2.764 V	_____	_____	+ 2.836 V
Ch1 100 mV Vert scale setting, +5 Div position setting, -2.0 V offset	- 2.836 V	_____	_____	- 2.764 V
Ch1 200 mV Vert scale setting, -5 Div position setting, +1.25 V offset	+ 2.697 V	_____	_____	+ 2.803 V
Ch1 200 mV Vert scale setting, +5 Div position setting, -1.25 V offset	- 2.803 V	_____	_____	- 2.697 V
Ch1 500 mV Vert scale setting, -5 Div position setting, 0 V offset	+ 3.394 V	_____	_____	+ 3.606 V
Ch1 500 mV Vert scale setting, +5 Div position setting, -0 V offset	- 3.606 V	_____	_____	- 3.394 V
Ch2 10 mV Vert scale setting, -5 Div position setting, +0.45 V offset	+ 524.75 mV	_____	_____	+ 535.25 mV
Ch2 10 mV Vert scale setting, +5 Div position setting, -0.45 V offset	- 535.25 mV	_____	_____	- 524.75 mV
Ch2 20 mV Vert scale setting, -5 Div position setting, +0.4 V offset	+ 552.75 mV	_____	_____	+ 567.25 mV
Ch2 20 mV Vert scale setting, +5 Div position setting, -0.4 V offset	- 567.25 mV	_____	_____	- 552.75 mV
Ch2 50 mV Vert scale setting, -5 Div position setting, +0.25 V offset	+ 636.75 mV	_____	_____	+ 663.25 mV
Ch2 50 mV Vert scale setting, +5 Div position setting, -0.25 V offset	- 663.25 mV	_____	_____	- 636.75 mV
Ch2 100 mV Vert scale setting, -5 Div position setting, +2.0 V offset	+ 2.764 V	_____	_____	+ 2.836 V

Table 3-3: Test record (cont.)

Instrument performance test	Minimum	Incoming	Outgoing	Maximum
Ch2 100 mV Vert scale setting, +5 Div position setting, -2.0 V offset	- 2.836 V	_____	_____	- 2.764 V
Ch2 200 mV Vert scale setting, -5 Div position setting, +1.25 V offset	+ 2.697 V	_____	_____	+ 2.803 V
Ch2 200 mV Vert scale setting, +5 Div position setting, -1.25 V offset	- 2.803 V	_____	_____	- 2.697 V
Ch2 500 mV Vert scale setting, -5 Div position setting, 0V offset	+ 3.394 V	_____	_____	+ 3.606 V
Ch2 500 mV Vert scale setting, +5 Div position setting, -0 V offset	- 3.606 V	_____	_____	- 3.394 V
Ch3 10 mV Vert scale setting, -5 Div position setting, +0.45 V offset	+ 524.75 mV	_____	_____	+ 535.25 mV
Ch3 10 mV Vert scale setting, +5 Div position setting, -0.45 V offset	- 535.25 mV	_____	_____	- 524.75 mV
Ch3 20 mV Vert scale setting, -5 Div position setting, +0.4 V offset	+ 552.75 mV	_____	_____	+ 567.25 mV
Ch3 20 mV Vert scale setting, +5 Div position setting, -0.4 V offset	- 567.25 mV	_____	_____	- 552.75 mV
Ch3 50 mV Vert scale setting, -5 Div position setting, +0.25 V offset	+ 636.75 mV	_____	_____	+ 663.25 mV
Ch3 50 mV Vert scale setting, +5 Div position setting, -0.25 V offset	- 663.25 mV	_____	_____	- 636.75 mV
Ch3 100 mV Vert scale setting, -5 Div position setting, +2.0 V offset	+ 2.764 V	_____	_____	+ 2.836 V
Ch3 100 mV Vert scale setting, +5 Div position setting, -2.0 V offset	- 2.836 V	_____	_____	- 2.764 V
Ch3 200 mV Vert scale setting, -5 Div position setting, +1.25 V offset	+ 2.697 V	_____	_____	+ 2.803 V
Ch3 200 mV Vert scale setting, +5 Div position setting, -1.25 V offset	- 2.803 V	_____	_____	- 2.697 V
Ch3 500 mV Vert scale setting, -5 Div position setting, 0V offset	+ 3.394 V	_____	_____	+ 3.606 V
Ch3 500 mV Vert scale setting, +5 Div position setting, -0 V offset	- 3.606 V	_____	_____	- 3.394 V
Ch4 10 mV Vert scale setting, -5 Div position setting, +0.45 V offset	+ 524.75 mV	_____	_____	+ 535.25 mV
Ch4 10 mV Vert scale setting, +5 Div position setting, -0.45 V offset	- 535.25 mV	_____	_____	- 524.75 mV
Ch4 20 mV Vert scale setting, -5 Div position setting, +0.4 V offset	+ 552.75 mV	_____	_____	+ 567.25 mV
Ch4 20 mV Vert scale setting, +5 Div position setting, -0.4 V offset	- 567.25 mV	_____	_____	- 552.75 mV



**Table 3-3: Test record (cont.)**

<b>Instrument performance test</b>	<b>Minimum</b>	<b>Incoming</b>	<b>Outgoing</b>	<b>Maximum</b>
Ch4 50 mV Vert scale setting, -5 Div position setting, +0.25 V offset	+ 636.75 mV	_____	_____	+ 663.25 mV
Ch4 50 mV Vert scale setting, +5 Div position setting, -0.25 V offset	- 663.25 mV	_____	_____	- 636.75 mV
Ch4 100 mV Vert scale setting, -5 Div position setting, +2.0 V offset	+ 2.764 V	_____	_____	+ 2.836 V
Ch4 100 mV Vert scale setting, +5 Div position setting, -2.0 V offset	- 2.836 V	_____	_____	- 2.764 V
Ch4 200 mV Vert scale setting, -5 Div position setting, +1.25 V offset	+ 2.697 V	_____	_____	+ 2.803 V
Ch4 200 mV Vert scale setting, +5 Div position setting, -1.25 V offset	- 2.803 V	_____	_____	- 2.697 V
Ch4 500 mV Vert scale setting, -5 Div position setting, 0V offset	+ 3.394 V	_____	_____	+ 3.606 V
Ch4 500 mV Vert scale setting, +5 Div position setting, -0 V offset	- 3.606 V	_____	_____	- 3.394 V
<b>DC voltage measurement accuracy (averaged), &lt; 4 GHz models</b>				
Ch1 1 mV Vert scale setting, -5 Div position setting, +0.5 V offset	+ 504.25 mV	_____	_____	+ 509.76 mV
Ch1 1 mV Vert scale setting, +5 Div position setting, -0.5 V offset	- 509.76 mV	_____	_____	- 504.25 mV
Ch1 2 mV Vert scale setting, -5 Div position setting, +0.5 V offset	+ 512.98 mV	_____	_____	+ 519.03 mV
Ch1 2 mV Vert scale setting, +5 Div position setting, -0.5 V offset	- 519.03 mV	_____	_____	- 512.98 mV
Ch1 5 mV Vert scale setting, -5 Div position setting, +0.5 V offset	+ 536.26 mV	_____	_____	+ 543.74 mV
Ch1 5 mV Vert scale setting, +5 Div position setting, -0.5 V offset	- 543.74 mV	_____	_____	- 536.26 mV
Ch1 10 mV Vert scale setting, -5 Div position setting, +0.5 V offset	+ 574.20 mV	_____	_____	+ 585.80 mV
Ch1 10 mV Vert scale setting, +5 Div position setting, -0.5 V offset	- 585.80 mV	_____	_____	- 574.20 mV
Ch1 20 mV Vert scale setting, -5 Div position setting, +0.5 V offset	+ 651.65 mV	_____	_____	+ 668.35 mV
Ch1 20 mV Vert scale setting, +5 Div position setting, -0.5 V offset	- 668.35 mV	_____	_____	- 651.65 mV
Ch1 50 mV Vert scale setting, -5 Div position setting, +0.5 V offset	+ 884.00 mV	_____	_____	+ 916.00 mV
Ch1 50 mV Vert scale setting, +5 Div position setting, -0.5 V offset	- 916.00 V	_____	_____	- 884.00 mV

Table 3-3: Test record (cont.)

Instrument performance test	Minimum	Incoming	Outgoing	Maximum
Ch1 90 mV Vert scale setting, -5 Div position setting, +0.5 V offset	+ 1.194 V	_____	_____	+ 1.246 V
Ch1 90 mV Vert scale setting, +5 Div position setting, -0.5 V offset	- 1.246 V	_____	_____	- 1.194 V
Ch1 100 mV Vert scale setting, 0 Div position setting, +4.5 V offset	+ 4.746 V	_____	_____	+ 4.854 V
Ch1 100 mV Vert scale setting, 0 Div position setting, -4.5 V offset	- 4.854 V	_____	_____	- 4.746 V
Ch1 200 mV Vert scale setting, -2 Div position setting, +4.6 V offset	+ 4.725 V	_____	_____	+ 4.875 V
Ch1 200 mV Vert scale setting, +2 Div position setting, -4.6 V offset	- 4.875 V	_____	_____	- 4.725 V
Ch1 500 mV Vert scale setting, -2 Div position setting, +5.0 V offset	+ 4.345 V	_____	_____	+ 4.655 V
Ch1 500 mV Vert scale setting, +2 Div position setting, -5.0 V offset	- 4.655 V	_____	_____	- 4.345 V
Ch1 1.0 V Vert scale setting, 0 Div position setting, +2.0 V offset	+ 4.745 V	_____	_____	+ 5.255 V
Ch1 1.0 V Vert scale setting, 0 Div position setting, -2.0 V offset	- 5.255 V	_____	_____	- 4.745 V
Ch2 1 mV Vert scale setting, -5 Div position setting, +0.5 V offset	+ 504.25 mV	_____	_____	+ 509.76 mV
Ch2 1 mV Vert scale setting, +5 Div position setting, -0.5 V offset	- 509.76 mV	_____	_____	- 504.25 mV
Ch2 2 mV Vert scale setting, -5 Div position setting, +0.5 V offset	+ 512.98 mV	_____	_____	+ 519.03 mV
Ch2 2 mV Vert scale setting, +5 Div position setting, -0.5 V offset	- 519.03 mV	_____	_____	- 512.98 mV
Ch2 5 mV Vert scale setting, -5 Div position setting, +0.5 V offset	+ 536.26 mV	_____	_____	+ 543.74 mV
Ch2 5 mV Vert scale setting, +5 Div position setting, -0.5 V offset	- 543.74 mV	_____	_____	- 536.26 mV
Ch2 10 mV Vert scale setting, -5 Div position setting, +0.5 V offset	+ 574.20 mV	_____	_____	+ 585.80 mV
Ch2 10 mV Vert scale setting, +5 Div position setting, -0.5 V offset	- 585.80 mV	_____	_____	- 574.20 mV
Ch2 20 mV Vert scale setting, -5 Div position setting, +0.5 V offset	+ 651.65 mV	_____	_____	+ 668.35 mV
Ch2 20 mV Vert scale setting, +5 Div position setting, -0.5 V offset	- 668.35 mV	_____	_____	- 651.65 mV
Ch2 50 mV Vert scale setting, -5 Div position setting, +0.5 V offset	+ 884.00 mV	_____	_____	+ 916.00 mV

**Table 3-3: Test record (cont.)**

<b>Instrument performance test</b>	<b>Minimum</b>	<b>Incoming</b>	<b>Outgoing</b>	<b>Maximum</b>
Ch2 50 mV Vert scale setting, +5 Div position setting, -0.5 V offset	- 916.00 V	_____	_____	- 884.00 mV
Ch2 90 mV Vert scale setting, -5 Div position setting, +0.5 V offset	+ 1.194 V	_____	_____	+ 1.246 V
Ch2 90 mV Vert scale setting, +5 Div position setting, -0.5 V offset	- 1.246 V	_____	_____	- 1.194 V
Ch2 100 mV Vert scale setting, 0 Div position setting, +4.5 V offset	+ 4.746 V	_____	_____	+ 4.854 V
Ch2 100 mV Vert scale setting, 0 Div position setting, -4.5 V offset	- 4.854 V	_____	_____	- 4.746 V
Ch2 200 mV Vert scale setting, -2 Div position setting, +4.6 V offset	+ 4.725 V	_____	_____	+ 4.875 V
Ch2 200 mV Vert scale setting, +2 Div position setting, -4.6 V offset	- 4.875 V	_____	_____	- 4.725 V
Ch2 500 mV Vert scale setting, -2 Div position setting, +5.0 V offset	+ 4.345 V	_____	_____	+ 4.655 V
Ch2 500 mV Vert scale setting, +2 Div position setting, -5.0 V offset	- 4.655 V	_____	_____	- 4.345 V
Ch2 1.0 V Vert scale setting, 0 Div position setting, +2.0 V offset	+ 4.745 V	_____	_____	+ 5.255 V
Ch2 1.0 V Vert scale setting, 0 Div position setting, -2.0 V offset	- 5.255 V	_____	_____	- 4.745 V
Ch3 1 mV Vert scale setting, -5 Div position setting, +0.5 V offset	+ 504.25 mV	_____	_____	+ 509.76 mV
Ch3 1 mV Vert scale setting, +5 Div position setting, -0.5 V offset	- 509.76 mV	_____	_____	- 504.25 mV
Ch3 2 mV Vert scale setting, -5 Div position setting, +0.5 V offset	+ 512.98 mV	_____	_____	+ 519.03 mV
Ch3 2 mV Vert scale setting, +5 Div position setting, -0.5 V offset	- 519.03 mV	_____	_____	- 512.98 mV
Ch3 5 mV Vert scale setting, -5 Div position setting, +0.5 V offset	+ 536.26 mV	_____	_____	+ 543.74 mV
Ch3 5 mV Vert scale setting, +5 Div position setting, -0.5 V offset	- 543.74 mV	_____	_____	- 536.26 mV
Ch3 10 mV Vert scale setting, -5 Div position setting, +0.5 V offset	+ 574.20 mV	_____	_____	+ 585.80 mV
Ch3 10 mV Vert scale setting, +5 Div position setting, -0.5 V offset	- 585.80 mV	_____	_____	- 574.20 mV
Ch3 20 mV Vert scale setting, -5 Div position setting, +0.5 V offset	+ 651.65 mV	_____	_____	+ 668.35 mV
Ch3 20 mV Vert scale setting, +5 Div position setting, -0.5 V offset	- 668.35 mV	_____	_____	- 651.65 mV

Table 3-3: Test record (cont.)

Instrument performance test	Minimum	Incoming	Outgoing	Maximum
Ch3 50 mV Vert scale setting, -5 Div position setting, +0.5 V offset	+ 884.00 mV	_____	_____	+ 916.00 mV
Ch3 50 mV Vert scale setting, +5 Div position setting, -0.5 V offset	- 916.00 V	_____	_____	- 884.00 mV
Ch3 90 mV Vert scale setting, -5 Div position setting, +0.5 V offset	+ 1.194 V	_____	_____	+ 1.246 V
Ch3 90 mV Vert scale setting, +5 Div position setting, -0.5 V offset	- 1.246 V	_____	_____	- 1.194 V
Ch3 100 mV Vert scale setting, 0 Div position setting, +4.5 V offset	+ 4.746 V	_____	_____	+ 4.854 V
Ch3 100 mV Vert scale setting, 0 Div position setting, -4.5 V offset	- 4.854 V	_____	_____	- 4.746 V
Ch3 200 mV Vert scale setting, -2 Div position setting, +4.6 V offset	+ 4.725 V	_____	_____	+ 4.875 V
Ch3 200 mV Vert scale setting, +2 Div position setting, -4.6 V offset	- 4.875 V	_____	_____	- 4.725 V
Ch3 500 mV Vert scale setting, -2 Div position setting, +5.0 V offset	+ 4.345 V	_____	_____	+ 4.655 V
Ch3 500 mV Vert scale setting, +2 Div position setting, -5.0 V offset	- 4.655 V	_____	_____	- 4.345 V
Ch3 1.0 V Vert scale setting, 0 Div position setting, +2.0 V offset	+ 4.745 V	_____	_____	+ 5.255 V
Ch3 1.0 V Vert scale setting, 0 Div position setting, -2.0 V offset	- 5.255 V	_____	_____	- 4.745 V
Ch4 1 mV Vert scale setting, -5 Div position setting, +0.5 V offset	+ 504.25 mV	_____	_____	+ 509.76 mV
Ch4 1 mV Vert scale setting, +5 Div position setting, -0.5 V offset	- 509.76 mV	_____	_____	- 504.25 mV
Ch4 2 mV Vert scale setting, -5 Div position setting, +0.5 V offset	+ 512.98 mV	_____	_____	+ 519.03 mV
Ch4 2 mV Vert scale setting, +5 Div position setting, -0.5 V offset	- 519.03 mV	_____	_____	- 512.98 mV
Ch4 5 mV Vert scale setting, -5 Div position setting, +0.5 V offset	+ 536.26 mV	_____	_____	+ 543.74 mV
Ch4 5 mV Vert scale setting, +5 Div position setting, -0.5 V offset	- 543.74 mV	_____	_____	- 536.26 mV
Ch4 10 mV Vert scale setting, -5 Div position setting, +0.5 V offset	+ 574.20 mV	_____	_____	+ 585.80 mV
Ch4 10 mV Vert scale setting, +5 Div position setting, -0.5 V offset	- 585.80 mV	_____	_____	- 574.20 mV
Ch4 20 mV Vert scale setting, -5 Div position setting, +0.5 V offset	+ 651.65 mV	_____	_____	+ 668.35 mV

**Table 3-3: Test record (cont.)**

<b>Instrument performance test</b>	<b>Minimum</b>	<b>Incoming</b>	<b>Outgoing</b>	<b>Maximum</b>
Ch4 20 mV Vert scale setting, +5 Div position setting, -0.5 V offset	- 668.35 mV	_____	_____	- 651.65 mV
Ch4 50 mV Vert scale setting, -5 Div position setting, +0.5 V offset	+ 884.00 mV	_____	_____	+ 916.00 mV
Ch4 50 mV Vert scale setting, +5 Div position setting, -0.5 V offset	- 916.00 V	_____	_____	- 884.00 mV
Ch4 90 mV Vert scale setting, -5 Div position setting, +0.5 V offset	+ 1.194 V	_____	_____	+ 1.246 V
Ch4 90 mV Vert scale setting, +5 Div position setting, -0.5 V offset	- 1.246 V	_____	_____	- 1.194 V
Ch4 100 mV Vert scale setting, 0 Div position setting, +4.5 V offset	+ 4.746 V	_____	_____	+ 4.854 V
Ch4 100 mV Vert scale setting, 0 Div position setting, -4.5 V offset	- 4.854 V	_____	_____	- 4.746 V
Ch4 200 mV Vert scale setting, -2 Div position setting, +4.6 V offset	+ 4.725 V	_____	_____	+ 4.875 V
Ch4 200 mV Vert scale setting, +2 Div position setting, -4.6 V offset	- 4.875 V	_____	_____	- 4.725 V
Ch4 500 mV Vert scale setting, -2 Div position setting, +5.0 V offset	+ 4.345 V	_____	_____	+ 4.655 V
Ch4 500 mV Vert scale setting, +2 Div position setting, -5.0 V offset	- 4.655 V	_____	_____	- 4.345 V
Ch4 1.0 V Vert scale setting, 0 Div position setting, +2.0 V offset	+ 4.745 V	_____	_____	+ 5.255 V
Ch4 1.0 V Vert scale setting, 0 Div position setting, -2.0 V offset	- 5.255 V	_____	_____	- 4.745 V
<b>DC gain accuracy (averaged), ≥ 4 GHz models</b>				
Ch1 10 mV Vert scale setting, 0 Div position setting, 0 V offset	+ 74.48 mV	_____	_____	+ 77.52 mV
-5 Div position setting, +0.45 V offset	+ 74.48 mV	_____	_____	+ 77.52 mV
+5 Div position setting, -0.45 V offset	+ 74.48 mV	_____	_____	+ 77.52 mV
Ch1 20 mV Vert scale setting, 0 Div position setting, 0 V offset	+ 148.96 mV	_____	_____	+ 155.04 mV
-5 Div position setting, +0.4 V offset	+ 148.96 mV	_____	_____	+ 155.04 mV
+5 Div position setting, -0.4 V offset	+ 148.96 mV	_____	_____	+ 155.04 mV
Ch1 50 mV Vert scale setting, 0 Div position setting, 0 V offset	+ 372.40 mV	_____	_____	+ 387.60 mV
-5 Div position setting, +0.25 V offset	+ 372.40 mV	_____	_____	+ 387.60 mV
+5 Div position setting, -0.25 V offset	+ 372.40 mV	_____	_____	+ 387.60 mV
Ch1 100 mV Vert scale setting, 0 Div position setting, 0 V offset	+ 744.80 mV	_____	_____	+ 775.20 mV
-5 Div position setting, +2.0 V offset	+ 744.80 mV	_____	_____	+ 775.20 mV
+5 Div position setting, -2.0 V offset	+ 744.80 mV	_____	_____	+ 775.20 mV

Table 3-3: Test record (cont.)

Instrument performance test	Minimum	Incoming	Outgoing	Maximum
Ch1 200 mV Vert scale setting, 0 Div position setting, 0 V offset	+ 1.49 V	_____	_____	+ 1.55 V
-5 Div position setting, +1.25 V offset	+ 1.849 V	_____	_____	+ 1.55 V
+5 Div position setting, -1.25 V offset	+ 1.49 V	_____	_____	+ 1.55 V
Ch1 500 mV Vert scale setting, 0 Div position setting, 0 V offset	+ 3.724 V	_____	_____	+ 3.876 V
-5 Div position setting, 0 V offset	+ 3.724 V	_____	_____	+ 3.876 V
+5 Div position setting, 0 V offset	+ 3.724 V	_____	_____	+ 3.876 V
Ch2 10 mV Vert scale setting, 0 Div position setting, 0 V offset	+ 74.48 mV	_____	_____	+ 77.52 mV
-5 Div position setting, +0.45 V offset	+ 74.48 mV	_____	_____	+ 77.52 mV
+5 Div position setting, -0.45 V offset	+ 74.48 mV	_____	_____	+ 77.52 mV
Ch2 20 mV Vert scale setting, 0 Div position setting, 0 V offset	+ 148.96 mV	_____	_____	+ 155.04 mV
-5 Div position setting, +0.4 V offset	+ 148.96 mV	_____	_____	+ 155.04 mV
+5 Div position setting, -0.4 V offset	+ 148.96 mV	_____	_____	+ 155.04 mV
Ch2 50 mV Vert scale setting, 0 Div position setting, 0 V offset	+ 372.40 mV	_____	_____	+ 387.60 mV
-5 Div position setting, +0.25 V offset	+ 372.40 mV	_____	_____	+ 387.60 mV
+5 Div position setting, -0.25 V offset	+ 372.40 mV	_____	_____	+ 387.60 mV
Ch2 100 mV Vert scale setting, 0 Div position setting, 0 V offset	+ 744.80 mV	_____	_____	+ 775.20 mV
-5 Div position setting, +2.0 V offset	+ 744.80 mV	_____	_____	+ 775.20 mV
+5 Div position setting, -2.0 V offset	+ 744.80 mV	_____	_____	+ 775.20 mV
Ch2 200 mV Vert scale setting, 0 Div position setting, 0 V offset	+ 1.49 V	_____	_____	+ 1.55 V
-5 Div position setting, +1.25 V offset	+ 1.49 V	_____	_____	+ 1.55 V
+5 Div position setting, -1.25 V offset	+ 1.49 V	_____	_____	+ 1.55 V
Ch2 500 mV Vert scale setting, 0 Div position setting, 0 V offset	+ 3.724 V	_____	_____	+ 3.876 V
-5 Div position setting, 0 V offset	+ 3.724 V	_____	_____	+ 3.876 V
+5 Div position setting, 0 V offset	+ 3.724 V	_____	_____	+ 3.876 V
Ch3 10 mV Vert scale setting, 0 Div position setting, 0 V offset	+ 74.48 mV	_____	_____	+ 77.52 mV
-5 Div position setting, +0.45 V offset	+ 74.48 mV	_____	_____	+ 77.52 mV
+5 Div position setting, -0.45 V offset	+ 74.48 mV	_____	_____	+ 77.52 mV
Ch3 20 mV Vert scale setting, 0 Div position setting, 0 V offset	+ 148.96 mV	_____	_____	+ 155.04 mV
-5 Div position setting, +0.4 V offset	+ 148.96 mV	_____	_____	+ 155.04 mV
+5 Div position setting, -0.4 V offset	+ 148.96 mV	_____	_____	+ 155.04 mV
Ch3 50 mV Vert scale setting, 0 Div position setting, 0 V offset	+ 372.40 mV	_____	_____	+ 387.60 mV
-5 Div position setting, +0.25 V offset	+ 372.40 mV	_____	_____	+ 387.60 mV
+5 Div position setting, -0.25 V offset	+ 372.40 mV	_____	_____	+ 387.60 mV

Table 3-3: Test record (cont.)

Instrument performance test	Minimum	Incoming	Outgoing	Maximum
Ch3 100 mV Vert scale setting, 0 Div position setting, 0 V offset	+ 744.80 mV	_____	_____	+ 775.20 mV
-5 Div position setting, +2.0 V offset	+ 744.80 mV	_____	_____	+ 775.20 mV
+5 Div position setting, -2.0 V offset	+ 744.80 mV	_____	_____	+ 775.20 mV
Ch3 200 mV Vert scale setting, 0 Div position setting, 0 V offset	+ 1.49 V	_____	_____	+ 1.55 V
-5 Div position setting, +1.25 V offset	+ 1.49 V	_____	_____	+ 1.55 V
+5 Div position setting, -1.25 V offset	+ 1.49 V	_____	_____	+ 1.55 V
Ch3 500 mV Vert scale setting, 0 Div position setting, 0 V offset	+ 3.724 V	_____	_____	+ 3.876 V
-5 Div position setting, 0 V offset	+ 3.724 V	_____	_____	+ 3.876 V
+5 Div position setting, 0 V offset	+ 3.724 V	_____	_____	+ 3.876 V
Ch4 10 mV Vert scale setting, 0 Div position setting, 0 V offset	+ 74.48 mV	_____	_____	+ 77.52 mV
-5 Div position setting, +0.45 V offset	+ 74.48 mV	_____	_____	+ 77.52 mV
+5 Div position setting, -0.45 V offset	+ 74.48 mV	_____	_____	+ 77.52 mV
Ch4 20 mV Vert scale setting, 0 Div position setting, 0 V offset	+ 148.96 mV	_____	_____	+ 155.04 mV
-5 Div position setting, +0.4 V offset	+ 148.96 mV	_____	_____	+ 155.04 mV
+5 Div position setting, -0.4 V offset	+ 148.96 mV	_____	_____	+ 155.04 mV
Ch4 50 mV Vert scale setting, 0 Div position setting, 0 V offset	+ 372.40 mV	_____	_____	+ 387.60 mV
-5 Div position setting, +0.25 V offset	+ 372.40 mV	_____	_____	+ 387.60 mV
+5 Div position setting, -0.25 V offset	+ 372.40 mV	_____	_____	+ 387.60 mV
Ch4 100 mV Vert scale setting, 0 Div position setting, 0 V offset	+ 744.80 mV	_____	_____	+ 775.20 mV
-5 Div position setting, +2.0 V offset	+ 744.80 mV	_____	_____	+ 775.20 mV
+5 Div position setting, -2.0 V offset	+ 744.80 mV	_____	_____	+ 775.20 mV
Ch4 200 mV Vert scale setting, 0 Div position setting, 0 V offset	+ 1.49 V	_____	_____	+ 1.55 V
-5 Div position setting, +1.25 V offset	+ 1.49 V	_____	_____	+ 1.55 V
+5 Div position setting, -1.25 V offset	+ 1.49 V	_____	_____	+ 1.55 V
Ch4 500 mV Vert scale setting, 0 Div position setting, 0 V offset	+ 3.724 V	_____	_____	+ 3.876 V
-5 Div position setting, 0 V offset	+ 3.724 V	_____	_____	+ 3.876 V
+5 Div position setting, 0 V offset	+ 3.724 V	_____	_____	+ 3.876 V
<b>Offset accuracy, <math>\geq 4</math> GHz models</b>				
Ch1 10 mV Vert scale setting, -5 Div position setting, +0.45 V offset	+ 495.75 mV	_____	_____	+ 504.25 mV
5 Div position setting, -0.45 V offset	- 504.25 mV	_____	_____	- 495.75 mV
Ch1 20 mV Vert scale setting, -5 Div position setting, +0.4 V offset	+ 494.75 mV	_____	_____	+ 505.25 mV
5 Div position setting, -0.4 V offset	- 505.25 mV	_____	_____	- 494.75 mV

Table 3-3: Test record (cont.)

Instrument performance test	Minimum	Incoming	Outgoing	Maximum
Ch1 50 mV Vert scale setting, -5 Div position setting, +0.25 V offset	+ 491.75 mV	_____	_____	+ 508.25 mV
5 Div position setting, -0.25 V offset	- 508.25 mV	_____	_____	- 491.75 mV
Ch1 100 mV Vert scale setting, -5 Div position setting, +2.0 V offset	+ 2.474 V	_____	_____	+ 2.526 V
5 Div position setting, -2.0 V offset	- 2.526 V	_____	_____	- 2.474 V
Ch1 200 mV Vert scale setting, -5 Div position setting, +1.25 V offset	+ 1.965 V	_____	_____	+ 2.035 V
5 Div position setting, -1.25 V offset	- 2.035 V	_____	_____	- 1.965 V
Ch1 500 mV Vert scale setting, -5 Div position setting, 0 V offset	+ 2.434 V	_____	_____	+ 2.566 V
5 Div position setting, 0 V offset	- 2.566 V	_____	_____	- 2.434 V
Ch2 10 mV Vert scale setting, -5 Div position setting, +0.45 V offset	+ 495.75 mV	_____	_____	+ 504.25 mV
5 Div position setting, -0.45 V offset	- 504.25 mV	_____	_____	- 495.75 mV
Ch2 20 mV Vert scale setting, -5 Div position setting, +0.4 V offset	+ 494.75 mV	_____	_____	+ 505.25 mV
5 Div position setting, -0.4 V offset	- 505.25 mV	_____	_____	- 494.75 mV
Ch2 50 mV Vert scale setting, -5 Div position setting, +0.25 V offset	+ 491.75 mV	_____	_____	+ 508.25 mV
5 Div position setting, -0.25 V offset	- 508.25 mV	_____	_____	- 491.75 mV
Ch2 100 mV Vert scale setting, -5 Div position setting, +2.0 V offset	+ 2.474 V	_____	_____	+ 2.526 V
5 Div position setting, -2.0 V offset	- 2.526 V	_____	_____	- 2.474 V
Ch2 200 mV Vert scale setting, -5 Div position setting, +1.25 V offset	+ 1.965 V	_____	_____	+ 2.035 V
5 Div position setting, -1.25 V offset	- 2.035 V	_____	_____	- 1.965 V
Ch2 500 mV Vert scale setting, -5 Div position setting, 0 V offset	+ 2.434 V	_____	_____	+ 2.566 V
5 Div position setting, 0 V offset	- 2.566 V	_____	_____	- 2.434 V
Ch3 10 mV Vert scale setting, -5 Div position setting, +0.45 V offset	+ 495.75 mV	_____	_____	+ 504.25 mV
5 Div position setting, -0.45 V offset	- 504.25 mV	_____	_____	- 495.75 mV
Ch3 20 mV Vert scale setting, -5 Div position setting, +0.4 V offset	+ 494.75 mV	_____	_____	+ 505.25 mV
5 Div position setting, -0.4 V offset	- 505.25 mV	_____	_____	- 494.75 mV
Ch3 50 mV Vert scale setting, -5 Div position setting, +0.25 V offset	+ 491.75 mV	_____	_____	+ 508.25 mV
5 Div position setting, -0.25 V offset	- 508.25 mV	_____	_____	- 491.75 mV
Ch3 100 mV Vert scale setting, -5 Div position setting, +2.0 V offset	+ 2.474 V	_____	_____	+ 2.526 V
5 Div position setting, -2.0 V offset	- 2.526 V	_____	_____	- 2.474 V



**Table 3-3: Test record (cont.)**

<b>Instrument performance test</b>	<b>Minimum</b>	<b>Incoming</b>	<b>Outgoing</b>	<b>Maximum</b>
Ch3 200 mV Vert scale setting, -5 Div position setting, +1.25 V offset	+ 1.965 V	_____	_____	+ 2.035 V
5 Div position setting, -1.25 V offset	- 2.035 V	_____	_____	- 1.965 V
Ch3 500 mV Vert scale setting, -5 Div position setting, 0 V offset	+ 2.434 V	_____	_____	+ 2.566 V
5 Div position setting, 0 V offset	- 2.566 V	_____	_____	- 2.434 V
Ch4 10 mV Vert scale setting, -5 Div position setting, +0.45 V offset	+ 495.75 mV	_____	_____	+ 504.25 mV
5 Div position setting, -0.45 V offset	- 504.25 mV	_____	_____	- 495.75 mV
Ch4 20 mV Vert scale setting, -5 Div position setting, +0.4 V offset	+ 494.75 mV	_____	_____	+ 505.25 mV
5 Div position setting, -0.4 V offset	- 505.25 mV	_____	_____	- 494.75 mV
Ch4 50 mV Vert scale setting, -5 Div position setting, +0.25 V offset	+ 491.75 mV	_____	_____	+ 508.25 mV
5 Div position setting, -0.25 V offset	- 508.25 mV	_____	_____	- 491.75 mV
Ch4 100 mV Vert scale setting, -5 Div position setting, +2.0 V offset	+ 2.474 V	_____	_____	+ 2.526 V
5 Div position setting, -2.0 V offset	- 2.526 V	_____	_____	- 2.474 V
Ch4 200 mV Vert scale setting, -5 Div position setting, +1.25 V offset	+ 1.965 V	_____	_____	+ 2.035 V
5 Div position setting, -1.25 V offset	- 2.035 V	_____	_____	- 1.965 V
Ch4 500 mV Vert scale setting, -5 Div position setting, 0 V offset	+ 2.434 V	_____	_____	+ 2.566 V
5 Div position setting, 0 V offset	- 2.566 V	_____	_____	- 2.434 V

Table 3-3: Test record (cont.)

Instrument performance test	Minimum	Incoming	Outgoing	Maximum
<b>Channel bandwidth</b>				
<b>&lt; 3.5 GHz models</b>				
Ch1				
1 V	3.535 V	_____	_____	N/A
500 mV	2.12 V	_____	_____	N/A
200 mV	848 mV	_____	_____	N/A
100 mV	424 mV	_____	_____	N/A
50 mV	212 mV	_____	_____	N/A
20 mV	84.8 mV	_____	_____	N/A
10 mV	42.4 mV	_____	_____	N/A
5 mV	21.2 mV	_____	_____	N/A
Ch2				
1 V	3.535 V	_____	_____	N/A
500 mV	2.12 V	_____	_____	N/A
200 mV	848 V	_____	_____	N/A
100 mV	424 mV	_____	_____	N/A
50 mV	212 mV	_____	_____	N/A
20 mV	84.8 mV	_____	_____	N/A
10 mV	42.4 mV	_____	_____	N/A
5 mV	21.2 mV	_____	_____	N/A
Ch3				
1 V	3.535 V	_____	_____	N/A
500 mV	2.12 V	_____	_____	N/A
200 mV	848 V	_____	_____	N/A
100 mV	424 mV	_____	_____	N/A
50 mV	212 mV	_____	_____	N/A
20 mV	84.8 mV	_____	_____	N/A
10 mV	42.4 mV	_____	_____	N/A
5 mV	21.2 mV	_____	_____	N/A
Ch4				
1 V	3.535 V	_____	_____	N/A
500 mV	2.12 V	_____	_____	N/A
200 mV	848 V	_____	_____	N/A
100 mV	424 mV	_____	_____	N/A
50 mV	212 mV	_____	_____	N/A
20 mV	84.8 mV	_____	_____	N/A
10 mV	42.4 mV	_____	_____	N/A
5 mV	21.2 mV	_____	_____	N/A
<b>≥ 4 GHz models</b>				
Ch1				
200 mV	1.061 V	_____	_____	N/A
100 mV	424 mV	_____	_____	N/A
50 mV	212 mV	_____	_____	N/A
20 mV	84.8 mV	_____	_____	N/A
10 mV	42.4 mV	_____	_____	N/A

Table 3-3: Test record (cont.)

Instrument performance test	Minimum	Incoming	Outgoing	Maximum
<b>Ch2</b>				
200 mV	1.061 V	_____	_____	N/A
100 mV	424 mV	_____	_____	N/A
50 mV	212 mV	_____	_____	N/A
20 mV	84.8 mV	_____	_____	N/A
10 mV	42.4 mV	_____	_____	N/A
<b>Ch3</b>				
200 mV	1.061 V	_____	_____	N/A
100 mV	424 mV	_____	_____	N/A
50 mV	212 mV	_____	_____	N/A
20 mV	84.8 mV	_____	_____	N/A
10 mV	42.4 mV	_____	_____	N/A
<b>Ch4</b>				
200 mV	1.061 V	_____	_____	N/A
100 mV	424 mV	_____	_____	N/A
50 mV	212 mV	_____	_____	N/A
20 mV	84.8 mV	_____	_____	N/A
10 mV	42.4 mV	_____	_____	N/A
<b>3.5 GHz models</b>				
<b>Ch1</b>				
1 V	2.83 V	_____	_____	N/A
500 mV	1.41 V	_____	_____	N/A
200 mV	566 mV	_____	_____	N/A
100 mV	283 mV	_____	_____	N/A
50 mV	141.4 mV	_____	_____	N/A
20 mV	56.6 mV	_____	_____	N/A
10 mV	28.3 mV	_____	_____	N/A
5 mV	21.2 mV	_____	_____	N/A
<b>Ch2</b>				
1 V	2.83 V	_____	_____	N/A
500 mV	1.41 V	_____	_____	N/A
200 mV	566 mV	_____	_____	N/A
100 mV	283 mV	_____	_____	N/A
50 mV	141.4 mV	_____	_____	N/A
20 mV	56.6 mV	_____	_____	N/A
10 mV	28.3 mV	_____	_____	N/A
5 mV	21.2 mV	_____	_____	N/A
<b>Ch3</b>				
1 V	2.83 V	_____	_____	N/A
500 mV	1.41 V	_____	_____	N/A
200 mV	566 mV	_____	_____	N/A
100 mV	283 mV	_____	_____	N/A
50 mV	141.4 mV	_____	_____	N/A
20 mV	56.6 mV	_____	_____	N/A
10 mV	28.3 mV	_____	_____	N/A
5 mV	21.2 mV	_____	_____	N/A

**Table 3-3: Test record (cont.)**

<b>Instrument performance test</b>	<b>Minimum</b>	<b>Incoming</b>	<b>Outgoing</b>	<b>Maximum</b>
Ch4				
1 V	2.83 V	_____	_____	N/A
500 mV	1.41 V	_____	_____	N/A
200 mV	566 mV	_____	_____	N/A
100 mV	283 mV	_____	_____	N/A
50 mV	141.4 mV	_____	_____	N/A
20 mV	56.6 mV	_____	_____	N/A
10 mV	28.3 mV	_____	_____	N/A
5 mV	21.2 mV	_____	_____	N/A
Input resistance, ≥ 4 GHz models				
Ch1 10 mV/div				
Ch1 100 mV/div	49.0 Ω	_____	_____	51.0 Ω
Ch2 10 mV/div	47.8 Ω	_____	_____	52.2 Ω
Ch2 100 mV/div	49.0 Ω	_____	_____	51.0 Ω
Ch3 10 mV/div	47.8 Ω	_____	_____	52.2 Ω
Ch3 100 mV/div	49.0 Ω	_____	_____	51.0 Ω
Ch4 10 mV/div	47.8 Ω	_____	_____	52.2 Ω
Ch4 100 mV/div	49.0 Ω	_____	_____	51.0 Ω
	47.8 Ω	_____	_____	52.2 Ω

Table 3-3: Test record (cont.)

Instrument performance test	Minimum	Incoming	Outgoing	Maximum
Time base system				
Long term sample rate, delay time, and internal reference accuracy				
10 MHz, < 4 GHz models	9999.965 kHz	_____	_____	10000.035 kHz
10 MHz, ≥ 4 GHz models	9999.975 kHz	_____	_____	10000.025 kHz
External reference				
10 MHz	Pass/Fail	_____	_____	Pass/Fail
Delta time measurement, < 4 GHz models				
DPO7054 only:	N/A	_____	_____	6.0 ps
Delta time measurement ≥ 4 GHz models				
MSO72004C and DPO72004C, BWE off				
10 mV, rms	N/A	_____	_____	1.280 ps
10 mV, pk-pk	N/A	_____	_____	12.80 ps
50 mV, rms	N/A	_____	_____	1.172 ps
50 mV, pk-pk	N/A	_____	_____	11.72 ps
100 mV, rms	N/A	_____	_____	1.186 ps
100 mV, pk-pk	N/A	_____	_____	11.86 ps
MSO71604C and DPO71604C, BWE off				
10 mV, rms	N/A	_____	_____	1.280 ps
10 mV, pk-pk	N/A	_____	_____	12.80 ps
50 mV, rms	N/A	_____	_____	1.172 ps
50 mV, pk-pk	N/A	_____	_____	11.72 ps
100 mV, rms	N/A	_____	_____	1.186 ps
100 mV, pk-pk	N/A	_____	_____	11.86 ps
MSO71254C and DPO71254C, BWE off				
10 mV, rms	N/A	_____	_____	1.304 ps
10 mV, pk-pk	N/A	_____	_____	13.04 ps
50 mV, rms	N/A	_____	_____	1.201 ps
50 mV, pk-pk	N/A	_____	_____	12.01 ps
100 mV, rms	N/A	_____	_____	1.205 ps
100 mV, pk-pk	N/A	_____	_____	12.05 ps

Table 3-3: Test record (cont.)

Instrument performance test	Minimum	Incoming	Outgoing	Maximum
MSO70804 and DSA/DPO70804B, BWE off				
10 mV, rms	N/A	_____	_____	1.462 ps
10 mV, pk-pk	N/A	_____	_____	14.62 ps
50 mV, rms	N/A	_____	_____	1.295 ps
50 mV, pk-pk	N/A	_____	_____	12.95 ps
100 mV, rms	N/A	_____	_____	1.336 ps
100 mV, pk-pk	N/A	_____	_____	13.36 ps
MSO70604 and DPO70604B, BWE off				
10 mV, rms	N/A	_____	_____	1.625 ps
10 mV, pk-pk	N/A	_____	_____	16.25 ps
50 mV, rms	N/A	_____	_____	1.427 ps
50 mV, pk-pk	N/A	_____	_____	14.27 ps
100 mV, rms	N/A	_____	_____	1.463 ps
100 mV, pk-pk	N/A	_____	_____	14.63 ps
MSO70404 and DPO70404B, BWE off				
10 mV, rms	N/A	_____	_____	2.022 ps
10 mV, pk-pk	N/A	_____	_____	20.22 ps
50 mV, rms	N/A	_____	_____	1.762 ps
50 mV, pk-pk	N/A	_____	_____	17.62 ps
100 mV, rms	N/A	_____	_____	1.821 ps
100 mV, pk-pk	N/A	_____	_____	18.21 ps
<b>BWE on</b>				
MSO72004C and DPO72004C, 20 GHz				
50 mV, rms	N/A	_____	_____	1.260 ps
50 mV, pk-pk	N/A	_____	_____	12.60 ps
100 mV, rms	N/A	_____	_____	1.432 ps
100 mV, pk-pk	N/A	_____	_____	14.32 ps
MSO72004C and DPO72004C, 18 GHz				
10 mV, rms	N/A	_____	_____	1.336 ps
10 mV, pk-pk	N/A	_____	_____	13.36 ps
50 mV, rms	N/A	_____	_____	1.182 ps
50 mV, pk-pk	N/A	_____	_____	11.82 ps
100 mV, rms	N/A	_____	_____	1.234 ps
100 mV, pk-pk	N/A	_____	_____	12.34 ps

Table 3-3: Test record (cont.)

Instrument performance test	Minimum	Incoming	Outgoing	Maximum
MSO71604C and DPO71604C, 16 GHz				
10 mV, rms	N/A	_____	_____	1.219 ps
10 mV, pk-pk	N/A	_____	_____	12.19 ps
50 mV, rms	N/A	_____	_____	1.154 ps
50 mV, pk-pk	N/A	_____	_____	11.54 ps
100 mV, rms	N/A	_____	_____	1.159 ps
100 mV, pk-pk	N/A	_____	_____	11.59 ps
MSO71254C and DPO71254C, 12.5 GHz				
10 mV, rms	N/A	_____	_____	1.333 ps
10 mV, pk-pk	N/A	_____	_____	13.33 ps
50 mV, rms	N/A	_____	_____	1.212 ps
50 mV, pk-pk	N/A	_____	_____	12.12 ps
100 mV, rms	N/A	_____	_____	1.228 ps
100 mV, pk-pk	N/A	_____	_____	12.28 ps
MSO70804 and DSA/DPO70804B, 8 GHz				
10 mV, rms	N/A	_____	_____	1.354 ps
10 mV, pk-pk	N/A	_____	_____	13.54 ps
50 mV, rms	N/A	_____	_____	1.235 ps
50 mV, pk-pk	N/A	_____	_____	12.35 ps
100 mV, rms	N/A	_____	_____	1.241 ps
100 mV, pk-pk	N/A	_____	_____	12.41 ps
MSO70604 and DPO70604B, 6 GHz				
10 mV, rms	N/A	_____	_____	1.445 ps
10 mV, pk-pk	N/A	_____	_____	14.45 ps
50 mV, rms	N/A	_____	_____	1.295 ps
50 mV, pk-pk	N/A	_____	_____	12.95 ps
100 mV, rms	N/A	_____	_____	1.329 ps
100 mV, pk-pk	N/A	_____	_____	13.29 ps
MSO70404 and DPO70404B, 4 GHz				
10 mV, rms	N/A	_____	_____	1.674 ps
10 mV, pk-pk	N/A	_____	_____	16.74 ps
50 mV, rms	N/A	_____	_____	1.437 ps
50 mV, pk-pk	N/A	_____	_____	14.37 ps
100 mV, rms	N/A	_____	_____	1.478 ps
100 mV, pk-pk	N/A	_____	_____	14.78 ps

Table 3-3: Test record (cont.)

Instrument performance test	Minimum	Incoming	Outgoing	Maximum
Trigger system accuracy				
Time accuracy for time qualified triggers, < 4 GHz models,				
time range < 1 ms				
Lower Limit	3.5 ns	_____	_____	6.5 ns
Upper Limit	3.5 ns	_____	_____	6.5 ns
time range $\geq$ 1 $\mu$ s				
Lower Limit	1.9 $\mu$ s	_____	_____	2.1 $\mu$ s
Upper Limit	1.9 $\mu$ s	_____	_____	2.1 $\mu$ s
Time accuracy for time qualified triggers, $\geq$ 4 GHz models				
time range < 1 ms				
Lower Limit	4.77 ns	_____	_____	5.23 ns
Upper Limit	4.77 ns	_____	_____	5.23 ns
time range $\geq$ 1 $\mu$ s				
Lower Limit	1.9 $\mu$ s	_____	_____	2.1 $\mu$ s
Upper Limit	1.9 $\mu$ s	_____	_____	2.1 $\mu$ s
Ch1 trigger sensitivity, 50 MHz	Pass/Fail	_____	_____	Pass/Fail
Ch1 delayed trigger sensitivity $\geq$ 4 GHz models: 50 MHz	Pass/Fail	_____	_____	Pass/Fail
AUX trigger input sensitivity, 50 MHz	Pass/Fail	_____	_____	Pass/Fail
Ch1 trigger sensitivity				
< 4 GHz models:	Pass/Fail	_____	_____	Pass/Fail
$\geq$ 4 GHz models: 4 GHz	Pass/Fail	_____	_____	Pass/Fail
$\geq$ 4 GHz models: 6 GHz	Pass/Fail	_____	_____	Pass/Fail
$\geq$ 4 GHz models: 8 GHz	Pass/Fail	_____	_____	Pass/Fail
$\geq$ 4 GHz models: 11 GHz	Pass/Fail	_____	_____	Pass/Fail
Ch1 B trigger sensitivity				
$\geq$ 4 GHz models: 4 GHz	Pass/Fail	_____	_____	Pass/Fail
$\geq$ 4 GHz models: 6 GHz	Pass/Fail	_____	_____	Pass/Fail
$\geq$ 4 GHz models: 9 GHz	Pass/Fail	_____	_____	Pass/Fail
Ch1 AUX trigger input				
< 4 GHz models: 250 MHz	Pass/Fail	_____	_____	Pass/Fail
$\geq$ 4 GHz models: 1 GHz	Pass/Fail	_____	_____	Pass/Fail
Aux trigger out				
Vout Hi	1.0 V	_____	_____	
Vout Lo		_____	_____	0.25 V
Probe compensation output signal Voltage (difference)				
< 4 GHz models	985 mV	_____	_____	1015 mV
$\geq$ 4 GHz models	343.2 mV	_____	_____	536.8 mV
Serial trigger ( $\geq$ 4 GHz models with Option PTH or < 4 GHz models with Option PTM only)				



**Table 3-3: Test record (cont.)**

<b>Instrument performance test</b>	<b>Minimum</b>	<b>Incoming</b>	<b>Outgoing</b>	<b>Maximum</b>
<b>Baud rate limits</b>				
Serial word recognizer				
Signal path 0, Pattern matching 1				
Trigger 1 UI before 0	Pass	_____	_____	N/A
Trigger on 0	Pass	_____	_____	N/A
Trigger 1 UI after 0	Pass	_____	_____	N/A
Signal path 1, Pattern matching 1				
Trigger 1 UI before 1	Pass	_____	_____	N/A
Trigger on 1	Pass	_____	_____	N/A
Trigger 1 UI after 1	Pass	_____	_____	N/A
Clock recovery frequency range	Pass	_____	_____	N/A

## Signal Acquisition System Checks

These procedures check those characteristics that relate to the signal-acquisition system and are listed as checked under *Warranted Characteristics* in *Specifications*. (See Table 3-2.) for test equipment specifications.

### Check DC Voltage Measurement Accuracy

#### Equipment Required

One DC calibration generator (Item 6)  
One SMA male-to-BNC female adapter (Item 19)

#### Prerequisites

The instrument must meet the prerequisites. (See page 3-18, *Prerequisites*.)



**WARNING.** *The generator is capable of outputting dangerous voltages. Be sure to set the DC calibration generator to off or 0 volts before connecting, disconnecting, and/or moving the test hookup during the performance of this procedure.*

**1.** *Install the test hookup and preset the instrument controls:*

**a.** *Hook up the test-signal source:*

- Set the output of a DC calibration generator to off or 0 volts. Set the DC impedance of the generator to 50  $\Omega$ .
- Connect the output of a DC calibration generator. (See Figure 3-20.)

**b.** *Initialize the instrument:* Press **DEFAULT SETUP**.

**c.** *Modify the default settings:*

- From the button bar, touch **Horiz/Acq** and select the **Acquisition** tab.
- Touch **Average** and set the number of averages to **16**.
- < 4 GHz models: Touch **Vertical**, select **Vertical Setup**, and then touch Termination **50  $\Omega$** .

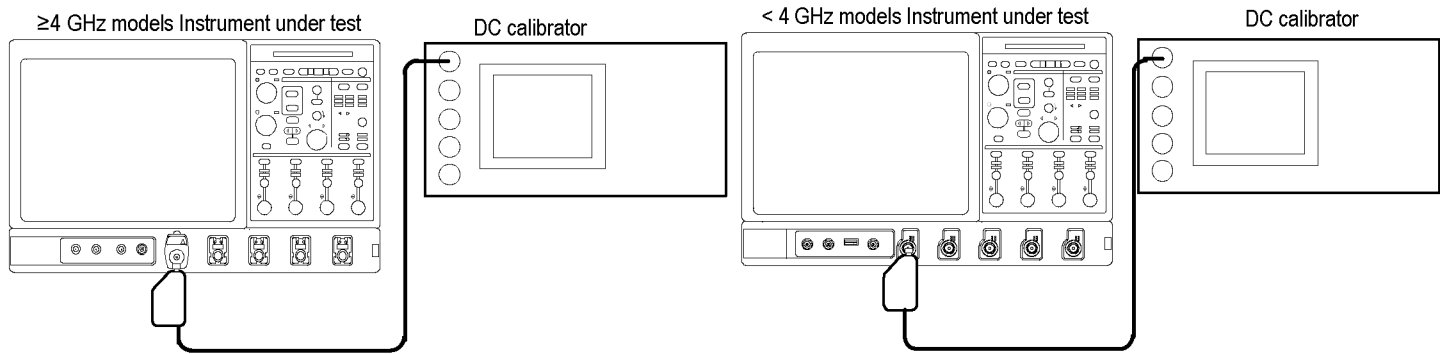

Figure 3-8: Initial test hookup

2. *Confirm input channels are within limits for DC accuracy at maximum offset and position:* Do the following substeps - test Ch 1 first, *skipping substep a of this step since Ch 1 is already selected from step 1.*
  - a. *Select an unchecked channel:*
    - From the button bar, touch **Measure** and then **Clear All** to remove the previous measurement.
    - Press the Vertical button of the channel just confirmed to remove the channel from the display.
    - Press the front-panel Vertical button that corresponds to the channel you are to confirm.
    - < 4 GHz models: Touch **Vertical**, select **Vertical Setup**, and then touch Termination **50 Ω**.
    - Set the generator output to 0 V.
    - Move the test hookup to the channel you selected.

**b. Turn on the measurement Mean for the channel:**

- From the button bar, touch **Measure** and select the **Ampl** tab, **More**, and then touch **Mean** to measure the mean of the current channel.
- Press the **X** (Close) button.

---

**NOTE.** When setting the Fluke generator to output >5 V, use the following procedure:

Press the Aux button

Press the fourth soft key down (Selects the pulse with an exclamation point)

Set the amplitude to 5.3 or 5.5 V

Press the ->| key to select the pulse energy

Set the energy to 50J, and press the Output On key

Press the Trig Pulse soft key to trigger the pulse (this will generate a pulse with 25 seconds duration).

---

Use the normal DC output for the 1 V, 3 V, and 5 V generator settings.

---



---

**NOTE.** If any of the voltages supplied by your generator are not calibrated, verify those generator voltages using a digital multimeter; item 27.

---

- c. Set the vertical scale:** Set the vertical **Scale** to one of the settings listed in the following table that is not yet checked, starting with the first setting listed.

**Table 3-4: DC voltage measurement accuracy**

Scale setting	Position setting (Divs)	Offset setting <sup>1</sup>	Generator setting	Accuracy limits
<b>≥ 4 GHz models</b>				
10 mV	-5	+0.45 V	+530 mV	+524.75 mV to +535.25 mV
	+5	-0.45 V	-530 mV	-535.25 mV to -524.75 mV
20 mV	-5	+0.4 V	+560 mV	+552.75 mV to +567.25 mV
	+5	-0.4 V	-560 mV	-567.25 mV to -552.75 mV
50 mV	-5	+0.25 V	+650 mV	+636.75 mV to +663.25 mV
	+5	-0.25 V	-650 mV	-663.25 mV to -636.75 mV
100 mV	-5	+2.0 V	+2.8 V	+2.764 V to 2.836 V
	+5	-2.0 V	-2.8 V	-2.836 V to -2.764 V
200 mV	-5	+1.25 V	+2.75 V	+2.697 V to 2.803 V
	+5	-1.25 V	-2.75 V	-2.803 V to -2.697 V
500 mV	-5	0 V	+3.5 V	+3.394 V to 3.606 V
	+5	0 V	-3.5 V	-3.606 V to -3.394 V

Table 3-4: DC voltage measurement accuracy (cont.)

Scale setting	Position setting (Divs)	Offset setting <sup>1</sup>	Generator setting	Accuracy limits
<b>&lt; 4 GHz models</b>				
1 mV	-5	+0.5 V	+507 mV	+504.25 mV to +509.76 mV
	+5	-0.5 V	-507 mV	-509.76 mV to -504.25 mV
2 mV	-5	+0.5 V	+516 mV	+512.98 mV to +519.03 mV
	+5	-0.5 V	-516 mV	-519.03 mV to -512.98 mV
5 mV	-5	+0.5 V	+540 mV	+536.26 mV to +543.74 mV
	+5	-0.5 V	-540 mV	-543.74 mV to -536.26 mV
10 mV	-5	+0.5 V	+580 mV	+574.20 mV to +585.80 mV
	+5	-0.5 V	-580 mV	-585.80 mV to -574.20 mV
20 mV	-5	+0.5 V	+660 mV	+651.65 mV to +668.35 mV
	+5	-0.5 V	-660 mV	-668.35 mV to -651.65 mV
50 mV	-5	+0.5 V	+900 mV	+884.00 mV to +916.00 mV
	+5	-0.5 V	-900 mV	-916.00 mV to -884.00 mV
90 mV	-5	+0.5 V	+1.22 V	+1.194 V to +1.246 V
	+5	-0.5 V	-1.22 V	-1.246 V to -1.194 V
100 mV	0	+4.5 V	+4.8 V	+4.746 V to +4.854 V
	0	-4.5 V	-4.8 V	-4.854 V to -4.746 V
200 mV	-2	+4.6 V	+4.8 V	+4.725 V to +4.875 V
	+2	-4.6 V	-4.8 V	-4.875 V to -4.725 V
500 mV	-2	+5.0 V	+4.5 V	+4.345 V to +4.655 V
	+2	-5.0 V	-4.5 V	-4.655 V to -4.345 V
1 V	0	+2.0 V	+5.0 V	+4.745 V to +5.255 V
	0	-2.0 V	-5.0 V	-5.255 V to -4.745 V

<sup>1</sup> Set as precisely as the instrument's offset resolution permits.

- d. *Display the test signal:*
  - From the button bar touch **Vertical** and touch **Position**.
  - Use the keypad to set vertical position to a position setting listed in the table for the current vertical scale setting. The baseline level may move off screen.
  - Touch **Offset**.
  - Use the keypad to set vertical offset to the positive-polarity setting listed in the table for the current vertical scale setting. The baseline level will remain off screen.
  - Set the generator to the level and polarity indicated in the table for the vertical scale, position, and offset settings you have made.
- e. *Measure the test signal:* Press the **X** (close) button. Read the measurement results at the measurement statistics **Mean** measurement readout. See the following figure.

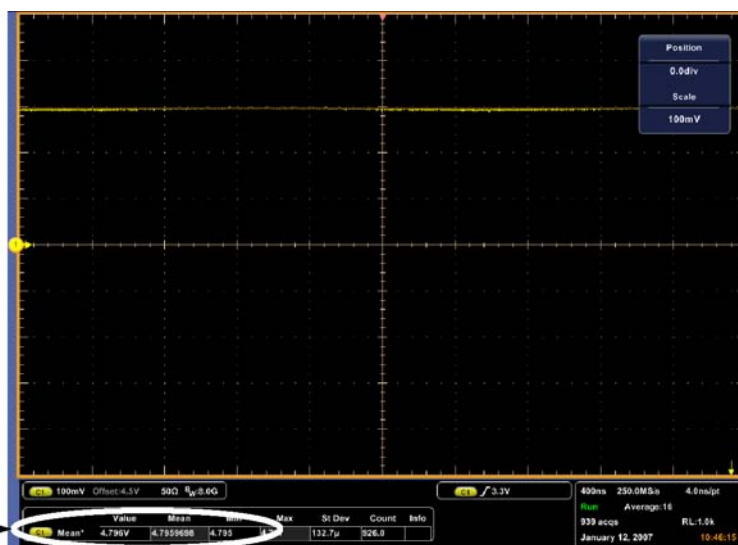

Turn on the mean measurement and read the results here.

Figure 3-9: Measurement of DC accuracy at maximum offset and position



**Check DC Gain Accuracy,  
≥ 4 GHz models**

**Equipment required**

One DC calibration generator (Item 6)  
One SMA male-to-female BNC adapter (Item 19)

**Prerequisites**

The instrument must meet the prerequisites.  
(See page 3-18, *Prerequisites*.)



**WARNING.** *The generator is capable of outputting dangerous voltages. To avoid injury, be sure to set the DC calibration generator to off or 0 volts before connecting, disconnecting, and/or moving the test hookup during this procedure.*

**1. Install the test hookup and preset the instrument controls:**

**a. Hook up the test-signal source:**

- Set the output of a DC calibration generator to off or 0 volts. Set the DC impedance of the generator to 50 Ω.
- Connect the generator to **Ch 1** through an adapter. Refer to the following figure.

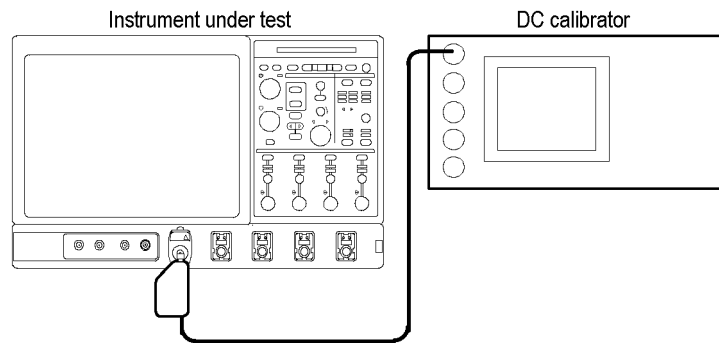

**b. Initialize the instrument:** Press **Default Setup**

**c. Modify the default settings:**

- From the tool bar, touch **Horiz/Acq** and select the **Acquisition** tab.
- Touch **Average** and set the number of averages to **16**.



2. *Confirm input channels are within limits for DC gain accuracy. Do the following substeps - test Ch 1 first, skipping substep a of this step since Ch 1 is already selected from step 1.*
  - a. *Select an unchecked channel:*
    - From the tool bar, touch **Measure** and then **Clear All** to remove the previous measurement.
    - Press the Vertical button of the channel just confirmed to remove the channel from the display.
    - Press the front-panel Vertical button that corresponds to the channel you are to confirm.
    - *Set the generator output to 0 V.*
    - Move the test hookup to the channel you selected.
  - b. *Turn on the measurement Mean for the channel:*
    - From the tool bar, touch **Measure** and select the **Ampl** tab, **More**, and then touch **Mean** to measure the mean of the current channel.
    - Press the **X** (Close) button.
  - c. *Set the vertical scale:* Set the vertical **Scale** to one of the settings in the following table that is not yet checked, starting with the first setting.

Table 3-5: Gain accuracy

Channel	Scale setting	Position setting (Divs)	Offset setting	Generator setting	Measurement mean	Difference of measurement means	Accuracy limits
<b>≥ 4 GHz models</b>							
Ch1	10 mV	0	0 V	+38.0 mV			+74.48 mV to +77.52 mV
				-38.0 mV			
		-5	+0.45 V	+538 mV			
			+462 mV				
		5	-0.45 V	-462 mV			+74.48 mV to +77.52 mV
				-538 mV			
	20 mV	0	0 V	+76.0 mV			+148.960 mV to +155.040 mV
				-76.0 mV			
		-5	+0.4 V	+576.0 mV			
			+424.0 mV				
		5	-0.4 V	-424.0 mV			+148.960 mV to +155.040 mV
				-576.0 mV			

Table 3-5: Gain accuracy (cont.)

Channel	Scale setting	Position setting (Divs)	Offset setting	Generator setting	Measurement mean	Difference of measurement means	Accuracy limits
Ch1	50 mV	0	0 V	+190 mV			+372.40 mV to +387.60 mV
				-190 mV			
		-5	+0.25 V	+690 mV			+372.40 mV to +387.60 mV
	100 mV	0	0 V	+380 mV			+744.80 mV to +775.20 mV
				-380 mV			
		-5	+2.0 V	+2.88 V			+744.80 mV to +775.20 mV
	200 mV	0	0 V	+760 mV			+1.49 V to +1.55 V
				-760 mV			
		-5	+1.25 V	+3.01 V			+1.49 V to +1.55 V
500 mV	0	0 V	+1.90 V			+3.724 V to +3.876 V	
			-1.90 V				
	-5	0 V	+4.40 V			+3.724 V to +3.876 V	
Ch2	10 mV	0	0 V	+38.0 mV			+74.48 mV to +77.52 mV
				-38.0 mV			
		-5	+0.45 V	+538 mV			+74.48 mV to +77.52 mV
	500 mV	0	0 V	-0.60 V			+3.724 V to +3.876 V
				-4.40 V			
		5	-0.45 V	-462 mV			+74.48 mV to +77.52 mV
					-538 mV		

Table 3-5: Gain accuracy (cont.)

Channel	Scale setting	Position setting (Divs)	Offset setting	Generator setting	Measurement mean	Difference of measurement means	Accuracy limits
Ch2	20 mV	0	0 V	+76.0 mV			+148.960 mV to +155.040 mV
				-76.0 mV			
		-5	+0.4 V	+576.0 mV			+148.960 mV to +155.040 mV
				+424.0 mV			
		5	-0.4 V	-424.0 mV			+148.960 mV to +155.040 mV
				-576.0 mV			
50 mV	50 mV	0	0 V	+190 mV			+372.40 mV to +387.60 mV
				-190 mV			
		-5	+0.25 V	+690 mV			+372.40 mV to +387.60 mV
				+310 mV			
		5	-0.25 V	-310 mV			+372.40 mV to +387.60 mV
				-690 mV			
100 mV	100 mV	0	0 V	+380 mV			+744.80 mV to +775.20 mV
				-380 mV			
		-5	+2.0 V	+2.88 V			+744.80 mV to +775.20 mV
				+2.12 V			
		5	-2.0 V	-2.12 V			+744.80 mV to +775.20 mV
				-2.88 V			
200 mV	200 mV	0	0 V	+760 mV			+1.49 V to +1.55 V
				-760 mV			
		-5	+1.25 V	+3.01 V			+1.49 V to +1.55 V
				+1.49 V			
		5	-1.25 V	-1.49 V			+1.49 V to +1.55 V
				-3.01 V			
500 mV	500 mV	0	0 V	+1.90 V			+3.724 V to +3.876 V
				-1.90 V			
		-5	0 V	+4.40 V			+3.724 V to +3.876 V
				+0.60 V			
		5	0 V	-0.60 V			+3.724 V to +3.876 V
				-4.40 V			

Table 3-5: Gain accuracy (cont.)

Channel	Scale setting	Position setting (Divs)	Offset setting	Generator setting	Measurement mean	Difference of measurement means	Accuracy limits
Ch3	10 mV	0	0 V	+38.0 mV			+74.48 mV to +77.52 mV
				-38.0 mV			
		-5	+0.45 V	+538 mV			+74.48 mV to +77.52 mV
	20 mV	0	0 V	+76.0 mV			+148.960 mV to +155.040 mV
				-76.0 mV			
		-5	+0.4 V	+576.0 mV			+148.960 mV to +155.040 mV
50 mV	50 mV	0	0 V	+190 mV			+372.40 mV to +387.60 mV
				-190 mV			
		-5	+0.25 V	+690 mV			+372.40 mV to +387.60 mV
	100 mV	0	0 V	+380 mV			+744.80 mV to +775.20 mV
				-380 mV			
		-5	+2.0 V	+2.88 V			+744.80 mV to +775.20 mV
200 mV	200 mV	0	0 V	+760 mV			+1.49 V to +1.55 V
				-760 mV			
		-5	+1.25 V	+3.01 V			+1.49 V to +1.55 V
	500 mV	0	0 V	+1.49 V			+1.49 V to +1.55 V
				-1.49 V			
		-5	-1.25 V	-1.49 V			+1.49 V to +1.55 V
				-3.01 V			

Table 3-5: Gain accuracy (cont.)

Channel	Scale setting	Position setting (Divs)	Offset setting	Generator setting	Measurement mean	Difference of measurement means	Accuracy limits
Ch3	500 mV	0	0 V	+1.90 V			+3.724 V to +3.876 V
				-1.90 V			
		-5	0 V	+4.40 V			+3.724 V to +3.876 V
				+0.60 V			
		5	0 V	-0.60 V			+3.724 V to +3.876 V
				-4.40 V			
Ch4	10 mV	0	0 V	+38.0 mV			+74.48 mV to +77.52 mV
				-38.0 mV			
		-5	+0.45 V	+538 mV			+74.48 mV to +77.52 mV
				+462 mV			
		5	-0.45 V	-462 mV			+74.48 mV to +77.52 mV
				-538 mV			
	20 mV	0	0 V	+76.0 mV			+148.960 mV to +155.040 mV
				-76.0 mV			
		-5	+0.4 V	+576.0 mV			+148.960 mV to +155.040 mV
				+424.0 mV			
		5	-0.4 V	-424.0 mV			+148.960 mV to +155.040 mV
				-576.0 mV			
	50 mV	0	0 V	+190 mV			+372.40 mV to +387.60 mV
				-190 mV			
		-5	+0.25 V	+690 mV			+372.40 mV to +387.60 mV
				+310 mV			
		5	-0.25 V	-310 mV			+372.40 mV to +387.60 mV
				-690 mV			
100 mV	0	0 V	+380 mV			+744.80 mV to +775.20 mV	
			-380 mV				
	-5	+2.0 V	+2.88 V			+744.80 mV to +775.20 mV	
			+2.12 V				
	5	-2.0 V	-2.12 V			+744.80 mV to +775.20 mV	
			-2.88 V				

Table 3-5: Gain accuracy (cont.)

Channel	Scale setting	Position setting (Divs)	Offset setting	Generator setting	Measurement mean	Difference of measurement means	Accuracy limits
Ch4	200 mV	0	0 V	+760 mV			+1.49 V to +1.55 V
				-760 mV			
		-5	+1.25 V	+3.01 V		+1.49 V	+1.49 V to +1.55 V
	500 mV	0	0 V	+1.90 V			+3.724 V to +3.876 V
				-1.90 V			
		-5	0 V	+4.40 V		+0.60 V	+3.724 V to +3.876 V
5	0	0 V	-1.49 V			+1.49 V to +1.55 V	
			-3.01 V				
	5	0 V	-0.60 V		-4.40 V	+3.724 V to +3.876 V	

**d. Display the test signal:**

- From the tool bar touch **Vertical** and then touch **Position**.
- Use the keypad to set vertical position to the number of divisions listed in the table for the current vertical scale setting and offset.
- Touch **Offset**.
- Use the keypad to set vertical offset to the setting listed in the table for the current vertical scale and position settings. The baseline level may move off screen.
- Set the generator to the level and polarity indicated in the table for the vertical scale, position, and offset settings you have made. The DC test level should appear on screen. (If it does not return, the accuracy check has failed for the current vertical scale, position, and offset settings of the current channel.)

**e. Measure the test signal:** Press the **Close** button.

- Read the measurement results at the measurement statistics **Mean** measurement readout. Refer to the following figure.
- Record the Mean in the Measurement Mean column. (See Table 3-5.)

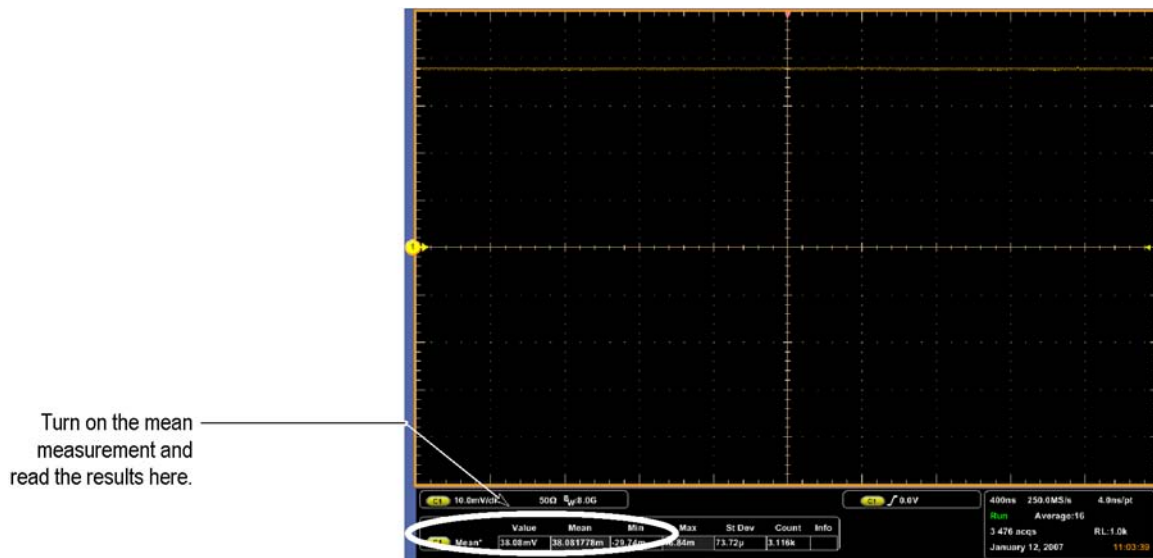

Figure 3-10: Measurement of DC gain accuracy

- f. *Measure second mean:*
    - Set the generator to the second level and polarity indicated in the table for the vertical scale, position, and offset settings you have made.
    - Repeat substep e using the current vertical scale, position, offset, and new generator setting for the second mean.
  - g. *Check against limits:*
    - Subtract the second measurement mean from the first measurement mean for the current vertical scale, position, and offset.
    - Record the difference of the two mean measurements in the Difference of Measurement Means column of the table. (See Table 3-5.)
    - CHECK that the Difference of Measurement Mean is within the limits listed for the current vertical scale/position/offset/generator settings. Enter measurement mean difference value on test record.
  - h. Repeat substeps d through g, using the next position, offset and generator settings listed in the table for the current vertical scale.
  - i. Repeat substeps c through h until all vertical scale settings, listed in the table, are checked for the channel under test. (See Table 3-5.)
  - j. *Test all channels:* Repeat substeps a through i for all four channels.
3. *Disconnect the hookup:*
    - a. *Set the generator output to 0 V.*
    - b. Disconnect the generator output from the channel last tested.

**Check Offset Accuracy  
≥ 4 GHz models**

**Equipment Required**

One DC calibration generator (Item 6)  
One SMA male-to-female BNC adapter (Item 19)

**Prerequisites**

The instrument must meet the prerequisites. (See page 3-18, *Prerequisites*.)



**WARNING.** The generator is capable of outputting dangerous voltages. To avoid injury, be sure to set the DC calibration generator to off or 0 volts before connecting, disconnecting, and/or moving the test hookup during this procedure.

**1. Install the test hookup and preset the instrument controls:**

**a. Hook up the test-signal source:**

- Set the output of a DC calibration generator to off or 0 volts. Set the DC impedance of the generator to 50 Ω.
- Connect the output of a DC calibration generator to **Ch 1** through an adapter. Refer to the following figure.

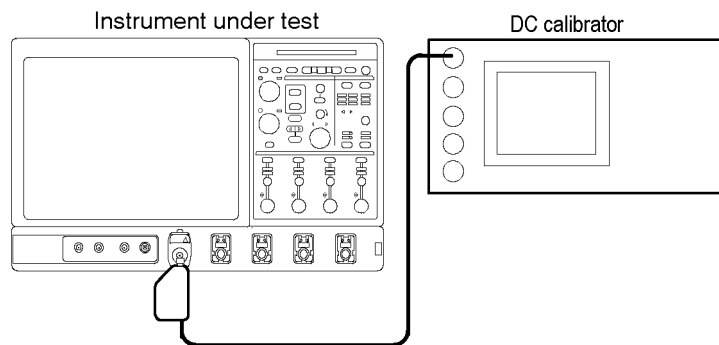

**Figure 3-11: Initial test hookup**

**b. Initialize the instrument:** Press **Default Setup**.

**c. Modify the default settings:**

- From the tool bar, touch **Horiz/Acq** and select the **Acquisition** tab.
- Touch **Average** and set the number of averages to **16**.



2. *Confirm input channels are within limits for offset accuracy.* Do the following substeps - test Ch 1 first, *skipping substep a since Ch 1 is already selected from step 1.*
  - a. *Select an unchecked channel:*
    - From the tool bar, touch **Measure** and then **Clear All** to remove the previous measurement.
    - Press the Vertical button of the channel just confirmed to remove the channel from the display.
    - Press the front-panel Vertical button that corresponds to the channel you are to confirm.
    - *Set the generator output to 0 V.*
    - Move the test hookup to the channel you selected.
  - b. *Turn on the measurement Mean for the channel:*
    - From the tool bar, touch **Measure** and select the **Ampl** tab, **More**, and then touch **Mean** to measure the mean of the current channel.
    - Press the **X** (Close) button.
  - c. *Set the vertical scale:* Set the vertical **Scale** to one of the settings in the following table that is not yet checked.

Table 3-6: Offset accuracy

Scale setting	Position setting (Divs)	Offset setting <sup>1</sup>	Generator setting	Accuracy limits
<b>≥ 4 GHz models</b>				
10 mV	-5	+0.45 V	+500 mV	+495.75 mV to +504.25 mV
	5	-0.45 V	-500 mV	-504.25 mV to -495.75 mV
20 mV	-5	+0.4 V	+500 mV	+494.75 mV to +505.25 mV
	5	-0.4 V	-500 mV	-505.25 mV to -494.75 mV
50 mV	-5	+0.25 V	+500 mV	+491.75 mV to +508.25 mV
	5	-0.25 V	-500 mV	-508.25 mV to -491.75 mV
100 mV	-5	+2.0 V	+2.5 V	+2.474 V to +2.526 V
	5	-2.0 V	-2.5 V	-2.526 V to -2.474 V
200 mV	-5	+1.25 V	+2.5 V	+1.965 V to +2.035 V
	5	-1.25 V	-2.5 V	-2.035 V to -1.965 V
500 mV	-5	0 V	+2.5 V	+2.434 V to +2.566 V
	5	0 V	-2.5 V	-2.566 V to -2.434 V

<sup>1</sup> Set as precisely as the instrument's offset resolution permits.

- d. *Display the test signal:*
  - From the tool bar touch **Vertical** and then touch **Position**.
  - Use the keypad to set vertical position to the setting listed in the table.
  - Touch **Offset**.
  - Use the keypad to set vertical offset to the positive-polarity setting listed in the table for the current vertical scale setting. The baseline level may move off screen.
  - Set the generator to the level and polarity indicated in the table for the vertical scale, position, and offset settings you have made.
- e. *Measure the test signal:* Press **Close**. Read the measurement results at the **Mean** measurement readout. Refer to the following figure.

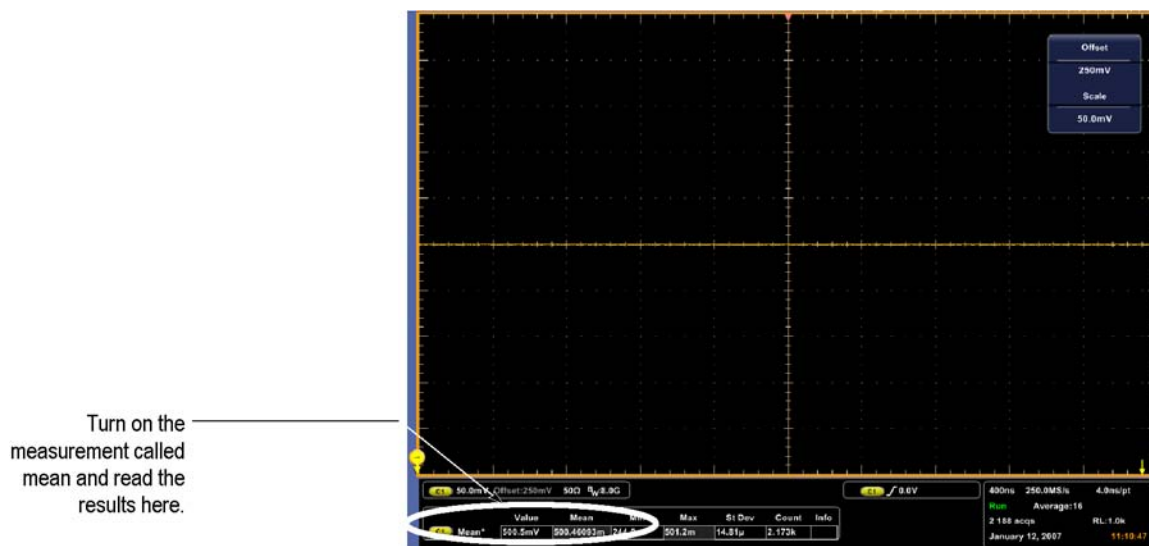

Figure 3-12: Measurement of offset accuracy

**f.** *Check against limits:*

- CHECK that the readout for the measurement **Mean** readout on screen is within the limits listed for the current vertical scale and position/offset/generator settings. Enter the value on the test record.
- Repeat substep d, using the offset and generator settings as is listed in the table.
- CHECK that the **Mean** measurement readout on screen is within the limits listed for the current vertical scale setting and position/offset/generator settings. Enter the value on the test record.
- Repeat substep d, using the negative-polarity offset and generator settings as is listed in the table.
- CHECK that the **Mean** measurement readout on screen is within the limits listed for the current vertical scale setting and position/offset/generator settings. Enter the value on the test record.
- Repeat substeps c through f until all vertical scale settings, are checked for the channel under test. (See Table 3-6.)

**g.** *Test all channels:* Repeat substeps a through f for all four channels.

**3.** *Disconnect the hookup:*

- a.** *Set the generator output to 0 V.*
- b.** Disconnect the generator from the channel last tested.

**Check Analog Bandwidth,  
< 3.5 GHz models**

**Equipment required**

**Prerequisites**

One sine wave generator (Item 9)  
 One level meter and power sensor (Item 10)  
 One power splitter (Item 11)  
 50  $\Omega$  precision cable 2.92 mm male-to-female (Item 12)  
 One K male-to-male adapter (Item 13)  
 SMA male-to-BNC female adapter (Item 19)

(See page 3-18, *Prerequisites*.)

**1. Install the test hookup and preset the instrument controls:**

**a. Initialize the instrument:**

- Press **Default Setup**.

**b. Modify the default settings:**

- Touch **Vertical**, select **Vertical Setup**, and then touch Termination **50  $\Omega$** .
- From the Bandwidth drop-down list, select the maximum bandwidth for your instrument.
- Turn the horizontal **Scale** knob to **50 ns**.
- From the button bar, touch **Horiz/Acq** and select the **Horizontal** tab. Select Constant Sample Rate mode. Set the Sample Rate to **200 GS/s**.
- From the button bar, touch **Horiz/Acq** and select the **Acquisition** tab. Set the acquisition mode as follows:

Touch **Average** and set the number of averages to **16**.

- Set the sampling mode as follows:

Touch the **Equivalent ET** button.

- From the button bar, touch **Measure**. Touch Setups **Ref Levs**; then touch the **Histogram** button.

**c. Hook up the test-signal source:** Connect the sine wave output of a sine wave generator to **Ch 1** through a power splitter. Connect the power sensor of the power meter to the power splitter. (See Figure 3-13.) Set the output of the generator to a reference frequency of 50 MHz or less.

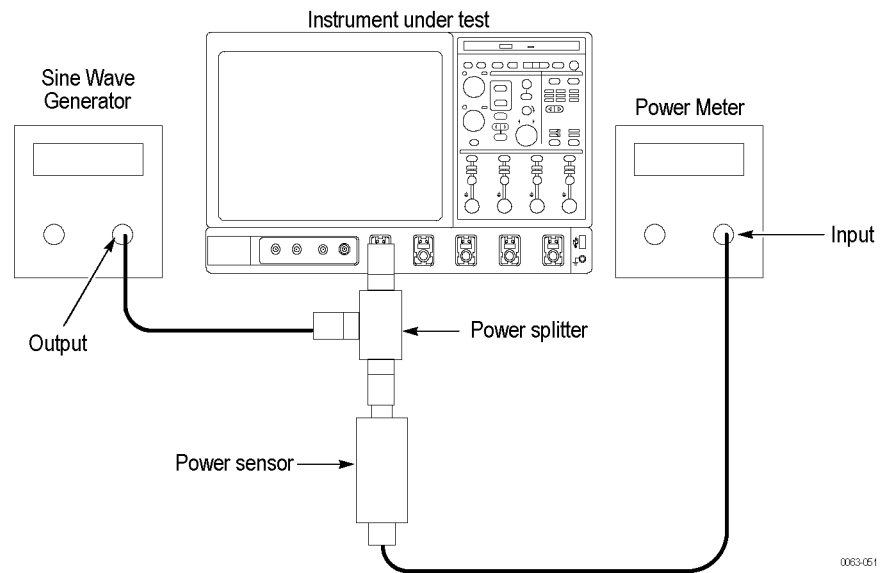

**Figure 3-13: Initial test hookup**

2. *Confirm the input channels are within limits for analog bandwidth: Do the following substeps - test Ch 1 first, skipping substeps a and b since Ch 1 is already set up for testing from step 1.*
  - a. *Select an unchecked channel:*
    - From the button bar, touch **Measure** and then **Clear All** to remove the previous measurement.
    - Press the Vertical button of the channel just confirmed to remove the channel from the display.
    - Press the front-panel Vertical button that corresponds to the channel you are to confirm.
    - Touch **Vertical**, select **Vertical Setup**, and then touch Termination **50 Ω**.
    - Move the leveled output of the sine wave generator to the channel you selected.
  - b. *Match the trigger source to the channel selected:* Press the Trigger **Source** button until the source that corresponds to the channel you are to confirm is on.

Table 3-7: Analog bandwidth, &lt; 3.5 GHz models

Vertical scale	Reference amplitude	Horizontal scale	Test frequency			
			DPO7254	DPO7104	DPO7054	-3 dB
5 mV	30 mV	1 ns	2.0 GHz	1 GHz	500 MHz	≥21.2 mV
10 mV	60 mV	1 ns	2.501 GHz	1 GHz	500 MHz	≥42.4 mV
20 mV	120 mV	1 ns	2.501 GHz	1 GHz	500 MHz	≥84.8 mV
50 mV	300 mV	1 ns	2.501 GHz	1 GHz	500 MHz	≥212 mV
100 mV	600 mV	1 ns	2.501 GHz	1 GHz	500 MHz	≥424 mV
200 mV	1.2 V	1 ns	2.501 GHz	1 GHz	500 MHz	≥848 mV
500 mV	3 V <sup>1</sup>	1 ns	2.501 GHz	1 GHz	500 MHz	≥2.12 V <sup>1</sup>
1 V	5 V <sup>1</sup>	1 ns	2.501 GHz	1 GHz	500 MHz	≥3.535 V <sup>1</sup>

<sup>1</sup> If your generator cannot output the required amplitude, determine its maximum output at the Test frequency, and use this for the reference amplitude. The -3 dB limit can be calculated as:  $0.707 \times \text{reference amplitude}$ .

**c.** *Set the vertical scale:*

For the channel you are testing, set the vertical **Scale** to the next setting in the table, starting with the 100 mV setting. (See Table 3-7.)

**d.** *Set the triggering coupling:* From the button bar, touch **Trigger**, then select **Coupling DC**.

**e.** *Display the test signal:* Do the following subparts to first display the reference signal and then the test signal.

- From the button bar touch **Measure**; then select the **Time** tab.
- Touch the **Freq** button to measure the frequency of the current channel.
- Select the **Ampl** tab. Touch the **Amplitude** button.
- Touch the **Statistics** button, then touch the **Mean** button.
- Touch the **X** (Close) button.
- Set the generator output so the Chx Amplitude mean readout equals the reference amplitude in the table. This corresponds to the vertical scale set in substep c. (See Table 3-7.)
- Record the reading on the power meter.
- Set the trigger as follows:

Press the front-panel **Push-Set 50%** as necessary to trigger a stable display. At full bandwidth, you may also want to make small, manual adjustments to the trigger level. You can use the **Trigger Level** knob to do this.

f. *Measure the test signal:*

Set the frequency of the generator, as shown on screen to the test frequency in the table that corresponds to the vertical scale set in substep c. (See Table 3-7.) (See Figure 3-14.)

Set the horizontal **Scale** to the horizontal scale setting that corresponds to the vertical scale set in substep c. (See Table 3-7.) Press **PUSH-SET 50%** as necessary to trigger the signal.

Adjust the output of the generator until the reading on the power meter is equal to the reading recorded on the power meter in substep e.

Read the results at the Chx Amplitude mean readout, which will automatically measure the amplitude of the test signal. Refer to the following figure.

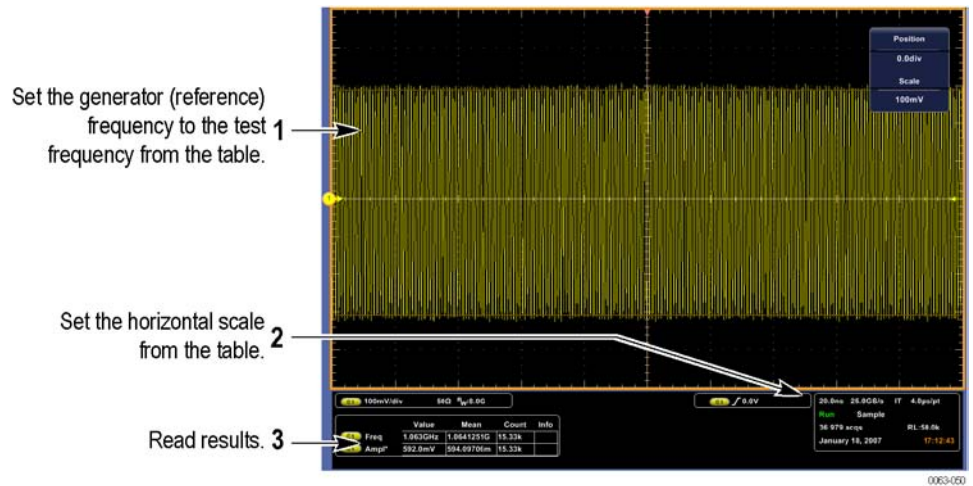

Figure 3-14: Measurement of analog bandwidth

- g.** *Check against limits:*

    - CHECK that the **Amplitude** mean readout on screen is within the limits listed in the table for the current vertical scale setting. (See Table 3-7.)
    - Enter the voltage on the test record.
    - When finished checking, set the horizontal **Scale** back to the 20 ns.
  - h.** *Check remaining vertical scale settings against limits:*

    - Check the remaining vertical scale settings for the channel under test by repeating substeps c through g for each of the remaining scale settings for the channel under test.
    - When doing substep f, skip the subparts that turn on the Chx Amplitude mean measurement until you check a new channel.
    - When selecting a new channel and before doing substep f, touch the **Clear All** button to remove the previous channel measurements.
  - i.** *Test all channels:* Repeat substeps a through g for all four channels.
- 3.** *Disconnect the hookup:* Disconnect the test hook up from the input connector of the channel last tested.



**Check Channel Bandwidth,  
≥ 3.5 GHz models****Equipment Required**

One sine wave generator (Item 9)  
 One level meter and power sensor (Item 10)  
 One power splitter (Item 11)  
 50  $\Omega$  precision cable 2.92 mm male-to-female (Item 12)  
 One K male-to-male adapter (Item 13)  
 SMA male-to-BNC female adapter (Item 19)

**Prerequisites**

(See page 3-18, *Prerequisites*.)

**1. Install the test hookup and preset the instrument controls:****a. Initialize the instrument:**

- Press **Default Setup**.

**b. Modify the default settings:**

- Touch **Vertical**, select **Vertical Setup**.
- DPO7354: Touch Termination **50  $\Omega$** .
- From the Bandwidth drop-down list, select the maximum bandwidth for your instrument.
- Turn the horizontal **Scale** knob to **40 ns** (DPO7354: **50 ns**).
- From the button bar, touch **Horiz/Acq** and select the **Horizontal** tab. Select Constant Sample Rate mode. Set the Sample Rate to **250 GS/s** (DPO7354: **200 GS/s**).
- From the button bar, touch **Horiz/Acq** and select the **Acquisition** tab. Set the acquisition mode as follows:

Touch **Sample**.

- Set the sampling mode as follows:

Touch the **Interpolate IT** button.

- From the button bar, touch **Measure**. Touch Setups **Ref Levs**; then touch the **Histogram Mode** button.
- If your instrument has enhanced bandwidth, from the toolbar, touch **Vertical** and check **Force Constant Sample Rate** (Digital filters ensured). Select **Apply to All Channels**.

**c. Hook up the test-signal source:** Connect the sine wave output of the sine wave generator to **Ch 1** through a power splitter. Connect the power sensor of the power meter to the power splitter. Set the output of the generator to a reference frequency of 50 MHz. (See Figure 3-15.)

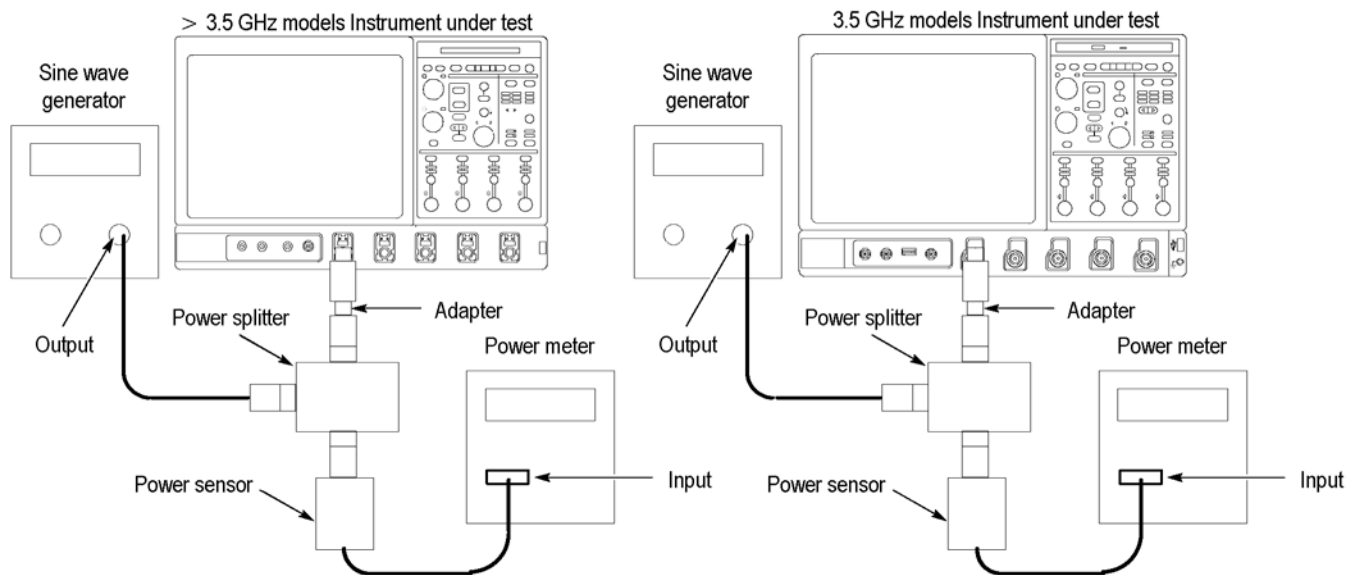

Figure 3-15: Initial test hookup

2. *Confirm the input channels are within limits for bandwidth:* Do the following substeps - test Ch 1 first, *skipping substeps a and b since Ch 1 is already set up for testing from step 1.*
  - a. *Select an unchecked channel:*
    - MSO71254C and DSA/DPO71254/B: Press **Cursors** to remove cursors from the display.
    - From the button bar, touch **Measure** and then **Clear All** to remove the previous measurement.
    - Press the Vertical button of the channel just confirmed to remove the channel from the display.
    - Press the front-panel Vertical button that corresponds to the channel you are to confirm.
    - DPO7354: Touch **Vertical**, select **Vertical Setup**, and then touch Termination **50 Ω**.
    - Move the test setup to the channel you selected.

Table 3-8: Channel bandwidth  $\geq 4$  GHz models

Vertical scale	Reference amplitude (6 div)	Horizontal scale	Test frequency						-3 dB limits
			DSA/DPO72004C, MSO72004C	DSA/DPO71604C, MSO71604C	DSA/DPO71254C, MSO71254C	DSA/DPO70804B, MSO70804	DSA/DPO70604B, MSO70604	DSA/DPO70404B, MSO70404	
10 mV	60 mV	1 ns	18 GHz	16 GHz	12.5 GHz	8 GHz	6 GHz	4 GHz	$\geq 42.4$ mV
20 mV	120 mV	1 ns	20 GHz	16 GHz	12.5 GHz	8 GHz	6 GHz	4 GHz	$\geq 84.8$ mV
50 mV	300 mV	1 ns	20 GHz	16 GHz	12.5 GHz	8 GHz	6 GHz	4 GHz	$\geq 212$ mV
100 mV	600 mV	1 ns	20 GHz	16 GHz	12.5 GHz	8 GHz	6 GHz	4 GHz	$\geq 424$ mV
200 mV	1.5 V	1 ns	20 GHz	16 GHz	12.5 GHz	8 GHz	6 GHz	4 GHz	$\geq 1.061$ V

Table 3-9: Channel bandwidth 3.5 GHz model

Vertical scale	Reference amplitude	Horizontal scale	Test frequency	
			DPO7354	-3 dB limits
5 mV	30 mV	1 ns	2.0 GHz	$\geq 21.2$ mV
10 mV	40 mV	1 ns	3.5 GHz	$\geq 28.3$ mV
20 mV	80 mV	1 ns	3.5 GHz	$\geq 56.6$ mV
50 mV	200 mV	1 ns	3.5 GHz	$\geq 141.4$ mV
100 mV	400 mV	1 ns	3.5 GHz	$\geq 283$ mV
200 mV	800 mV	1 ns	3.5 GHz	$\geq 566$ mV
500 mV	2 V <sup>1</sup>	1 ns	3.5 GHz	$\geq 1.41$ V <sup>1</sup>
1 V	4 V <sup>1</sup>	1 ns	3.5 GHz	$\geq 2.83$ V <sup>1</sup>

<sup>1</sup> If your generator cannot output the required amplitude, determine its maximum output at the Test frequency, and use this for the reference amplitude. The -3 dB limit can be calculated as:  $0.707 \times$  reference amplitude.

- b. Match the trigger source to the channel selected:** Press the Trigger Source button until the source that corresponds to the channel you are to confirm is on.

$\geq 3.5$  GHz models with bandwidth  $>9$  GHz: Set the trigger Source to **Line**.

- c. DPO7354:** Set the input impedance to **50  $\Omega$** .

- d. Set the vertical scale:**

For the channel you are testing, set the vertical **Scale** to the next setting listed in the tables, starting with the 100 mV setting. See the preceding Channel Bandwidth table that applies to your instrument.

- e. *Set the trigger coupling:* From the button bar, touch **Trigger** and select Coupling **DC**.
- f. *Display the test signal:* Do the following subparts to first display the reference signal and then the test signal.
  - MSO71254C and DSA/DPO71254/B: From the button bar, touch **Cursors**. Touch Cursor Type **H Bars**.
  - From the button bar touch **Measure**; then select the **Time** tab.
  - Touch the **Freq** button to measure the frequency of the current channel.
  - Select the **Ampl** tab. Touch the **Amplitude** button.
  - From the Annotation drop-down list, select **None**.
  - Touch the **Statistics** button, then touch the **Mean** button.
  - Touch the **X** (Close) button.
  - Set the generator output so the Chx Amplitude mean readout equals the reference amplitude. See the preceding Channel Bandwidth table that applies to your oscilloscope model. This corresponds to the vertical scale set in substep d.
  - Record the reading on the power meter.
  - Set the trigger as follows:

Press the front-panel **Push-Set 50%** button as necessary to trigger a stable display. At full bandwidth, you may also want to make small, manual adjustments to the trigger level. You can use the **Trigger Level** knob to do this.

---

**NOTE.** *If you are using Line trigger, the test signal is not shown as a stable display.*

---

- g. *Measure the test signal:*
  - MSO71254C and DSA/DPO71254/B: Set the frequency of the generator to the test frequency in the tables that corresponds to the vertical scale set in substep d.
  - All instruments except the MSO71254C and DSA/DPO71254/B: Set the frequency of the generator, as shown on screen, to the test frequency in the tables that corresponds to the vertical scale set in substep d.
  - Set the horizontal **Scale** to the horizontal scale setting in the tables that corresponds to the vertical scale set in substep d. Press **PUSH-SET 50%** as necessary to trigger the signal.

- Adjust the output of the generator until the reading on the power meter is equal to the reading recorded on the power meter in step f.
- MSO71254C and DSA/DPO71254/B: Using the Multipurpose knobs, adjust Cursor 1 to the top of the waveform and Cursor 2 to the bottom of the waveform. Read the absolute value of the result at the  $\Delta V$  readout.
- All instruments except the MSO71254C and DSA/DPO71254/B: Read the results at the Chx Amplitude mean readout, which will automatically measure the amplitude of the test signal. (See Figure 3-16.)

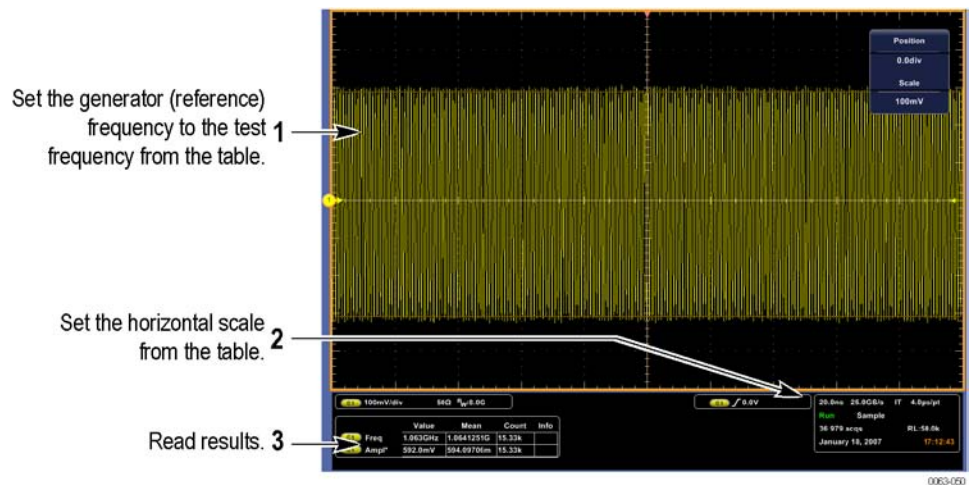

Figure 3-16: Measurement of analog bandwidth

**h. Check against limits:**

- CHECK that the measured amplitude is within the limits for the current vertical scale setting in the table.
- Enter the voltage on the test record.
- When finished checking, set the horizontal **Scale** back to the 20 ns.

- i. *Check remaining vertical scale settings against limits:*
    - Check the remaining vertical scale settings for the channel under test by repeating substeps a through h for each of the remaining scale settings for the channel under test.
    - When doing substep f, skip the subparts that turn on the Chx Amplitude mean measurement until you check a new channel.
    - When selecting a new channel and before doing substep e, touch the **Clear All** button to remove the previous channel measurements.
  - j. *Test all channels:* Repeat substeps a through i for all four channels.
3. *Disconnect the hookup:* Disconnect the test hook up from the input connector of the channel last tested.

**Check Input Resistance,  
≥ 4 GHz models****Equipment Required**

One Digital Multimeter (Item 27)  
 One Dual-Banana Connector, (Item 5)  
 One precision 50  $\Omega$  coaxial cable (Item 4)  
 One SMA male-to-female BNC adapter (Item 19)  
 One SMA female-to-female adapter (Item 16)  
 One SMA male short circuit adapter (Item 25)

**Prerequisites**

(See page 3-18, *Prerequisites*.)

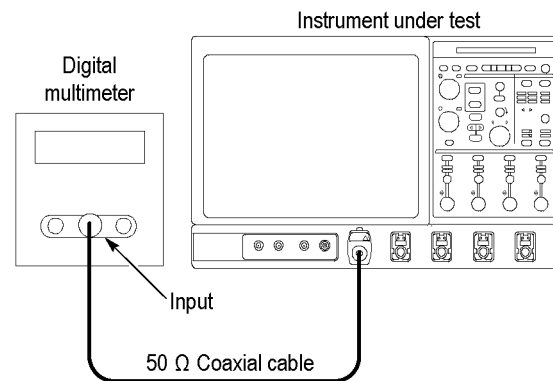

**Figure 3-17: Initial test hookup**

1. *Install the test hookup and preset the instrument controls:*
  - a. *Initialize the instrument:* Press the **Default Setup** button.
  - b. Short the cable from the multimeter by connecting a shorting adapter and SMA-to-SMA adapter to the BNC-to-SMA adapter.
  - c. Read and record the resistance of the multimeter leads.
  - d. *Hook up the test-signal source:* Connect, through a 50  $\Omega$  precision coaxial cable, the input of the multimeter to **Ch 1** through adapters. (See Figure 3-17.)
  - e. Set the Vertical **Scale** to **10 mV** per division

2. *Check input impedance against limits:*
  - a. *Measure the impedance:* Read and record the measured impedance.
  - b. Remove the dual banana connector from the digital multimeter (DMM), turn it 180 degrees and reinsert it in the DMM input.
  - c. *Measure the impedance:* Read and record the measured impedance.
  - d. Add the two measurements and divide the result by 2.
  - e. Subtract the resistance of the multimeter leads from the average that you calculated.
  - f. Enter the result on the test record.
  - g. Check - The measurement is within the limits specified in the test record.
3. Set the Vertical **Scale** to **100 mV** per division and repeat step 2.
4. *Repeat steps 2 through 3 for the remaining input channels:*
  - a. Move the test setup to an unchecked input channel.
  - b. Set the Vertical **Scale** of the channel to **10 mV** per division.
  - c. Repeat steps 2 through 3.
5. *Disconnect the hookup:* Disconnect the equipment from the instrument.



## Time Base System Checks

These procedures check those characteristics that relate to the time base system and are listed as checked under *Warranted Characteristics* in *Specifications*.

### Check Timebase and Delay Time Accuracy and Reference

#### Equipment Required

One timer-counter (Item 8)  
 One 50  $\Omega$ , precision coaxial cable (Item 4)  
 One SMA male-to-female BNC adapter (Item 19)  
 One sine wave generator (Item 9)

#### Prerequisites

(See page 3-18, *Prerequisites*.)

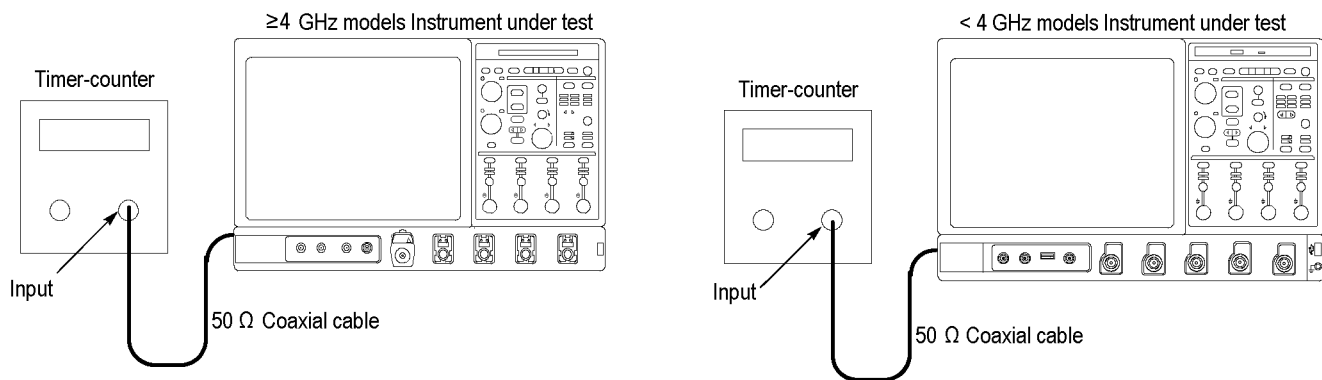

Figure 3-18: Initial test hookup

1. *Install the test hookup and preset the instrument controls:*
  - a. *Hook up the test-signal source:* Connect the input of the timer-counter to **AUX Out** (< 4 GHz models) or reference output ( $\geq$  4 GHz models). (See Figure 3-18.)
    - Set the timer-counter gate to 1 s.
    - Set the timer-counter to count the 10 MHz reference output.
  - b. *Initialize the instrument:* Press the **Default Setup** button.
  - c. < 4 GHz models: Display menu mode. Select Utilities > External Signals and press **Ref Out**.
2. *Confirm the time base is within limits for accuracies:*
  - a. *Check long-term sample rate, delay time accuracies, and reference output frequency:*
    - CHECK that the count on the timer-counter is within limits. (See page 3-37.)
    - Enter the count on the test record.

3. *Disconnect the hookup:* Disconnect the equipment from the instrument.

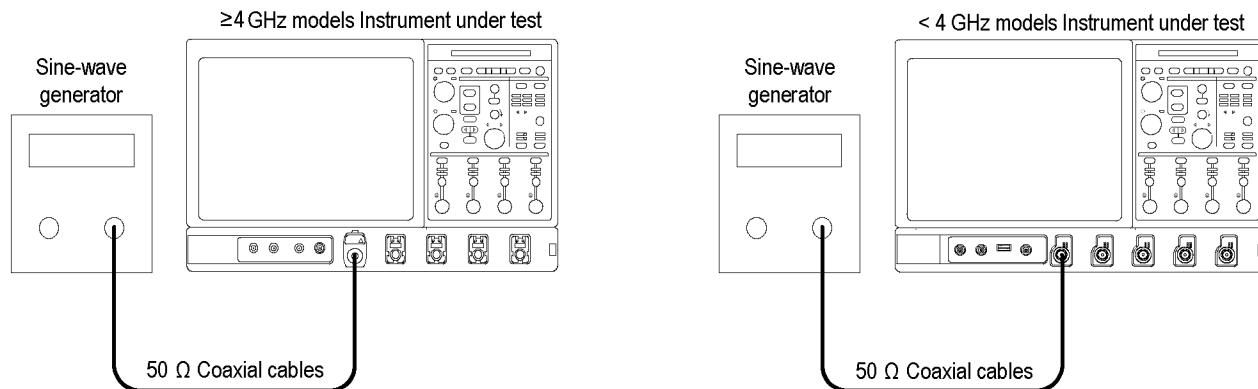

Figure 3-19: Initial test hookup

4. *Install the test hookup and preset the instrument controls:*

- a. *Initialize the instrument:* Press the **Default Setup** button.
- b. *Hook up the test-signal source:* Connect the output of the sine wave generator to **Ch 1** input. (See Figure 3-19.)
  - From the button bar, touch **Measure** and select the **Ampl** tab.
  - Touch the **Pk-Pk** button.
  - Touch the **X** (Close) button.
  - Set the Vertical **Scale** to 50 mV.
  - < 4 GHz models: Touch **Vertical**, select **Vertical Setup**, and then touch Termination **50 Ω**.
  - Set the generator for a 10.0 MHz sine wave.
  - Set the generator to output a 4 division signal. Adjust the output until the Pk-Pk readout displays 200 mV.
- c. *Set the instrument controls:*
  - Move the cable from the **Ch 1** input to the rear-panel **Ext Ref** input (See Figure 3-20.)
  - From menu mode, touch **Utilities** and select **External Signals**.
  - Touch the **External** button to select the external reference.

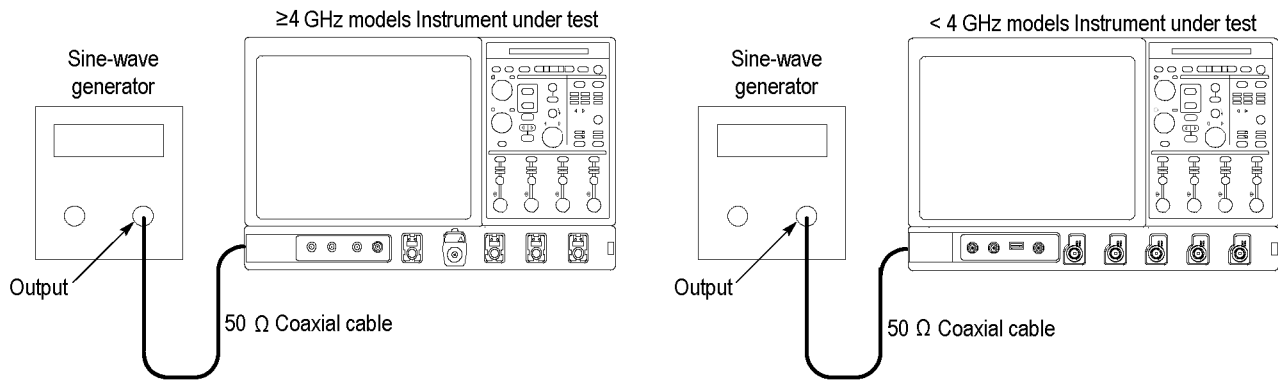

Figure 3-20: Final test hookup

5. *Confirm external reference:*
  - a. *Perform a signal path compensation:*
    - Touch **Utilities** and select **Instrument Calibration**.
    - Touch **Run SPC (Calibrate)** on some instruments) and wait for the signal path compensation to finish.
  - b. *Check the completion status:* Enter the pass/fail status in the test record. If the Status is Fail, refer the instrument to qualified service personnel.
6. *Disconnect the hookup:*
  - a. Disconnect all test equipment from the instrument.
  - b. *Set the instrument controls:*
    - From menu mode, touch **Utilities** and select **External Signals**.
    - Touch the **Internal** button to select the internal reference.
  - c. *Perform a signal path compensation:*
    - Touch **Utilities** and select **Instrument Calibration**.
    - Touch **Run SPC (Calibrate)** on some instruments) and wait for the signal path compensation to finish.

**Check Delta Time Measurement Accuracy, < 4 GHz models**

Equipment Required	Prerequisites
One 50 Ω, precision coaxial cable (Item 4)	(See page 3-18, <i>Prerequisites</i> .)
One 50 Ω, 60 inch precision coaxial cable, male-to-male SMA connectors (Item 28)	
One Pulse Generator (Item 20)	
One BNC elbow connector (Item 24)	
One SMA "T", male to two SMA female connectors (Item 22)	
One SMA female to BNC male connector (Item 23)	
One SMA termination connector, short circuit, (Item 25)	
One SMA male-to-female BNC adapter (Item 17)	

This procedure checks the "sample rate" portion of the Delta Time Measurement Accuracy as listed in *Specifications*. The previous procedure, that checks the reference, (See page 1-1.) verified the "PPM" portion of the delta time specification.

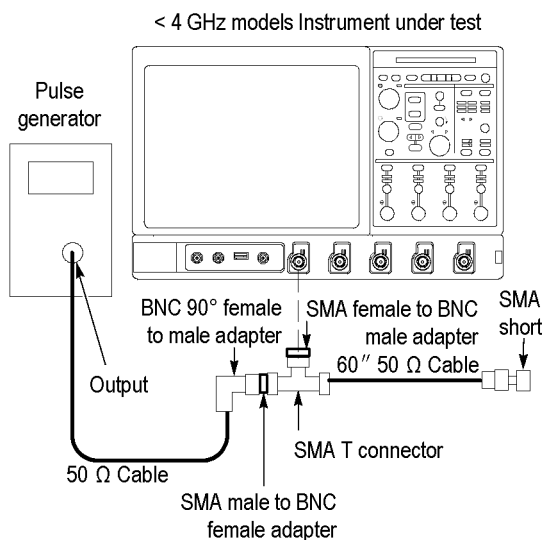

**Figure 3-21: Delta time accuracy test hookup**

1. *Install the test hookup and preset the instrument controls:*
  - a. *Initialize the instrument:* Press the **Default Setup** button.
  - b. *Hook up the pulse generator:*
    - < 4 GHz models: Touch **Vertical**, select **Vertical Setup**, and then touch Termination **50 Ω**.
    - Connect the pulse generator output to a **50 Ω** precision coaxial cable followed by a 90° right-angle female to male SMA adapter. The adapter is connected to one side of the female SMA T connector. The other side of the SMA T is connected to a 60 inch **50 Ω** coaxial cable. Connect the SMA short, to the remaining end of the cable. Now connect the male SMA T connector to **Ch 1** through an SMA female to BNC male adapter.
    - Set the pulse generator output for a positive-going pulse with a rise-time as shown in the table for your instrument, and for the fastest possible repetition rate (at least 1 kHz). (See Table 3-10 on page 3-78.)
    - Set the pulse generator output for about 500 mV. (This amplitude can be adjusted later to get a 5-division pulse on screen.)
  - c. *Modify the initialized front-panel control settings:*
    - Power on the pulse generator.
    - Touch **Utilities**, select **User Preferences**, select the **Units** tab, and then select the **1-2-5** button.
    - Readjust the Trigger **Level** knob so the trigger level is about 50% of the rising edge of the positive pulse.
    - Press **Autoset**. You may see both positive and negative pulses. Adjust the Trigger **Level** knob so the trigger level is about 50% of the rising edge of the positive pulse.
    - From the button bar, touch the **Horiz/Acq** button and select the **Acquisition** tab. Press the **RT** button to turn on Real Time Only.
    - < 4 GHz models: Set the horizontal SCALE as indicated in the following table.

Table 3-10: Delta time measurement settings

Instrument	Pulse generator rise and fall time range	Horizontal scale setting	Sample rate	Delta time accuracy limit
DPO7354	≤ 150 ps	10 ns/div	10 GS/s	≤ 6.0 ps
DPO7254	≤ 150 ps	10 ns/div	10 GS/s	≤ 6.0 ps
DPO7104	≤ 150 ps	10 ns/div	10 GS/s	≤ 6.0 ps
DPO7054	≤ 150 ps	20 ns/div	5 GS/s	≤ 12.0 ps

- Adjust the generator output or instrument vertical scale and position as necessary to obtain at least **5 divisions** of the **positive** pulse.
- d.** *Set up for statistics measurements:*
- Press **Run/Stop** button to freeze the display.
  - From the button bar, touch **Measure** and select the **Time** tab to show the Time Measurements menu.
  - Touch the **Pos Width** button.
  - Touch Setups **Statistics** and then touch **All**. Touch **Reset** to reset the statistics.
  - Touch **Weight n=**. On the keypad press **1000**, then **Enter**. Touch **Setup**.
  - Touch Setups **Ref Levs** and then touch **Absolute**.
  - Touch **MidRef**. Using the keypad or multipurpose knobs, set the mid reference level. Set the reference level near the center of the pulse,

above any noise, and below any overshoot or ringing on the pulse.  
Touch the **X** (Close) button.

- Press the **Run/Stop** button to start the acquisitions.
  - Wait about 30 seconds.
  - Press **Run/Stop** button to freeze the display.
  - Read the Std Dev statistic measurement.
  - The standard deviation (St Dev) measurement must be less than or equal to the Delta-time accuracy limit for your instrument. (See Table 3-10.)
  - Enter the result for delta time on the test record.
- e. *Repeat for all other channels:*
- Note the vertical scale setting of the channel just confirmed.
  - Press the Vertical channel button for the channel just confirmed to remove the channel from display.
  - Touch **Measure** and then **Clear All** to remove the measurement.
  - Press the front-panel button that corresponds to the channel you are to confirm.
  - Set vertical scale to the setting noted in step e, first bullet.
  - Press the Trigger **Source** button to toggle the source to the channel selected.
  - < 4 GHz models: Touch **Vertical**, select **Vertical Setup**, and then touch Termination **50 Ω**.
  - Move the test hookup to the channel you selected.
  - Press **Run/Stop** button to start the display.
  - Repeat step d.
  - Touch **Utilities**, select **User Preferences**, select the **Units** tab, and then select the **1-2-3** button.

2. *Disconnect all test equipment from the instrument.*

**Check Delta Time Measurement Accuracy,  $\geq 4$  GHz models**

**Equipment Required**

One 50  $\Omega$ , precision coaxial cable (Item 4)  
 One sine-wave generator (Item 9)  
 One adapter (Item 19)

**Prerequisites**

(See page 3-18, *Prerequisites*.)

This procedure checks the Delta Time Measurement Accuracy as listed in *Specifications*.

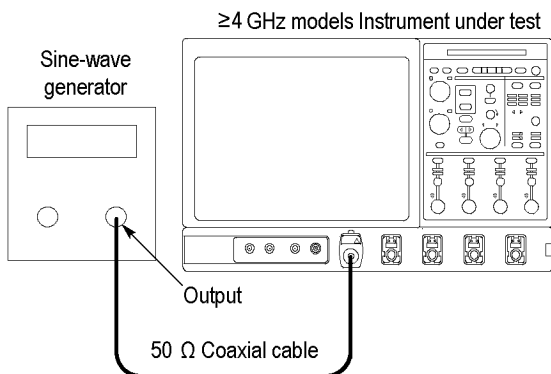

**Figure 3-22: Delta time accuracy test hookup**

1. *Install the test hookup and preset the instrument controls:*
  - a. *Initialize the instrument:* Press the **Default Setup** button.
  - b. *Hook up the sine-wave generator:*
    - Connect the sine-wave output of the sine-wave generator through a **50  $\Omega$**  precision coaxial cable to **Ch 1** through an adapter.
    - Power on the generator.
    - Set the sine-wave generator to output a sine wave of the frequency shown in the table. (See Table 3-11 on page 3-81.)
    - Set the generator output for 80 mV. (This amplitude can be adjusted later to get a 8-division pulse on screen.)
    - Set the Vertical Scale to 10 mV per division.



c. *Modify the initialized front-panel control settings:*

- Readjust the Trigger **Level** knob so the trigger level is at 50% of the rising edge of the sine wave.
- From the button bar, touch the **Horiz/Acq** button. Select the **Manual** button to turn on Manual Mode.
- Select the **Acquisition** tab. Press the **IT** button to turn on Interpolate Time Only.
- From the button bar, touch the **Vertical** button.
- Select **Analog Only**.
- Set the vertical scale, record length, and sample rate as indicated in the following table.

Table 3-11: Delta time measurement settings

Instrument	Volts/div	Sine wave generator frequency	Record length	Sample rate	Burst width	Delta time rms accuracy limit	Delta time pk-pk accuracy limit
<b>BWE off</b>							
MSO72004C and DPO72004C, BWE off	10 mV	9.94 GHz	10000	500 GS/s	10 ns	1.280 ps	12.80 ps
	50 mV	9.94 GHz	10000	500 GS/s	10 ns	1.172 ps	11.72 ps
	100 mV	9.94 GHz	10000	500 GS/s	10 ns	1.186 ps	11.86 ps
MSO71604C and DPO71604C, BWE off	10 mV	9.94 GHz	10000	500 GS/s	10 ns	1.280 ps	12.80 ps
	50 mV	9.94 GHz	10000	500 GS/s	10 ns	1.172 ps	11.72 ps
	100 mV	9.94 GHz	10000	500 GS/s	10 ns	1.186 ps	11.86 ps
MSO71254C and DPO71254C, BWE off	10 mV	7.76 GHz	10000	500 GS/s	10 ns	1.304 ps	13.04 ps
	50 mV	7.76 GHz	10000	500 GS/s	10 ns	1.201 ps	12.01 ps
	100 mV	7.76 GHz	10000	500 GS/s	10 ns	1.205 ps	12.05 ps
MSO70804 and DPO70804B, BWE off	10 mV	4.97 GHz	10000	500 GS/s	10 ns	1.462 ps	14.62 ps
	50 mV	4.97 GHz	10000	500 GS/s	10 ns	1.295 ps	12.95 ps
	100 mV	4.97 GHz	10000	500 GS/s	10 ns	1.336 ps	13.36 ps
MSO70604 and DPO70604B, BWE off	10 mV	3.73 GHz	10000	500 GS/s	10 ns	1.625 ps	16.25 ps
	50 mV	3.73 GHz	10000	500 GS/s	10 ns	1.427 ps	14.27 ps
	100 mV	3.73 GHz	10000	500 GS/s	10 ns	1.463 ps	14.63 ps
MSO70404 and DPO70404B, BWE off	10 mV	2.48 GHz	10000	500 GS/s	10 ns	2.022 ps	20.22 ps
	50 mV	2.48 GHz	10000	500 GS/s	10 ns	1.762 ps	17.62 ps
	100 mV	2.48 GHz	10000	500 GS/s	10 ns	1.821 ps	18.21 ps

Table 3-11: Delta time measurement settings (cont.)

Instrument	Volts/div	Sine wave generator frequency	Record length	Sample rate	Burst width	Delta time rms accuracy limit	Delta time pk-pk accuracy limit
<b>BWE on</b>							
MSO72004C and DPO72004C, 20 GHz	50 mV	11.2 GHz	10000	500 GS/s	10 ns	1.260 ps	12.60 ps
	100 mV	11.2 GHz	10000	500 GS/s	10 ns	1.432 ps	14.32 ps
MSO72004C and DPO72004C, 18 GHz	10 mV	11.2 GHz	10000	500 GS/s	10 ns	1.336 ps	13.36 ps
	50 mV	11.2 GHz	10000	500 GS/s	10 ns	1.182 ps	11.82 ps
	100 mV	11.2 GHz	10000	500 GS/s	10 ns	1.234 ps	12.34 ps
MSO71604C and DPO71604C, 16 GHz	10 mV	9.94 GHz	10000	500 GS/s	10 ns	1.219 ps	12.19 ps
	50 mV	9.94 GHz	10000	500 GS/s	10 ns	1.154 ps	11.54 ps
	100 mV	9.94 GHz	10000	500 GS/s	10 ns	1.159 ps	11.59 ps
MSO71254C and DPO71254C, 12.5 GHz	10 mV	7.45 GHz	10000	500 GS/s	10 ns	1.333 ps	13.33 ps
	50 mV	7.45 GHz	10000	500 GS/s	10 ns	1.212 ps	12.12 ps
	100 mV	7.45 GHz	10000	500 GS/s	10 ns	1.228 ps	12.28 ps
MSO70804 and DPO70804B, 8 GHz	10 mV	4.97 GHz	10000	500 GS/s	10 ns	1.354 ps	13.54 ps
	50 mV	4.97 GHz	10000	500 GS/s	10 ns	1.235 ps	12.35 ps
	100 mV	4.97 GHz	10000	500 GS/s	10 ns	1.241 ps	12.41 ps
MSO70604 and DPO70604B, 6 GHz	10 mV	3.73 GHz	10000	500 GS/s	10 ns	1.445 ps	14.45 ps
	50 mV	3.73 GHz	10000	500 GS/s	10 ns	1.295 ps	12.95 ps
	100 mV	3.73 GHz	10000	500 GS/s	10 ns	1.329 ps	13.29 ps
MSO70404 and DPO70404B, 4 GHz	10 mV	2.48 GHz	10000	500 GS/s	10 ns	1.674 ps	16.74 ps
	50 mV	2.48 GHz	10000	500 GS/s	10 ns	1.437 ps	14.37 ps
	100 mV	2.48 GHz	10000	500 GS/s	10 ns	1.478 ps	14.78 ps

- Adjust the generator output as necessary to obtain **8 divisions** of displayed waveform.

**d.** *Set up for statistics measurements:*

- From the button bar, touch **Measure** and select the **More** tab to show the More Measurements menu.
- Touch the **Burst Width** button.
- Touch Setups **Gating** and then touch **Cursor**.
- Touch **Setup**.
- Touch Setups **Statistics** and then touch **All**. Set the Weight n= to **1000**. Touch **Reset** to reset the statistics.
- Touch **Setup**.
- Touch Setups **Ref Levs** and then touch **Absolute**.

- Touch **MidRef**. Using the keypad or multipurpose knobs, set the mid reference level to **0 V**. Touch the **X** (Close) button.
- Click one of the cursors to assign the multipurpose knobs to the cursors.
- Using the multipurpose knobs, set the Cursor 1 x position to  $-5.0$  ns, and set the Cursor 2 x position to  $+5$  ns.
- Press the **Multiview Zoom** front panel button.
- Using the multipurpose knobs, set the Zoom position to 25%, and set the Zoom factor to 20.
- Press the **Cursors** front-panel button twice to assign the multipurpose knobs to the Cursors.
- Set the Cursor 1 x position to align the cursor with the nearest trough of the waveform.



- Press the **Zoom** button twice. Set the Zoom position to 75%.
- Press the **Cursors** button twice. Set the Cursor 2 x position to align the cursor with the nearest trough of the waveform.

**e.** *Read the measurement:*

- Press the **Clear** button. Allow approximately 1000 acquisitions to accumulate, then press **Run/Stop**.
- Read the Std Dev statistic measurement.
- Enter the time on the test record.
- The standard deviation (St Dev) measurement must be less than or equal to the rms Delta-time accuracy limit for your instrument and bandwidth setting. (See Table 3-11.)
- Read the Max and Min statistic measurements.
- Subtract the Max and Min statistic measurements.
- Enter the time on the test record.
- The absolute value of the difference of the Max and Min measurements must be less than or equal to the pk-pk Delta-time accuracy limit for your instrument and bandwidth setting. (See Table 3-11.)
- Press the **Run/Stop** button.

**f.** *Repeat for all other Volts/div settings in the table:*

- Set the vertical scale, record length, and sample rate as indicated in the table.
- Repeat step e.

**g.** *Repeat for all other appropriate bandwidths:*

- Set the sine-wave generator to output the next appropriate frequency for your instrument from the table.
- For tests with BWE on, from the button bar, touch the **Vertical** button, and then Select **Digital Filters (DSP) Enabled**.
- Set the vertical scale, record length, and sample rate as indicated in the table.
- Using the Horizontal SCALE and the Multipurpose knobs, adjust the Horizontal SCALE and cursors so that the burst width measurement is as in the table.
- Repeat steps e and f.

**2.** *Disconnect all test equipment from the instrument.*

## Trigger System Checks

These procedures check those characteristics that relate to the trigger system and are listed as checked in *Specifications*.

### Check Time Qualified Trigger Accuracy

#### Equipment Required

One sine wave generator (Item 9)  
 One 2X attenuator (Item 26)  
 One 50  $\Omega$ , precision coaxial cable (Item 4)  
 One SMA male-to-female BNC adapter (Item 19)

#### Prerequisites

(See page 3-18, *Prerequisites*.)

1. *Install the test hookup and preset the instrument controls:*
  - a. *Initialize the instrument:* Press the **Default Setup** button.
  - b. *Modify the default setup:*
    - < 4 GHz models: Set the horizontal **Scale** to 2.5 ns.
    - $\geq$  4 GHz models: Set the horizontal **Scale** to 2 ns.
    - < 4 GHz models: From the button bar, click the **Vertical** button; then click the Termination **50  $\Omega$**  button.
  - c. *Hook up the test-signal source:* Connect the output of the sine wave generator to Ch 1 as shown in the following figure.

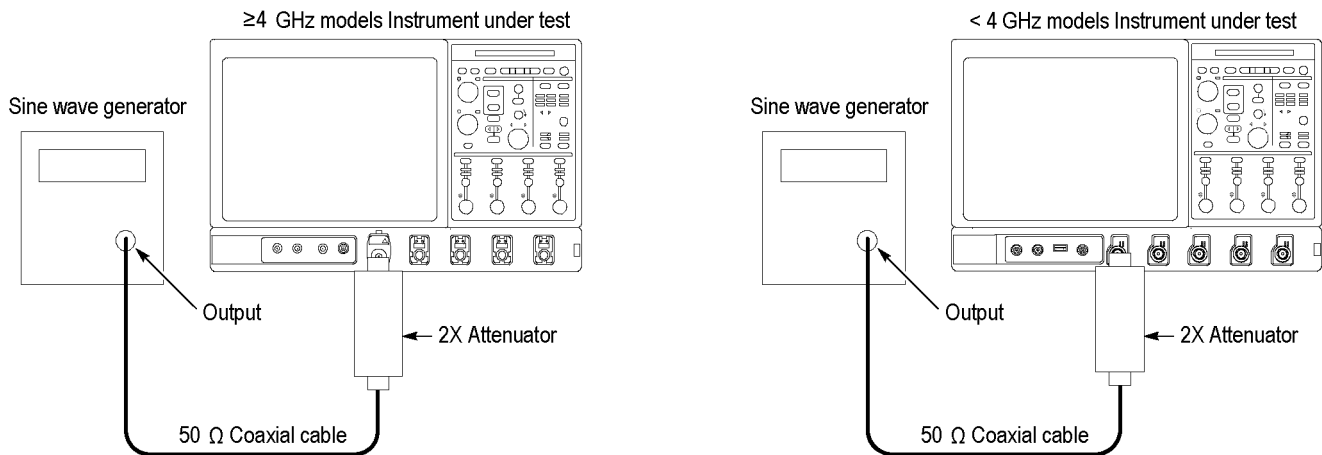
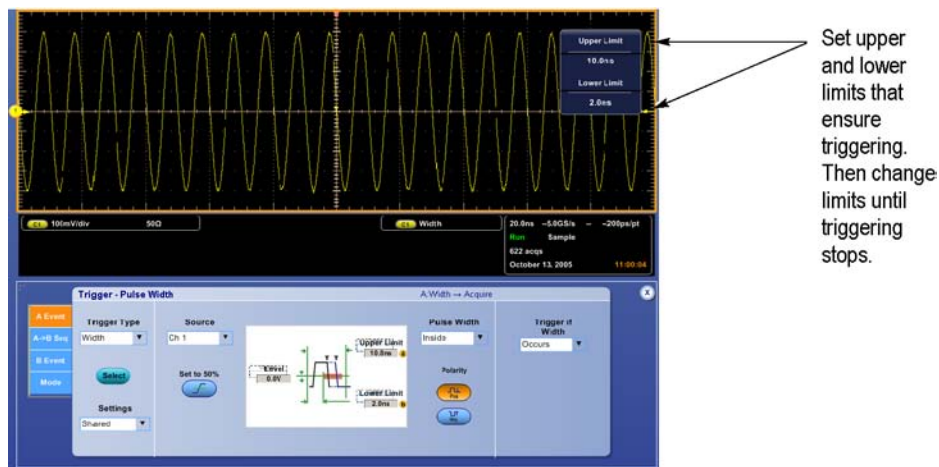

Figure 3-23: Initial test hookup

- d. *Set the trigger mode:* Press the Trigger **Mode** button to toggle it to **Normal**.



**Figure 3-24: Measurement of time accuracy for pulse and glitch triggering**

2. *Confirm the trigger system is within time-accuracy limits for time qualified trigger accuracy (time range <math>< 1 \mu\text{s}</math>):*
  - a. *Set upper and lower limits that ensure triggering at 100 MHz: (See Figure 3-24.)*
    - Press the front-panel **Advanced** button and select the **A Event** tab; then pull down on Trigger Type and select **Width** triggering.
    - Pull down Pulse Width and select **Inside** limits.
    - Touch **Upper Limit**. Use the keypad to set the upper limit to 10 ns.
    - Touch **Lower Limit**. Use the keypad to set the lower limit to 2 ns.
  - b. *Display the test signal:*
    - Set the Horizontal **Scale** to 20 ns.
    - Set the output of the sine wave generator for a 100 MHz, five-division sine wave on screen. Set the Vertical **Scale** to 20 mV (the waveform will overdrive the display).
    - Press **PUSH-SET 50%**.
  - c. *Check against limits: Do the following subparts in the order listed.*
    - While doing the following subparts, monitor the display (it will stop acquiring) and the front-panel light **Trig'd** (it will extinguish) to determine when triggering is lost.
    - $\geq 4$  GHz models: Press the multipurpose knobs until Fine is on.
    - Use the multipurpose knob to *increase* the **Lower Limit** readout until triggering is lost.

- CHECK that the **Lower Limit** readout, after the instrument stops triggering, is within the following limits:

Model	Limit
< 4 GHz models	3.5 ns to 6.5 ns
≥ 4 GHz models	4.77 ns to 5.23 ns

- Enter the time on the test record.
- Use the keypad to return the **Lower Limit** to 2 ns and reestablish triggering.
- Touch **Upper Limit**; then use the multipurpose knob to slowly *decrease* the **Upper Limit** readout until triggering stops.
- CHECK that the **Upper Limit** readout, after the instrument loses triggering, is within the following limits:

Model	Limit
< 4 GHz models	3.5 ns to 6.5 ns, inclusive
≥ 4 GHz models	4.77 ns to 5.23 ns, inclusive

- Enter the time on the test record.

3. *Confirm the trigger system is within time-accuracy limits for pulse-glitch or pulse-width triggering (time range ≥ 1 μs):*

a. *Set upper and lower limits that ensure triggering at 250 kHz:*

- Touch **Upper Limit**. Use the keypad to set the upper limit to 4 μs.
- Touch **Lower Limit**. Use the keypad to set the lower limit to 500 ns.

**b. Display the test signal:**

- < 4 GHz models: Set the Horizontal **Scale** to 5  $\mu$ s.
- $\geq$  4 GHz models: Set the Horizontal **Scale** to 4  $\mu$ s.
- Set the Vertical **Scale** to 100 mV.
- Set the output of the sine wave generator for a 250 kHz, five-division sine wave on screen. Set the Vertical **Scale** to 20 mV (the waveform will overdrive the display).
- Press **PUSH-SET 50%**.

**c. Check against limits:** Do the following subparts in the order listed.

- $\geq$  4 GHz models: Press the multipurpose knobs until Fine is on.
- Use the multipurpose knob to *increase* the **Lower Limit** readout until triggering is lost.
- CHECK that the **Lower Limit** readout, after the instrument stops triggering, is within the following limits:

Model	Limit
< 4 GHz models	1.9 $\mu$ s to 2.1 $\mu$ s, inclusive
$\geq$ 4 GHz models	1.9 $\mu$ s to 2.1 $\mu$ s, inclusive

- Enter the time on the test record.
- Use the keypad to return the **Lower Limit** to 500 ns and reestablish triggering.
- Touch **Upper Limit**; then use the multipurpose knob to slowly *decrease* the **Upper Limit** readout until triggering stops.
- CHECK that the **Upper Limit** readout, after the instrument loses triggering, is within the following limits:

Model	Limit
< 4 GHz models	1.9 $\mu$ s to 2.1 $\mu$ s, inclusive
$\geq$ 4 GHz models	1.9 $\mu$ s to 2.1 $\mu$ s, inclusive

- Enter the time on the test record.

**4. Disconnect the hookup:** Disconnect the equipment from the instrument.



**Check Sensitivity, Edge Trigger, DC Coupled****Equipment required**

One leveled sine wave generator (Item 9)  
 Three precision 50  $\Omega$  coaxial cables (Item 21)  
 Two SMA female to BNC male adapters (item 23)  
 Three SMA female-to-female adapters (item 16)  
 One 10X attenuator (Item 1)  
 One power splitter (Item 11)  
 Male N-to-BNC adapter (Item 14)  
 One SMA adapter (Item 19)  
 One 5X attenuator (Item 2)  
 One 2X attenuator (Item 26)  
 < 4 GHz models, one 50  $\Omega$  termination (item 3)

**Prerequisites**

(See page 3-18, *Prerequisites*.)

**NOTE.** *The sine wave generator output amplitude must be leveled to within 0.35 dB of the reference frequency (10 MHz) through the trigger frequency being tested.*

*Refer to the Sine Wave Generator Leveling Procedure if your sine wave generator does not have automatic output amplitude leveling. (See page 3-114.)*

1. *Install the test hookup and preset the instrument controls:*
  - a. *Initialize the instrument:* Press the **Default Setup** button.
  - b. *Modify the initialized front-panel control settings:*
    - Set the Horizontal **Scale** to 20 ns.
    - < 4 GHz models: Touch **Vertical**, select **Vertical Setup**, and then touch Termination **50  $\Omega$** .
    - Press the Trigger **Mode** button to toggle it to **Normal**.
    - From the button bar, touch **Horiz/Acq** and select the **Acquisition** tab.
    - Touch **Average** and set the number of averages to **16**.
    - Touch the **Equivalent ET** button.

c. *Hook up the test-signal source:*

- Connect the signal output of the generator to a power splitter. Connect one output of the power splitter to **Ch 1** as shown in the following figure. Connect the other output of the power splitter to the **Aux Input** as in the following figure.

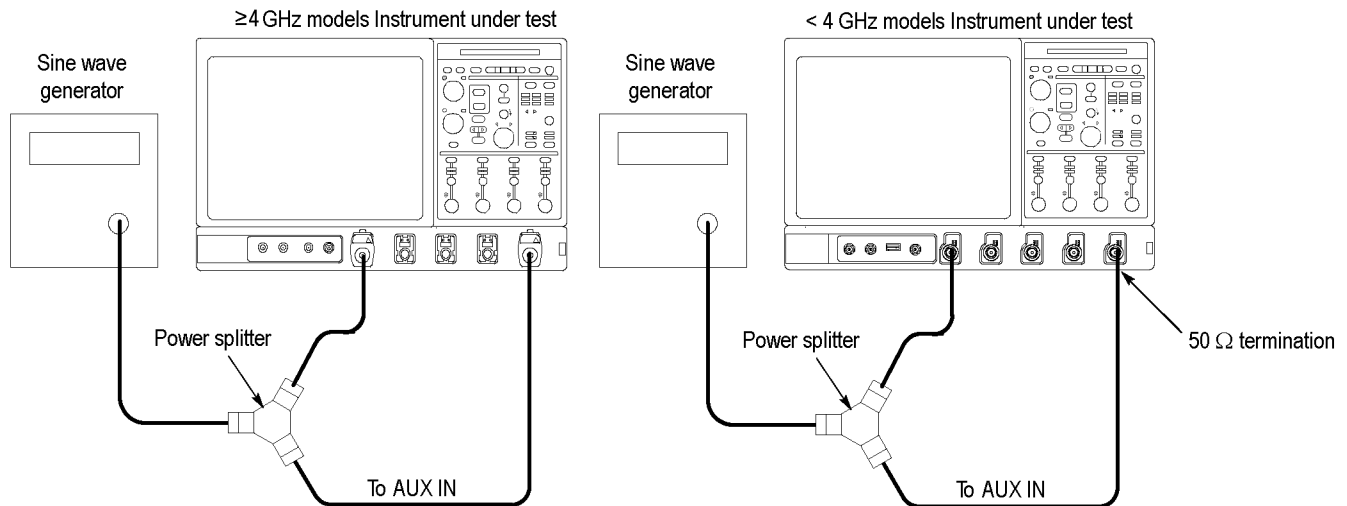

Figure 3-25: Initial test hookup

2. *Confirm the trigger system is within sensitivity limits (50 MHz):*

a. *Display the test signal:*

- Set the generator frequency to 50 MHz.
- From the button bar, touch **Measure**.
- Touch Setup **Ref Levs**; then touch the **Min-Max** button.
- Touch the **Setup** button and select the **Ampl** tab; then touch the **Amplitude** button.
- Touch the X (close) button.
- Press **Push-Set 50%**.

- Set the generator amplitude on screen as follows:

Model	Divisions
≥ 4 GHz models	4 divisions
< 4 GHz models	7 divisions

- Now fine adjust the generator output until the **Ch 1 Amplitude** readout indicates the amplitude is as follows (Readout may fluctuate):

Model	Amplitude
≥ 4 GHz models	400 mV
< 4 GHz models	700 mV

- Disconnect the 50 Ω precision coaxial cable at **Ch 1** and reconnect it to **Ch 1** through a 10X attenuator.

**b.** *Check the A trigger system for stable triggering at limits:*

- Read the following definition: A stable trigger is one that is consistent; that is, one that results in a uniform, regular display triggered on the selected slope (positive or negative). This display should *not* have its trigger point switching between opposite slopes, nor should it roll across the screen. At horizontal scale settings of 2 ms/division and faster, **Trig'd** will remain constantly lighted. It will flash for slower settings.
- Press the Trigger **Slope** button to select the positive slope.
- Adjust the Trigger **Level** knob so that there is a stable trigger. CHECK that the trigger is stable for the test waveform on the positive slope.
- Press the Trigger **Slope** button to select the negative slope. Adjust the Trigger **Level** knob so that there is a stable trigger.
- CHECK that the trigger is stable for the test waveform on the negative slope.
- Enter pass or fail in the test record.
- Leave the trigger system triggered on the positive slope of the waveform before continuing to the next step.

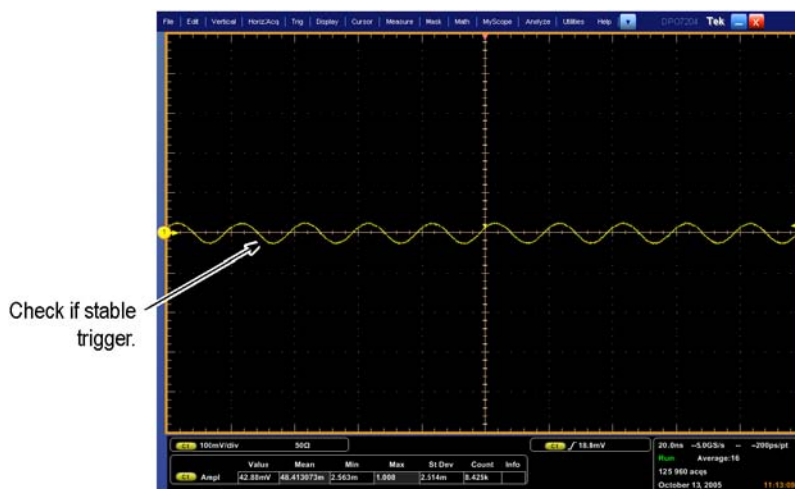

**Figure 3-26: Measurement of trigger sensitivity - 50 MHz results shown**

- c.  $\geq 4$  GHz models: *Check B trigger system for stable triggering at limits:* Do the following subparts in the order listed.
- From the button bar touch **Trig**, select the **A Event** tab, and set the **Source** to Line.
  - Select the **A->B Seq** tab, and touch the A then B **Trig After Time** button.
  - Select the **B Event** tab, and touch the **Set To 50%** button.
  - CHECK that a stable trigger is obtained for the test waveform for both the positive and negative slopes of the waveform. Use the **Trigger Level** knob to stabilize the A trigger. Touch **Level** and use the keypad or the multipurpose knob/Fine button to stabilize the B trigger. Touch one of the Slope buttons to switch between trigger slopes. (See Figure 3-26 on page 3-92.)
  - Enter pass or fail in the test record.
  - Leave the Delayed trigger system triggered on the positive slope of the waveform before continuing to the next step. Also, return to the A trigger: select the **A->B Seq** tab and touch the A->B Sequence **A Only** button. Then select the **A Event** tab.
  - Select the **A Event** tab, and set the **Source** to CH1.
  - Press the X (Close button).

3. *Confirm the AUX Trigger input (at 50 MHz):*
  - a. *Display the test signal:*
    - Remove the 10X attenuator and reconnect the cable to **Ch 1**.
    - Set the signal amplitude as follows: **2.5 divisions**
    - Now fine adjust the generator output until the **Ch 1 Amplitude** readout indicates the amplitude is as follows (Readout may fluctuate): **250 mV**
  - b. *Check the AUX trigger source for stable triggering at limits: Do the following in the order listed.*
    - Use the definition for stable trigger from step 2 substep b.
    - Press the Trigger **Source** button to toggle it to **Aux** (Ext).
    - Press **Push-Set 50%**.
    - CHECK that a stable trigger is obtained for the test waveform on both the positive and negative slopes. Press the Trigger **Slope** button to switch between trigger slopes. Use the Trigger **Level** knob to stabilize the trigger if required.
    - Enter pass or fail in the test record.
    - Leave the trigger system triggered on the positive slope of the waveform before proceeding to the next check.
    - Press the Trigger **Source** button to toggle it to **Ch 1**.

4. Confirm that the A trigger system is within sensitivity limits (full bandwidth):

a. Set the Horizontal Scale: Set the Horizontal **Scale** to 200 ps.

b. Display the test signal:

- Set the generator frequency to full bandwidth as follows:

Model	Generator frequency
≥ 4 GHz models	4 GHz
DPO7354	3.5 GHz
DPO7254	2.5 GHz
DPO7104	1 GHz
DPO7054	500 MHz

- Set the generator amplitude on screen as follows:

Model	Amplitude
≥ 4 GHz models	2 divisions
DPO7354	2.5 divisions
DPO7254	6 divisions
DPO7104	6 divisions
DPO7054	6 divisions

- Now fine adjust the generator output until the **Ch 1 Amplitude** readout indicates the amplitude is as follows (Readout may fluctuate):

Model	Amplitude
≥ 4 GHz models	200 mV
DPO7354	250 mV
DPO7254	600 mV
DPO7104	600 mV
DPO7054	600 mV

- Disconnect the cable at **Ch 1** and reconnect it to **Ch 1** through an attenuator:

Model	Attenuator
≥ 4 GHz models	2X
DPO7354	None
DPO7254	5X
DPO7104	5X
DPO7054	5X

- Check that a stable trigger is obtained.
- c. Repeat step 2, substep b and c for the full bandwidth selected.

**Table 3-12: Trigger settings for ≥ 4 GHz models**

Generator amplitude	Generator frequency		
	A trigger	B trigger	Horizontal scale
	10 MHz	10 MHz	200 ns
150 mV	6 GHz	6 GHz	200 ps
200 mV	8 GHz	NA	200 ps
500 mV	11 GHz	9 GHz	200 ps

- d. ≥ 4 GHz models: *Display the test signal:*
- Remove the attenuator.
  - Set the generator frequency to 10 MHz. Set the Horizontal SCALE as indicated in the table. (See Table 3-12.)
  - Fine adjust the generator output until the **Ch 1 Amplitude** readout indicates the amplitude listed in the table for a frequency not yet checked. (See Table 3-12.)
  - Set the generator frequency to the frequency in the table that corresponds to the amplitude just set. Set the Horizontal SCALE as indicated in the table. (See Table 3-12.)
  - Check that a stable trigger is obtained.
  - Read the following definition: A stable trigger is one where the **Trig'd** LED will remain constantly lighted.
  - Press the Trigger **Slope** button to select the positive slope.
  - Adjust the Trigger **Level** knob so that there is a stable trigger. CHECK that the trigger is stable.
  - Press the Trigger **Slope** button to select the negative slope. Adjust the Trigger **Level** knob so that there is a stable trigger.
  - CHECK that the trigger is stable.
  - Enter pass or fail in the test record.

- Leave the trigger system triggered on the positive slope of the waveform before continuing to the next step.
  - From the button bar touch **Trig**, select the **A Event** tab, and set the **Source** to Line.
  - If you are using a generator amplitude of 200 mV, skip to step e.
  - If the generator frequency is different for the B trigger, set the generator frequency to the frequency in the table that corresponds to the amplitude in the table. (See Table 3-12.)
  - From the button bar touch **Trig**, select the **A->B Seq** tab, and touch the A then B **Trig After Time** button.
  - Select the **B Event** tab, and touch the **Set To 50%** button.
  - CHECK that a stable trigger is obtained for the test waveform for both the positive and negative slopes of the waveform. Use the **Trigger Level** knob to stabilize the A trigger. Touch **Level** and use the keypad or the multipurpose knob/Fine button to stabilize the B trigger. Touch one of the Slope buttons to switch between trigger slopes. (See Figure 3-26 on page 3-92.)
  - Enter pass or fail in the test record.
  - Leave the B trigger system triggered on the positive slope of the waveform before continuing to the next step. Also, return to the A trigger: select the **A->B Seq** tab and touch the A->B Sequence **A Only** button. Then select the **A Event** tab.
  - From the button bar touch **Trig**, select the **A Event** tab, and set the **Source** to CH1.
  - Press the X (Close button).
- e.  $\geq 4$  GHz models: Repeat step 4, substep d until each frequency in the table is checked. (See Table 3-12 on page 3-95.)



**f.** *Display the test signal (Aux trigger at bandwidth):*

- Set the Horizontal Scale to 1 ns.
- < 4 GHz models: Remove the attenuator and reconnect the cable to **Ch 1**.
- $\geq$  4 GHz models: Reconnect the cable to **Ch 1**.
- Set the generator frequency to full bandwidth as follows:

Model	Generator frequency
$\geq$ 4 GHz models	1 GHz
< 4 GHz models	250 MHz

- Set the generator amplitude on screen as follows:

Model	Amplitude
$\geq$ 4 GHz models	7 divisions
< 4 GHz models	7 divisions

- Now fine adjust the generator output until the **Ch 1 Amplitude** readout indicates the amplitude is as follows (Readout may fluctuate):

Model	Amplitude
$\geq$ 4 GHz models	700 mV
< 4 GHz models	700 mV

- Disconnect the cable at **Aux In** and reconnect it to **Aux In** through an attenuator:

Model	Attenuator
$\geq$ 4 GHz models	2X
< 4 GHz models	2X

**g.** Repeat step 3, substep f only, for the full bandwidth selected.

**NOTE.** *You just checked the trigger sensitivity. If desired, you may repeat steps 1 through step 4 substep c for the other channels (Ch 2, Ch 3, and Ch 4).*

**5.** *Disconnect the hookup:* Disconnect the equipment from Aux In and the channel last tested.

## Output Signal Checks

The procedure that follows checks those characteristics of the output signals that are listed as checked under *Warranted Characteristics* in *Specifications*.

### Check Aux Trigger Out

#### Equipment required

One precision 50  $\Omega$  coaxial cable (Item 4)

#### Prerequisites

(See page 3-18, *Prerequisites*.) Also, the instrument must have passed *Check DC Voltage Measurement Accuracy*. (See page 3-42, *Check DC Voltage Measurement Accuracy*.)

1. *Install the test hookup and preset the instrument controls:*

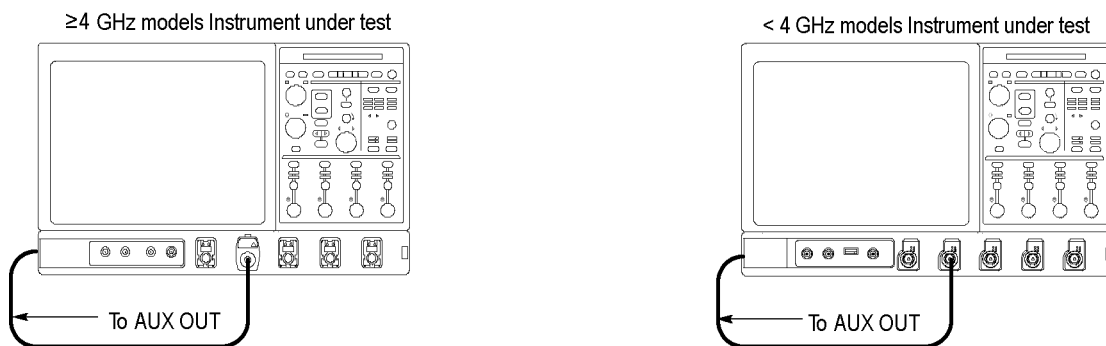

Figure 3-27: Initial test hookup

- Hook up test-signal source:* Connect **Aux Out** to **Ch 2** through a 50  $\Omega$  precision cable and an adapter. (See Figure 3-27.)
- Initialize the instrument:* Press the **Default Setup** button.
- Modify the initialized front-panel control settings:*
  - Press the Vertical **Ch 1** button to toggle it off.
  - Set the Horizontal **Scale** to 200  $\mu$ s.
  - From the button bar, touch **Horiz/Acq** and select the **Acquisition** tab.
  - Touch **Average** and set the number of averages to **64**.
  - Touch the **X** (close) button.

2. *Confirm Aux Out is within limits for logic levels:*
  - a. *Display the test signal:*
    - Press the Vertical **Ch 2** button to display that channel.
    - < 4 GHz models: Touch **Vertical**, select **Vertical Setup**, and then touch Termination **50 Ω**.
    - Set the Vertical **Scale** to 500 mV.
    - Use the Vertical **Position** knob to center the display on screen.
  - b. *Measure logic levels:*
    - From the button bar, touch **Measure** and select the **Ampl** tab.
    - Touch the **High** and **Low** buttons.
    - Touch the **X** (close) button.
  - c. *Check Aux Out output against limits:* CHECK that the **Ch 2 High** readout is  $\geq 1.0$  volt and that the **Ch 2 Low** readout  $\leq 0.25$  volts. (See Figure 3-28.)
3. *Disconnect the hookup:* Disconnect the test setup from the inputs and outputs.



Figure 3-28: Measurement of trigger out limits

### Check Probe Compensation or Fast Edge Output

#### Equipment required

- One BNC to Minigrabber adapter (Item 18)
- One precision 50  $\Omega$  coaxial cable (Item 21)
- One DC calibration generator (Item 6)
- One adapter (Item 19)

#### Prerequisites

(See page 3-18, *Prerequisites*.) Also, the instrument must have passed *Check Timebase and Delay Time Accuracy and Reference*. (See page 3-73.)

**1. Install the test hookup and preset the instrument controls:**

**a. Hook up test-signal:** Refer to the following figure.

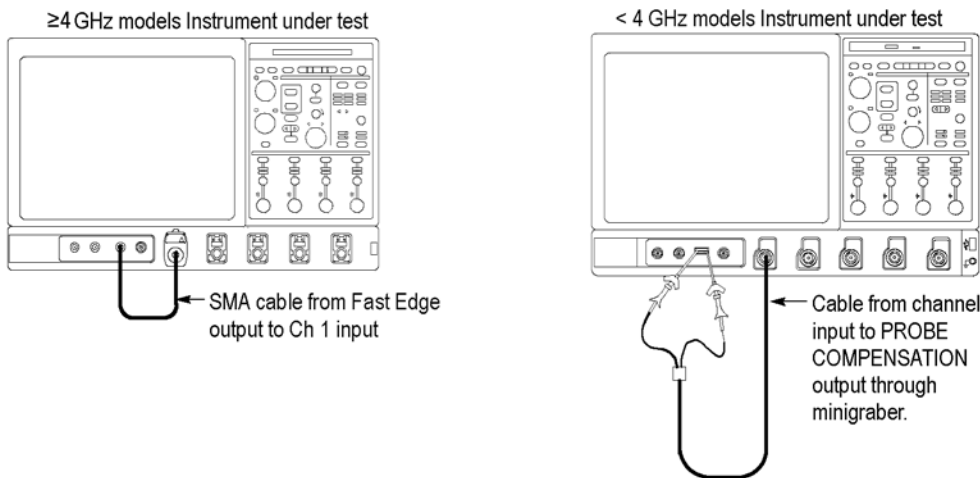

Figure 3-29: Initial test hookup

**b. Initialize the instrument:** Press the **Default Setup** button.

**c. Modify the initialized front-panel control settings:**

- Set the **Vertical Scale** to 200 mV.
- Set the **Horizontal Scale** to 200  $\mu$ s.
- Press **Push-Set 50%**.
- Use the Vertical **Position** knob to center the display on screen.
- From the button bar, touch **Horiz/Acq** and select the **Acquisition** tab.
- Touch **Average** and set the number of averages to **128**.

## 2. Confirm the Probe Compensator signal:



Figure 3-30: Measurement of probe compensator frequency

### a. Save the probe compensation signal in reference memory:

- From the menu bar, touch **File; Save As . . .**, **Waveform**, and then **Ref 1**.
- Touch the **Save** button to save the probe compensation signal in reference 1.
- < 4 GHz models: Disconnect the signal from **Ch 1** and the probe compensation connector.
- ≥ 4 GHz models: Disconnect the signal from **Ch 1** and the Fast Edge connector.
- Touch **File; Recall . . .**, **Waveform**, and then select the file name.
- Touch the **Recall** button to recall the probe compensation signal to the display.

### b. Hook up the DC standard source:

- Set the output of a DC calibration generator to off or 0 volts.
- Connect the output of a DC calibration generator to **Ch 1**. Refer to the following figure.

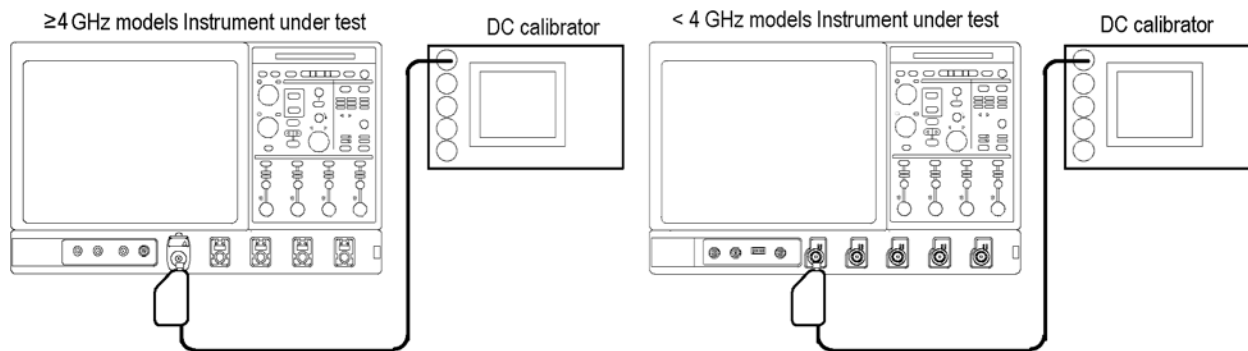

Figure 3-31: Subsequent test hookup

- c. *Measure amplitude of the probe compensation signal:*
  - From the button bar, touch **Horiz/Acq** and select the **Acquisition** tab.
  - Touch **Average** and set the number of averages to **16** using the keypad or the multipurpose knob.
  - Adjust the output of the DC calibration generator until it precisely overlaps the top (upper) level of the stored probe compensation signal.
  - Record the setting of the DC generator.
  - Adjust the output of the DC calibration generator until it precisely overlaps the base (lower) level of the stored probe compensation signal.
  - Record the setting of the DC generator.
- d. Press the **X** (close) button to remove the menus from the display. (See Figure 3-32.)



Figure 3-32: Measurement of probe compensator amplitude

e. *Check against limits:*

- Subtract the value just obtained (base level) from that obtained previously (top level).
- CHECK that the difference obtained is within limits as follows:

Model	Limits
≥ 4 GHz models	343.2 mV to 536.8 mV
< 4 GHz models	985 mV to 1015 mV

- Enter voltage difference on test record.

3. *Disconnect the hookup:* Disconnect the equipment from **Ch 1**.

## Serial Trigger Checks (Optional on Some Models)

These procedures check those characteristics that relate to the serial trigger system and are listed as checked in *Specifications*.

### Check Serial Trigger Baud Rate Limits

#### Equipment required

- One precision 50 Ω coaxial cable (Item 4)
- One sine-wave generator (Item 9)
- One adapter (Item 19)

#### Prerequisites

(See page 3-18, *Prerequisites*.) Also, the instrument must have passed *Check DC Voltage Measurement Accuracy*. (See page 3-42, *Check DC Voltage Measurement Accuracy*.)

1. *Install the test hookup and preset the instrument controls:*

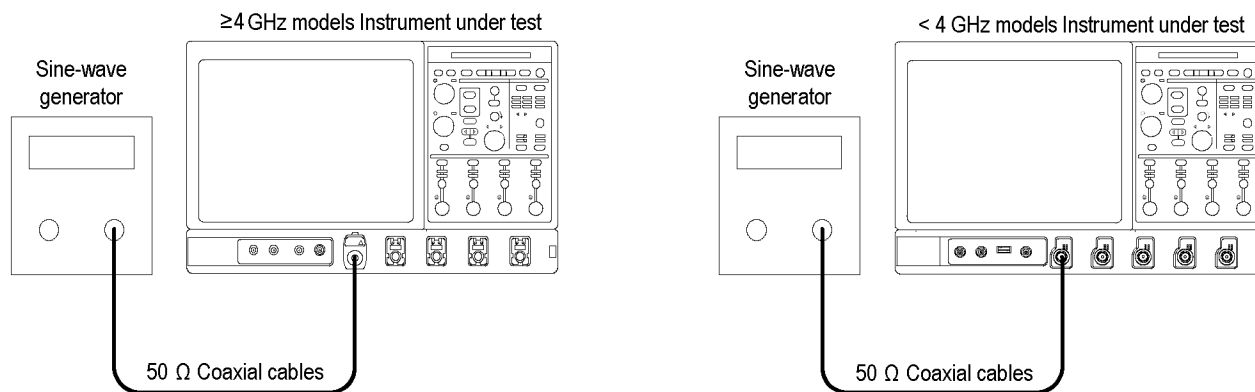

Figure 3-33: Initial test hookup

- a. *Hook Up the test-signal source:* (See Figure 3-33.)
  - Connect the sine wave output of the sine-wave generator through a 50 Ω precision coaxial cable to Ch 1 through an adapter.
  - Set the sine-wave generator to output a 416 MHz sine wave.
- b. *Initialize the instrument:* Press the **Default Setup** button.



- c. Modify the initialized front-panel control settings:
  - Set the vertical **Scale** to 50 mV per division.
  - < 4 GHz models: Touch **Vertical**, select **Vertical Setup**, and then touch Termination **50 Ω**.
  - Set the horizontal **Scale** to 1 ns per division.
  - Adjust the sine-wave generator output for 4 divisions of amplitude centered on the display.
  - Adjust the trigger **Level** to trigger at 25% (-1 division) on the sine wave.

**Table 3-13: Serial pattern data**

Serial pattern data	Trigger location
B6DB 6DB6 DB6D B6DB <sub>16</sub>	One UI before the 0
6DB6 DB6D B6DB 6DB6 <sub>16</sub>	At the 0
DB6D B6DB 6DB6 DB6D <sub>16</sub>	One UI after the 0

2. *Verify that the signal path can do isolated 0 and pattern matching circuits can do isolated 1:*
  - a. From the button bar, touch **Cursors** and then the **Setup** button. If using the menu bar, touch **Cursors** and then select **Cursor Setup**. Touch the **Cursor** button to toggle it on and display the cursors.
  - b. Set the Tracking Mode to **Tracking**.
  - c. Touch the **X** (close) button.
  - d. From the button bar, touch **Trig**, select the **A Event** tab, and touch the **Select** button.
  - e. Touch the **Serial** button, set Coding to NRZ, and then set the Standard to **GB Ethernet**.

- f. Touch the **Edit** button.
- g. Set the Format to **Hex** and then touch the **Clear** button.
- h. Enter data into the Serial Pattern Data field for one of the settings in the table that is not yet checked, starting with the first setting. (See Table 3-13.)
- i. Touch **Enter**.
- j. Right click on the graticule, select Cursors > **Move Cursors to Center**.
- k. Adjust the cursors until the  $\Delta t$  readout equals 800 ps (one unit interval).
- l. Center Cursor 2 in the low of the waveform just to the right of the center graticule line (See Figure 3-34 on page 3-107.)
- m. Verify that the instrument triggers one Unit Interval (UI, one baud divided by the bit period) before the 0 in the input signal. The absolute value of the T1 cursor readout must be  $\leq 325$  ps. Enter pass or fail in the test record.
- n. Touch the **Edit** and then the **Clear** button.
- o. Enter data into Serial Pattern Data field for the next setting in the table that is not yet checked. (See Table 3-13.)
- p. Touch **Enter**.
- q. Center the Cursor 1 in the low of the waveform nearest the center graticule line. (See Figure 3-34 on page 3-107.)

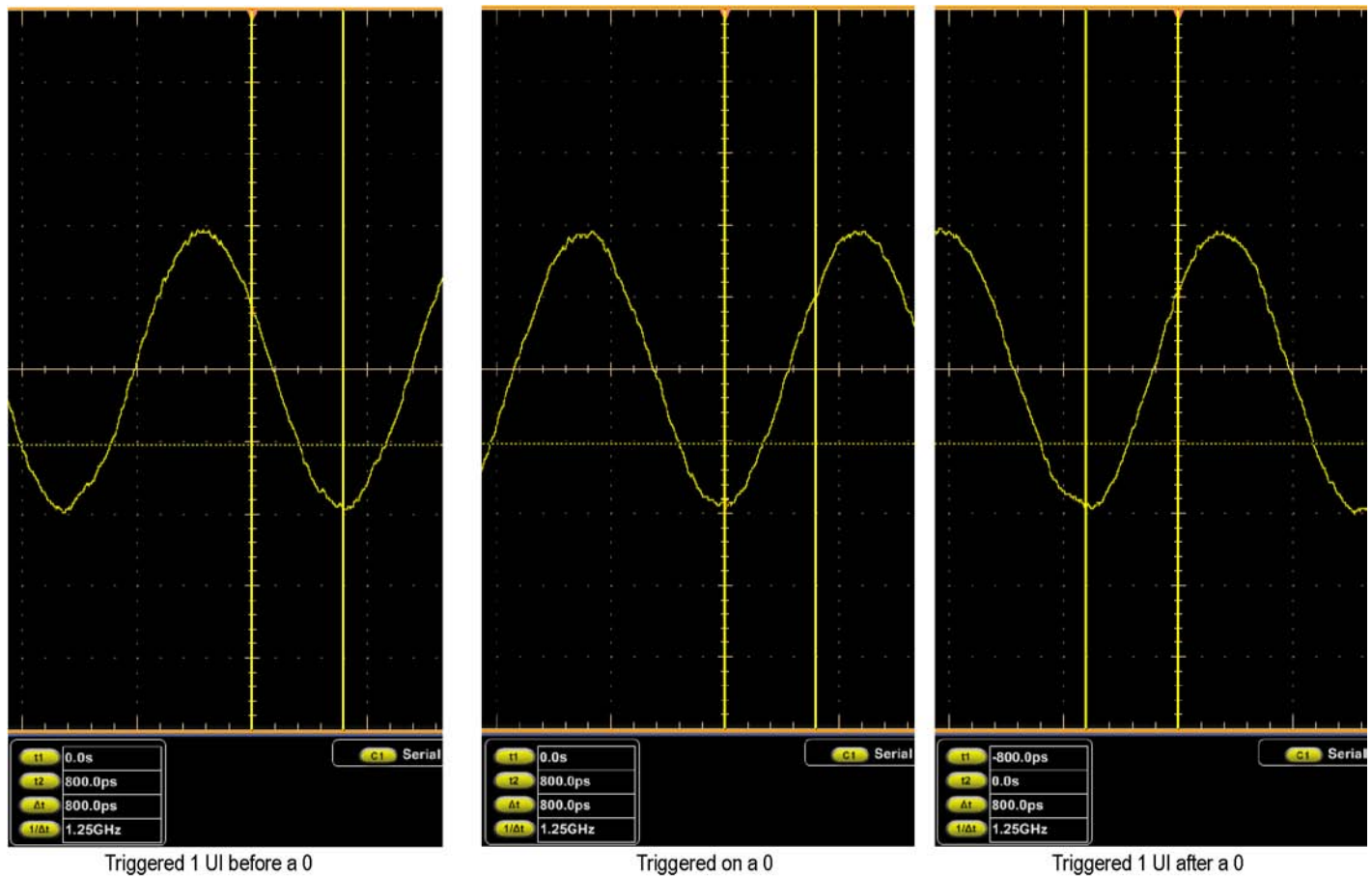

Figure 3-34: Isolated 0 triggering

- r. Verify that the instrument triggers at the 0 in the input signal. The absolute value of the T1 cursor readout must be  $\leq 325$  ps. Enter pass or fail in the test record.
- s. Touch the **Edit** and then the **Clear** button.
- t. Enter data into Serial Pattern Data field for the next setting in the table that is not yet checked. (See Table 3-13.)
- u. Touch **Enter**.
- v. Center Cursor 1 in the low of the waveform just to the left of the center graticule line. (See Figure 3-34 on page 3-107.)
- w. Verify that the instrument triggers one Unit Interval (UI) after the 0 in the input signal. The absolute value of the T2 cursor readout must be  $\leq 325$  ps. Enter pass or fail in the test record.

**Table 3-14: Word recognizer data**

Serial pattern data	Trigger location
4924 9249 2492 4924 <sub>16</sub>	One UI before the 1
9249 2492 4924 9249 <sub>16</sub>	At the 1
2492 4924 9249 2492 <sub>16</sub>	One UI after the 1

3. *Verify that the serial path and pattern matching circuits can do isolated Is:*
  - a. Adjust the trigger **Level** to trigger at 75% (+1 division) on the sine wave.
  - b. Touch the **Edit** and then the **Clear** button.
  - c. Enter data into the Serial Pattern Data field for one of the settings in the table that is not yet checked, starting with the first setting. (See Table 3-14.)
  - d. Touch **Enter**.
  - e. Center Cursor 2 in the high of the waveform just to the right of the center graticule line. (See Figure 3-35 on page 3-109.)
  - f. Verify that the instrument triggers one Unit Interval (UI) before the 1 in the input signal. The absolute value of the T1 cursor readout must be  $\leq 325$  ps. Enter pass or fail in the test record.
  - g. Touch the **Edit** and then the **Clear** button.
  - h. Enter data into the Serial Pattern Data field for the next setting that is not yet checked.
  - i. Touch **Enter**.
  - j. Center the Cursor 1 in the waveform high nearest the center graticule line. (See Figure 3-35 on page 3-109.)
  - k. Verify that the instrument triggers at the 1 in the input signal. The absolute value of the T1 cursor readout must be  $\leq 325$  ps. Enter pass or fail in the test record.
  - l. Touch the **Edit** and then the **Clear** button.
  - m. Enter data into the Serial Pattern Data field for the next setting in the table that is not yet checked. (See Table 3-14.)
  - n. Touch **Enter**.
  - o. Center Cursor 1 in the high of the waveform just to the left of the center graticule line. (See Figure 3-35 on page 3-109.)
  - p. Verify that the instrument triggers one Unit Interval (UI) after the 1 in the input signal. The absolute value of the T2 cursor readout must be  $\leq 325$  ps. Enter pass or fail in the test record.

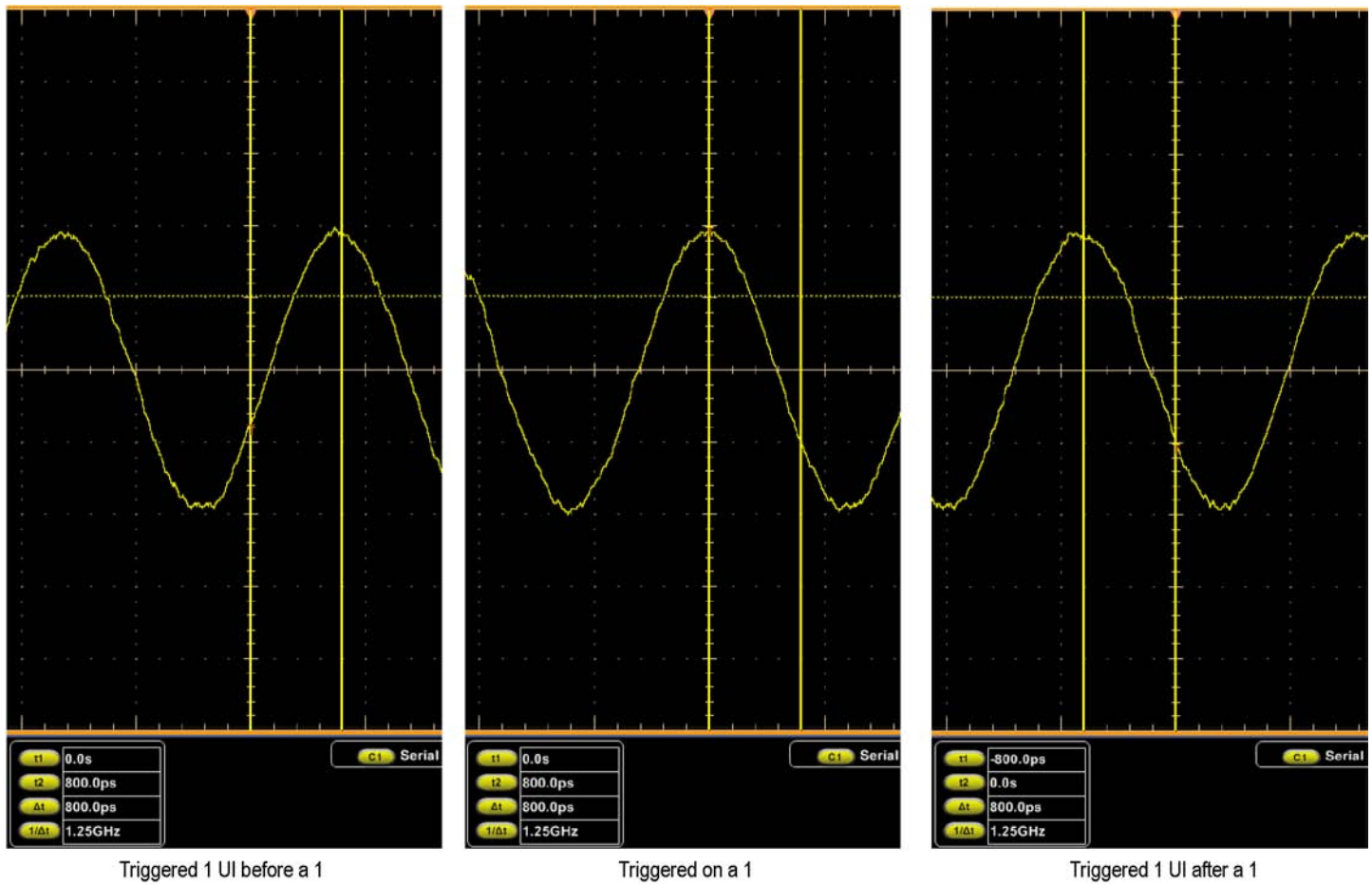

Figure 3-35: Isolated 1 triggering

### Check Serial Trigger Clock Recovery Range

#### Equipment required

- One precision 50  $\Omega$  coaxial cable (Item 4)
- One sine-wave generator (Item 9)
- One adapter (Item 19)

#### Equipment required

The oscilloscope must meet the prerequisites. Also, the instrument must have passed *Check DC Voltage Measurement Accuracy*. (See page 3-42, *Check DC Voltage Measurement Accuracy*.)

1. *Install the test hookup and preset the instrument controls:*

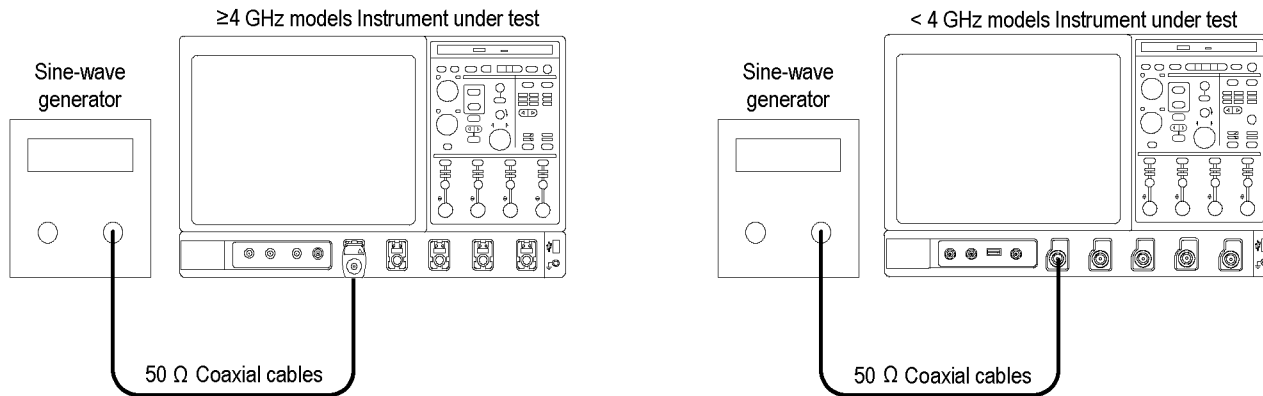

Figure 3-36: Initial test hookup

- a. *Hook up test-signal source 1:* (See Figure 3-36.)
  - Connect the sine wave output of the sine-wave generator through a 50  $\Omega$  precision coaxial cable to Ch 1 through an adapter.
  - Set the sine-wave generator to output a 1.5625 GHz sine wave.
- b. *Initialize the instrument:* Press the **Default Setup** button.

**c.** *Modify the initialized front-panel control settings:*

- Set the Vertical **Scale** to 50 mV per division.
- < 4 GHz models: Touch **Vertical**, select **Vertical Setup**, and then touch Termination **50 Ω**.
- Set the horizontal **Scale** to 200 ps per division.
- From the button bar, touch the **Display** button.
- Set the Display Style to **Dots**.
- Set the Display Persistence to **Variable**, and set the persist Time to **3.0 s**.
- Touch the **X** (close) button.
- Adjust the sine-wave generator output for 8 divisions of amplitude.
- From the button bar, touch **Trig** and select the **A Event** tab.
- Touch the **Select** button.
- Touch the **Comm** button. Set **Source** to Ch1, **Type** to R Clk, and **Coding** to NRZ.

**2.** *Verify the clock recovery at frequency:*

- a.** From the button bar, touch **Trig** and select the **A Event** tab.
- b.** Set the sine-wave generator to output one of the input frequencies in the table that is not yet checked, starting with the first setting. (See Table 3-15 on page 3-112.)
- c.** Set the instrument Bit Rate to the Recovered clock Baud rate listed in the table for the current input frequency.

---

**NOTE.** *The instrument will attempt to acquire lock once. If the input data is disrupted, removed, or heavily distorted, the instrument may not acquire lock or may lose lock. If the recovered clock is not locked to the incoming data, the waveform display will not be stable. Once the input data is available, press the PUSH SET TO 50% knob to force the instrument to acquire lock again.*

---

- d.** Press **PUSH-SET 50%**.

---

**NOTE.** As the input frequency is lowered, adjust the Horizontal SCALE to maintain about 3 to 5 eyes across the display.

---

- e. Verify that lock is acquired. (See Figure 3-37 on page 3-113.)
  - f. Repeat substeps b through d for each input frequency and Baud rate listed in the table. (See Table 3-15 on page 3-112.)
  - g. If all tests pass, enter passed in the test record.
3. *Disconnect the hookup:* Disconnect the equipment from the instrument.

**Table 3-15: Clock recovery input frequencies and baud rates**

Input frequency	Recovered clock baud rate
<i>≥ 4 GHz models</i>	
1.5625 GHz	3125 Mbaud
781.25 MHz	3125 Mbaud
742.19 MHz	2968.8 Mbaud
600 MHz	2400 Mbaud
575.00 MHz	2300 Mbaud
546.25 MHz	2185 Mbaud
390.63 MHz	1.5625 Gbaud
388.13 MHz	1.5525 Gbaud
<i>&lt; 4 GHz models</i>	
625 MHz	1.25 Gbaud
321.5 MHz	1.25 Gbaud
296.87 MHz	1.187 Gbaud
168.75 MHz	675 Mbaud
300 MHz	1200 Mbaud
156.25 MHz	625 Mbaud
78.12 MHz	312.5 Mbaud
74.21 MHz	296.48 Mbaud
31.25 MHz	125 Mbaud
15.62 MHz	62.5 Mbaud
7.81 MHz	31.25 Mbaud
3.9 MHz	15.65 Mbaud
1.95 MHz	7.81 Mbaud
976.56 kHz	3.9 Mbaud
488.28 kHz	1.95 Mbaud
380.98 kHz	1.52 Mbaud



Recovered clock locked  
(1.5625 GHz)

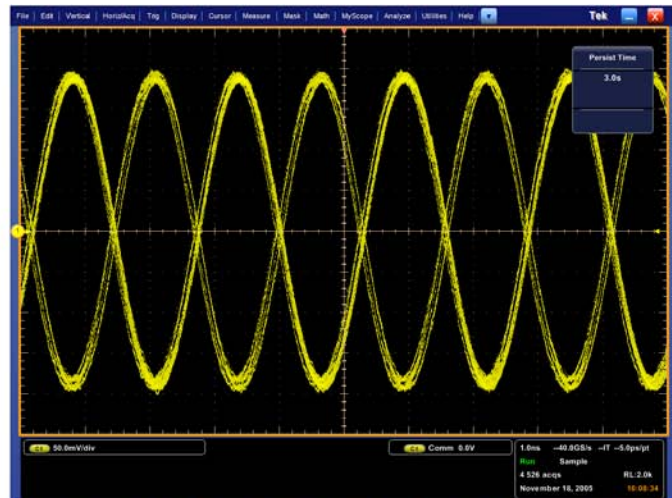

Recovered clock locked  
(All frequencies except  
1.5625 GHz)

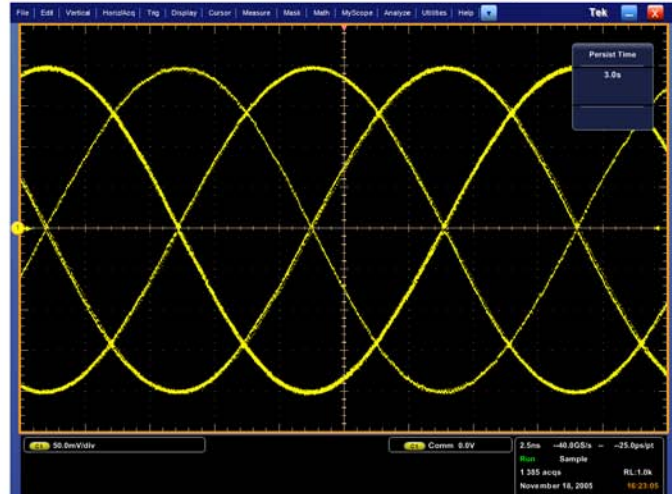

A possible display with the  
recovered clock not locked

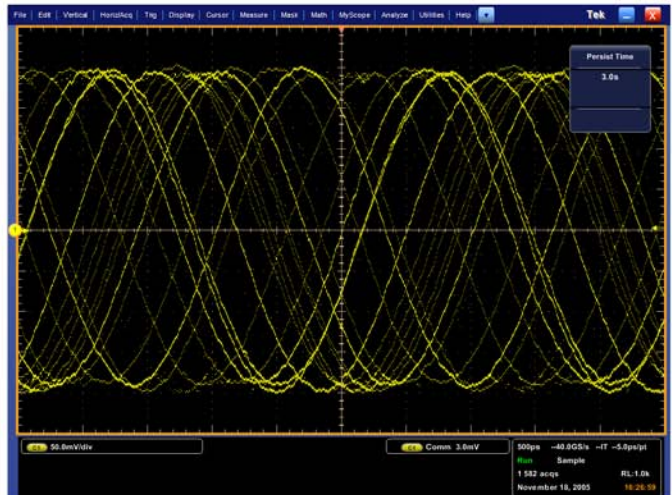

Figure 3-37: Clock recovery

## Sine Wave Generator Leveling Procedure

Some procedures in this manual require a sine wave generator to produce the necessary test signals. If you do not have a leveled sine wave generator, use one of the following procedures to level the output amplitude of your sine wave generator.

### Equipment required

Sine wave generator (Item 9)  
 Meter, power and sensor (Item 10)  
 Power splitter (Item 11)  
 50  $\Omega$  precision cable 2.92 mm male-to-female (Item 12)  
 One K male-to-male adapter (Item 13)

### Prerequisites

(See page 3-18, *Prerequisites*.)

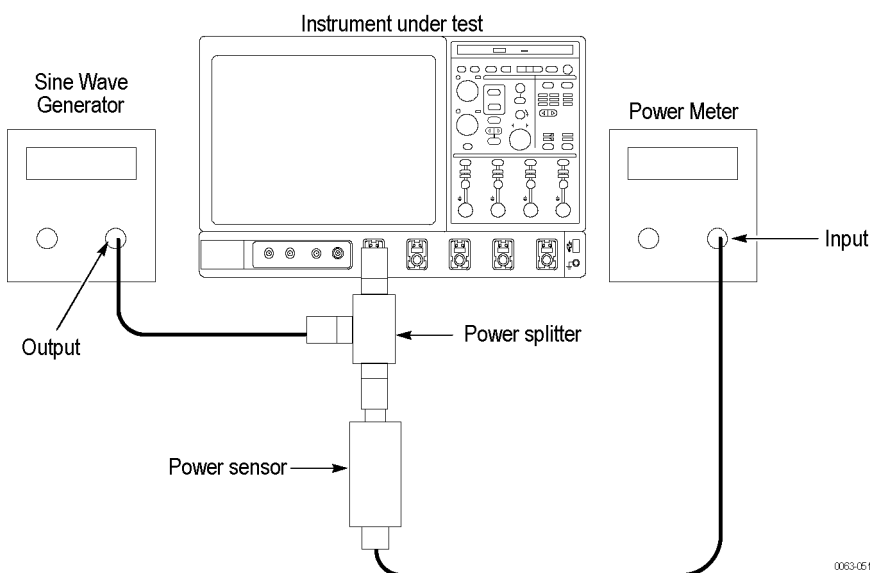

**Figure 3-38: Sine wave generator leveling equipment setup**

1. *Install the test hookup:* Connect the equipment as shown in the above figure.
2. *Set the Generator:*
  - Set the sine wave generator to a reference frequency of 10 MHz.
  - Adjust the sine wave generator amplitude to the required number of divisions as measured by the instrument.

3. *Record the reference level:* Note the reading on the level meter.
4. *Set the generator to the new frequency and reference level:*
  - Change the sine wave generator to the desired new frequency.
  - Input the correction factor and/or the new frequency into the level meter.
  - Adjust the sine wave generator amplitude until the level meter again reads the value noted in step 3. The signal amplitude is now correctly set for the new frequency.

<b>Equipment required</b>	<b>Prerequisites</b>
Sine wave generator (Item 9)	(See page 3-18, <i>Prerequisites.</i> )
Level meter and power sensor (Item 10)	
Two male N to female BNC adapters (Item 14)	
Two precision coaxial cables (Item 4)	
One or two SMA male-to-female BNC adapters (Item 19)	

1. *Install the test hookup:* Connect the equipment as shown in the figure below (start with the sine wave generator connected to the instrument). (See Figure 3-39.)
2. *Set the Generator:*
  - Set the sine wave generator to a reference frequency of 10 MHz.
  - Adjust the sine wave generator amplitude to the required number of divisions as measured by the instrument.

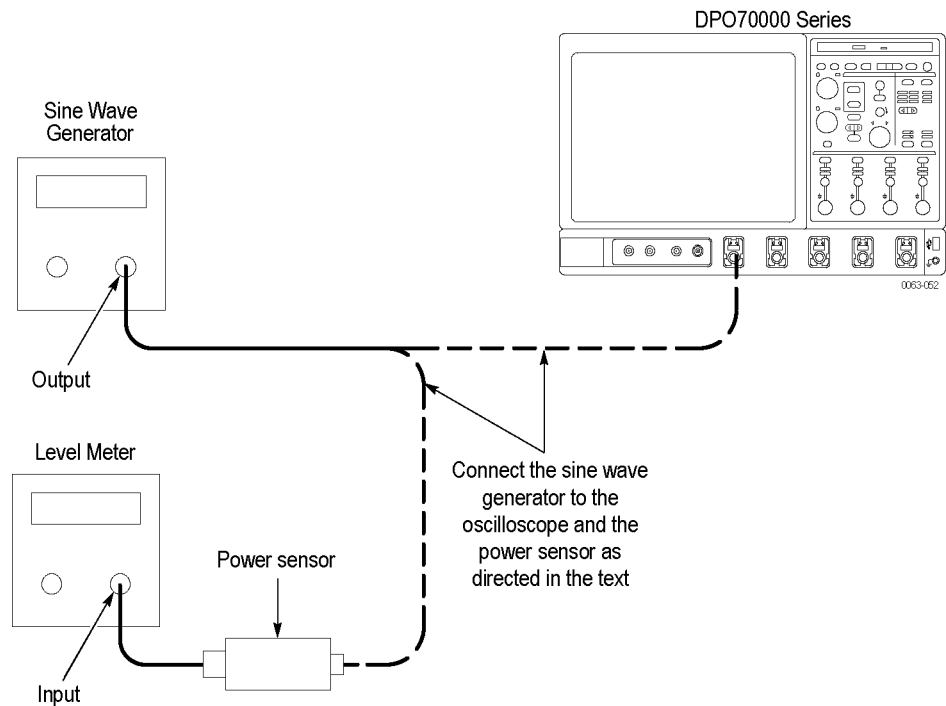

**Figure 3-39: Equipment setup for maximum amplitude**

**3. Record the reference level:**

- Disconnect the sine wave generator from the instrument.
- Connect the sine wave generator to the power sensor.
- Note the level meter reading.

**4. Set the generator to the new frequency and reference level:**

- Change the sine wave generator to the desired new frequency.
- Input the correction factor and/or the new frequency into the level meter.
- Adjust the sine wave generator amplitude until the level meter again reads the value noted in step 3. The signal amplitude is now correctly set for the new frequency.
- Disconnect the sine wave generator from the power sensor.
- Connect the sine wave generator to the instrument.

---

# Performance Verification (MSO/DPO5000 Series)



# Performance Verification (MSO/DPO5000 Series)

This chapter contains performance verification procedures for the specifications marked with the ✓ symbol. The following equipment, or a suitable equivalent, is required to complete these procedures.

**Table 4-1: Required equipment**

Description	Minimum requirements	Examples
DC voltage source	3 mV to 4 V, $\pm 0.1\%$ accuracy	Fluke 9500 Oscilloscope Calibrator with a 9510 Output Module
Leveled sine wave generator	50 kHz to 1000 MHz, $\pm 4\%$ amplitude accuracy	
Time mark generator	80 ms period, $\pm 1$ ppm accuracy, rise time <50 ns	
Logic Probe (MSO5000 Series only)	Low capacitance digital probe, 16 channels.	P6616 probe; standard accessory for MSO5000 Series oscilloscopes.
BNC-to-0.1 inch pin adapter to connect the logic probe to the signal source. (MSO5000 Series only)	BNC-to-0.1 inch pin adapter; female BNC to 2x16 .01 inch pin headers.	Tektronix adapter part number 679-6240-00; to connect the Fluke 9500 to the P6616 probe.
Digital Multimeter (DMM)	0.1% accuracy or better	
One 50 $\Omega$ terminator	Impedance 50 $\Omega$ ; connectors: female BNC input, male BNC output	Tektronix part number 011-0049-02
One 50 $\Omega$ BNC cable	Male-to-male connectors	Tektronix part number 012-0057-01
Optical Mouse	USB, PS2	Tektronix part number 119-7054-00; standard accessory for MSO5000 Series and DPO5000 Series oscilloscopes.

You might need additional cables and adapters, depending on the actual test equipment you use.

These procedures cover all MSO5000 series and DPO5000 series models. Disregard checks that do not apply to the specific model you are testing.

Print the test record on the following pages and use it to record the performance test results for your oscilloscope.

---

**NOTE.** *Completion of the performance verification procedure does not update the stored time and date of the latest successful adjustment. The date and time are updated only when the adjustment procedures in the service manual are successfully completed.*

---

The performance verification procedures verify the performance of your instrument. They do not adjust your instrument. If your instrument fails any of the performance verification tests, you should return the instrument to Tektronix for adjustment or repair.

## Test Record

Model	Serial	Procedure performed by	Date
-------	--------	------------------------	------

Test	Passed	Failed
------	--------	--------

Self Test

### Input Impedance

Performance checks	Vertical scale	Low limit	Test result	High limit
Channel 1 Input Impedance, 1 M $\Omega$	10 mV/div	990 k $\Omega$		1.01 M $\Omega$
	100 mV/div	990 k $\Omega$		1.01 M $\Omega$
	1 V/div	990 k $\Omega$		1.01 M $\Omega$
Channel 1 Input Impedance, 50 $\Omega$	10 mV/div	49.5 $\Omega$		50.5 $\Omega$
	100 mV/div	49.5 $\Omega$		50.5 $\Omega$
Channel 2 Input Impedance, 1 M $\Omega$	10 mV/div	990 k $\Omega$		1.01 M $\Omega$
	100 mV/div	990 k $\Omega$		1.01 M $\Omega$
	1 V/div	990 k $\Omega$		1.01 M $\Omega$
Channel 2 Input Impedance, 50 $\Omega$	10 mV/div	49.5 $\Omega$		50.5 $\Omega$
	100 mV/div	49.5 $\Omega$		50.5 $\Omega$
Channel 3 Input Impedance, 1 M $\Omega$	10 mV/div	990 k $\Omega$		1.01 M $\Omega$
	100 mV/div	990 k $\Omega$		1.01 M $\Omega$
	1 V/div	990 k $\Omega$		1.01 M $\Omega$
Channel 3 Input Impedance, 50 $\Omega$	10 mV/div	49.5 $\Omega$		50.5 $\Omega$
	100 mV/div	49.5 $\Omega$		50.5 $\Omega$
Channel 4 Input Impedance, 1 M $\Omega$	10 mV/div	990 k $\Omega$		1.01 M $\Omega$
	100 mV/div	990 k $\Omega$		1.01 M $\Omega$
	1 V/div	990 k $\Omega$		1.01 M $\Omega$
Channel 4, Input Impedance, 50 $\Omega$	10 mV/div	49.5 $\Omega$		50.5 $\Omega$
	100 mV/div	49.5 $\Omega$		50.5 $\Omega$
AUX In Input Impedance, 250 k $\Omega$	100 mV/div	246 k $\Omega$		254 k $\Omega$



**DC Balance**

<b>Performance checks</b>	<b>Vertical scale</b>	<b>Low limit</b>	<b>Test result</b>	<b>High limit</b>
Channel 1 DC Balance, 50 $\Omega$ , 20 MHz BW	1 mV/div	-0.2 mV		0.2 mV
	2 mV/div	-0.2 mV		0.2 mV
	10 mV/div	-1 mV		1 mV
	100 mV/div	-10 mV		10 mV
	1 V/div	-100 mV		100 mV
Channel 1 DC Balance, 1 M $\Omega$ , 20 MHz BW	1 mV/div	-0.2 mV		0.2 mV
	2 mV/div	-0.4 mV		0.4 mV
	10 mV/div	-2 mV		2 mV
	100 mV/div	-20 mV		20 mV
	1 V/div	-200 mV		200 mV
	10 V/div	-2 V		2 V
Channel 1 DC Balance, 50 $\Omega$ , 175 MHz BW	1 mV/div	-0.2 mV		0.2 mV
Channel 1 DC Balance, 1 M $\Omega$ , 175 MHz BW	1 mV/div	-0.2 mV		0.2 mV
Channel 1 DC Balance, 50 $\Omega$ , 250 MHz BW	2 mV/div	-0.2 mV		0.2 mV
	10 mV/div	-1 mV		1 mV
	100 mV/div	-10 mV		10 mV
	1 V/div	-100 mV		100 mV
Channel 1 DC Balance, 1 M $\Omega$ , 250 MHz BW	2 mV/div	-0.4 mV		0.4 mV
	10 mV/div	-2 mV		2 mV
	100 mV/div	-20 mV		20 mV
	1 V/div	-200 mV		200 mV
	10 V/div	-2 V		2 V
Channel 1 DC Balance, 50 $\Omega$ , Full BW	1 mV/div	-0.2 mV		0.2 mV
	2 mV/div	-0.2 mV		0.2 mV
	10 mV/div	-1 mV		1 mV
	100 mV/div	-10 mV		10 mV
	1 V/div	-100 mV		100 mV
Channel 1 DC Balance, 1 M $\Omega$ , Full BW	1 mV/div	-0.2 mV		0.2 mV
	2 mV/div	-0.4 mV		0.4 mV
	10 mV/div	-2 mV		2 mV
	100 mV/div	-20 mV		20 mV
	1 V/div	-200 mV		200 mV
	10 V/div	-2 V		2 V

Performance Verification (MSO/DPO5000 Series)

**DC Balance**

Performance checks	Vertical scale	Low limit	Test result	High limit
Channel 2 DC Balance, 50 $\Omega$ , 20 MHz BW	1 mV/div	-0.2 mV		0.2 mV
	2 mV/div	-0.2 mV		0.2 mV
	10 mV/div	-1 mV		1 mV
	100 mV/div	-10 mV		10 mV
	1 V/div	-100 mV		100 mV
Channel 2 DC Balance, 1 M $\Omega$ , 20 MHz BW	1 mV/div	-0.2 mV		0.2 mV
	2 mV/div	-0.4 mV		0.4 mV
	10 mV/div	-2 mV		2 mV
	100 mV/div	-20 mV		20 mV
	1 V/div	-200 mV		200 mV
	10 V/div	-2 V		2 V
Channel 2 DC Balance, 50 $\Omega$ , 175 MHz BW	1 mV/div	-0.2 mV		0.2 mV
Channel 2 DC Balance, 1 M $\Omega$ , 175 MHz BW	1 mV/div	-0.2 mV		0.2 mV
Channel 2 DC Balance, 50 $\Omega$ , 250 MHz BW	2 mV/div	-0.2 mV		0.2 mV
	10 mV/div	-1 mV		1 mV
	100 mV/div	-10 mV		10 mV
	1 V/div	-100 mV		100 mV
Channel 2 DC Balance, 1 M $\Omega$ , 250 MHz BW	2 mV/div	-0.4 mV		0.4 mV
	10 mV/div	-2 mV		2 mV
	100 mV/div	-20 mV		20 mV
	1 V/div	-200 mV		200 mV
	10 V/div	-2 V		2 V
Channel 2 DC Balance, 50 $\Omega$ , Full BW	1 mV/div	-0.2 mV		0.2 mV
	2 mV/div	-0.2 mV		0.2 mV
	10 mV/div	-1 mV		1 mV
	100 mV/div	-10 mV		10 mV
	1 V/div	-100 mV		100 mV
Channel 2 DC Balance, 1 M $\Omega$ , Full BW	1 mV/div	-0.2 mV		0.2 mV
	2 mV/div	-0.4 mV		0.4 mV
	10 mV/div	-2 mV		2 mV
	100 mV/div	-20 mV		20 mV
	1 V/div	-200 mV		200 mV
	10 V/div	-2 V		2 V

**DC Balance**

<b>Performance checks</b>	<b>Vertical scale</b>	<b>Low limit</b>	<b>Test result</b>	<b>High limit</b>
Channel 3 DC Balance, 50 $\Omega$ , 20 MHz BW	1 mV/div	-0.2 mV		0.2 mV
	2 mV/div	-0.2 mV		0.2 mV
	10 mV/div	-1 mV		1 mV
	100 mV/div	-10 mV		10 mV
	1 V/div	-100 mV		100 mV
Channel 3 DC Balance, 1 M $\Omega$ , 20 MHz BW	1 mV/div	-0.2 mV		0.2 mV
	2 mV/div	-0.4 mV		0.4 mV
	10 mV/div	-2 mV		2 mV
	100 mV/div	-20 mV		20 mV
	1 V/div	-200 mV		200 mV
	10 V/div	-2 V		2 V
Channel 3 DC Balance, 50 $\Omega$ , 175 MHz BW	1 mV/div	-0.2 mV		0.2 mV
Channel 3 DC Balance, 1 M $\Omega$ , 175 MHz BW	1 mV/div	-0.2 mV		0.2 mV
Channel 3 DC Balance, 50 $\Omega$ , 250 MHz BW	2 mV/div	-0.2 mV		0.2 mV
	10 mV/div	-1 mV		1 mV
	100 mV/div	-10 mV		10 mV
	1 V/div	-100 mV		100 mV
Channel 3 DC Balance, 1 M $\Omega$ , 250 MHz BW	2 mV/div	-0.4 mV		0.4 mV
	10 mV/div	-2 mV		2 mV
	100 mV/div	-20 mV		20 mV
	1 V/div	-200 mV		200 mV
	10 V/div	-2 V		2 V
Channel 3 DC Balance, 50 $\Omega$ , Full BW	1 mV/div	-0.2 mV		0.2 mV
	2 mV/div	-0.2 mV		0.2 mV
	10 mV/div	-1 mV		1 mV
	100 mV/div	-10 mV		10 mV
	1 V/div	-100 mV		100 mV
Channel 3 DC Balance, 1 M $\Omega$ , Full BW	1 mV/div	-0.2 mV		0.2 mV
	2 mV/div	-0.4 mV		0.4 mV
	10 mV/div	-2 mV		2 mV
	100 mV/div	-20 mV		20 mV
	1 V/div	-200 mV		200 mV
	10 V/div	-2 V		2 V

**DC Balance**

<b>Performance checks</b>	<b>Vertical scale</b>	<b>Low limit</b>	<b>Test result</b>	<b>High limit</b>
Channel 4 DC Balance, 50 Ω, 20 MHz BW	1 mV/div	-0.2 mV		0.2 mV
	2 mV/div	-0.2 mV		0.2 mV
	10 mV/div	-1 mV		1 mV
	100 mV/div	-10 mV		10 mV
	1 V/div	-100 mV		100 mV
Channel 4 DC Balance, 1 MΩ, 20 MHz BW	1 mV/div	-0.2 mV		0.2 mV
	2 mV/div	-0.4 mV		0.4 mV
	10 mV/div	-2 mV		2 mV
	100 mV/div	-20 mV		20 mV
	1 V/div	-200 mV		200 mV
	10 V/div	-2 V		2 V
Channel 4 DC Balance, 50 Ω, 175 MHz BW	1 mV/div	-0.2 mV		0.2 mV
Channel 4 DC Balance, 1 MΩ, 175 MHz BW	1 mV/div	-0.2 mV		0.2 mV
Channel 4 DC Balance, 50 Ω, 250 MHz BW	2 mV/div	-0.2 mV		0.2 mV
	10 mV/div	-1 mV		1 mV
	100 mV/div	-10 mV		10 mV
	1 V/div	-100 mV		100 mV
Channel 4 DC Balance, 1 MΩ, 250 MHz BW	2 mV/div	-0.4 mV		0.4 mV
	10 mV/div	-2 mV		2 mV
	100 mV/div	-20 mV		20 mV
	1 V/div	-200 mV		200 mV
	10 V/div	-2 V		2 V
Channel 4 DC Balance, 50 Ω, Full BW	1 mV/div	-0.2 mV		0.2 mV
	2 mV/div	-0.2 mV		0.2 mV
	10 mV/div	-1 mV		1 mV
	100 mV/div	-10 mV		10 mV
	1 V/div	-100 mV		100 mV
Channel 4 DC Balance, 1 MΩ, Full BW	1 mV/div	-0.2 mV		0.2 mV
	2 mV/div	-0.4 mV		0.4 mV
	10 mV/div	-2 mV		2 mV
	100 mV/div	-20 mV		20 mV
	1 V/div	-200 mV		200 mV
	10 V/div	-2 V		2 V

**DC Gain Accuracy**

<b>Performance checks</b>	<b>Bandwidth</b>	<b>Vertical scale</b>	<b>Low limit</b>	<b>Test result</b>	<b>High limit</b>	
Channel 1 DC Gain Accuracy, 0 V offset, 0 V vertical position, 50 $\Omega$	20 MHz	1 mV/div	-2.0%		2.0%	
		2 mV/div	-1.5%		1.5%	
		5 mV/div	-1.5%		1.5%	
		10 mV/div	-1.5%		1.5%	
		20 mV/div	-1.5%		1.5%	
		50 mV/div	-1.5%		1.5%	
		100 mV/div	-1.5%		1.5%	
		200 mV/div	-1.5%		1.5%	
		500 mV/div	-1.5%		1.5%	
		1 V/div	-1.5%		1.5%	
		Channel 1 DC Gain Accuracy, 0 V offset, 0 V vertical position, 1 M $\Omega$	20 MHz	1 mV/div	-2.0%	
2 mV/div	-1.5%				1.5%	
5 mV/div	-1.5%				1.5%	
10 mV/div	-1.5%				1.5%	
20 mV/div	-1.5%				1.5%	
50 mV/div	-1.5%				1.5%	
63.5 mV/div	-3.0%				3.0%	
100 mV/div	-1.5%				1.5%	
200 mV/div	-1.5%				1.5%	
500 mV/div	-1.5%				1.5%	
1 V/div	-1.5%				1.5%	
250 MHz	20 mV/div			-1.5%		1.5%
FULL	20 mV/div			-1.5%		1.5%

**DC Gain Accuracy**

<b>Performance checks</b>	<b>Bandwidth</b>	<b>Vertical scale</b>	<b>Low limit</b>	<b>Test result</b>	<b>High limit</b>	
Channel 2 DC Gain Accuracy, 0 V offset, 0 V vertical position, 50 $\Omega$	20 MHz	1 mV/div	-2.0%		2.0%	
		2 mV/div	-1.5%		1.5%	
		5 mV/div	-1.5%		1.5%	
		10 mV/div	-1.5%		1.5%	
		20 mV/div	-1.5%		1.5%	
		50 mV/div	-1.5%		1.5%	
		100 mV/div	-1.5%		1.5%	
		200 mV/div	-1.5%		1.5%	
		500 mV/div	-1.5%		1.5%	
		1 V/div	-1.5%		1.5%	
Channel 2 DC Gain Accuracy, 0 V offset, 0 V vertical position, 1 M $\Omega$	20 MHz	1 mV/div	-2.0%		2.0%	
		2 mV/div	-1.5%		1.5%	
		5 mV/div	-1.5%		1.5%	
		10 mV/div	-1.5%		1.5%	
		20 mV/div	-1.5%		1.5%	
		50 mV/div	-1.5%		1.5%	
		63.5 mV/div	-3.0%		3.0%	
		100 mV/div	-1.5%		1.5%	
		200 mV/div	-1.5%		1.5%	
		500 mV/div	-1.5%		1.5%	
		1 V/div	-1.5%		1.5%	
		250 MHz	20 mV/div	-1.5%		1.5%
		FULL	20 mV/div	-1.5%		1.5%

**DC Gain Accuracy**

<b>Performance checks</b>	<b>Bandwidth</b>	<b>Vertical scale</b>	<b>Low limit</b>	<b>Test result</b>	<b>High limit</b>		
Channel 3 DC Gain Accuracy, 0 V offset, 0 V vertical position, 50 $\Omega$	20 MHz	1 mV/div	-2.0%		2.0%		
		2 mV/div	-1.5%		1.5%		
		5 mV/div	-1.5%		1.5%		
		10 mV/div	-1.5%		1.5%		
		20 mV/div	-1.5%		1.5%		
		50 mV/div	-1.5%		1.5%		
		100 mV/div	-1.5%		1.5%		
		200 mV/div	-1.5%		1.5%		
		500 mV/div	-1.5%		1.5%		
		1 V/div	-1.5%		1.5%		
Channel 3 DC Gain Accuracy, 0 V offset, 0 V vertical position, 1 M $\Omega$	20 MHz	1 mV/div	-2.0%		2.0%		
		2 mV/div	-1.5%		1.5%		
		5 mV/div	-1.5%		1.5%		
		10 mV/div	-1.5%		1.5%		
		20 mV/div	-1.5%		1.5%		
		50 mV/div	-1.5%		1.5%		
		63.5 mV/div	-3.0%		3.0%		
		100 mV/div	-1.5%		1.5%		
		200 mV/div	-1.5%		1.5%		
		500 mV/div	-1.5%		1.5%		
		1 V/div	-1.5%		1.5%		
			250 MHz	20 mV/div	-1.5%		1.5%
			FULL	20 mV/div	-1.5%		1.5%

**DC Gain Accuracy**

<b>Performance checks</b>	<b>Bandwidth</b>	<b>Vertical scale</b>	<b>Low limit</b>	<b>Test result</b>	<b>High limit</b>
Channel 4 DC Gain Accuracy, 0 V offset, 0 V vertical position, 50 $\Omega$	20 MHz	1 mV/div	-2.0%		2.0%
		2 mV/div	-1.5%		1.5%
		5 mV/div	-1.5%		1.5%
		10 mV/div	-1.5%		1.5%
		20 mV/div	-1.5%		1.5%
		50 mV/div	-1.5%		1.5%
		100 mV/div	-1.5%		1.5%
		200 mV/div	-1.5%		1.5%
		500 mV/div	-1.5%		1.5%
		1 V/div	-1.5%		1.5%
Channel 4 DC Gain Accuracy, 0 V offset, 0 V vertical position, 1 M $\Omega$	20 MHz	1 mV/div	-2.0%		2.0%
		2 mV/div	-1.5%		1.5%
		5 mV/div	-1.5%		1.5%
		10 mV/div	-1.5%		1.5%
		20 mV/div	-1.5%		1.5%
		50 mV/div	-1.5%		1.5%
		63.5 mV/div	-3.0%		3.0%
		100 mV/div	-1.5%		1.5%
		200 mV/div	-1.5%		1.5%
		500 mV/div	-1.5%		1.5%
	1 V/div	-1.5%		1.5%	
	250 MHz	20 mV/div	-1.5%		1.5%
	FULL	20 mV/div	-1.5%		1.5%



**DC Offset Accuracy****Performance**

<b>checks</b>	<b>Vertical scale</b>	<b>Vertical offset<sup>1</sup></b>	<b>Low limit</b>	<b>Test result</b>	<b>High limit</b>
<b>All models:</b>					
Channel 1 DC Offset Accuracy, 20 MHz BW, 50 $\Omega$	1 mV/div	900 mV	895.3 mV		904.7 mV
	1 mV/div	-900 mV	-904.7 mV		-895.3 mV
	100 mV/div	5.0 V	4.965 V		5.035 V
	100 mV/div	-5.0 V	-5.035 V		-4.965 V
Channel 1 DC Offset Accuracy, 20 MHz BW, 1 M $\Omega$	1 mV/div	900 mV	895.3 mV		904.7 mV
	1 mV/div	-900 mV	-904.7 mV		-895.3 mV
	100 mV/div	9.0 V	8.935 V		9.065 V
	100 mV/div	- 9.0V	-9.065 V		-8.935 V
	500 mV/div	9.0 V	8.855 V		9.145 V
	500 mV/div	- 9.0V	-9.145 V		-8.855 V
	1.01 V/div	99.5 V	98.80 V		100.2 V
	1.01 V/div	-99.5 V	-100.2 V		-98.80 V
	3 V/div	99.5 V	98.4 V		100.6 V
	3 V/div	-99.5 V	-100.6 V		-98.4 V
Channel 2 DC Offset Accuracy, 20 MHz BW, 50 $\Omega$	1 mV/div	900 mV	895.3 mV		904.7 mV
	1 mV/div	-900 mV	-904.7 mV		-895.3 mV
	100 mV/div	5.0 V	4.965 V		5.035 V
	100 mV/div	-5.0 V	-5.035 V		-4.965 V
Channel 2 DC Offset Accuracy, 20 MHz BW, 1 M $\Omega$	1 mV/div	900 mV	895.3 mV		904.7 mV
	1 mV/div	-900 mV	-904.7 mV		-895.3 mV
	100 mV/div	9.0 V	8.935 V		9.065 V
	100 mV/div	-9.0 V	-9.065 V		-8.935 V
	500 mV/div	9.0 V	8.855 V		9.145 V
	500 mV/div	- 9.0V	-9.145 V		-8.855 V
	1.01 V/div	99.5 V	98.80 V		100.2 V
	1.01 V/div	-99.5 V	-100.2 V		-98.80 V
	3 V/div	99.5 V	98.40 V		100.6 V
	3 V/div	-99.5 V	-100.6 V		-98.4 V

**DC Offset Accuracy****Performance**

<b>checks</b>	<b>Vertical scale</b>	<b>Vertical offset<sup>1</sup></b>	<b>Low limit</b>	<b>Test result</b>	<b>High limit</b>
Channel 3 DC Offset Accuracy, 20 MHz BW, 50 $\Omega$	1 mV/div	900 mV	895.3 mV		904.7 mV
	1 mV/div	-900 mV	-904.7 mV		-895.3 mV
	100 mV/div	5.0 V	4.965 V		5.035 V
	100 mV/div	-5.0 V	-5.035 V		-4.965 V
Channel 3 DC Offset Accuracy, 20 MHz BW, 1 M $\Omega$	1 mV/div	900 mV	895.3 mV		904.7 mV
	1 mV/div	-900 mV	-904.7 mV		-895.3 mV
	100 mV/div	9.0 V	8.935 V		9.065 V
	100 mV/div	-9.0 V	-9.065 V		-8.935 V
	500 mV/div	9.0 V	8.855 V		9.145 V
	500 mV/div	-9.0V	-9.145 V		-8.855 V
	1.01 V/div	99.5 V	98.80 V		100.2 V
	1.01 V/div	-99.5 V	-100.2 V		-98.80 V
	3 V/div	99.5 V	98.4 V		100.6 V
	3 V/div	-99.5 V	-100.6 V		-98.4 V
Channel 4 DC Offset Accuracy, 20 MHz BW, 50 $\Omega$	1 mV/div	900 mV	895.3 mV		904.7 mV
	1 mV/div	-900 mV	-904.7 mV		-895.3 mV
	100 mV/div	5.0 V	4.965 V		5.035 V
	100 mV/div	-5.0 V	-5.035 V		-4.965 V
Channel 4 DC Offset Accuracy, 20 MHz BW, 1 M $\Omega$	1 mV/div	900 mV	895.3 mV		904.7 mV
	1 mV/div	-900 mV	-904.7 mV		-895.3 mV
	100 mV/div	9.0 V	8.935 V		9.065 V
	100 mV/div	-9.0 V	-9.065 V		-8.935 V
	500 mV/div	9.0 V	8.855 V		9.145 V
	500 mV/div	-9.0V	-9.145 V		-8.855 V
	1.01 V/div	99.5 V	98.80 V		100.2 V
	1.01 V/div	-99.5 V	-100.2 V		-98.80 V
	3 V/div	99.5 V	98.4 V		100.6 V
	3 V/div	-99.5 V	-100.6 V		-98.4 V

<sup>1</sup> Use this value for both the calibrator output and the oscilloscope offset setting.

## Analog Bandwidth

## Performance checks

Bandwidth at Channel	Impedance	Vertical scale	Horizontal scale	$V_{in-pp}$	$V_{bw-pp}$	Limit	Test result Gain = $V_{bw-pp}/V_{in-pp}$
<b>All Models</b>							
Channel 1	50 $\Omega$	1 mV/div	5 ns/div (175 MHz)			$\geq 0.707$	
		2 mV/div	2.5 ns/div (350 MHz)			$\geq 0.707$	
		5 mV/div	1 ns/div (Full BW)			$\geq 0.707$	
		10 mV/div	1 ns/div (Full BW)			$\geq 0.707$	
		50 mV/div	1 ns/div (Full BW)			$\geq 0.707$	
		100 mV/div	1 ns/div (Full BW)			$\geq 0.707$	
		1 V/div	1 ns/div (Full BW)			$\geq 0.707$	
<b>MSO5204, DPO5204, MSO5104, DPO5104 Only</b>							
Channel 1	1 M $\Omega$	1 mV/div	5 ns/div (175 MHz)			$\geq 0.707$	
		2 mV/div	2.5 ns/div (350 MHz)			$\geq 0.707$	
		5 mV/div	1 ns/div (Full BW)			$\geq 0.707$	
		10 mV/div	1 ns/div (Full BW)			$\geq 0.707$	
		50 mV/div	1 ns/div (Full BW)			$\geq 0.707$	
		100 mV/div	1 ns/div (Full BW)			$\geq 0.707$	
		1 V/div	1 ns/div (Full BW)			$\geq 0.707$	

## Analog Bandwidth

## Performance checks

Bandwidth at							
Channel	Impedance	Vertical scale	Horizontal scale	$V_{in-pp}$	$V_{bw-pp}$	Limit	Test result Gain = $V_{bw-pp}/V_{in-pp}$
<b>All Models</b>							
Channel 2	50 $\Omega$	1 mV/div	5 ns/div (175 MHz)			$\geq 0.707$	
		2 mV/div	2.5 ns/div (350 MHz)			$\geq 0.707$	
		5 mV/div	1 ns/div (Full BW)			$\geq 0.707$	
		10 mV/div	1 ns/div (Full BW)			$\geq 0.707$	
		50 mV/div	1 ns/div (Full BW)			$\geq 0.707$	
		100 mV/div	1 ns/div (Full BW)			$\geq 0.707$	
		1 V/div	1 ns/div (Full BW)			$\geq 0.707$	
<b>MSO5204, DPO5204, MSO5104, DPO5104 Only</b>							
Channel 2	1 M $\Omega$	1 mV/div	5 ns/div (175 MHz)			$\geq 0.707$	
		2 mV/div	2.5 ns/div (350 MHz)			$\geq 0.707$	
		5 mV/div	1 ns/div (Full BW)			$\geq 0.707$	
		10 mV/div	1 ns/div (Full BW)			$\geq 0.707$	
		50 mV/div	1 ns/div (Full BW)			$\geq 0.707$	
		100 mV/div	1 ns/div (Full BW)			$\geq 0.707$	
		1 V/div	1 ns/div (Full BW)			$\geq 0.707$	

## Analog Bandwidth

## Performance checks

Bandwidth at Channel	Impedance	Vertical scale	Horizontal scale	$V_{in-pp}$	$V_{bw-pp}$	Limit	Test result Gain = $V_{bw-pp}/V_{in-pp}$
<b>All Models</b>							
Channel 3	50 $\Omega$	1 mV/div	5 ns/div (175 MHz)			$\geq 0.707$	
		2 mV/div	2.5 ns/div (350 MHz)			$\geq 0.707$	
		5 mV/div	1 ns/div (Full BW)			$\geq 0.707$	
		10 mV/div	1 ns/div (Full BW)			$\geq 0.707$	
		50 mV/div	1 ns/div (Full BW)			$\geq 0.707$	
		100 mV/div	1 ns/div (Full BW)			$\geq 0.707$	
		1 V/div	1 ns/div (Full BW)			$\geq 0.707$	
<b>MSO5204, DPO5204, MSO5104, DPO5104 Only</b>							
Channel 3	1 M $\Omega$	1 mV/div	5 ns/div (175 MHz)			$\geq 0.707$	
		2 mV/div	2.5 ns/div (350 MHz)			$\geq 0.707$	
		5 mV/div	1 ns/div (Full BW)			$\geq 0.707$	
		10 mV/div	1 ns/div (Full BW)			$\geq 0.707$	
		50 mV/div	1 ns/div (Full BW)			$\geq 0.707$	
		100 mV/div	1 ns/div (Full BW)			$\geq 0.707$	
		1 V/div	1 ns/div (Full BW)			$\geq 0.707$	

## Analog Bandwidth

## Performance checks

Bandwidth at							
Channel	Impedance	Vertical scale	Horizontal scale	$V_{in-pp}$	$V_{bw-pp}$	Limit	Test result Gain = $V_{bw-pp}/V_{in-pp}$
<b>All Models</b>							
Channel 4	50 $\Omega$	1 mV/div	5 ns/div (175 MHz)			$\geq 0.707$	
		2 mV/div	2.5 ns/div (350 MHz)			$\geq 0.707$	
		5 mV/div	1 ns/div (Full BW)			$\geq 0.707$	
		10 mV/div	1 ns/div (Full BW)			$\geq 0.707$	
		50 mV/div	1 ns/div (Full BW)			$\geq 0.707$	
		100 mV/div	1 ns/div (Full BW)			$\geq 0.707$	
		1 V/div	1 ns/div (Full BW)			$\geq 0.707$	
<b>MSO5204, DPO5204, MSO5104, DPO5104 Only</b>							
Channel 4	1 M $\Omega$	1 mV/div	5 ns/div (175 MHz)			$\geq 0.707$	
		2 mV/div	2.5 ns/div (350 MHz)			$\geq 0.707$	
		5 mV/div	1 ns/div (Full BW)			$\geq 0.707$	
		10 mV/div	1 ns/div (Full BW)			$\geq 0.707$	
		50 mV/div	1 ns/div (Full BW)			$\geq 0.707$	
		100 mV/div	1 ns/div (Full BW)			$\geq 0.707$	
		1 V/div	1 ns/div (Full BW)			$\geq 0.707$	

## Random Noise, Sample Acquisition Mode

Performance checks		Vertical sensitivity = 100 mV/div			
		1 M $\Omega$		50 $\Omega$	
	Bandwidth	Test result (mV)	High limit (mV)	Test result (mV)	High limit (mV)
<b>MSO5204, DPO5204</b>					
Channel 1	Full		8.18		6.15
	250 MHz limit		5.12		4.08
	20 MHz limit		5.12		4.08
Channel 2	Full		8.18		6.15
	250 MHz limit		5.12		4.08
	20 MHz limit		5.12		4.08
Channel 3	Full		8.18		6.15
	250 MHz limit		5.12		4.08
	20 MHz limit		5.12		4.08
Channel 4	Full		8.18		6.15
	250 MHz limit		5.12		4.08
	20 MHz limit		5.12		4.08
<b>MSO5104, DPO5104</b>					
Channel 1	Full		8.15		6.08
	250 MHz limit		5.10		4.05
	20 MHz limit		5.10		4.05
Channel 2	Full		8.15		6.08
	250 MHz limit		5.10		4.05
	20 MHz limit		5.10		4.05
Channel 3	Full		8.15		6.08
	250 MHz limit		5.10		4.05
	20 MHz limit		5.10		4.05
Channel 4	Full		8.15		6.08
	250 MHz limit		5.10		4.05
	20 MHz limit		5.10		4.05

**Random Noise, Sample Acquisition Mode**

Performance checks		Vertical sensitivity = 100 mV/div			
		1 M $\Omega$		50 $\Omega$	
	Bandwidth	Test result (mV)	High limit (mV)	Test result (mV)	High limit (mV)
<b>MSO5034, DPO5034, MSO5054, DPO5054</b>					
Channel 1	Full		8.13		8.13
	250 MHz limit		6.10		6.10
	20 MHz limit		4.10		4.10
Channel 2	Full		8.13		8.13
	250 MHz limit		6.10		6.10
	20 MHz limit		4.10		4.10
Channel 3	Full		8.13		8.13
	250 MHz limit		6.10		6.10
	20 MHz limit		4.10		4.10
Channel 4	Full		8.13		8.13
	250 MHz limit		6.10		6.10
	20 MHz limit		4.10		4.10

**Sample Rate and Delay Time Accuracy**

Performance checks	Low limit	Test result	High limit
	-1 divisions		+1 divisions



## Delta Time Measurement Accuracy

## Performance checks

## Channel 1

**MSO/DPO = 4 ns/Div, Source freq = 240 MHz**

MSO/DPO V/Div	Source $V_{pp}$	Test result	High limit
5 mV	40 mV		120 ps
100 mV	800 mV		118 ps
500 mV	4 V		117 ps
1 V	4 V		122 ps

**MSO/DPO = 40 ns/Div, Source freq = 24 MHz**

1 mV	8 mV		708 ps
5 mV	40 mV		322 ps
100 mV	800 mV		236 ps
500 mV	4 V		233 ps
1 V	4 V		417 ps

**MSO/DPO = 400 ns/Div, Source freq = 2.4 MHz**

1 mV	8 mV		6.69 ns
5 mV	40 mV		3.01 ns
100 mV	800 mV		2.07 ns
500 mV	4 V		2.03 ns
1 V	4 V		4.02 ns

**MSO/DPO = 4  $\mu$ s/Div, Source freq = 240 kHz**

1 mV	8 mV		69.9 ns
5 mV	40 mV		30.1 ns
100 mV	800 mV		20.7 ns
500 mV	4 V		20.3 ns
1 V	4 V		40.2 ns

**MSO/DPO = 40  $\mu$ s/Div, Source freq = 24 kHz**

1 mV	8 mV		699 ns
5 mV	40 mV		301 ns
100 mV	800 mV		207 ns
500 mV	4 V		203 ns
1 V	4 V		402 ns

**MSO/DPO = 400  $\mu$ s/Div, Source freq = 2.4 kHz**

1 mV	8 mV		6.99 $\mu$ s
5 mV	40 mV		3.01 $\mu$ s
100 mV	800 mV		2.07 $\mu$ s
500 mV	4 V		2.03 $\mu$ s
1 V	4 V		4.02 $\mu$ s

**Delta Time Measurement Accuracy**

**Channel 2**

**MSO/DPO = 4 ns/Div, Source freq = 240 MHz**

MSO/DPO V/Div	Source V <sub>pp</sub>	Test result	High limit
5 mV	40 mV		120 ps
100 mV	800 mV		118 ps
500 mV	4 V		117 ps
1 V	4 V		122 ps

**MSO/DPO = 40 ns/Div, Source freq = 24 MHz**

1 mV	8 mV		708 ps
5 mV	40 mV		322 ps
100 mV	800 mV		236 ps
500 mV	4 V		233 ps
1 V	4 V		417 ps

**MSO/DPO = 400 ns/Div, Source freq = 2.4 MHz**

1 mV	8 mV		6.99 ns
5 mV	40 mV		3.01 ns
100 mV	800 mV		2.07 ns
500 mV	4 V		2.03 ns
1 V	4 V		4.02 ns

**MSO/DPO = 4 μs/Div, Source freq = 240 kHz**

1 mV	8 mV		69.9 ns
5 mV	40 mV		30.1 ns
100 mV	800 mV		20.7 ns
500 mV	4 V		20.3 ns
1 V	4 V		40.2 ns

**MSO/DPO = 40 μs/Div, Source freq = 24 kHz**

1 mV	8 mV		699 ns
5 mV	40 mV		301 ns
100 mV	800 mV		207 ns
500 mV	4 V		203 ns
1 V	4 V		402 ns

**MSO/DPO = 400 μs/Div, Source freq = 2.4 kHz**

1 mV	8 mV		6.99 μs
5 mV	40 mV		3.01 μs
100 mV	800 mV		2.07 μs
500 mV	4 V		2.03 μs
1 V	4 V		4.02 μs

## Delta Time Measurement Accuracy

## Channel 3

**MSO/DPO = 4 ns/Div, Source freq = 240 MHz**

MSO/DPO V/Div	Source V <sub>pp</sub>	Test result	High limit
5 mV	40 mV		120 ps
100 mV	800 mV		118 ps
500 mV	4 V		117 ps
1 V	4 V		122 ps

**MSO/DPO = 40 ns/Div, Source freq = 24 MHz**

1 mV	8 mV		708 ps
5 mV	40 mV		322 ps
100 mV	800 mV		236 ps
500 mV	4 V		233 ps
1 V	4 V		417 ps

**MSO/DPO = 400 ns/Div, Source freq = 2.4 MHz**

1 mV	8 mV		6.99 ns
5 mV	40 mV		3.01 ns
100 mV	800 mV		2.07 ns
500 mV	4 V		2.03 ns
1 V	4 V		4.02 ns

**MSO/DPO = 4 μs/Div, Source freq = 240 kHz**

1 mV	8 mV		69.9 ns
5 mV	40 mV		30.1 ns
100 mV	800 mV		20.7 ns
500 mV	4 V		20.3 ns
1 V	4 V		40.2 ns

**MSO/DPO = 40 μs/Div, Source freq = 24 kHz**

1 mV	8 mV		699 ns
5 mV	40 mV		301 ns
100 mV	800 mV		207 ns
500 mV	4 V		203 ns
1 V	4 V		402 ns

**MSO/DPO = 400 μs/Div, Source freq = 2.4 kHz**

1 mV	8 mV		6.99 μs
5 mV	40 mV		3.01 μs
100 mV	800 mV		2.07 μs
500 mV	4 V		2.03 μs
1 V	4 V		4.02 μs

**Delta Time Measurement Accuracy**

**Channel 4**

**MSO/DPO = 4 ns/Div, Source freq = 240 MHz**

MSO/DPO V/Div	Source V <sub>pp</sub>	Test result	High limit
5 mV	40 mV		120 ps
100 mV	800 mV		118 ps
500 mV	4 V		117 ps
1 V	4 V		122 ps

**MSO/DPO = 40 ns/Div, Source freq = 24 MHz**

1 mV	8 mV		708 ps
5 mV	40 mV		322 ps
100 mV	800 mV		236 ps
500 mV	4 V		233 ps
1 V	4 V		417 ps

**MSO/DPO = 400 ns/Div, Source freq = 2.4 MHz**

1 mV	8 mV		6.99 ns
5 mV	40 mV		3.01 ns
100 mV	800 mV		2.07 ns
500 mV	4 V		2.03 ns
1 V	4 V		4.02 ns

**MSO/DPO = 4 μs/Div, Source freq = 240 kHz**

1 mV	8 mV		69.9 ns
5 mV	40 mV		30.1 ns
100 mV	800 mV		20.7 ns
500 mV	4 V		20.3 ns
1 V	4 V		40.2 ns

**MSO/DPO = 40 μs/Div, Source freq = 24 kHz**

1 mV	8 mV		699 ns
5 mV	40 mV		301 ns
100 mV	800 mV		207 ns
500 mV	4 V		203 ns
1 V	4 V		402 ns

**MSO/DPO = 400 μs/Div, Source freq = 2.4 kHz**

1 mV	8 mV		6.99μs
5 mV	40 mV		3.01μs
100 mV	800 mV		2.07 μs
500 mV	4 V		2.03 μs
1 V	4 V		4.02 μs

## Digital Threshold Accuracy, MSO5000 series only

## Performance checks:

Digital channel	Threshold	$V_{s-}$	$V_{s+}$	Low limit	Test result	High limit
D0	0 V			-0.1 V		0.1 V
	4 V			3.88 V		4.12 V
D1	0 V			-0.1 V		0.1 V
	4 V			3.88 V		4.12 V
D2	0 V			-0.1 V		0.1 V
	4 V			3.88 V		4.12 V
D3	0 V			-0.1 V		0.1 V
	4 V			3.88 V		4.12 V
D4	0 V			-0.1 V		0.1 V
	4 V			3.88 V		4.12 V
D5	0 V			-0.1 V		0.1 V
	4 V			3.88 V		4.12 V
D6	0 V			-0.1 V		0.1 V
	4 V			3.88 V		4.12 V
D7	0 V			-0.1 V		0.1 V
	4 V			3.88 V		4.12 V
D8	0 V			-0.1 V		0.1 V
	4 V			3.88 V		4.12 V
D9	0 V			-0.1 V		0.1 V
	4 V			3.88 V		4.12 V
D10	0 V			-0.1 V		0.1 V
	4 V			3.88 V		4.12 V
D11	0 V			-0.1 V		0.1 V
	4 V			3.88 V		4.12 V
D12	0 V			-0.1 V		0.1 V
	4 V			3.88 V		4.12 V
D13	0 V			-0.1 V		0.1 V
	4 V			3.88 V		4.12 V
D14	0 V			-0.1 V		0.1 V
	4 V			3.88 V		4.12 V
D15	0 V			-0.1 V		0.1 V
	4 V			3.88 V		4.12 V

**Auxiliary (Trigger) Output**

Performance checks		Low limit	Test result	High limit
Trigger Output	High 1 M $\Omega$	$\geq 2.5$ V		-
	Low 1 M $\Omega$	-		$\leq 0.7$ V
Trigger Output	High 50 $\Omega$	$\geq 1.0$ V		-
	Low 50 $\Omega$	-		$\leq 0.25$ V

## Performance Tests (MSO/DPO5000 Series)

This section contains a collection of manual procedures for checking that the instrument performs as warranted. They check all the characteristics that are designated as checked in *Specifications*. (The characteristics that are checked appear with a ✓ in *Specifications*).

### Prerequisites

The tests in this section comprise an extensive, valid confirmation of performance and functionality when the following requirements are met:

- The cabinet must be installed on the instrument.
- You must have performed and passed the procedures under *Self Test*. (See page 4-26, *Self Test*.)
- A signal-path compensation must have been done within the recommended calibration interval and at a temperature within  $\pm 5$  °C ( $\pm 9$  °F) of the present operating temperature. (If at the time you did the prerequisite *Self Test*, the temperature was within the limits just stated, consider this prerequisite met). A signal-path compensation must have been done at an ambient humidity within 25% of the current ambient humidity and after having been at that humidity for at least 4 hours.
- The instrument must have been last adjusted at an ambient temperature between +18 °C (+64 °F) and +28 °C (+82 °F), must have been operating for a warm-up period of at least 20 minutes, and must be operating at an ambient temperature as listed in the specifications. (See Table 2-10 on page 2-17.) (The warm-up requirement is usually met in the course of meeting the *Self Test* prerequisites listed above).
- Support sensor, probe, and adapter setups to avoid stress or torque when connected to the device under test (DUT).

## Self Test

This procedure verifies that the instrument passes the internal diagnostics and performs signal path compensation. No test equipment or hookups are required.

Equipment required	Prerequisites
None	Power on the instrument and allow a 20 minute warm-up period before performing this procedure.

1. *Run the System Diagnostics (may take several minutes):*
  - a. Ensure that an optical mouse is installed on one of the USB connectors.
  - b. Disconnect everything from the oscilloscope inputs.
  - c. If the instrument is in toolbar mode, put the instrument into menu bar mode by clicking on the down arrow at the top of the display.
  - d. Pull down the **Utilities** menu and select **Instrument Diagnostics**. This displays the diagnostics control window.
  - e. Click the **Run** button in the diagnostics control window.
  - f. Wait. The internal diagnostics perform an exhaustive verification of proper instrument function. This verification may take several minutes. When the verification is finished, the resulting status will appear in the diagnostics control window
  - g. Verify that the status of all tests on the readout is **Pass**.
2. *Run the signal-path compensation routine (may take 5 to 15 minutes):*
  - a. Pull down the **Utilities** menu and select **Instrument Calibration**. This displays the instrument calibration control window. If required because the instrument is in service mode, select the **Signal Path** button under Calibration Area.
  - b. Click the **Run SPC** button to start the routine.
  - c. Wait. Signal-path compensation may take 5 to 15 minutes to run.
  - d. Verify that the **SPC Status** is **Pass** and that the **Temperature Status** is Ready.
3. *Return to regular service:* Click the **X** (close) button to exit the instrument calibration control window.



## Check Input Impedance (Resistance)

This test checks the Input Impedance.

1. Connect the output of the oscilloscope calibrator (for example, Fluke 9500) to the oscilloscope channel 1 input, as shown in the following illustration.

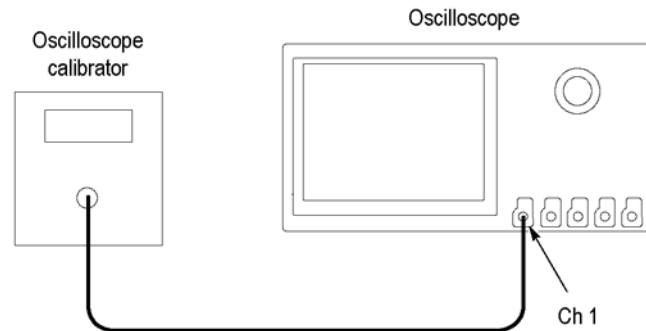

**WARNING.** The generator is capable of providing dangerous voltages. Be sure to set the generator to off or 0 volts before connecting, disconnecting, and/or moving the test hookup during the performance of this procedure.

2. Push the front-panel **Default Setup** button.
3. Set the impedance to 1 M $\Omega$  as follows:
  - a. Set the calibrator impedance to 1 M $\Omega$ .
  - b. Push the front-panel Vertical **Menu** button.
  - c. Set the **Termination** to 1 M $\Omega$ .
4. Set the Vertical **Scale** to 10 mV/div.
5. Use the calibrator to measure the input impedance of the oscilloscope and enter the value in the test record.
6. Repeat steps 4 and 5 for all vertical scale settings in the test record.
7. Repeat the tests at 250 k $\Omega$  as follows:
  - a. Set the calibrator impedance to 1 M $\Omega$ .
  - b. In the toolbar, click the **Utilities** menu and select **Instrument Diagnostics**.
  - c. Click the on-screen **Manual Product Verification** button.
  - d. Click the on-screen box to Verify the probe host terminations.
  - e. Set the Vertical **Scale** to 100 mV/division.
  - f. Use the calibrator to measure the input impedance of the oscilloscope and enter the value in the test record.

8. *Repeat the tests at 50  $\Omega$  as follows:*
  - a. Set the calibrator impedance to 50  $\Omega$ .
  - b. Push the front-panel oscilloscope Vertical **Menu** button.
  - c. Set the **Termination** to **50  $\Omega$** .
  - d. Repeat steps 4 through 6.
9. *Repeat the procedure for all remaining channels as follows:*
  - a. Push the front-panel button to deselect the channel that you have already tested.
  - b. Push the front-panel button to select the next channel to be tested.
  - c. Move the calibrator connection to the next channel to be tested.
  - d. Starting from step 3, repeat the procedure until all channels have been tested.
10. Press the **Menu Off** button.

## Check DC Balance

This test checks the DC balance. You do not need to connect any test equipment (other than the 50  $\Omega$  terminator) to the oscilloscope to perform this check.

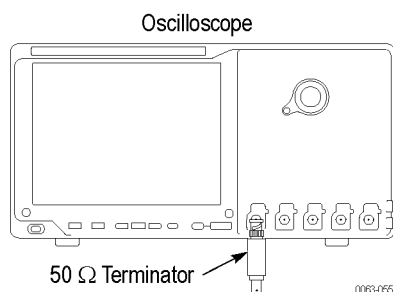

1. Attach a 50  $\Omega$  terminator to the oscilloscope channel 1 input.
2. Push the front-panel **Default Setup** button.
3. *Set the oscilloscope impedance to 50  $\Omega$  as follows:*
  - a. Push the front-panel oscilloscope Vertical **Menu** button.
  - b. Set the **Termination** to **50  $\Omega$** .
4. Set the **Bandwidth** to **20 MHz**
5. Set the Horizontal **Scale** to **1 ms/division**.

6. *Set the Acquisition mode to Average as follows:*
  - a. Push the front-panel **Acquire** button.
  - b. In the Acquisition window, select the **Acquisition** tab at the left.
  - c. Select **Average** Acquisition mode.
  - d. Ensure that the **number of averages** is set to **16**.
7. *Set the trigger source to AC line as follows:*
  - a. Push the front-panel Trigger **Menu** button.
  - b. In the Trigger menu, under **Source**, click **Select**.
  - c. Click **Line** to set the trigger source to AC line, and then click **OK**.
8. Set the Vertical **Scale** to **1 mV**.
9. *Select the mean measurement (if not already selected) as follows:*
  - a. Push the front-panel Wave Inspector **Measure** button.
  - b. In the Measurements Setup window, go to the **Measurements** box. Click the **More** button and then select **Mean**.
  - c. View the **Mean** measurement value in the display.
10. Enter the mean value as the test result in the test record.
11. Repeat steps 8 through 10 for each vertical scale setting in the test record.
12. Repeat steps 4 through 11 for each bandwidth setting in the test record table.
13. *Repeat the tests at 1 M $\Omega$  impedance as follows:*
  - a. Push the front-panel Vertical **Menu** button.
  - b. Set the **Termination** to **1M  $\Omega$** .
  - c. Repeat steps 4 through 12.
14. *Repeat the procedure for all remaining channels as follows:*
  - a. Push the front-panel button to deselect the channel that you have already tested.
  - b. Push the front-panel button to select the next channel to be tested.
  - c. Move the 50  $\Omega$  terminator to the channel input to be tested.
  - d. Starting from step 3, repeat the procedure until all channels have been tested.
15. Press the **Menu Off** button.

## Check DC Gain Accuracy

This test checks the DC gain accuracy.

1. Connect the oscilloscope to a DC voltage source. If you are using the Fluke 9500 calibrator, connect the calibrator head to the oscilloscope channel to test.

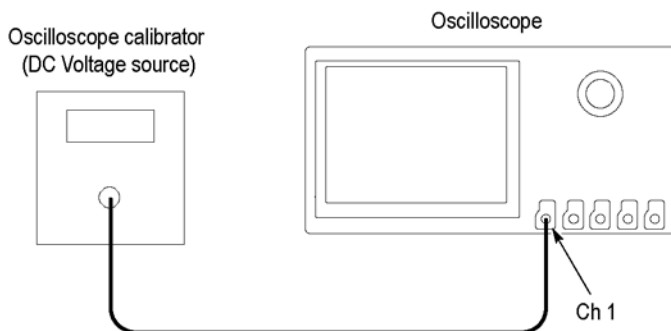

**WARNING.** The generator is capable of providing dangerous voltages. Be sure to set the generator to off or 0 volts before connecting, disconnecting, and/or moving the test hookup during the performance of this procedure.

2. Push the front-panel **Default Setup** button.
3. Set the input impedance to 50  $\Omega$  as follows:
  - a. Set the calibrator to 50  $\Omega$  output impedance.
  - b. Push the front-panel oscilloscope Vertical **Menu** button.
  - c. Set the **Termination** to **50  $\Omega$** .
4. Set the **Bandwidth** to **20 MHz**.
5. Set the Acquisition mode to Average as follows:
  - a. Push the front-panel **Acquire** button.
  - b. In the Acquisition window, select the **Acquisition** tab at the left.
  - c. Select **Average** Acquisition mode.
  - d. Ensure that the **number of averages** is set to **16**.
6. Set the trigger source to AC line as follows:
  - a. Push the Trigger **Menu** front-panel button.
  - b. In the Trigger menu, under **Source**, click **Select**.
  - c. Click **Line** to set the trigger source to AC line, and then click **OK**.
7. Set the Vertical **Scale** to **1 mV/division**.

8. *Record the negative-measured and positive-measured mean readings in the worksheet as follows:*
  - a. Set the DC Voltage Source to  $V_{\text{negative}}$ .
  - b. Push the front-panel Wave Inspector **Measure** button.
  - c. In the Measurements Setup window, go to the **Measurements** box. Click the **More** button and then select **Mean**.
  - d. View the **Mean** measurement value in the display.
  - e. In the Measurement Setup window, select **Statistics**.
  - f. Click **Reset**.
  - g. Enter the mean reading in the worksheet as  $V_{\text{negative-measured}}$ . (See Table 4-2 on page 4-32.)
  - h. Set the DC Voltage Source to  $V_{\text{positive}}$ .
  - i. Click **Reset** again.
  - j. Enter the mean reading in the worksheet as  $V_{\text{positive-measured}}$ .

Table 4-2: Gain expected worksheet

Oscilloscope Vertical Scale Setting	$V_{diffExpected}$	$V_{negative}$	$V_{positive}$	$V_{negative-measured}$	$V_{positive-measured}$	$V_{diff}$	Test Result (Gain Accuracy)
1 mV/div	9 mV	-4.5 mV	+4.5 mV				
2 mV/div	18 mV	-9 mV	+9 mV				
4.98 mV	44.82 mV	-22.41 mV	+22.41 mV				
5 mV	45 mV	-22.5 mV	+22.5 mV				
10 mV	90 mV	-45 mV	+45 mV				
20 mV	180 mV	-90 mV	+90 mV				
49.8 mV	448.2 mV	-224.1 mV	+224.1 mV				
50 mV	450 mV	-225 mV	+225 mV				
100 mV	900 mV	-450 mV	+450 mV				
200 mV	1800 mV	-900 mV	+900 mV				
500 mV	4900 mV	-2450 mV	+2450 mV				
1.0 V	9000 mV	-4500 mV	+4500 mV				

9. Record Gain Accuracy as follows:

- a. Calculate  $V_{diff}$  as follows:

$$V_{diff} = | V_{negative-measured} - V_{positive-measured} |$$

- b. Enter  $V_{diff}$  in the worksheet. (See Table 4-2 on page 4-32.)

- c. Calculate Gain Accuracy as follows:

$$Gain\ Accuracy = ((V_{diff} - V_{diffExpected}) / V_{diffExpected}) \geq 100\%$$

- d. Enter Gain Accuracy in the worksheet and in the test record.

10. Repeat tests at 1 M $\Omega$  impedance as follows:

- Set the calibrator to 1 M $\Omega$  output.
- Push the front-panel Vertical **Menu** button.
- Set the **Termination** to 1 M $\Omega$
- Repeat steps 8 through 9.

11. Repeat steps 7 through 10 for all vertical scale settings in the test record.

12. Repeat the procedure for all remaining channels:
  - a. Push the front-panel button to deselect the channel that you have already tested.
  - b. Push the front-panel button to select the next channel to be tested.
  - c. Move the DC voltage source connection to the channel input to be tested.
  - d. Starting from step 3, repeat the procedure until all channels have been tested.
13. Press the **Menu Off** button.

## Check Offset Accuracy

This test checks the offset accuracy.

1. Connect the oscilloscope to a DC voltage source. If you are using the Fluke 9500 calibrator as the DC voltage source, connect the calibrator head to the oscilloscope channel 1.

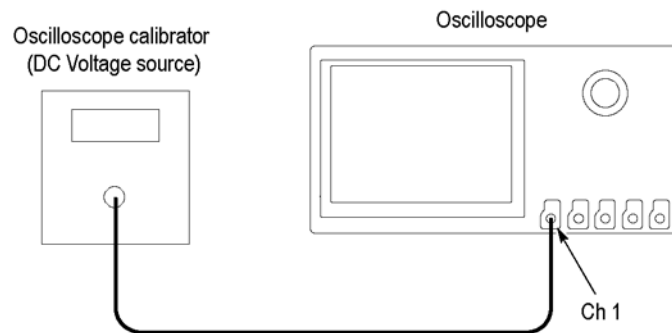

**WARNING.** *The generator is capable of providing dangerous voltages. Be sure to set the generator to off or 0 volts before connecting, disconnecting, and/or moving the test hookup during the performance of this procedure.*

2. Push the front-panel **Default Setup** button.
3. Set the impedance to 50  $\Omega$  as follows:
  - a. Set the calibrator to 50  $\Omega$  output impedance.
  - b. Push the front-panel oscilloscope Vertical **Menu** button.
  - c. Set the **Termination** to **50  $\Omega$** .
4. Set the calibrator to 900 mV, as shown in the test record.
5. Set the **Bandwidth** to **20 MHz**.

6. Set the Horizontal **Scale** to 1 ms/div.
7. Set the Vertical **Scale** to 1 mV/div.
8. In the Vertical menu, set the oscilloscope **Vertical Offset** to 900 mV.
9. Check that the vertical position is set to 0 divisions. If it is not, turn the Vertical **Position** knob to set the position to 0.
10. *Set the Acquisition mode to Average as follows:*
  - a. Push the front-panel **Acquire** button.
  - b. In the Acquisition window, select the **Acquisition** tab at the left.
  - c. Click **Average** Acquisition mode.
  - d. Ensure that the **number of averages** is set to **16**.
11. *Set the trigger source to AC line as follows:*
  - a. Push the Trigger **Menu** front-panel button.
  - b. In the Trigger menu, under **Source**, click **Select**.
  - c. Click **Line** to set the trigger source to AC line, and then click **OK**.
12. *Select the mean measurement as follows:*
  - a. Push the front-panel Wave Inspector **Measure** button.
  - b. In the Measurements Setup window, go to the **Measurements** box. Click the **More** button and then select **Mean**.
  - c. View the **Mean** measurement value in the display.
13. Enter the mean value as the test result in the test record.
14. Repeat step 13 for each vertical scale and vertical offset setting shown in the test record.
15. *Repeat the tests at 1 M $\Omega$  impedance as follows:*
  - a. Change the calibrator impedance to 1 M $\Omega$ .
  - b. Push the front-panel Vertical **Menu** button.
  - c. Set the **Termination** to **1 M $\Omega$** .
  - d. Repeat steps 4 through 14.



16. Repeat the procedure for all remaining channels as follows:
  - a. Push the front-panel button to deselect the channel that you have already tested.
  - b. Push the front-panel button to select the next channel to be tested.
  - c. Move the DC voltage source connection to the channel input to be tested.
  - d. Starting from step 3, repeat the procedure until all channels have been tested.
17. Press the **Menu Off** button.

## Check Analog Bandwidth

This test checks the bandwidth at  $50\ \Omega$  and  $1\ \text{M}\ \Omega$  for each channel.

1. Connect the output of the leveled sine wave generator (for example, Fluke 9500) to the oscilloscope channel 1 input as shown in the following illustration.

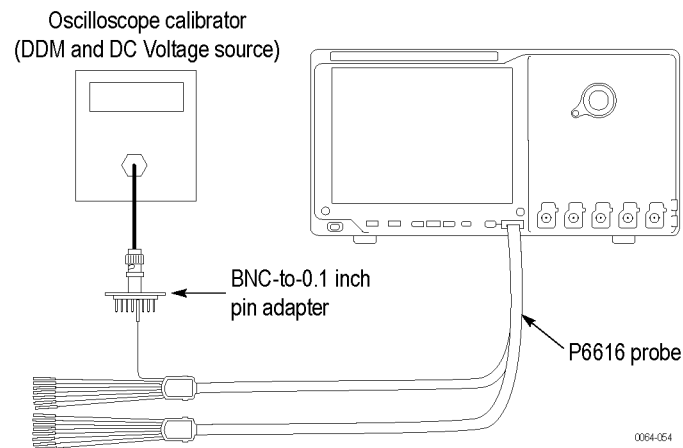

**WARNING.** The generator is capable of providing dangerous voltages. Be sure to set the generator to off or 0 volts before connecting, disconnecting, and/or moving the test hookup during the performance of this procedure.

3. Push the front-panel **Default Setup** button.
4. Set the impedance to  $50\ \Omega$  as follows:
  - a. Set the calibrator to  $50\ \Omega$  output impedance, and to generate a sine wave.
  - b. Push the front-panel oscilloscope Vertical **Menu** button.
  - c. Under **Termination**, click  **$50\ \Omega$** .

5. Set the Vertical **Scale** to **1 mV**.
6. *Set the Acquisition mode to Sample as follows:*
  - a. Push the front-panel **Acquire** button.
  - b. In the Acquisition window, select the **Acquisition** tab at the left.
  - c. Click **Sample** Acquisition mode.
7. Adjust the signal source to at least 8 vertical divisions at the selected vertical scale with a set frequency of 50 kHz. For example, at 5 mV/div, use a  $\geq 40$  mV<sub>p-p</sub> signal, at 2 mV/div, use a  $\geq 16$  mV<sub>p-p</sub> signal, and at 1 mV/div, use a  $\geq 8$  mV<sub>p-p</sub> signal. Use a sine wave for the signal source.
8. Set the Horizontal **Scale** to **1 ms/division**.
9. *Record the peak-to-peak measurement as follows:*
  - a. Push the front-panel Wave Inspector **Measure** button.
  - b. In the **Measurements** box, click **Pk-Pk**.
  - c. This will provide a mean  $V_{p-p}$  of the signal. Call this value  $V_{in-pp}$ .
  - d. Enter this value in the test record.
10. Set the Horizontal **Scale** to **5 ns/division**.
11. Adjust the signal source to the maximum bandwidth frequency for the bandwidth and model desired, as shown in the following worksheet.
12. *Record the peak-to-peak measurement as follows:*
  - a. With the **Pk-Pk** measurement still displayed from step 9, view the measurement at the new frequency.
  - b. This will provide a mean  $V_{p-p}$  of the signal. Call this value  $V_{bw-pp}$ .
  - c. Enter this value in the test record.

---

**NOTE.** For more information on the contents of this worksheet, refer to the bandwidth specifications. (See Table 2-1 on page 2-1.)

---

Table 4-3: Maximum bandwidth frequency worksheet

**Model: MSO5204, DPO5204**

Impedance	Vertical Scale	Maximum bandwidth
50 $\Omega$	10 mV/div — 1 V/div	500 MHz <sup>1</sup>
	5 mV/div	500 MHz <sup>1</sup>
	2 mV/div	350 MHz
	1 mV/div	175 MHz
1 M $\Omega$	5 mV/div — 1 V/div	500 MHz
	2 mV/div	350 MHz
	1 mV/div	175 MHz

**Model: MSO5104, DPO5104**

Impedance	Vertical Scale	Maximum bandwidth
50 $\Omega$	5 mV/div — 1 V/div	500 MHz <sup>1</sup>
	2 mV/div	350 MHz
	1 mV/div	175 MHz
1 M $\Omega$	5 mV/div — 1 V/div	500 MHz
	2 mV/div	350 MHz
	1 mV/div	175 MHz

**Model: MSO5054, DPO5054**

50 $\Omega$	5 mV/div — 1 V/div	500 MHz
	2 mV/div	350 MHz
	1 mV/div	175 MHz
1 M $\Omega$	5 mV/div — 1 V/div	500 MHz
	2 mV/div	350 MHz
	1 mV/div	175 MHz

**Model: MSO5034, DPO5034**

50 $\Omega$	2 mV/div — 1 V/div	350 MHz
	1 mV/div	175 MHz
1 M $\Omega$	5 mV/div — 1 V/div	350 MHz
	2 mV/div	350 MHz
	1 mV/div	175 MHz

<sup>1</sup> For DPO5204, MSO5204, DPO5104, and MSO5104 bandwidth performance verification, use 500 MHz on the 10 mV/div and 5 mV/div vertical scale.

14. Use the values of  $V_{bw-pp}$  and  $V_{in-pp}$  stored in the test record to calculate the *Gain* at bandwidth with the following equation:

$$Gain = V_{bw-pp} / V_{in-pp}$$

To pass the performance measurement test, Gain should be  $\geq 0.707$ . Enter *Gain* in the test record.

15. Repeat steps 5 through 14 for all combinations of Vertical Scale and Horizontal Scale settings listed in the test record.
16. *For MSO/DPO5204 and MSO/DPO5104 models only, repeat the tests at 1 M $\Omega$  impedance as follows:*
  - a. Change the calibrator impedance to 1 M $\Omega$ .
  - b. Push the front-panel Vertical **Menu** button.
  - c. Set the **Termination** to 1 M $\Omega$ .
  - d. Repeat steps 5 through 15.
17. *Repeat the procedure for all remaining channels as follows:*
  - a. Push the front-panel button to deselect the channel that you have already tested.
  - b. Push the front-panel button to select the next channel to be tested.
  - c. Move the calibrator connection to the channel input to be tested.
  - d. Starting from step 4, repeat the procedure until all channels have been tested.
18. Press the **Menu Off** button.

## Check Random Noise, Sample Acquisition Mode

This test checks random noise at 50  $\Omega$  and 1 M  $\Omega$  for each channel. You do not need to connect any test equipment to the oscilloscope for this test.

1. Disconnect everything from the oscilloscope inputs.
2. Push the front-panel **Default Setup** button.
3. *Turn Gating off as follows:*
  - a. Push the front-panel Wave Inspector **Measure** button.
  - b. In the Measurement Setup window, click the **More** button and then select **Gating**.
  - c. Ensure that **Off (Full Record)** is selected.
4. *Select the RMS measurement as follows:*
  - a. Push the front-panel Wave Inspector **Measure** button.
  - b. In the Measurement Setup window, select the **RMS** measurement.
  - c. Ensure that the channel being tested is selected in the **Channels** box.

5. *Reset the Statistics as follows:*
  - a. Select **Statistics**.
  - b. Click **Reset**.
  - c. Click **OK**.
6. Read and make a note of the RMS Mean value. This is the Sampled Mean Value (SMV).
7. *Set the Acquisition mode to Average as follows:*
  - a. Push the front-panel **Acquire** button.
  - b. In the Acquisition window, select the **Acquisition** tab at the left.
  - c. Click to select **Average** Acquisition mode.
  - d. Ensure that the **number of averages** is set to **16**.
8. *Reset statistics as follows:*
  - a. Push the front-panel Wave Inspector **Measure** button.
  - b. In the Measurement Setup window, select **Statistics**.
  - c. Click **Reset**.
9. Read and make a note of the RMS Mean value. This is the Averaged Mean Value (AMV).
10. Calculate the RMS noise (RMS noise = SMV – AMV), and enter the calculated RMS noise in the test record.
11. *Set the Acquisition mode to Sample as follows:*
  - a. Push the front-panel **Acquire** button.
  - b. In the Acquisition window, select the **Acquisition** tab at the left.
  - c. Select the **Sample** Acquisition mode.
12. *Repeat the tests at 50  $\Omega$  as follows:*
  - a. Push the front-panel oscilloscope Vertical **Menu** button.
  - b. Set the **Termination** to **50  $\Omega$** .
  - c. Repeat steps 5 through 11.

13. Repeat the tests at all bandwidth settings as follows:
  - a. Push the front-panel oscilloscope Vertical **Menu** button.
  - b. Set the **Termination** to **1M  $\Omega$** .
  - c. Select the next **Bandwidth** at which to test.
  - d. Starting at step 5, repeat the procedure for each bandwidth setting in the test record.
14. Press the **Menu Off** button.

## Check Sample Rate and Delay Time Accuracy

This test checks the sample rate and delay time accuracy (time base).

1. Connect the output of a time mark generator to the oscilloscope channel 1 input using a 50  $\Omega$  cable, as shown in the following illustration.

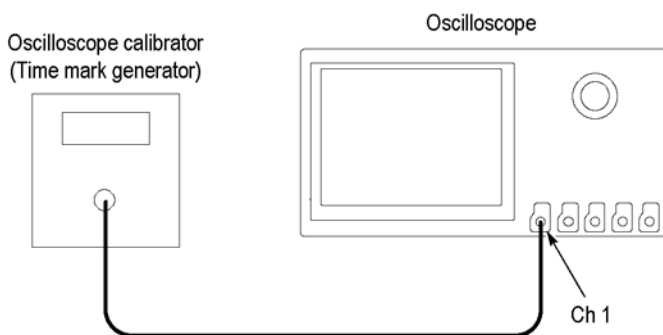

**WARNING.** The generator is capable of providing dangerous voltages. Be sure to set the generator to off or 0 volts before connecting, disconnecting, and/or moving the test hookup during the performance of this procedure.

2. Set the time mark generator period to **80 ms**. Use a time mark waveform with a fast rising edge.
3. Push the front-panel **Default Setup** button.
4. Set the impedance to 50  $\Omega$  as follows:
  - a. Push the front-panel oscilloscope Vertical **Menu** button.
  - b. Set the **Termination** to **50  $\Omega$** .
5. If it is adjustable, set the time mark amplitude to approximately **1 V<sub>p-p</sub>**.
6. Set the Vertical **Scale** to **500 mV**.
7. Set the Horizontal **Scale** to **20 ms/div**.

8. Set the Vertical **Position** to center the time mark signal on the screen.
9. Set the **Trigger Level** as necessary for a triggered display.
10. Adjust the Horizontal **Position** to move the trigger location to the center of the screen (50%).
11. *Set the delay to 80 ms as follows:*
  - a. Push the front-panel **Acquire** button. Ensure that the **Horizontal** tab on the left side of the screen is selected.
  - b. Turn **Delay** on.
  - c. Turn the Horizontal **Position** knob clockwise (or click the Delay box and use the keypad) to set the delay to exactly **80 ms**.
12. Set the horizontal scale to **500 ns/div** using the Horizontal **Scale** knob or by clicking in the Scale box and using the up/down arrows.
13. Compare the rising edge of the marker with the center horizontal graticule line. The rising edge should be within  $\pm 1$  divisions of center graticule. Enter the deviation in the test record.

---

**NOTE.** *One division of displacement from graticule center corresponds to a 5 ppm time base error.*

---

14. Press the **Menu Off** button.

## Check Delta Time Measurement Accuracy

This test checks the Delta-time measurement accuracy for a given instrument setting and input signal.

1. Connect a 50  $\Omega$  coaxial cable from the signal source to the oscilloscope channel 1, as shown in the following illustration.

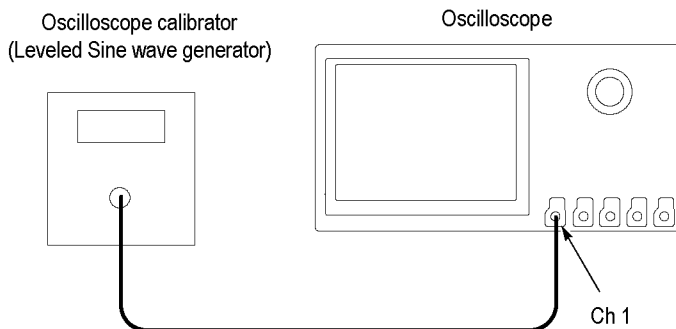

**WARNING.** The generator is capable of providing dangerous voltages. Be sure to set the generator to off or 0 volts before connecting, disconnecting, and/or moving the test hookup during the performance of this procedure.

2. Push the oscilloscope front-panel **Default Setup** button.
3. Set the Horizontal **Scale** to 4 ms/div as follows:
  - a. Turn the Horizontal **Scale** knob to set the time per division as close as you can to the desired setting. In this case, set the scale to 5 ms/div.
  - b. Push the front-panel **Acquire** button.
  - c. Select **Manual Mode**.
  - d. Click the **Record Length** field to bring up the onscreen keypad.
  - e. Reduce the record length to 80% of its original value (such that 1000 points is changed to 800 points). This will change the Horizontal **Scale** to the correct setting.
4. Set the Vertical **Scale** to 5 mV/div.
5. Set the impedance to 50  $\Omega$  as follows:
  - a. Set the sine wave generator output impedance to 50  $\Omega$ .
  - b. Push the front-panel oscilloscope Vertical **Menu** button.
  - c. Set the **Termination** to 50  $\Omega$ .



6. *Set the Mean & St Dev Samples to 1000 as follows:*
  - a. Push the Wave Inspector **Measure** button.
  - b. In the Measurements Setup window, select the **More** tab on the left.
  - c. Select the **Burst Width** measurement.
  - d. Select **Statistics**.
  - e. Click in the **Weight n=** box and set the value to 1000.
7. Set the signal source to 240 MHz and 40 mV as shown in the test record.

---

**NOTE.** *To provide consistent results, set the signal source frequency such that the zero crossing does not occur at the beginning or end of the record.*

---

8. *Reset statistics as follows:*
  - a. Push the front-panel Wave Inspector **Measure** button.
  - b. In the Measurement Setup window, select **Statistics**.
  - c. Click **Reset**.
  - d. Wait 5 or 10 seconds for the oscilloscope to acquire all of the samples before taking the reading.
9. *Check the oscilloscope performance as follows:*
  - a. Verify that the **St Dev** is less than the upper limit shown in the test record.
  - b. Enter the reading in the test record.
  - c. Repeat the check for each combination of oscilloscope and source signal settings in the test record, using the method in step 3 to change the Horizontal Scale settings.
10. *Repeat the tests at 1 M $\Omega$  as follows:*
  - a. Set the sine wave generator output impedance to 1 M $\Omega$ .
  - b. Push the front-panel oscilloscope Vertical **Menu** button.
  - c. Set the **Termination** to 1 M $\Omega$ .
  - d. Repeat steps 7 through 9 for each setting combination shown in the test record.

11. Repeat the procedure for all remaining channels as follows:
  - a. Push the front-panel button to deselect the channel that you have already tested.
  - b. Push the front-panel channel button for the next channel to be tested.
  - c. Connect the signal source to the input for that channel.
  - d. Repeat the procedure from step 5 until all channels have been tested.
12. Press the **Menu Off** button.

## Check Digital Threshold Accuracy (MSO5000 only)

For the MSO5000 series only, this test checks the threshold accuracy of the digital channels. This procedure applies to digital channels D0 through D15, and to channel threshold values of 0 V and +4 V.

1. Connect the P6616 digital probe to the MSO5000 series instrument.

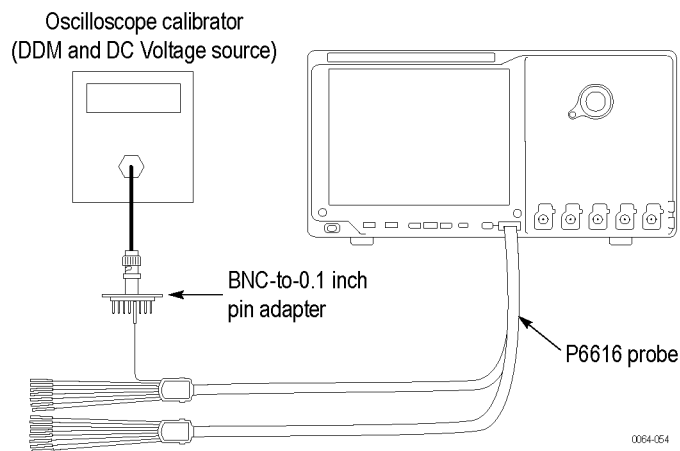

**WARNING.** The generator is capable of providing dangerous voltages. Be sure to set the generator to off or 0 volts before connecting, disconnecting, and/or moving the test hookup during the performance of this procedure.

2. Connect the DC voltage source to the digital channel D0.

If you are using the Fluke 9500 calibrator as the DC voltage source, connect the calibrator head to the digital channel D0, using the BNC-to-0.1 inch pin adapter listed in the Required Equipment table. (See Table 4-1 on page 4-1.) Be sure to connect channel D0 from the probe connector to both the corresponding signal pin and to a ground pin on the adapter.

3. Push the front-panel **Default Setup** button.

4. *Turn on the digital channels and set the thresholds as follows:*
  - a. Push the front-panel **D15-D0** button.
  - b. Select the **D7-D0** tab on the left and turn channels D7-D0 **On**.
  - c. Select the **D15-D8** tab and turn channels D15-D8 **On**.
  - d. The instrument will display the 16 digital channels.
  - e. Click in the **Global Threshold** box and set the value to **0.00 V**.
  - f. Click **Apply**.
  - g. All thresholds are now set for the 0 V threshold check.
5. Set the Horizontal Scale to 5  $\mu$ s/div.
6. *Set the source as follows:*
  - a. Push the front-panel **Trigger Menu** button.
  - b. Under **Source**, click **Select**.
  - c. In the Source Selection box, select **Ch D0**. Click **OK**.
7. Set the DC voltage source ( $V_s$ ) to -400 mV. Wait 3 seconds. Check the logic level of the channel D0 signal display. If it is at a static logic high, change the DC voltage source  $V_s$  to -500 mV.
8. Increment  $V_s$  by +10 mV. Wait 3 seconds and check the logic level of the channel D0 signal display. If it is a static logic high, record the  $V_s$  value as in the 0 V row of the test record.  
  
If the signal level is a logic low or is alternating between high and low, repeat this step (increment  $V_s$  by 10 mV, wait 3 seconds, and check for a static logic high) until a value for  $V_{s-}$  is found.
9. Click the lower **Slope** button to change the slope to **Falling**.
10. Set the DC voltage source ( $V_s$ ) to +400 mV. Wait 3 seconds. Check the logic level of the channel D0 signal display.  
  
If it is at a static logic low, change the DC voltage source  $V_s$  to +500 mV.
11. Reduce  $V_s$  by -10 mV. Wait 3 seconds and check the logic level of the channel D0 signal display. If it is a static logic low, record the  $V_s$  value as  $V_{s+}$  in the 0 V row of the test record.  
  
If the signal level is a logic high or is alternating between high and low, repeat this step (decrement  $V_s$  by 10 mV, wait 3 seconds, and check for a static logic low) until a value for  $V_{s+}$  is found.
12. Find the average using this formula:  $V_{sAvg} = (V_{s-} + V_{s+})/2$ . Record the average as the test result in the test record.

Compare the test result to the limits. If the result is between the limits, continue with the procedure to test the channel at the +4 V threshold value.

**13.** *Begin the +4 V threshold test as follows:*

- a. Push the front-panel **D15-D0** button.
- b. Set the **D0 Threshold** value to **4.00 V** (+4.0 V/div).

**14.** Set the DC voltage source ( $V_s$ ) to +4.4 V. Wait 3 seconds. Check the logic level of the channel D0 signal display.

If it is a static logic low, change the DC voltage source  $V_s$  to +4.5 V.

**15.** Decrement  $V_s$  by -10 mV. Wait 3 seconds and check the logic level of the channel D0 signal display. If it is a static logic low, record the  $V_s$  value as  $V_{s+}$  in the 4 V row of the test record.

If the signal level is a logic high or is alternating between high and low, repeat this step (decrement  $V_s$  by 10 mV, wait 3 seconds, and check for a static logic low) until a value for  $V_{s+}$  is found.

**16.** Push the front-panel **Trigger Menu** button.

**17.** Click the lower **Slope** button to change the slope to **Rising**.

**18.** Set the DC voltage source ( $V_s$ ) to +3.6 V. Wait 3 seconds. Check the logic level of the channel D0 signal display.

If the signal level is a static logic high, change the DC voltage source  $V_s$  to +3.5 V.

**19.** Increment  $V_s$  by +10 mV. Wait 3 seconds and check the logic level of the channel D0 signal display. If it is a static logic high, record the  $V_s$  value in the 4 V row of the test record.

If the signal level is a logic low or is alternating between high and low, repeat this step (increment  $V_s$  by 10 mV, wait 3 seconds, and check for a static logic high) until a value for  $V_{s-}$  is found.

**20.** Find the average using this formula:  $V_{sAvg} = (V_{s-} + V_{s+})/2$ . Record the average as the test result in the test record.

Compare the test result to the limits. If the result is between the limits, the channel passes the test.

21. Repeat the procedure for all remaining digital channels as follows:
  - a. Push the front-panel **Trigger Menu** button.
  - b. Under **Source**, click **Select**.
  - c. In the Source Selection box, select the next digital channel (such as D1) to be tested.
  - d. Connect the DC voltage source to the digital channel to be tested.
  - e. Starting from step 7, repeat the procedure until all 16 digital channels have been tested.
22. Press the **Menu Off** button.

## Check Trigger Out

This test checks the Trigger Output.

1. Connect the Trigger Out signal from the rear of the instrument to the channel 1 input using a 50  $\Omega$  cable, as shown in the following illustration.

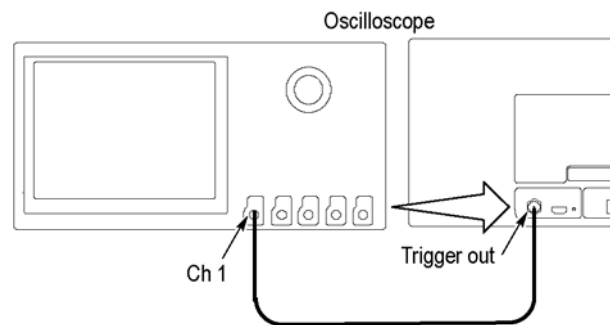

2. Push the front-panel **Default Setup** button.
3. Set the Vertical **Scale** to **1 V/div**.

4. *Record the Low and High measurements at 1 M $\Omega$  as follows:*
  - a. Push the front-panel Wave Inspector **Measure** button.
  - b. Ensure that the **Amplitude** tab is selected.
  - c. Select the **Low** measurement.
  - d. Enter the Low measurement reading in the test record.
  - e. Select the **High** measurement.
  - f. Enter the High measurement reading in the test record.
5. *Record the Low and High measurements at 50  $\Omega$  as follows:*
  - a. Push the front-panel oscilloscope Vertical **Menu** button.
  - b. Set the **Termination** to **50  $\Omega$** .
  - c. Push the front-panel Wave Inspector **Measure** button.
  - d. Ensure that the **Amplitude** tab is selected.
  - e. Select the **Low** measurement.
  - f. Enter the Low measurement reading in the test record.
  - g. Select the **High** measurement.
  - h. Enter the High measurement reading in the test record.

This completes the performance verification procedure.