



**TekExpress® PCI Express  
Transmitter Compliance and Testing Solution Software  
Printable Application Help**







**TekExpress® PCI Express  
Transmitter Compliance and Testing Solution Software  
Printable Application Help**

Copyright © Tektronix. All rights reserved. Licensed software products are owned by Tektronix or its subsidiaries or suppliers, and are protected by national copyright laws and international treaty provisions. Tektronix products are covered by U.S. and foreign patents, issued and pending. Information in this publication supersedes that in all previously published material. Specifications and price change privileges reserved.

TEKTRONIX and TEK are registered trademarks of Tektronix, Inc.

### **Contacting Tektronix**

Tektronix, Inc.  
14150 SW Karl Braun Drive  
P.O. Box 500  
Beaverton, OR 97077  
USA

For product information, sales, service, and technical support:

- In North America, call 1-800-833-9200.
- Worldwide, visit [www.tek.com](http://www.tek.com) to find contacts in your area.

---

# Table of Contents

Welcome .....	v
---------------	---

## Getting help and support

Related documentation .....	1
Conventions used in help .....	2
Technical support .....	2

## Getting started

Minimum system requirements .....	3
Instruments and accessories required .....	4
Windows 7 user account settings .....	5
Install the software .....	6
Set application file permissions .....	7
Activate the license .....	9
View software version and license information .....	9
Application directories and their contents .....	10
File name extensions .....	11

## Operating basics

Run the application .....	13
Exit the application .....	14
Application controls and menus .....	14
Application controls .....	14
Options menu .....	17
Application panels .....	23
Application panel overview .....	23
Setup panel .....	25
Status panel overview .....	43
Results panel .....	45
Reports panel .....	48

## Setting up and configuring tests

About setting up tests .....	55
Equipment connection setup .....	55
Equipment connection setup through switch system .....	56

## Running tests

Test setup overview .....	61
Prerequisite .....	62
Compensate the signal path .....	62
Deskew .....	62
Running tests .....	64
Prerun checklist .....	64

## Saving and recalling test setups

About test setups .....	65
Save a test setup .....	66
Open (load) a saved test setup .....	67
Create a new test setup based on an existing one .....	67

## Switch Matrix application

Product description .....	69
Application overview .....	69
File name extensions .....	77
Status indicators .....	77
Saved configurations .....	77
De-embed settings .....	78
Apply a filter file for all relays .....	78
Apply a filter file for each relay type separately .....	79
Apply a filter file for each relay separately .....	79
Apply a filter file for each connection separately .....	80
Graphical view of switch matrix configuration .....	81
Saving the configuration .....	81
Feature description .....	82
Link width .....	82
Debug mode .....	82
Cascade (Relay cascade) .....	83
Error messages .....	85

## SCPI commands

About SCPI command .....	87
Socket configuration for SCPI commands .....	87

---

TEKEXP:*IDN?	95
TEKEXP:*OPC?	95
TEKEXP:ACQUIRE_MODE	96
TEKEXP:ACQUIRE_MODE?	96
TEKEXP:EXPORT	97
TEKEXP:INFO?	97
TEKEXP:INSTRUMENT	98
TEKEXP:INSTRUMENT?	98
TEKEXP:LASTERROR?	99
TEKEXP:LIST?	99
TEKEXP:MODE	100
TEKEXP:MODE?	101
TEKEXP:POPUP	101
TEKEXP:POPUP?	102
TEKEXP:REPORT	102
TEKEXP:REPORT?	103
TEKEXP:RESULT?	103
TEKEXP:SELECT	104
TEKEXP:SELECT?	105
TEKEXP:SETUP	105
TEKEXP:STATE	106
TEKEXP:STATE?	106
TEKEXP:VALUE	107
TEKEXP:VALUE?	108
Command parameters list	109
Examples	115
Switch Matrix commands	117
SWITCH:*IDN	117
SWITCH:*OPC	117
SWITCH:CONFIG	117
SWITCH:DE-EMBED:ALL:FILTER_FILE	118
SWITCH:DE-EMBED:CONN:FILTER_FILE	118
SWITCH:DE-EMBED:FILTER_FILE	118
SWITCH:DE-EMBED:MODE	119
SWITCH:DE-EMBED:RELAY:FILTER_FILE	119
SWITCH:DE-EMBED:RELAY_TYPE:FILTER_FILE	119
SWITCH:LASTERROR	120
SWITCH:LINKWIDTH	120
SWITCH:RELAY:CASCADE	121

SWITCH:RELAY:CASCADED .....	121
SWITCH:RELAY:COMMON .....	121
SWITCH:RELAY:POLARITY .....	122
SWITCH:RELAY:SIGNAL .....	122

## Reference

De-embed using filter files .....	123
Setup files .....	124
RF Switch configuration files .....	130



# Welcome

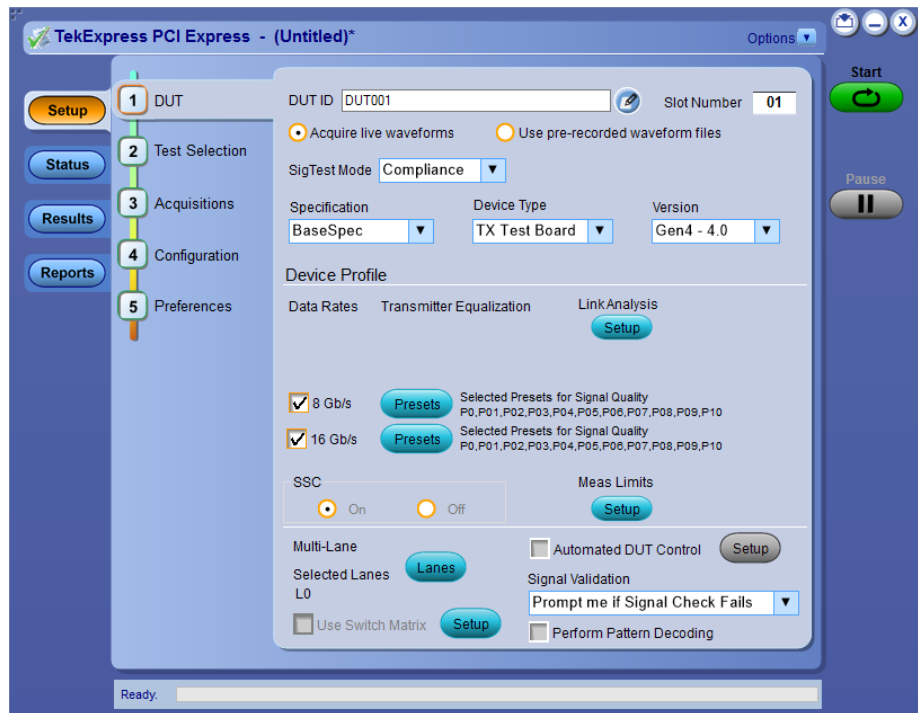

Welcome to the TekExpress<sup>®</sup> PCI Express Automated Test Solution Software application (referred to as TekExpress PCIe or PCIe in the rest of the document). TekExpress PCIe provides an automated, simple, and efficient way to test PCI Express interfaces and devices consistent to the requirements of the PCI Express specifications.

## Tek Express PCIe key features and benefits

### New features from current release

- Supports PCIe4.0 Base Spec with SigTest v4.0
- Migrated to New TekExpress Framework v4.2.10
- Migrated to Windows 64-Bit platform from 32-Bit
- Included Gen1,2,3,4 with Test Names for quick access
- Improved Switch and DUT toggle mechanism
- Deploys SigTest v3.2.0 and v4.0 to be used for PCIe3.0 and PCIe4.0 respectively
- Supports only Command Line Interface (CLI) for SigTest
- Supports only SCPI commands to remotely communicate with the TekExpress application

- Automates compliance measurements for PCI Express 3.0 BASE Specification Rev 0.9. for PCIE\_3\_8GB\_BASE
- Automates compliance measurements for PCI Express 4.0 BASE Specification Rev 0.9. for PCIE\_4\_16GB\_BASE

#### **Features of previous release**

- Support U.2 (SFF-8639) specification, provided the machine has SigTest v3.2.0 with U.2 templates
- Clock lane support in differential mode for the System-Board device type of CEM specification and Host device type of U.2 (SFF-8639) specification
- Updated mask co-ordinates for the Add-in-card device type of CEM specification, of Gen2 in DLL mode
- RF Switch support to test the x12 and x16 lanes using Keithley and Gigatronics switches respectively
- Trigger type support for Gen3 (Auto/Width/Edge)
- Supports P75xx, P76xx, and P77xx Trimode probes
- TekExpress setup files in-line with PCI-SIG Compliance Workshop
- Faster test execution time with improved Autoset
- Simple push button, enabling the users to manually toggle PCIe presets from AWG/AFG
- Automates compliance measurements for PCI Express 3.0 CEM Specification Rev 0.9. for the following configurations:
  - PCIE\_1\_0a- PCIE\_TX\_ADD\_CON\_250UI
  - PCIE\_1\_0a- PCIE\_TX\_SYS\_CON\_250UI
  - PCIE\_CEM\_CARD\_1\_1
  - PCIE\_CEM\_SYS\_1\_1
  - PCIE\_2\_0\_CARD
  - PCIE\_2\_0\_SYS
  - PCIE\_3\_0\_CARD
  - PCIE\_3\_0\_SYS
- Fully automated General, Jitter, Composite Eye, Transition Eye, and Non Transition Eye measurements
- Provides both an automation solution (for compliance) and DPOJET (for debug)
- The PCI-SIG<sup>®</sup> PCI Express Compliance Test Library is integrated into the TekExpress framework
- Reduces the time required to conduct testing
- Minimizes user intervention when conducting time-consuming testing
- Enables loading filter files to support system and add-in card measurements
- Performs fully-automated testing for system and add-in card measurements
- Provides individual or group test selection by using a tree-structure menu

- Built-in reporting features:
  - Provides a Pass/Fail summary table
  - Provides margin details on each test
  - Provides a consolidated report for all tests
- Complete programmatic interface enables automation scripts to call PCIe functions



# Getting help and support

## Related documentation

The following manuals are available as part of the TekExpress PCIe Compliance and Debug Solution documentation set.

**Table 1: Product documentation**

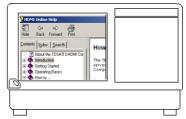
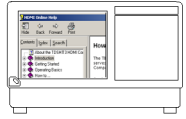
Item	Purpose	Location
Application Help	In-depth operation and UI help	
PDF of the Application Help	Printable version of the compiled Application help	

See also [Technical support](#)

## Conventions used in help

Application Help uses the following conventions:

- The term “DUT” is an abbreviation for Device Under Test.
- The term “select” is a generic term that applies to the two methods of choosing an option: using a mouse or using the touch screen.
- The term "close" refers to normally close the relay signal (select the signal).
- The term "open" refers to normally open the relay signal (unselect the signal).
- The term "channel" refers to the relay signal or oscilloscope channel.

## Technical support

Tektronix values your feedback on our products. To help us serve you better, please send us your suggestions, ideas, or comments on your application or oscilloscope. Contact Tektronix through mail, telephone, or the Web site. See [Contacting Tektronix](#) for more information.

When you contact Tektronix Technical Support, please include the following information (be as specific as possible):

### General information

- All instrument model numbers
- Hardware options, if any
- Probes used
- Your name, company, mailing address, phone number, FAX number
- Please indicate if you would like to be contacted by Tektronix about your suggestion or comments.

### Application specific information

- Software version number
- Description of the problem such that technical support can duplicate the problem
- If possible, save the setup files for all the instruments used and the application
- If possible, save the TekExpress setup files, log.xml, \*.TekX (session files and folders), and status messages text file
- If possible, save the waveform on which you are performing the measurement as a .wfm file

---

# Getting started

## Minimum system requirements

The following table shows the minimum system requirements needed for an oscilloscope to run TekExpress PCI Express.

**Table 2: System requirements**

Component	Requirement
Oscilloscope	See <a href="#">Instruments and accessories required</a>
Processor	Same as the oscilloscope
Operating system	Microsoft Windows 7 (64-bit only) <a href="#">Required Windows 7 user account settings</a>
Memory	Same as the oscilloscope
Hard disk	Same as the oscilloscope
Display	Same as the oscilloscope <sup>1</sup>
Firmware	Tekscope 10.7.0 or later for MSO/DSA/DPO70000C, D, DX, SX
Software	<ul style="list-style-type: none"><li>■ DPOJET, Jitter and Eye Diagram Analysis Tool <sup>2</sup></li><li>■ Microsoft .NET 4.0 Framework</li><li>■ Microsoft Internet Explorer 8.0 SP1 or later</li><li>■ PyVisa version 1.0.0</li><li>■ IronPython version 2.7.3</li><li>■ Microsoft Photo Editor 3.0 or equivalent software for viewing image files</li><li>■ Adobe Reader 7.0 or equivalent software for viewing portable document format (PDF) files</li></ul>

---

<sup>1</sup> If TekExpress is running on an instrument having a video resolution lower than 800x600 (for example, a sampling oscilloscope), it is recommended that you connect a secondary monitor, which must be enabled before launching the application.

<sup>2</sup> For software version, refer to Readme TekExpress PCI Express.txt file at C:\Program Files\Tektronix\TekExpress\TekExpress PCI Express

## Instruments and accessories required

The following table lists the instruments and accessories required for TekExpress PCI Express application.

**Table 3: Instruments and accessories required for PCI Express application**

Instrument/Accessory	Model number
Oscilloscope	MSO70604 <sup>3</sup> , DPO/MSO70604C (Gen1 testing only) MSO70804 <sup>3</sup> , DPO/MSO70804C (Gen1 and Gen2 testing only) MSO71254 <sup>3</sup> , DPO/MSO71254C (Gen1, Gen2, and Gen3 testing) MSO71604 <sup>3</sup> , DPO/MSO71604C (Gen1, Gen2, and Gen3 testing) MSO72004 <sup>3</sup> , DPO/MSO72004C (Gen1, Gen2, and Gen3 testing) DPO/DSA72504D ( Gen 1, Gen2, and Gen 3 testing) DPO/DSA73304D (Gen 1, Gen 2, and Gen 3 testing) DPO/MSO72304DX (Gen1, Gen2, and Gen3 testing) DPO/MSO72504DX (Gen1, Gen2 and Gen3 testing) DPO/MSO73304DX (Gen1, Gen2 and Gen3 testing) DPO72304SX (Gen1, Gen2 and Gen3 testing) DPO75002SX [Standalone <sup>4</sup> or 2 stack] (Gen1, Gen2 and Gen3 testing) DPO73304SX (Gen1, Gen2 and Gen3 testing) DPO75902SX [Standalone <sup>4</sup> or 2 stack] (Gen1, Gen2 and Gen3 testing) DPO77002SX [Standalone <sup>4</sup> or 2 stack] (Gen1, Gen2 and Gen3 testing)
Arbitrary Function Generator (AFG) <sup>5</sup> (for automatic test pattern toggling)	Tektronix AFG3252, AFG3252C
Arbitrary Waveform Generator (AWG) (for automatic test pattern toggling)	<ul style="list-style-type: none"> <li>■ Tektronix AWG5002B/C, AWG5012B/C, AWG5014B/C</li> <li>■ Tektronix AWG7082B/C, AWG7122B/C</li> <li>■ Tektronix AWG70001A, AWG70002A</li> </ul>
Probes	P7313, P7513, P7513A, P7516, P7520A (with P75PST tip), P7520A, P7633, P7720, P7716, P7713

<sup>3</sup> Requires Microsoft Windows 7 (64-bit) operating system. Contact your local Tektronix Customer Service representative for upgrade information.

<sup>4</sup> Standalone can be used only for CEM specification Add-In-Card device type or U.2(SFF8639) specification Module device type

<sup>5</sup> The listed AFG/AWG instruments support both differential inputs (requires 2 channels) and 100 MHz burst mode.



Instrument/Accessory	Model number
RF Switch <sup>6 7</sup>	<ul style="list-style-type: none"> <li>■ Keithley System S46 and S46T RF Microwave Switch Systems for x12 PCIe</li> <li>■ Gigatronics RF Switch 26GHz (8902-L-48TS26) for x16 PCIe</li> </ul>
Other devices	<ul style="list-style-type: none"> <li>■ SMP-SMA cables</li> <li>■ TCA-SMA connectors</li> <li>■ Matched pair cables</li> <li>■ Tektronix P7313 SMA Differential Probe</li> </ul>

## Windows 7 user account settings

Windows 7 instruments need to have the User Account Control Settings set to **Never Notify**. To set User Account Control Settings:

1. Go to **Control Panel > User Accounts > Change User Account Control settings**.
2. Set it to **Never Notify** as shown in the image.

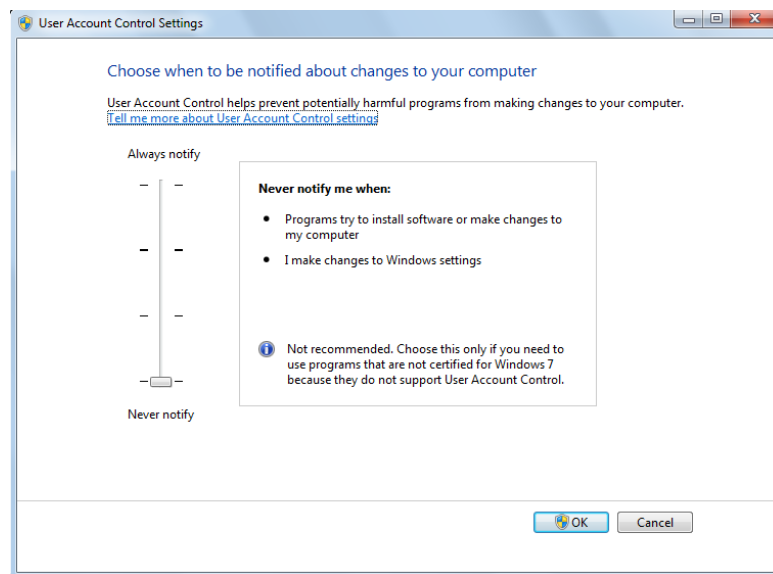

<sup>6</sup> Use GPIB cable or USB-to-GPIB cable to connect the oscilloscope to switch.

<sup>7</sup> The GPIB address of the RF Switch and toggle instrument (AWG/AFG) must be different.

See also [Supported oscilloscopes](#)

## Install the software

Use the following steps to install PCI Express software on any compatible instrument running Microsoft Windows 7 (64-bit). See [Minimum System Requirements](#) for details.

1. Close all applications (including the TekScope application).
2. Go to the [www.tek.com](http://www.tek.com) Web site and search for TekExpress PCI Express to locate the installation file. Download the file TekExpress\_PCIe\_Deployment\_Package.exe.
3. Copy or download the PCIe installer file to the oscilloscope.
4. Double-click the installer .exe file to extract the installation files and launch the InstallShield Wizard. Follow the on-screen instructions. The software installs in the following location:

*C:\Program Files\Tektronix\TekExpress\TekExpress PCI Express*

5. The installer updates the TekScope Analyze menu to include the installed options.

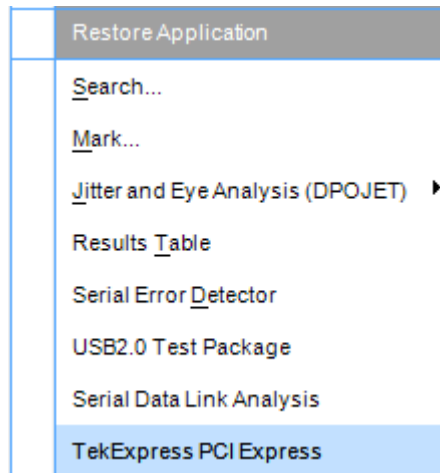

See also [Minimum system requirements](#)  
[Supported oscilloscopes](#)

## Set application file permissions

Before you run tests for the first time, do the following:

1. Understand where your test files are stored on the instrument.

After you install and launch TekExpress PCIe, it creates the following folders on the oscilloscope:

- \My Documents\My TekExpress\PCI Express
- \My Documents\My TekExpress\PCI Express\Untitled Session

Every time you launch TekExpress PCIe, an Untitled Session folder is created in the PCIe folder. The Untitled Session folder is automatically deleted when you exit the PCIe application. To preserve your test session files, save the test setup before exiting the TekExpress application.



### CAUTION.

*Do not modify any of the session files or folders because this may result in loss of data or corrupted session files. Each session has multiple files associated with it. When you save a session, a .TekX file, and a folder named for the session that contains associated files, is created on the oscilloscope X: drive.*

2. [Map the shared My TekExpress folder](#) as **X:** (X drive) on the instruments used in test setups running Microsoft Windows Operating System.

The My TekExpress folder has the share name format <domain><user ID>My TekExpress. Or, if the instrument is not connected to a domain, the share name format is <instrument name><user ID>My TekExpress. This shared folder is used to save the waveform files and is used during other file transfer operations.

**NOTE.** *If the X: drive is mapped to any other shared folder, the application will display a warning message asking you to disconnect the X: drive manually.*

3. Make sure that the My TekExpress folder (Drive X:) has read and write access:
  - a. Right-click the folder and select **Properties**.
  - b. Select the **General** tab and then click **Advanced**.
  - c. In the Advanced Attributes dialog box, make sure that the option **Encrypt contents to secure data** is NOT selected (not checked). Example.

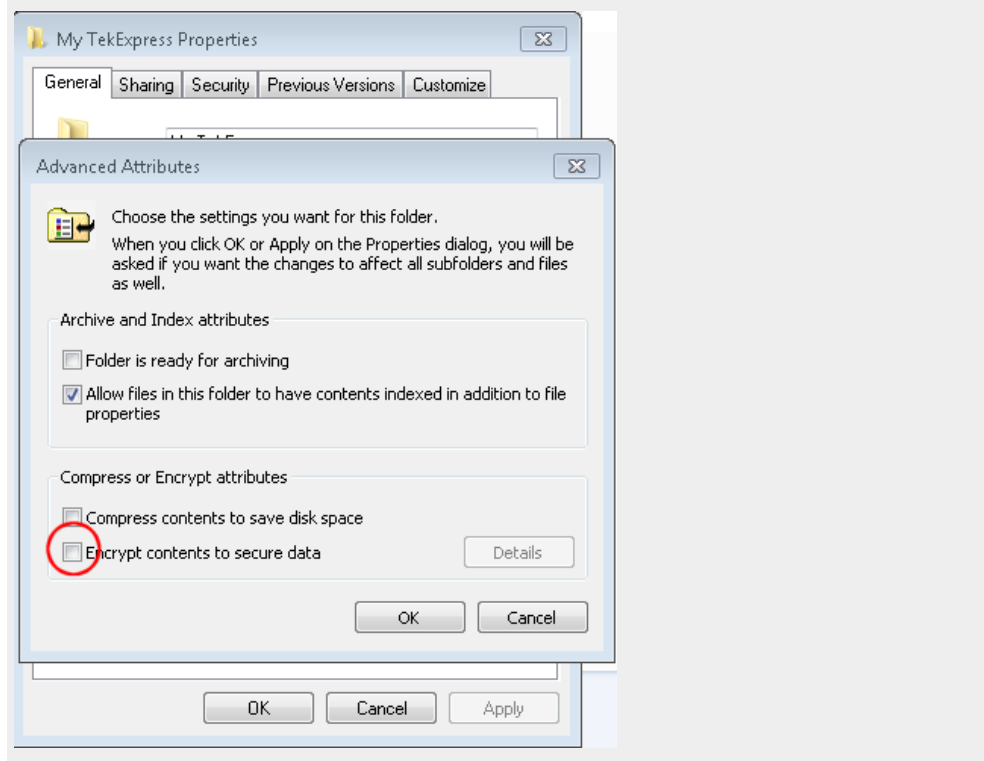

4. See the [prerun checklist](#) before you run a test.

**See also**

[Configuration test parameters](#)

[View test-related files](#)

[Application directories and usage](#)

[File name extensions](#)

## Activate the license

Activate the license using the Option Installation wizard on the oscilloscope. Instructions for using the Options Installation window to activate licenses for installed applications is provided in the oscilloscope online Help:

1. From the oscilloscope menu bar, click **Utilities > Option Installation**.  
The TekScope Option Installation wizard opens.
2. Push the **F1** key on the oscilloscope keyboard to open the Option Installation help topic. Follow the directions in the topic to activate the license.

See also

[View version and license information](#)

## View software version and license information

Use the following instructions to view version information for the application and for the application modules such as the Programmatic Interface and the Programmatic Interface Client.

To view version information for PCIe:

1. In the PCIe application, click the **Options** button and select **About TekExpress**.

The About Tektronix TekExpress PCI Express dialog box appears, showing the version details.

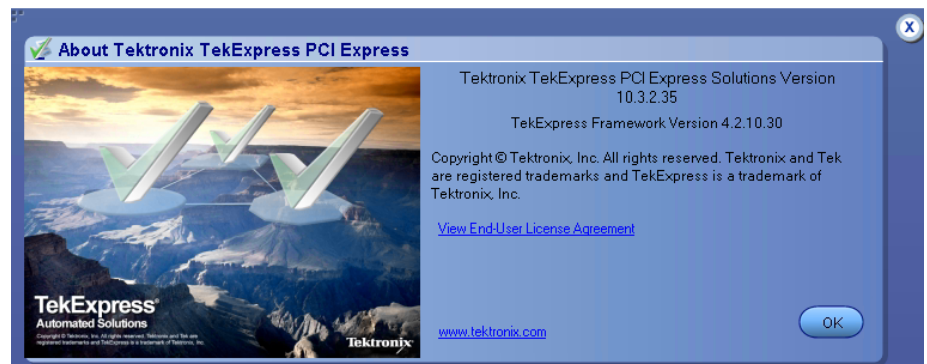

To view license and option key information:

1. From the TekScope menu, select **Help > About TekScope**.
2. Scroll through the Options section list to locate PCI Express.
3. To view the Option key, look below the **Options** list.

See also [Activate the license](#)  
[Options menu](#)

## Application directories and their contents

**TekExpress PCIe application** The TekExpress PCIe application files are installed at *C:\Program Files\Tektronix\TekExpress\TekExpress PCI Express*.

It contains the following folders:

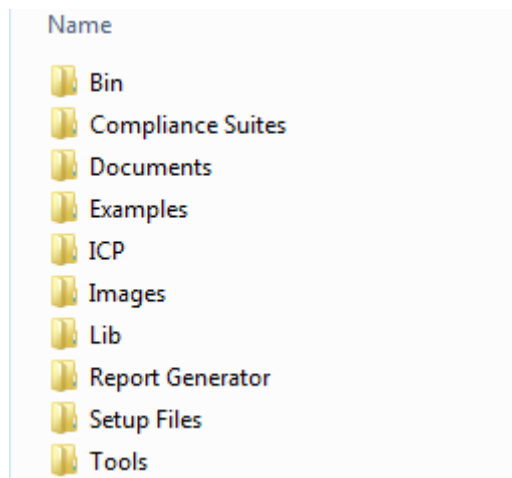

The following table lists the application directory names and their purpose.

**Table 4: Application directories and usage**

Directory names	Usage
ACP	Contains instrument and PCIe application-specific interface libraries
Bin	Contains miscellaneous PCIe application libraries
Compliance Suites	Contains compliance-specific files
Data Manager	Contains result management-specific libraries of the PCIe application
Data Storage	Contains libraries needed for storing data
Documents	Contains the technical documentation for the PCIe application
Examples	Contains various support files and example Python and C# test files
ICP	Contains instrument and PCIe application-specific interface libraries
Lib	Contains utility files specific to the PCIe application and Switch Matrix filter files

Directory names	Usage
Report Generator	Contains style sheets for report generation
<a href="#">Setup files</a>	Contains PCI-SIG work shop compliant TekExpress setup files for System-Bard, Add-In-Card of CEM specification and Host, Module of U.2(SFF8639) specification
Tools	Contains instrument and PCIe application-specific files

See also [View test-related files](#)  
[File name extensions](#)

## File name extensions

The TekExpress PCIe application uses the following file name extensions:

File name extension	Description
.TekX	Application session files (the extensions may not be displayed)
.py	Python test file. See the TekExpress PCI Express\Examples folder for a sample file
.xml	Test-specific configuration information (encrypted) file Application log file
.wfm	Test waveform file
.mht	Test result reports (default). Test reports can also be <a href="#">saved in HTML format</a>
.flt	Filter files
.chm, pdf	Help manuals

### Waveform file names

This application uses file name conventions to access the Data and Clock waveforms. It is recommended to save the waveforms with following file names.

- Differential data waveform: *Tek\_PCIe\_01\_8Gbps\_Ln00\_P0\_d\_Diff.wfm*
- Differential clock waveform: *Tek\_PCIe\_01\_8Gbps\_Ln00Clk\_P0\_d\_Diff.wfm*
- Single ended data positive waveform:  
*Tek\_PCIe\_01\_8Gbps\_Ln00\_P0\_d\_Pos.wfm*
- Single ended data negative waveform:  
*Tek\_PCIe\_01\_8Gbps\_Ln00\_P0\_d\_Neg.wfm*
- Others:  
*Tek\_PCIe\_Slot\_DataRate\_LaneNumber\_PresetNumber\_Data\_Differential.wfm*

**See also**

*Select report options*

*View test-related files*

*Application directories and their contents*

*Before you click start*



---

# Operating basics

## Run the application

To launch the PCIe application, do either of the following:

- Select **Analyze > TekExpress PCI Express** from the TekScope menu.
- Double-click any saved PCIe session file (<file name>.TekX).

When you first run the application after installation, the application checks for a file called Resources.xml located at C:\Users\<>username>\My TekExpress\PCI Express. The Resources.xml file gets mapped to the X: drive when the application launches. Session files are then stored inside the X:\PCI Express folder.

The Resources.xml file contains information about available network-connected instruments. If this file is not found, the application runs an instrument discovery program, before launching PCIe, to locate available instruments.

To keep the application window on top, select **Keep On Top** from the PCIe *Options menu*. If the application goes behind the oscilloscope application, click **Analyze > TekExpress PCI Express** to move the application to be in front.

**See also** [Activate the license](#)

## Exit the application

Use the following method to exit the application:

---

**NOTE.** Using other methods to exit the application results in abnormal termination of the application.

---

1. Click  on the application title bar.
2. Do one of the following:
  - If you have an unsaved session or test setup, you are asked to save it before exiting. To save it, click **Yes**. Otherwise click **No**. The application closes.
  - A message box appears asking if you really want to exit TekExpress. To exit, click **Yes**.

---



**NOTE.** To minimise the application, click  on the application title bar.







---

## Application controls and menus

### Application controls

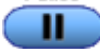
**Table 5: Application controls descriptions**

Item	Description
<p><i>Options menu</i></p> 	Menu to display global application controls
<p><i>Panel buttons</i></p> 	Controls that open panels for configuring test settings and options.

Item	Description
<p data-bbox="545 275 716 306">Start/Stop button</p> <div data-bbox="553 369 651 436" style="text-align: center;"> <p data-bbox="578 373 626 394">Start</p>  </div> <div data-bbox="553 569 651 659" style="text-align: center;"> <p data-bbox="578 573 626 594">Stop</p>  </div>	<p data-bbox="862 275 1503 401">Use the Start button to start the test run of the measurements in the selected order. If prior acquired measurements have not been cleared, the new measurements are added to the existing set.</p> <p data-bbox="862 405 1503 468">The button toggles to the Stop mode while tests are running. Use the Stop button to abort the test.</p>
<p data-bbox="545 709 789 741">Pause \ Continue button</p> <div data-bbox="553 804 651 877" style="text-align: center;"> <p data-bbox="578 808 626 829">Pause</p>  </div> <div data-bbox="553 982 651 1056" style="text-align: center;"> <p data-bbox="578 987 626 1008">Continue</p>  </div>	<p data-bbox="862 709 1503 804">Use the Pause button to temporarily interrupt the current acquisition. When a test is paused, the button name changes to "Continue."</p>
<p data-bbox="545 1102 675 1134">Clear button</p> <div data-bbox="553 1197 651 1270" style="text-align: center;"> <p data-bbox="578 1201 626 1222">Clear</p>  </div>	<p data-bbox="862 1102 1503 1291">Use the Clear button to clear all existing measurement results. Adding or deleting a measurement, or changing a configuration parameter of an existing measurement, also clears measurements. This is to prevent the accumulation of measurement statistics or sets of statistics that are not coherent. This button is available only on the <a href="#">Results pane</a>.</p>
<p data-bbox="545 1312 708 1344">Minimize button</p> <div data-bbox="553 1407 610 1480" style="text-align: center;">  </div>	<p data-bbox="862 1312 1122 1344">Minimizes the application.</p>
<p data-bbox="545 1522 675 1554">Close button</p> <div data-bbox="553 1617 610 1690" style="text-align: center;">  </div>	<p data-bbox="862 1522 1073 1554">Exits the application.</p>

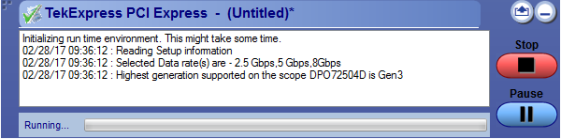
Item	Description
Application window move	Place the cursor over the application window and drag it to the desired location.
Mini view  	<p>Toggles the application to mini view which displays all the run messages with the time stamp, progress bar, Start / Stop button, and Pause / Continue button.</p> <p>The application will navigate to mini view when you start the test run of the measurements.</p> 

**Options menu** **Options menu overview.** The Options menu is located in the upper right corner of the application.

The Options menu has the following selections:

Menu	Function
Default Test Setup	Opens an untitled test setup with defaults selected
Open Test Setup	Opens a saved test setup
Save Test Setup	Saves the current test setup selections <sup>1</sup>
Save Test Setup As	Creates a new test setup based on an existing one <sup>1</sup>
Open Recent	Displays a menu of recently opened test setups to select from
<i>Instrument Control Settings</i>	Shows the list of instruments connected to the test setup and allows you to locate and refresh connections to those instruments
Keep On Top	Keeps the TekExpress PCIe utility on top of other open windows on the desktop
<i>Email Settings</i>	Use to configure email options for test run and results notifications
Deskew	Allows to read the skew and attenuation values from the TekScope application. Before using this option, manually compensate for skew and attenuations in Tekscope application.
Help	Displays the TekExpress PCIe Online help
About TekExpress	<ul style="list-style-type: none"> <li>■ Displays application details such as software name, version number, and copyright</li> <li>■ Provides access to <i>license information</i> for your PCIe installation</li> <li>■ Provides a link to the Tektronix Web site</li> </ul>

<sup>1</sup> In pre-recorded mode, waveform recall will not be successful if the session name is lengthy, i.e. more than 10 characters.

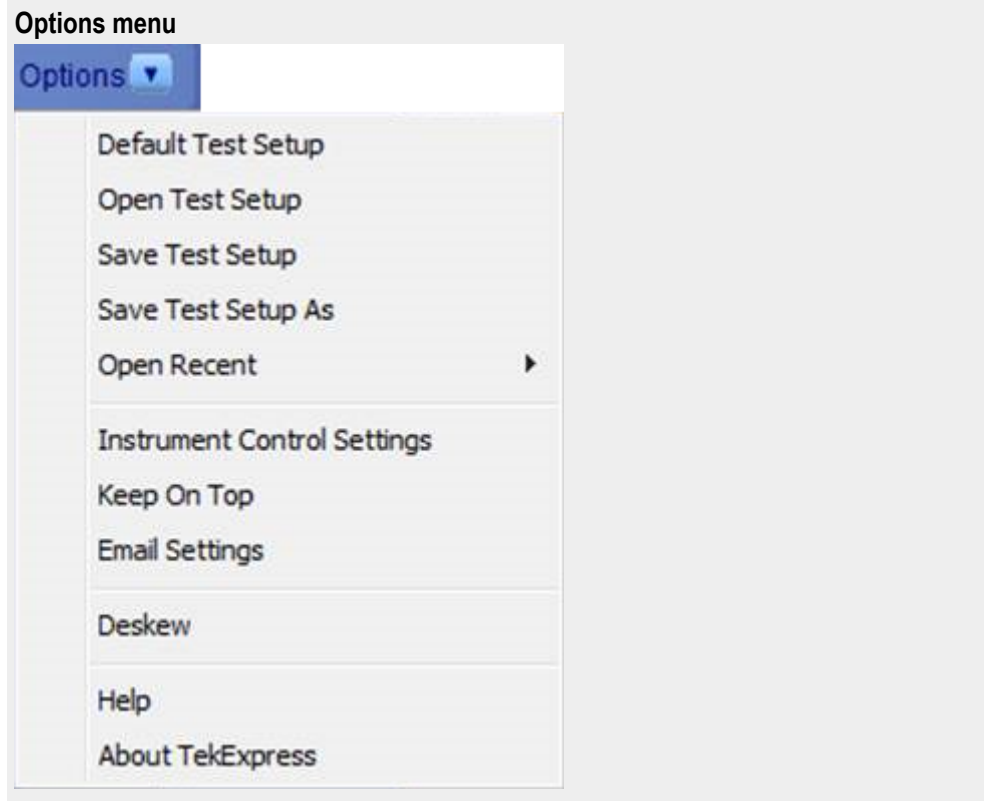

**See also.**

*[Application controls](#)*

**Instrument control settings dialog box.** Use the TekExpress Instrument Control Settings dialog box to search for and list the connected resources (instruments) found on specified connections (LAN, GPIB, USB, and so on) and each instruments connection information. You access this dialog box from the Options menu.

Access this dialog box from the **Options** menu.

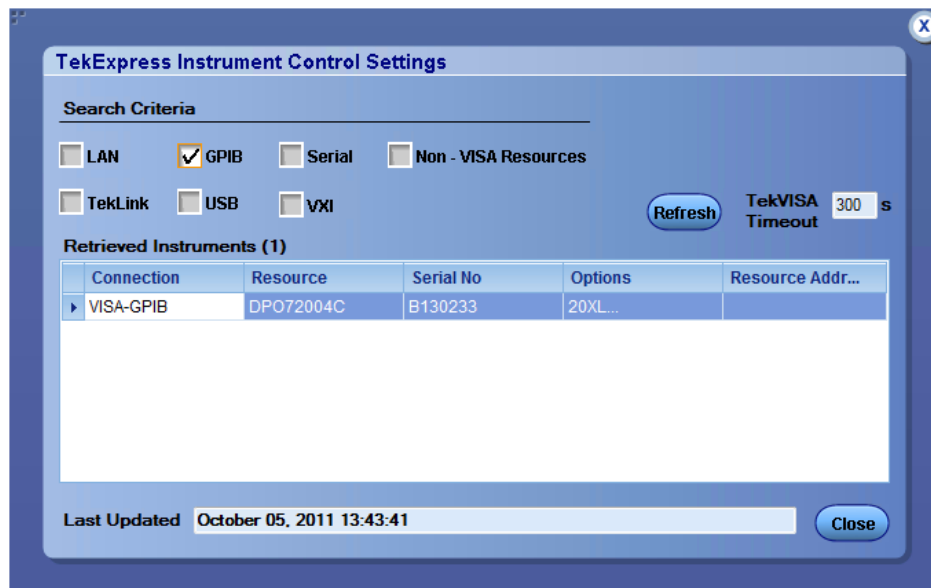

Use the Instrument Control Settings feature to *search for connected instruments* and view instrument connection details. Connected instruments displayed here can be selected for use under Global Settings in the test configuration section.

**See also.**

*[Options menu overview](#)*

**View connected instruments.** Use the Instrument Control Settings dialog box to view or search for connected instruments required for the tests. The application uses TekVISA to discover the connected instruments.

To refresh the list of connected instruments:

1. From the Options menu, select **Instrument Control Settings**.
2. In the Search Criteria section of the Instrument Control Settings dialog box, select the connection types of the instruments for which to search.

Instrument search is based on the VISA layer, but different connections determine the resource type, such as LAN, GPIB, and USB. For example, if you choose LAN, the search will include all the instruments supported by TekExpress that are communicating over the LAN. If the search does not find any instruments that match a selected resource type, a message appears telling you that no such instruments were found.

3. Click **Refresh**. TekExpress searches for connected instruments.

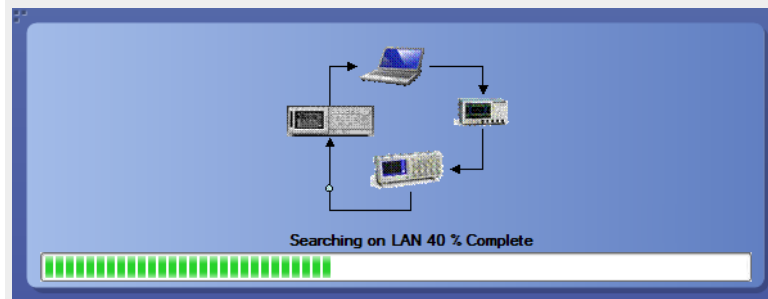

4. After discovery, the dialog box lists the instrument-related details based on the search criteria you selected. For example, if you selected LAN and GPIB as the search criteria, the application checks for the availability of instruments over LAN, then GPIB.

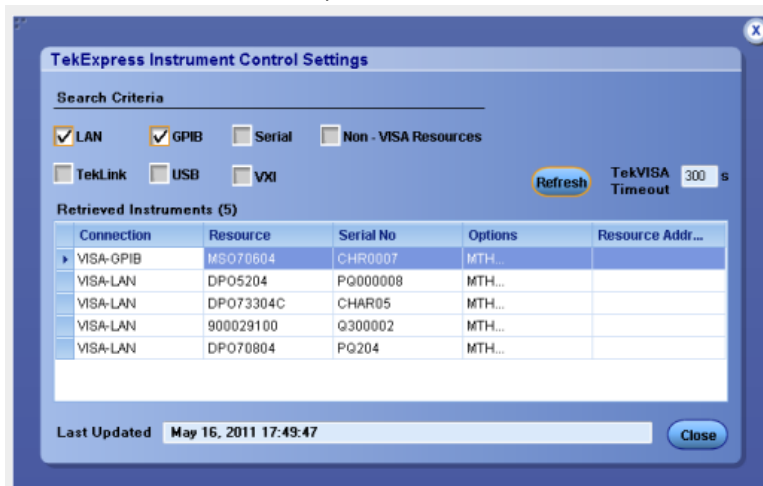

The details of the instruments are displayed in the Retrieved Instruments table. The time and date of instrument refresh is displayed in the Last Updated field.

**See also.**

[Configuration test parameters](#)



### *Equipment connection setup*

**Email settings.** Use the Email Settings utility to *configure email notifications* to receive notifications when a test completes, produces an error, or fails. Select the type of test session information to include with the email, such as test reports and test logs, the email message format, and the email message size limit.

Access this dialog box from the Options menu.

---

**NOTE.** *Recipient email address, sender's address, and SMTP Server are mandatory fields.*

---

**Email Settings**

Recipient e-mail Address(es)

Sender's Address  Note: Separate Email addresses with a comma

**Email Attachments**

Reports

Status Log  Last 20 Lines  Full Log

**Server Configuration**

SMTP Server  SMTP Port

Login

Password

Host Name

**Email Configuration**

Email Format  HTML  Plain Text

Max Email Size (MB)  Number of Attempts to Send

Timeout (Sec)

Email Test Results When complete or on error

**See also.**

*Configure email settings*

*Options menu*

*Select test notification preferences*

**Configure email settings.** To be notified by email when a test completes, fails, or produces an error, configure the email settings.

1. **Options > Email Settings** to open the Email Settings dialog box.
2. (Required) For Recipient email Address(es), enter one or more email addresses to which to send the test notification. To include multiple addresses, separate the addresses with commas.
3. (Required) For Sender's Address, enter the email address used by the instrument. This address consists of the instrument name followed by an underscore followed by the instrument serial number, then the @ symbol and the email server used. For example:  
DPO72016C\_B130099@yourcompany.com.
4. (Required) In the Server Configuration section, type the SMTP Server address of the Mail server configured at the client location, and the SMTP Port number, in the corresponding fields.

If this server requires password authentication, enter a valid login name, password, and host name in the corresponding fields.

---

**NOTE.** *If any of the above required fields are left blank, the settings will not be saved and email notifications will not be sent.*

---

5. In the Email Attachments section, select from the following options:
  - **Reports:** Select to receive the test report with the notification email.
  - **Status Log:** Select to receive the test status log with the notification email. If you select this option, then also select whether you want to receive the full log or just the last 20 lines.
6. In the Email Configuration section:
  - Select the message file format to send: HTML (the default) or plain text.
  - Enter a maximum file size for the email message. Messages with attachments larger than this limit will not be sent. The default is 5 MB.
  - Enter the number in the Number of Attempts to Send field, to limit the number of attempts that the system makes to send a notification. The default is 1. You can also specify a timeout period.
7. Select the **Email Test Results When complete or on error** check box. Use this check box to quickly enable or disable email notifications.
8. To test your email settings, click **Test Email**.
9. To apply your settings, click **Apply**.
10. Click **Close** when finished.

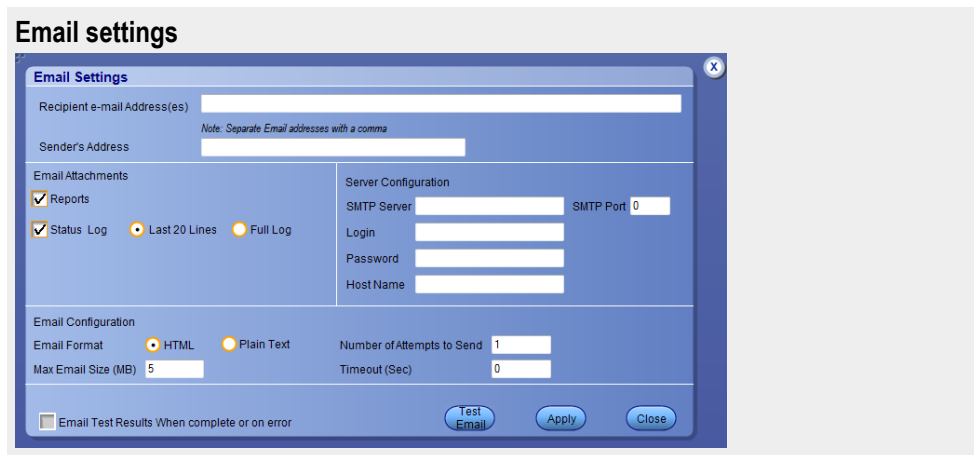

## Application panels

### Application panel overview

Panels group related configuration, test selection, and results settings. Click a button to open the associated panel.

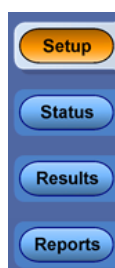

A panel may have one or more tabs that list the selections available in that panel. Controls in a panel can change depending on settings made in that panel or another panel.

The TekExpress PCIe panels are:

**Table 6: Application panels**

Panel Name	Purpose
<a href="#">Setup</a>	<p>The Setup panel shows the test setup controls. Click the <b>Setup</b> button to open this panel.</p> <p>Use this panel to:</p> <ul style="list-style-type: none"> <li>■ <a href="#">Select DUT parameters.</a></li> <li>■ <a href="#">Select the test(s).</a></li> <li>■ <a href="#">Set acquisitions parameters</a> for selected tests.</li> <li>■ <a href="#">Configuration test parameters</a></li> <li>■ <a href="#">Select test notification preferences.</a></li> </ul>
<a href="#">Status</a>	View the progress and analysis status of the selected tests, and view test logs.
<a href="#">Results</a>	View a summary of test results and select result viewing preferences.
<a href="#">Reports</a>	Browse for reports, save reports as specific file types, specify report naming conventions, select report content to include (such as summary information, detailed information, user comments, setup configuration, application configuration), and select report viewing options.

**See also.**

[Application controls](#)

[About setting up test](#)

**Setup panel** **Setup panel overview.** The Setup panel contains sequentially ordered tabs that help guide you through a typical test setup process.

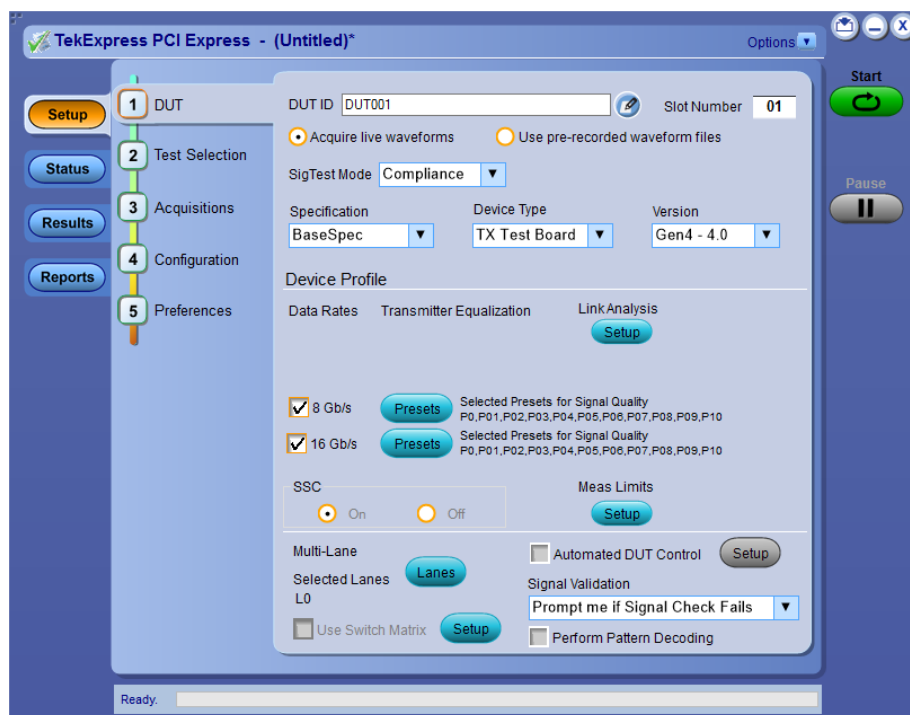

Use the tabs on this panel to:

*Set the DUT parameters*

*Select test(s)*

*Select acquisition parameters*

*Set configuration parameters*

*Select test notification preferences*

**Set DUT parameters.** Use the DUT tab to select parameters for the device under test. The settings are global and apply to all tests for the current session. DUT settings also affect the list of available tests in the Test Selection tab.

Click **Setup > DUT** to access the DUT parameters.

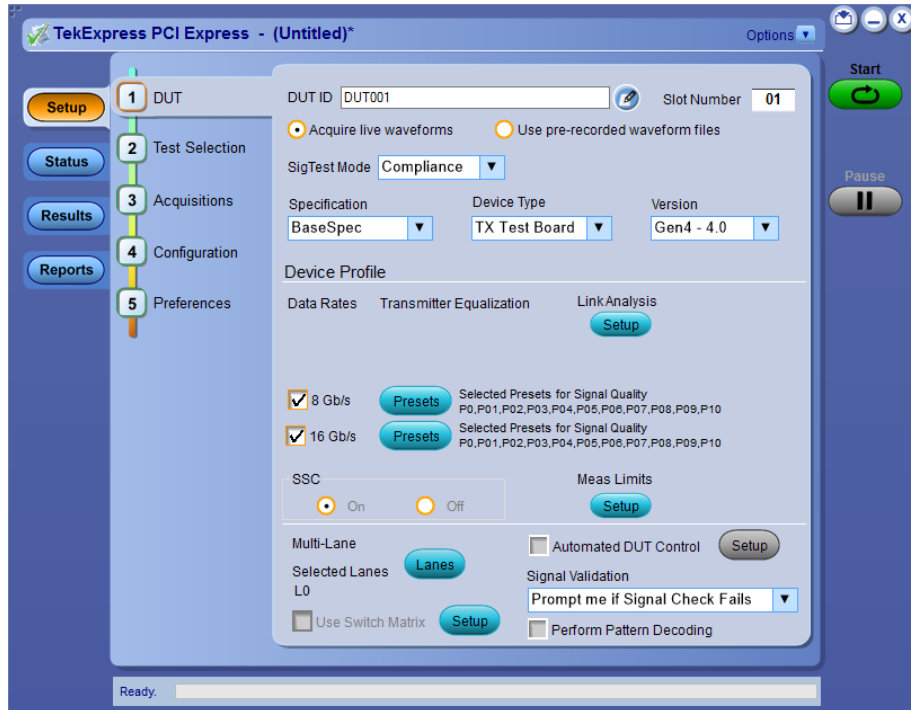

**Table 7: DUT tab settings**

Setting	Description
DUT ID	Adds an optional text label for the DUT to reports. The default value is DUT001. <sup>1</sup>
Slot Number	The slot parameter (1, 2, 4, 8, 16, or 32) of the DUT.
 Comments icon (to the right of the DUT ID field)	Opens a Comments dialog box in which to enter optional text to add to a report. The maximum number of characters is 256. To enable or disable comments appearing on the test report, see <a href="#">Select report options.</a> )
Acquire live waveforms	Acquire active signals from the DUT for testing.
Use prerecorded waveform files	Run tests on a saved waveform. <a href="#">Open (load) a saved test setup</a>

<sup>1</sup> In pre-recorded mode, waveform recall will not be successful if the session name is lengthy, i.e. more than 10 characters.

Setting	Description
SigTest Mode	<p>Sets the overall testing mode. Select Compliance or User Defined:</p> <ul style="list-style-type: none"> <li>■ Compliance: Preselects tests and parameters to meet compliance specifications for the selected version, specification, and device type.</li> <li>■ User Defined: Enables the user to select specific tests and set custom parameters for tests.</li> </ul>
Specification	<p>PCIe supports the CEM, BaseSpec, and U.2 (SFF-8639) specification.</p> <p><b>NOTE.</b> U.2 (SFF8639) and Base Specification supports Gen3 (3.0) version only.</p>
Device Type	<p>Sets the DUT device type (System-Board or Add-in-Card).</p> <p>Sets the DUT device type. The device type available depends on the selected specification. For CEM, the Device Type is System-Board or Add-In-Card For BaseSpec, the Device Type is TX Test Board For U.2 (SFF-8639), the Device Type is Module or Host</p>
Version	<p>Sets the DUT generation version. Available versions are Gen 1 (1.0a and 1.1), Gen2 (2.0), Gen3 (3.0), and Gen4 (4.0)</p>
<b>Device Profile</b>	
Data Rates	<p>Sets the data rates to test (2.5 Gb/s, 5 Gb/s, 8 Gb/s, and 16 Gb/s). The data rates available depend on the selected DUT version.</p>
Transmitter Equalization	<p>Sets transmitter preemphasis levels. Available for Gen 2 and Gen 3 devices.</p> <p>The application selects both preemphasis levels by default when in the compliance mode for an Add-in-Card.</p> <p>At least one preemphasis level must be selected.</p>
Link Analysis	<p>Opens the Link Analysis dialog box to select custom filter files with which to perform link analysis on the source waveforms. <a href="#">Link Analysis dialog box</a></p>
Presets	<p>Opens the Presets dialog box to select the presets (P0-P10) used to perform the signal quality tests. Only available for Gen 3 DUT version.</p>

Setting		Description
Meas Limits	Voltage Swing Limits	Sets the lane/link transmitter p-p voltage swing. This affects the limits applied to certain measurements based on the settings and does not change anything on the DUT tab.
	Crosstalk Limits	<p>Sets specific eye test limits depending on if the DUT design uses interleaved or non interleaved routing. This affects the limits applied to certain measurements based on the settings and does not change anything on the DUT tab. This is applicable for Gen2.</p> <ul style="list-style-type: none"> <li>■ When the DUT uses noninterleaved routing, select <b>Crosstalk (noninterleaved routing)</b>.</li> <li>■ When the DUT uses interleaved routing, select <b>No Crosstalk (interleaved routing)</b>.</li> </ul>
SSC (spread spectrum clocking)		Enables or disables SSC clocking. This affects the limits applied to certain measurements based on the settings and does not change anything on the DUT tab.
Lanes		<p>Opens the Test Lane Setup dialog box to select the lanes to test. Lanes required for compliance testing are colored orange. At least one lane must be selected.</p> <p>The Link Width setting determines the number of lanes that can be tested.</p> <p><a href="#">Test Lane Setup dialog box</a></p>
Automated DUT Control		Enables automatic toggling of the DUT into different test modes (generation/equalization). Requires the use of an AFG or AWG instrument. Click <b>Setup</b> to access the <a href="#">Automated DUT Control dialog box</a>
Use Switch Matrix		<p>Select to use the switch matrix. This solution allows you to map each of the several transmitter signals and forward the selected input either to another relay or to the oscilloscope channel.</p> <p>Click <b>Setup</b> to configure the switch matrix. Refer <a href="#">Switch Matrix application</a> for more details on configurations.</p> <hr/> <p><b>NOTE.</b> Keithley supports maximum of 12 lanes and Gigatronics supports maximum of 16 lanes.</p>
Signal validation		Sets the application to validate acquisition signals and perform the specified action to take when acquired signals do not meet requirements. Select the action from the list.



Setting	Description
Perform Pattern Decoding	Select to validate the pattern according to the respective lane and preset for Gen3 and Gen4.

**See also.**

[About setting up tests](#)

[Select a test](#)

**Link analysis dialog box.** The Link Analysis dialog box lets you select custom filter files for performing link analysis on the source waveforms. The options available depends on the Specification selected.

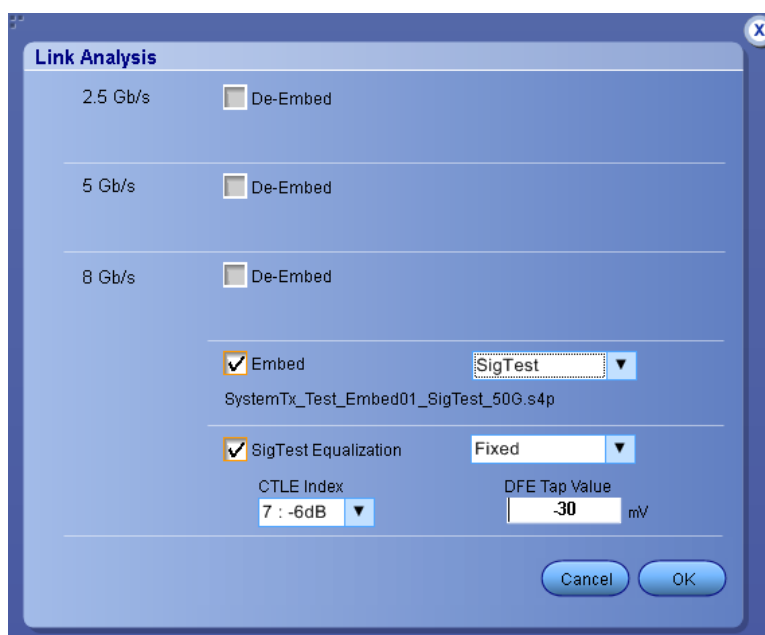
**De-Embed**

Select de-embed for the data rate; click **Browse** and select the de-embed filter file.

**Embed**

Select Embed and select SigTest or Scope from the drop-down list. Scope option allows you to select the scope filter file.

**SigTestEqualization**

Select SigTestEqualization and select Optimize or Fixed from the drop-down list. Fixed mode allows you to set the CTLE Index and DFE Tap Value parameters.

**Test lane setup dialog box.** The Test Lane Setup dialog box enables setting the link width and specific lanes to test. Lanes required for compliance testing are colored orange. At least one lane must be selected.

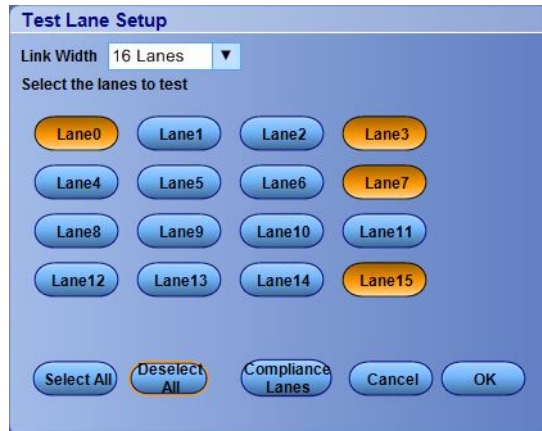

- The Link Width parameter sets the lanes that are tested.
- The lanes required for compliance testing are selected by default.
- Click **Select All** to select all the lanes.
- Click **Deselect All** to clear the selected lanes.
- Click **Compliance Lanes** to set all lanes required for compliance testing for the specified link width value.

**Automated DUT control setup.** The Automated DUT Control dialog box sets the parameters needed for automatic toggling of the DUT into different test modes (generation/equalization). DUT automation requires the use of a signal source (AFG or AWG).

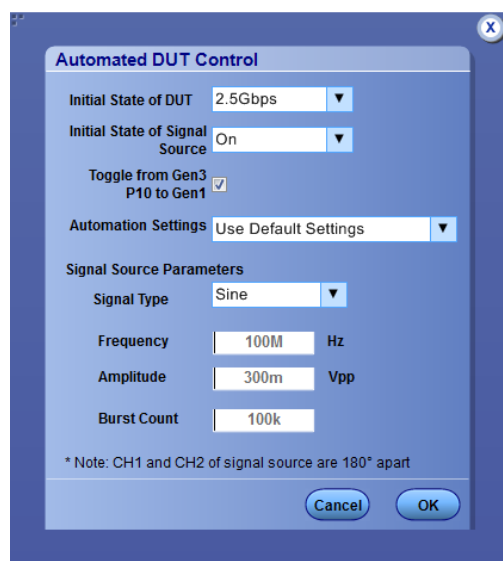

**Initial State of DUT:** Sets the starting state of the DUT.

**Initial State of Signal Source:** Sets the AFG/AWG state to **On** (default) or **Off**. The On state enables the AFG/AWG output before the application starts signal acquisition. Some DUTs will toggle to the next signal state when the AFG/AWG initial state is On. Set the initial state to Off for these types of DUTs before running automated tests.

**Toggle from Gen3 P10 to Gen1:** Sets the DUT to toggle automatically to Gen1 after Gen3 P10 test execution.

**Automation Settings:** The Automation Settings values are Use Default Settings, Manually Configure Settings, and Custom Settings:

- **Use Default Settings:** The signal source parameters are set to predefined values as recommended by the test specification. The signal source parameter fields are disabled and cannot be edited.
- **Manually Configure Settings:** The signal source parameters are set directly at the AFG or AWG. The signal source parameter fields are disabled and cannot be edited. The PCIe application turns on or off the signal source without changing the settings.
- **Use Custom Settings:** The signal source parameters are set to the values specified in the Signal Source Parameters area. The signal source parameter fields are enabled.

**Signal Type:** Valid signal types are **Sine** and **Square**.

**Frequency, Amplitude:** Sets the AFG to output the specified frequency and amplitude values.

**Burst Count:** Sets the AFG to output the specified signal burst count.

---

**NOTE.** *Ch 1 and Ch 2 on the AFG source are set to 180° phase difference in all modes except Manually Configure Settings.*

---

---

**NOTE.** *Using DC Caps or Manual toggle, you can eliminate the automatic toggling issues that is due to DC offset.*

---

**Select tests.** Use the **Test Selection** tab to select the Signal Test and Preset Test(s) (for Gen3 only).

---

**NOTE.** *All tests are selected by default.*

---

1. Click **Setup > Test Selection**.
2. Select the test(s) to run:
  - Click + to expand a group of commands. Click the check box adjacent to a test group to select all tests in that group. Click check boxes adjacent to individual tests to select those tests.
  - Click **Deselect All** button to deselect all tests. All tests are selected by default.
  - Click **Select All** button to select all tests.
  - Click **Show MOI** button to open the MOI (Methods of Implementation) document for all measurements.
  - Click **Schematic** button to view a diagram that shows the correct DUT and equipment setup for the selected test. Use to verify your test equipment setup before running the test.
3. For Gen3 testing:
  - (Gen3 only) Click the **Preset Test** tab and select the presets tests.
  - (Gen3 only) Click the **Lanes** button in the Preset Test tab to view and select which lanes to use for preset testing. At least one lane must be selected.

**See also.**

[Set acquisition parameters](#)

[About setting up tests](#)

**Acquisitions tab.**

**Set acquisition parameters.** Use the **Acquisition** tab in the Setup panel to view and select test acquisition parameters, including the signal source channels, acquisition options, and waveform save options. This panel also shows the signal inputs required for the selected DUT parameters.

Contents displayed on this tab depend on whether you acquire active waveforms or use prerecorded waveform files (as set in the **DUT** tab. Contents displayed on this tab also depend on detected probes and the specified DUT type.

#### Active waveforms.

Figure 1: Acquisitions tab: using active waveforms

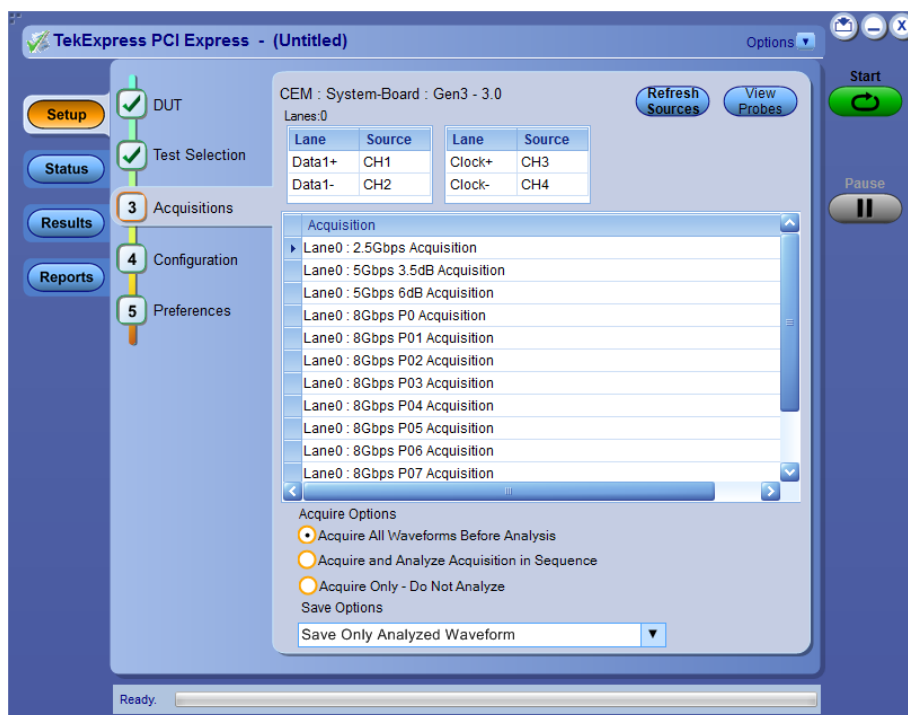

- Click the *Source* fields to select signal sources for the listed lanes. The number of lanes shown depends on the parameters set in the DUT tab.
- Click **Refresh Sources** to refresh the probe configuration after changing any probes. (This button performs the same function as the Refresh button in the Probe Configuration dialog box.)

- Click **View Probes** to view the detected probe configuration. Use the View Probes dialog box to enable or disable probe signal source access in the application.

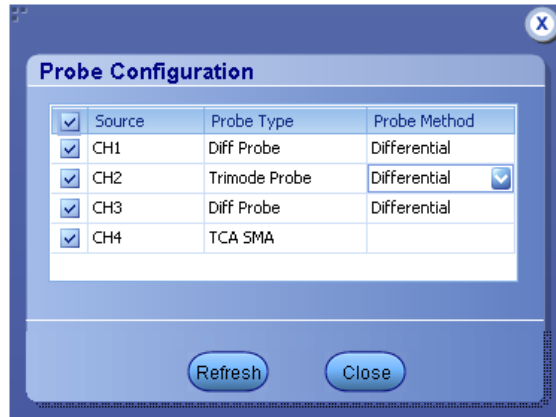

Only Differential option is available under Probe Method for Trimode probes.

- Click the *Acquire Options* controls to set how the application acquires and analyzes signals.
- Click the *Save Options* field to set how the application saves acquired waveforms (save all waveforms, save all waveforms after applying filters, or discard all waveforms after running analysis).

**Prerecorded waveforms.**

**Figure 2: Acquisitions tab: using prerecorded waveforms**

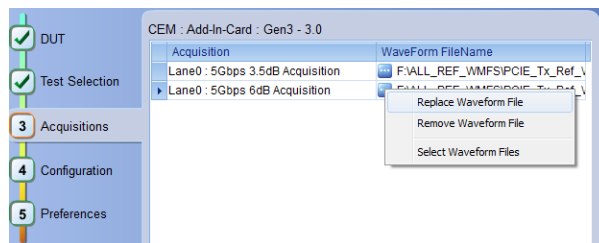

When using prerecorded waveform files, this panel lists available prerecorded waveform files. You can only select the source of the prerecorded waveform file for each test. See *Set acquisition waveform source for prerecorded waveform files*.

**Set acquisition options.** Select an **Acquire Option** to set the order in which waveforms are acquired and analyzed:

- **Acquire All Waveforms Before Analysis:** Acquire all waveforms required by tests before performing analysis. All required user interventions (such as connecting to different lanes) are completed, and waveforms acquired, before the analysis is run. You can turn off the DUT after the acquisitions are completed.
- **Acquire and Analyze Acquisition in Sequence:** Acquire waveforms and analyze for each test before proceeding to the next test. Use this setting to stop the testing when an error occurs, investigate and correct DUT, instrumentation connections, or application settings, then restart testing.
- **Acquire Only – Do Not Analyze:** Acquire all waveforms required by tests, and then stop (do not use waveforms to perform test analysis). Use this setting for testing multiple DUTs once the test and application settings are correct. Acquire all required waveforms and save the session for each DUT, and then recall the waveforms at a later point to analyze in *Prerecorded* mode.

**See also.**

*[Set acquisitions signal source](#)*

*[Set acquisition waveform save options](#)*

**Set acquisition waveform save options.** Select a **Save Option** to set how to save acquired test waveforms:

- **Save All the Waveforms:** Save all waveforms that were acquired for tests.
- **Save Only Analyzed Wfms:** Save waveforms that was used for analysis.
- **No Waveforms Saved – Discard after analysis:** Delete all acquired waveform data after analysis is complete.

Waveforms are saved to a folder that is unique to each session (a session starts when you click the Start button). The folder path is X:\PCI Express\Untitled Session\<<dutid>\<date>\_<time>. Images created for each analysis, CSV files with result values, reports, and other information specific to that particular execution are also saved in this folder. When the session is saved, content is moved to that session folder and the “Untitled Session” gets replaced by the session name.

**Waveform file names.** This application uses file name conventions to access the Data and Clock waveforms. It is recommended to save the waveforms with following file names.

- Differential data waveform: *Tek\_PCIe\_01\_8Gbps\_Ln00\_P0\_d\_Diff.wfm*
- Differential clock waveform: *Tek\_PCIe\_01\_8Gbps\_Ln00Clk\_P0\_d\_Diff.wfm*
- Single ended data positive waveform:  
*Tek\_PCIe\_01\_8Gbps\_Ln00\_P0\_d\_Pos.wfm*
- Single ended data negative waveform:  
*Tek\_PCIe\_01\_8Gbps\_Ln00\_P0\_d\_Neg.wfm*
- Others:  
*Tek\_PCIe\_Slot\_DataRate\_LaneNumber\_PresetNumber\_Data\_Differential.wfm*

**See also.**

[Set acquisitions signal source](#)

[Set acquisition waveform source for prerecorded waveform files](#)

[Set acquisition Acquire options](#)



**Set acquisition waveform source for prerecorded waveform files.** When using prerecorded waveform files, there are no acquisition source selections to make. You can only select the source of the prerecorded waveform files for each test.

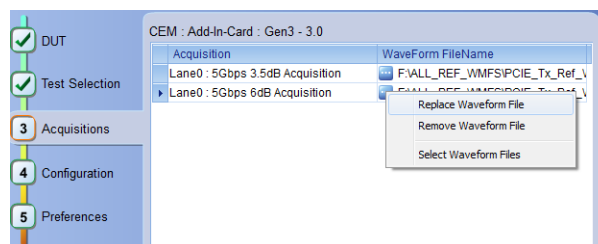

If you selected to use a prerecorded waveform file (in the DUT tab), the lane and source fields are not applicable and are not shown. The Acquisition tab instead shows a table of the waveforms used for the required test acquisitions.

You can load a different waveform file for each table item. To load a different waveform file:

1. Click the ellipsis button (⋮) of the waveform file to change.
2. Select the waveform task to perform (replace, remove, or select the waveform file).
3. Use the dialog box to navigate to and select the waveform file with which to replace the current file. You need to select all required differential waveforms for analysis. For example, select one data waveform and one clock waveform for each acquisition (except 2.5 Gbps) for testing a system board.

---

**NOTE.** Clock signals are not required for Gen1 (2.5 Gbps data rate) testing.

---

**See also.**

[Set acquisition signal source](#)

[Set acquisition options](#)

[Set acquisition waveform save options](#)

**Set acquisition signal source.** Use this procedure to set the channel sources for live waveform acquisitions. The number of Lane and Source fields shown depends on the number of lanes selected for testing in the **DUT** tab.

1. Click **Setup > Acquisitions**.
2. Click in the Source column of the field to change.
3. Click the arrow button to list available sources from which to select.

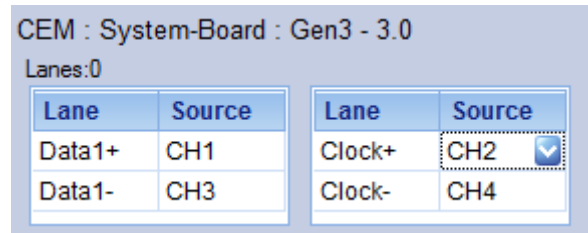

**See also.**

*[Set acquisition options](#)*

*[Set acquisition waveform save options](#)*

*[Set acquisition waveform source for prerecorded waveform files](#)*

**Configure test parameters.**

**About configuring test parameters.** Use the **Configuration** tab to view and set global and individual measurement parameters for the selected tests. Which fields are available to edit depends on the selected Sigtest mode (Compliance or User Defined) as set in this tab or the DUT tab.

**NOTE.** You cannot change test parameters that are grayed out.

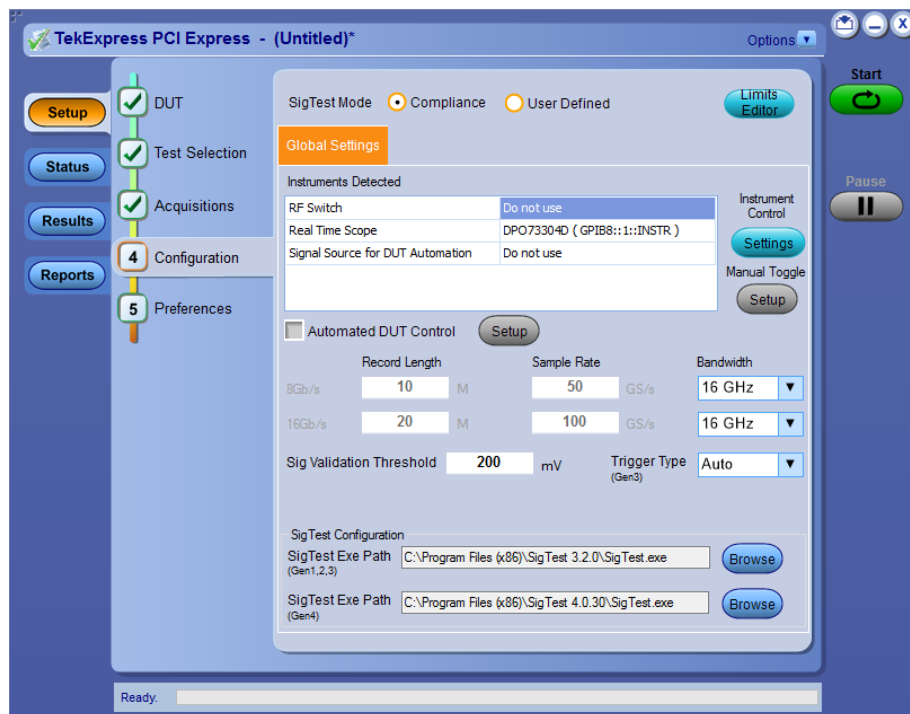

**See also.**

*Configuration tab parameters*

*About setting up tests*

*About running tests*

**Configuration tab parameters.** The following table lists the Configuration tab settings and parameters.

**Table 8: Configuration tab parameters**

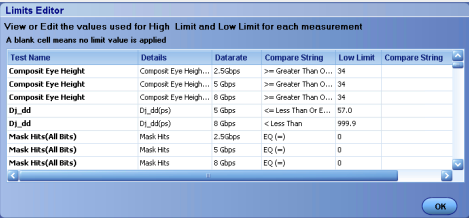
Parameter	Description
SigTest Mode	<p>Determines whether test parameters are in compliance or can be edited (User Defined Mode).</p> <ul style="list-style-type: none"> <li>Compliance: Most test parameter values cannot be edited.</li> <li>User Defined: Enables editing of most test parameters.</li> </ul>
Limits Editor	<p>Shows the upper and lower limits for the applicable measurement using different types of comparisons.</p> <p>In Compliance Mode, use the Limits Editor to view the measurement high and low limits used for selected tests.</p> <p>In User Defined Mode, use the Limits Editor to edit the limit settings.</p>  <p>To edit a value, click that field and either select from the displayed list or enter a new value. Use the bottom scroll bar to view all available fields.</p>
Instruments Detected	<p>Displays a list of the connected instruments found during the instrument discovery. Instrument types include equipment such as oscilloscopes and signal generators.</p>
Instrument Control	<p>Click <b>Settings</b> to <a href="#">search for connected instruments</a> and view instrument connection details. Connected instruments displayed here can be selected for use under Global Settings in the test configuration section.</p>
Manual Toggle	<p>Click <b>Setup</b> to manually toggle AWG or AFG for PCIe presets.</p> <p>This is enabled when the Signal Source for DUT Automation in Instruments Detected is selected.</p>
Automated DUT Control	<p>Enables automatic toggling of test patterns for DUT tests. Requires an AFG instrument as part of the test setup. Click <b>Setup</b> to configure the DUT automation settings.</p>

Parameter	Description
Record Length, Sample Rate, Bandwidth	<p>These settings apply to all tests selected for the indicated data rate.</p> <ul style="list-style-type: none"> <li>■ Record Length: Specifies the waveform record length.</li> <li>■ Sample Rate: Specifies the oscilloscope sample rate to use for all tests.</li> <li>■ Bandwidth: Specifies the oscilloscope bandwidth to use for all tests.</li> </ul>
Sig Validation Threshold	Sets the threshold voltage to use for signal validation.
Trigger Type (Gen3)	<ul style="list-style-type: none"> <li>■ Edge</li> <li>■ Width</li> <li>■ Auto</li> </ul>
SigTest Configuration	Select the SigTest executable (.exe) for Gen1, 2, 3, and 4. Click <b>Browse</b> and select the .exe. The default path is C:\Program Files (x86)\SigTest x.x.x\ where x.x.x is the version number of the SigTest.

**See also.**[About acquisition](#)[De-embed using filter files](#)

**Set test notification preferences.** Use the Preferences tab to set the application action when a test measurement fails:

1. Click **Setup > Preferences**.
2. Select the measurement failure action:
  - Select **On Test Failure, pause the test and let me investigate** to pause the test when a failure occurs. Click the **Status** and **Results** buttons to explore the failure condition. To resume the test, click **Continue**.
  - Select **On Test Failure, stop and notify me of the failure** to stop the test and send an email when a test fails. Click **Email Settings** to verify that **Email Test Results when complete or on error** is selected, and to verify the address to which the email is sent.

**Preferences tab parameters.** Use the Preferences tab to set the application action when a test measurement fails, and how the application handles pop-up error, warning, and information messages during test sequences.

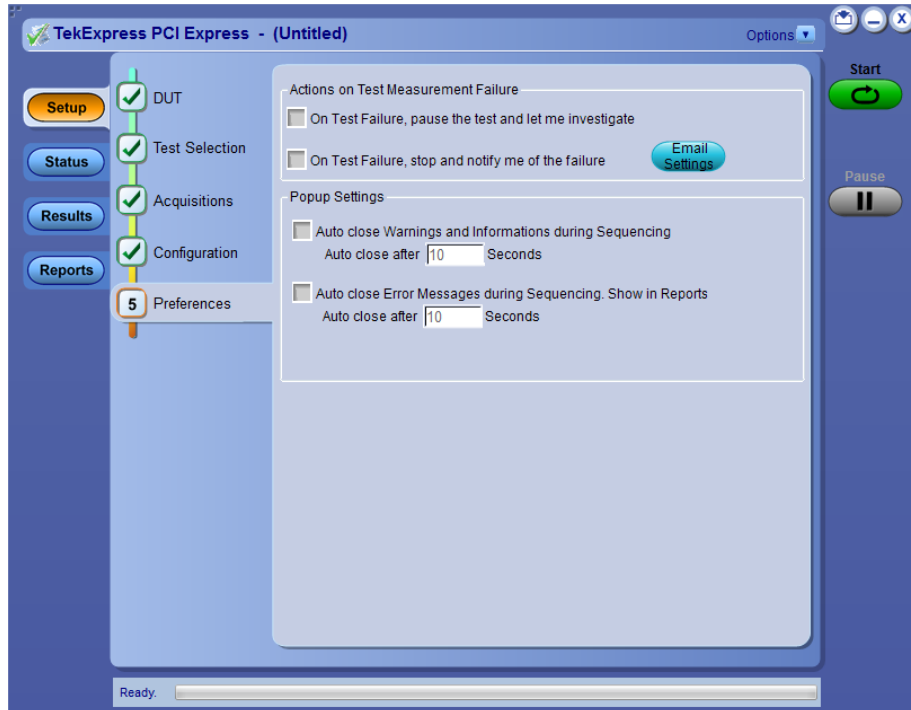

**Table 9: Preferences tab parameters**

Parameter	Description
<b>Actions on Test Measurement Failure</b>	
On Test Failure, stop and notify me of the failure	Stops the test sequence and sends an email when a test fails.
On Test Failure, pause the test and let me investigate	Pauses the test when a failure occurs. Click the <b>Status</b> and <b>Results</b> buttons to explore the failure condition. To resume the test, click <b>Continue</b> .
<b>Email Settings</b> button	Click <b>Email Settings</b> to open the Email Settings dialog box and verify that <b>Email Test Results when complete or on error</b> is selected, and verify the address to which the email is sent.
<b>Popup Settings</b>	
Auto close Warnings and Informations during Sequencing	Sets the time for how long the application displays Warning and Information pop-up messages before automatically closing the messages and continues testing by taking the default action.

Parameter	Description
Auto close Error Messages during Sequencing. Show in Reports	Sets the time for how long the application displays Error pop-up messages before automatically closing the messages and continuing with testing. Message content is added to the test report.

**See also.**

*[About setting up tests](#)*

*[Select report options](#)*

**Status panel overview**

The Status panel provides status on test acquisition and analysis (Test Status tab) and a listing of test tasks performed (Log View tab). The application opens the Test Status tab when you start a test run. You can select the Test Status or the Log View tab to view these items while tests are running.

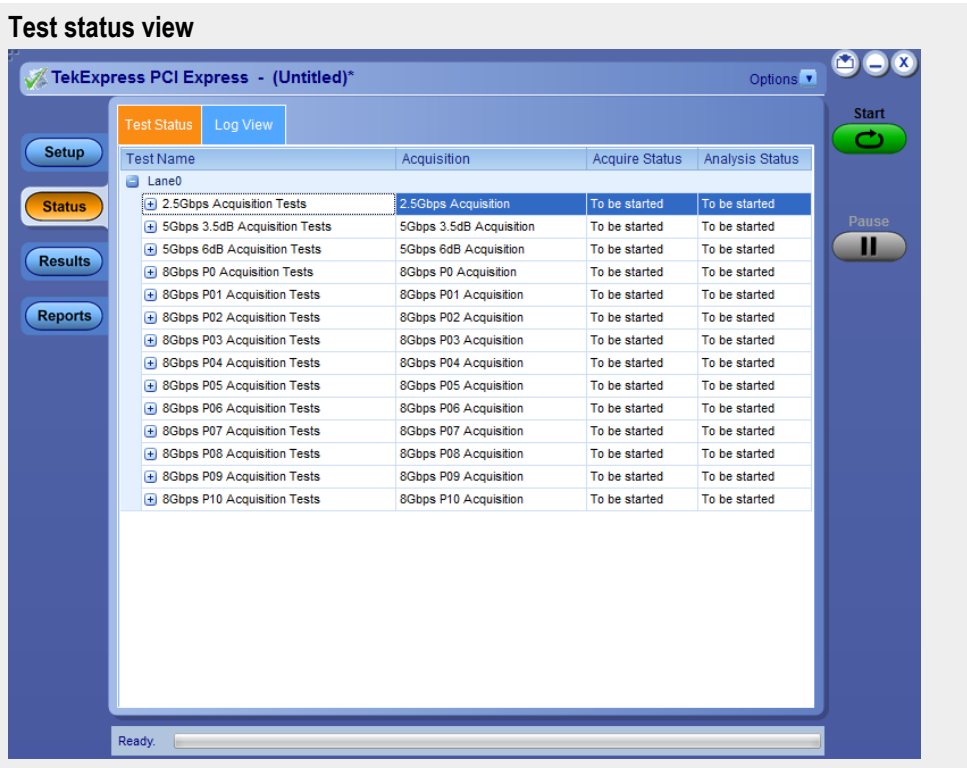

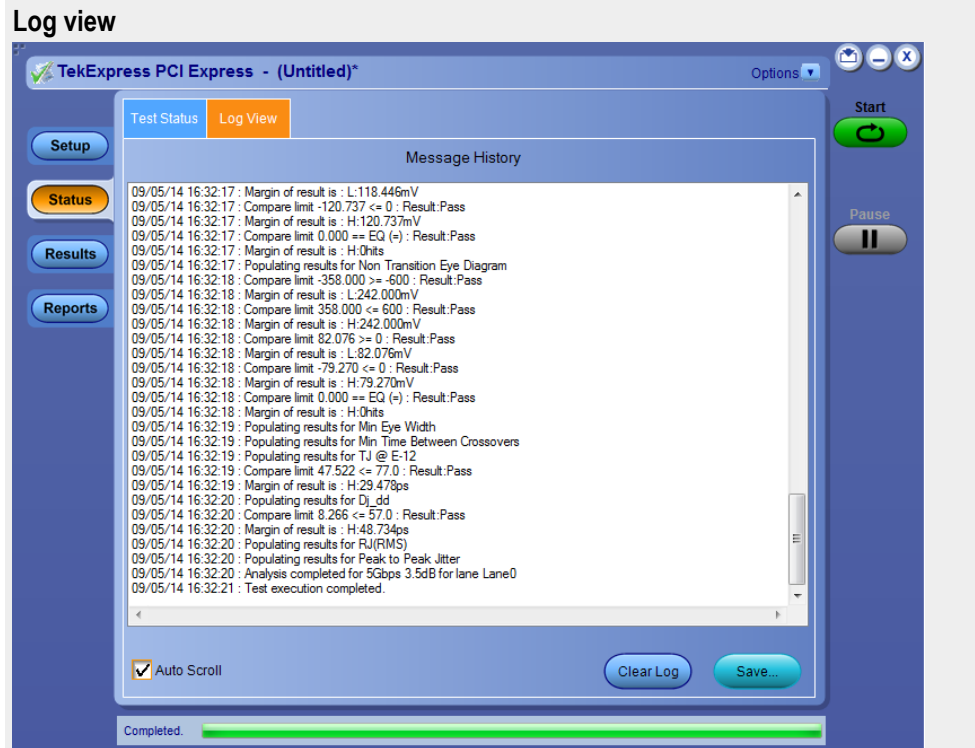

The Log View display has several viewing options:

- **Message History**: This window timestamps and displays all run messages.
- **Auto Scroll** button : Select this check box to have the program automatically scroll down as information is added to the log during the test.
- **Clear Log** button : Click this button to clear all messages from the display.
- **Save** button : Click this button to save the log file as a text file. A standard Save File window is displayed to name and save the file.

**See also.**

[Application panel overview](#)



## Results panel

**Results panel overview.** When a test finishes, the application switches to the Results panel to display a summary of signal and preset test results. The Overall Test Result is displayed at the top left of the Results table. If all of the tests for the session pass, the overall test result is **Pass**. If one or more tests fail, the overall test result is **Fail**.

Set viewing preferences for this panel from the Preferences menu in the upper right corner. Viewing preferences include showing whether a test passed or failed, summary results or detailed results, and enabling wordwrap.

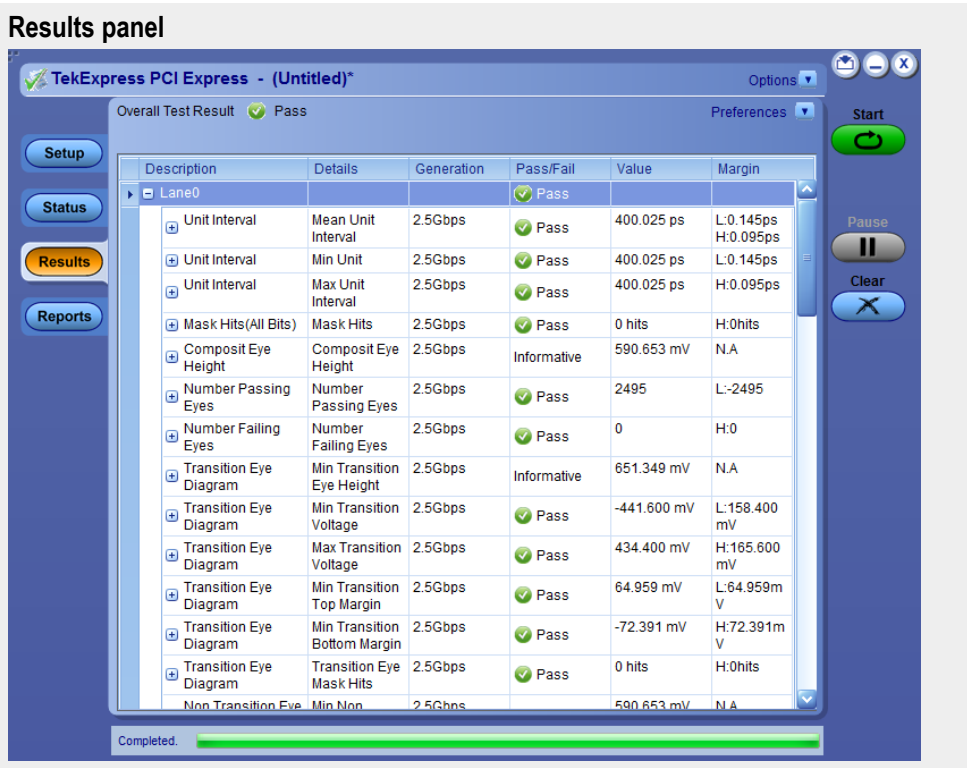

The screenshot displays the TekExpress PCI Express Results panel. At the top, the overall test result is 'Pass'. Below this, a table lists various test parameters for Lane0. The table has columns for Description, Details, Generation, Pass/Fail, Value, and Margin. The tests include Unit Interval (Mean, Min, Max), Mask Hits, Composit Eye Height, Number Passing/Failing Eyes, and Transition Eye Diagram (Min/Max Voltage, Top/Bottom Margin, Mask Hits). All tests are marked as 'Pass' or 'Informative'. A 'Completed' progress bar is visible at the bottom.

Description	Details	Generation	Pass/Fail	Value	Margin
Overall Test Result: <span style="color: green;">✔</span> Pass					
▶ Lane0			<span style="color: green;">✔</span> Pass		
+ Unit Interval	Mean Unit Interval	2.5Gbps	<span style="color: green;">✔</span> Pass	400.025 ps	L:0.145ps H:0.095ps
+ Unit Interval	Min Unit	2.5Gbps	<span style="color: green;">✔</span> Pass	400.025 ps	L:0.145ps
+ Unit Interval	Max Unit Interval	2.5Gbps	<span style="color: green;">✔</span> Pass	400.025 ps	H:0.095ps
+ Mask Hits(All Bits)	Mask Hits	2.5Gbps	<span style="color: green;">✔</span> Pass	0 hits	H:0hits
+ Composit Eye Height	Composit Eye Height	2.5Gbps	Informative	590.653 mV	N.A
+ Number Passing Eyes	Number Passing Eyes	2.5Gbps	<span style="color: green;">✔</span> Pass	2495	L:-2495
+ Number Failing Eyes	Number Failing Eyes	2.5Gbps	<span style="color: green;">✔</span> Pass	0	H:0
+ Transition Eye Diagram	Min Transition Eye Height	2.5Gbps	Informative	651.349 mV	N.A
+ Transition Eye Diagram	Min Transition Voltage	2.5Gbps	<span style="color: green;">✔</span> Pass	-441.600 mV	L:158.400 mV
+ Transition Eye Diagram	Max Transition Voltage	2.5Gbps	<span style="color: green;">✔</span> Pass	434.400 mV	H:165.600 mV
+ Transition Eye Diagram	Min Transition Top Margin	2.5Gbps	<span style="color: green;">✔</span> Pass	64.959 mV	L:64.959m V
+ Transition Eye Diagram	Min Transition Bottom Margin	2.5Gbps	<span style="color: green;">✔</span> Pass	-72.391 mV	H:72.391m V
+ Transition Eye Diagram	Transition Eye Mask Hits	2.5Gbps	<span style="color: green;">✔</span> Pass	0 hits	H:0hits
+ Non Transition Eye	Min Non	2.5Gbps		590.653 mV	N.A

When a test finishes, the application switches to the Results panel, which displays a summary of test results.

**NOTE.** NAN (Not A Number) is displayed in the test results if an invalid waveform was supplied for the test.

Each test result occupies a row in the Results table. By default, results are displayed in summary format with the measurement details collapsed and with the Pass/Fail column visible. Change the view in the following ways:

- To expand all tests listed, select **View Results Details** from the Preferences menu in the upper right corner.
- To expand and collapse tests, click the plus and minus buttons.
- To collapse all expanded tests, select **Preferences > View Results Summary**.
- To remove or restore the Pass/Fail column, select **Preferences > Show Pass/Fail**.

- To enable or disable the wordwrap feature, select **Preferences > Enable Wordwrap**.
- To expand the width of a column, place the cursor over the vertical line that separates the column from the column to the right. When the cursor changes to a double-ended arrow, hold down the mouse button and drag the column to the desired width.
- To group and view the tests by Lane, Test, Equalization, Pass/Fail, use the Preferences option in Results Panel.
- To clear all test results displayed, click **Clear**.

**See also.**

[View a report](#)

[About panels](#)

**View test-related files.** Files related to tests are stored in the My TekExpress\PCI Express folder. Each test setup in this folder has a test setup file and a test setup folder, both with the test setup name.

The test setup file is preceded by the TekExpress icon and usually has no visible file name extension.

Inside the test setup folder is another folder named for the DUT ID used in the test sessions. The default is DUT001.

Inside the DUT001 folder are the session folders and files. Each session also has a folder and file pair, both named for the test session using the naming convention (date)\_(time). Each session file is stored outside its matching session folder:

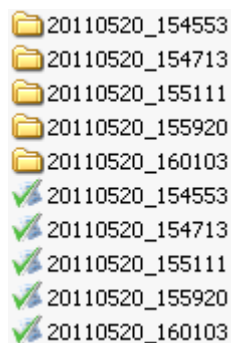

Each session folder contains image files of any plots generated from running the test session. If you selected to save all waveforms or ran tests using prerecorded waveform files, these are included here.

The first time you run a new, unsaved session, the session files are stored in the Untitled Session folder located at ..\My TekExpress\PCI Express. When you name and save the session, the files are placed in a folder with the name that you specify. A copy of the test files stay in the Untitled Session folder until you run a new test or until you close the PCIe application.

**See also.**

*[File name extensions](#)*

*[Before you click start](#)*

**Reports panel** **Reports panel overview.** Use the Reports panel to browse for reports, name and save reports, select test content to include in reports, and select report viewing options.

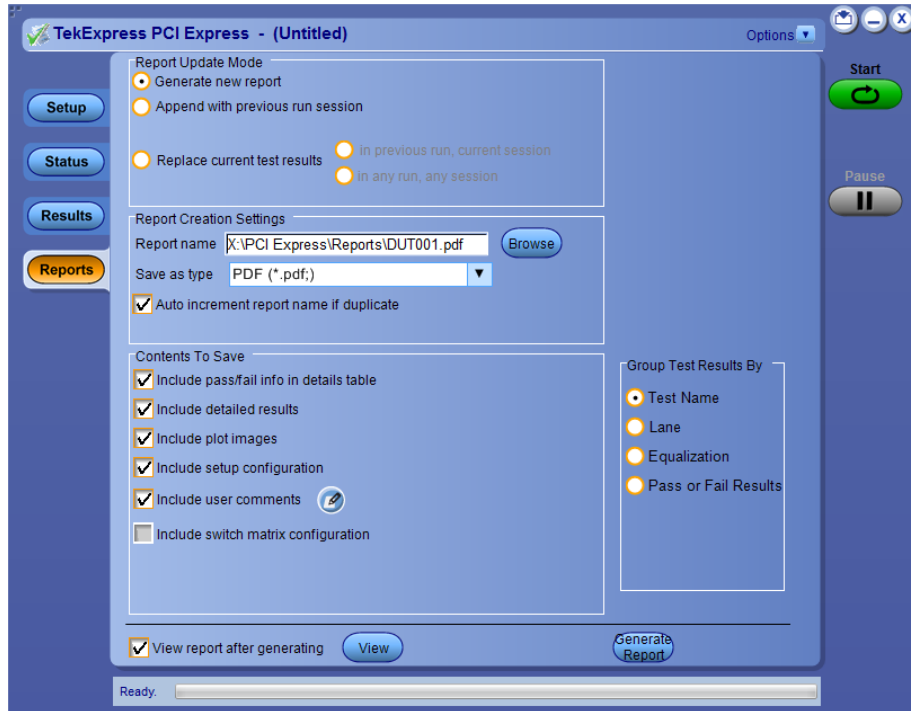

For information on setting up reports, see [Select report options](#). For information on viewing reports, see [View a Report](#).

**See also.**

[About panels](#)

**Select report options.** Click the **Reports** button and use the Reports panel controls to select which test result information to include in the report, and the naming conventions to use for the report. For example, always give the report a unique name or select to have the same name increment each time you run a particular test.

Select report options before running a test or when creating and saving test setups. Report settings are included in saved test setups.

In the Reports panel, select from the following report options:

**Table 10: Report options**

Setting		Description
<b>Report Update Mode</b>		
Generate new report		Creates a new report.
Append with previous run session		Appends the latest test results to the end of the current test results report.
Replace current test results	In previous run, current session	Select to replace current test results in the report with the test result(s) of previous run in current session.
	In previous run, current session	Select to replace current test results in the report with the test result(s) in selected run session's report. Click  and select test result of any other run session from another setup.
<b>Report Creation Settings</b>		

Setting	Description
Report name	<p>Displays the name and location from which to open a report. The default location is at <i>My TekExpress\PCI Express\Reports\</i>. The report file in this folder gets overwritten each time you run a test unless you specify a unique name or select to auto increment the report name, this option is selected by default.</p> <p>Change the report name or location.</p> <p>Do one of the following:</p> <ul style="list-style-type: none"> <li>■ In the Report Path field, type over the current folder path and name.</li> <li>■ Double-click in the Report Path field and then make selections from the popup keyboard and click the <b>Enter</b> button.</li> </ul> <p>Be sure to include the entire folder path, the file name, and the file extension. For example: C:\Documents and Settings\your user name\My Documents\My TekExpress\PCI Express\DUT001_Test_72.7.1.3.mht.</p> <p>Open an existing report.</p> <p>Click <b>Browse</b> button to locate and select the report file and then click <b>View</b> button at the bottom of the panel.</p>
Save as type	<p>Saves a report in the specified file type. Lists supported file types to choose from.</p> <hr/> <p><b>NOTE.</b> <i>If you select a file type different from the default, be sure to change the report file name extension in the Report Name field to match. By default, report is generated in PDF format but you can also generate the report in MHT format.</i></p>
Auto increment report name if duplicate	<p>Sets the application to automatically increment the name of the report file if the application finds a file with the same name as the one being generated. For example: DUT001, DUT002, DUT003. This option is enabled by default.</p> <hr/> <p><b>NOTE.</b></p> <p><i>If you choose, say 'TID_345', for 'DUT ID', the next report for a new run in the same session will be named 'TID_346' which may contradict or cause confusion. In this case, it is suggested that you choose 'TID_345_001' for DUT ID, since the next runs in the same session will have report names generated with the last suffix auto-incremented as follows – 'TID_345_002' and so on.</i></p>

Setting	Description
<b>Contents To Save</b>	
Include pass/fail info in details table	Select to include the column labeled Test Result (indicating whether the test passed or failed) in the report. For details, see Report Contents in <a href="#">View a report</a> .
Include detailed results	Sets the application to include parameter limits, execution time, and test-specific comments generated during the test.
Include plot images	Sets the application to include plotted diagrams such as Eye diagrams.
Include setup configuration	Sets the application to include hardware and software information in the summary box at the top of the report. Information includes: the oscilloscope model and serial number, probe model and serial number, the oscilloscope firmware version, SPC and factory calibration status, and software versions for applications used in the measurements.
Include user comments	Select to include any comments about the test that you or another user added in the DUT tab of the Setup panel. Comments appear in the Comments section, under the summary box at the beginning of each report.
Include switch matrix configuration	Select to include switch matrix configuration.
<b>Group Test Results by</b>	
Test Name	Select to display the test results by test name.
Lane	Select to display the test results by lane.
Equalization	Select to display the test results by equalization.
Pass or Fail Results	Select to display the test results by pass or fail results.
<b>Other</b>	
View Report After Generating	Automatically opens the report in a Web browser when the test completes. This option is selected by default.
<b>View</b> button	Click to view the most current report.
<b>Generate Report</b> button	Generates a new report based on the current analysis results.

**See also.**[View a report](#)[About setting up tests](#)

**View a report.** The application automatically generates a report when test analysis is completed and displays the report in your default Web browser (unless the **View Report After Generating** check box is not selected). If this check box is not cleared, or to view a different test report, do the following:

1. Click the **Browse** button and locate and select the report file to view.
2. In the Reports panel, click **View**.

For information on changing the file type, file name, and other report options, see [Select report options](#).



**Report contents.** A report shows specified test details, as defined in the Reports panel.

**NOTE.** *NAN (Not A Number)* is displayed in the report contents if an invalid waveform was supplied for the test. In PDF generated report, hyperlinks do not work and result table for some measurements maybe spread across a page.

### Setup configuration information

Setup configuration information is listed in the summary box at the beginning of the report. This information includes the oscilloscope model and serial number, and software versions. To exclude this information from a report, clear the **Include Setup Configuration** check box in the Reports panel before running the test.

Tektronix				TekExpress PCI Express			
Module Test Report							
<b>Setup Information</b>							
DUT ID	DUT001	DPOJET Version	10.0.5.1	Scope Model	MS073304DX		
Date/Time	2017-09-12 11:15:49	Scope Serial Number	PQ00005	Scope Calibration	PASS:UNCAL		
Device Type	U.2(SFF-8639)	Scope F/W Version	10.7.1 Build 16	Probe1 Model	TCA-SMA		
TekExpress Version	PCI Express:10.3.1.43 Framework:4.2.9.5	Probe2 Model	TCA292D	Probe2 Serial Number	N/A		
Test Mode	SigTest User Defined	Probe3 Model	TCA-SMA	Probe4 Model	TCA-SMA		
Spec Version	Gen3 - 3.0						
SigTest Version	SigTest 3.2.0(Gen1,2,3)						
Slot Number	01						
Overall Execution Time	0:06:55						
Overall Test Result	Pass						
DUT COMMENT:	DUT001						
<b>Test Name Summary Table</b>							
<a href="#">Unit Interval Gen3</a>							
<a href="#">Composit Eye Height Gen3</a>							
<a href="#">Transition Eye Diagram Gen3</a>							
<a href="#">Non Transition Eye Diagram Gen3</a>							
<a href="#">Min Eye Width Gen3</a>							
<a href="#">Min Time Between Crossovers Gen3</a>							
<a href="#">J1 @ E-12 Gen3</a>							
<a href="#">Dj_d4 Gen3</a>							
<a href="#">RIRMS Gen3</a>							
<a href="#">Peak to Peak Jitter Gen3</a>							

### Test result summary

The Test Result column indicates whether a test passed or failed. If the test passed, the column cell is green. If the test failed, it is red. To exclude this information from a report, clear the **Include pass/fail info in details table** check box in the Reports panel before running the test.

Unit Interval Gen1								
Measurement	Lane Name	Data Rate	Equalization	Measured Value	Test Result	Margin	Low Limit	High Limit
<b>Details</b>								
Mean Unit Interval	Lane03	2.5Gbps	-	400.000 ps	Pass	L:0.120ps H:2.120ps	399.88	402.12
Min Unit Interval	Lane03	2.5Gbps	-	399.999 ps	Pass	L:0.119ps	399.88	N.A
Max Unit Interval	Lane03	2.5Gbps	-	400.000 ps	Pass	H:2.120ps	N.A	402.12
COMMENTS		Found Amplitude = 889,Found Data Rate = 2.5,Pattern Check = Pass PCI Express Base Specification Revision 4.0 v0.5 Table 4-18: Transmitter Specifications						
<a href="#">Back to Summary Table</a>								
Transition Eye Diagram Gen1								
Measurement	Lane Name	Data Rate	Equalization	Measured Value	Test Result	Margin	Low Limit	High Limit
<b>Details</b>								
Min Transition Eye Height	Lane03	2.5Gbps	-	759.436 mV	Informative	N.A	N.A	N.A
Min Transition Voltage	Lane03	2.5Gbps	-	-497.075 mV	Pass	L:102.925mV	-600	N.A
Max Transition Voltage	Lane03	2.5Gbps	-	488.192 mV	Pass	H:111.808mV	N.A	600
Min Transition Top Margin	Lane03	2.5Gbps	-	239.710 mV	Pass	L:239.710mV	0	N.A
Min Transition Bottom Margin	Lane03	2.5Gbps	-	-245.726 mV	Pass	H:245.726mV	N.A	0
Transition Eye Mask Hits	Lane03	2.5Gbps	-	Result Unavailable	N.A	N.A	N.A	N.A
COMMENTS		Found Amplitude = 889,Found Data Rate = 2.5,Pattern Check = Pass PCI Express Card Electromechanical Specification Revision 4.0 v0.5 Table 4-16:						
<a href="#">Back to Summary Table</a>								

**See also.**

*Results panel overview*

*View test-related files*

---

# Setting up and configuring tests

## About setting up tests

Set up tests using the tabs in the [Setup panel](#). Settings in the DUT tab use a top-down, left-to-right logic flow, so that any parameter that affects or acts as a filter for other parameters appears either to the top of or to the left of the affected parameters.

Tests are saved when you save a test setup. To avoid overwriting test results, remember to assign a unique name to the test either before running it or immediately after.

### See also

[Test setup overview](#)

[Before you click start](#)

[About test setups](#)

[About running tests](#)

## Equipment connection setup

Click the **Setup > Test Selection > Schematic** button to open a PDF file that shows the compliance test setup diagrams (instrument, DUT, and cabling) for supported testing configurations.

### See also

[Minimum system requirements](#)

[View connected instruments](#)

[About setting up tests](#)

**Equipment connection setup through switch system**

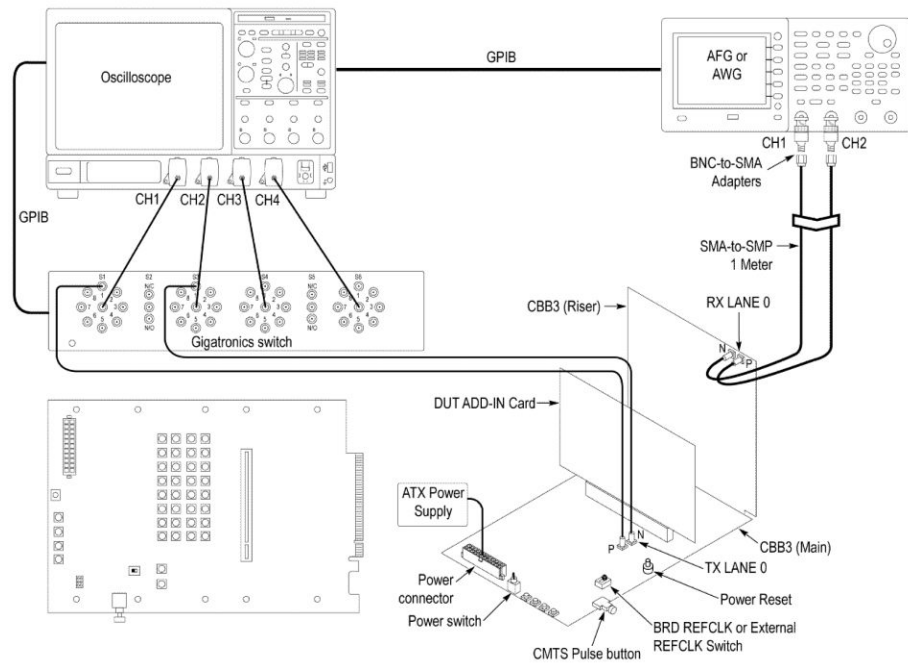

**Figure 3: Add-In card connection setup through switch system**

Gigatronics Switch: DUT Lane to Signal connection mapping			
TX LANE 0 P	S1 (relay) > Signal 1	TX LANE 0 N	S3 > Signal 1
TX LANE 1 P	S1 > Signal 2	TX LANE 1 N	S3 > Signal 2
TX LANE 2 P	S1 > Signal 3	TX LANE 2 N	S3 > Signal 3
TX LANE 3 P	S1 > Signal 4	TX LANE 3 N	S3 > Signal 4
TX LANE 4 P	S1 > Signal 5	TX LANE 4 N	S3 > Signal 5
TX LANE 5 P	S1 > Signal 6	TX LANE 5 N	S3 > Signal 6
TX LANE 6 P	S1 > Signal 7	TX LANE 6 N	S3 > Signal 7
TX LANE 7 P	S1 > Signal 8	TX LANE 7 N	S3 > Signal 8
TX LANE 8 P	S4 > Signal 1	TX LANE 8 N	S6 > Signal 1
TX LANE 9 P	S4 > Signal 2	TX LANE 9 N	S6 > Signal 2
TX LANE 10 P	S4 > Signal 3	TX LANE 10 N	S6 > Signal 3
TX LANE 11 P	S4 > Signal 4	TX LANE 11 N	S6 > Signal 4
TX LANE 12 P	S4 > Signal 5	TX LANE 12 N	S6 > Signal 5
TX LANE 13 P	S4 > Signal 6	TX LANE 13 N	S6 > Signal 6
TX LANE 14 P	S4 > Signal 7	TX LANE 14 N	S6 > Signal 7
TX LANE 15 P	S4 > Signal 8	TX LANE 15 N	S6 > Signal 8

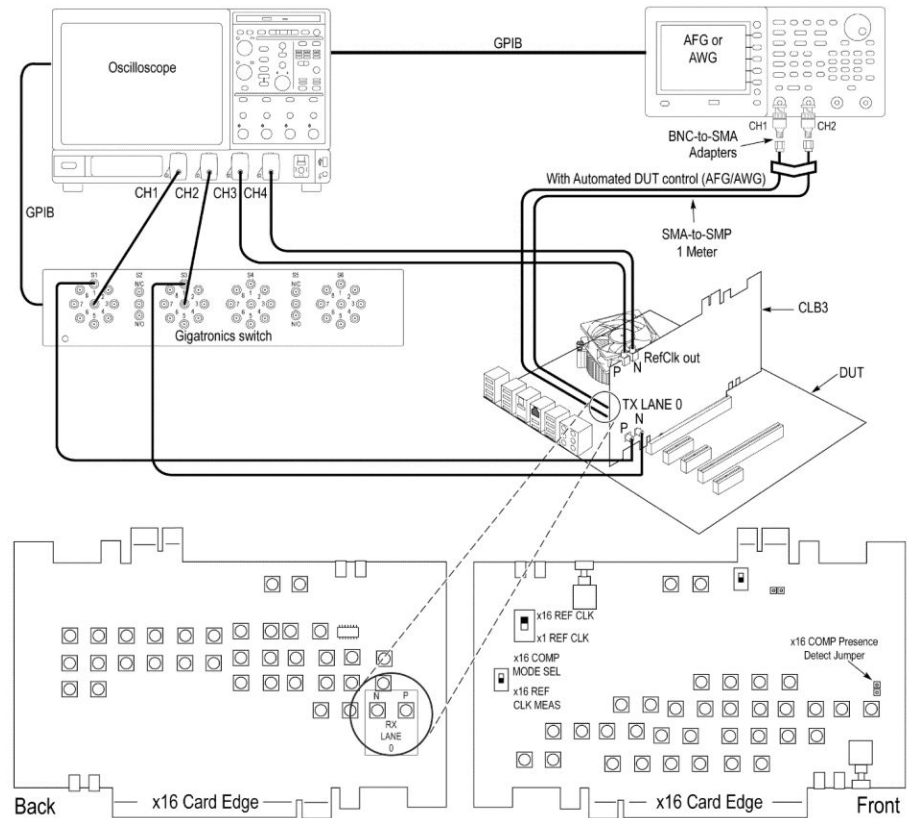

Figure 4: System board (normal) connection setup through switch system

Gigatronics Switch: DUT Lane to Signal connection mapping			
TX LANE 0 P	S1 (relay) > Signal 1	TX LANE 0 N	S3 > Signal 1
TX LANE 1 P	S1 > Signal 2	TX LANE 1 N	S3 > Signal 2
TX LANE 2 P	S1 > Signal 3	TX LANE 2 N	S3 > Signal 3
TX LANE 3 P	S1 > Signal 4	TX LANE 3 N	S3 > Signal 4
TX LANE 4 P	S1 > Signal 5	TX LANE 4 N	S3 > Signal 5
TX LANE 5 P	S1 > Signal 6	TX LANE 5 N	S3 > Signal 6
TX LANE 6 P	S1 > Signal 7	TX LANE 6 N	S3 > Signal 7
TX LANE 7 P	S1 > Signal 8	TX LANE 7 N	S3 > Signal 8

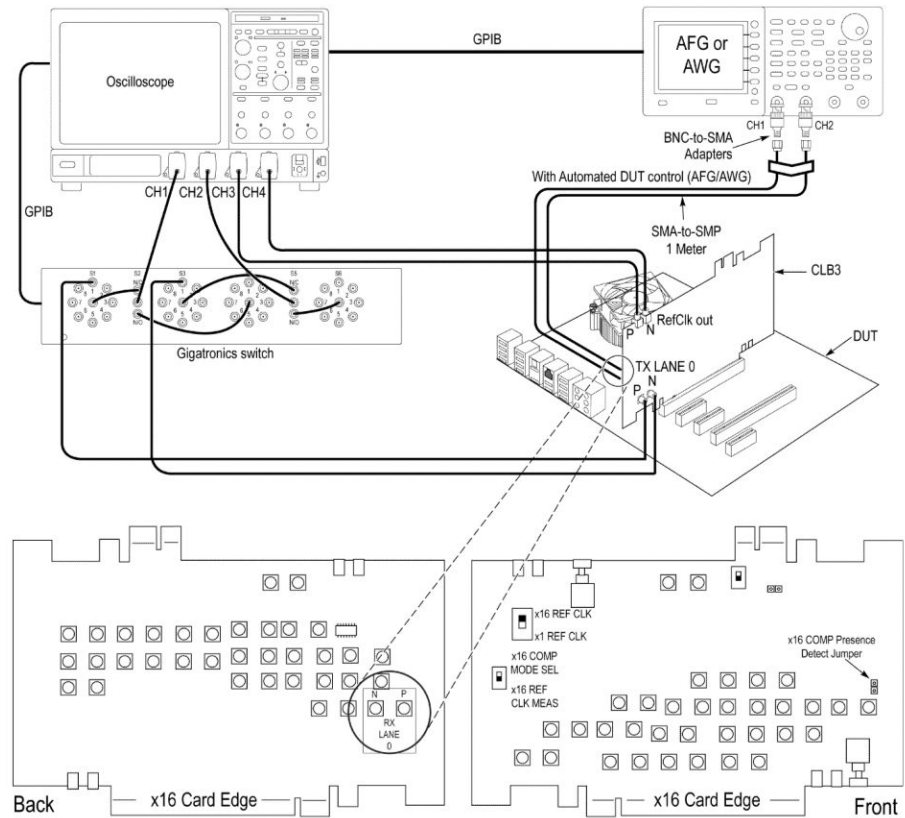

Figure 5: System board (cascade) connection setup through switch system

Gigatronics Switch: DUT Lane to Signal connection mapping			
TX LANE 0 P	S1 (relay) > Signal 1	TX LANE 0 N	S3 > Signal 1
TX LANE 1 P	S1 > Signal 2	TX LANE 1 N	S3 > Signal 2
TX LANE 2 P	S1 > Signal 3	TX LANE 2 N	S3 > Signal 3
TX LANE 3 P	S1 > Signal 4	TX LANE 3 N	S3 > Signal 4
TX LANE 4 P	S1 > Signal 5	TX LANE 4 N	S3 > Signal 5
TX LANE 5 P	S1 > Signal 6	TX LANE 5 N	S3 > Signal 6
TX LANE 6 P	S1 > Signal 7	TX LANE 6 N	S3 > Signal 7
TX LANE 7 P	S1 > Signal 8	TX LANE 7 N	S3 > Signal 8
TX LANE 8 P	S4 > Signal 1	TX LANE 8 N	S6 > Signal 1
TX LANE 9 P	S4 > Signal 2	TX LANE 9 N	S6 > Signal 2
TX LANE 10 P	S4 > Signal 3	TX LANE 10 N	S6 > Signal 3
TX LANE 11 P	S4 > Signal 4	TX LANE 11 N	S6 > Signal 4
TX LANE 12 P	S4 > Signal 5	TX LANE 12 N	S6 > Signal 5
TX LANE 13 P	S4 > Signal 6	TX LANE 13 N	S6 > Signal 6
TX LANE 14 P	S4 > Signal 7	TX LANE 14 N	S6 > Signal 7
TX LANE 15 P	S4 > Signal 8	TX LANE 15 N	S6 > Signal 8

---

**NOTE.** *GPIB is the recommended interface to execute the switch matrix commands.*

---





---

# Running tests

## Test setup overview

Test setup includes acquisition and configuration parameters. You can also select report options when setting up tests. Use the options in the [Setup panel](#) and [Reports panel](#) to select and configure tests.

1. [Set up equipment.](#)
2. [Do the prerun checklist.](#)
3. [Set DUT parameters.](#)
4. [Select one or more tests.](#)
5. [Select acquisitions.](#)
6. [Configuration test parameters.](#)
7. [Set test measurement notification options.](#)
8. [Select report options.](#)

### See also

[About test setups](#)  
[Before you click star](#)  
[About running tests](#)

## Prerequisite

### Compensate the signal path

Use the following procedure to compensate the internal signal acquisition path. Perform this procedure if the ambient temperature has changed more than 5 °C (9 °F) since you performed the last signal path compensation. Perform the signal path compensation once a week. Failure to do so may result in the instrument not meeting warranted performance levels.

1. Power on and wait for the instrument to complete its warm up period before continuing with this procedure.
2. Disconnect any probes you have connected to the input channels.
3. Set the instrument to Menu mode.
4. Select Instrument Calibration from the Utilities menu.
5. Note any instructions that appear in the resulting control window.
6. Click Run SPC to begin the procedure. The procedure may take several minutes to complete.
7. Verify that the Status changes to Compensated after the procedure is complete. If the Calibration Status field indicates anything other than Compensated, see Signal Path Compensation Status for information on the readout and recommended action.

---

**NOTE.** *When making measurements at vertical scale settings less than or equal to 5 mV, you should perform the signal path compensation at least once a week. Failure to do so may result in the instrument not meeting warranted performance levels at those volts/div settings.*

---

### Deskew

If skew is present between positive and negative channels, then the channels need to be deskewed before being used for waveform measurements. TekExpress PCIe provides support for channel deskew and attenuation using the following method:

1. Determine what the skew is for each channel.
2. From the TekScope menu, select Vertical > Deskew.
3. In the Deskew/Attenuation window, click the channel (1 – 4) button for the first channel to be deskewed.
4. Click in the Ch(x) Deskew Time entry field and enter the skew. The skew can be +ve or –ve.
5. Click the channel button for the next channel and repeat step 4.
6. After entering the skew for all the channels that require it, from the Options menu in TekExpress PCIe, select Deskew.

7. In the Deskew dialog box, select the desired level:
  - Less than 100 mV signal amplitude: Select this if the signal amplitude is such that the oscilloscope's vertical setting is less than 100 mV/division.
  - 100 mV or greater signal amplitude: Select this if the signal amplitude is such that the oscilloscope's vertical setting is greater than 100 mV/division.

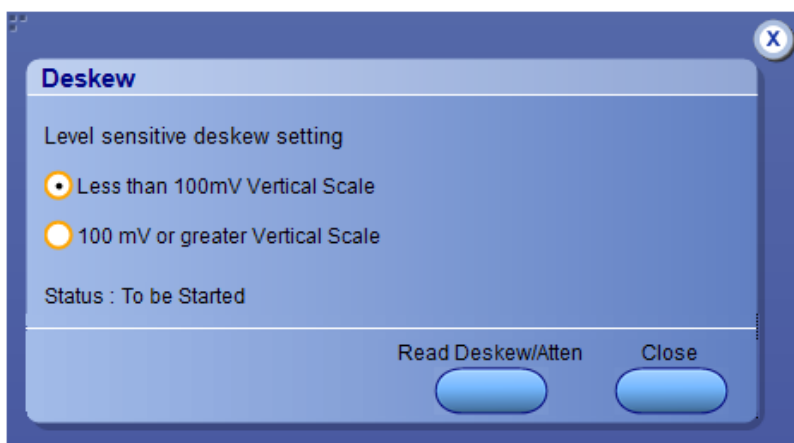

**Figure 6: Deskew**

8. Click Read Deskew/Attn.
9. When the status in the dialog box indicates the deskew is finished, click Close.

Each input channel has its own deskew settings. Deskew compensates individual channels for probes or cables of different lengths. The instrument applies the delay values after each completed acquisition. The deskew values are saved as part of the instrument setup. The deskew values for the selected channel are retained until you change the probe, you restore a saved setup, or you recall the factory setup.

## Running tests

After selecting and configuring tests, review the [Prerun checklist](#) and then click **Start** to run the tests. While tests are running, you cannot access the Setup or Reports panels. To monitor the test progress, switch back and forth between the Status panel and the Results panel.

The application displays a report when the tests are complete. While the tests are running, other applications may display windows in the background. The TekScope application takes precedence over other applications, but you can switch to other applications by using the **Alt + Tab** key combination. To keep the TekExpress PCIe application on top, select **Keep On Top** from the TekExpress Options menu.

### See also

[Before you click start](#)

[About configuring tests](#)

[About setting up tests](#)

### Prerun checklist

Do the following before you click Start to run a test. If this is the first time you are running a test on a setup, refer to the information in [Before you click start](#).

1. Make sure that all the required instruments are properly warmed up (approximately 20 minutes).
2. Perform Signal Path Compensation (SPC):
  - a. On the oscilloscope main menu, select the **Utilities** menu.
  - b. Select **Instrument Calibration**.
3. Verify that the application is able to find the DUT. If it cannot, perform a search for connected instruments:
  - a. In PCIe, select the **Setup** panel and then click the **Test Selection** tab.
  - b. Select any test and then click **Configure**.
  - c. In the Configuration section, click **Global Settings**.
  - d. In the **Instruments Detected** section, click the drop-down arrow to the right of **Real Time Scope** and make sure that the oscilloscope with the (GPIB8::1::INSTR) designation is in the list.

### See also.

[Equipment connection setup](#)

---

# Saving and recalling test setups

## About test setups

TekExpress PCIe opens with the default setup selected. Run a test before or after saving a setup. When you save a setup, the test information, such as the selected oscilloscope, general parameters, acquisition parameters, measurement limits, waveforms (if applicable), and other configuration settings are all saved under the setup name at *X:\PCI Express*.

Use test setups to:

- Run a saved test in prerecorded mode.
- View all the information associated with a saved test, including the log file, the history of the test status as it executed, and the results summary.
- Create a new test setup based on an existing one.
- Run a new session, acquiring live waveforms, using a saved test configuration.

### See also

[\*About setting up tests\*](#)

[\*Save a test setup\*](#)

[\*Recall a saved test setup\*](#)

## Save a test setup

Save a test setup before or after running a test to save the test configuration. Create a new test setup from any open setup or from the default setup. When you select the default test setup, all parameters are returned to the application's default values.

To save the current setup session to the same setup name, select **Options > Save Test Setup**.

To save the current setup session to a new setup name, select **Options > Save Test Setup As**.

To create and save a new setup from the default test setup:

1. Select **Options > Default Test Setup**.
2. Select **Setup** and set required options and parameters in the tabs (DUT, Test Selection, and so on).
3. Select **Reports** and set your *report options*.
4. Optional: Click **Start** to run the test and verify that it runs correctly and captures the information you want. If it does not, edit the parameters and repeat this step until the test runs to your satisfaction.

Running the test helps verify that all parameters are set correctly, but it is not a necessary step.

5. Select **Options > Save Test Setup**. Enter the file name for the setup file. The application saves the file to *X:\PCI Express\<session\_name>*.

### See also

[About setting up tests](#)

[Test setup overview](#)

[View test-related files](#)

[About configuring tests](#)

## Open (load) a saved test setup

These instructions are for recalling saved test setups.

1. Select **Options > Open Test Setup**.
2. Select the setup from the list and click **Open**. Setup files must be located at *X:\PCI Express*.

### See also

[About test setups](#)

[Create a new test setup based on an existing one](#)

[Test setups overview](#)

## Create a new test setup based on an existing one

Use this method to create a variation on a test setup without having to create the setup from the beginning.

1. Select **Options > Open Test Setup**.
2. Select a setup from the list and then click **Open**.
3. Use the **Setup** and **Reports** panels to modify the parameters to meet your testing requirements.
4. Select **Options > Save Test Setup As**.
5. Enter a test setup name and click **Save**.

---

### NOTE.

- Select **Default Test Setup** before execution of every test and save the session with a valid name; this will prevent overwriting/losing data.
  - When you save session using the option **Save Test Setup**, the "Untitled Session" folder and the "Untitled Session.Tekx" file will get renamed with the session name provided by you. It takes few seconds to store the data in the folder.
  - When you save session using the option **Save Test Setup As**, the "Untitled Session" folder and the "Untitled Session.Tekx" file will get named with session name provided by you. It takes few seconds to store the data in the folder. The same is applicable when you use the **Save as** option to save the already saved session files.
-

**See also**

*[About test setups](#)*

*[Set DUT parameters](#)*

*[Configuration parameters](#)*

*[Select acquisitions](#)*



# Switch Matrix application

## Product description



Switch Matrix application allows to configure and setup automated multi-lane testing using RF switch. The solution allows you to map each of the several transmitter signals and forward the selected input either to another relay or to the oscilloscope channel.

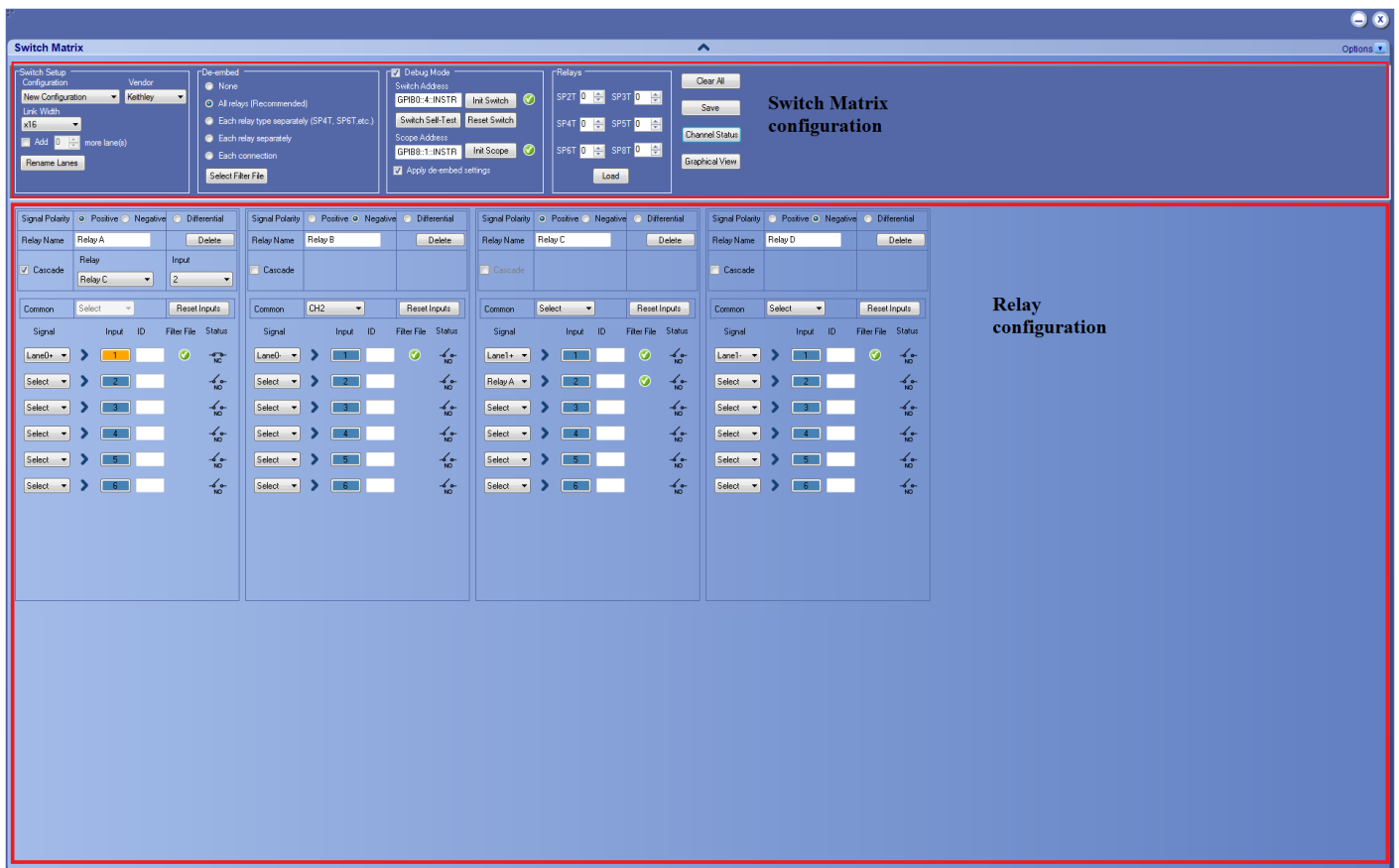

## Application overview

This section describes the Switch Matrix application settings.

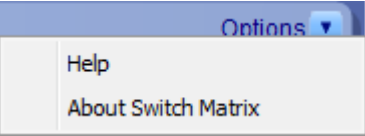
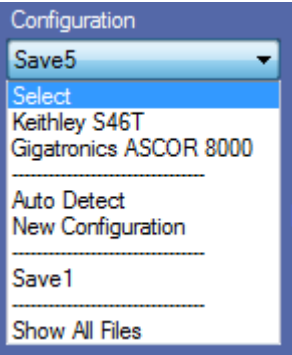

**Table 11: Switch Matrix configuration settings**

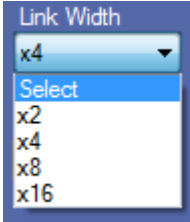
Item	Description
	Click to expand/collapse the switch matrix configuration.
Options  	Click <b>Help</b> to view the software help document and <b>About Switch Matrix</b> for software version.
<b>Switch Matrix configuration</b>	
Configuration  	Select the configuration option: <ul style="list-style-type: none"> <li>■ <b>Keithley S46T</b>: 6-input-to-1-output switch configuration</li> <li>■ <b>Gigatronics ASCOR 8000</b>: 8-input-to-1-output switch configuration</li> <li>■ <b>Auto Detect</b>: Select to autodetect the switch.</li> <li>■ <b>New Configuration</b>: Select to manually configure the switch.</li> <li>■ <b>Saved file names</b>: Saved configuration file name(s) are displayed in the drop-down list. Select to recall the configuration.</li> <li>■ <b>Show All Files</b>: Select to view the list of all saved files.</li> </ul>
Vendor  	Select the vendor from the drop-down list. This field is displayed: <ul style="list-style-type: none"> <li>■ When you select <b>Configuration &gt; New Configuration</b> to create afresh configuration.</li> <li>■ When you open a saved configuration. The displayed vendor name is not editable.</li> <li>■ When Auto Detect is selected. The displayed vendor name is not editable.</li> </ul>

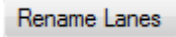
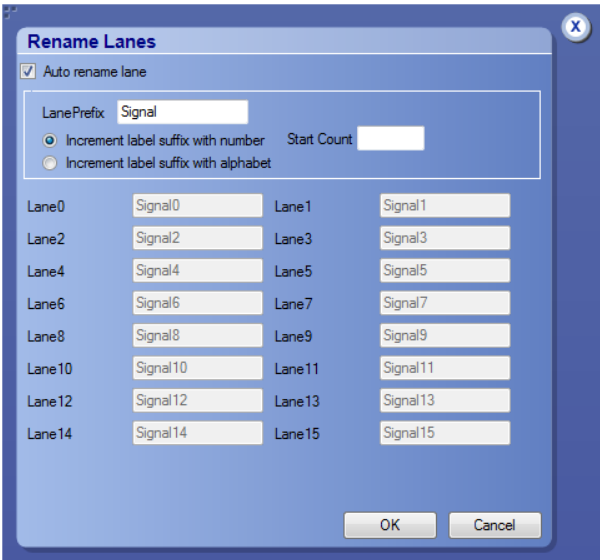

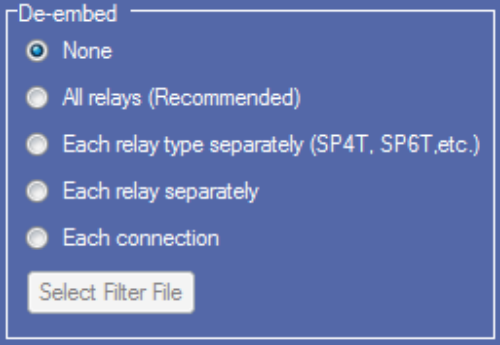
Item	Description
<p><i>Link Width</i></p> 	<p>Select the Link Width from the drop-down list. This determines the maximum number of lanes supported by the DUT.</p>
<p>Add &lt;X&gt; more lane(s)</p> 	<p>Select to add extra lanes (Additional1, Additional2,...) to the lanes list. The extra lanes added are displayed in the relay signals. You can add a maximum of 10 lanes.</p>
<p>Rename Lanes</p> 	<p>Click to rename the lanes. Enter the LanePrefix and select the increment label type to suffix by either number or alphabet. The number of lanes depends on the Link Width selected. Clear the Auto rename lane check box to set unique names for the lanes.</p> 
<p><b>De-embed</b></p>	

Item	Description
<p>De-embed <sup>1</sup></p> 	<p>Select the De-embed option:</p> <ul style="list-style-type: none"><li>■ None</li><li>■ <i>All relays (Recommended)</i></li><li>■ <i>Each relay type separately (SP4T, SP6T, etc.)</i></li><li>■ <i>Each relay separately</i></li><li>■ <i>Each connection</i></li></ul> <p>Select the de-embed option and click <b>Select Filter File</b> to browse and select the filter file(s).</p>
<b>Debug Mode</b>	



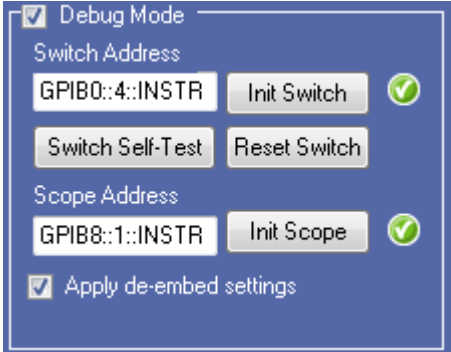

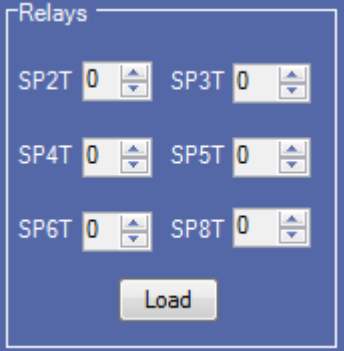
---

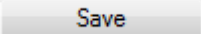
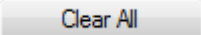
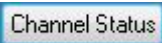
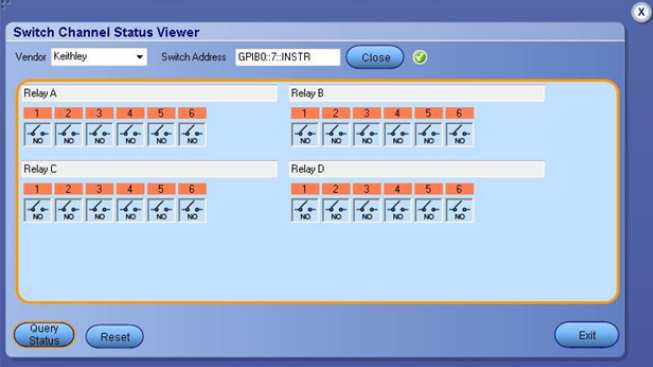
<sup>1</sup> Configure at least one relay before configuring the de-embed settings.

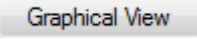
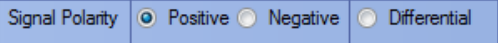
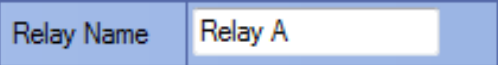
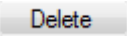
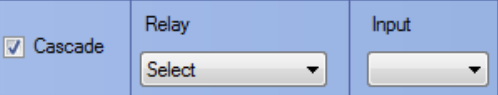
Item	Description
<p><i>Debug Mode</i></p> 	<p>Select Debug Mode to manually configure the switch.</p> <p><b>Switch Address</b> Enter the Switch Address in the GPIB or TCPIP format. GPIB format: GPIB0:X:INSTR TCPIP format: TCPIP::IPADDR::INSTR</p> <p><b>Init Switch</b> This will synchronize the configuration of relay(s) in the application with the relay(s) in the switch. Synchronization will be successful only for the relays whose configuration matches with the physical switch. Pass/Fail status is displayed next to the button.</p> <hr/> <p><b>NOTE.</b> Relay configurations (number of relays, number of relay inputs, and name of relays) in the application should match the physical switch, for successful synchronization.</p> <hr/> <p><b>Switch Self-Test</b> This will close and open all switch channels one-by-one and displays the pass/fail status of the channel next to the ID. A self-test report (CSV) is generated at the end of the process. You cannot abort this process.</p> <hr/> <p><b>NOTE.</b> Initialize the switch before performing the self-test.</p> <hr/> <p><b>Reset Switch</b> Click <b>Reset Switch</b> to reset the switch. This will open all channels.</p> <p><b>Scope Address</b> Enter the oscilloscope address in the GPIB or TCPIP format. GPIB format: GPIB0:X:INSTR TCPIP format: TCPIP::IPADDR::INSTR</p> <p><b>Init Scope</b> Enter the oscilloscope address in the Scope Address field and click <b>Init Scope</b> to initialize the oscilloscope. This will establish the connection with the oscilloscope. The pass/fail status is displayed next to the button.</p> <p><b>Apply De-embed settings</b> Select to apply de-embed settings to the channels. When the oscilloscope is initialized and de-embed settings are configured, closing a connection will apply the de-embed settings and then close the connection.</p>
<b>Relays</b>	

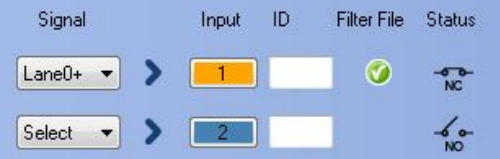
Item	Description
<p>Relays</p> 	<p>Select the relay(s). In SPnT, <i>n</i> represents the number of connection signals for the relay. For example, SP4T is a four signal connection relay.</p> <p>This field displays only for a new configuration. By default, zero relays are selected.</p> <p>Enter the total number of relays to be loaded in their respective input box and click <b>Load</b>.</p> <p>You can also click  or  to increase or decrease the number.</p>
<p>Save</p> 	<p>Click to save the configuration at <i>C:\ProgramData\Tektronix\Switch Matrix Configurations\*.xml</i>.</p> <p>This operation checks whether all the required configurations are done. If any of the required configurations are not selected, then error popup is displayed, which prompts you to complete the configuration(s).</p>
<p>Clear All</p> 	<p>Click to clear all configurations. The application will be loaded with Configuration drop-down (default).</p>
<p>Channel Status</p> 	<p>Click to view the relays and status of channels of Keithley or Gigatronics switch. This updates the channel status dynamically.</p> <p>In Switch Channel Status Viewer, select the Vendor type, enter the Switch Address and click <b>Init</b> to initialize the switch. This will establish the connection with the switch.</p> <p>Click <b>Query Status</b> to get the details of the relays of the switch and the status of the channels.</p> <p>Click <b>Reset</b> to reset the status viewer.</p> 

Item	Description
<p>Graphical View</p> <p></p>	<p>Click to view the graphical representation of the configured relays. If the relays are cascaded, then they are also displayed in the graphical representation.</p>
<b>Relay configuration</b>	
<p>Signal Polarity</p> <p></p>	<p>Select the signal polarity of DUT:</p> <ul style="list-style-type: none"> <li>■ <b>Positive:</b> populates Lane0+, Lane1+, .... connection signals.</li> <li>■ <b>Negative:</b> populates Lane0-, Lane1-, .... connection signals.</li> <li>■ <b>Differential:</b> populates Lane0, Lane1, .... connection signals.</li> </ul>
<p>Relay Name</p> <p></p>	<p>Enter the relay name. This name should match the relay name of the connected switch.</p>
<p>Delete</p> <p></p>	<p>Click to delete the relay. This configuration is only available for the configured (loaded) relays, when Configuration &gt; New Configuration is selected.</p>
<p>Cascade</p> <p></p>	<p>Select to cascade the relay by connecting the common channel as the input signal for another relay. Select the Relay and the Input of the relay. Check that the selected relay signal displays the appropriate relay name. The cascade settings is also displayed in the graphical view. <a href="#">Click here</a> to get details about Cascade.</p> <p><b>NOTE.</b> Select the cascade settings before you save the configuration.</p>

Item	Description
<p>Common</p> 	<p>Select the oscilloscope channel for Common. If cascaded, it displays the name of the relay. Click <b>Reset Inputs</b> to clear all connection signal settings.</p> <p><b>NOTE.</b> Select the common settings for all the relays, before you save the configuration.</p>
	<p><b>Signal</b> Select the DUT connection signal. This drop-down list shows the lanes based on <a href="#">Link Width</a> and <a href="#">Signal Polarity</a> settings. If the link width is x8 and signal polarity is Positive, then the Signal drop-down list will have Lane0+ to Lane7+ options.</p> <p><b>Input</b> This button is enabled only in debug mode and if a valid signal is configured for the channel. Click to close or open the channel.</p> <p><b>ID</b> Enter the three character alias name for the channel. This is shown in the <a href="#">graphical view of switch matrix configuration</a>.</p> <p><b>Filter File</b> This column shows  or  indicating the status of the filter file configuration for the channel. If no de-embed option is selected, then this column remains blank.</p> <p><b>Status</b> This column displays the status of the channel.</p> <p>Channel closed (normally closed) : </p> <p>Channel opened (normally opened) : </p>







## File name extensions

This application uses the following file name extensions:

File name extension	Description
.html	Saved configuration and Graphical view file formats
.xml	Switch Matrix configuration files

## Status indicators

Status indicators	Description
	Success indicator
	Failure indicator
	Closed channel indicator (NC = Normally Closed)
	Opened channel indicator (NO = Normally Opened)

## Saved configurations

Click **Configuration** > **Show All Files** to view the list of all saved files.

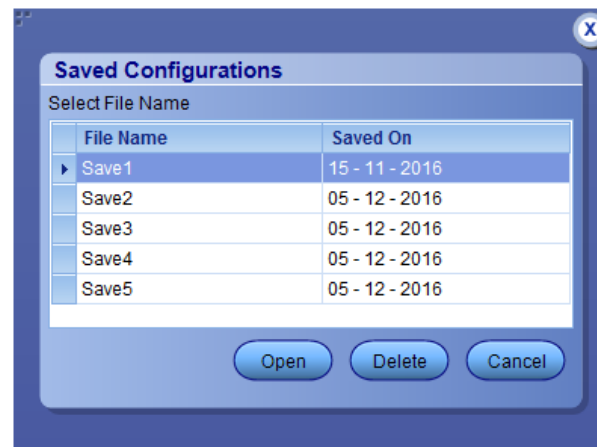
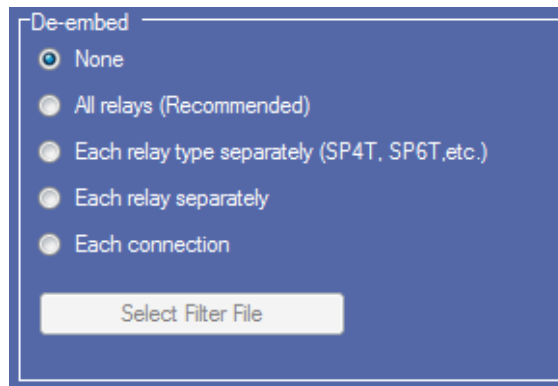

**Table 12: Saved configurations**

Item	Description
Open	Opens the selected file.
Delete	Deletes the selected file.
Cancel	Closes the Saved Configurations window.

## De-embed settings

De-embed allows you to apply filter file(s) for relay(s). Select the De-embed option and click **Select Filter File** to browse and select the filter file(s).



**Figure 7: De-embed options**

### Apply a filter file for all relays

Select to apply a single filter file for all relays.

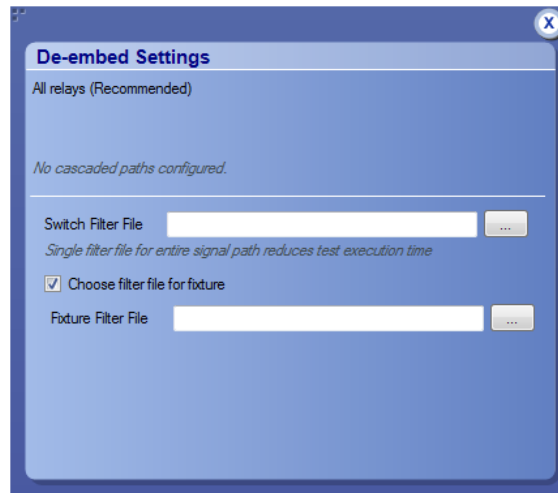

Click **...** to browse and select the filter file for the switch. To apply the filter file for the fixture, select **Choose filter file for fixture** and browse the filter file.

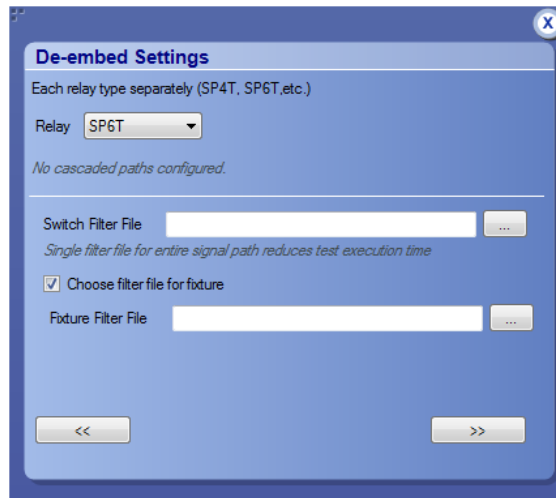

### Apply a filter file for each relay type separately

Select to separately apply a single filter file for each relay type.



Select the Relay type from the drop-down list; click  to browse and select the filter file for the switch. To apply the filter file for the fixture, select **Choose filter file for fixture** and browse the filter file.



**TIP.** Click  or  to select the previous or next relay type.



**TIP.** The selected relay types are highlighted in dark blue in the application.

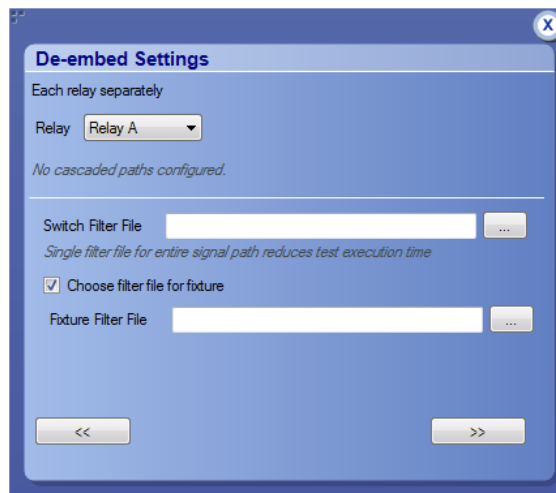

### Apply a filter file for each relay separately

Select to separately apply a filter file for each relay.



Select the Relay from the drop-down list; click  to browse and select the filter file for the switch. To apply the filter file for the fixture, select **Choose filter file for fixture** and browse the filter file.



**TIP.** Click  or  to select the previous or next relay.



**TIP.** The selected relay is highlighted in dark blue in the application.

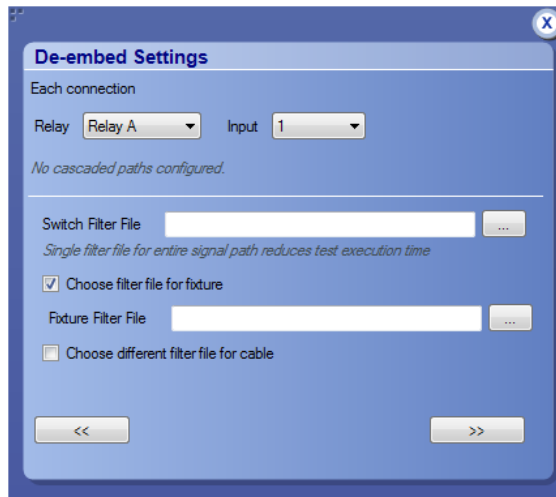

### Apply a filter file for each connection separately

Select to apply a filter file for each connection.





Select the Relay and the Input from the drop-down list; click  to browse and select the filter file for the switch. To apply the filter file for the fixture, select **Choose filter file for fixture** and browse the filter file. Select **Choose different filter file for cable** to browse and select the filter file for cable.



**TIP.** Click  or  to select the previous or next channel.



**TIP.** The selected relay signal is highlighted in dark blue in the application.

**NOTE.** Clicking  on the last input of a relay selects the first input of the next relay; clicking  on the first input of a relay selects the last input of the previous relay.

## Graphical view of switch matrix configuration

The Graphical view displays the pictorial representation of the switch configuration.

The following figure displays the graphical view of a Keithley switch configuration.



## Saving the configuration

Click **Save** in the configuration panel; in the Configuration Save dialog box, enter the file name and click **Save**. The default save path is `C:\ProgramData\Tektronix\Switch Matrix Configurations\`.



**NOTE.** Save configuration checks whether all the required configurations are done. If any of the required configurations are not selected, then error message is displayed, which prompts you to complete the configuration(s).

## Feature description

**Link width** Link width determines the number of DUT signals. For example, x8 represents an eight lane DUT.

This works in conjunction with the signal polarity selected for each relay. For example, if the link width is x8, and:

- If the signal polarity is **Positive**, then the signal drop-down list will have selections from Lane0+ to Lane7+.
- If the signal polarity is **Negative**, then the signal drop-down list will have selections from Lane0- to Lane7-.
- If the signal polarity is **Differential**, then the signal drop-down list will have selections from Lane0 to Lane7.

### Debug mode

**Init Switch.** Enter the Switch Address and click **Init Switch** to initialize the switch. This will synchronize the configuration of relay(s) in the application with the relay(s) in the switch. Synchronization will only be successful for those relays that match the physical switch. Pass/Fail status is displayed next to the button.

The factory default GPIB address for Keithley (GPIB0::7::INSTR) and Gigatronics (GPIB0::4::INSTR) is populated in the switch address based on the configured vendor. You can enter the address in GPIB (GPIB0:X:INSTR) or TCPIP (TCPIP::IPADDR::INSTR) format.

---

**NOTE.** *Relay configurations (number of relays, number of relay inputs, and name of relays) in the application should match the physical switch, for successful synchronization.*

---

**Switch Self-Test.** This will close and open all switch channels one-by-one. A selftest report (CSV) is generated at the end of the process. You cannot abort this process.

---

**NOTE.** *Initialize the switch before performing the Switch Self-Test.*

---

**Reset Switch.** Click **Reset Switch** to reset the switch. This will open all channels.

**Init Scope.** Enter the oscilloscope address in the Scope Address field and click **Init Scope** to initialize the oscilloscope. This will establish the connection with the oscilloscope. The pass/fail status is displayed next to the button.

You can enter the address in GPIB (GPIB0:X:INSTR) or TCPIP (TCPIP::IPADDR::INSTR) format.

When the oscilloscope is initialized and de-embed settings are configured, closing a connection will apply the de-embed settings and then close the connection.

---

**NOTE.** *The virtual GPIB address of the oscilloscope is GPIB8::1::INSTR.*

---

---

**NOTE.** *If oscilloscope fails to respond to the \*IDN? query during initialization, then the connection attempt is considered a failure.*

---

### **Cascade (Relay cascade)**

This feature allows you to cascade the relay by connecting the common channel as an input signal for another relay.

To cascade, select **Cascade** in the relay and select the Relay and Input of the relay. Check that the selected relay signal displays the relay name, specifying that the lane input signal is the output from that relay.

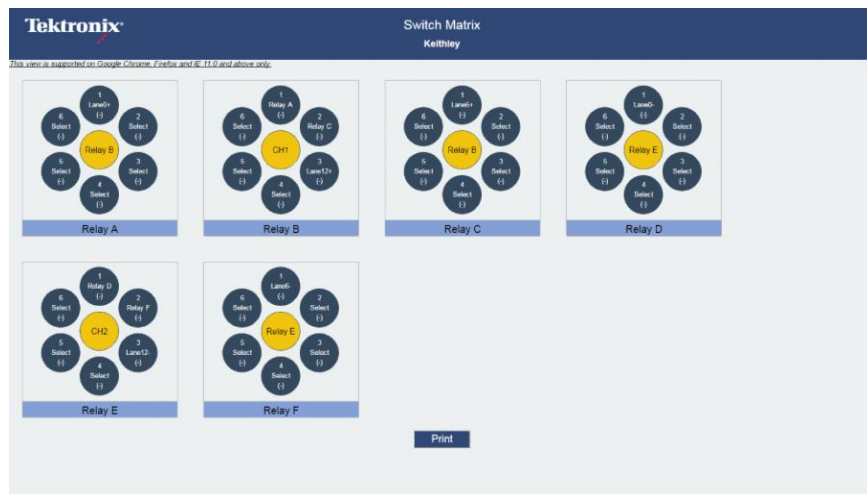
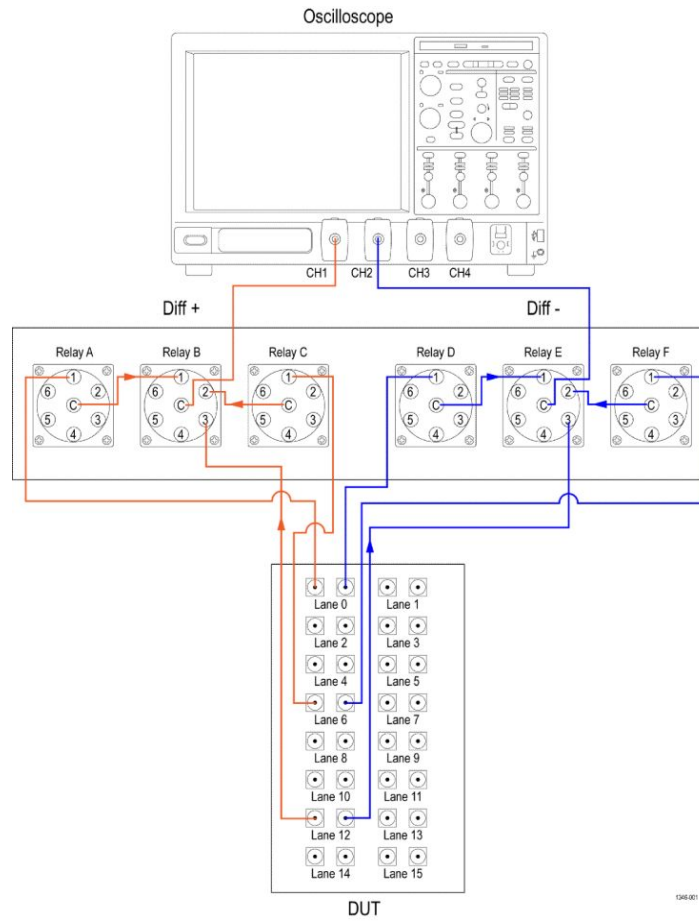

Figure 8: Graphical view of relay cascade configuration





**TIP.** Switch Matrix application supports only single-level cascading of the relays. For example, if the Relay A output is cascaded to Relay B, then the Relay B output cannot be cascaded.

## Error messages

Error message	Possible solution
"A filename cannot be empty and it cannot contain any of the following characters:\nlt. .. \\ \\ : ? \\ " < >   * ! @ # \$ % ^ & * ( ) - + . , / \\ ' < > Also, the file name cannot be \\ "Keithley S46T\\", \\ "Gigatronics ASCOR 8000\\", \\ "Select\\", \\ "New Configuration\\", \\ "Custom\\", \\ "Auto Detect\\", or \\ "Show All Files\\""	
Configure appropriate signals before the de-embed settings.	Select at least one signal for a relay before configuring the de-embed settings.
Either the instrument address is invalid or instrument is not connected.	Check the GPIB connection from oscilloscope to switch and verify the instrument address.
Error occurred while trying to recall the configuration settings. Try re-creating configuration or recalling a different configuration file.	Re-create the configuration file or recall a different configuration file.
Error occurred while trying to access the connection for open/close operation.	
Filter file <FilterFileName> not found.	Reselect the de-embed filter file and try again.
Graphical view is not generated or does not exist.	
Initialize the switch	Initialize the switch and then perform the switch operations.
Instrument address doesn't belong to any supported switch.	Verify the switch address.
Instrument address is empty.	Instrument address cannot be empty. Enter a valid instrument address in the GPIB (GPIB0:X:INSTR) or TCPIP (TCPIP::IPADDR::INSTR) format.
No switch detected. Connect a Keithley or Gigatronics switch and try auto detection by selecting Configuration > Auto Detect.	Check the GPIB connection from the oscilloscope to switch and whether the instrument is detected in TekVisa.
Number of relays cannot be more than 26	
Please ensure that the name(s) of the configured relay(s) match the ones present on the physical switch.	

Error message	Possible solution
Relay name cannot be empty	
Scope initialization failed. Check if the address is valid and ensure that the instrument is switched on and try again.	Validate the oscilloscope address try again.
Switch communication failed...	Ensure that the switch is on. Reset the switch and try again.
Switch initialization failed. Check if the address is valid and ensure that the instrument is switched on and try again.	Validate the switch address and ensure that the instrument is switched on. Try again.
The start count cannot be more than 74	
Timeout Error. Either the command is invalid or instrument is not active.	Check the command syntax and the connection of the instrument by <i>SWITCH:*IDN</i> command.
Two or more lanes have same name. The lane names should be unique.	
Two or more relays have same name.	

# SCPI commands

## About SCPI command

You can use Standard Commands for Programmable Instruments (SCPI) to communicate with the TekExpress application.

## Socket configuration for SCPI commands

This section describes the steps for TCP/IP socket configuration and TekVISA configuration to execute the SCPI commands.

### TCP/IP socket configuration

1. Click **Start > Control Panel > System and Security > Windows Firewall > Advanced settings**

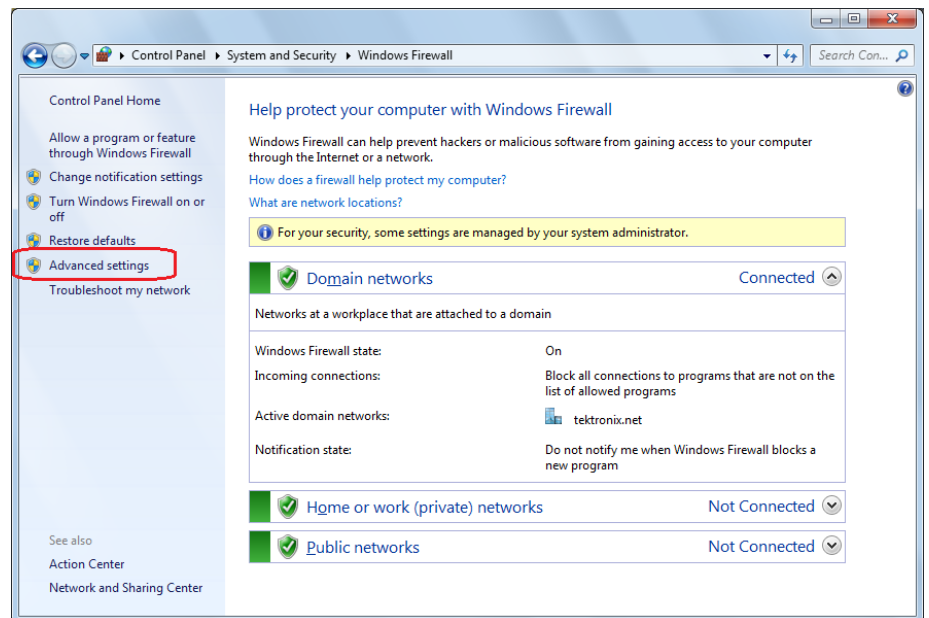

2. In Windows Firewall with Advanced Security menu, select **Windows Firewall with Advanced Security on Local Computer > Inbound Rules** and click **New Rule...**

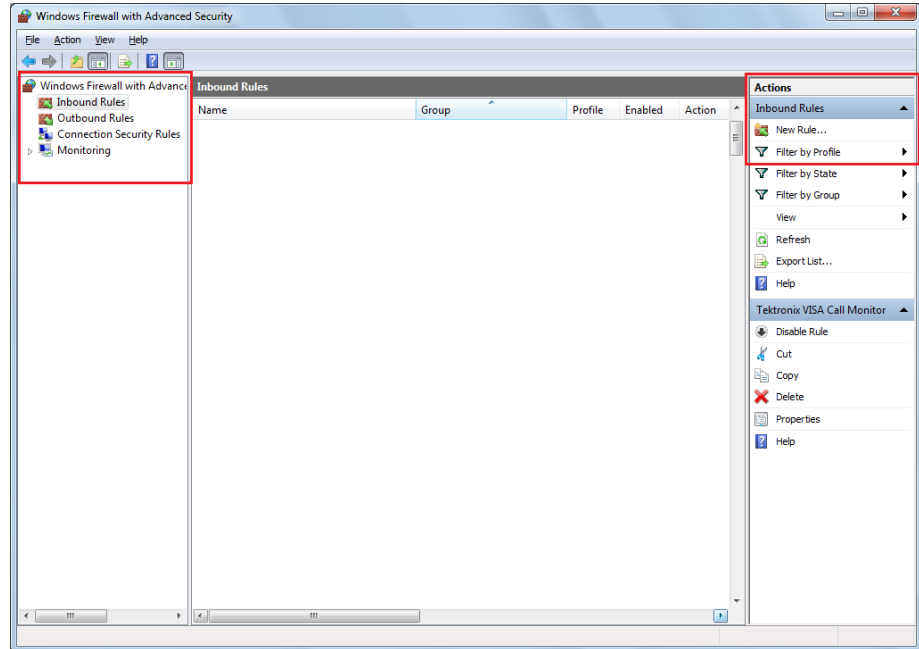

3. In New Inbound Rule Wizard menu
  - a. Select **Port** and click **Next**

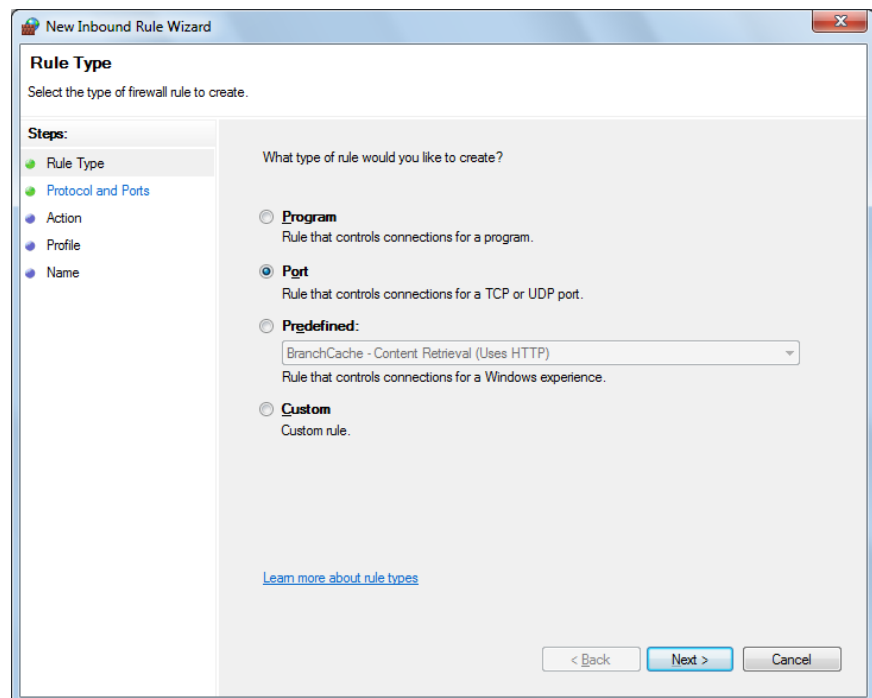

- b. Select **TCP** as rule apply and enter 5000 for **Specific local ports** and click **Next**

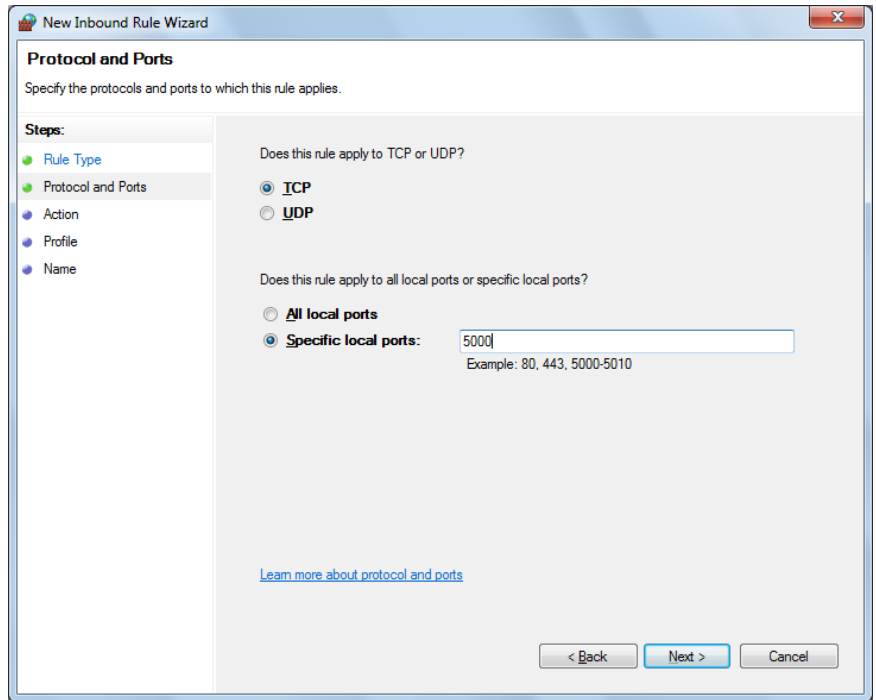

- c. Select **Allow the connection** and click **Next**

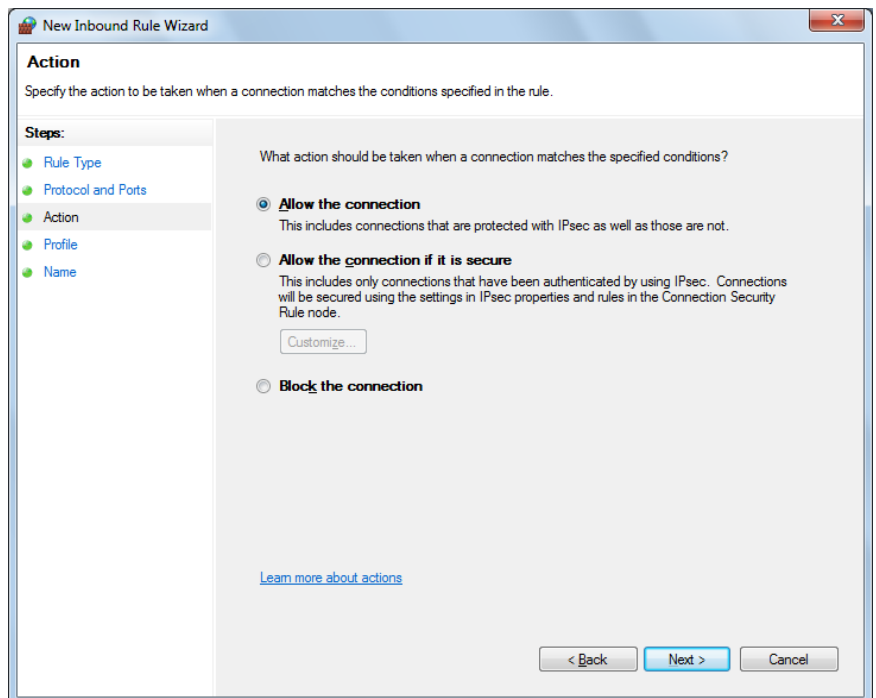

d. Select **Domain**, **Private**, **Public** and click **Next**

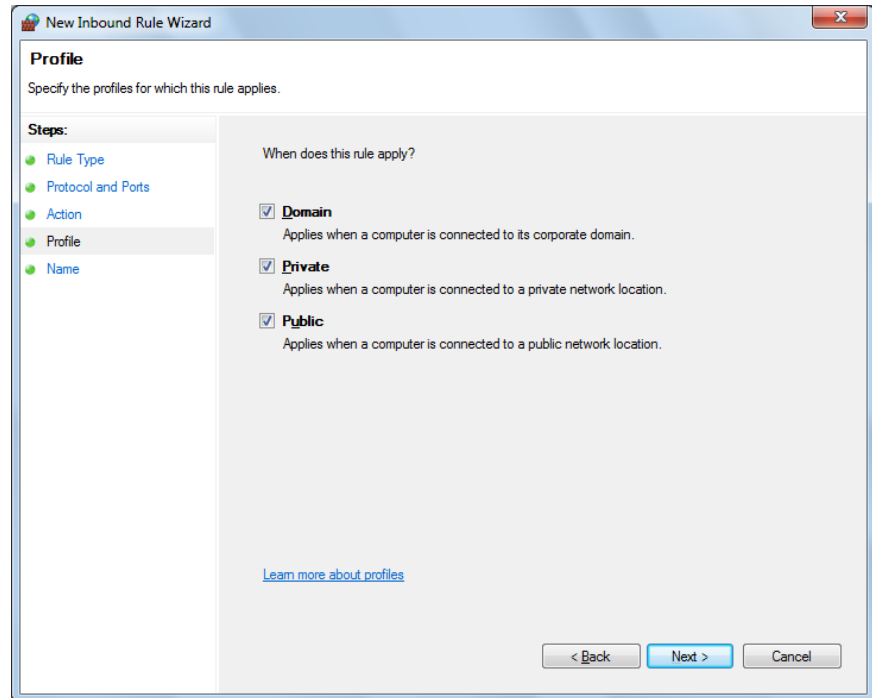

e. Enter **Name**, Description (optional), and click **Finish**

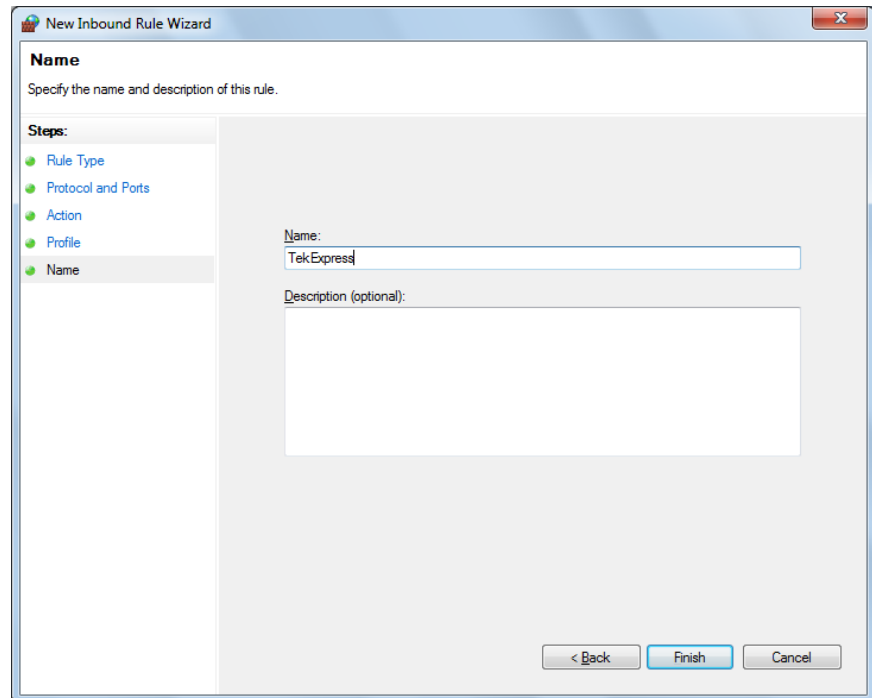

4. Check whether the Rule name is displayed in **Windows Firewall with Advanced Security** menu > **Inbound Rules**

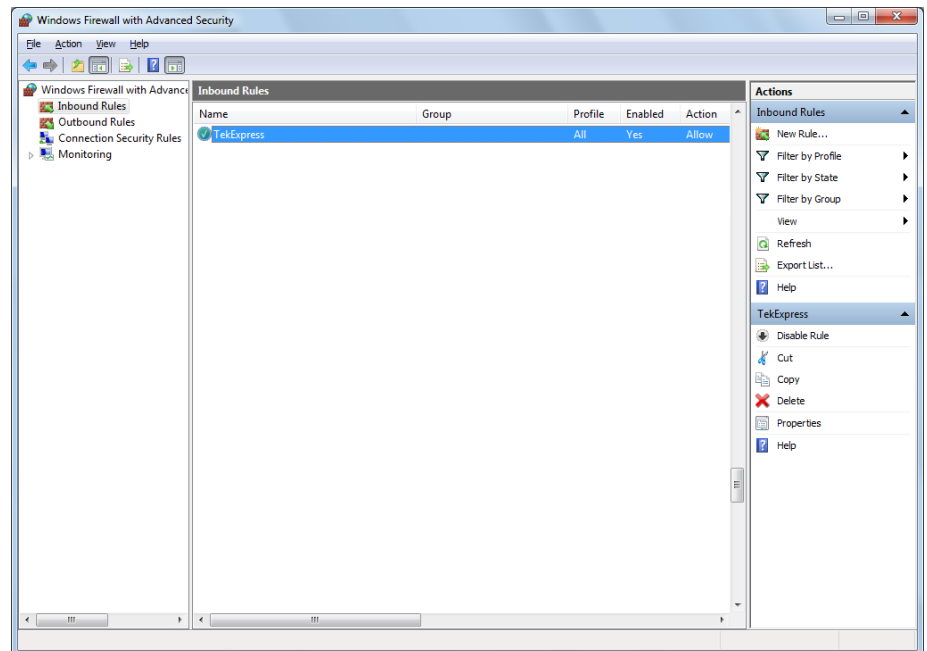

- TekVISA configuration**    1. Click **Start > All Programs > TekVISA > OpenChoice Instrument Manager**

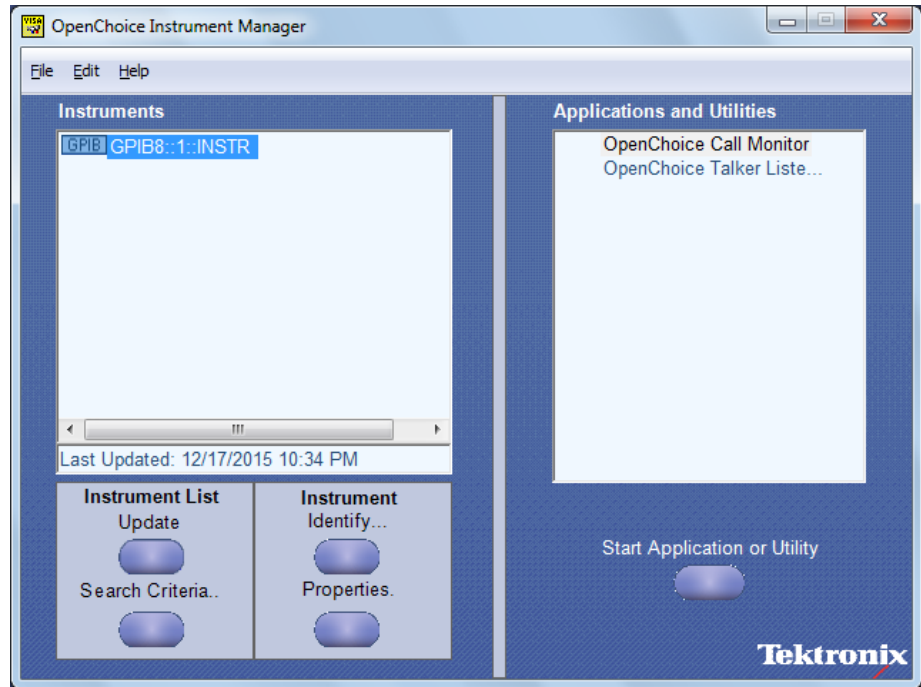



2. Click **Search Criteria**. In Search Criteria menu, click **LAN** to Turn-on. Select **Socket** from the drop-down list, enter the IP address of the

TekExpress device in **Hostname** and type **Port** as 5000. Click  to configure the IP address with Port.

Enter the Hostname as 127.0.0.1 if the TekVISA and TekExpress application are in the same system, else enter the IP address of the TekExpress application system.

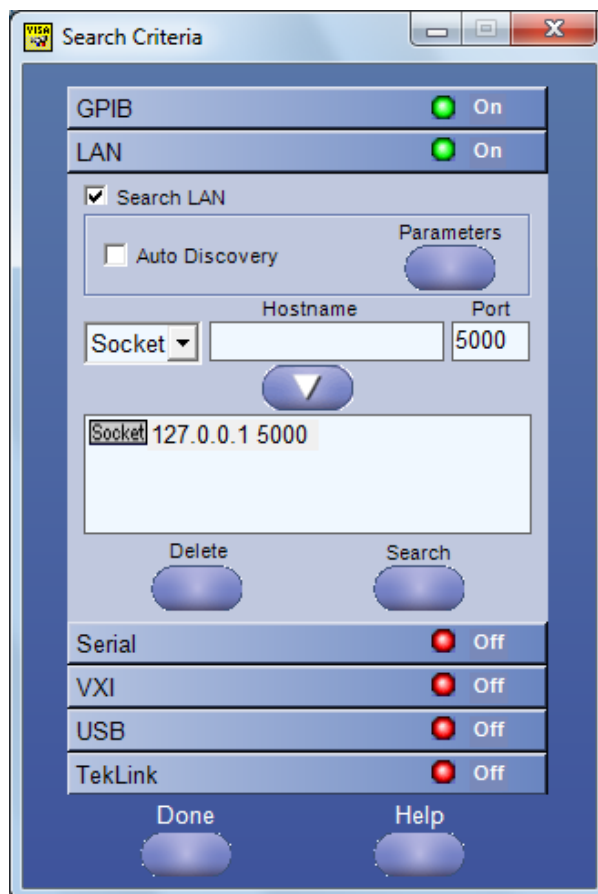

- Click **Search** to setup the TCPIP connection with the host. Check whether the TCPIP host name is displayed in **OpenChoice Instrument Manager > Instruments**

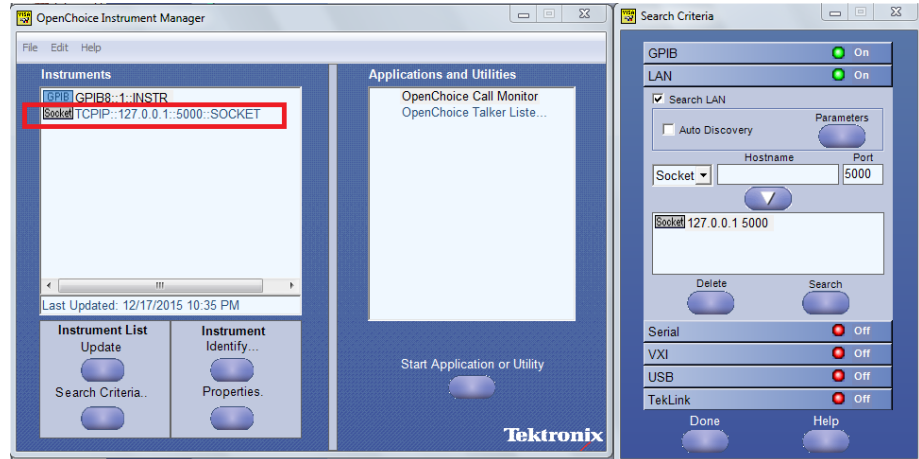

- Double-click **OpenChoice Takler Listener** and enter the Command **\*IDN?** in command entry field and click **Query**. Check that the Operation is successful and Talker Listener Readout displays the Command / Data.

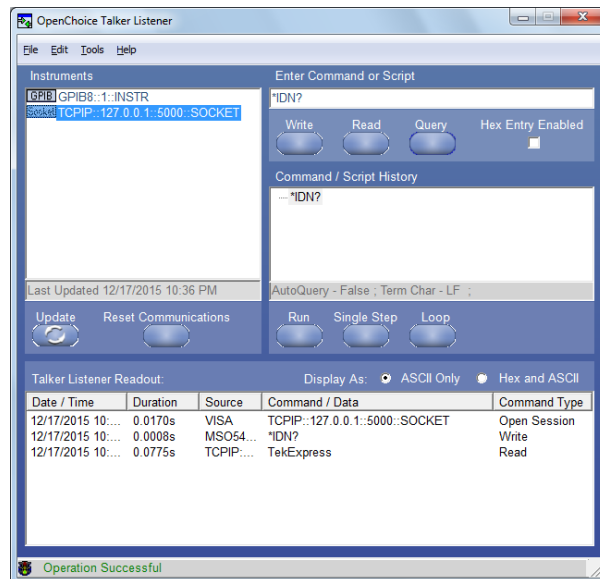

## TEKEXP:\*IDN?

This command queries the active TekExpress application name running on the oscilloscope.

**Syntax**    TEKEXP:\*IDN?\n

**Inputs**    NA

**Outputs**    Returns active TekExpress application name running on the oscilloscope.



---

**TIP.** [Click here](#) for examples.

---

## TEKEXP:\*OPC?

This command queries the execution status of the last executed command.

**Syntax**    TEKEXP:\*OPC?\n

**Inputs**    NA

**Outputs**    0 - last command execution is not complete  
1 - last command execution is complete



---

**TIP.** [Click here](#) for examples.

---

## TEKEXP:ACQUIRE\_MODE

This command sets the acquire mode as live or pre-recorded.

**Syntax**    `TEKEXP:ACQUIRE_MODE {LIVE | PRE-RECORDED}\n`

**Inputs**    `{LIVE | PRE-RECORDED}`

**Outputs**    NA



**TIP.** [Click here](#) for examples.

---

## TEKEXP:ACQUIRE\_MODE?

This command queries the acquire mode type.

**Syntax**    `TEKEXP:ACQUIRE_MODE?\n`

**Inputs**    NA

**Outputs**    `{LIVE | PRE-RECORDED}`



**TIP.** [Click here](#) for examples.

---

## TEKEXP:EXPORT

This command returns all the bytes of data to the specified file.

Syntax	Outputs
TEKEXP:EXPORT REPORT\n	Returns the report file in bytes
TEKEXP:EXPORT WFM,"<FileName>"\n	Returns the specified waveform file in bytes
TEKEXP:EXPORT IMAGE,"<FileName>"\n	Returns the specified image file in bytes

**Inputs** FileName - Specifies the file name



**TIP.** [Click here](#) for examples.

## TEKEXP:INFO?

This command queries the information about the file(s).

Syntax	Outputs
TEKEXP:INFO? REPORT\n	<ReportFileSize>,"<ReportFileName.mht>"
TEKEXP:INFO? WFM\n	<WfmFile1Size>,"<WfmFileName1.wfm>" ;<WfmFile2Size>,"<WfmFileName2.wfm>" ;...
TEKEXP:INFO? IMAGE\n	<Image1FileSize>,"<Image1FileName>" ;<Image2FileSize>,"<Image2FileName>" ;...



**TIP.** [Click here](#) for examples.

## TEKEXP:INSTRUMENT

This command sets the value for the selected instrument type.

**Syntax**    `TEKEXP:INSTRUMENT "<InstrumentType>",<Value>"\n`

**Inputs**    InstrumentType  
               Value



---

**TIP.** Check [Command parameters list](#) for *InstrumentType* and *Value* parameters.

---

**Outputs**    NA



---

**TIP.** [Click here](#) for examples.

---

## TEKEXP:INSTRUMENT?

This command queries the instrument selected for the specified instrument type.

**Syntax**    `TEKEXP:INSTRUMENT? "<InstrumentType>"\n`

**Inputs**    InstrumentType



---

**TIP.** Check [Command parameters list](#) for *InstrumentType* parameters.

---

**Outputs** Returns the instrument selected for the specified instrument type



**TIP.** [Click here for examples.](#)

## TEKEXP:LASTERROR?

This command queries the last error string occurred for the current TCP session. If there are no errors since startup, or since the last call to TEKEXP:LASTERROR?\n, this command returns an empty string.

**Syntax** TEKEXP:LASTERROR?\n

**Inputs** NA

**Outputs** <string>



**TIP.** [Click here for examples.](#)

## TEKEXP:LIST?

This command queries the list of available device, suite, test, version or instrument.

Syntax	Outputs
TEKEXP:LIST? DEVICE\n	Returns the list of available device(s) as comma separated values.
TEKEXP:LIST? SUITE\n	Returns the list of available suite(s) as comma separated values.
TEKEXP:LIST? TEST\n	Returns the list of available test(s) as comma separated values.
TEKEXP:LIST? VERSION\n	Returns the list of available version(s) as comma separated values.
TEKEXP:LIST? INSTRUMENT,"<InstrumentType>\n	Returns the list of available instruments' for the given Instrument type as comma separated values.

---

**NOTE.** This command returns the list of items within double quotes (""). Iterate the receive procedure until the list ends with double quotes otherwise the next query commands won't work as expected.

---

**Inputs** InstrumentType



---

**TIP.** Check [Command parameters list](#) for InstrumentType parameters.

---



---

**TIP.** [Click here](#) for examples.

---

## TEKEXP:MODE

This command sets the execution mode as compliance or user defined.

**Syntax** TEKEXP:MODE {COMPLIANCE | USER-DEFINED}\n

**Inputs** {COMPLIANCE | USER-DEFINED}

**Outputs** NA



---

**TIP.** [Click here](#) for examples.

---



## TEKEXP:MODE?

This command queries the execution mode type.

**Syntax**    `TEKEXP:MODE?\n`

**Inputs**    NA

**Outputs**    {COMPLIANCE | USER-DEFINED}



---

**TIP.** [Click here](#) for examples.

---

## TEKEXP:POPUP

This command sets the response to the active popup shown in the application.

**Syntax**    `TEKEXP:POPUP "<PopupResponse>"\n`

**Inputs**    PopupResponse

**Outputs**    NA



---

**TIP.** [Click here](#) for examples.

---

## TEKEXP:POPUP?

This command queries the active popup information shown in the application.

**Syntax**    `TEKEXP:POPUP?\n`

**Inputs**    NA

**Outputs**    Returns the active popup information in the application.



---

**TIP.** [Click here](#) for examples.

---

## TEKEXP:REPORT

This command generates the report for the current session.

**Syntax**    `TEKEXP:REPORT GENERATE\n`

**Inputs**    GENERATE

**Outputs**    NA



---

**TIP.** [Click here](#) for examples.

---

## TEKEXP:REPORT?

This command queries the queried header field value in the report.

**Syntax**    `TEKEXP:REPORT? "<HeaderField>"\n`

**Inputs**    HeaderField - Specifies to return the measured value for the indicated test.



**TIP.** Check **Report** for HeaderField parameters.

**Outputs**    Returns the queried header field value in the report



**TIP.** [Click here](#) for examples.

## TEKEXP:RESULT?

This command queries the result available in report summary/details table.

Syntax	Outputs
<code>TEKEXP:RESULT? "&lt;TestName&gt;"\n</code>	Return Pass/Fail status of the test.
<code>TEKEXP:RESULT? "&lt;TestName&gt;","&lt;ColumnName&gt;"\n</code>	Returns all the row values of the specified column for the test.
<code>TEKEXP:RESULT? "&lt;TestName&gt;","&lt;ColumnName&gt;",&lt;RowNumber&gt;\n</code>	Returns the column value for the specified row number <sup>1</sup>

<sup>1</sup> Row number starts from zero.

- Inputs**
- TestName - Specifies the name of the test for which to obtain the test result value.
  - ColumnName - Specifies the column name for the measurement
  - RowNumber - Specifies the row number of the measurement

---

 **TIP.** Check **Results** panel for TestName, ColumnName, and RowNumber parameters.

---

 **TIP.** [Click here](#) for examples.

---

## TEKEXP:SELECT

This command selects the device, suite, version, or test.

**Syntax**

```
TEKEXP:SELECT <string1>,<string2>,<string4>\n
TEKEXP:SELECT TEST,<string3>,<string4>\n
```

**Inputs**

- <string1> = {DEVICE | SUITE | VERSION}
- <string2> = {DeviceName | SuiteName | VersionName}
- <string3> = {"<TestName>" | ALL | REQUIRED }
- <string4> = {TRUE | FALSE}

---

 **TIP.** Check [Command parameters list](#) for DeviceName, SuiteName, VersionName, and TestName parameters.

---

 **TIP.** [Click here](#) for examples.

---

**Outputs** NA

## TEKEXP:SELECT?

This command queries the name of the selected device, suite, version, or test.

**Syntax** TEKEXP:SELECT? {DEVICE | SUITE | TEST | VERSION}\n

**Inputs** {DEVICE | SUITE | TEST | VERSION}

**Outputs** Returns the name of the selected device, suite, version, or test.



**TIP.** [Click here for examples.](#)

## TEKEXP:SETUP

This command sets the value of the current setup.

Syntax	Outputs
TEKEXP:SETUP DEFAULT\n	Restore to default Setup
TEKEXP:SETUP OPEN,"<SessionName>"\n	Open the session
TEKEXP:SETUP SAVE\n	Save the session
TEKEXP:SETUP SAVE,"<SessionName>"\n	Save the session

**Inputs** SessionName - The name of the session



**TIP.** [Click here for examples.](#)

## TEKEXP:STATE

This command sets the execution state of the application.

**Syntax**    `TEKEXP:STATE {RUN | STOP | PAUSE | RESUME}\n`

**Inputs**    `{RUN | STOP | PAUSE | RESUME}`

**Outputs**    NA



---

**TIP.** [Click here](#) for examples.

---

## TEKEXP:STATE?

This command queries the current setup state.

Syntax	Outputs
TEKEXP:STATE?	RUNNING   PAUSED   WAIT   ERROR   READY   STOPPED
TEKEXP:STATE? SETUP	SAVED   NOT_SAVED



---

**TIP.** [Click here](#) for examples.

---

## TEKEXP:VALUE

This command sets the value of parameters of type General, Acquire, Analyze, or DUTID.

**Syntax**    `TEKEXP:VALUE GENERAL,"<ParameterName>","<Value>"\n`  
`TEKEXP:VALUE ACQUIRE,"<TestName>","<AcquireType>","`  
`"<ParameterName>","<Value>"\n`  
`TEKEXP:VALUE ANALYZE,"<TestName>","<ParameterName>".<Value>"`  
`\n`  
`TEKEXP:VALUE DUTID,"<Value>"\n`

**Inputs**    ParameterName - Specifies the parameter name  
TestName - Specifies the test name  
AcquireType - Specifies the acquire type  
Value - Specifies the value to set



---

**TIP.** Check [Command parameters list](#) for ParameterName, AcquireType, and Value parameters.

---

**Outputs**    NA



---

**TIP.** [Click here](#) for examples.

---

## TEKEXP:VALUE?

This command queries the value of the parameter for type General, Acquire, Analyze, or DUTID.

Syntax	Outputs
TEKEXP:VALUE? GENERAL,"<ParameterName>"\n	Returns the value of Parameter for type GENERAL
TEKEXP:VALUE? ACQUIRE,"<TestName>", "<AcquireType>","<ParameterName>"\n	Returns the value of Parameter for type ACQUIRE
TEKEXP:VALUE? ANALYZE, "<TestName>","<ParameterName>"\n	Returns the value of Parameter for type ANALYZE
TEKEXP:VALUE? DUTID\n	Returns the DUTID value

**Inputs**

- ParameterName - Specifies the parameter name
- TestName - Specifies the test name
- AcquireType - Specifies the acquire type



**TIP.** Check [Command parameters list](#) for ParameterName and AcquireType parameters.

**Outputs**

Returns the value of Parameter for type GENERAL | ACQUIRE | ANALYZE | DUTID.



**TIP.** [Click here](#) for examples.



## Command parameters list

This section provides the parameters list for the SCPI commands.

Parameters	Description
InstrumentType	Specifies the instrument type. Valid values are: <ul style="list-style-type: none"> <li>■ Alternate Real Time Scope</li> <li>■ Real Time Scope</li> </ul>
Value	Specifies the value parameters. <ul style="list-style-type: none"> <li>■ For InstrumentType, valid values are:               <ul style="list-style-type: none"> <li>■ Comment</li> </ul> </li> <li>■ For DUTID, valid values are:               <ul style="list-style-type: none"> <li>■ Comment</li> </ul> </li> </ul>
DeviceName	Specifies the device name. Valid values are <b>CEM</b> , <b>U.2(SFF-8639)</b> , and <b>BaseSpec</b>
SuiteName	Specifies the suite name. For CEM, valid values are System-Board, Add-In-Card For U.2(SFF-8639), valid values are Host, Module For BaseSpec, valid value is TX Test Board

Parameters	Description
VersionName	Specifies the version name. Valid values are: <ul style="list-style-type: none"><li>■ Gen1-1.0a (Applicable only for DeviceName = CEM)</li><li>■ Gen1-1.1 (Applicable only for DeviceName = CEM)</li><li>■ Gen2-2.0 (Applicable only for DeviceName = CEM)</li><li>■ Gen3-3.0</li><li>■ Gen4-4.0</li></ul>

Parameters	Description
TestName	<p>Specifies the test measurement name. Valid values for CEM and U.2(SFF-8639) are:</p> <ul style="list-style-type: none"> <li>■ Unit Interval</li> <li>■ Mask Hits(All Bits)</li> <li>■ Composit Eye Height</li> <li>■ Number Passing Eyes</li> <li>■ Number Failing Eyes</li> <li>■ Transition Eye Diagram</li> <li>■ Non Transition Eye Diagram</li> <li>■ Min Eye Width</li> <li>■ Min Time Between Crossovers</li> <li>■ RMS Jitter (Per Edge)</li> <li>■ Median Peak Jitter</li> <li>■ TJ @ E-12</li> <li>■ Dj_dd</li> <li>■ RJ(RMS)</li> <li>■ Peak to Peak Jitter</li> </ul> <hr/> <p><b>NOTE.</b> Add one space at the end of the test name to select the 5Gbps tests and two spaces to select the 8Gbps tests.</p> <hr/> <p>Valid values for BaseSpec are:</p> <ul style="list-style-type: none"> <li>■ AC CM 4GHz</li> <li>■ AC CM 30KHz-500MHz</li> <li>■ EIEOS Min Voltage</li> <li>■ V Tx_no_eq</li> <li>■ DDj</li> <li>■ F/2 Jitter</li> <li>■ PS21 Ratio</li> <li>■ PWJ RJ (RMS)</li> <li>■ TIE RJ (RMS)</li> <li>■ Uncorrelated PWJ DJ dd@E-12</li> <li>■ Uncorrelated PWJ TJ@E-12</li> <li>■ Uncorrelated TIE DJ dd@E-12</li> <li>■ Uncorrelated TIE TJ @ E-12</li> </ul>

### ParameterName and Value for General

Specifies the ParameterName and Value for General. The configuration parameters available are not same for measurements.

**Table 13: ParameterName and Value for General**

ParameterName	Value
DataRate2Gb	<ul style="list-style-type: none"> <li>■ Included</li> <li>■ Excluded</li> </ul>
DataRate5Gb	<ul style="list-style-type: none"> <li>■ Included</li> <li>■ Excluded</li> </ul>
DataRate8Gb	<ul style="list-style-type: none"> <li>■ Included</li> <li>■ Excluded</li> </ul>
DataRate16Gb	<ul style="list-style-type: none"> <li>■ Included</li> <li>■ Excluded</li> </ul>
PreEmphasis3dB	<ul style="list-style-type: none"> <li>■ Included</li> <li>■ Excluded</li> </ul>
PreEmphasis6dB	<ul style="list-style-type: none"> <li>■ Included</li> <li>■ Excluded</li> </ul>
SSC	<ul style="list-style-type: none"> <li>■ On</li> <li>■ Off</li> </ul>
VoltageSwing	<ul style="list-style-type: none"> <li>■ Full</li> <li>■ Reduced</li> </ul>
Link Widths	1 Lane
SignalPreset8Gb	Signal quality preset selection values are P0, P1, P2, P3, P4, P5, P6, P7, P8, P9, P10.
SignalPreset16Gb	To select multiple signal quality preset, specify as P0_P1_P2
Preset8Gb	Preset selection values are P0_, P1_, P2_, P3_, P4_, P5_, P6_, P7_, P8_, P9_, P10_.
Preset16Gb	To select multiple signal quality preset, specify as P0_P1_P2
Acquisition	BeforeAnalysis
SaveOptions	Save All the Waveforms
DeEmbed2Gb	<ul style="list-style-type: none"> <li>■ Included</li> <li>■ Excluded</li> </ul>
DeEmbed5Gb	<ul style="list-style-type: none"> <li>■ Included</li> <li>■ Excluded</li> </ul>

ParameterName	Value
DeEmbed8Gb	<ul style="list-style-type: none"> <li>■ Included</li> <li>■ Excluded</li> </ul>
DeEmbed16Gb	<ul style="list-style-type: none"> <li>■ Included</li> <li>■ Excluded</li> </ul>
Embed8Gb	<ul style="list-style-type: none"> <li>■ Included</li> <li>■ Excluded</li> </ul>
Equalization8Gb	<ul style="list-style-type: none"> <li>■ Included</li> <li>■ Excluded</li> </ul>
Filterfile2Gb	Filterfile2Gb.ftt
Filterfile5Gb	Filterfile5Gb.ftt
FilterfileDeEmbed8Gb	FilterfileDeEmbed8Gb.ftt
FilterfileEmbed8Gb	FilterfileEmbed8Gb.ftt
EmbedDropdown	<ul style="list-style-type: none"> <li>■ SigTest</li> <li>■ Scope</li> </ul>
EqualizationDropdown	<ul style="list-style-type: none"> <li>■ Optimize</li> <li>■ Fixed</li> </ul>
CTLE Index	1 : -12dB
DFE	-30e-3
EnableDUTAutomation	<ul style="list-style-type: none"> <li>■ Included</li> <li>■ Excluded</li> </ul>
Automation Settings	Use Default Settings
Signal Type	<ul style="list-style-type: none"> <li>■ Square</li> <li>■ Sine</li> </ul>
RecordLength2Gb	2.5e6
RecordLength5Gb	10e6
RecordLength8Gb	10e6
RecordLength16Gb	20e6
SampleRate2Gb	50e9
SampleRate5Gb	50e9
SampleRate8Gb	50e9
SampleRate16Gb	100e9
Bandwidth2Gb	7e9
Bandwidth5Gb	12.5e9

ParameterName	Value
Bandwidth8Gb	12.5e9
Bandwidth16Gb	16e9
Signal Validation	Turn Off Signal Check
SlotNumber	05
Toggle from Gen3P10 to Gen1	<ul style="list-style-type: none"> <li>■ On</li> <li>■ Off</li> </ul>
Signal Validation Threshold(mV)	200
AnalysisMode	CLI
Report Update Mode	<ul style="list-style-type: none"> <li>■ New</li> <li>■ Append</li> <li>■ Replace</li> </ul>
Auto increment report name if duplicate	TRUE or FALSE
Include Pass/Fail Results Summary	TRUE or FALSE
Include Detailed Results	TRUE or FALSE
Include Plot Images	TRUE or FALSE
Include Setup Configuration	TRUE or FALSE
Include Complete Application Configuration	TRUE or FALSE
Include User Comments	TRUE or FALSE
Save As Type	<ul style="list-style-type: none"> <li>■ Web Archive (*.mht;*.mhtml)</li> <li>■ PDF (*.pdf;)</li> </ul>
View Report After Generating	TRUE or FALSE
Report Group Mode	<ul style="list-style-type: none"> <li>■ Test Name</li> <li>■ Lane Name</li> <li>■ Test Result</li> <li>■ Equalization</li> </ul>
Create report at the end	<ul style="list-style-type: none"> <li>■ Included</li> <li>■ Excluded</li> </ul>
DUTID Comment	User comment
Number of retries for instrument IO errors	0 to 5
Run Test More than Once	TRUE or FALSE
Number of Runs	1 to 100

ParameterName	Value
On Failure Rerun	TRUE or FALSE
Number of Reruns On Failure	1 to 100
Time between retries (seconds)	5 to 60
Timer Warning Info Message Popup	<ul style="list-style-type: none"> <li>■ "True"</li> <li>■ "FALSE"</li> </ul>
Timer Warning Info Message Popup Duration	0 to 20
Timer Error Message Popup	<ul style="list-style-type: none"> <li>■ "True"</li> <li>■ "False"</li> </ul>
Timer Error Message Popup Duration	0 to 20
On Failure Stop and Notify	TRUE or FALSE

## Examples

This section provides the examples for the SCPI commands.

Example	Description
TEKEXP:*IDN?\n	It returns the active TekExpress application name running on the scope.
TEKEXP:*OPC?\n	It returns the last command execution status.
TEKEXP:ACQUIRE_MODE PRE-RECORDED\n	It sets the acquire mode as pre-recorded.
TEKEXP:ACQUIRE_MODE?\n	It returns LIVE when acquire mode is set to live.
TEKEXP:EXPORT REPORT\n	It returns the report file in bytes. This can be written into another file for further analysis.
TEKEXP:INFO? REPORT\n	It returns "100,"ReportFileName.mht", when 100 is the filesize in bytes for the filename ReportFileName.
TEKEXP:INFO? WFM\n	It returns "100,"WfmFileName1.wfm";"200,"WfmFileName2.wfm" when 100 is the filesize in bytes for the filename WfmFileName1.wfm and 200 is the filesize in bytes for the filename WfmFileName2.wfm.
TEKEXP:INSTRUMENT "Real Time Scope",DPO72504D ( GPIB8::1::INSTR )\n	It sets the instrument value as DPO72504D ( GPIB8::1::INSTR ) for the selected instrument type Real Time Scope.
TEKEXP:INSTRUMENT? "Real Time Scope" \n	It returns "IDPO72504D ( GPIB8::1::INSTR ), when DPO72504D ( GPIB8::1::INSTR )" is the selected instrument for the instrument type Real Time Scope.
TEKEXP:LASTERROR?\n	It returns ERROR: INSTRUMENT_NOT_FOUND, when no instrument is found.
TEKEXP:LIST? DEVICE\n	It returns "TX-Device,RX-Device" when TX-Device, RX-Device are the available device.
TEKEXP:LIST? INSTRUMENT,"Real Time Scope"\n	It returns "DPO72504D ( GPIB8::1::INSTR ),MSO72504 ( TCIPIP::134.64.248.91::INSTR )" when DPO72504D ( GPIB8::1::INSTR ), MSO72504 ( TCIPIP::134.64.248.91::INSTR ) are the list of available instruments.
TEKEXP:MODE COMPLIANCE\n	It sets the execution mode as compliance.

Example	Description
TEKEXP:MODE?\n	It returns COMPLIANCE when the execution mode is compliance.
TEKEXP:POPOP "OK"\n	It sets OK as the response to active popop in the application.
TEKEXP:POPOP?\n	It returns "OK", when OK is the active popop information shown in the application.
TEKEXP:REPORT GENERATE\n	It generates report for the current session.
TEKEXP:REPORT? "Scope Model"\n	It returns "DPO73304SX" when DPO73304SX is the scope model.
TEKEXP:REPORT? "DUT ID"\n	It returns "DUT001" when DNI_DUT001 is the DUT ID.
TEKEXP:RESULT? "Period using SCOPE (Acquire-Analyze Combined)"\n	It returns Pass when the test result is Pass.
TEKEXP:RESULT? "Period using SCOPE (Acquire-Analyze Combined)", "Margin", 1\n	It returns "L:-50.000ps H:2000.000ps" when L:-50.000ps H:2000.000ps is the value.
TEKEXP:SELECT DEVICE, TX_Device, TRUE\n	It selects TX_Device
TEKEXP:SELECT? DEVICE\n	It returns "TX-Device" when TX-Device is the selected device type.
TEKEXP:SETUP DEFAULT\n	It restores the application to default setup.
TEKEXP:STATE STOP\n	It stops the test execution.
TEKEXP:STATE?\n	It returns as READY when the application is ready to run next measurement.
TEKEXP:STATE? SETUP\n	It returns as NOT_SAVED when the current setup is not saved.
TEKEXP:VALUE GENERAL, "Signal Type", "N1N0"\n	It sets the signal type parameter value to N1N0.
TEKEXP:VALUE? GENERAL, "Signal Type"\n	It returns "N1N0" when N1N0 is the Signal Type value.



## Switch Matrix commands

This section describes the switch matrix commands. It is recommended to execute the switch matrix commands through GPIB interface.

**SWITCH:\*IDN** This command queries the switch matrix version information.

**Syntax.** SWITCH:\*IDN?\n

**Inputs.** NA

**Outputs.** Returns the switch matrix version information.

**Example.** SWITCH:\*IDN?\n returns "Tektronix,Switch Matrix,v1.0.0.0", where v1.0.0.0 is the Switch Matrix version.

**SWITCH:\*OPC** This command queries the previously executed commands execution status.

**Syntax.** SWITCH:\*OPC?\n

**Inputs.** NA

**Outputs.** Returns 0 if the previously executed command execution is in progress.  
Returns 1 if the previously executed command execution is done.

**Example.** SWITCH:\*OPC?\n returns 1, when the previously executed command execution is done.

**SWITCH:CONFIG** This command sets or queries the config file.

**Syntax.** SWITCH:CONFIG {"<ConfigName>" | "<UserConfigFilePath>"}\n  
SWITCH:CONFIG?\n

**Inputs.** <ConfigName> specifies the config file.

<UserConfigFilePath> specifies the config file from the given path.

**Outputs.** Returns the loaded config file name with path.

**Examples.** SWITCH:CONFIG "Keithley S46T"\n sets the config file of Keithley.  
SWITCH:CONFIG "E:\myconfig.xml"\n sets the config file from the given path.  
SWITCH:CONFIG?\n returns "E:\myconfig.xml".

**SWITCH:DE-EMBED:ALL:FILTER\_FILE**

This command sets the filter file for all connections.

**Syntax.** SWITCH:DE-EMBED:ALL:FILTER\_FILE "<SwitchFilterFilePath>",<FixtureFilterFilePath>"\n

**Inputs.** <SwitchFilterFilePath> specifies the switch filter file path.

<FixtureFilterFilePath> specifies the fixture filter file path.

**Outputs.** NA

**Example.** SWITCH:DE-EMBED:ALL:FILTER\_FILE "C:\FilterFiles\SWTCH1.flr","C:\FilterFiles\CABLE\_1.flr"\n sets the switch filter file for all connections and the fixture filter file for all cables connected.

**SWITCH:DE-EMBED:CONN:FILTER\_FILE**

This command sets the filter file for the switch, fixture, and cable for the specified connection.

**Syntax.** SWITCH:DE-EMBED:CONN:FILTER\_FILE "<RelayName>",<InputName>",<SwitchFilterFilePath>",<FixtureFilterFilePath>",<CableFilterFilePath>"\n

**Inputs.** <RelayName> specifies the relay name.

<InputName> specifies the input name.

<SwitchFilterFilePath> specifies the switch filter file path.

<FixtureFilterFilePath> specifies the fixture filter file path.

<CableFilterFilePath> specifies the cable filter file path.

**Example.** SWITCH:DE-EMBED:CONN:FILTER\_FILE "Relay A","1","C:\FilterFiles\RA\_1.flr","C:\FilterFiles\Fxtre\_1.flr","C:\FilterFiles\cbl\_1.flr"\n sets filter files to Relay A's input 1 and to the connected cable.

**SWITCH:DE-EMBED:FILTER\_FILE**

This command queries the filter file based on the mode selected in the application.

**Syntax.** SWITCH:DE-EMBED:FILTER\_FILE?\n

**Inputs.** NA

**Outputs.** Returns the filter file in any of the the below specified format, based on the mode selected.

None
ALL;"<SwitchFilterFilePath>",<FixtureFilterFilePath>;
RELAY_TYPE;"<RelayType1>",<SwitchFilterFilePath1>",<FixtureFilterFilePath1>",<RelayType2>",<SwitchFilterFilePath2>",<FixtureFilterFilePath2>;
RELAY;"<RelayName1>",<SwitchFilterFilePath1>",<FixtureFilterFilePath1>",<RelayName2>",<SwitchFilterFilePath2>",<FixtureFilterFilePath2>;
CONN;"<RelayName1>",<InputName1>",<SwitchFilterFilePath1>",<FixtureFilterFilePath1>",<CableFilterFilePath1>",<RelayName1>",<InputName2>",<SwitchFilterFilePath2>",<FixtureFilterFilePath2>",<CableFilterFilePath2>;

**Example.** SWITCH:DE-EMBED:FILTER\_FILE?\n returns ALL;"C:\FilterFiles\SWTCH1.flc" ,"C:\FilterFiles\Fxtre\_1.flc".

### SWITCH:DE-EMBED:MODE

This command sets or queries the De-Embed mode.

**Syntax.** SWITCH:DE-EMBED:MODE {NONE | ALL | RELAY\_TYPE | RELAY | CONN}\n

SWITCH:DE-EMBED:MODE?\n

**Inputs.** {NONE | ALL | RELAY\_TYPE | RELAY | CONN}

**Outputs.** Returns the De-Embed mode.

**Examples.** SWITCH:DE-EMBED:MODE ALL\n sets the De-Embed mode as ALL.

SWITCH:DE-EMBED:MODE?\n returns ALL.

### SWITCH:DE-EMBED:RELAY:FILTER\_FILE

This command sets the filter file and fixture file for the specified relay.

**Syntax.** SWITCH:DE-EMBED:RELAY:FILTER\_FILE "<RelaName>","<SwitchFilterFilePath>","<FixtureFilterFilePath>"\n

**Inputs.** <RelaName> specifies the relay name.

<SwitchFilterFilePath> specifies the switch filter file path.

<FixtureFilterFilePath> specifies the fixture filter file path.

**Outputs.** SWITCH:DE-EMBED:RELAY:FILTER\_FILE "Relay A","C:\FilterFiles\RA.flc","C:\FilterFiles\Fxtre\_1.flc"\n sets filter files for all connections in Relay A.

### SWITCH:DE-EMBED:RELAY\_TYPE:FILTER\_FILE

This command sets the filter file for specified relay type.

**Syntax.** SWITCH:DE-EMBED:RELAY\_TYPE:FILTER\_FILE "<RelayType>","<SwitchFilterFilePath>","<FixtureFilterFilePath>"\n

**Inputs.** <RelayType> specifies the relay type.

<SwitchFilterFilePath> specifies the switch filter file path.

<FixtureFilterFilePath> specifies the fixture filter file path.

**Example.** SWITCH:DE-EMBED:RELAY\_TYPE:FILTER\_FILE "SP2T","C:\FilterFiles\SP2T.flc","C:\FilterFiles\Fxtre\_1.flc"\n sets filter file for SP2T relay type.

**SWITCH:LASTERROR** This command queries the error occurred while executing last command.

**Syntax.** SWITCH:LASTERROR?\n

**Inputs.** NA

**Outputs.** Returns the error occurred while executing last command.

Error message	Description
NO_ERROR	No error occurred executing last command.
INVALID_COMMAND	The last command sent is either invalid or syntax is not correct.
"No config file loaded."	The last command to load the config file is failed.
"Invalid configuration."	The last command has invalid configuration.
"Invalid linkwidth."	The last command has invalid linkwidth.
"Invalid de-embed mode."	The last command has invalid de-embed mode.
"Invalid signal polarity."	The last command has invalid signal polarity.
"Invalid relay name."	The last command has invalid relay name.
"Invalid relay type."	The last command has invalid relay type.
"Invalid signal name."	The last command has invalid signal name.
"Invalid common value."	The last command has invalid value for common.
"Invalid input ID."	The last command has invalid input ID.

**Example.** SWITCH:LASTERROR?\n returns the last error occurred.

**SWITCH:LINKWIDTH** This command sets or queries the link width.

**Syntax.** SWITCH:LINKWIDTH {X2 | X4 | X8 | X16}\n

SWITCH:LINKWIDTH?\n

**Inputs.** {X2 | X4 | X8 | X16}

**Outputs.** Returns the link width value.

**Examples.** SWITCH:LINKWIDTH X8\n sets the linkWidth to 8.

SWITCH:LINKWIDTH?\n returns 8.

<b>SWITCH:RELAY:CASCADE</b>	<p>This command sets or queries the cascade of the relay.</p> <p><b>Syntax.</b> SWITCH:RELAY:CASCADE "&lt;FromRelayName&gt;","&lt;ToRelayName&gt;","&lt;InputName&gt;"\n SWITCH:RELAY:CASCADE? "&lt;RelayName&gt;"\n</p> <p><b>Inputs.</b> &lt;FromRelayName&gt; specifies the relay name from which to cascade. &lt;ToRelayName&gt; specifies the relay name to cascade. &lt;InputName&gt; specifies the input name of the relay to cascade. &lt;RelayName&gt; specifies the relay name.</p> <p><b>Outputs.</b> Returns the cascading info of the relay if cascaded else returns NOT_CASCADED.</p> <p><b>Example.</b> SWITCH:RELAY:CASCADE "Relay A","Relay B","2"\n sets Relay A's output cascade to Relay B's input 2. SWITCH:RELAY:CASCADE? "Relay A"\n returns "Relay B","2". SWITCH:RELAY:CASCADE? "Relay B"\n returns NOT_CASCADED.</p>
<b>SWITCH:RELAY:CASCADE</b>	<p>This command sets or queries cascaded state of the relay.</p> <p><b>Syntax.</b> SWITCH:RELAY:CASCADED "&lt;RelayName&gt;",{TRUE   FALSE}\n SWITCH:RELAY:CASCADED? "&lt;RelayName&gt;"\n</p> <p><b>Inputs.</b> &lt;RelayName&gt; specifies the relay name. TRUE or FALSE to cascade the relay or not.</p> <p><b>Outputs.</b> Returns whether the relay is cascaded or not.</p> <p><b>Examples.</b> SWITCH:RELAY:CASCADED "Relay A",TRUE\n sets the cascaded state of Relay A to TRUE. SWITCH:RELAY:CASCADED? "Relay A"\n returns TRUE.</p>
<b>SWITCH:RELAY:COMMON</b>	<p>This command sets or queries the relays common connection connected to scope channels.</p> <p><b>Syntax.</b> SWITCH:RELAY:COMMON "&lt;RelayName&gt;",{CH1   CH2   CH3   CH4}\n SWITCH:RELAY:COMMON? "&lt;RelayName&gt;"\n</p> <p><b>Inputs.</b> &lt;RelayName&gt; specifies the relay name. {CH1   CH2   CH3   CH4} specifies the channel number.</p> <p><b>Outputs.</b> Returns the channel connected to the common connection of relay.</p> <p><b>Example.</b> SWITCH:RELAY:COMMON "Relay A",CH1\n sets the common connection of Relay A to CH1. SWITCH:RELAY:COMMON? "Relay A"\n returns CH1.</p>

**SWITCH:RELAY:POLARITY**

This command sets or queries the signal polarity of the specified relay.

**Syntax.** SWITCH:RELAY:POLARITY "<RelayName>",{POS | NEG | DIFF}\n  
SWITCH:RELAY:POLARITY? "<RelayName>"\n

**Inputs.** <RelayName> specifies the relay name.

{POS | NEG | DIFF} specifies the signal polarity as Positive, Negative or Differential respectively.

**Outputs.** Returns the signal polarity of the relay.

**Examples.** SWITCH:RELAY:POLARITY "Relay A",POS\n sets the Relay A's signal polarity to POS.

SWITCH:RELAY:POLARITY? "Relay A"\n returns POS.

**SWITCH:RELAY:SIGNAL**

This command sets or queries the signal name connected to input port.

**Syntax.** SWITCH:RELAY:SIGNAL  
"<RelayName>","<InputName>","<SignalName>"\n

SWITCH:RELAY:SIGNAL? "<RelayName>","<InputName>"\n

**Inputs.** <RelayName> specifies the relay name.

<InputName> specifies the input name of the relay.

<SignalName> specifies the signal name to connect to the relays input.

**Outputs.** Returns the signal name connected to the input port.

**Example.** SWITCH:RELAY:SIGNAL "Relay A","1","Lane0+"\n sets the signal name Lane0+ to Relay A's input 1.

SWITCH:RELAY:SIGNAL? "Relay A","1"\n returns "Lane0+".

---

# Reference

## De-embed using filter files

TekExpress PCIe provides an option to de-embed the signal path using filter files. You create the filter files. The filter files are .flt files composed of de-embed filter coefficients for a particular sampling rate. A filter file created for one sampling rate might not work for other sampling rates, so it is important to understand at what sampling rate the measurements are being performed.

Also, the de-embedding filters might differ based on the type of input. For example, if a single ended input is made using a matched SMA cable pair, a filter file for de-embedding a single SMA cable must be provided, since matched SMA cables mostly have similar s-parameters. So in this case, the same filter file is used to de-embed the SMA cable pair.

The maximum sampling rate provided on any channel combination on MSO/DPO/DSA70000/C/D/DX series oscilloscopes is 50 GS/s in realtime mode. The maximum sampling rate provided on Ch1-Ch3 and Ch2-Ch4 channel combinations on MSO/DPO/DSA70000C/D/DX series oscilloscopes is 100 GS/s, provided only 2 channels are on at a given time.

### See also

[\*Common test parameters and values\*](#)

[\*Configuration test parameters\*](#)

## Setup files

TekExpress PCI Express package contains setup files (\*.TekX) which can be used at PCIE Gen3 workshop for compliance tests.

**Table 14: Setup files configuration details**

Setup files (*.TekX)	Configuration details (exclusively used in Gen1/2/3 Gold Suite of PCI-SIG Work Shop (WS))
WorkShop_CEM_AIC_x1	<ul style="list-style-type: none"> <li>■ Specification - CEM</li> <li>■ Device Type - Add-In-Card</li> <li>■ Version - Gen3 - 3.0</li> <li>■ Data Rates - 2.5 Gbps, 5 Gbps (Tx equalization 3.5dB, 6 dB) and 8 Gbps</li> <li>■ Signal Quality Preset Selection - P0, P7 and P8 for L0 and All Presets from P0 to P10 for Lane0</li> <li>■ Link Width - 1 Lane (Selected test lane: L0)</li> <li>■ Automated DUT Control - unchecked</li> <li>■ Signal Validation - Pattern Decoding</li> <li>■ SigTest Interface Mode: CMD line - SigTest displayed and its HTML report saved with TE Report</li> </ul>
WorkShop_CEM_AIC_x2	<ul style="list-style-type: none"> <li>■ Specification - CEM</li> <li>■ Device Type - Add-In-Card</li> <li>■ Version - Gen3 - 3.0</li> <li>■ Data Rates - 2.5 Gbps, 5 Gbps (Tx equalization 3.5dB, 6 dB) and 8 Gbps</li> <li>■ Signal Quality Preset Selection - P0, P7 and P8 for L0 and All Presets from P0 to P10 for Lane0</li> <li>■ Link Width - 2 Lanes (Selected test lane: L0)</li> <li>■ Automated DUT Control - unchecked</li> <li>■ Signal Validation - Pattern Decoding</li> <li>■ SigTest Interface Mode: CMD line - SigTest displayed and its HTML report saved with TE Report</li> </ul>
WorkShop_CEM_AIC_x4	<ul style="list-style-type: none"> <li>■ Specification - CEM</li> <li>■ Device Type - Add-In-Card</li> <li>■ Version - Gen3 - 3.0</li> <li>■ Data Rates - 2.5 Gbps, 5 Gbps (Tx equalization 3.5dB, 6 dB) and 8 Gbps</li> <li>■ Signal Quality Preset Selection - P0, P7 and P8 for L0 and All Presets from P0 to P10 for Lane0</li> <li>■ Link Width - 4 Lanes (Selected test lane: L0, L03)</li> <li>■ Automated DUT Control - unchecked</li> <li>■ Signal Validation - Pattern Decoding</li> <li>■ SigTest Interface Mode: CMD line - SigTest displayed and its HTML report saved with TE Report</li> </ul>



Setup files (*.TekX)	Configuration details (exclusively used in Gen1/2/3 Gold Suite of PCI-SIG Work Shop (WS))
WorkShop_CEM_AIC_x8	<ul style="list-style-type: none"> <li>■ Specification - CEM</li> <li>■ Device Type - Add-In-Card</li> <li>■ Version - Gen3 - 3.0</li> <li>■ Data Rates - 2.5 Gbps, 5 Gbps (Tx equalization 3.5dB, 6 dB) and 8 Gbps</li> <li>■ Signal Quality Preset Selection - P0, P7 and P8 for L0 and All Presets from P0 to P10 for Lane0</li> <li>■ Link Width - 8 Lanes (Selected test lane: L0, L03, L07)</li> <li>■ Automated DUT Control - unchecked</li> <li>■ Signal Validation - Pattern Decoding</li> <li>■ SigTest Interface Mode: CMD line - SigTest displayed and its HTML report saved with TE Report</li> </ul>
WorkShop_CEM_AIC_x16	<ul style="list-style-type: none"> <li>■ Specification - CEM</li> <li>■ Device Type - Add-In-Card</li> <li>■ Version - Gen3 - 3.0</li> <li>■ Data Rates - 2.5 Gbps, 5 Gbps (Tx equalization 3.5dB, 6 dB) and 8 Gbps</li> <li>■ Signal Quality Preset Selection - P0, P7 and P8 for L0 and All Presets from P0 to P10 for Lane0</li> <li>■ Link Width - 16 Lanes (Selected test lane: L0, L07, L15)</li> <li>■ Automated DUT Control - unchecked</li> <li>■ Signal Validation - Pattern Decoding</li> <li>■ SigTest Interface Mode: CMD line - SigTest displayed and its HTML report saved with TE Report</li> </ul>
WorkShop_CEM_SYB_x1	<ul style="list-style-type: none"> <li>■ Specification - CEM</li> <li>■ Device Type - Add-In-Card</li> <li>■ Version - Gen3 - 3.0</li> <li>■ Data Rates - 2.5 Gbps, 5 Gbps (Tx equalization 3.5dB, 6 dB) and 8 Gbps</li> <li>■ Signal Quality Preset Selection - P0, P7 and P8 for L0 and All Presets from P0 to P10 for Lane0</li> <li>■ Link Width - 1 Lane (Selected test lane: L0)</li> <li>■ Automated DUT Control - unchecked</li> <li>■ Signal Validation - Pattern Decoding</li> <li>■ SigTest Interface Mode: CMD line - SigTest displayed and its HTML report saved with TE Report</li> </ul>

Setup files (*.TekX)	Configuration details (exclusively used in Gen1/2/3 Gold Suite of PCI-SIG Work Shop (WS))
WorkShop_CEM_SYB_x2	<ul style="list-style-type: none"> <li>■ Specification - CEM</li> <li>■ Device Type - Add-In-Card</li> <li>■ Version - Gen3 - 3.0</li> <li>■ Data Rates - 2.5 Gbps, 5 Gbps (Tx equalization 3.5dB, 6 dB) and 8 Gbps</li> <li>■ Signal Quality Preset Selection - P0, P7 and P8 for L0 and All Presets from P0 to P10 for Lane0</li> <li>■ Link Width - 2 Lanes (Selected test lane: L0)</li> <li>■ Automated DUT Control - unchecked</li> <li>■ Signal Validation - Pattern Decoding</li> <li>■ SigTest Interface Mode: CMD line - SigTest displayed and its HTML report saved with TE Report</li> </ul>
WorkShop_CEM_SYB_x4	<ul style="list-style-type: none"> <li>■ Specification - CEM</li> <li>■ Device Type - Add-In-Card</li> <li>■ Version - Gen3 - 3.0</li> <li>■ Data Rates - 2.5 Gbps, 5 Gbps (Tx equalization 3.5dB, 6 dB) and 8 Gbps</li> <li>■ Signal Quality Preset Selection - P0, P7 and P8 for L0 and All Presets from P0 to P10 for Lane0</li> <li>■ Link Width - 4 Lanes (Selected test lane: L0, L03)</li> <li>■ Automated DUT Control - unchecked</li> <li>■ Signal Validation - Pattern Decoding</li> <li>■ SigTest Interface Mode: CMD line - SigTest displayed and its HTML report saved with TE Report</li> </ul>
WorkShop_CEM_SYB_x8	<ul style="list-style-type: none"> <li>■ Specification - CEM</li> <li>■ Device Type - Add-In-Card</li> <li>■ Version - Gen3 - 3.0</li> <li>■ Data Rates - 2.5 Gbps, 5 Gbps (Tx equalization 3.5dB, 6 dB) and 8 Gbps</li> <li>■ Signal Quality Preset Selection - P0, P7 and P8 for L0 and All Presets from P0 to P10 for Lane0</li> <li>■ Link Width - 8 Lanes (Selected test lane: L0,L03,L07)</li> <li>■ Automated DUT Control - unchecked</li> <li>■ Signal Validation - Pattern Decoding</li> <li>■ SigTest Interface Mode: CMD line - SigTest displayed and its HTML report saved with TE Report</li> </ul>

Setup files (*.TekX)	Configuration details (exclusively used in Gen1/2/3 Gold Suite of PCI-SIG Work Shop (WS))
WorkShop_CEM_SYB_x16	<ul style="list-style-type: none"> <li>■ Specification - CEM</li> <li>■ Device Type - Add-In-Card</li> <li>■ Version - Gen3 - 3.0</li> <li>■ Data Rates - 2.5 Gbps, 5 Gbps (Tx equalization 3.5dB, 6 dB) and 8 Gbps</li> <li>■ Signal Quality Preset Selection - P0, P7 and P8 for L0 and All Presets from P0 to P10 for Lane0</li> <li>■ Link Width - 16 Lanes (Selected test lane: L0,L07,L15)</li> <li>■ Automated DUT Control - unchecked</li> <li>■ Signal Validation - Pattern Decoding</li> <li>■ SigTest Interface Mode: CMD line - SigTest displayed and its HTML report saved with TE Report</li> </ul>
WorkShop_U2_Module_x1	<ul style="list-style-type: none"> <li>■ Specification - U.2 (SFF8639)</li> <li>■ Device Type - Module</li> <li>■ Version - Gen3 - 3.0</li> <li>■ Data Rates - 8 Gbps</li> <li>■ Signal Quality Preset Selection - P0, P7 and P8 for L0 and All Presets from P0 to P10 for Lane0</li> <li>■ Link Width - 1 Lane (Selected test lane: L0)</li> <li>■ Automated DUT Control - unchecked</li> <li>■ Signal Validation - Pattern Decoding</li> <li>■ SigTest Interface Mode: CMD line - SigTest displayed and its HTML report saved with TE Report</li> </ul>
WorkShop_U2_Module_x2	<ul style="list-style-type: none"> <li>■ Specification - U.2 (SFF8639)</li> <li>■ Device Type - Module</li> <li>■ Version - Gen3 - 3.0</li> <li>■ Data Rates - 8 Gbps</li> <li>■ Signal Quality Preset Selection - P0, P7 and P8 for L0 and All Presets from P0 to P10 for Lane0</li> <li>■ Link Width - 2 Lanes (Selected test lane: L0)</li> <li>■ Automated DUT Control - unchecked</li> <li>■ Signal Validation - Pattern Decoding</li> <li>■ SigTest Interface Mode: CMD line - SigTest displayed and its HTML report saved with TE Report</li> </ul>

Setup files (*.TekX)	Configuration details (exclusively used in Gen1/2/3 Gold Suite of PCI-SIG Work Shop (WS))
WorkShop_U2_Module_x4	<ul style="list-style-type: none"> <li>■ Specification - U.2 (SFF8639)</li> <li>■ Device Type - Module</li> <li>■ Version - Gen3 - 3.0</li> <li>■ Data Rates - 8 Gbps</li> <li>■ Signal Quality Preset Selection - P0, P7 and P8 for L0 and All Presets from P0 to P10 for Lane0</li> <li>■ Link Width - 4 Lanes (Selected test lane: L0,L03)</li> <li>■ Automated DUT Control - unchecked</li> <li>■ Signal Validation - Pattern Decoding</li> <li>■ SigTest Interface Mode: CMD line - SigTest displayed and its HTML report saved with TE Report</li> </ul>
WorkShop_U2_Host_x1	<ul style="list-style-type: none"> <li>■ Specification - U.2 (SFF8639)</li> <li>■ Device Type - Host</li> <li>■ Version - Gen3 - 3.0</li> <li>■ Data Rates - 8 Gbps</li> <li>■ Signal Quality Preset Selection - P0, P7 and P8 for L0 and All Presets from P0 to P10 for Lane0</li> <li>■ Link Width - 1 Lane (Selected test lane: L0)</li> <li>■ Automated DUT Control - unchecked</li> <li>■ Signal Validation - Pattern Decoding</li> <li>■ SigTest Interface Mode: CMD line - SigTest displayed and its HTML report saved with TE Report</li> </ul>

Setup files (*.TekX)	Configuration details (exclusively used in Gen1/2/3 Gold Suite of PCI-SIG Work Shop (WS))
WorkShop_U2_Host_x2	<ul style="list-style-type: none"> <li>■ Specification - U.2 (SFF8639)</li> <li>■ Device Type - Host</li> <li>■ Version - Gen3 - 3.0</li> <li>■ Data Rates - 8 Gbps</li> <li>■ Signal Quality Preset Selection - P0, P7 and P8 for L0 and All Presets from P0 to P10 for Lane0</li> <li>■ Link Width - 2 Lanes (Selected test lane: L0)</li> <li>■ Automated DUT Control - unchecked</li> <li>■ Signal Validation - Pattern Decoding</li> <li>■ SigTest Interface Mode: CMD line - SigTest displayed and its HTML report saved with TE Report</li> </ul>
WorkShop_U2_Host_x4	<ul style="list-style-type: none"> <li>■ Specification - U.2 (SFF8639)</li> <li>■ Device Type - Host</li> <li>■ Version - Gen3 - 3.0</li> <li>■ Data Rates - 8 Gbps</li> <li>■ Signal Quality Preset Selection - P0, P7 and P8 for L0 and All Presets from P0 to P10 for Lane0</li> <li>■ Link Width - 4 Lanes (Selected test lane: L0, L03)</li> <li>■ Automated DUT Control - unchecked</li> <li>■ Signal Validation - Pattern Decoding</li> <li>■ SigTest Interface Mode: CMD line - SigTest displayed and its HTML report saved with TE Report</li> </ul>

### How to open a setup file

1. Click **Options > Open Test Setup**
2. Select the TekExpress Setup File as per your required configuration. Check Setup files configuration details table for configuration details.

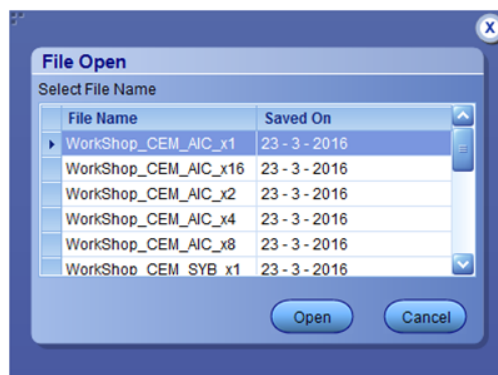

3. Make the configuration details and start the test execution.

4. Click **Save Test Setup As** and save the setup.

---

**NOTE.** You cannot edit the TekExpress Test Setup files as they are in **Read Only** mode.

---



---

**NOTE.** The setup files path is *C:\Program Files\Tektronix\TekExpress\TekExpress PCI Express\Setup Files*

---

**RF Switch configuration files** TekExpress PCI Express package contains RF Switch configuration files.

File name	Configuration details
PCE_Keithley_SYB_x6	<p>Recall this file for Keithley S46T RF Switch and System-Board device type. The below are the configuration details:</p> <ul style="list-style-type: none"> <li>■ Lane0 Positive to Lane05 Positive connected as Signal Inputs to Relay S1.</li> <li>■ Lane0 Negative to Lane05 Negative connected as Signal Inputs to Relay S3.</li> <li>■ Common output of relay A, B is connected to CH1, CH3 of the oscilloscope respectively. For 2-Unit, SX box &gt;= 59 GHz, set the common outputs to CH1, CH3 respectively.</li> <li>■ Connect the Ref Clock Positive and Negative from CLB to CH3, CH4 of oscilloscope. For 2-Unit, SX box &gt;=59GHz, set the Ref Clock Positive and Negative to CH2 and CH4 respectively.</li> </ul>
PCE_KthCCD_SYB_x12	<p>Recall this file for Keithley S46T RF Switch and System-Board device type. The below are the configuration details:</p> <ul style="list-style-type: none"> <li>■ Lane0 Positive to Lane05 Positive connected as Signal Inputs to Relay A which is Cascade to Relay 4 and Input to NO.</li> <li>■ Lane0 Negative to Lane05 Negative connected as Signal Inputs to Relay B which is Cascade to Relay 5 and Input to NO.</li> <li>■ Lane06 Positive to Lane11 Positive connected as Signal Inputs to Relay C which is Cascade to Relay 4 and Input to NC.</li> <li>■ Lane06 Negative to Lane11 Negative connected as Signal Inputs to Relay D which is Cascade to Relay 5 and Input to NC.</li> <li>■ Relay 4 is selected as Positive and Relay 5 as Negative; common output of 4 and 5 is connected to CH1, CH2 of the oscilloscope respectively. For 2-Unit, SX box &gt;= 59 GHz, set the common outputs to CH1, CH3 respectively.</li> <li>■ Connect the Ref Clock Positive and Negative from CLB to CH3, CH4 of oscilloscope. For 2-Unit, SX box &gt;=59GHz, set the Ref Clock Positive and Negative to CH2 and CH4 respectively.</li> </ul>

File name	Configuration details
PCE_Giga_SYB_x8	<p>Recall this file for Gigatronics ASCOR 8000 Series RF Switch and System-Board device type. The below are the configuration details:</p> <ul style="list-style-type: none"> <li>■ Lane0 Positive to Lane07 Positive connected as Signal Inputs to Relay S1.</li> <li>■ Lane0 Negative to Lane07 Negative connected as Signal Inputs to Relay S3.</li> <li>■ Common output of relay S1, S3 is connected to CH1, CH3 of the oscilloscope respectively. For 2-Unit, SX box &gt;= 59 GHz, set the common outputs to CH1, CH3 respectively.</li> <li>■ Connect the Ref Clock Positive and Negative from CLB to CH3, CH4 of oscilloscope. For 2-Unit, SX box &gt;=59GHz, set the Ref Clock Positive and Negative to CH2 and CH4 respectively.</li> </ul>
PCE_GigCCD_SYB_x16	<p>Recall this file for Gigatronics ASCOR 8000 Series RF Switch and System-Board device type. The below are the configuration details:</p> <ul style="list-style-type: none"> <li>■ Lane0 Positive to Lane07 Positive connected as Signal Inputs to Relay S1 which is Cascade to Relay S2 and Input to NO.</li> <li>■ Lane0 Negative to Lane07 Negative connected as Signal Inputs to Relay S3 which is Cascade to Relay S5 and Input to NO.</li> <li>■ Lane08 Positive to Lane15 Positive connected as Signal Inputs to Relay S4 which is Cascade to Relay S2 and Input to NC.</li> <li>■ Lane08 Negative to Lane15 Negative connected as Signal Inputs to Relay S6 which is Cascade to Relay s5 and Input to NC.</li> <li>■ Relay S2 is selected as Positive and Relay S5 as Negative; common output of S2 and S5 is connected to CH1, CH2 of the oscilloscope respectively. For 2-Unit, SX box &gt;= 59 GHz, set the common outputs to CH1, CH3 respectively.</li> <li>■ Connect the Ref Clock Positive and Negative from CLB to CH3, CH4 of oscilloscope. For 2-Unit, SX box &gt;=59GHz, set the Ref Clock Positive and Negative to CH2 and CH4 respectively.</li> </ul>

File name	Configuration details
PCE_Keithley_AIC_x12	<p>Recall this file for Keithley S46T RF Switch and Add-In-Card device type. The below are the configuration details:</p> <ul style="list-style-type: none"><li>■ Lane0 Positive to Lane05 Positive connected as Signal Inputs to Relay A.</li><li>■ Lane0 Negative to Lane05 Negative connected as Signal Inputs to Relay B.</li><li>■ Lane08 Positive to Lane11 Positive connected as Signal Inputs to Relay C.</li><li>■ Lane08 Negative to Lane11 Negative connected as Signal Inputs to Relay D.</li><li>■ Common output of relay A, B, C, D is connected to CH1, CH2, CH3, CH4 of the oscilloscope respectively. For 2-Unit, SX box <math>\geq</math> 59 GHz, set the common outputs to CH1, CH3, CH2 and CH4 respectively.</li></ul>
PCE_Giga_AIC_x16	<p>Recall this file for Gigatronix ASCOR 8000 Series RF Switch and Add-In-Card device type. The below are the configuration details:</p> <ul style="list-style-type: none"><li>■ Lane0 Positive to Lane07 Positive connected as Signal Inputs to Relay S1.</li><li>■ Lane0 Negative to Lane07 Negative connected as Signal Inputs to Relay S3.</li><li>■ Lane08 Positive to Lane15 Positive connected as Signal Inputs to Relay S4.</li><li>■ Lane08 Negative to Lane15 Negative connected as Signal Inputs to Relay S6.</li><li>■ Common output of relay S1, S2, S3, S4 is connected to CH1, CH2, CH3, CH4 of the oscilloscope respectively. For 2-Unit, SX box <math>\geq</math> 59 GHz, set the common outputs to CH1, CH3, CH2 and CH4 respectively.</li></ul>



# Index

## A

- Acquire live waveforms, 26
- Acquire parameters
  - including in test reports, 49
  - viewing in reports, 52
- Acquisition tab, 33
- Acquisitions tab
  - refresh channel sources info, 38
  - set channel sources, 38
  - set waveform save options, 36
  - set waveform source (prerecorded files), 37
  - setAcquire options, 35
  - view detected probes, 38
- Activate the license, 9
- Advanced View, 55
- Application overview, 69
- Application version, 9
- Automate RF switch, 33

## B

- Bandwidth, 40

## C

- Cascade, 83
- Cascade (relay cascade), 83
- Channel Status, 74
- Command buttons, 15
- Comments, 26
- Compensate the signal path, 62
- Compliance Mode, 40, 55
- Compliance View, 55
- Configuration parameters, 40
- Configuring email notifications, 22
- Connected instruments
  - searching for, 20
- Connection requirements, 55

## D

- De-embed settings

- apply a filter file for all relays, 78
- apply a filter file for each connection separately, 80
- apply a filter file for each relay separately, 79
- apply a filter file for each relay type separately, 79
- De-embedding, 123
- Detailed log view, 43
- Device parameters, 26
- Device profile connections, 55
- Device profiles, 26
- DPOJET Plug-In, 6
- DUT ID, 26
- DUT parameters, 26
- DUT type
  - 10GBase-KR, 26
  - 40GBase-KR4, 26

## E

- Email notifications, 22
- Email settings, 21
- Equipment setup, 55
- Error messages, 85
- Evaluation mode, 13
- Exiting the application, 14

## F

- File name extensions, 11
- Filter files, 123
- Free trials, 13, 55

## G

- Global settings, 40
- Graphical view of switch matrix configuration, 81

## H

- Help conventions, 2
- Host tests, 55

- I**
  - Initialize the oscilloscope, 83
  - Installing the software
    - DPOJET Plug-In, 6
    - TekExpress application for PCIe, 6
  - Instruments
    - discovering connected, 19
    - viewing connected, 20
  - Instruments and accessories required, 4
  - Instruments detected, 40
- K**
  - Keep On Top, 13
  - Key, 13
- L**
  - lanes, 33
  - Lanes
    - number of, 26
  - License, 13
  - License activation, 9
  - License agreement, 9
  - Limits Editor, 40
  - Link width, 82
  - Loading a test setup, 67
  - Log view
    - save file, 43
  - Log view tab, 43
- M**
  - Measurement limits, 40
  - Menus, 17
  - Mode
    - Compliance, 40
    - User Defined, 40
  - Module tests, 55
  - My TekExpress folder
    - files stored in, 47
    - location of, 7
- N**
  - Notifications (test failure), 42
- O**
  - Opening a saved test setup, 67
  - Options menu
    - Instrument control settings, 19
    - Keep On Top, 13
  - Oscilloscope compensation, 62
  - Overall test result, 45
- P**
  - Panels, 23
  - Pass/Fail summary
    - viewing, 52
  - Pass/Fail Summary
    - including in reports, 51
  - Plot images
    - including in reports, 51
    - viewing, 52
  - Preferences menu, 45
  - Preferences parameters, 42
  - Preferences tab, 25, 42
  - Prerecorded waveform files, 26, 33
  - prerecorded waveform files (acquisitions), 37
  - Prerun checklist, 64
  - Probes (acquisitions), 38
- R**
  - Reactivate the license, 9
  - Real time oscilloscope, 40
  - Recalling a test setup, 67
  - Record length, 40
  - Refresh sources (acquisitions), 38
  - Related documentation, 1
  - Relay cascade, 83
  - Relay configuration
    - cascade, 75
    - common, 76
    - relay name, 75
    - signal, 76
    - signal polarity, 75
  - Report name, 50
  - Report options, 49
  - Report sections, 52

## Reports

- adding user comments to, 26
- receiving in email notifications, 22

Reports panel, 23, 48

Resource file, 13

Results panel, 45

RF switch, 33

RF Switch configuration file details, 130

**S**

Sample Rate, 40

Sampling rate, 123

Saving test setups, 66

Saving tests, 47

Saving the switch matrix configuration, 81

## SCPI commands

- Command parameters list, 109
- Examples, 115
- SWITCH:\*IDN, 117
- SWITCH:\*OPC, 117
- SWITCH:CONFIG, 117
- SWITCH:DE-EMBED:ALL:FILTER\_FILE, 118
- SWITCH:DE-EMBED:CONN:FILTER\_FILE, 118
- SWITCH:DE-EMBED:FILTER\_FILE, 118
- SWITCH:DE-EMBED:MODE, 119
- SWITCH:DE-EMBED:RELAY\_TYPE:FILTER\_FILE, 119
- SWITCH:DE-EMBED:RELAY:FILTER\_FILE, 119
- SWITCH:LASTERROR, 120
- SWITCH:LINKWIDTH, 120
- SWITCH:RELAY:CASCADE, 121
- SWITCH:RELAY:CASCADED, 121
- SWITCH:RELAY:COMMON, 121
- SWITCH:RELAY:POLARITY, 122
- SWITCH:RELAY:SIGNAL, 122
- TEKEXP:\*IDN?, 95
- TEKEXP:\*OPC?, 95
- TEKEXP:ACQUIRE\_MODE, 96
- TEKEXP:ACQUIRE\_MODE?, 96
- TEKEXP:EXPORT, 97
- TEKEXP:INFO?, 97

TEKEXP:INSTRUMENT, 98

TEKEXP:INSTRUMENT?, 98

TEKEXP:LASTERROR?, 99

TEKEXP:LIST?, 99

TEKEXP:MODE, 100

TEKEXP:MODE?, 101

TEKEXP:POPUP, 101

TEKEXP:POPUP?, 102

TEKEXP:REPORT, 102

TEKEXP:REPORT?, 103

TEKEXP:RESULT?, 103

TEKEXP:SELECT, 104

TEKEXP:SELECT?, 105

TEKEXP:SETUP, 105

TEKEXP:STATE, 106

TEKEXP:STATE?, 106

TEKEXP:VALUE, 107

TEKEXP:VALUE?, 108

Selecting test report contents, 49

Selecting tests, 32

Session files, 47

Session folders, 47

Set acquisition Acquire options, 35

Set waveform save options, 36

Setting up equipment, 55

Setting up tests, 55, 61

Setup files, 124

Setup panel, 23, 25

Setup panel views, 26

Software installation, 6

Software version, 9

Sources (acquisitions), 38

Status indicators, 77

Status panel, 43

Support, 2

Switch matrix configuration

- additional lanes, 71

- configuration, 70

- de-embed, 72

- debug mode, 73

- graphical view, 75

- link width, 71

- relays, 74

- rename lanes, 71
- vendor, 70
- Switch self test, 82
- System requirements, 3

## T

- Technical support, 2
- TekExpress application for PCIe, 6
- Test failure action, 42
- Test groups, 32
- Test parameters (Configuration tab), 40
- Test reports, 52
- Test results
  - emailing, 22
- Test selection controls, 32
- Test setup files, 47
- Test setup steps, 61
- Test setups
  - creating, 67
  - load, 67
  - open, 67
  - recalling, 67
  - saving, 66
- Test status tab, 43

- Test-related files, 47
- Tests
  - running, 64
  - selecting, 32
  - setting up, 55

## U

- Untitled session folder, 7
- User account setting (Windows 7), 5
- User comments
  - location in reports, 52
- User Comments
  - including in reports, 51
- User Defined Mode, 40, 55

## V

- View probes (acquisitions), 38

## W

- Waveform files
  - locating and storing, 47
- Windows 7 user account setting, 5