

**Online Help**



**RT-Eye<sup>®</sup> Serial Compliance and Analysis  
Application**

**077-0013-00**

Adapted from the RT-Eye Online Help, Version 2.0.0

Copyright © Tektronix, Inc. All rights reserved. Licensed software products are owned by Tektronix or its suppliers and are protected by United States copyright laws and international treaty provisions.

Use, duplication, or disclosure by the Government is subject to restrictions as set forth in subparagraph (c)(1)(ii) of the Rights in Technical Data and Computer Software clause at DFARS 252.227-7013, or subparagraphs (c)(1) and (2) of the Commercial Computer Software -- Restricted Rights clause at FAR 52.227-19, as applicable.

Tektronix products are covered by U.S. and foreign patents, issued and pending. Information in this publication supercedes that in all previously published material. Specifications and price change privileges reserved.

TEKTRONIX and TEK are registered trademarks of Tektronix, Inc.

RT-Eye Serial Data Compliance and Analysis Online Help, 076-0026-00, Version 2.0

### **Contacting Tektronix**

Tektronix, Inc.

14200 SW Karl Braun Drive or P.O. Box 500

Beaverton, OR 97077 USA

For product information, sales, service, and technical support:

- In North America, call 1-800-833-9200.
- Worldwide, visit [www.tektronix.com](http://www.tektronix.com) to find contacts in your area.

General Safety Summary .....	xiv
------------------------------	-----

## **Welcome to the RT-Eye<sup>®</sup> Serial Compliance and Analysis Application**

### **xv**

Five-Time Free Trial .....	xvi
Related Documentation .....	xvi
GPIB Information .....	xvii
Relevant Web Sites .....	xvii
Application CD Contents .....	xviii
Access to PDF Files .....	xix
Conventions .....	xx
Types of Online Help Information .....	xxi
Using Online Help .....	xxii
Online Help for the Report Generator .....	xxiii
Online Help for Compliance Modules .....	xxiii
Find Tab and Searches .....	xxiv
Feedback	xxiv
General Information .....	xxiv
Application-Specific Information .....	xxiv

## **Getting Started..... 1**

Product Description .....	1
Analysis and Compliance Modules .....	1
Compatibility .....	2
Requirements and Restrictions .....	3
Minimum Required System Configuration .....	4
Accessories .....	4
Installation	4
Connecting to a Device Under Test (DUT) .....	5
Probe Information .....	5
Power Spectrum of a 2.5 Gb/sec Signal Example .....	6
Two TCA-to-SMA Adaptors, Diagram A .....	6
One P73XX SMA Differential Probe, Diagram B .....	7
Two P72XX Single-Ended or P73XX Differential Probes, Diagram C .....	7
One P73XX Differential Probe, Diagram D .....	8

Deskewing Probes and Channels .....	8
<b>Operating Basics .....</b>	<b>9</b>
About Basic Operations .....	9
Starting the Application .....	10
Oscilloscope Menu Bar and Selected Application .....	11
Application Interface.....	11
User Interface Definitions.....	12
Menu With Application User Interface Items .....	13
Application Menu Bar and Drop-Down Lists.....	14
Using Basic Oscilloscope Functions.....	14
Returning to the Application .....	15
Hiding the Application .....	15
Minimizing and Maximizing the Application .....	15
Exiting the Application .....	15
Docking the Application .....	16
Undocking the Application .....	16
Application Directories .....	17
Directory Structure for the Serial Analysis Application .....	18
File Name Extensions.....	19
How to Enter Alphanumerical Values.....	20
Virtual Keypad .....	21
Virtual Keyboard.....	22
Using MyTest.....	22
About My Test.....	22
Saving MyTest .....	23
Running MyTest.....	23
Using Serial Data Wizard .....	24
About the Serial Data Wizard .....	24
Probe type.....	25
Measurement Sources .....	26
Standards Selection .....	27
Measurement Categories .....	28
Autoset Source Levels.....	29
Autoset Source Reference Levels.....	30

---

Plots.....	30
File Menus	33
File Menu Definitions .....	33
About the File menus .....	34
Saving a Setup File.....	34
File: Save Browser .....	35
Recalling a Saved Setup File.....	36
File: Recall Browser.....	37
Recalling the Default Setup.....	38
Recalling a Recently Saved or Accessed Setup File .....	38
Recall Recent Drop-Down List Example .....	39
Defining Preferences .....	39
File Preferences Options .....	40
File: Preferences Menu.....	40
About Setting up the Application for Analysis .....	41
General Steps to Set Up the Application.....	42
Selecting an Analysis or Compliance Module .....	43
Selecting the Analysis Module.....	43
Selecting a Compliance Module.....	44
Choosing the Probe Configuration .....	44
Probe Type Definitions .....	45
Selecting a Measurement .....	45
Measurement Definitions .....	46
Measurements: Select Menu for Differential Probes .....	47
Measurements: Select Menu for Single-Ended Probes .....	47
Autoset Button in the Measurements Select Menu .....	48
Autoset Summary Menu Options.....	48
Autoset Summary Menu Example .....	49
Configuring a Measurement.....	50
About Configuring a Measurement.....	50
Configure Menu Definitions .....	51
Sources.....	52
About Configuring the Sources.....	52
Configure Source Menu Options for a Differential Probe .....	53
Configure Source Menu for Differential Probes .....	54

Configure Source from a File for Differential Probes.....	54
Configure Source Menu Options for Single-Ended Probes .....	55
Configure Source Menu for Single-Ended Probes .....	56
Configure Source from Ref Waveform for Single-Ended Probes.....	56
Configure Source from File for Single-Ended Probes .....	57
Autosetting Sources for Live (Channel) Waveforms .....	58
Reference Voltage Levels .....	59
About Reference Voltage Levels .....	59
High, Mid, and Low Reference Voltage Levels.....	59
Reference Voltage Levels Diagram .....	59
Rising Versus Falling Thresholds .....	60
Using the Hysteresis Option.....	60
Example of Hysteresis on a Noisy Waveform .....	60
Cursor Gating and Reference Voltage Levels Autose.....	61
Configuring Reference Voltage Level Autose.....	61
Configuring Reference Voltage Autose Percentages .....	62
Steps to Set the Reference Voltage Levels.....	63
Reference Level Autose Setup Menu Options .....	64
Ref Level Autose Setup Menu .....	64
Manually Adjusting the Reference Voltage Levels.....	64
Configure Ref Levels Menu Options .....	65
Configure Ref Levels Menu.....	66
Gating Measurements .....	66
About Gated Measurements .....	66
Configure Smart Gating Menu Options .....	67
Configure Smart Gating Menu with Gating Off .....	67
Configure Smart Gating Menu with Cursors Gating.....	68
Configure Smart Gating Menu Options for Smart Gating .....	69
Using Smart Gating.....	70
Configure Smart Gating Menu with Clock Recovery Window .....	71
Configure Smart Gating Menu with Analysis Window .....	71
Smart Gating Diagram .....	72
Clock Recovery Measurements .....	72
Clock Recovery Methods.....	72
About Constant (Straight-Line) Clock Recovery .....	73

---

About PLL-based Clock Recovery.....	74
PLL-based Clock Recovery Setup .....	74
Clock Recovery Menu Options .....	75
Configure Clock Recovery Menu.....	76
Jitter Measurements .....	76
Jitter Measurement Methods .....	76
Rj/Dj Analysis of Repeating Patterns Using a Spectral Approach.....	77
RjDj Analysis of Arbitrary Pattern.....	77
Configure Jitter Menu Options.....	78
Configure Jitter menu for Repeating patterns .....	79
Configure Jitter menu for Arbitrary patterns.....	79
Bathtub Curve: BER versus Decision Time.....	80
Population for Measurements .....	80
Setting the Population for the Measurements.....	80
Configure Population Menu Options .....	81
Configure Population Menu .....	81
General Config.....	82
Measurement Limits .....	83
About Using Measurements Limits File .....	83
Creating a Measurements Limits File .....	83
Editing a Measurements Limits File .....	84
Measurements Limits Menu Options .....	84
Measurements: Limits Menu.....	85
Measurements Limits Editor Toolbar Functions.....	85
Measurements Limits Editor Menu Options .....	85
Measurements: Limits Editor Menu.....	86
Measurements Limits File Summary .....	87
User Masks.....	88
About Using Standard Masks.....	88
Using the User Mask File Editor.....	89
Import of User Mask .....	91
Manually Editing a Mask File.....	92
User Mask File Opened in a Text Editor.....	93
Creating a New User Mask File .....	94
Mask File Edited Using a Text Editor Example.....	94

Recalling a User Mask in the Plots Configure Menu .....	95
Taking Measurements .....	96
About Taking Measurements .....	96
Localizing Measurements .....	97
About Sequencing .....	97
Acquiring Data .....	98
Control Panel Functions .....	99
Sequence Mode Option Definitions .....	99
Single shot, Scan mode off.....	100
Single shot, Scan mode on .....	101
Free run, Scan mode off .....	101
Free run, Scan mode on .....	101
Control Panel.....	102
About the Results .....	102
Statistical Results .....	103
About Viewing Statistics.....	103
Viewing Statistics.....	103
Results Summary Menu Options.....	104
Results: Summary Menu .....	104
Results Details Menu Options.....	105
Results: Details Menu .....	105
Saving Statistics to a .CSV File.....	106
Plotting the Results .....	107
About Plotting .....	107
Plot Type Definitions .....	108
Measurements and Available Plots .....	108
Plot Window Layouts.....	109
Eye Diagram Plot Usage .....	109
RT-Eye (Real Time) Rendering .....	110
ET-Eye (Equivalent Time) Rendering .....	111
Usage of Waveform with Bit Error Locator.....	112
Histogram Plot Usage.....	113
Spectrum Plot Usage .....	113
Bathtub Plot Usage.....	114
Selecting and Configuring Plots .....	114



---

Selecting Plots for Configuration .....	114
Plots Select Menu Options .....	115
Plots: Select Menu.....	115
Configuring Plots .....	116
Plots Configure Menu Options for an Eye Diagram .....	117
Plots Configure Menu for an Eye Diagram.....	117
Plots Configure Menu Options for a Histogram .....	118
Plots Configure Menu for a Histogram .....	118
Plots Configure Menu Options for a Spectrum .....	119
Plots Configure Menu for a Spectrum.....	119
Plots Configure Menu Option for a Bathtub .....	120
Plots Configure Menu for a Bathtub .....	120
Viewing Plots.....	121
About Viewing Plots .....	121
Using a Separate Monitor to View Plots .....	122
Toolbar Functions in Plot Windows.....	122
Plot Summary Window Example .....	123
Plot Details Window Example .....	124
Plot Summary and Details Window Example .....	125
Viewing a Plot in the Whole Display or in Half the Display .....	126
Returning to the Plot Summary Window .....	126
Using Zoom and Cursors in a Plot .....	127
Removing Plots .....	128
Using Zoom in a Plot .....	128
About Using Zoom in a Plot .....	128
Plot Zoom Definitions .....	128
Changing the Scale of Data in a Plot (Zoom) .....	129
Using Cursors in a Plot .....	130
About Using Cursors in a Plot.....	130
Plot Cursors Definitions .....	130
Using Cursors in a Plot.....	130
Using Grid Points in a Plot.....	131
Horizontal and Vertical Cursors in a Plot Example .....	131
Saving Plots to Files.....	132
About Saving Plot Files.....	132

Save Plot Files Definitions .....	132
Saving Plot Files.....	132
Printing Plots.....	133
About Printing Plots .....	133
Plot Print Preview Window .....	134
Plot Page Setup Window .....	135
Logging Worst Case Waveforms .....	135
Saving Worst Case Waveforms from a Live Source.....	135
Log Worst Case Configure Options .....	136
Log: Worst Case Configure Menu .....	137
File Names of Worst Case Waveforms .....	137
Log: Worst Case File Names Menu .....	137
Generating a Report .....	138
About Generating a Report .....	138
Report Generator File Directories .....	138
Directory Structure for the Report Generator Utility .....	139
Starting the Report Generator and Accessing the Online Help .....	140
Setting Up a Test Template and Layout for a Report.....	141
Generating and Printing a Report.....	141
Creating a PDF File of the Compliance Report.....	142
Test Template Menu.....	143
Report Layout Menu .....	144
Report Generate Menu Options.....	144
Report Generate Menu .....	145
Report Generator Fields .....	145
Application Fields General Information List .....	146
Application Fields Configuration List and Ref Levels Example .....	147
Application Fields Results List and Specific Measurements Example .....	148
Oscilloscope Fields and Native Fields Lists.....	149
<b>Tutorial .....</b>	<b>151</b>
Introduction to the Tutorial .....	151
Setting Up the Oscilloscope .....	151
Starting the Application .....	151
Waveform Files.....	151

Recalling a Waveform File .....	152
Oscilloscope Reference Memory Setup Menu.....	153
Taking an Eye Width Measurement.....	154
Setting Up an Eye Width Measurement .....	154
Ref1 Selected as the Source .....	155
Using Autoset for Reference Voltage Levels.....	155
Taking a Measurement and Viewing as an Eye Diagram .....	156
Results Summary and Plots Summary Window Example .....	157
Results Details and Plot Details Window Example .....	158
Ending a Tutorial Lesson .....	158
Stopping the Tutorial.....	159
Returning to the Tutorial .....	159
Quick Method Concept .....	159
Quick Method to Take Measurements .....	160
Taking a TIE Jitter Measurement.....	161
Clearing Results .....	161
Setting Up a TIE Jitter Measurement and Plots .....	162
TIE Jitter Results with Histogram Example.....	163
TIE Jitter Histogram and Spectrum Plot Example .....	164
Examples of Plot Details .....	165
Saving Statistical Results to a .CSV File .....	166
A .CSV File Viewed with Wordpad Example .....	167
A .CSV File Viewed in a Spreadsheet Example .....	167
Generating a Simple Report.....	167
Simple Report Example Page 1 .....	168
Simple Report Example Page 2.....	169
<b>Serial Analysis Laboratory .....</b>	<b>171</b>
About the Serial Analysis Laboratory (Lab).....	171
Recall Default Settings and Run RT-Eye SW.....	172
Reference Waveform File Setup .....	172
Training Board 2 - Live Signal Source .....	174
Use P7380SMA with CH1 as the Differential Source for Analysis .....	175
Use TCA-SMA Adapters on CH1 and CH3 as Single-Ended Sources for Analysis.....	177
Run the Analysis and View the Results .....	180

MJSQ Jitter Analysis ..... 181

Using MyTest..... 184

Defining a Limits Module..... 184

Creating a Compliance Report..... 186

PCI Express Compliance Tests ..... 187

    Results of PCI Express Add in Card Compliance Test ..... 188

Serial Analysis Lab Conclusion..... 191

**Parameters..... 193**

About Application Parameters ..... 193

File Menus Parameters..... 194

File Preferences Menu Parameters..... 194

Control Panel Parameters..... 195

Measurements Select Menu Parameters..... 195

Autoset Summary Menu Parameters..... 196

Measurements Configure Menus ..... 196

Configure Source Menu Parameters for Differential Probes ..... 197

Configure Source Menu Parameters for Single-Ended Probes ..... 197

Configure Ref Levels Menu Parameters ..... 198

Configure Ref Level Autoset Setup Menu Parameters ..... 198

Configure Smart Gating Menu Parameters ..... 199

Configure Smart Gating Menu with Smart Gating Parameters..... 199

Configure Clock Recovery Menu Parameters..... 199

Configure Jitter Menu Parameters ..... 201

Configure Population Menu Parameters ..... 201

Configure General Config Parameters ..... 201

Measurements Limits Menu Parameters..... 202

Results Menus ..... 202

Results Summary Menu Parameters ..... 202

Results Details Menu Parameters ..... 203

Plots Select Menu Parameters..... 203

Eye Diagram Configure Menu Parameters ..... 204

Histogram Plot Configure Menu Parameters ..... 204

Spectrum Plot Configure Menu Parameters..... 205

Bathtub Plot Configure Menu Parameter ..... 205

Log Worst Case Configure Menu Parameters .....	206
Utilities Report Generator Menus Parameters .....	206
Help Menu	206
<b>Algorithms .....</b>	<b>207</b>
About Measurement Algorithms.....	207
Oscilloscope Setup Guidelines.....	207
Test Methodology .....	208
Measurements .....	209
Notation in Algorithms .....	210
About Notation in Algorithms.....	210
Notational Rules.....	210
Summary Definitions of Fundamental Signals and Measurements .....	211
Waveforms .....	211
Edge Time Threshold Voltages.....	212
Crossing Times.....	212
Recovered Clock Times .....	213
Eye Center Voltages.....	213
Timing Measurements .....	214
About Timing Measurements.....	214
Eye Width Measurement .....	214
Rise Time Measurement.....	215
Rise Time Measurement.....	215
Fall Time Measurement .....	216
Rising Edge Measurement .....	217
Falling Edge Measurement.....	218
Unit Interval Measurement.....	219
Bit Rate Measurement.....	220
Differential Skew Measurement.....	220
Amplitude Measurements .....	221
About Amplitude Measurements.....	221
Eye Height Measurement .....	221
Differential Amplitude Measurement .....	223
Differential Peak Voltage Measurement .....	224
Differential Average Measurement .....	224

High Amplitude Measurement .....	224
Low Amplitude Measurement.....	225
CM Voltage Measurement .....	225
AC CM Voltage Measurement.....	226
AC CM RMS Voltage Measurement .....	226
De-Emphasis Measurement.....	227
Jitter Measurements .....	228
About Jitter Measurements.....	228
Jitter @ BER Measurement.....	229
Spectrum Analysis based Rj/Dj Separation on Repeating Pattern .....	230
Rj/Dj Separation based on Dual-Dirac Model.....	233
Jitter Measurements Field Notes .....	234
TIE Jitter Measurement .....	234
TIE Jitter Filtering Measurement .....	235
Statistics 237	
About Statistics .....	237
Maximum Value.....	237
Minimum Value .....	237
Mean Value .....	237
Standard Deviation Value .....	238
Peak-to-Peak Value.....	238
Population Value .....	238
<b>GPIB.....</b>	<b>239</b>
About the GPIB Program.....	239
Guidelines to GPIB Programming .....	240
Program Example.....	241
GPIB Commands .....	242
Introduction to GPIB Command Syntax .....	242
GPIB Reference Materials .....	243
Starting and Setting Up the Application using GPIB.....	243
Variable: Value RT-Eye Command.....	244
Syntax.....	244
Variable: Value RT-Eye Command Arguments and Queries (Part 1) .....	245
Variable:Value RT-Eye Command Arguments and Queries (Part 2) .....	246

---

Measurements Results Queries .....	247
Measurements Results Queries Variable Names (Part 1).....	247
Measurements Results Queries Variable Names (Part 2).....	248
Serial Analysis Measurement Names for the resultFor Variable.....	249
InfiniBand Driver Measurement Names for the resultFor Variable .....	250
InfiniBand Receiver Measurement Names for the resultFor Variable.....	251
InfiniBand Cable Assembly Measurement Names for the resultsFor Variable .....	251
PCI Express Measurement Names for the resultFor Variable for any Test point except Reference clock .....	252
PCI Express Reference Clock Measurement Names for the resultFor Variable.....	253
FBDIMM Transmitter Measurement Names for the resultFor Variable .....	254
FBDIMM Receiver Measurement Names for the resultFor Variable.....	255
FBDIMM Reference Clock Measurement Names for the resultFor Variable .....	256
GPIB Commands Error Codes .....	256
GPIB Commands Warning Codes .....	258

## General Safety Summary

Review the following safety precautions to avoid injury and prevent damage to this product or any products connected to it. To avoid potential hazards, use this product only as specified.

Only qualified personnel should perform service procedures.

While using this product, you may need to access other parts of the system. Read the *General Safety Summary* in other system manuals for warnings and cautions related to operating the system.

To Avoid Fire or Personal Injury:

**Connect and Disconnect Properly:** Do not connect or disconnect probes or test leads while they are connected to a voltage source.

**Observe All Terminal Ratings:** To avoid fire or shock hazard, observe all ratings and markings on the product. Consult the product manual for further ratings information before making connections to the product.

**Do Not Operate With Suspected Failures:** If you suspect there is damage to this product, have it inspected by qualified service personnel.

**Symbols and Terms:** The following terms and symbols may appear in the online help.

 **WARNING:** Warning statements identify conditions or practices that could result in injury or loss of life.

 **CAUTION:** Caution statements identify conditions or practices that could result in damage to this product or other property.

**Terms on the Product:** The following terms may appear on the product:

DANGER indicates an injury hazard immediately accessible as you read the marking.

WARNING indicates an injury hazard not immediately accessible as you read the marking.

CAUTION indicates a hazard to property including the product.

**Symbols on the Product:** The following symbol may appear in the product:



CAUTION Refer to Help



# Welcome to the RT-Eye<sup>®</sup> Serial Compliance and Analysis Application

The RT-Eye product is an application that enhances the basic capabilities of some high-performance oscilloscopes from Tektronix. The application incorporates MATLAB run-time and uses it to display real-time graphical representations of the measurement results in plot windows.

The Real-Time Eye (RT-Eye) application provides general compliance measurements and analysis capabilities for emerging serial data standards, and includes the following features:

- Selects and configures multiple measurements on one differential or two single-ended probe inputs
- Performs Timing, Amplitude, and Jitter measurements per industry standard methods
- Displays an RT-Eye rendering of the serial bit stream, and other plots such as Waveform (with Bit Error Locator), Jitter Histogram, Jitter Spectrum, and Jitter Eye Opening analysis
- Specifies configurable Limits for Pass/Fail analysis on waveforms and measurements when a Limits file is enabled
- Performs "Plug-Fest" level compliance measurements defined by industry working groups using optional Compliance Modules such as Fully Buffered DIMM (FB-DIMM), InfiniBand, PCI Express, SAS, and Serial ATA.
- Exports analysis results to a .csv file for further analysis
- Tracks and saves the worst case waveforms to .wfm files
- Creates, formats, and generates reports
- Automates compliance tests for production



**Tip** To return to the Table of Contents, select Help Topics from the Help menu bar.

## Five-Time Free Trial

A five-time free trial is available for all applications in the "Applications on this CD and Compatible Oscilloscope" table found in the *Optional Applications Software on a Windows-Based Oscilloscope Installation Manual*. You can start and exit an application up to five times to help you evaluate Tektronix software solutions.

**Note:** To evaluate an application, first check that your TDS6000- or TDS/CSA7000-series oscilloscope firmware version is consistent with the version requirements mentioned in the application's readme file. You can check the firmware version number from the oscilloscope Help drop-down list (About ...). You can check the application's firmware compatibility by referring to the System Requirements section in the application's readme.txt file.

If an application becomes available after you receive your oscilloscope, you can download the application as described in the installation manual (Tektronix part number 071-1078-xx) to obtain the free trial.

## Related Documentation

In addition to the online help, the application includes a Reference guide. Refer to the

RT-Eye<sup>™</sup> Serial Compliance and Analysis Quick Start User Manual (071-1769-xx) for the following information:

- The manual provides task-oriented procedures to explain the basic operations that cover the set up of the application.
- Refer to the *Optional Applications Software on a Windows-Based Oscilloscope Installation Manual* for the following information:
  - Software warranty
  - Software license agreement
  - List of all available applications, compatible oscilloscopes, and relevant software and firmware version numbers
  - How to use the five-time free trial
  - Installation procedures
  - How to enable an application
  - How to download files from the Tektronix Web site

The *Optional Applications Software on a Windows-Based Oscilloscope CD-ROM* includes many PDF files in the Documents directory that you can view and print.

Refer to Start> All Programs> Tek Applications for PDF documentation after installation of the application.

## GPIB Information

For information on how to operate the oscilloscope and use the application-specific GPIB commands, refer to the following documents:

- This online help provides a sample RT-Eye program that illustrates how to set up and use remote automation
- The user manual for your oscilloscope provides general information on how to operate the oscilloscope
- The online help for your oscilloscope can provide details on how to use GPIB commands to control the oscilloscope if you install the GPIB Programmer guide (and code examples) from the oscilloscope CD-ROM
- The online help for *Option SST Serial ATA and Serial Attached SCSI Analysis module* provides details on how to use GPIB commands for SAS and SATA

## Relevant Web Sites

You can also find useful information on serial data standards on the following Web sites:

- [www.Infinibandta.org](http://www.Infinibandta.org)
- [www.pcisig.com](http://www.pcisig.com)
- [www.T11.org](http://www.T11.org)
- [www.tektronix.com/search RT-Eye](http://www.tektronix.com/search RT-Eye).

## Application CD Contents

The Optional Applications Software on a Windows-Based Oscilloscope CD-ROM includes files for the following types of documentation:

- Printable file of the *RT-Eye Serial Data Compliance and Analysis online help* formatted to resemble a user manual
- Printable file of the *Option SST online help* formatted to resemble a user manual
- Printable file of the *Report Generator online help* formatted to resemble a user manual
- PDF files of the *Methods of Implementation (MOI)* for serial data standards as they apply to the corresponding compliance modules
- RT-Eye<sup>™</sup> Serial Compliance and Analysis Quick Start User Manual (071-1769-xx)
- Optional Applications Installation manual

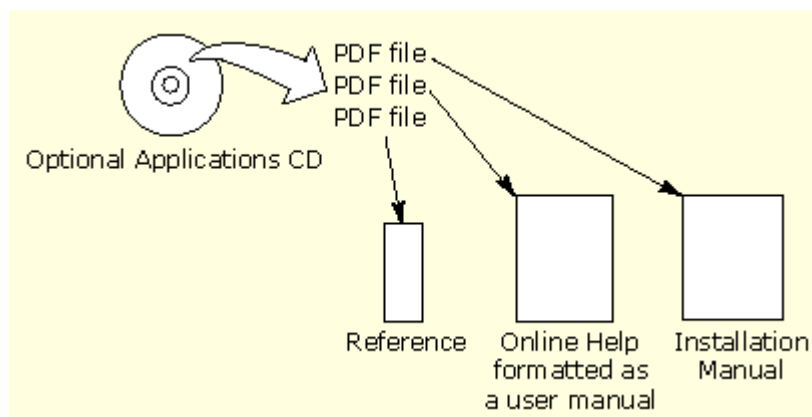

Figure 1-1: Application CD Contents

## Access to PDF Files

You can use any of the following methods to view the various PDF files associated with this application:

- Access a file in the Documents directory on the Applications CD from any PC.
- Access documents on the CD from the Installation Browser.
- Note: The documents are available on Application CD at Documents\TDSRT-Eye. The CD Installation Browser page for TDSRT-Eye is accessed from "Serial Data Compliance and Analysis" and also includes a link to "Browse the Documentation". This link opens a Microsoft Explorer Window to the folder above.
- Select a file from the Start menu in the oscilloscope task bar; you may need to first [minimize the RT-Eye application](#)
- Access a file from the Help drop-down list in the RT-Eye application

---

*Note: If you do not have an Acrobat reader to view a PDF file, you can get a free copy of the reader from the [www.adobe.com/products/acrobat](http://www.adobe.com/products/acrobat) Web page.*

---

## Conventions

Online help topics use the following conventions:

- The terms "RT-Eye application" and "application" refer to the RT-Eye Serial Compliance and Analysis Application.
- The term "oscilloscope" refers to any product on which this application runs.
- The term "select" is a generic term that applies to the two mechanical methods of choosing an option: with a mouse or with the Touch Screen.
- The term "Compliance Module" refers to optional "plug-in applications" from Tektronix used for compliance testing to specific serial data standards.
- The term "Limits Module" refers to a formatted text file used to specify user limits on mask geometry and measurement boundary conditions for Pass/Fail testing.
- The term "channel" is context dependent. It can refer to the transmit channel of the device under test or to an oscilloscope channel.
- The term "DUT" is an abbreviation for Device Under Test.
- There may be minor differences in the display of user interface screen graphics on other types of oscilloscopes such as TDS6000 or TDS7000.
- When steps require a sequence of selections using the application interface, the ">" delimiter marks each transition between a menu and an option. For example, one of the steps to recall a setup file would appear as File> Recall.

## Types of Online Help Information

The online help contains the following types of information:

- A Getting Started group of topics briefly describes the application, contains connection procedures, and includes an optional deskew procedure.
- An Operating Basics group of topics covers basic operating principles of the application. The sequence of topics reflects the steps you perform to operate the application and includes definitions for all menus and options.
- A Tutorial group of topics teaches you how to set up the application to acquire a waveform, take a measurement, view the results, view a plot, and save data to a file.
- A Serial Analysis Laboratory group of topics demonstrates how to use serial analysis measurements to identify a problem with a serial data waveform through the process of elimination. This should give you ideas on how to solve your own measurement problems.
- A Reference group of topics includes the parameters (range of values) for all options and the default values.
- A Measurement Algorithms group of topics includes information on measurement guidelines and on how the application calculates each measurement.
- A GPIB Command Syntax group of topics contains a list of arguments and values that you can use with the remote commands and their associated parameters. The application includes a simple remote interface program to show you how to operate the application using GPIB commands.

The application Help drop-down list includes a PDF Help menu item you can use to access a PDF file of the help topics. The file is printable and is formatted to resemble a user manual.

The Report Generator utility also has an independent online help system that you can launch from the Report Generator window.

## Using Online Help

Online help has many advantages over a printed manual because of advanced search capabilities. You can select Help> Topics on the right side of the application menu bar to display the Help file.

The main (opening) Help screen shows a series of book icons and three tabs along the top menu, each of which offers a unique mode of assistance:

- **Table of Contents (TOC) tab** - organizes the Help into book-like sections. Select a book icon to open a section; select any of the topics listed under the book.
- **Index tab** - enables you to scroll a list of alphabetical keywords. Select the topic of interest to display the corresponding help page.
- **Find tab** - allows a text-based search. Follow these steps:
  1. Type the word or phrase you want to find in the search box. If the word or phrase is not found, try the Index tab.
  2. Select some matching words in the next box to narrow your search.
  3. Choose a topic in the lower box, and then select the Display button.

---

*Note: The Find tab function does not include words found in graphics. Refer to the Find Tab and Searches topic for more information.*

---

- To print a topic, select the Print button from the help topics menu bar.
- Select Options from the menu bar for other commands, such as to annotate a topic, to keep the help window on top, or to use system colors.
- Select the Back button to return to the previous help window. Sometimes you can jump from one topic to another through a hyperlink. If the Back button is grayed out, or a jump is not available, choose the Help Topics button to return to the originating help folder.
- Browse buttons (Next >> and Previous <<) allow you to move forward and backward through topics in the order of the Table of Contents (TOC).
- A Note: in the topic text indicates important information.

---

*Note: Green-underlined text indicates a Jump (hyperlink) to another topic. Select the green text to jump to the related topic. For example, select the green text to jump to the topic on [Feedback to contact Tektronix](#).*

---



 **Tip** You can tell when the cursor is over an active hyperlink (button, jump, or popup), because the arrow cursor changes to a small pointing hand cursor.

 **Tip** The light bulb icon and word Tip indicate additional information to help you operate the application more efficiently.

## **Online Help for the Report Generator**

The Report Generator utility is a separate program that allows you to create a new test template or report layout, or edit an existing one. The online help for the Report Generator explains how to use the utility.

## **Online Help for Compliance Modules**

Each compliance module has its own help documents: online help or PDF documents called as MOIs (Methods Of Implementation). To view compliance specific help topics, refer to the Help menu in the module of interest.

## Find Tab and Searches

Many online help topics contain only tables. To retain vertical and horizontal lines, the tables are graphical objects. The Find tab in the online help does not recognize words in these tables.

The online help is extensively indexed with the proper names of all menus and options as they appear in the application and in the left column of graphical tables.

---

*Note: If you conduct a Find tab search with no results, try the Index tab instead.*

---

## Feedback

Tektronix values your feedback on our products. To help us serve you better, please send us suggestions, ideas, or other comments you may have about your application or oscilloscope.

You can send us your feedback by e-mail to [techsupport@tektronix.com](mailto:techsupport@tektronix.com), by FAX at (503) 627-5695 (North America), or by telephone (See [Contacting Tektronix](#)). Please be as specific as possible and include the following information:

### General Information

- Oscilloscope model number and hardware options, if any
- Probes used
- Serial data standard
- Signaling rate
- Your name, company, mailing address, phone number, FAX number

---

*Note: Please indicate if you would like to be contacted by Tektronix regarding your suggestion or comments.*

---

### Application-Specific Information

- Software version number
- Description of the problem such that technical support can duplicate the problem
- If possible, save the oscilloscope waveform file as a .wfm file

- If possible, save the oscilloscope and application setup files from the application to obtain both the oscilloscope .set file and the application .ini file. Refer to [Saving a Setup File](#).

Once you have gathered this information, you can contact technical support by phone or through e-mail. If using e-mail, be sure to enter in the subject line "RT-Eye Problem," and attach the .set, .ini, and .wfm files.

 **Tip** To include screen shots, from the oscilloscope menu bar, select File> Export. In the Export dialog box, enter a file name with a .bmp extension and select Save. The file is saved in the C:\TekScope\Images directory. You can then attach the file to your email (depending on the capabilities of your email editor)

# Getting Started

## Product Description

The RT-Eye Serial Compliance and Analysis Application is a software product that enhances basic capabilities of some high-performance oscilloscopes offered by Tektronix. The RT-Eye application is a general analysis tool you can use to test, debug, and verify serial-data based designs. The compliance applications are specific tools you can use with device designs that must comply with serial data standards, such as PCI Express, FB-DIMM, Serial ATA, Serial Attached SCSI, or InfiniBand.

You can use this application to do the following tasks:

- Select and configure many amplitude and timing measurements on a serial data signal
- Conduct RT-Eye rendering and mask testing, Time Interval Error analysis, Rj/Dj (random jitter and deterministic jitter) analysis, and display results as a Bathtub plot
- Locate bit errors (mask violations) on the acquired waveform
- Display the results as eye diagram, histogram, spectrum, or bathtub curve plots
- Perform Pass or Fail limits testing based on waveform masks and based on measurements that use Limits Modules
- Perform "plug-fest" level compliance tests for available compliance modules that test against a specific standard
- Save the statistical results to a file
- Save the worst case waveforms to files
- Generate reports

---

*Note: There are no standard accessories for this product. Refer to [Accessories](#) for a list of recommended probes.*

---

## Analysis and Compliance Modules

You can use the RT-Eye (real-time eye) serial data analysis application and industry specific compliance modules to characterize serial transmission signal

integrity. The applications were developed to help you perform analysis on the following types of designs:

- General serial-data based designs
- Device designs that need to comply with a specific serial-data standard

The RT-Eye application is the foundation for current and for future compliance modules. Each enabled compliance application shows at least two choices in the Modules drop-down list; one will always be for Serial Analysis.

## Compatibility

For information on oscilloscope compatibility, refer to the *Optional Application Software on Microsoft Windows Based Oscilloscopes Installation Manual*, Tektronix part number 071-1078-xx. The manual is also available as a PDF file.

## Requirements and Restrictions

The Sun Java Run-Time Environment (JRE) and the Mathworks MATLAB Run-Time Server are components of the RT-Eye application. When you install the application, the InstallShield Wizard automatically installs the proper software components.

**MATLAB Server:** The MATLAB server is dedicated to the RT-Eye application and cannot be used for other purposes. Do not close the Matlab Server icon  in the oscilloscope task bar because this will disrupt the operation of the RT-Eye application. The application will close the MATLAB sever when you exit the application.

**Oscilloscope:** Maximum sampling rate of 20 GS/s with interpolation is often necessary to ensure accurate results. Be sure to consider the following differences in sampling rates before taking measurements:

- The TDS6604 oscilloscopes sample at 20 GS/s on two channels and at 10 GS/s on four channels.
- The TDS7404 oscilloscopes sample at 20 GS/s on one channel and at 10 GS/s on two channels.
- The TDS6000C oscilloscopes sample at 40 GS/s on two channels and 20 GS/s on four channels.
- The TDS6000B oscilloscopes sample at 20 GS/s on two and four channels.
- The TDS7000B oscilloscopes sample at 20 GS/s on one channel, 10 GS/s on two channels, and 5GS/s on four channels.

When the Record Length of the oscilloscope is set to 4M or less, the application can take all measurements. When the Record Length is set to 4M or 20M, the RT-Eye application can take one TIE measurement.

**Keyboard:** You may need to use a keyboard to enter new names for some file save operations.

**Distiller Software:** To convert an RTF file from the Report Generator utility to a PDF file, you require distiller software, such as Adobe Acrobat 6.0 or freeware such as CutePDF.

## Minimum Required System Configuration

Before operating the RT-Eye application, check the readme.txt file to verify whether the oscilloscope configuration meets the minimum requirements. If the RT-Eye application is installed on the oscilloscope, select Start> Programs> TekApplications> tdsRT-Eye> readme file. If the application is not installed, the readme.txt file is in the same directory as the setup.exe file on the Optional Applications CD.

## Accessories

There are no standard accessories for this product. However, you can refer to the product datasheet available on the Tektronix Web site for information on optional accessories relevant to your application. For example, Tektronix recommends that you use the following probes:

**Table 2-1: Probes**

Probe*	Description
P73XX (Includes P7350, P7380, P7313)	Z-Active™ Differential Probe family.
P73XXSMA	SMA Input Differential Acquisition System.
*Check the <a href="http://www.Tektronix.com">www.Tektronix.com</a> web site for an up-to-date list of probes and information on standard-specific test fixtures.	

## Installation

Refer to the *Optional Applications Software on a Windows-Based Oscilloscope Installation Manual*, Tektronix part number 071-1078-xx, for the following information:

- Available applications, compatible oscilloscopes, and relevant software and firmware version numbers
- Using the free trials
- Applying a new authorized Option Installation key label
- Installing the application
- Enabling an application
- Downloading updates from the Tektronix Web site

The manual is also available as a PDF file.

## Connecting to a Device Under Test (DUT)

You can use any compatible probes to connect your DUT (Device Under Test) with your oscilloscope.

There are four typical probing configurations for serial data links: two for Pseudo Differential Waveforms and two for True Differential Waveforms. The method of setting up your measurement channel(s) is dependent on your application and what you want to measure.

 **Warning:** To avoid electric shock, you must ensure that power is removed from the DUT before attaching probes to it. Do not touch exposed conductors except with the properly rated probe tips. Refer to the probe manual for proper use. Refer to the [General Safety Summary](#) in your oscilloscope manual.

## Probe Information

Table 2-2: Probe Information

		Probing Configurations			Captured Waveforms		Typical System Specifications									
		Probe	Break Serial Link	Channels Used	Differential Mode	Common Mode	TDS6604B		TDS7704B**		TDS6804B		TDS6124C		TDS6154C	
							Band Width	Rise* Time (20-80)	Band Width	Rise* Time (20-80)	Band Width	Rise* Time (20-80)	Band Width	Rise* Time (20-80)	Band Width	Rise* Time (20-80)
SMA Connection	A	2 x TCA-SMA	Y	2	Pseudo	AC	6GHz	53ps	7GHz	43ps	8GHz	35ps	12GHz	24ps	15GHz	19ps
	B	1 x P7380SMA	Y	1	True	No	6GHz	53ps	7GHz	43ps	8GHz	35ps	8GHz	35ps	8GHz	35ps
ECB Pad Connection	C	2 x P7260	Y or N	2	Pseudo	AC/DC	6GHz	53ps	6GHz	56ps	6GHz	56ps	6GHz	56ps	6GHz	56ps
		2 x P7380	Y or N	2	Pseudo	AC/DC	6GHz	53ps	7GHz	43ps	8GHz	35ps	8GHz	35ps	8GHz	35ps
	D	2 x P7313	Y or N	2	Pseudo	AC/DC	6GHz	53ps	7GHz	43ps	8GHz	35ps	12GHz	28ps	12.5GHz	25ps
		1 x P7380	Y or N	1	True	No	6GHz	53ps	7GHz	43ps	8GHz	35ps	8GHz	35ps	8GHz	35ps
		1 x P7313	Y or N	1	True	No	6GHz	53ps	7GHz	43ps	8GHz	35ps	12GHz	28ps	12.5GHz	25ps

\* Typical  
\*\* 10GS/s in Pseudo-differential

 **Tip** When you are deciding what oscilloscope and probe combination to use, the system bandwidth should be greater than 1.5 times the bit rate. This provides adequate bandwidth for most of the measurements because most of the energy in high-speed serial data signals is contained in the 1<sup>st</sup> and 3<sup>rd</sup> harmonic. To ensure accurate Rise time measurements, 2.5 times the bit rate (5<sup>th</sup> harmonic) is required.



## Power Spectrum of a 2.5 Gb/sec Signal Example

*Note: The 1<sup>st</sup> and 3<sup>rd</sup> harmonics are the two highest peaks.*

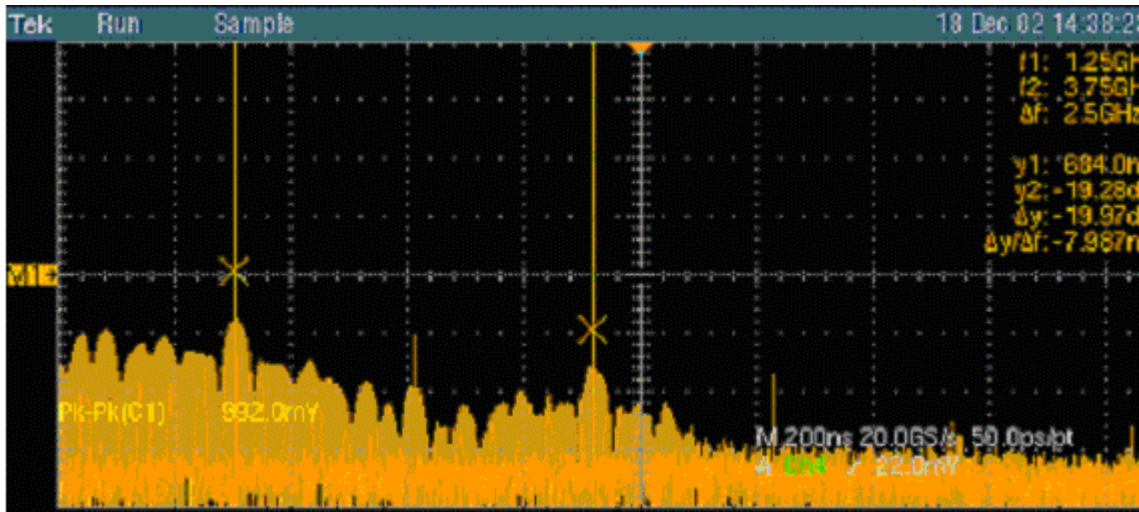

Figure 2-1: Power Spectrum of a 2.5 Gb/sec signal

## Two TCA-to-SMA Adaptors, Diagram A

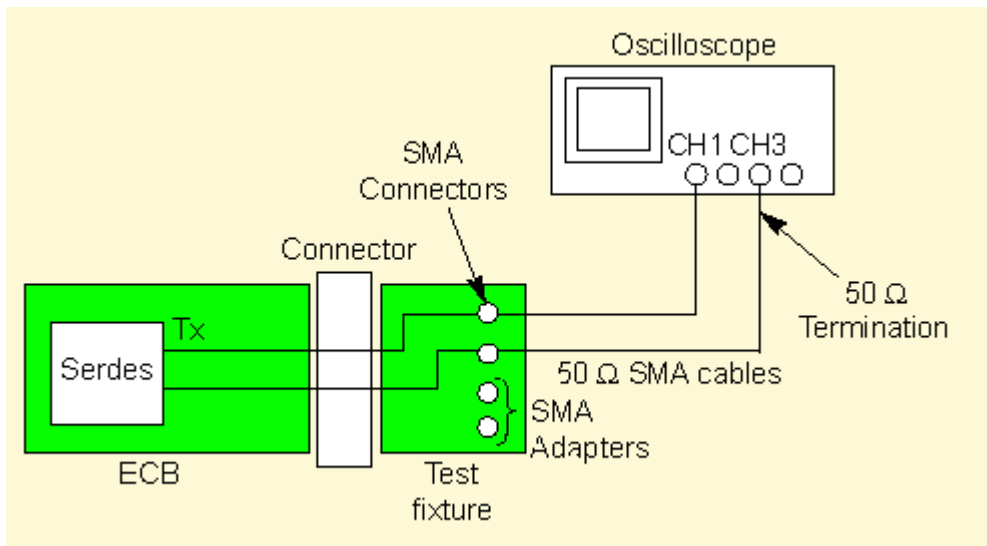

Figure 2-2: Two TCA-to-SMA Adaptors, Diagram A

## One P73XX SMA Differential Probe, Diagram B

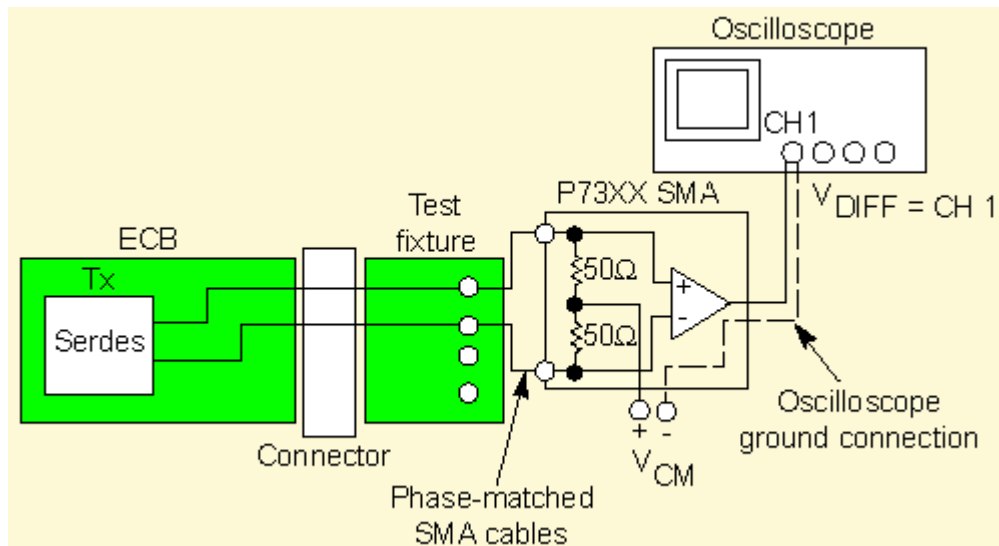

Figure 2-3: One P73XX SMA Differential Probe, Diagram B

## Two P72XX Single-Ended or P73XX Differential Probes, Diagram C

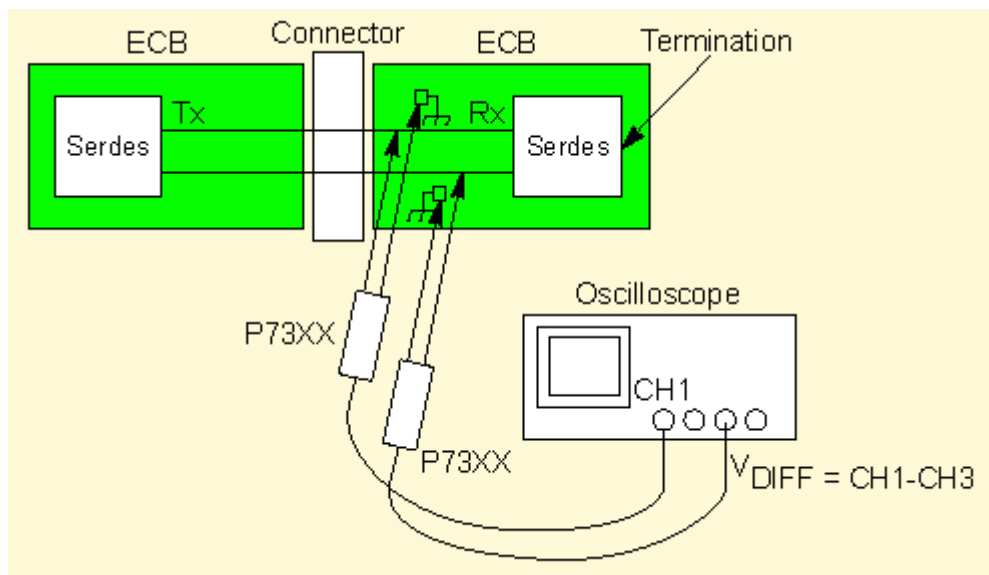

Figure 2-4: Two P72XX Single-Ended or P73XX Differential Probes, Diagram C

## One P73XX Differential Probe, Diagram D

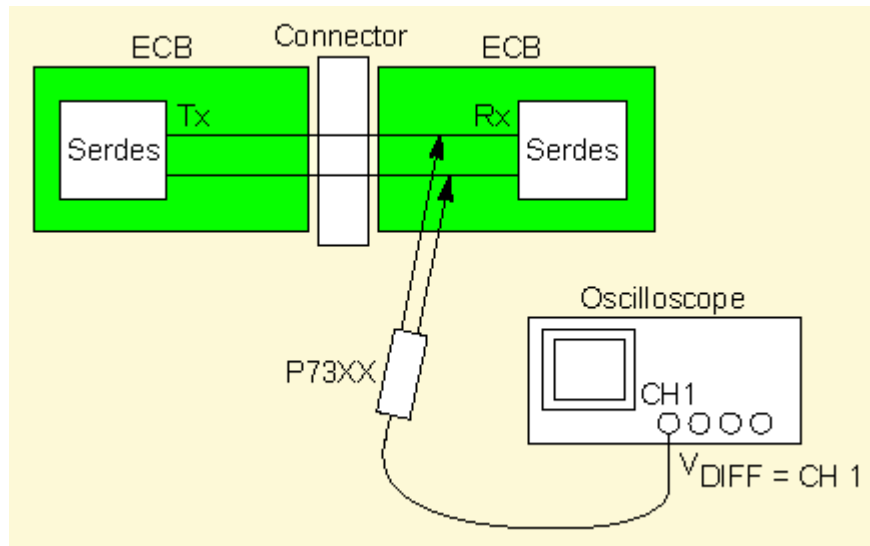

Figure 2-5: One P73XX Differential Probe, Diagram D

## Deskewing Probes and Channels

When using two channels to perform pseudo-differential measurements, it is important to deskew the probes. Be sure to use the proper deskew fixture and procedure as described in the online help of your oscilloscope.

---

**Note:** The RT-Eye application relies on upsampled, deskewed data from the oscilloscope to conduct math operations for differential and common mode waveform measurements. Upsampling prior to deskew is required to ensure accurate measurements.

---

Oscilloscope firmware V 2.4.0 and above implements sub-sampled deskew and is required if you use the RT-Eye application for Single-Ended measurements.

# Operating Basics

## About Basic Operations

The topics in the Operating Basics book cover the following definitions and tasks:

- [Application user interface](#)
- [Basic oscilloscope functions](#)
- [Saving](#) and recalling
- [Setting up the application](#)
- [Using a Limits file](#)
- [Using User Masks](#)
- [Taking measurements](#)
- [Saving the measurement results](#)
- Viewing the measurement results as plots
- Using the plot window [zoom](#) and [cursors](#)
- [Saving plots](#)
- [Logging the worst case waveforms](#)
- Creating and generating a custom compliance report

## Starting the Application

On the oscilloscope menu bar, select File> Run Application> RT-Eye Serial Compliance and Analysis. View [how to start the application](#). For B and C series oscilloscopes, select App> RT-Eye Serial Compliance and Analysis from the menu bar to run the application.

The application starts and displays the Measurements> Select menu.

After the application initializes, the Welcome dialog box, if enabled, will appear. If it is disabled, you can use File> Preferences to configure it to appear the next time the application is launched.

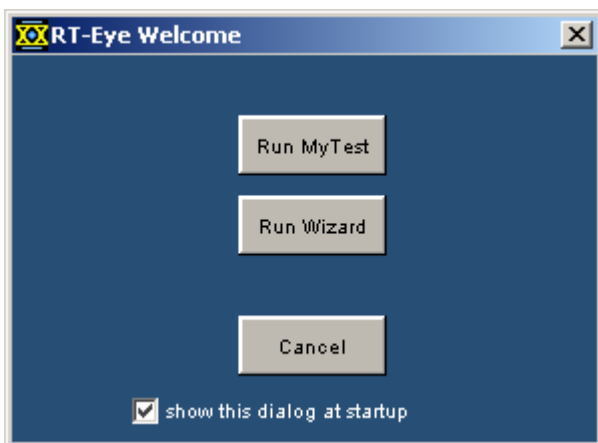

Figure 3-1: RT-Eye Welcome dialog box

You can perform the following functions in this dialog box as shown in the table:

Table 3-1:RT-Eye Welcome dialog box options

Click	To
Run MyTest	Recall the previously saved MyTest setup and automatically start the sequencer. See also: Running MyTest.
Run Wizard	Launch the RT-Eye Wizard. The application takes the measurements and displays the results in the result summary window. See also: About Serial data Wizard.
Cancel	Close the RT-Eye Welcome dialog box and work directly with the application.
Show this dialog at startup	Enable or disable display of the RT-Eye Welcome dialog the next time when you launch the application.

## Oscilloscope Menu Bar and Selected Application

For non-B series oscilloscopes, select File> Run Application> RT-Eye Serial Compliance and Analysis to start the application.

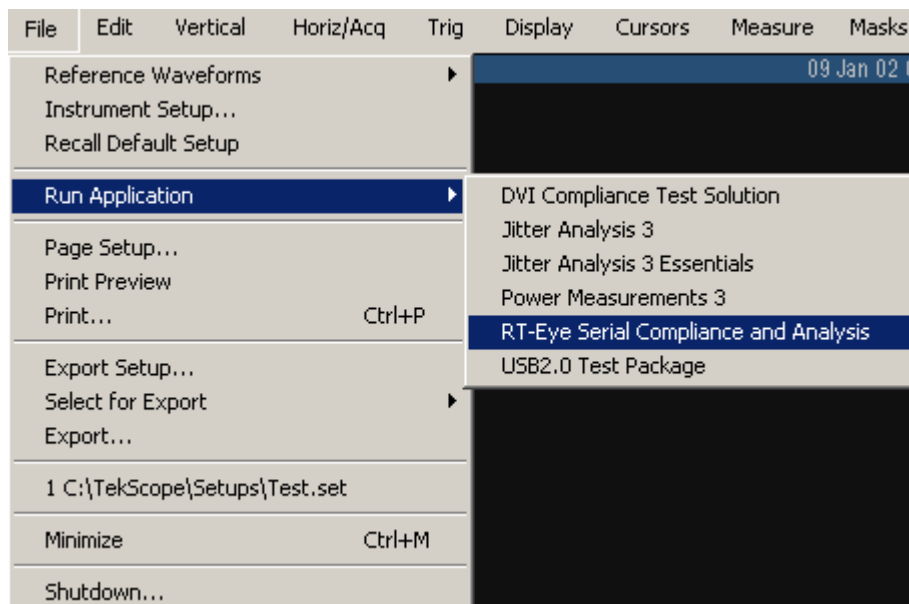

Figure 3-2: Oscilloscope menu bar and selected application

For B/C series oscilloscopes, select App> RT-Eye Serial Compliance and Analysis to start the application.

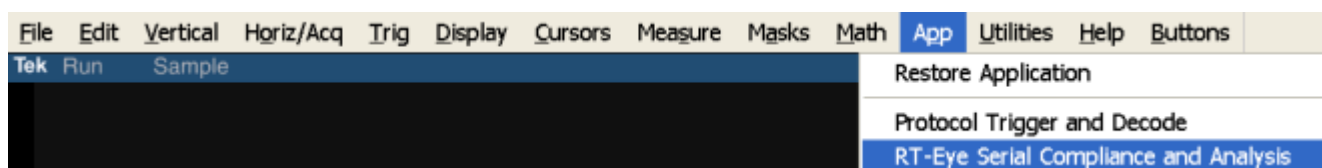

Figure 3-3: B/C series oscilloscope menu bar and selected application

## Application Interface

The RT-Eye application uses a Microsoft Windows based interface. [Display the definitions of the application user interface items](#), or view a menu labeled with the user interface items.

---

*Note: The oscilloscope application shrinks to half size and appears in the top half of the screen when the application is running.*

---

## User Interface Definitions

**Table 3-2:User Interface Definitions**

Item	Description
Area	Visual frame that encloses a set of related options.
Box	Use to define an option; enter a value with the Keypad or turn the Multipurpose knob to select a value.
Browse	Displays a window where you can look through a list of directories and files.
Button	Use to define an option; not a command button.
Check box	Use to select or clear an option.
Command button	Initiates an immediate action, such as the Start command button in the Control panel.
Control panel	Located to the right of the application; contains command buttons that you use often, such as to Start sequencing.
Keypad	On-screen keypad that you can use to enter numeric values.
List box	Use to define an option from a list.
Menu	All options in the application window (except the Control panel) that display when you select a menu bar item.
Menu bar	Located at the top of the application display and contains application menus.
Option	Any named button (other than a command button) or any named box that defines a control or task.
Status bar	Line located at the bottom of the application display that shows the name of the current menu (location) and the next step that you might take (action).
Tab	Short cut to a menu in the menu bar or a category of menu options; most tabs are short cuts.
Virtual keyboard	On-screen keyboard that you can use to enter alphanumeric strings, such as for file names.
Scroll bar	Vertical or horizontal bar at the side or bottom of a display area that you use to move around in that area.

## Menu With Application User Interface Items

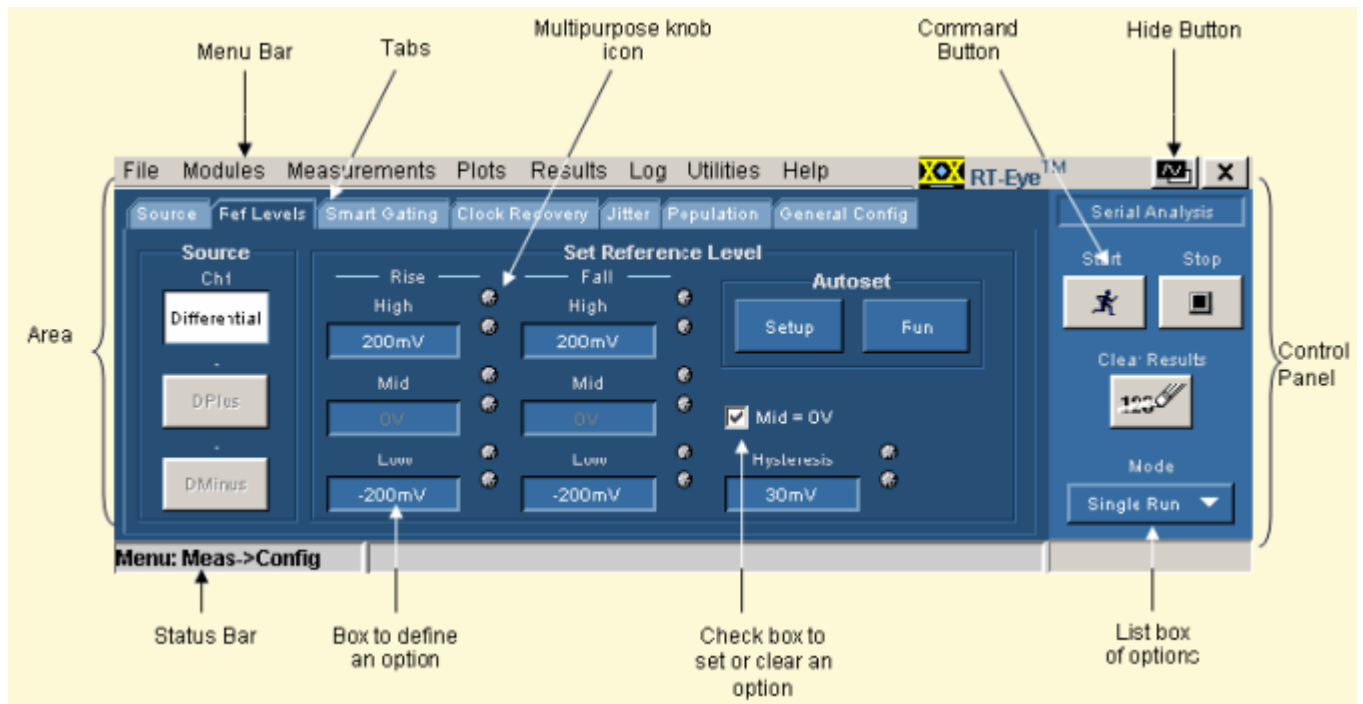

Figure 3-4: Menu with application user interface items



## Application Menu Bar and Drop-Down Lists

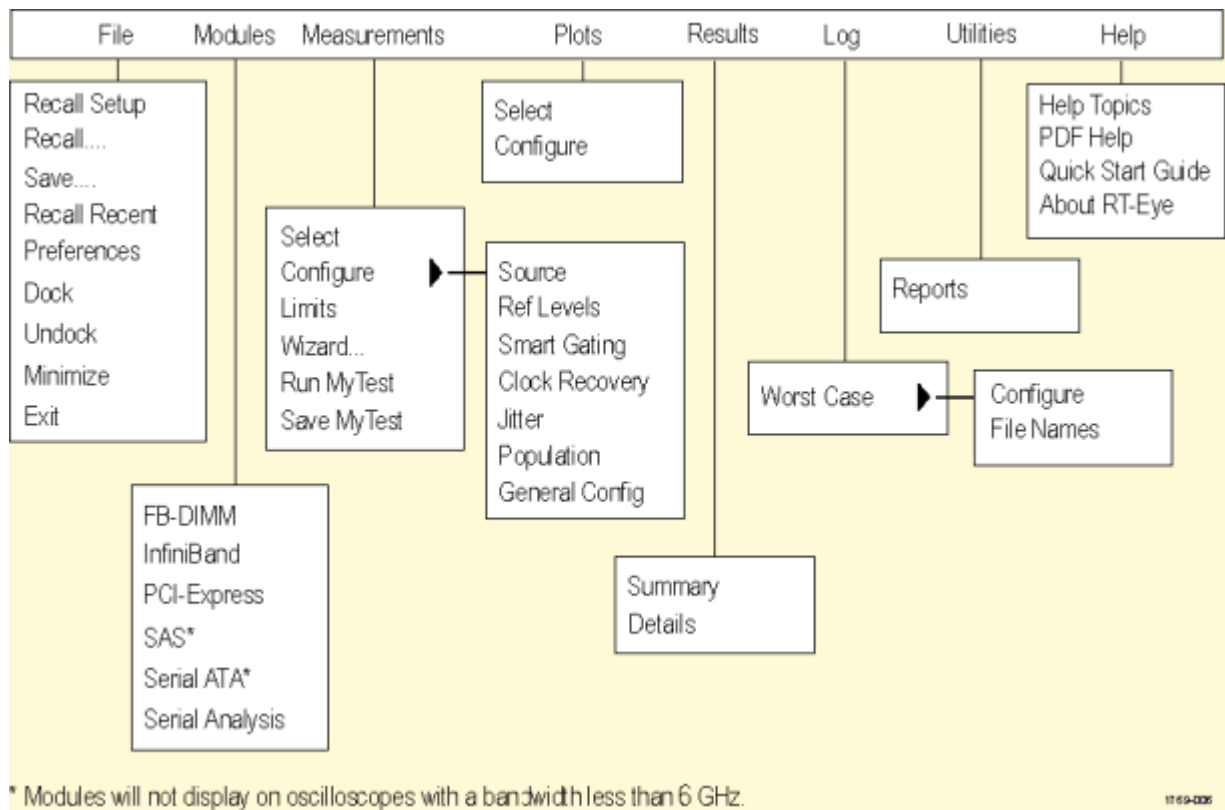

Figure 3-5: Application menu bar and drop-down lists

### Using Basic Oscilloscope Functions

You can use oscilloscope controls and functions while running the application. To do so, select a menu from the oscilloscope Menu bar (or Toolbar) and access menus, or use the front-panel knobs and buttons. You can also use the oscilloscope Help menu to access information about the oscilloscope and how to use it. When you access some oscilloscope controls, the oscilloscope fills the display.

### Returning to the Application

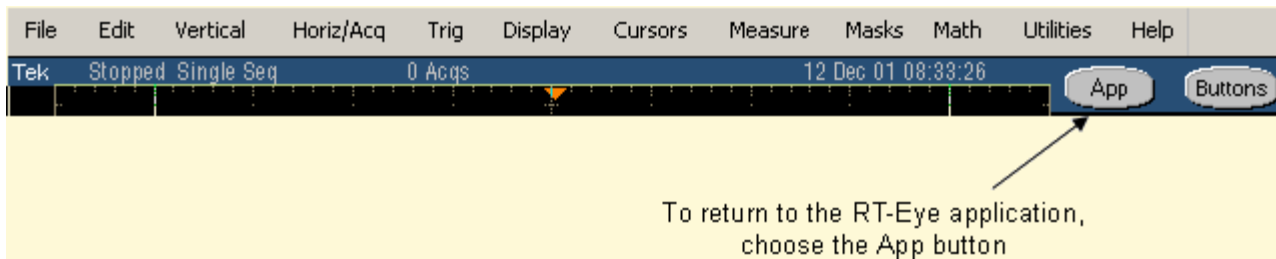



Figure 3-6: Returning to the application

For B and C series oscilloscopes, select App> Restore Application to return to the RT-Eye application.

### Hiding the Application

The Hide function minimizes the application and the oscilloscope fills the display. To hide and return to the application, follow these steps:

1. Select the  command button in the application menu bar.
2. Use the oscilloscope.
3. [Return to the application.](#)

### Minimizing and Maximizing the Application

To minimize the RT-Eye application, select File> Minimize in the application menu bar.

To maximize the application, select  RT-Eye in the task bar.

### Exiting the Application

To exit the RT-Eye application, select File> Exit or the  (Exit) command button in the application menu bar. When you exit the application, you can choose to keep the oscilloscope setup currently in use with the application or to restore the oscilloscope setup that was present before you started the application. If you select the Save MyTest check box, the current setup of both the oscilloscope and the application will be saved for convenient recall next time. Refer to [MyTest](#) for more information.

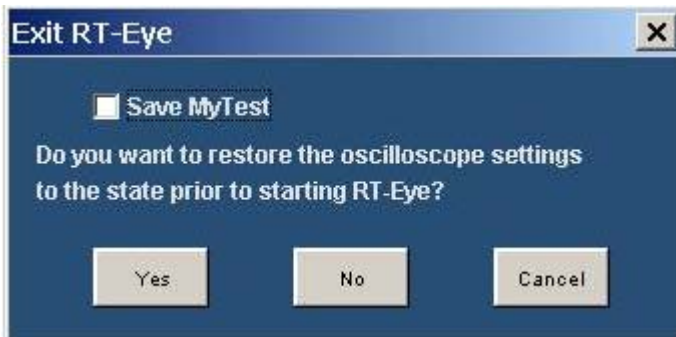

Figure 3-7: Exiting the application

### Docking the Application

To Dock the RT-Eye application, select File> Dock in the application menu bar. This positions the application at the default location.

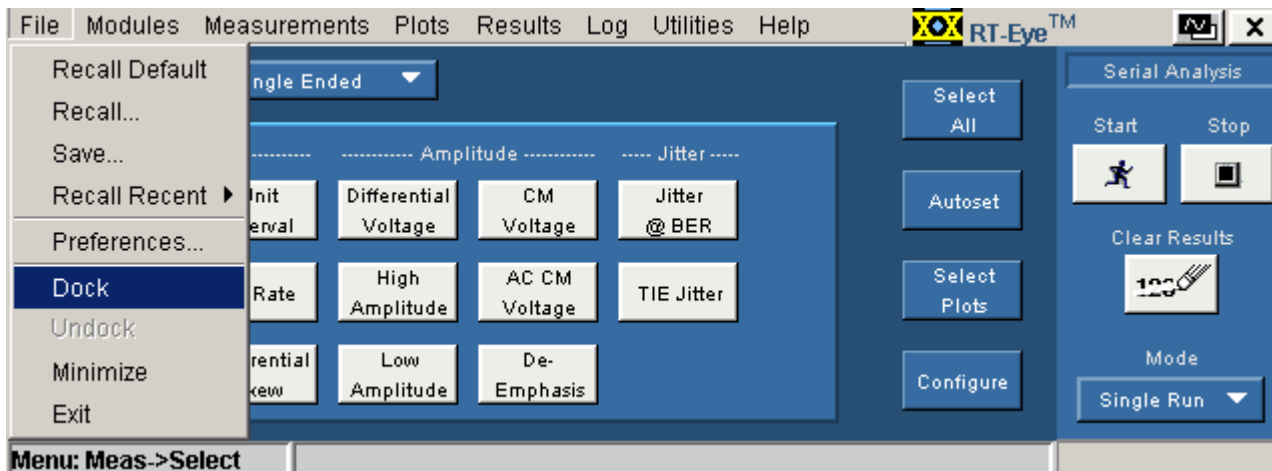

Figure 3-8: Docking the application

### Undocking the Application

To Undock the RT-Eye application, select File> Undock in the application menu bar. After you undock the application, you can click and drag the application tool bar to position the application anywhere on the screen.

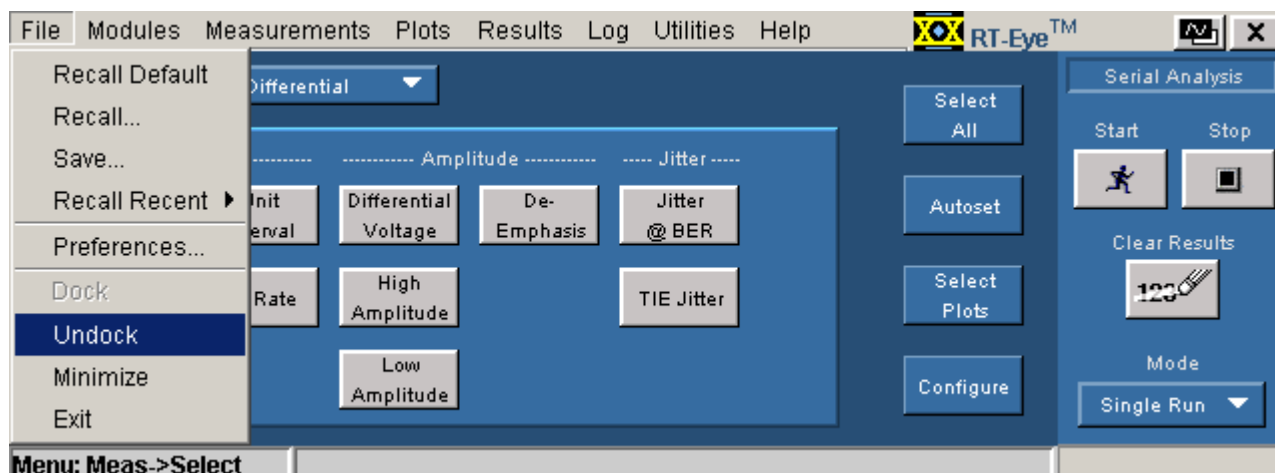

Figure 3-9: Undocking the application

### Application Directories

During installation, the application sets up directories for various functions, such as to save setup files, and uses extensions appended to file names to identify the file types.

Table 3-3: Application directories

Default directory names*	Directory use
\modules\SerialAnalysis	Serial Analysis application home location.
\modules\SerialAnalysis\data	Measurement results files.
\modules\SerialAnalysis\limits	Limits files for Pass or Fail compliance tests.
\modules\SerialAnalysis\masks	Waveform mask files for plots and limits testing.
\modules\SerialAnalysis\setup	Setup files.
\modules\SerialAnalysis\waveforms	Log worst case waveforms and recall waveform files.
\Masks	Mask files for various serial data standards.
\Examples\RemoteCtrl	Sample remote control program.
\Examples\WFMS	Waveforms for learning.
\images	Plot files.
\temp	Temporary files.
\ReportGenerator\modules\Serial Analysis\Reports	Files created by the Report Generator utility.

\* All subdirectories are located in the C:\TekApplications\tdsrt-eye directory.

### Directory Structure for the Serial Analysis Application

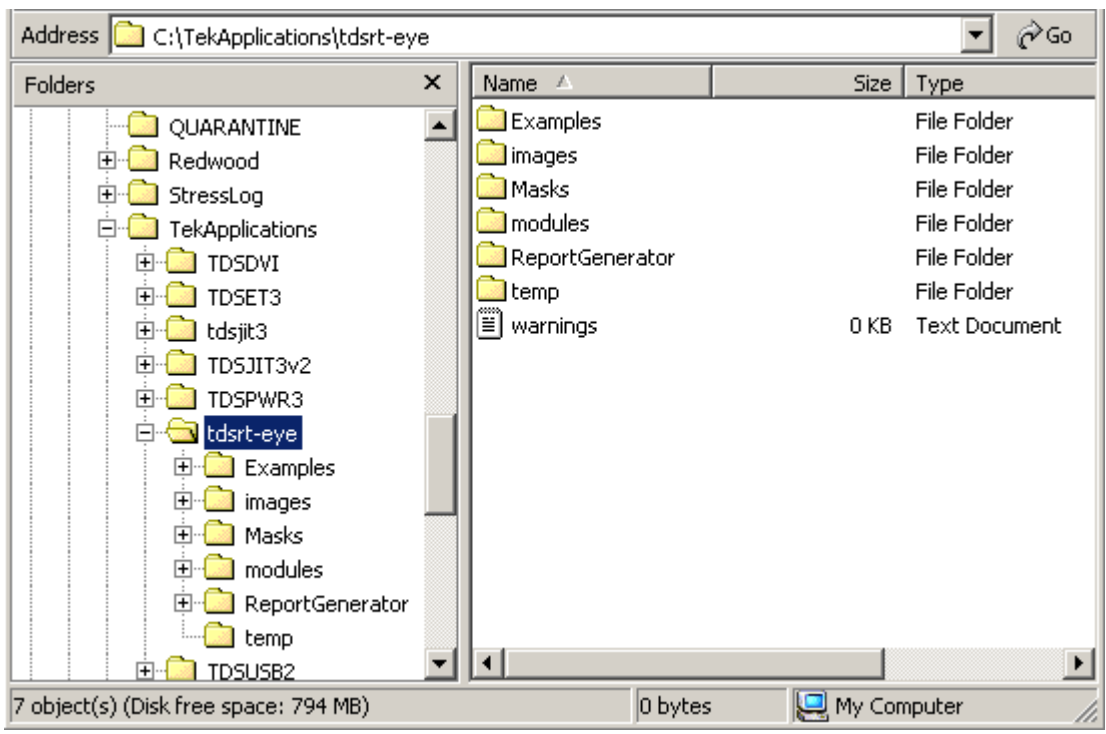

Figure 3-10: Directory structure of serial analysis application

### File Name Extensions

**Table 3-4: File name extensions**

Extension	Description
.bmp	File that uses a "bitmap" format.
.csv	File that uses a "comma separated variable" format.
.dat	File with binary format; stores waveform vectors.
.fig	Plot file with binary data.
.gif	File that uses a "graphics interchange format".
.ini	RT-Eye application setup file.
.jpg	File that uses a "joint photographic experts group" format; also known as JPEG.
.lim	Limits file used with Pass/Fail compliance tests.
.mat	MATLAB waveform vector header saved to the hard disk.
.msk	Waveform mask file used with plots.
.pdf	File that uses a "portable data format".
.png	File that uses a "portable network graphics" format.
.rgt	File that defines the report template.
.rpl	File that defines the report layout.
.rpt	File created by the Report Generator utility.
.rtf	File that uses a "rich text format".
.set	Oscilloscope setup file saved that is recalled with an application .ini file; both files will have the same name.
.wfm	Waveform file; can be recalled into Reference memory.

### How to Enter Alphanumerical Values

---

*Note: Press the FINE button on the oscilloscope to enter or select the smallest values or units.*

---





---

*Note: Be sure to select the CLR button before you enter a value using the keypad.*

---

**Table 3-5:How to enter alphanumeric values**

Method	Description
 Keypad	When you select the keypad icon, the virtual keypad appears (looks similar to a calculator); use to enter a value.
 Multipurpose knob*	When you select a knob icon, a line appears between the upper icon and the option box. This activates the upper multipurpose knob on the front panel of the oscilloscope; turn the knob to select a value.
 Keyboard	When you select the keyboard icon, the virtual keyboard appears (looks similar to a physical keyboard); use it to enter a file name.
Edit box*	Type in a value from the physical keyboard and press the Enter key.
<b>* When selected twice, the Keypad appears.</b>	

### Virtual Keypad

**Note:** Select the  icon, and then use the virtual keypad to enter information, such as reference voltage levels.

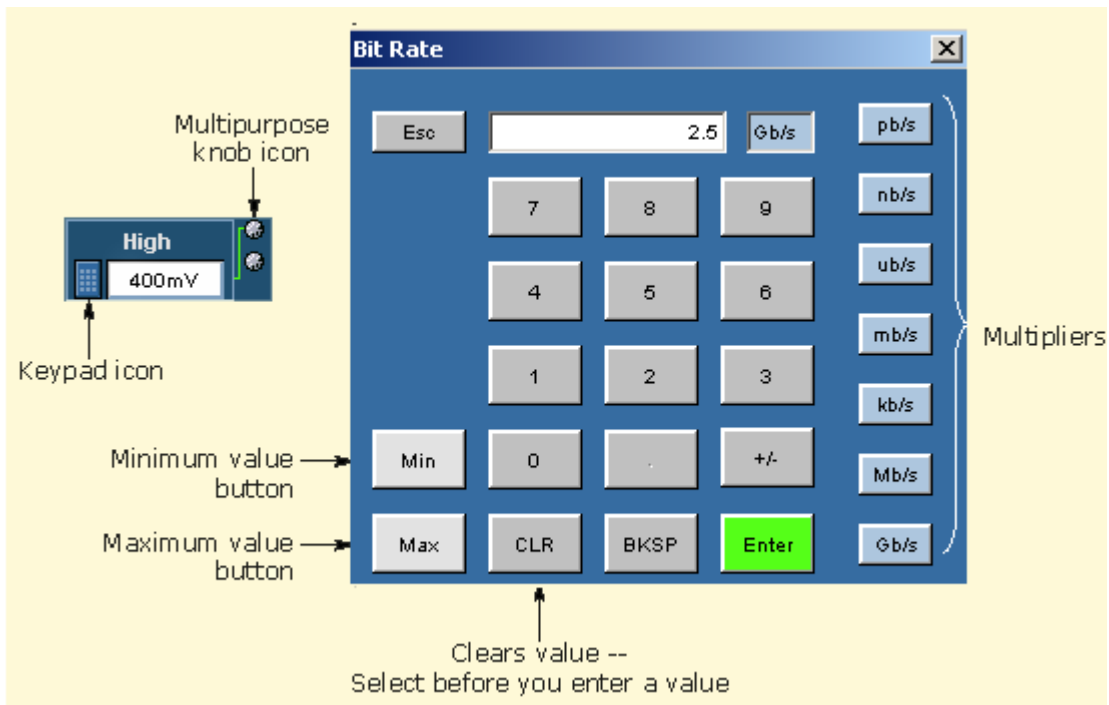



Figure 3-11: Virtual Keypad



### Virtual Keyboard

---

*Note:* Select the  icon, and then use the virtual keyboard to enter information, such as file names.

---

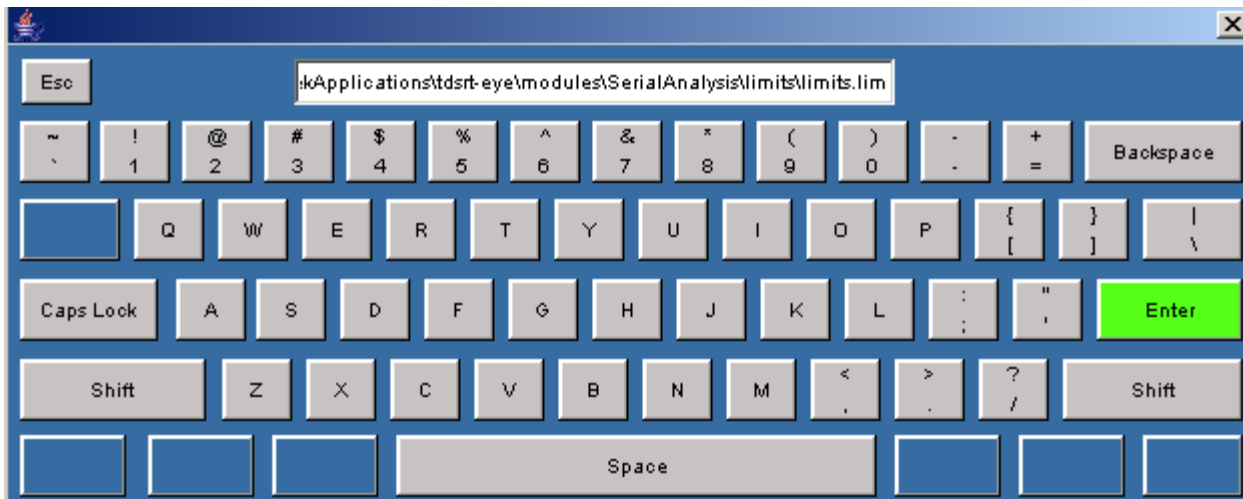

Figure 3-12: Virtual Keyboard

## Using MyTest

### About My Test

The MyTest feature allows you to save a single measurement configuration so that it can be recalled and run at any time with a single click. This is similar to the save/recall feature (which allows as many named configurations as you want), except that MyTest is designed to be easily accessible and runs automatically when selected.

### Saving MyTest

To save the current application and oscilloscope settings without closing the RT-Eye application, select Measurements> Save MyTest.

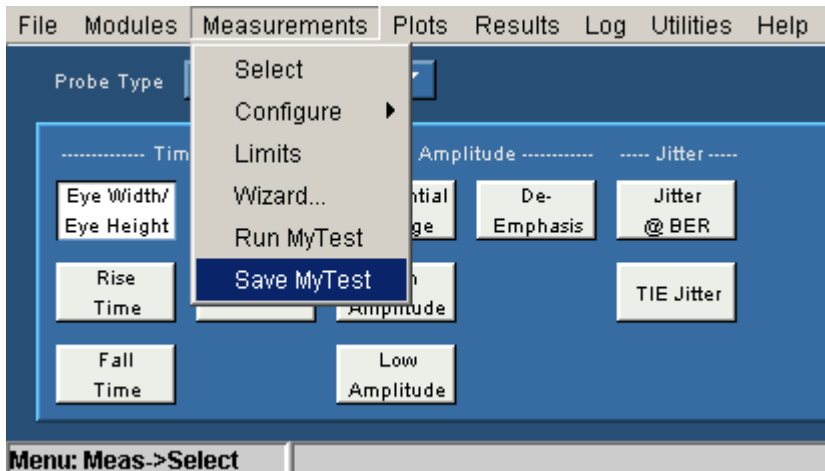

Figure 3-13: Save Mytest

You can also save your MyTest before exiting the RT-Eye application. When you select File> Exit from the RT-Eye application, the application prompts you to save the oscilloscope settings. If you select the Save MyTest check box, the current setup will be saved as the new MyTest.

### Running MyTest

Select Measurements> Run MyTest to run MyTest at any time.

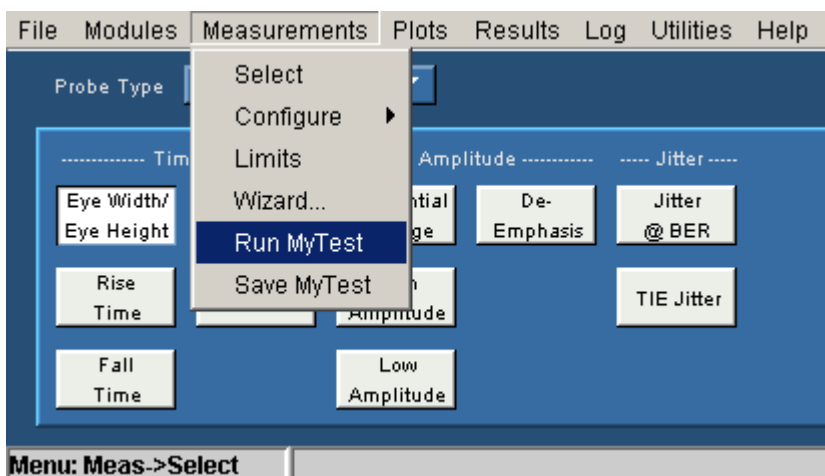

Figure 3-14: Run Mytest

The application takes the measurements from the saved MyTest and displays the results in the Result summary window. You can also run MyTest directly from the RT-Eye Welcome dialog. Refer to Starting the Application.

## Using Serial Data Wizard

### About the Serial Data Wizard

The RT-Eye application Setup Wizard guides you through the process of setting up, running, and displaying the results of a measurement using an intuitive sequential process. The Wizard can be used for accurate measurements for a single acquisition, or as a starting point for advanced configurations, or free-run measurements.

---

*Note: The statistical results for the Setup Wizard and RT-Eye application are identical if the measurements and setups are the same.*

---

Select Measurements> Wizard to open the Setup Wizard anytime. You can also open the Setup Wizard during the launch of the RT-Eye application by clicking Run Wizard in the RT-Eye Welcome dialog. Refer to Starting the Application for more information.

The Setup Wizard takes you through the steps to configure the following parameters:

- Probe type
- Measurement Sources
- Standards
- Measurement Categories
- Autoset Source Levels
- Autoset Source Reference Levels
- Plots

---

*Note: You can exit the Setup Wizard without affecting any settings in the Serial Analysis application by clicking Cancel anytime before clicking the Run button.*

---

### Probe type

In this step, you can select the type of probe. The default probe type is Single-ended. In the single-ended probe configuration, you connect two probes or two SMA cables to the unit under test and the application forms a pseudo-differential signal by subtracting them. See Probe Diagrams [A](#) and [C](#) ". In the differential probe configuration, you connect a single differential probe, as shown in Probe Diagrams [B](#) and [D](#).

Note that the currently selected step is always highlighted in the left column of the Wizard.

Click Next to accept your probe type and proceed to Measurement Sources.

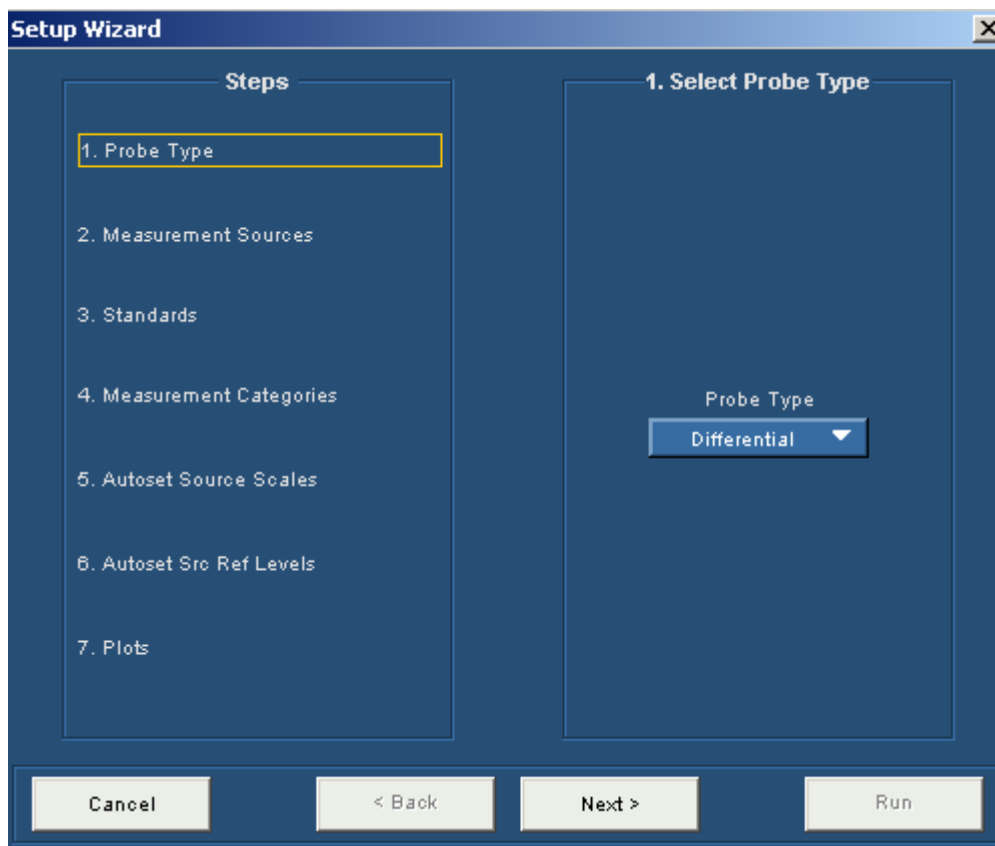

Figure 3-15: Probe Type

### Measurement Sources

In step 2, you can select the Measurement sources. The available sources depend on which probe type you have selected in the previous step. The selection in the previous step is displayed in yellow text as shown in the following figure.

Click Next to proceed to Standards. Click Back if you want to change the probe type.

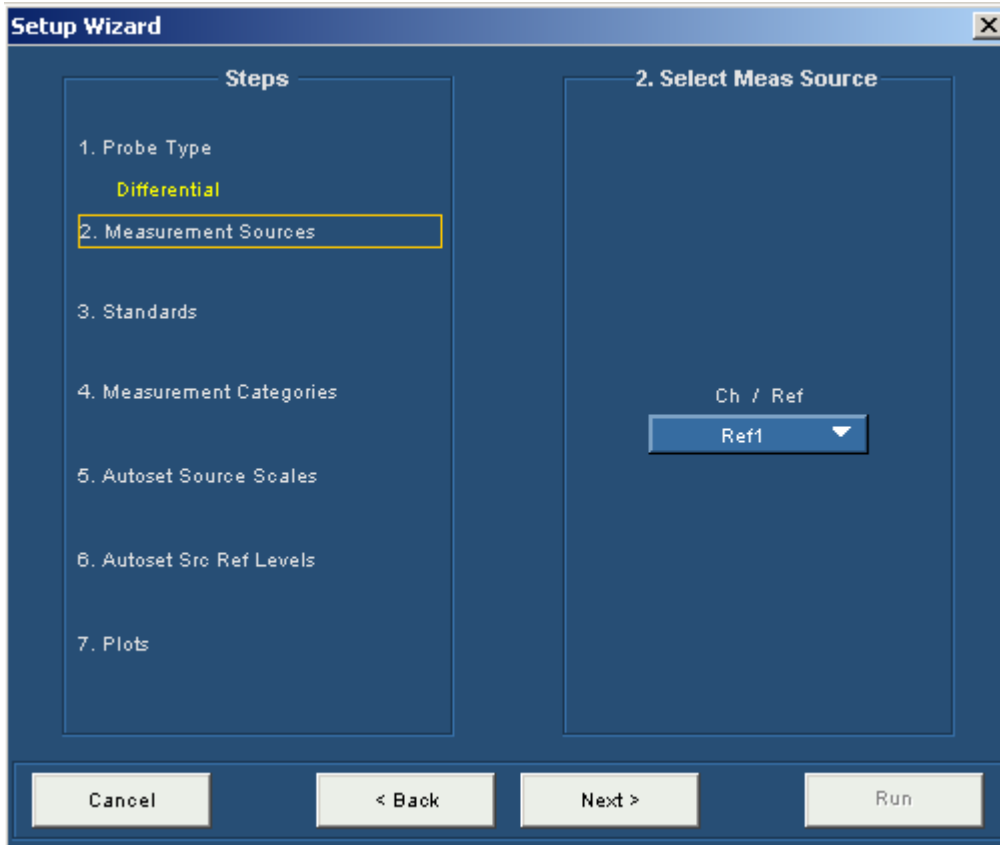

Figure 3-16: Measurement sources

### Standards Selection

In step 3, you select the Serial Analysis standards that guide clock recovery by establishing the bit rate. The default standard is PCI-E : 2.5 G.

Click Next to proceed to Measurement Categories.

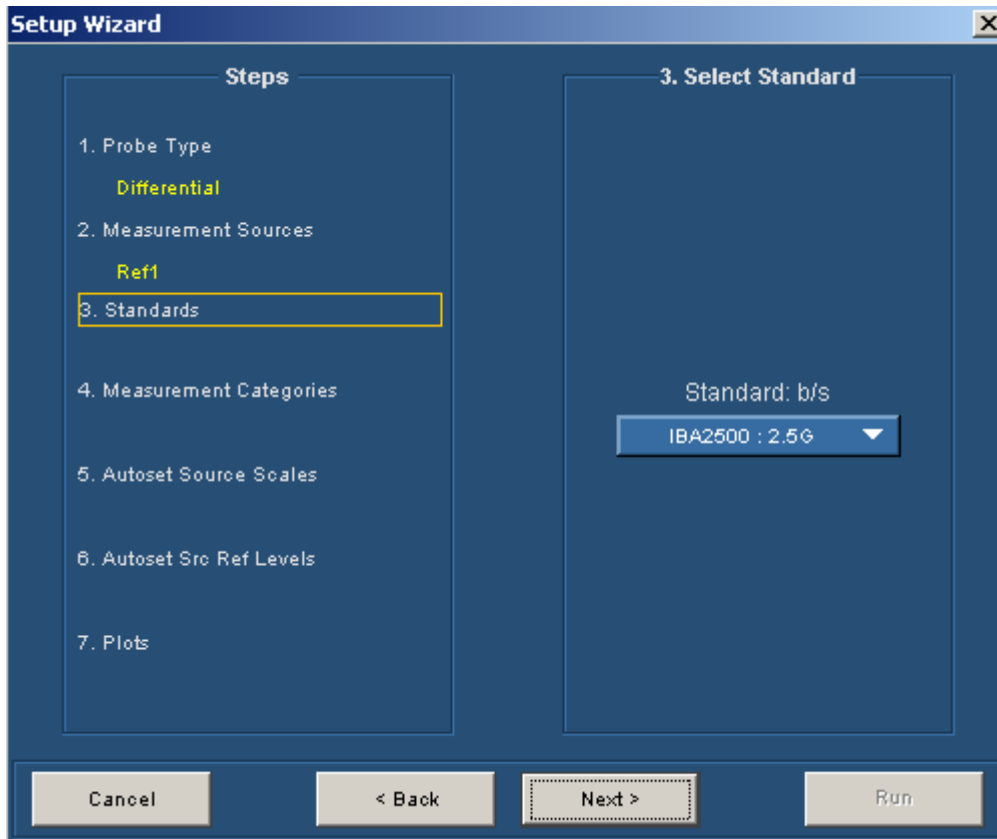

Figure 3-17: Standards

### Measurement Categories

In step 4, you select the Measurement that will be performed. Various measurement parameters are grouped under these categories. You need to select at least one measurement to advance to the next step. For more details, refer to [Selecting a Measurement](#).

If you select Jitter@BER measurement, you can set the pattern length by selecting Repeating pattern and then entering the pattern length in the Pat Len text box. The default value is 2500 unit intervals. If you have a non-repeating waveform pattern or if the pattern length is unknown, select Arbitrary.

---

*Note: The measurements that you select also determine which plot types will be available in step 7.*

---

Click Next to proceed to step 5, where you select whether to Autoselect the source scales.

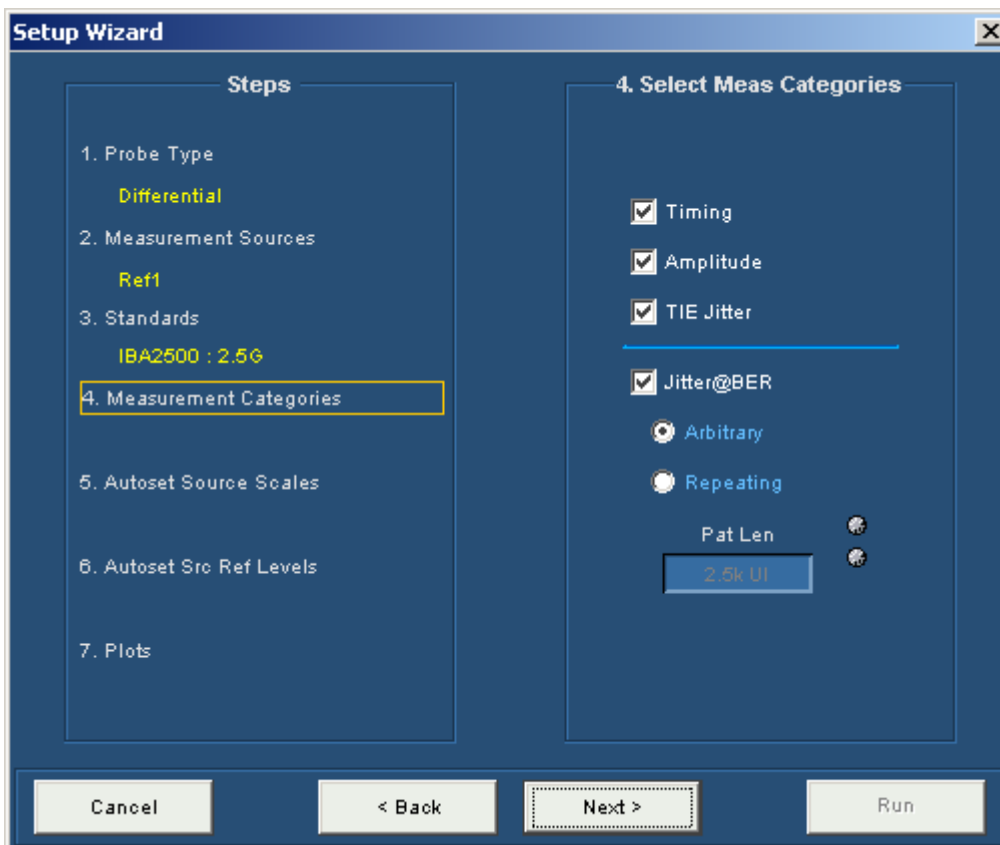

Figure 3-18: Measurement categories

### Autoset Source Levels

In step 5, you can choose to automatically adjust the horizontal and vertical scaling before the measurement. This is similar to the Autoset feature of the oscilloscope. The default of Yes is recommended unless you select a reference source. If you select No, you will retain the current oscilloscope settings.

Click Next to proceed to Autoset the source reference levels.

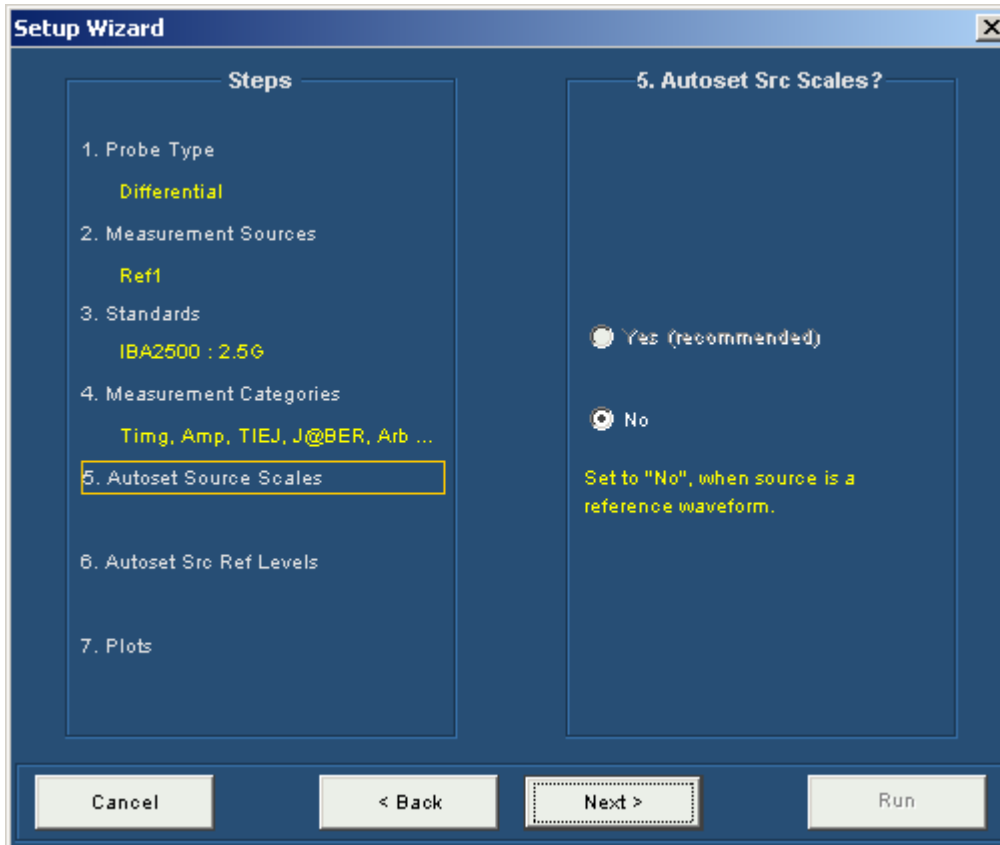

Figure 3-19: Autoset source levels



### Autoset Source Reference Levels

In step 6, you can choose to automatically adjust the reference levels before the measurement. The reference levels are the voltage thresholds that are compared to the waveform to determine when timing events occur. The default of Yes is recommended.

Click Next to proceed to Plot selection.

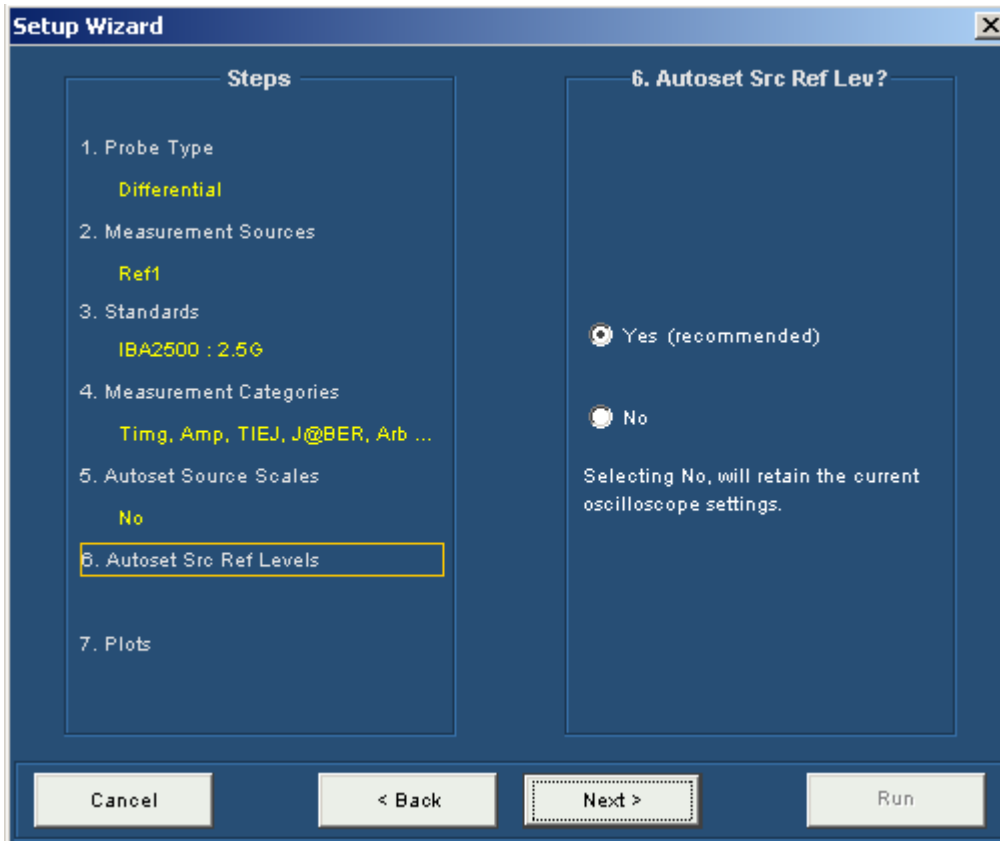
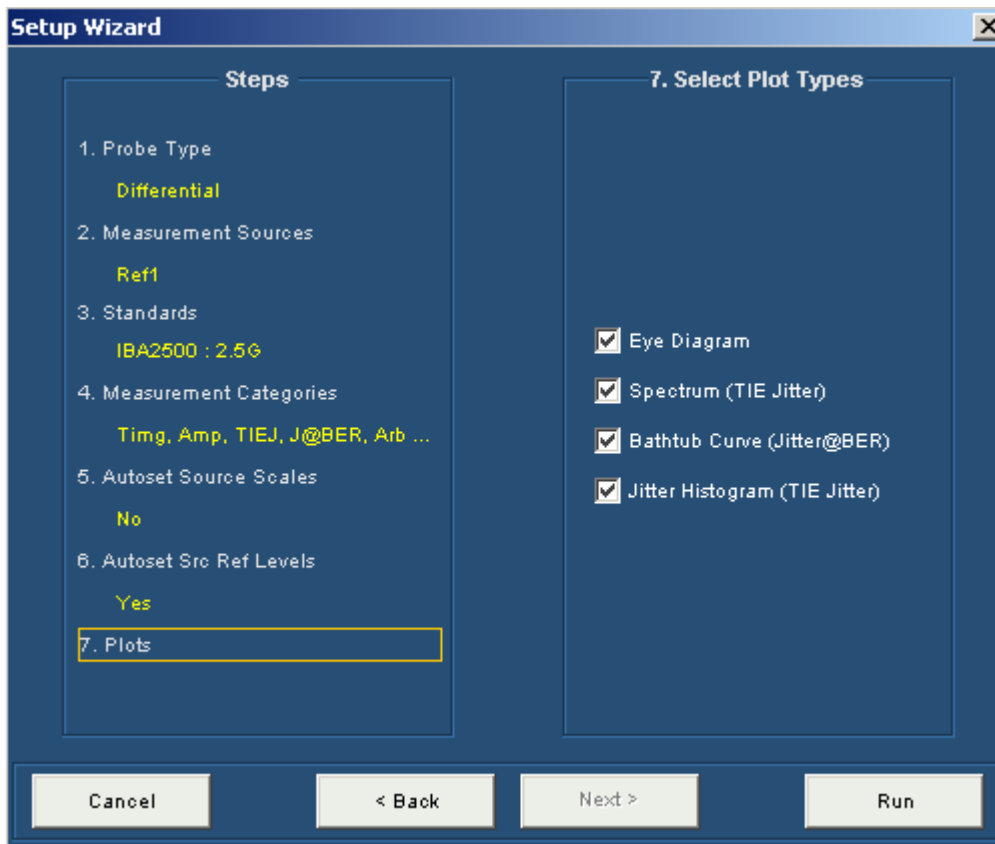

Figure 3-20: Autoset source reference levels

### Plots

In step 7, you can select the plot types that you want to display. Some plot types may not be available depending on the measurements that you chose in the Measurement Categories step. The default is to select all plot types. The types of plots available are:

- Eye Diagram—Default and is available for all measurements
- Spectrum—if TIE Jitter is selected
- Bathtub Curve—if Jitter@BER is selected
- Jitter Histogram—if TIE Jitter is selected



**Figure 3-21: Plots**

Click Run to start a single acquisition sequence using the selected settings. The Plot waveform diagrams are displayed in the chosen order, as shown in the following figure.

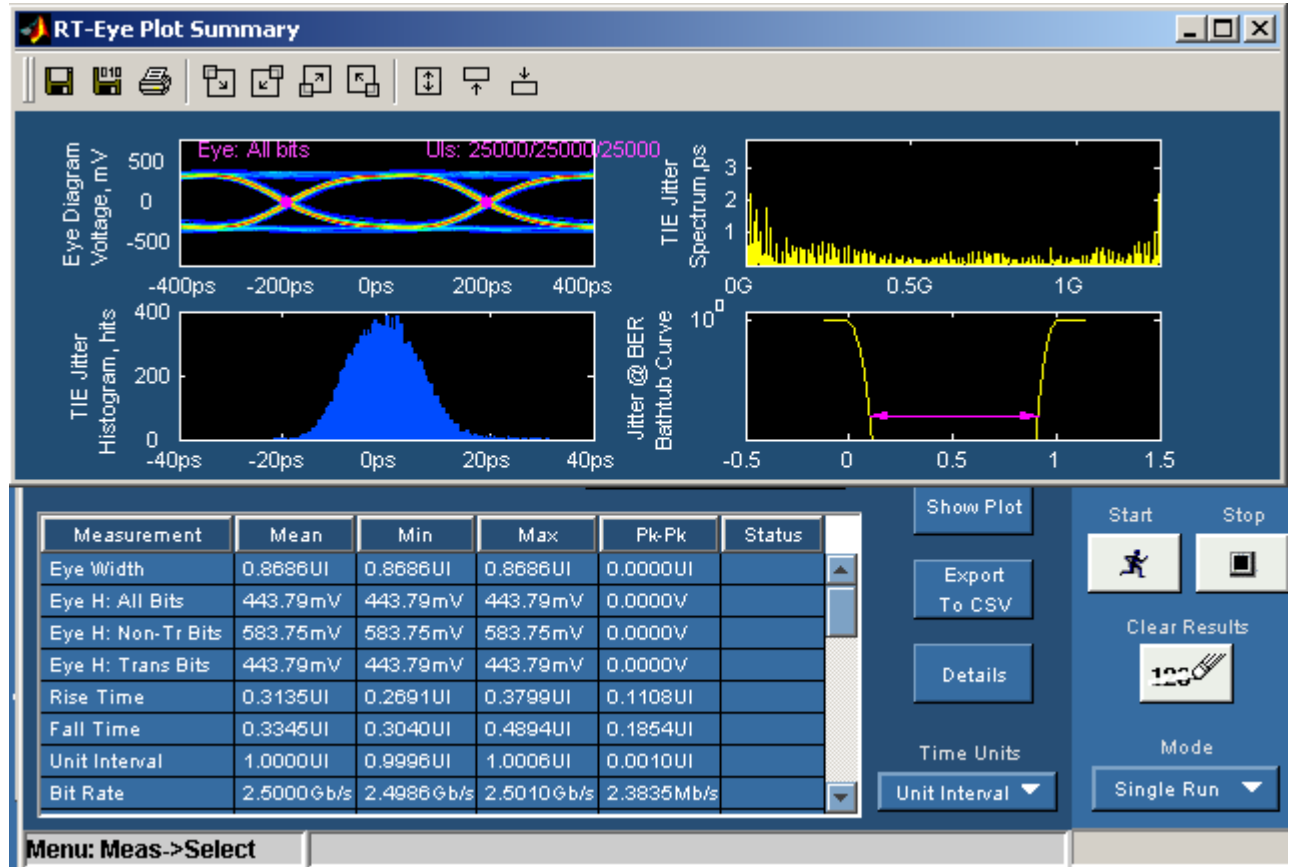

Figure 3-22: Plot waveform diagrams

## File Menus

### File Menu Definitions

Table 3-6: File menu definitions

Menu/function	Description or function
Recall Default	Recalls most default (startup) parameters for the active module.
Recall*	Browse to select an application setup (.ini) file to recall the setup file. Recall restores the application to the values saved in the setup.
Save*	Save the current application settings in a .ini file.
Recall Recent	Select from a list of the four most recently accessed setup files (saved or recalled) and recall that setup.
Preferences	Displays the Preferences menu; settings apply until you exit the application; saved setup files include the settings.
Dock	Locks the RT-Eye user interface to its default position.
Undock	Allows the RT-Eye user interface to be repositioned.
Minimize	Minimizes the application.
Exit	Exits the application; you can choose to retain the current oscilloscope settings or restore the oscilloscope to settings prior to starting the application.
*Save or Recall functions also save or recall the associated oscilloscope setup file (.set); an oscilloscope file is recalled if the application finds a .set file with a matching name.	

### About the File menus

You can use the File menus to save and recall different application setups and recently accessed files. [Display the definitions of the file menus.](#)

**Note:** The File> Save function saves application settings in an .ini file and the settings of the oscilloscope application in a .set file with a matching name.

If an oscilloscope .set file with a matching name is found when you recall an application setup file, then the oscilloscope settings are also recalled. If the .set file is missing or cannot be opened by the oscilloscope, then the application recalls the application settings and displays a message that the Recall of the .set file failed.



Do not edit a setup file or recall a file not generated by the application.

### Saving a Setup File

To save the application and oscilloscope settings to a setup file, follow these steps:

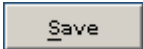
1. Select File> Save.
2. The Save dialog box appears. To view details about the file, such as size, type, and modified date, select the Details tool.
3. In the file browser, select the directory in which to save the setup file or use the current directory.
4. Select or use the keyboard to enter a new file name. The application appends an ".ini" extension to the name of the application setup file.
5. Select the  command button.

---

**Note:** The application also saves the oscilloscope setup to a ".set" file when you save an application setup. Both the application .ini file and oscilloscope .set file have the same file name.

---

**File: Save Browser**

To view details, such as file size, type, and modified date, select the Details tool.

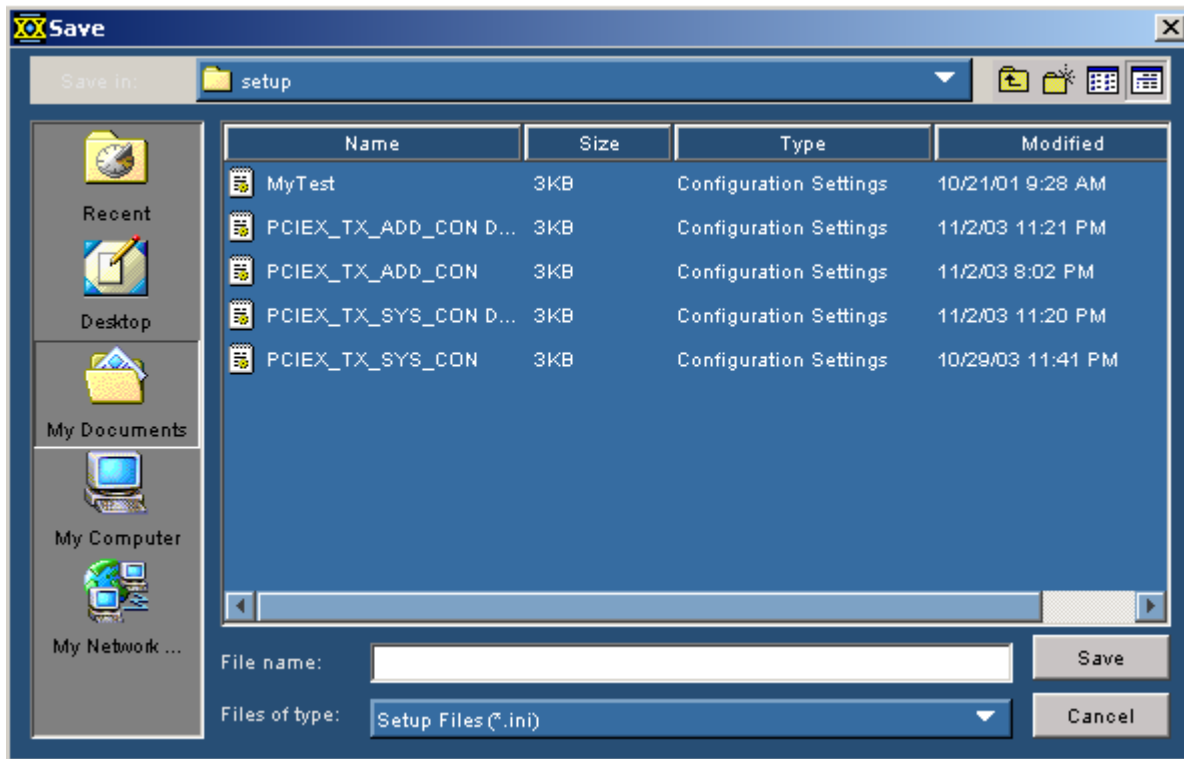

**Figure 3-23: Save Browser**

### Recalling a Saved Setup File

To recall the application and oscilloscope settings from saved setup files, follow these steps:

1. Select File> Recall.
2. The Recall dialog box appears. To view details about the file, such as size, type, and date modified, select the Details tool.
3. In the Recall dialog box, select the directory from which to recall the setup file.
4. Select a setup file name, and then select Open.

---

*Note: The application recalls the .ini setup file and the associated oscilloscope setup if the application can find a .set file with a matching name.*

---



Do not edit setup files. If you try to recall a setup file that has been edited, the recall operation fails.



If a matching .set file is not found or if the .set file does not recall correctly to the oscilloscope, then a warning appears that says the oscilloscope recall failed while the RT-Eye application recall succeeded.

**File: Recall Browser**

To view details, such as file size, type, and modified date, select the Details tool.

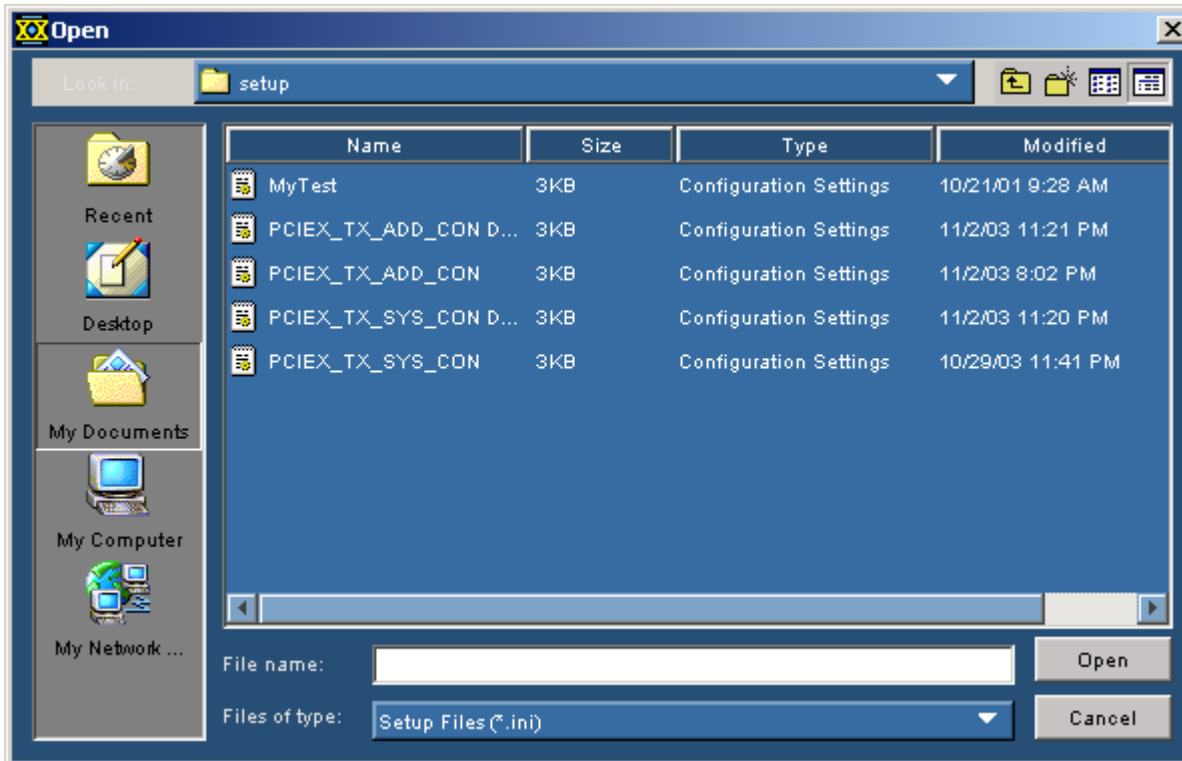

Figure 3-24: Recall browser



### Recalling the Default Setup

To recall the default application settings, select File> Recall Default.

---

*Note: Most of the settings for the active module are recalled to the default state.*

---

### Recalling a Recently Saved or Accessed Setup File

To recall a recently saved or accessed setup file, select File> Recall Recent and then the file from the drop-down list of setup file names.

---

*Note: The application also recalls the associated oscilloscope setup if the application can find a .set file with a matching name.*

---



Do not edit setup files. If you try to recall a setup file that has been edited, the recall operation fails.



If a matching .set file is not found or if the .set file does not recall correctly to the oscilloscope, then a warning appears that says that the RT-Eye application recall succeeded but the oscilloscope recall failed.

## Recall Recent Drop-Down List Example

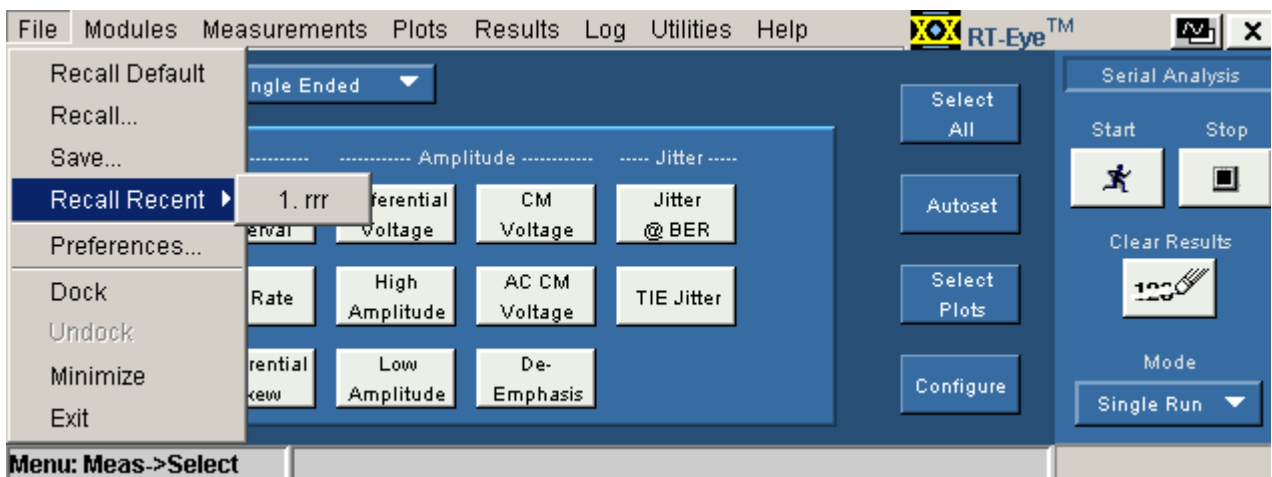

Figure 3-25: Recall recent drop-down list

## Defining Preferences

The application includes options that you can set, and these options remain applied until you change them. The options can help you to operate the application more efficiently.

The File Preferences menu contains several check box options that you can set (enable) or clear (disable). Saved setup files include the File> Preferences settings. View the File Preferences menu.

**File Preferences Options**

**Table 3-7: File preferences options**

Option	Description
Show Welcome dialog at Start up	Determines whether welcome dialog box is displayed whenever the application is launched.
Show Autoset Summary when Autoset is selected	Determines whether a summary table of autoset values is displayed every time autoset is run.
Enable high-performance eye rendering	<p>When unchecked, all unit intervals (UI) in the waveform(s) are included in the rendered eye. This gives the highest fidelity eye rendering, but can take considerable amount of time for long records.</p> <p>When checked, a statistically representative subset of the UI is rendered, so that eye diagrams for long waveforms can be displayed in a reasonable time.</p> <p>The rules for high-performance rendering are as follows:</p> <ol style="list-style-type: none"> <li>1) If the waveform contains 15,000 or fewer UI, all the UIs in the waveform are rendered.</li> <li>2) If the waveform includes more than 15,000 UI, it is subdivided into segments of 2000 UI each. The entire waveform is scanned to find the UI, which are the worst-case violators for six different points around the eye. For each of these worst-case violators, the entire segment of 2000 UI in which it lies is rendered. Depending on whether multiple worst-case violators lie in the same segment or not, as few as 2000 UI but typically from 8000 to 12,000 UI will be rendered in the final eye.</li> </ol>
Cancel	Discards changes and closes.
OK	Accepts changes and closes.

**File: Preferences Menu**

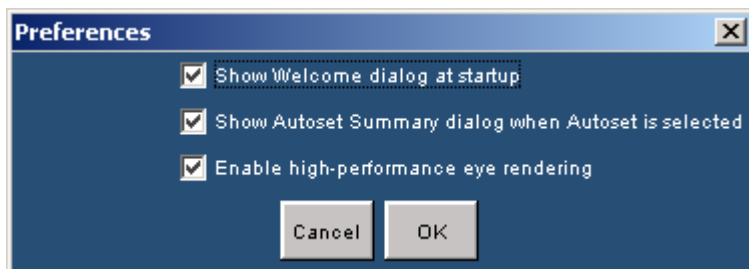

**Figure 3-26: File preferences menu**

## Setting up the Application

### About Setting up the Application for Analysis

You need to set up the RT-Eye application for serial data analysis or for serial data standard compliance testing. To do so may require that you perform some or all of the following tasks:

- Choose the probe configuration: differential or single-ended
- Select all desired measurements
- Select the Autoset command button
- This automatically sets the range of the vertical scale, sets the horizontal resolution, and dynamically sets the waveform crossing thresholds based on signal characteristics.
- [Configure measurement](#) options manually in the Source, Ref Levels, Smart Gating, Jitter, Population, and General Config menus.
- Select and configure all desired plots (up to four at one time)

After setting up the application, you can select the Start command button to take measurements. The application displays the results as statistics and as plots if you set up the Plots menus and enabled the Plots Display option.

---

*Note: You can enable and adjust [Measurement Limits](#) checking to create a Pass or Fail type of compliance test. You can also import industry standard masks and modify or create your own masks files.*

---

After taking measurements, you can do any of the following tasks:

- View the results as statistics
- [Save statistics in a .csv file](#)
- View the results as a plot
- Use the Zoom functions in a plot
- Use the Cursors functions in a plot
- [Save a plot file](#)
- [Print a plot](#)
- [Save the worst case waveforms as .wfm files](#)
- [Generate a report file](#)

General Steps to Set Up the Application

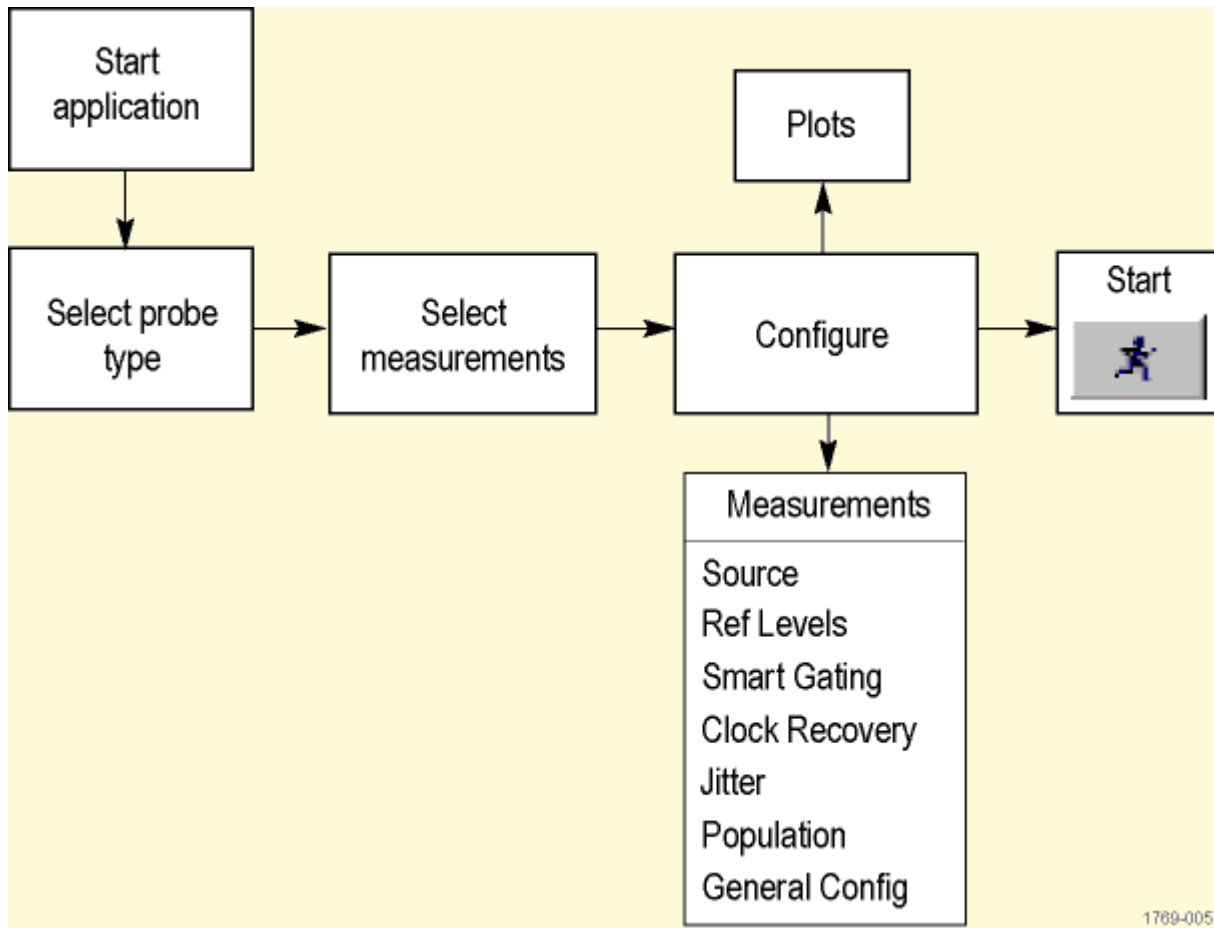

Figure 3-27: Steps to set up the application

### Selecting an Analysis or Compliance Module

The RT-Eye application supports dedicated, technology-specific compliance modules.

The application accepts Tektronix compliance modules for industry-specified testing. These modules are available as options and require the RT-Eye software. If the application does not detect a compliance module, only "Serial Analysis" appears in the Modules drop-down list. If the application detects other compliance modules, then multiple selections appear in the list.

The RT-Eye online help only discusses the "Serial Analysis" module operation. However, the application also includes separate PDF files with Methods of Implementation (MOI) for the InfiniBand and the PCI Express serial data standards specific to the corresponding compliance module.

The Control Panel shows which module is active.

### Selecting the Analysis Module

View the default Measurements Select menu.

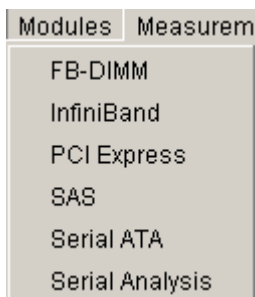

Figure 3-28: Modules

### Selecting a Compliance Module

*Note: The compliance module must be installed and enabled before you can select it. Compliance modules have static configurations and reporting formats unique to a specific standard. In general, you can use these modules for design verification and "Plug-Fest" testing.*

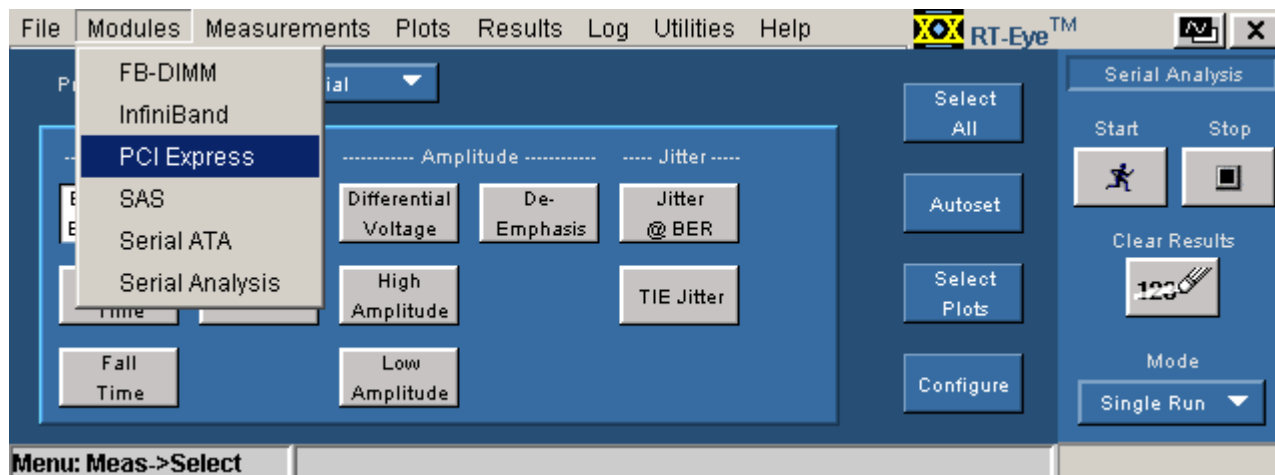

Figure 3-29: Selecting a compliance module

### Choosing the Probe Configuration

Two of the four typical probing configurations discussed in Connecting to a Device Under Test use two channels to make up the differential serial data signal. Additional measurements are also available with these probing configurations. To set the probing configuration (or if you have two reference waveforms), select Single-Ended as the Probe Type option. If the signal is probed differentially so that the differential signal is delivered to the oscilloscope on a single channel, select Differential as the Probe Type option.

## Probe Type Definitions

**Table 3-8: Probe type definitions**

Probe type	Description
Differential*	Displays source selections and measurements suitable for true differential probing (single connection to scope).
Single-Ended	Displays source selections and measurements suitable for pseudo-differential probing (two connections to scope, with difference operation performed in software).
* The default Probe Type for the RT-Eye serial analysis application.	



### Selecting a Measurement



You can use the Measurements> Select menu to select measurements for the application to take. The application takes all selected measurements.

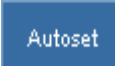

This is the default menu when you start the application. You can also access the menu by selecting Measurements> Select in the menu bar.

The measurements will vary depending on the type of probe selected as the Probe Type option.

Use the  button to automatically set the Horizontal and Vertical scales of the Sources and the corresponding reference voltage levels. Refer to [Autoset Button in Measurements Select menu](#).

 **Tip** Use the  button as a short cut to the Plots> Select menu.

 **Tip** Use the  button as a short cut to the Measurements> Configure menus.

 **Tip** Use the  button as a short cut to turn on all the available Measurements instead of selecting one measurement at a time.



Measurement Definitions

Table 3-9: Measurement definitions

Area	Option	Description	Units
Timing*	Eye Width/ Eye Height	Eye Width is the <i>measured</i> minimum horizontal eye opening at the middle reference level as shown in the eye diagram. Eye Height is the <i>measured</i> minimum vertical eye opening at the UI center as shown in the eye diagram.	s or V
	Rise Time**	Time difference between when the Hi reference level is crossed and the Lo reference level is crossed on the rising edge of the waveform.	s
	Fall Time**	Time difference between when the Hi reference level is crossed and the Lo reference level is crossed on the falling edge of the waveform.	s
	Unit Interval	Cycle duration of the recovered clock.	s
	Bit Rate	Inverse of Unit Interval.	Gb/s
	Differential Skew†	Time delay between two single ended waveform sources.	s
Amplitude	Differential Voltage**	Statistics for a differential waveform.	V
	High Amplitude	Histogram mode of all differential waveform values greater than zero.	V
	Low Amplitude	Histogram mode of all differential waveform values less than zero.	V
	CM Voltage†	Statistics of the Common Mode voltage waveform.	V
	AC CM Voltage†	AC statistics of the Common Mode voltage waveform.	V
	De-Emphasis	Ration of any non-transition eye-voltage to its nearest preceding transition eye voltage.	dB
Jitter*	Jitter @ BER	Deterministic and random components of jitter.	s
	TIE Jitter	Measured time difference between a data edge and a recovered clock edge.	s
* Use the Time Units option (Results menu) to convert and display the results as Unit Interval.			
** Use the File Preferences menu to restrict measurements to transition bits only.			
† Added when Single Ended is the Probe Type option.			

**Measurements: Select Menu for Differential Probes**

*Note: This is the default menu that appears when you start the RT-Eye application.*

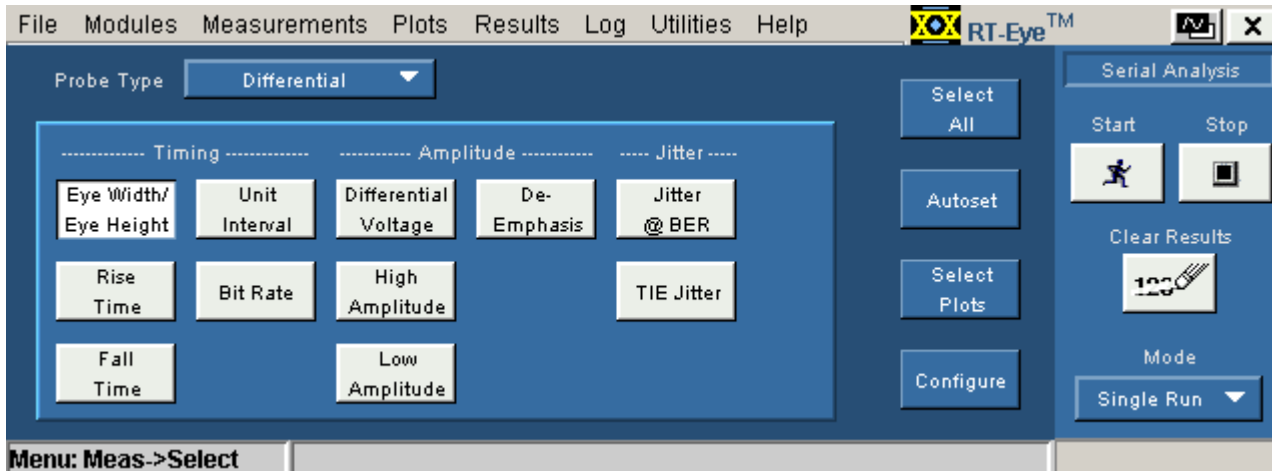

Figure 3-30: Measurement selections for differential probe

**Measurements: Select Menu for Single-Ended Probes**

*Note: The application adds measurements when Single-Ended is selected as the Probe Type option: Differential Skew, CM Voltage, and AC CM Voltage.*

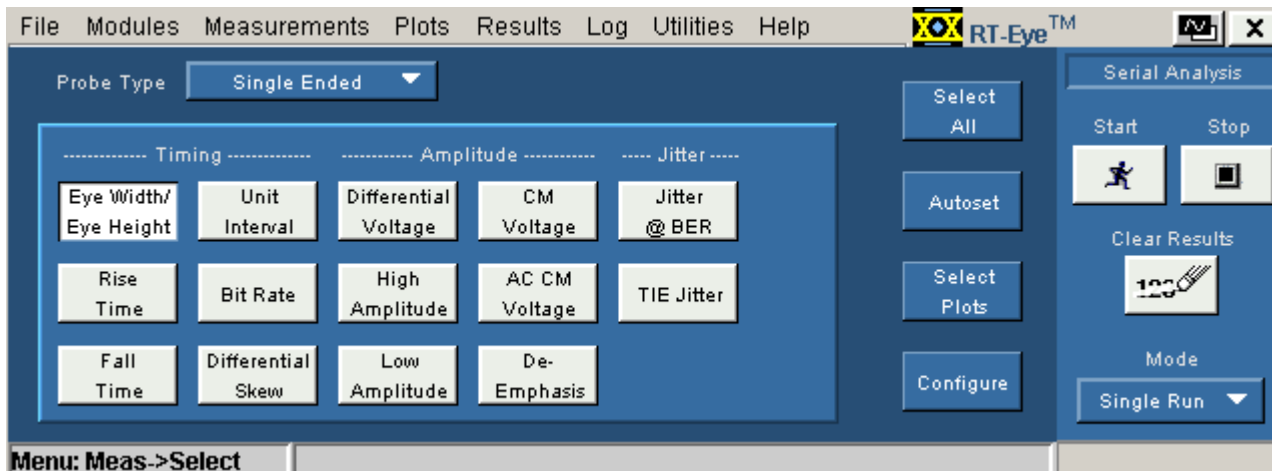





Figure 3-31: Measurement selections for single-ended probe

### Autoset Button in the Measurements Select Menu

Select the  button in the Measurements> Select menu to automatically set the vertical scale, horizontal resolution, and reference voltage levels for all active sources. Depending on the settings in the File> Preferences menu, either the autoset operation will occur immediately or the application will display the Autoset Summary menu and wait for you to choose the next action.

The Autoset Summary menu shows the current source autoset and reference level autoset values and parameters in a brief outline view. No autoset operation is performed until you select

the  command button.

 **Tip** Use the  button as a short cut to the Measurements> Configure menus.

### Autoset Summary Menu Options

Table 3-10:Autoset summary menu options

Option/function	Description
Autoset	Performs the Source Autoset and the Ref Levels Autoset functions; values update accordingly.
Configure	Accesses the Configure Ref Levels menu.
Close	Discards changes and closes the menu.
Do not show this menu again*	Defines whether or not the application displays the Autoset Summary menu every time you select the Autoset command button in the Measurements>Select menu.
<b>* If set, use the File Preferences menu to display the Autoset Summary menu.</b>	

## Autoset Summary Menu Example

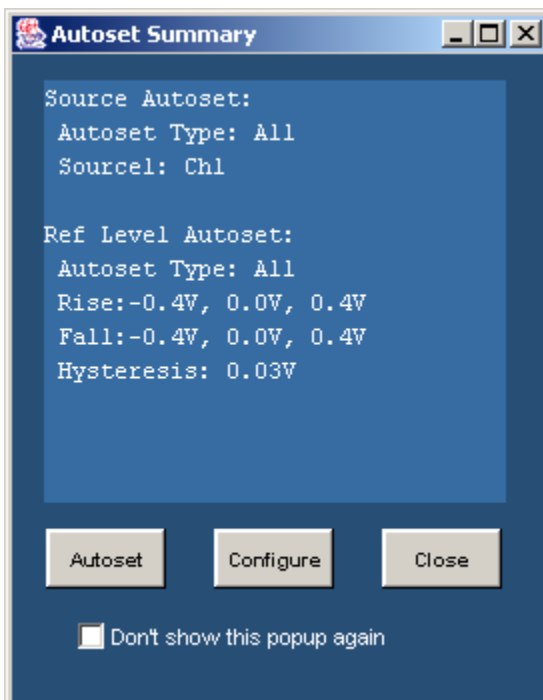

Figure 3-32: Autoset Summary

## Configuring a Measurement

### About Configuring a Measurement

Measurements may or may not require configuration. A quick way to configure measurements is to select the [Autoset button in the Measurements Select menu](#).



**Tip**



Use the  button from the Measurements> Select menu as a short cut to the Configure menus.

The application includes the following Configure menus:



- [Source](#)
- [Ref Levels](#)
- [Smart Gating](#)
- [Clock Recovery](#)
- [Jitter](#)
- [Population](#)
- General Config

### Configure Menu Definitions

**Table 3-11: Configure Menu definitions**

Menu name	Description
Source*	Specify the source of the measurement as a channel (live) or reference waveform, or a File; you can use the Autoset functions (only for live sources) to change the vertical scale or horizontal resolution of the waveform. The automatic Vertical Scale function ensures that the entire waveform occupies the full vertical space available in the graticule. The automatic Horizontal Resolution function ensures that there are enough samples for accurate results.
Ref Levels	Set the reference voltage levels for the thresholds of the rising and the falling edges as an absolute value The automatic function sets the thresholds relative to the minimum and maximum levels of the peak-to-peak values; default percentages are 20% and 80%.
Smart Gating	Sets a gated region: Cursor gating, Smart Gating (Custom), or no gating at all (Off).
Clock Recovery	Sets clock recovery to an industry standard method: PLL Standard BW, PLL User BW, Constant Clock Mean, or Constant Clock Median.
Jitter	Defines the analysis method, data pattern, and Bit Error Rate threshold for Jitter@BER measurements. These parameters are not required for TIE Jitter measurements.
Population**	Sets the required population for each measurement or specifies the number of acquisitions.
General Config	Sets whether Rise/Fall and Amplitude measurements are limited to transition bits or performed for all bits. Enables logging of worst case waveforms obtained during scan mode in the waveform files directory.
<b>* All sources must have the same Horizontal Sample Rate, Record Length, and Position to assure that measurements function properly.</b>	
<b>** In Free Run mode, sequencing stops when the population limit is met.</b>	

## Sources

### About Configuring the Sources

The application takes measurements from waveforms or files specified as input sources. You can select an oscilloscope channel input (live), a reference waveform, or a saved waveform file as the source. The selections available for Source Type depend on the Probe Type selected in the Measurements> Select menu.



**Tip** Use the  button as a short cut to the Measurements Select menu.

[View the Configure Source menu for Differential probes](#)

[View the Configure Source menu for Single-Ended probes](#)

### Configure Source Menu Options for a Differential Probe

*Note: Differential probes do not provide common mode voltage components.*

**Table 3-12: Configure source menu for a differential probe**

Area	Option	Description
Source Type	Live/Ref	Lists channel or reference waveforms for the Select Differential option.
	File*	Recalls the input from a single .csv or .wfm file; enables the Select File area.
Select Differential**	Ch1, Ch2, Ch3, Ch4, Ref1, Ref2, Ref3, Ref4	Use a channel or reference waveform from which to take $V_{DIFF}$ measurements.
Autoset†	Vertical Scale	Sets the display of the waveform to the full screen vertically based on the amplitude of the source; the Peak-Peak of the waveform is 80% of the ADC full scale.
	Horizontal Resolution	Sets the time base parameters to the necessary horizontal resolution and record length to ensure accurate results.
	Vertical & Horizontal	Sets the vertical scale and the horizontal resolution.
* Use the Browser to select a Differential File.		
** Uses a differential mode waveform as the source when Differential is the Probe Type option. You can use a Math waveform, such as for a CH1-CH3 operation, if you save the resultant waveform, recall the waveform to a reference memory location (Ref1, Ref2, Ref3, or Ref4), and then use the Ref waveform as a source.		
† Only available for live (channel) waveforms.		



Configure Source Menu for Differential Probes

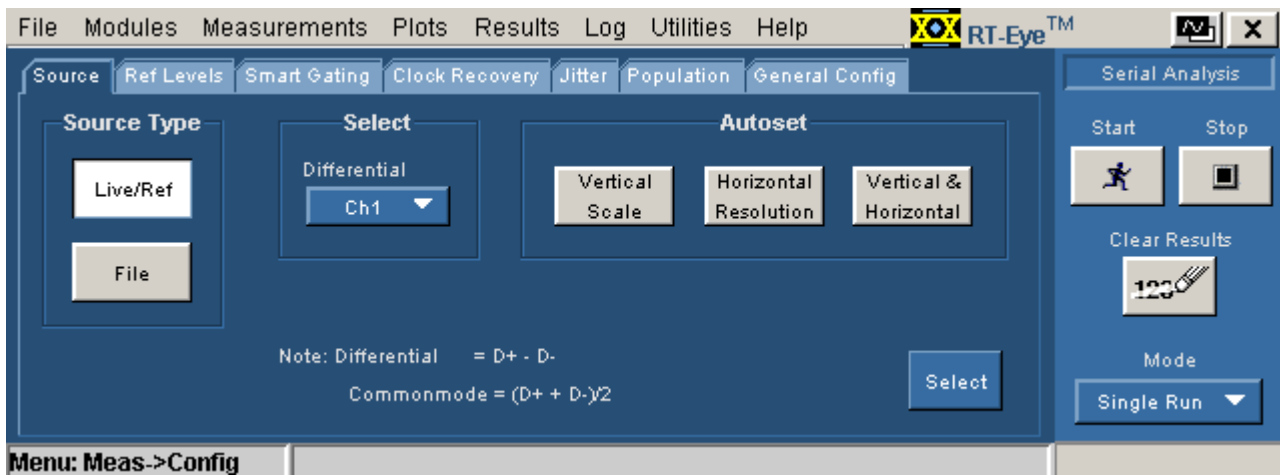

Figure 3-33: Configure source menu for differential probes

Configure Source from a File for Differential Probes

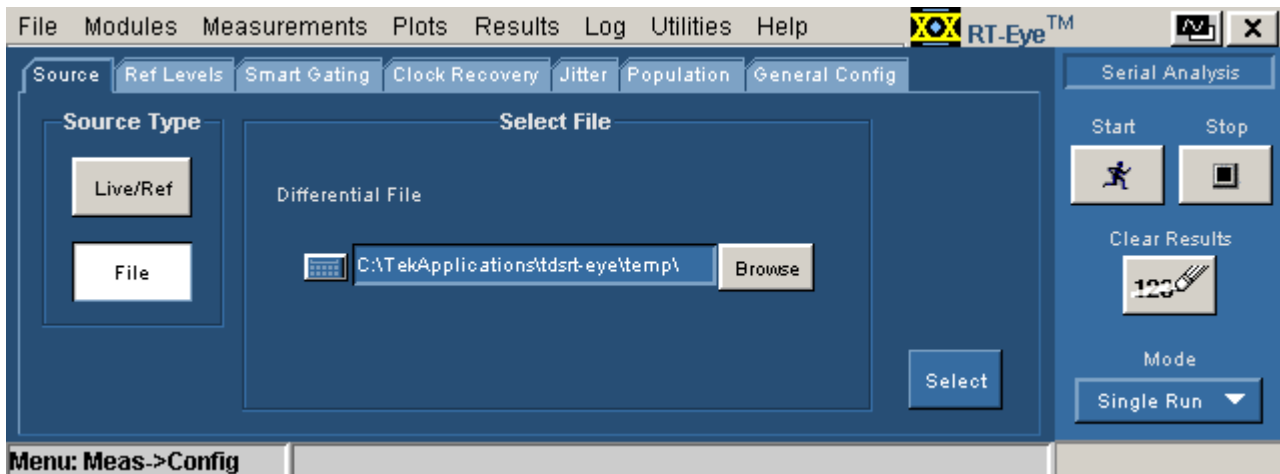

Figure 3-34: Configure source from a file for differential probes

### Configure Source Menu Options for Single-Ended Probes

*Note: You must use single-ended probes for common mode voltage measurements.*

**Table 3-13: Configure source menu options for single-ended probes**

Area	Option	Description
Source Type	Live	Uses one of the following channel combinations for the D+ and D- waveforms: CH1, CH3 CH1, CH4 CH2, CH3 CH2, CH4
	Ref	Uses any combination of reference waveforms for the D+ and D- waveforms.
	File	Enables the Select File area.
Select D+, D-	Selections are based on a Live or Ref Source Type option.	
Autoset*	Vertical Scale	Sets the display of each waveform to the full screen vertically based on the amplitude of the source; the Peak-Peak of the waveform is 80% of the ADC full scale.
	Horizontal Resolution	Sets the time base parameters to the necessary horizontal resolution and record length to ensure accurate results.
	Vertical & Horizontal	Sets the vertical scale and the horizontal resolution.
Select Files**	Browse	Recalls single-ended inputs from two .csv or .wfm files, a D+ and D-.
* Only available for channel waveforms.		
** Use the Browser to select the Differential File(s).		

### Configure Source Menu for Single-Ended Probes

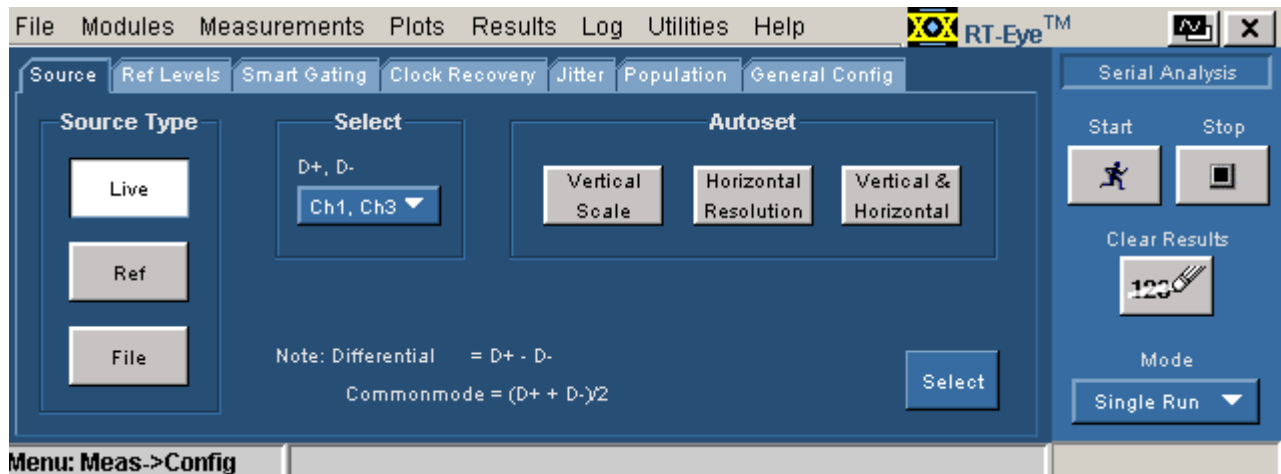

Figure 3-35: Configure source menu for single-ended probes

### Configure Source from Ref Waveform for Single-Ended Probes

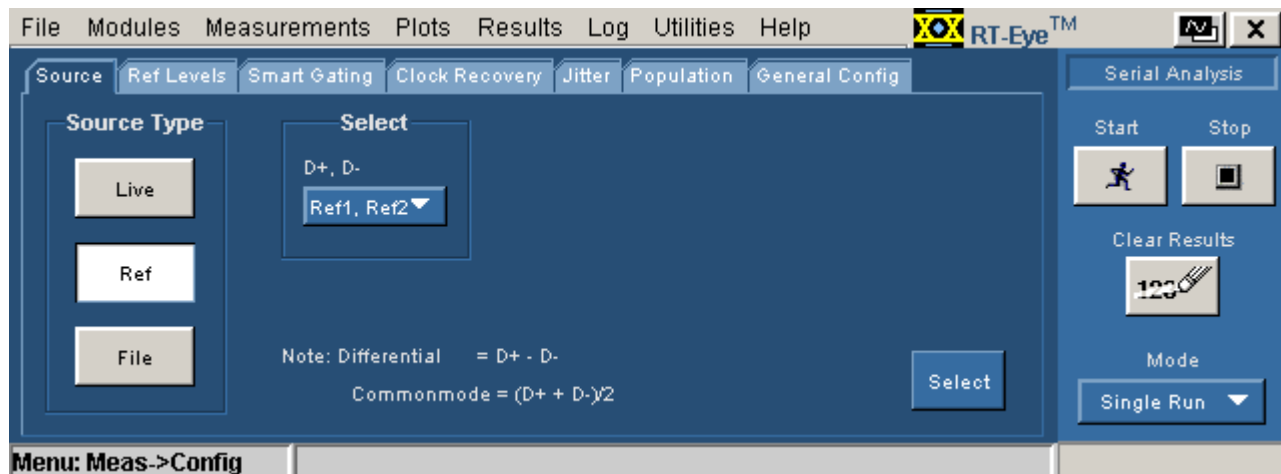

Figure 3-36: Configure Source from Ref Waveform for Single-Ended Probes

## Configure Source from File for Single-Ended Probes

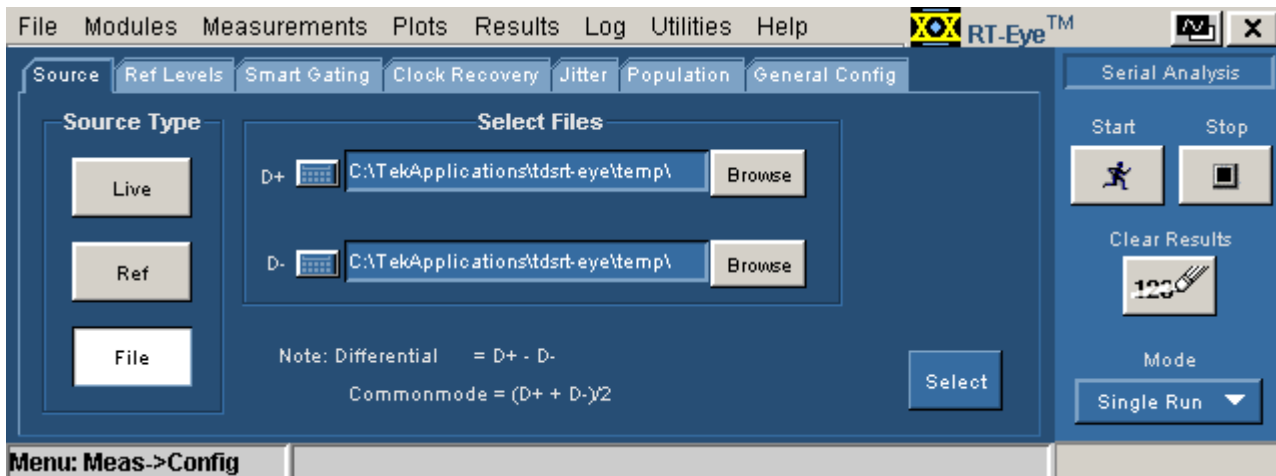

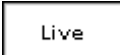

Figure 3-37: Configure source from file for single-ended probes

### Autosetting Sources for Live (Channel) Waveforms

In most situations when you want to take measurements from a "live" (channel) waveform, you can usually improve measurement accuracy by using the Autoset options to optimize the vertical scale or horizontal resolution settings of the oscilloscope.

To automatically define the vertical and horizontal settings for a source, follow these steps:

1. Select Measurements> Configure> Source (or the  tab).
2. For differential probes, select the  button.
3. For single-ended probes, select the  button.
4. In the Select area, choose the specific channel or channels that you are using.
5. Select one of the Autoset area command buttons. Refer to the [Configure Source Menu Options for Single-Ended Probes](#) topic for a description of each option.

---

*Note: The horizontal autoset in RT-Eye places the instrument in the maximum sample rate available. If the 20-80% rise time of the signal is faster than 2X the sample interval, interpolation is recommended to increase accuracy of rise time and jitter measurements.*

---

## Reference Voltage Levels

### About Reference Voltage Levels

You need to set reference voltage levels so that the application can identify state transitions on a waveform. Serial data timing measurements are based on state transition times in waveforms. By definition, edges occur when a waveform crosses specified reference voltage levels. There are two ways to set the reference voltage levels: automatically and manually.

### High, Mid, and Low Reference Voltage Levels

The application uses three reference voltage levels: High, Mid, and Low.

- For most Time Interval and Jitter measurements, the application only uses the Mid reference voltage level.

The Mid reference level defines when the waveform transition occurs at a given threshold. For most NRZ AC coupled signals, you would set the Mid reference level to Zero volts.

The Configure Ref Levels menu includes a "Mid = 0V" option which is set by default. You can clear the check box to allow the Autoset function to calculate the proper Mid reference level in the presence of common mode voltages frequently encountered when using single-ended probes.

- For Rise Time and Fall Time measurements, the High and Low reference voltage levels define when the waveform is fully high or low.

### Reference Voltage Levels Diagram

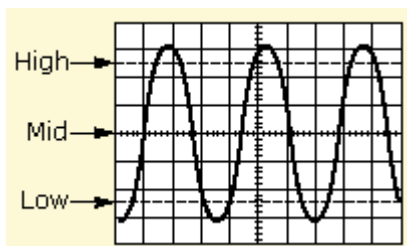

Figure 3-38: Reference voltage levels diagram

### Rising Versus Falling Thresholds

The option to set separate thresholds for Rising edges vs Falling edges is available in Ref Level Control panel, though the feature is not currently implemented. The High, Mid and Low thresholds entered in the Rise column are actually applied to both rising and falling edges. The values entered in the Fall column are ignored.

### Using the Hysteresis Option

The hysteresis option can prevent small amounts of noise in a waveform from producing multiple threshold crossings. You can use a hysteresis when the rising and falling thresholds for a given reference voltage level are set to the same value.

The reference voltage level  $\pm$  the hysteresis value defines a voltage range that must be fully crossed by the waveform for an edge event to occur. If the decision threshold is crossed more than once before the waveform exits the hysteresis band, the mean value of the first and last crossing times is used as the edge event time.

For example, if the waveform rises through the Threshold - Hysteresis, then rises through the Threshold, then falls through the Threshold, and then rises through both the Threshold and the Threshold + Hysteresis, a single edge event occurs at the mean value of the two rising crossings.

### Example of Hysteresis on a Noisy Waveform

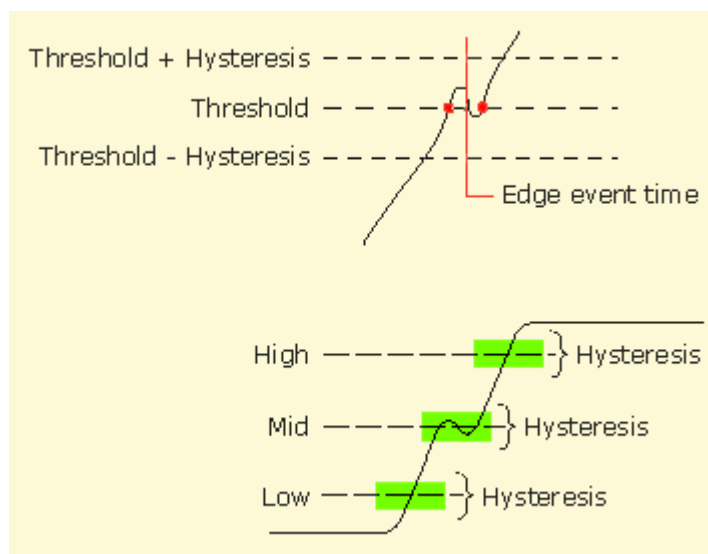

Figure 3-39: Example of Hysteresis on a noisy waveform

**Cursor Gating and Reference Voltage Levels Autose**

You can use cursor gating with the reference voltage levels Autose function. If you enable and set up Cursors in the Configure Smart Gating menu, the application uses the data within the gated region to automatically calculate the reference voltage levels.

**Configuring Reference Voltage Level Autose**

The Autose Run button on the Ref Levels tab sets all reference voltage thresholds and the hysteresis value to percentages of the base-top voltage amplitude for the waveform. The Ref Level Autose Setup menu allows you to configure the percentages to define each threshold.



### Configuring Reference Voltage Autoset Percentages

The default Reference Level Autoset parameters should be appropriate for most conditions, but you can adjust them for specific situations if you require different behavior.

To configure the Ref Level Autoset Setup menu options, follow these steps:

1. Select Measurements> Configure> Ref Levels> Autoset Setup.
2. The Ref Level Autoset Setup menu appears. [View the Ref Level Autoset Setup menu.](#)
3. For each reference voltage level you want to adjust, select the keypad icon or multipurpose knob icon, and enter the percentage of the base to top span of the waveform. The settings are based on the following definitions:

$$0\% = \text{mean}(v_{EYE-HI-TRAN}(n))$$

$$100\% = \text{mean}(v_{EYE-LO-TRAN}(n))$$

4. Select the OK button to update the values and close the Ref Level Autoset Setup menu.
5. Select the Run command button in the Configure Ref Levels menu.
6. The application calculates the reference voltage levels based on the percentages set in the Ref Level Autoset Setup menu.
7. If desired, you can manually refine the calculated values in the Configure> Ref Levels menu to suit your analysis situation.

### Steps to Set the Reference Voltage Levels

The screenshot shows the RT-Eye software interface. The main window is titled 'RT-Eye™' and has a menu bar with 'File', 'Modules', 'Measurements', 'Plots', 'Results', 'Log', 'Utilities', and 'Help'. The 'Ref Levels' tab is selected. The 'Set Reference Level' dialog box is open, showing 'Autoset' options. The 'Autoset' section has 'Setup' and 'Run' buttons. A 'Set Reference Level' dialog box is shown below, with fields for Rise High (200mV), Rise Mid (0V), Rise Low (-200mV), Fall High (200mV), Fall Mid (0V), and Fall Low (-200mV). A 'Set Ref Level % Relative to Base-Top' dialog box is also shown, with fields for Rise High (80%), Rise Mid (50%), Rise Low (20%), Fall High (90%), Fall Mid (50%), Fall Low (20%), and Hysteresis (3%).

1. Display the Ref Level Autoset Setup menu and adjust values.

2. Select OK to accept.

3. Select Run; the application calculates reference level values.

4. If necessary, adjust values manually.

Figure 3-40: Steps to set reference voltage levels

Reference Level Autoset Setup Menu Options

Table 3-14: Reference level autoset setup menu options

Option*	Description**
Rise, High	Sets the high threshold level for the rising edge of the source.
Rise, Mid	Sets the middle threshold level for the rising edge of the source.
Rise, Low	Sets the low threshold level for the rising edge of the source.
Fall, High	Sets the high threshold level for the falling edge of the source.
Fall, Mid	Sets the middle threshold level for the falling edge of the source.
Fall, Low	Sets the low threshold level for the falling edge of the source.
Hysteresis	Sets the threshold margin to the reference level which the voltage must cross to be recognized as changing; the margin is the relative reference level plus or minus half the hysteresis; use to filter out spurious events.
* Default settings are 80% (High), 50% (Mid), 20% (Low), and 3% (Hysteresis)	
** Where 0% = mean(VEYE-HI-TRAN(n)) and 100% = mean(VEYE-LO-TRAN(n)).	

Ref Level Autoset Setup Menu

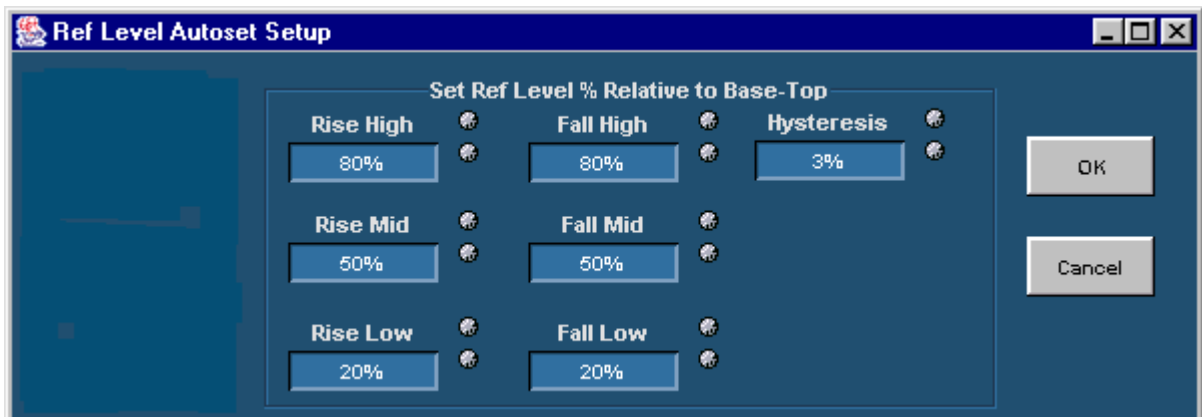

Figure 3-41: Reference level autoset set up menu

Manually Adjusting the Reference Voltage Levels

Whether or not you use the application to automatically calculate the reference voltage levels, you may need to manually change the values. To set the reference levels manually, follow these steps:

1. Select Measurements> Configure> Ref Levels> Source and choose a source (channel or reference waveform) for which you want to set the reference levels. If the Probe Type is differential, only one choice is available.
2. In the Set Reference Level area, adjust the values of the reference voltage levels and the hysteresis. View the [Configure Ref Levels menu](#).

## Configure Ref Levels Menu Options

Table 3-15: Configure reference levels menu options

Area	Option	Description
Source	Differential	Selects the reference levels for the Differential waveform or file.
	DPlus*	Selects the reference levels for the DPlus waveform or file.
	DMinus*	Selects the reference levels for the DMinus waveform or file.
Ref Level Autoset	Setup	Displays the Ref Level Autoset Setup menu.
	Run	Automatically calculates and sets the reference levels according the settings in the Ref Level Autoset Setup menu.
Set Reference Level	Rise, High	Sets the high threshold level, in volts, for both rising and falling edges of the source waveform.
	Rise, Mid	Sets the middle threshold level, in volts, for both rising and falling edges of the source waveform.
	Rise, Low	Sets the low threshold level, in volts, for the rising and falling edges of the source waveform.
	Fall, High	Reserved for future use.
	Fall, Mid	Reserved for future use.
	Fall, Low	Reserved for future use.
	Hysteresis	Sets the threshold margin, in volts, relative to the reference level which the voltage must cross to be recognized as changing; the margin is the reference voltage level plus or minus half the hysteresis; use to filter out spurious events.
Mid = 0V**	Set or clear	When checked, sets the middle threshold level to 0 Volts; when cleared (unchecked), sets the level to the value calculated by the application.
<b>* Only available when Single Ended is the Probe Type.</b>		
<b>** Common mode voltages can be frequently found with single-ended probes. Clear this option before you use the Reference Level Autoset function.</b>		

### Configure Ref Levels Menu

*Note: The Source DPlus and DMinus options are only usable when you select Single-Ended as the Probe Type option in the Measurements> Select menu.*

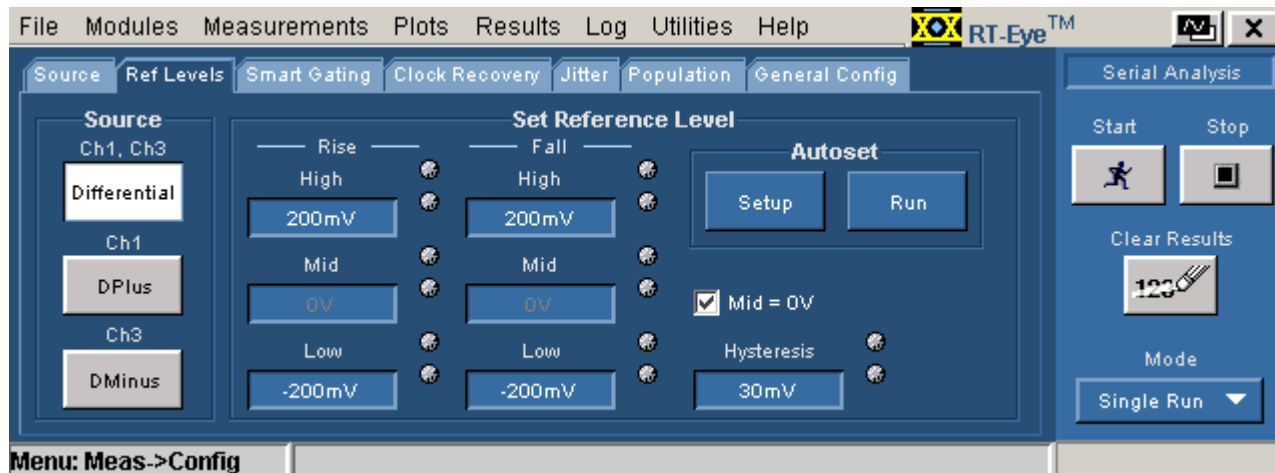

Figure 3-42: Configure reference levels menu

## Gating Measurements

### About Gated Measurements

Gating allows you to focus the analysis on a specific area of the waveform bound by a gated region, which is a way to filter unnecessary information. To access the Smart Gating menu, select Measurements> Configure> Smart Gating.

You can set up a gated region in one of the following ways:

- Vertical Cursors
- Smart Gating

The application uses the Smart Gating function when you select Smart Gating as the Gating option. With Smart Gating, the application establishes a Clock Recovery Window, part of the waveform on which the selected clock recovery method is applied. An Analysis Window is the part of the waveform on which measurements are taken and it is defined relative to the clock recovery window. If you enable scanning, the clock recovery window (with its contained analysis window) is scanned across the acquired waveform according to the scanning parameters. In this case, the results from each scan increment contribute to the population of measurements.

The population of measurement appears in the results panel and the associated plots.

Configure Smart Gating Menu Options

Table 3-16: Configure smart gating menu options

Area	Option	Description
Gating	Off	No gating occurs; application takes measurements over the entire waveform.
	Cursors	Gates the waveform with Vertical cursors.
	Smart Gating	Enables the Smart Gating function; refer to the Configure Gating Menu Options for Custom Gating topic.

Configure Smart Gating Menu with Gating Off

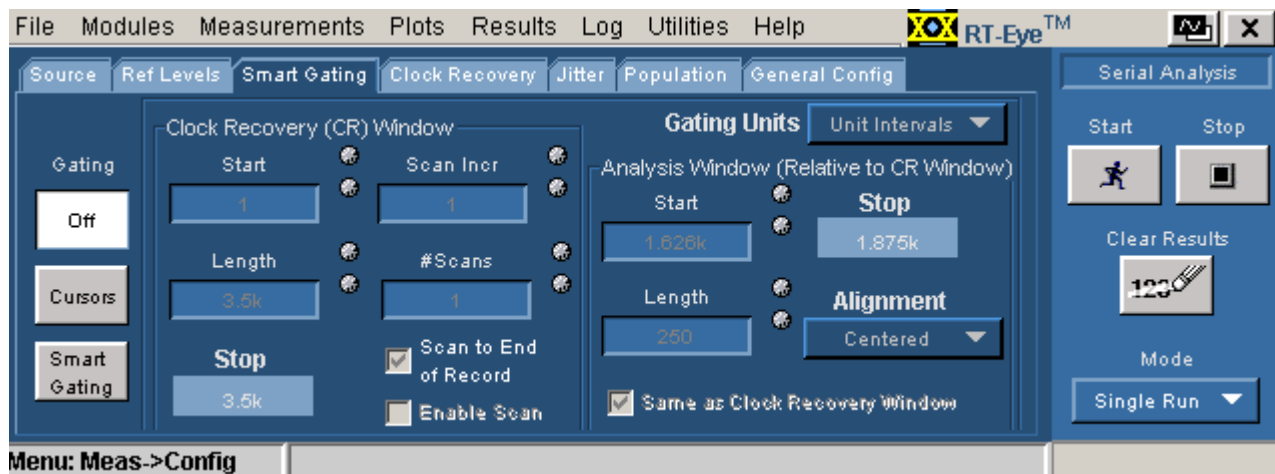

Figure 3-43: Configure smart gating menu with gating off

### Configure Smart Gating Menu with Cursors Gating

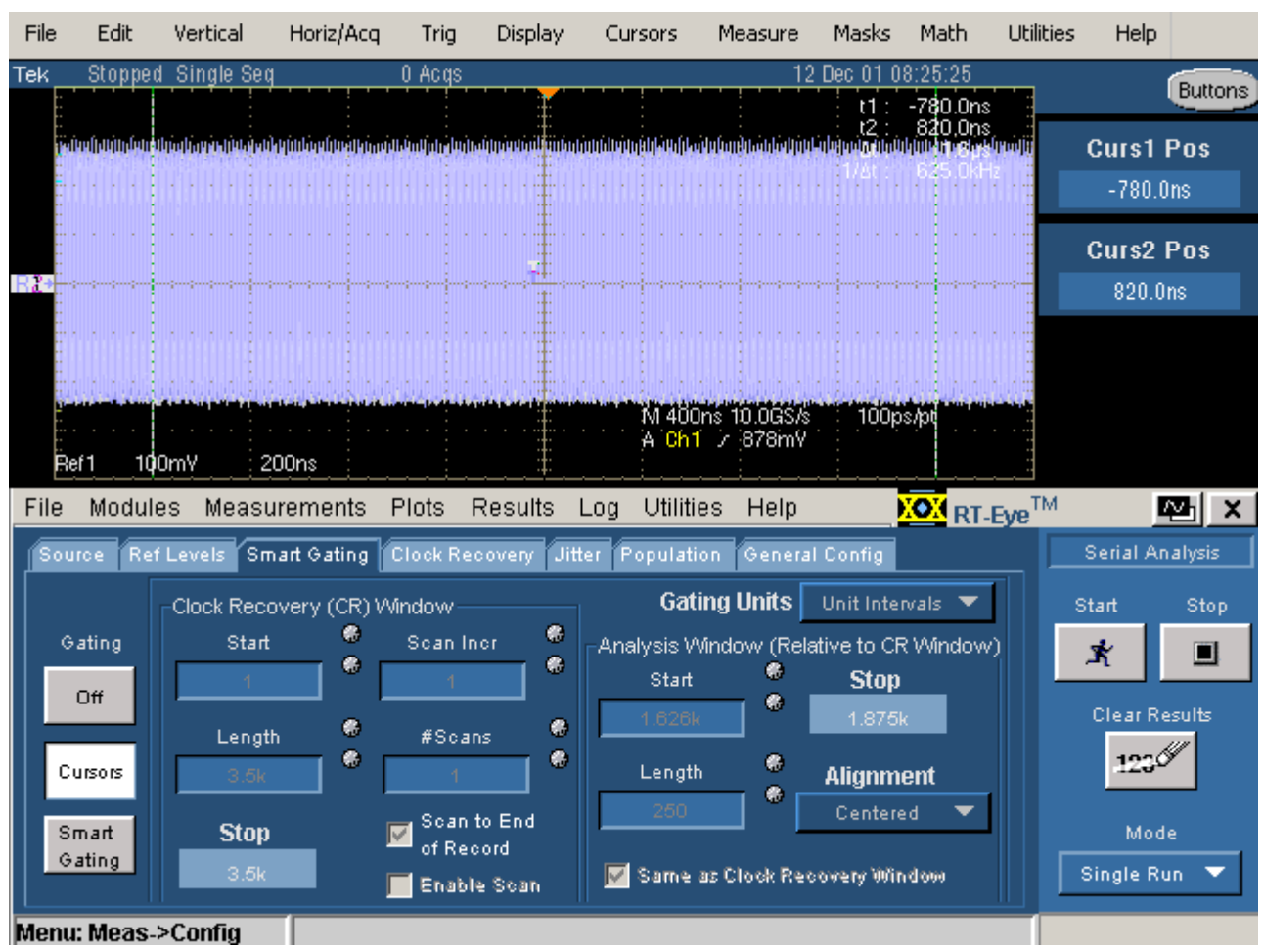

Figure 3-44: Configure smart gating menu with cursors gating

### Configure Smart Gating Menu Options for Smart Gating

**Table 3-17: Configure smart gating menu options**

Area	Option	Description
Gating Units	Unit Intervals	Gates the waveform by Unit Intervals.
	Edges	Gates the waveform by Edges.
Clock Recovery Window	Length	Number of Unit Intervals or Edges that defines the size of the window over which the application recovers the clock.
	Start	Specific Unit Interval or Edge within the record where the application starts to recover the clock.
	Stop	Reports the Unit Interval or Edge on which the application will stop the clock recovery.
	Scan Incr	Amount by which the Start and Stop values are incremented for each new scan, if scan is enabled.
	#Scans	Number of scans, if scanning is enabled and scan-to-end is disabled.
	Scan to End of Record	Causes scanning to repeat based on scan increment, until the end of the record.
	Enable Scan	Enables scan mode for the measurements.
Analysis Window	Same as Clock Recovery Window	Enables or disables reusing the same settings for the Analysis Window as for the Clock Recovery Window option.
	Alignment Centered	Centers the Analysis Window within the Clock Recovery Window.
	User Defined	Specifies the absolute position of the Analysis Window within the Clock Recovery Window.
	Length	Number of Unit Intervals or Edges that defines the size of the window.
	Start	Specific Unit Interval or Edge where the window starts.
	Stop	Reports the UI or Edge on which the window will stop.



### **Using Smart Gating**

The Smart Gating control consists of a Clock Recovery (CR) window and an Analysis window (Refer to the Smart Gating Diagram). The Clock Recovery and Analysis window can be set to scan the waveform record. You can configure the starting point and length of the CR window. The resulting Stop value (end point) is calculated and displayed. You can also configure the scan increment. The clock recovery method selected on the Clock Recovery tab will be applied to the CR window to establish the reference clock edges for this portion of the waveform.

The Analysis window is defined relative to the CR window using the Length and Alignment controls. If the Alignment control is set to Custom, the Start control defines where the Analysis window begins relative to the CR window. As a convenience, you can select the "Same as Clock Recovery window" check box to make the two windows coincide.

The following example shows how to apply a CR window of 3500 UI and an analysis window of 250 UI, centered within the CR window:

#### **In the CR window:**

Start: 1, Length: 3.5k.

#### **In the Analysis window:**

Alignment: Centered

Length: 250

Configure Smart Gating Menu with Clock Recovery Window

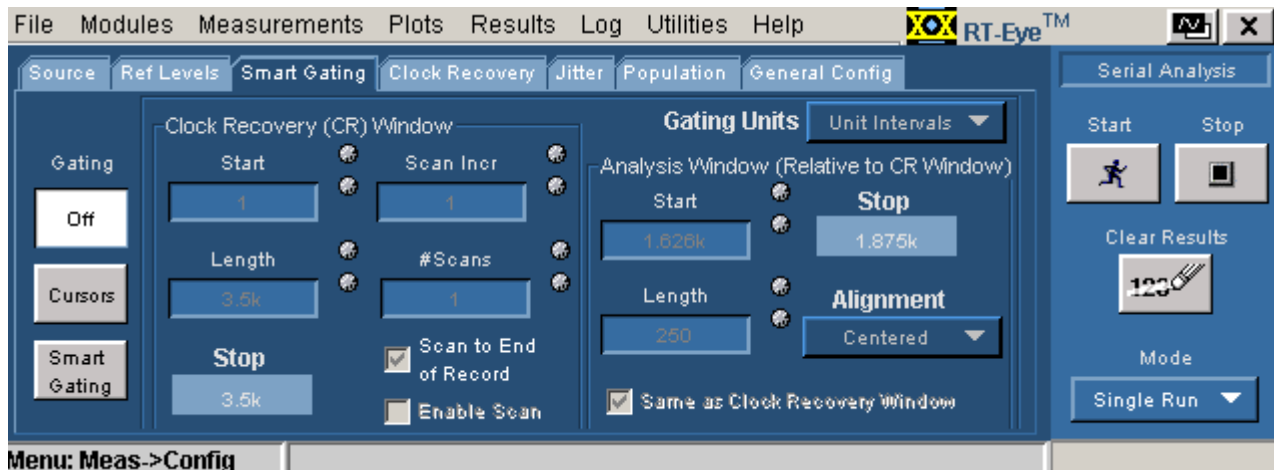

Figure 3-45: Configure smart gating menu with clock recovery window

Configure Smart Gating Menu with Analysis Window

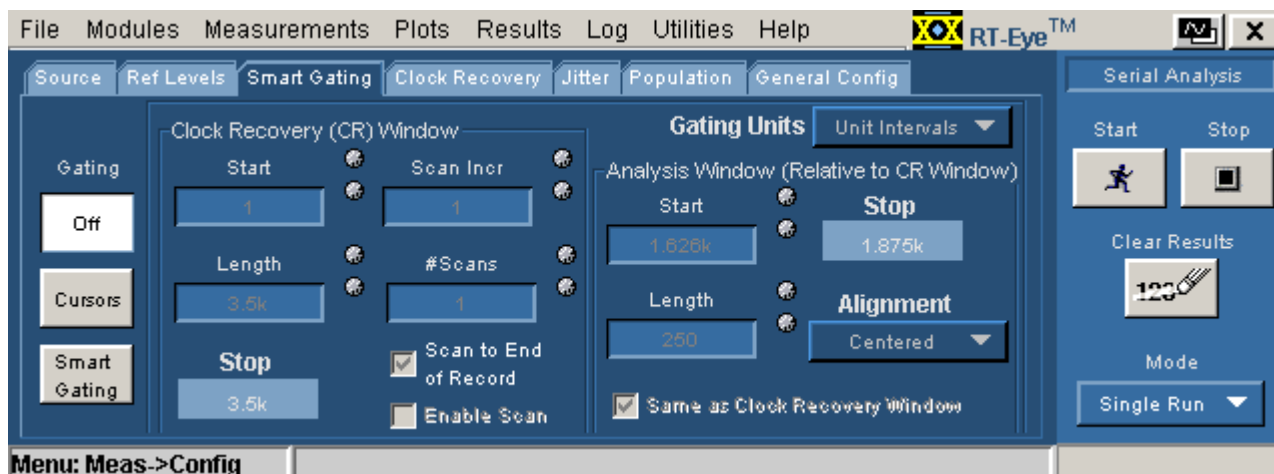

Figure 3-46: Configure smart gating menu with analysis window

Smart Gating Diagram

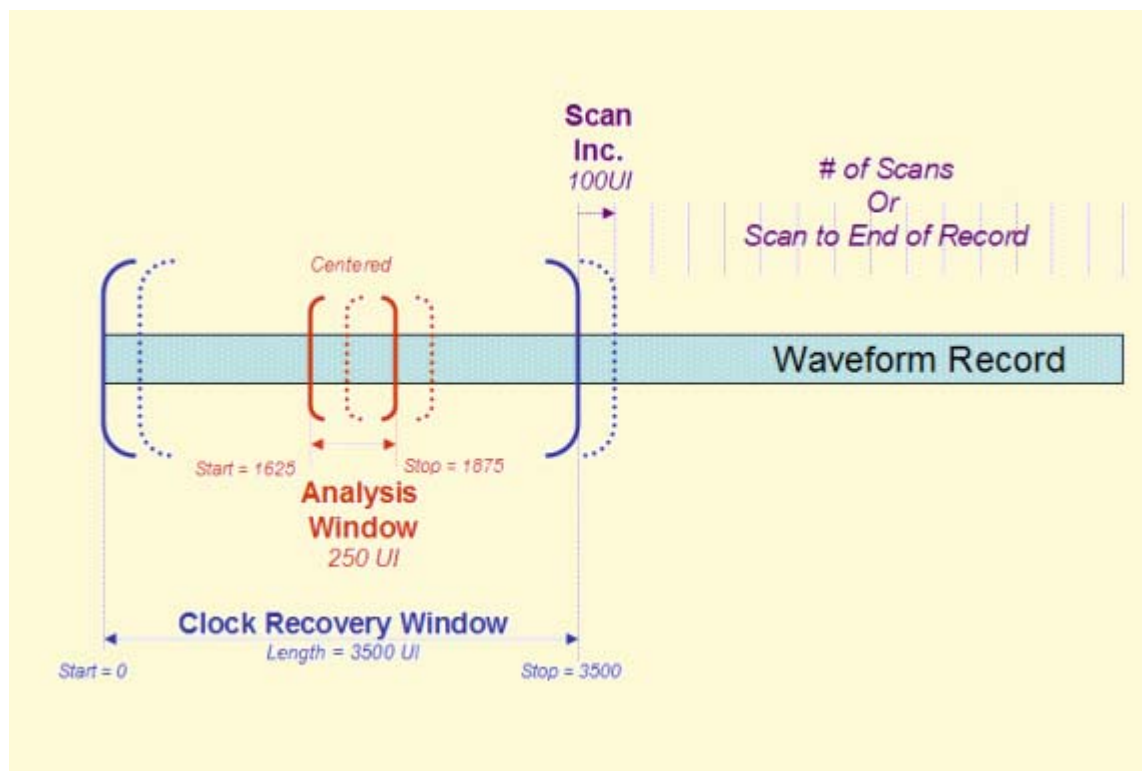

Figure 3-47: Smart gating diagram

## Clock Recovery Measurements

### Clock Recovery Methods

In serial data standards, jitter measurements are defined in several ways by working standards groups. To make the Time Interval Error (TIE) measurement, you need to first set the jitter reference clock (or ideal clock). All jitter measurements are based on TIE. To comply with industry standards, the RT-Eye application allows you to select various clock recovery methods, which can be generally categorized as either Constant-Clock (mean-squared best fit straight line) or PLL-based.

Whether the clock recovery method is PLL-based or not, you can specify a nominal bit rate to help the clock recovery process. This is especially helpful, for example, when the data pattern on the serial link can be interpreted as a different pattern at a lower rate. A data pattern of 110011001100... at 5.0 Gb/s looks exactly like a pattern of 101010... at 2.5 Gb/s. The application normally uses 2.5 Gb/s rate but you can also select the 5.0 Gb/s by enabling the Nominal data rate control and setting the bit rate.

### About Constant (Straight-Line) Clock Recovery

Constant (straight line) Clock Recovery can be applied to the measurements by selecting a Constant Clock Mean or Median method in the Clock Recovery tab. In Constant Clock Recovery, the clock is assumed to be of the form  $A \cdot \sin(2\pi ft + \phi)$ , where the frequency ( $f$ ) and phase ( $\phi$ ) are treated as unknown constants. Once a source waveform is acquired and the edges extracted, the clock frequency is selected using linear regression, so that the recovered clock minimizes the mean squared sum of the Time Interval Error (TIE) for that waveform.

If Constant Clock: Mean is selected as the clock recovery method, the phase  $\phi$  is also chosen to minimize the mean squared error. If Constant Clock: Median is used, the phase is chosen so that the median error between the recovered and measured edges is zero.

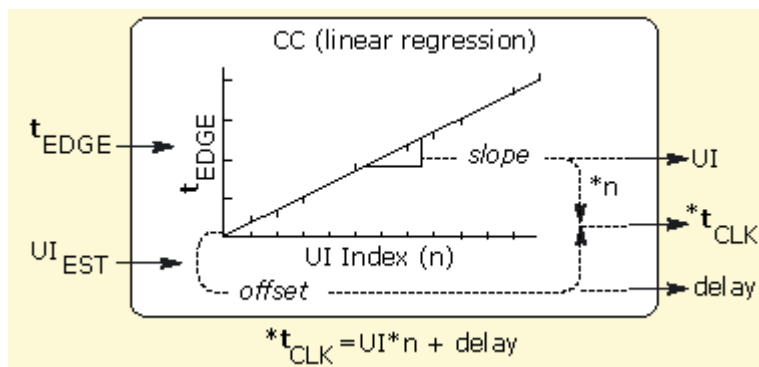

Figure 3-48: Constant clock recovery diagram

### About PLL-based Clock Recovery

When PLL-based clock recovery is selected, the application simulates the behavior of the hardware PLL clock recovery circuit. This is a feedback loop in which the voltage-controlled oscillator (VCO) is used to track or follow slow variations in the bit rate of the input waveform. Such loops are frequently used to recover the clock in communication links that do not transmit the clock as a separate signal. The PLL parameters in the application may be adjusted to synchronize with the behavior of a receiver in such a link, with certain guidelines.

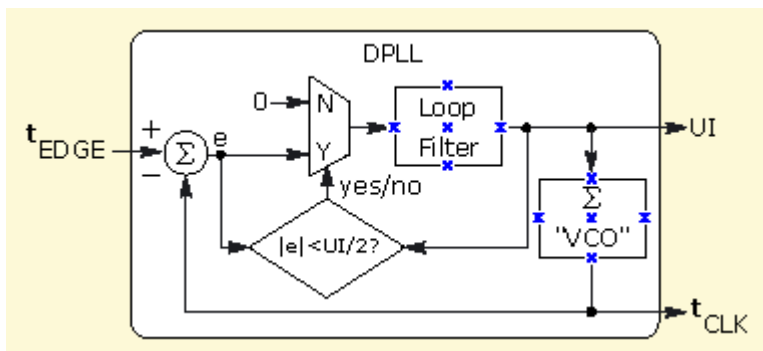

Figure 3-49: PLL-based clock recovery diagram

### PLL-based Clock Recovery Setup

If PLL-based clock recovery is selected, you can choose the loop bandwidth and the loop order. If a second-order loop is chosen, you can specify the damping factor. The loop bandwidth can be selected implicitly by specifying a data communications standard, or it can be set explicitly.

To set the loop bandwidth automatically, based on a serial standard, select PLL: Standard BW as the clock recovery method. From the Standard: b/s list box, select the standard that matches your data link. For example, choose "PCI-E: 2.5" to test a 2.5 Gbit/second PCI-Express link. The PLL bandwidth will be set to 1/1667 of the baud rate.

To manually control the loop bandwidth, select PLL: User BW as the clock recovery method and use the User BW control to select the 3 dB bandwidth of the loop, in Hertz.

You can use the PLL Order list box to choose between first-order and second-order loop. More correctly, this is the loop type, where a type 1 loop has a transfer function that approaches zero frequency with a slope of  $1/s$  and a type 2 loop approaches zero frequency with a  $1/s^2$  slope. The term Order is used in the application in line with popular usage. For a thorough discussion of loop type versus order, see *Frequency Synthesis by Phase Lock*, by William Egan.

If you choose a second-order loop, the Damping option is enabled. (The Damping Factor does not apply to first-order loops.)

---

*Note: Although it is possible to configure a second-order PLL with a bandwidth as high as 1/10 of the baud rate, such a loop will have poor dynamic performance. This is because second-order loops have less phase margin than first-order loops.*

---

### Clock Recovery Menu Options

**Table 3-18: Clock recovery menu options**

Area	Option	Description
Clock Recovery	Method	Selects an industry standard clock recovery method: Const Clk: Mean, Const Clk: Median, PLL: Standard BW, or PLL: User BW.
Nominal Data Rate	On/Off	Enables or disables bit rate guidance to the clock recovery algorithm.
	Bit Rate	Suggests the nominal bit rate. Helpful if data rate is ambiguous due to the data pattern (for example: "110011001100").
PLL Loop Bandwidth	Standard: b/s*	Implicitly sets the loop bandwidth of the clock recovery PLL, based on selection of the industry standard and data rate in bits/second.
	User BW**	Explicitly sets the loop bandwidth of the clock recovery PLL.
PLL	PLL Order	Selects between a first- or second-order phase-locked loop.
	Damping	For only second-order loops, adjusts the damping ratio of the loop.
* Only available when you use the PLL: Standard BW Method option.		
** Only available when you use the PLL: User BW Method option.		

### Configure Clock Recovery Menu

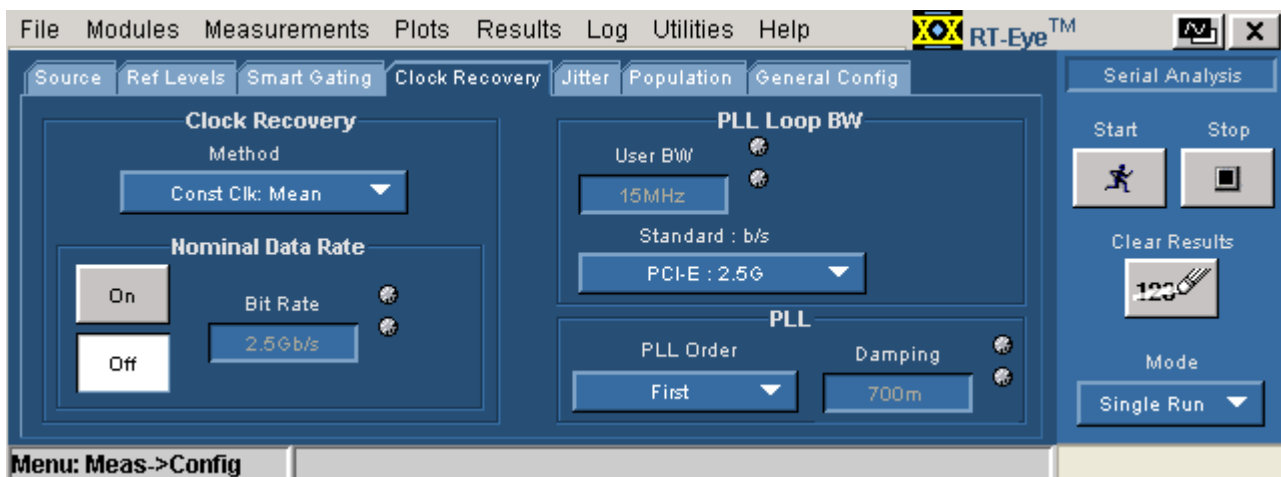

Figure 3-50: Configure clock recovery menu

## Jitter Measurements

### Jitter Measurement Methods

The basic jitter measurement is the Time Interval Error (TIE) measurement. TIE is a measure, on a cycle-by-cycle basis, of how far each edge differs in time from where the edge ideally should have occurred. In this context, "Ideal" is determined by the [clock recovery method](#). Apart from choosing and configuring the clock recovery method and reference levels, no specific setup is required for a TIE jitter measurement.

The advanced form of jitter analysis is jitter separation, also known as Rj/Dj analysis. This analysis breaks the timing jitter into various categories and uses the results to predict the total jitter at a selected bit error rate (BER). The RT-Eye application offers two methods of Rj/Dj analysis:

- A method based on spectral analysis that is appropriate for cyclic repeating data patterns
- A method that works for any arbitrary data pattern

### **Rj/Dj Analysis of Repeating Patterns Using a Spectral Approach**

This method of Rj/Dj analysis uses a Fourier transform of the time-interval error signal to identify and separate jitter components. It is described in the Fibre Channel - Methodologies for Jitter and Signal Quality Specification (MJSQ) and was the analysis method originally introduced with the RT-Eye application.

This method requires that the data signal be composed of a pattern of N bits that are repeated over and over. The pattern length (N) must be known, although it is not necessary to know the specific bits that make up the pattern.

### **RjDj Analysis of Arbitrary Pattern**

When the data pattern is not repeating, or is unknown, a second method of Rj/Dj analysis may be used. (It may also be used if the pattern is repeating, and correlates well with the Spectral method in this case.) This method assumes that the effects of Inter Symbol Interference (ISI) only last for a few bits. For example, in a band-limited link where a string of ones follows a string of zeros, the signal may require three or four bit periods to fully settle to the "high" state.

In this method, an analysis window with a width of K bits is slid along the waveform. For each position of the window, the time interval error of the rightmost bit in the window is stored, along with the K-1 bit pattern that preceded it. After the window has been slid across all positions, it is possible to calculate the component of the jitter that is correlated with each observed K-1 bit pattern, by averaging together all the observed errors associated with that specific pattern.

In the configuration menu for the arbitrary-pattern method, the Window Length field allows you to select how many bits are included in the sliding window. The window should include enough bits to encompass the impulse response of the system under test, usually 5 to 10 bits. A good practical test is to check whether increasing the window length causes any appreciable change in the jitter results; if not, the window length is effectively capturing all the ISI effects. The disadvantage of increasing the window length is that it uses more memory and slows the processing.

The configuration menu also includes a field for selecting what population of each K-1 bit pattern must be accumulated before the TIE associated with that pattern is considered accurate. Using a larger population means that more observations are averaged together, so that the variance of the measurement is reduced. Specifying a larger population has the disadvantage of requiring a longer measurement period before results can be calculated.

It may be necessary to sequence the instrument several times before enough statistics are accumulated to provide results.



The arbitrary pattern approach for measuring jitter may not be appropriate if there are very-long-duration memory effects in your data link. An example would be if there are impedance mismatch reflections that arrive long enough after the initial edge to fall outside the analysis window.

**Configure Jitter Menu Options**

**Table 3-19: Configure jitter menu options**

	<b>Option</b>	<b>Description</b>
Data Pattern	Type	Must be set to correspond to the data pattern on the serial link. Use Repeating for cyclically repeating patterns, and Arbitrary for any data content.
	Pattern*	Sets the repeating data pattern length automatically for various popular patterns.
	Length*	Sets the data pattern length explicitly if the Pattern list box is set to Custom.
	Window Length**	Sets the number of history bits over which the effects of DDJ can be monitored.
	Population**	Sets the required population of observations of each DDJ pattern that must be reached before the TIE caused by that pattern is deduced.
Rj/Dj	BER=10-e?	Sets the Bit Error Rate exponent, thereby setting the statistical level at which Total Jitter and Eye Opening are reported.
* Only available when you use Type = Repeating.		
** Only available when you use Type = Arbitrary.		

## Configure Jitter menu for Repeating patterns

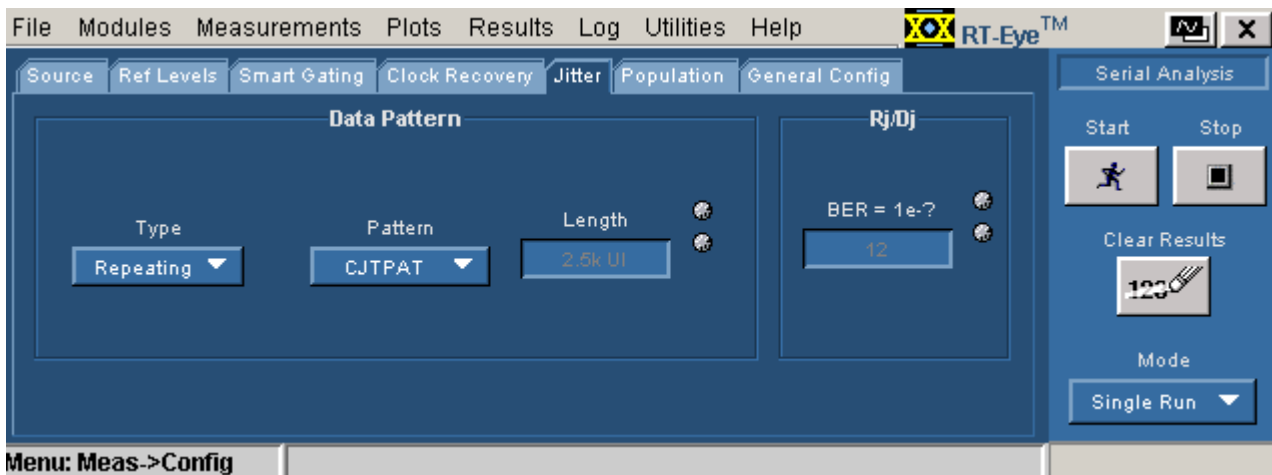

Figure 3-51: Configure jitter menu for repeating patterns

## Configure Jitter menu for Arbitrary patterns

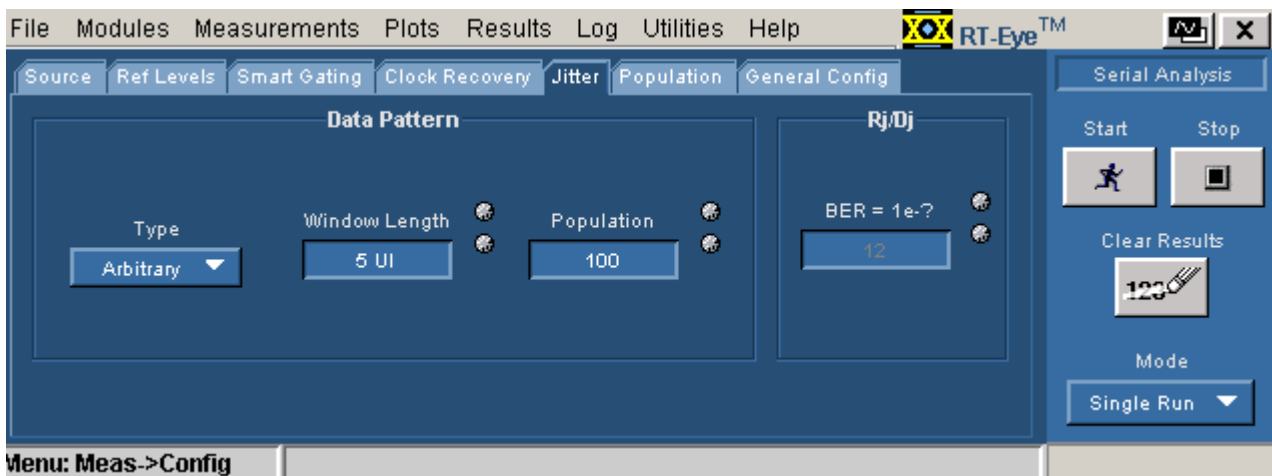

Figure 3-52: Configure jitter menu for arbitrary patterns

### Bathtub Curve: BER versus Decision Time

The Bathtub Curve plot shows the eye opening and total jitter values as functions of the BER level. The plot is obtained from the Rj/Dj separation that is automatically performed when a Jitter@BER measurement is executed.

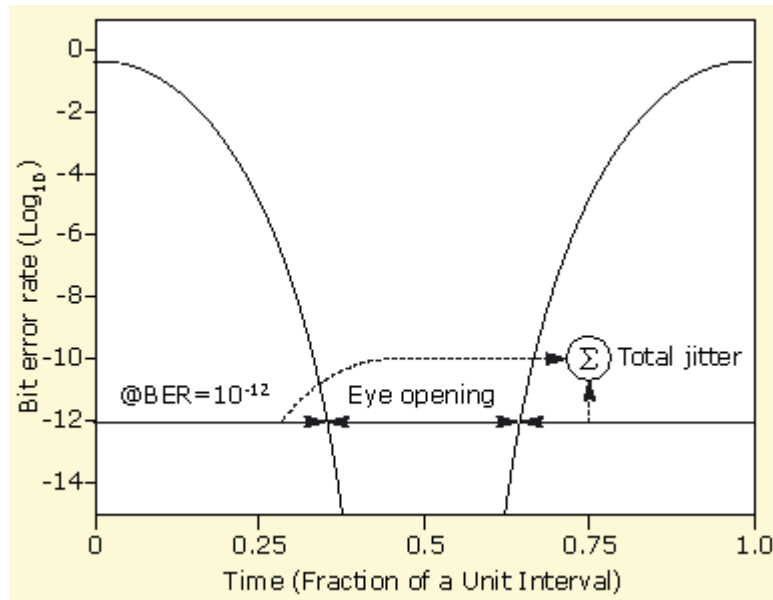

Figure 3-53: Bathtub Curve

## Population for Measurements

### Setting the Population for the Measurements

The Population control allows you to limit the amount of waveform data that is analyzed. This is often done in industry standards to make sure that there is consistency between measurement techniques. You can use the Configure Population menu to set a limit on a maximum population to obtain for all selected measurements. [View the Configure Population menu.](#)

To define the maximum population for measurements, follow these steps:

1. Select Measurements> Configure> Population> On.
2. Select Limit By and choose a waveform characteristic on which to base the population.
3. Select Limit and specify a population limit from one to one million.

If you use a population limit, Statistics individually accumulate for each measurement that reports the Current acquisition statistic to the population limit. A Free Run stops when all such active measurements reach the population limit.

An acquisition population limit applies to all active measurements; statistics will accumulate until the acquisition limit is reached.

You can use a population limit for a Single Run. If the limit is less than the normal population for that Single Run then the measurement statistics will stop at the limit.

**Configure Population Menu Options**

**Table 3-20: Configure Population menu options**

Area	Option	Description
Population Limit	On	Enables or disables the application from using a population limit while taking measurements.
	Off	
Configure	Limit By	Uses Acquisitions or Measurements to count the population.
	Limit	Specifies the maximum number of Acquisitions or Measurements the application takes before sequencing stops.

**Configure Population Menu**

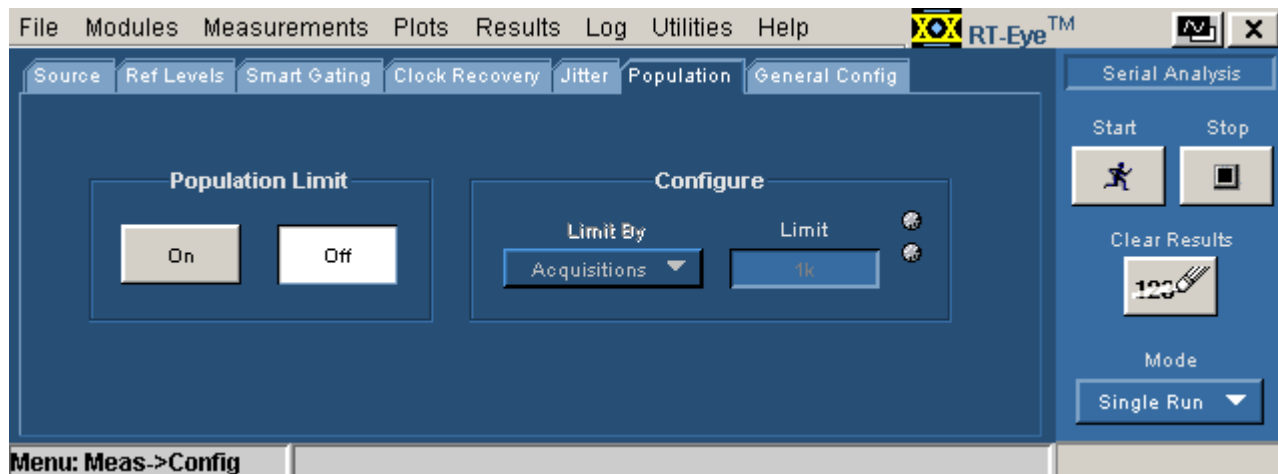

**Figure 3-54: Configure Population menu**

## General Config

The General Config control allows you to set rise, fall, and amplitude measurements either for transition bits or all bits. The transition bits refer to edge transitions for which the preceding transition was only one unit interval away. This may be important for signals with pre-emphasis, since the transition following a string of two or more like bits has an intentionally low swing that you may not want to measure.

You can also set the option to save maximum and minimum values of the worst case waveforms obtained during scan mode to files in the waveforms directory.

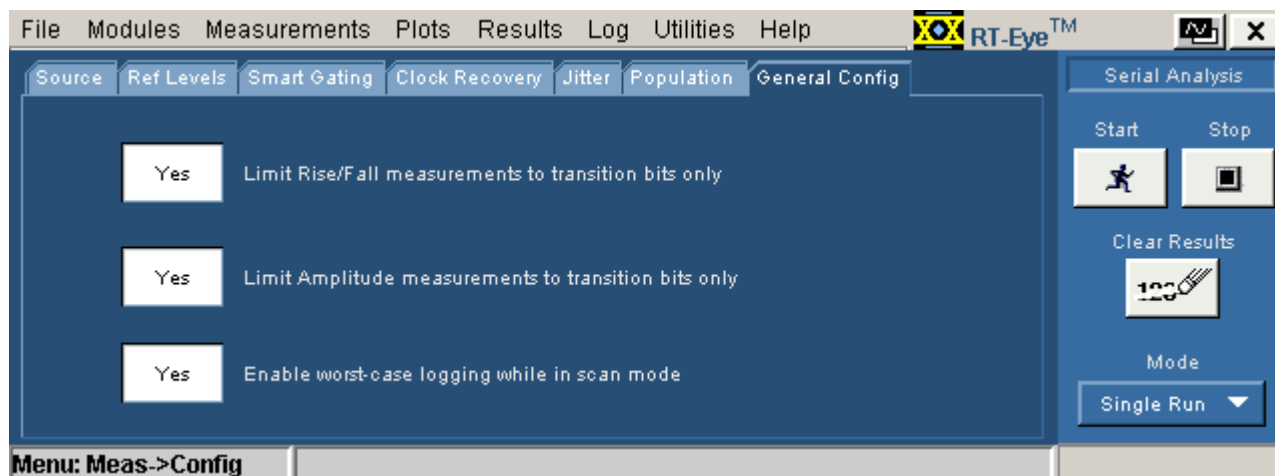

Figure 3-55: General config menu

Table 3-21: General config options

Option	Description
Limit Rise/Fall measurements to transition bits	Acquires and takes Rise Time/ False Time measurements only from transition bits; non-transition bits are not acquired.
Limit Amplitude Measurements to transition bits	Acquires and takes amplitude measurements only from transition bits; non-transition bits are not acquired.
Enable worst case logging while in scan mode	Enables or disables saving the maximum and minimum values of the worst case waveforms to files for each source.

## Measurement Limits

### About Using Measurements Limits File



Each serial data application provides a Limits file that includes combinations of all measurements and statistical characteristics, and an appropriate range of values for each combination. The application can use the Limits file and a mask file to determine the Pass or Fail status for compliance tests.

To test against a Limits file, you need to enable measurements limits checking, and enable a mask file in the Plots menus. [View the Measurements Limits menu.](#)

### Creating a Measurements Limits File

You can use the Limits File Editor functions to create a Limits file. The editor includes variable range options to suit your specific needs.

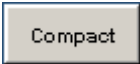

To create a Limits file, follow these steps:

1. Select Measurements> Limits.
2. Select . The Limits Editor window appears.
3. Select . The editor adds a measurement with None selected.
4. In the new row, select a Measurement, type of Statistic, a Lower Limit value and an Upper Limit value as appropriate. View an example of a Measurements Limits Editor window.
5. Select . The application verifies that the limits for each measurement are valid and that there are no duplicates.
6. Select . The application removes measurements where the selection is None.
7. Select File> Show Summary. View an example of a Show Summary list from the limits file.

The next time you select , the application compares the measurement results against the Limits file and the mask file, and then displays the status as Pass or Fail in the results menus.

### Editing a Measurements Limits File

You can use the Limits File Editor functions to edit an existing Limits file. To edit a Limits file, follow these steps:

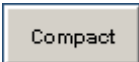
1. Select Measurements> Limits.
2. Select  and navigate to the directory where the Limits file resides.
3. Select a file, and then Open.
4. The selected file appears in the Limits Editor window.
5. Edit the file as necessary. To delete a measurement, select None.
6. Select . The application verifies that the limits for each measurement are valid and that there are no duplicates.
7. Select  to remove the rows where None is selected as the measurement.
8. Select File> Show Summary. View an example of a Show Summary list from the limits file.

### Measurements Limits Menu Options

**Table 3-22: Measurement limit menu options**

Area	Option	Description
Limits	On Off	Enables or disables the application from checking the measurements limits; when enabled, the application displays the results as Pass or Fail.
Limits File Editor*	Current	Edit the currently displayed Limits file.
	New	Create a new Limits file.
Limits File	Browse	Locate the directory and select an existing Limits file; you can use the virtual keyboard to enter a file name.
* Opens the Limits File Editor window.		

**Measurements: Limits Menu**

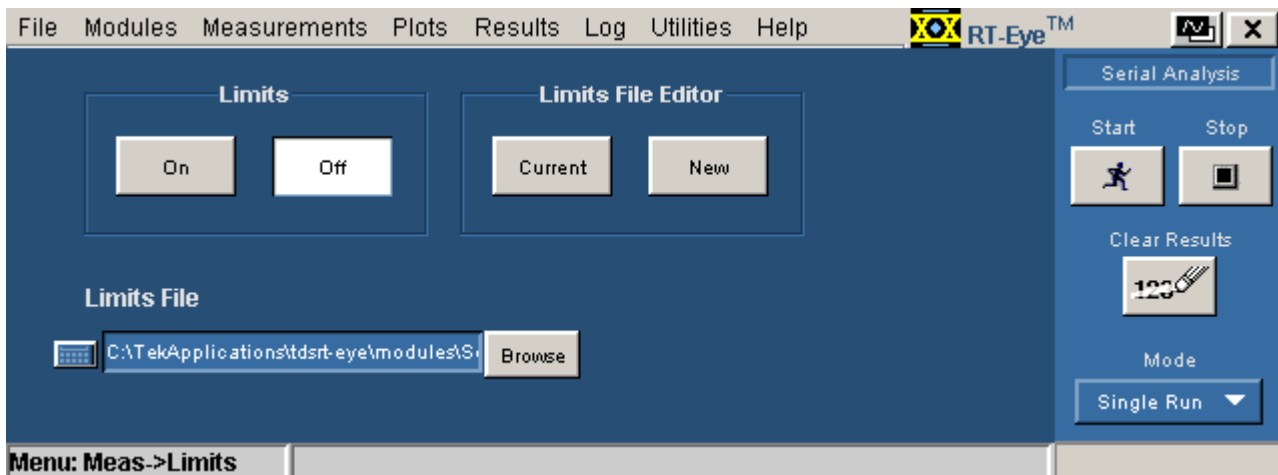

Figure 3-56: Measurement Limits menu

**Measurements Limits Editor Toolbar Functions**

Table 3-23: Measurement limits editor toolbar functions

Tool/option	Description
New	Opens a new file.
Open	Opens an existing file.
Add	Adds a measurement and associated limits.
Clear All	Deletes all measurements.

**Measurements Limits Editor Menu Options**

Table 3-24: Measurement limits editor menu options

Tool/option	Description
Compact	Removes measurements where None is selected.
Validate	Verifies that limits are valid, such as an upper limit cannot be lower than a corresponding lower limit.
Save As	Opens a Save File dialog box.
Cancel	Discards changes and closes the Limits Editor window.



Measurements: Limits Editor Menu

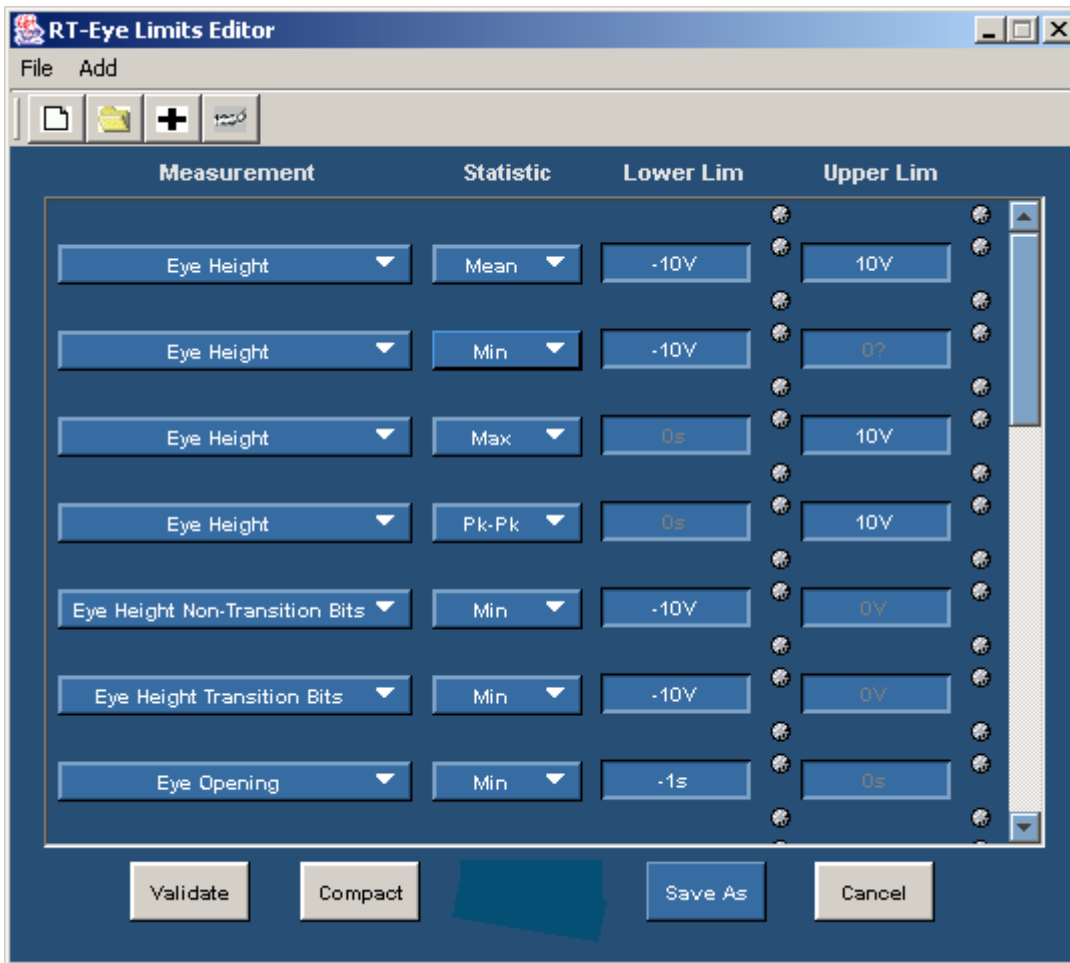
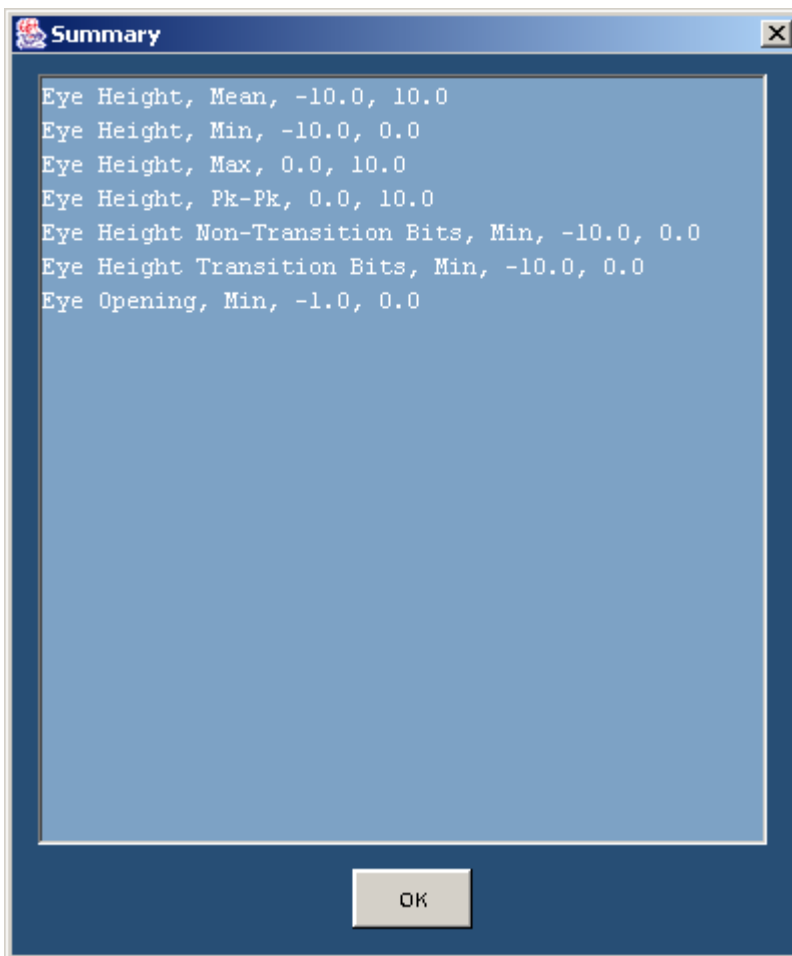

Figure 3-57: Measurement limits menu

**Measurements Limits File Summary****Figure 3-58: Measurement limits file summary**

## User Masks

### About Using Standard Masks

You can use masks based on serial data standards for compliance testing of DUTs.

Industry standard masks are available from the file browser in the Plots Configure menu (for an Eye Diagram plot). The mask files are selected from the following directory:

C:/TekApplications/tdsrt-eye/Examples/Masks

The standards supported are as follows:

- InfiniBand
- PCI Express
- Ethernet (Including XAUI)
- 1394B
- Fibre Channel
- FB-DIMM
- Serial ATA
- SAS (Serial Attached SCSI)
- Serial Rapid IO

You can edit a mask file to create a custom user mask through one of the following methods:

- Using the User Mask File Editor available in the Mask menu (if enabled) in your oscilloscope
- Manually using a text editor

**Using the User Mask File Editor**

To edit a mask file with the User Mask File Editor of the oscilloscope, follow these steps:

1. From the menu bar of the oscilloscope, select Masks> Mask Edit Setup.
2. Select the Recall button and navigate to the following directory:  
C:\TekApplications\tdsrt-eye\modules\SerialAnalysis\masks
3. Recall the user.msk file.
4. Follow the instructions in the online help of the oscilloscope to edit and save the file.

Mask File in the Oscilloscope Mask Editor

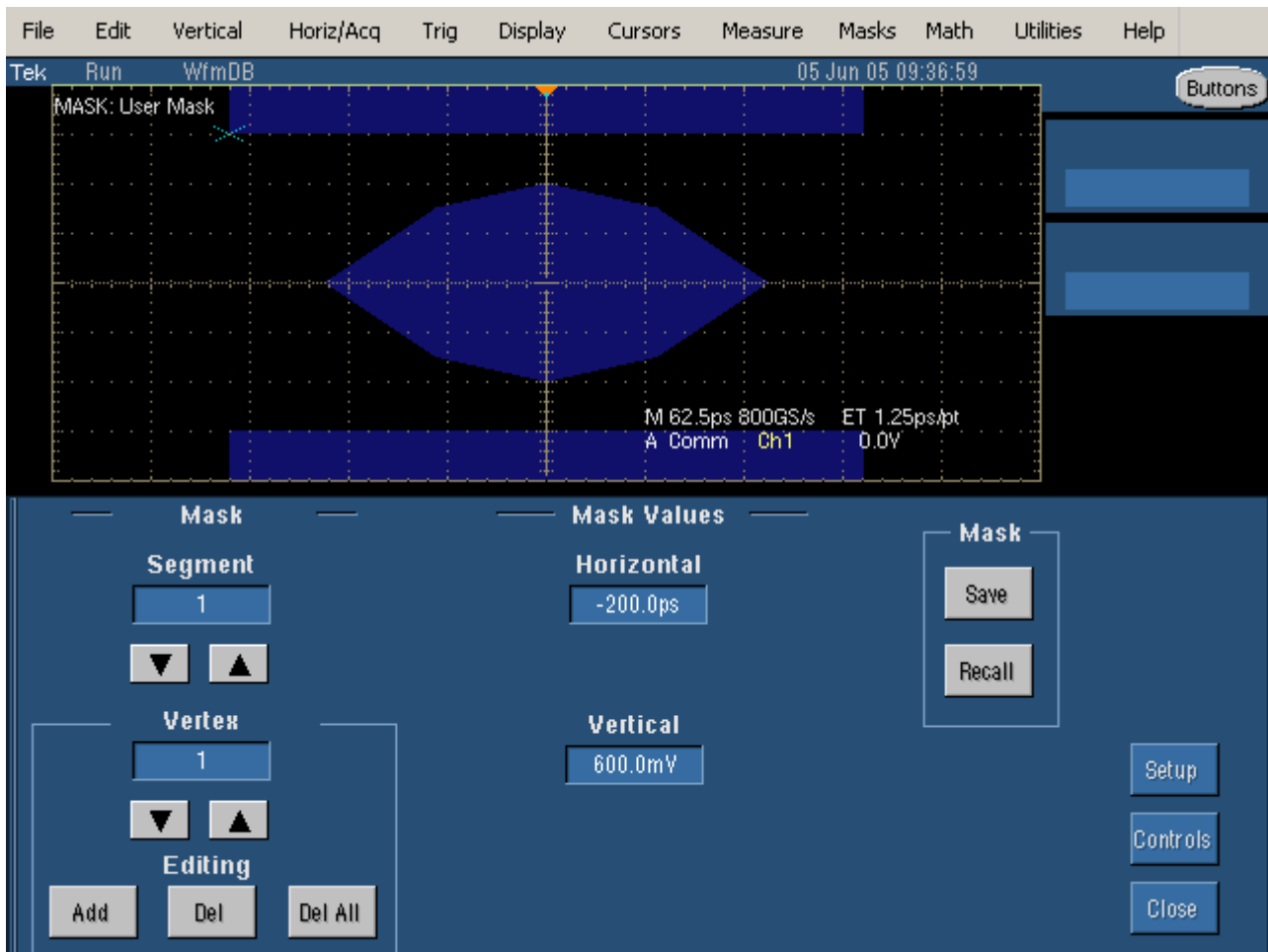

Figure 3-59: Mask file in oscilloscope mask editor

### Import of User Mask

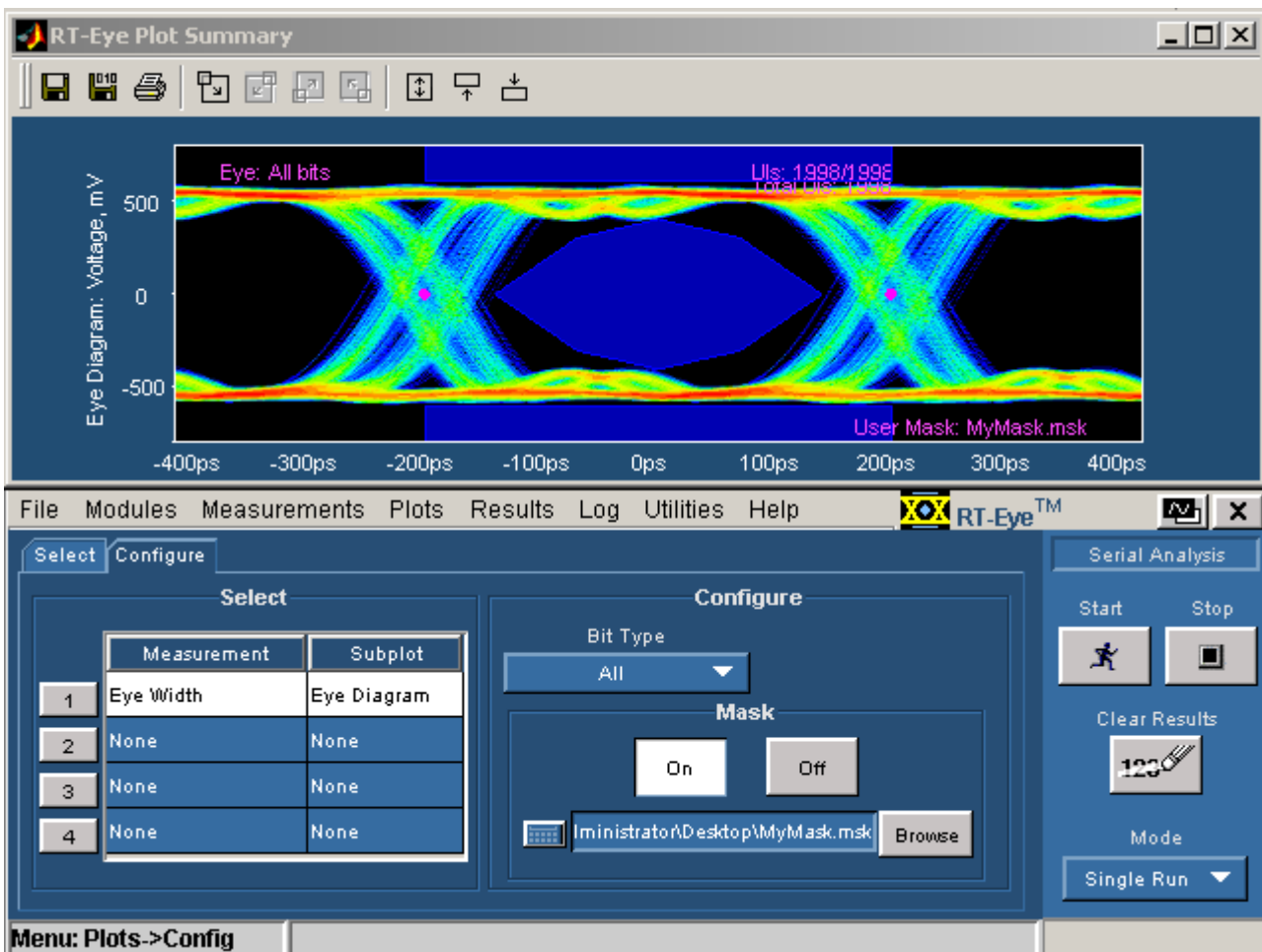

Figure 3-60: Import of user mask

### Manually Editing a Mask File

If you do not have a Mask Editor available in your oscilloscope, you can use a text editor to manually edit a mask file.

The User Mask File Opened in a Text Editor diagram shows an .msk file revised using the Mask Editor in a TDS7000 series oscilloscope. The diagram shows the fields used by the RT-Eye application in red boxes.

---

*Note: The application ignores all other fields. The mask file must contain SEG1, SEG2, and SEG3 fields for proper operation.*

---

To change the geometry of the mask, use a text editor to edit the following fields:

**Table 3-25: Mask fields**

Mask file field	Description*
MASK: USER: WID	Defines unit interval.
MASK: USER: SEG1: POINTS	Defines 1 <sup>st</sup> segment vertices in X,Y coordinates.
MASK: USER: SEG2: POINTS	Defines 2 <sup>nd</sup> segment vertices in X,Y coordinates.
MASK: USER: SEG3: POINTS	Defines 3 <sup>rd</sup> segment vertices in X,Y coordinates.
<b>* Where the X coordinate is in time (ps) and the Y coordinate is in amplitude (V).</b>	

### User Mask File Opened in a Text Editor

This diagram shows the fields used by the RT-Eye application in red boxes. You can edit these fields to change the geometry of the mask.

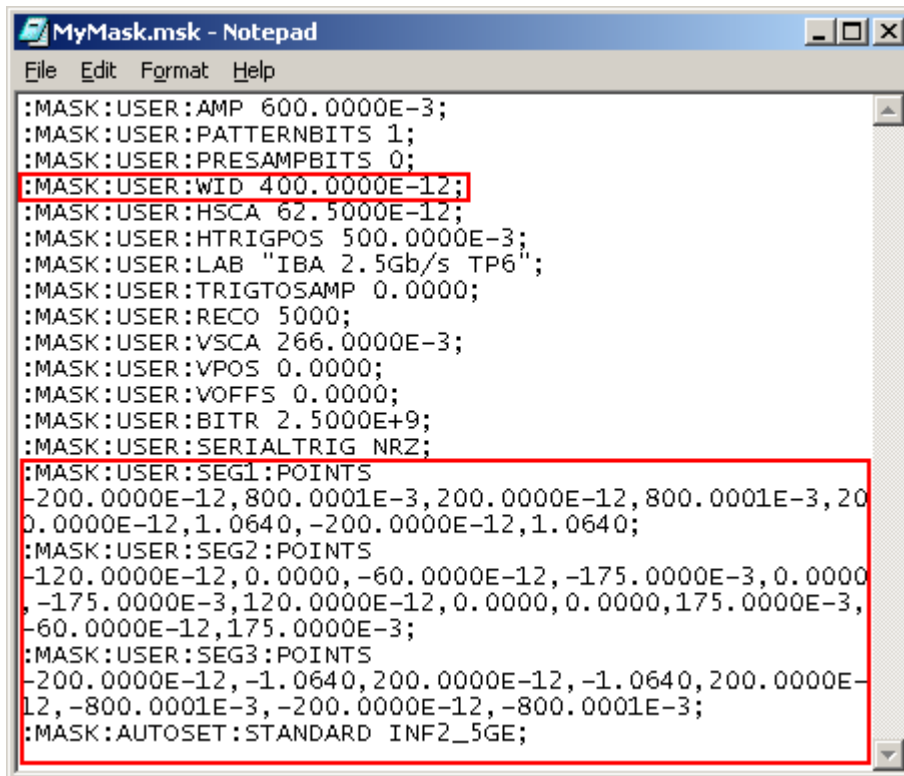

```
MyMask.msk - Notepad
File Edit Format Help
:MASK:USER:AMP 600.0000E-3;
:MASK:USER:PATTERNBITS 1;
:MASK:USER:PRESAMPBITS 0;
:MASK:USER:WID 400.0000E-12;
:MASK:USER:HSCA 62.5000E-12;
:MASK:USER:HTRIGPOS 500.0000E-3;
:MASK:USER:LAB "IBA 2.5Gb/s TP6";
:MASK:USER:TRIGTOSAMP 0.0000;
:MASK:USER:RECO 5000;
:MASK:USER:VSCA 266.0000E-3;
:MASK:USER:VPOS 0.0000;
:MASK:USER:VOFFS 0.0000;
:MASK:USER:BITR 2.5000E+9;
:MASK:USER:SERIALTRIG NRZ;
:MASK:USER:SEG1:POINTS
-200.0000E-12,800.0001E-3,200.0000E-12,800.0001E-3,20
0.0000E-12,1.0640,-200.0000E-12,1.0640;
:MASK:USER:SEG2:POINTS
-120.0000E-12,0.0000,-60.0000E-12,-175.0000E-3,0.0000
,-175.0000E-3,120.0000E-12,0.0000,0.0000,175.0000E-3,
-60.0000E-12,175.0000E-3;
:MASK:USER:SEG3:POINTS
-200.0000E-12,-1.0640,200.0000E-12,-1.0640,200.0000E-
12,-800.0001E-3,-200.0000E-12,-800.0001E-3;
:MASK:AUTOSET:STANDARD INF2_5GE;
```

Figure 3-61: User mask file opened in text editor



### Creating a New User Mask File

If need be, you can create a new User Mask file using a text editor. This is an alternative to editing an existing mask. To do so, follow these steps:

1. Create a new file using a text editor.
2. Enter User Mask information.
3. Save as a .msk file.
4. Recall the file in the Plots Configure menu.

### Mask File Edited Using a Text Editor Example

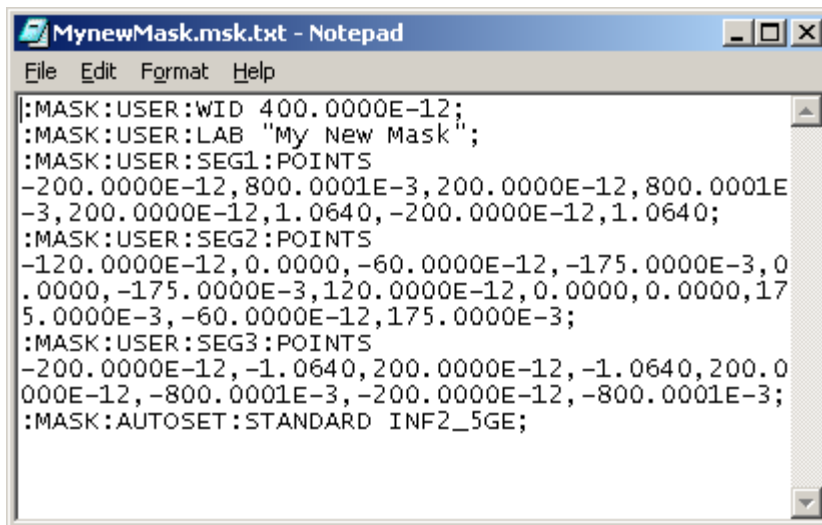

```

MynewMask.msk.txt - Notepad
File Edit Format Help
:MASK:USER:WID 400.0000E-12;
:MASK:USER:LAB "My New Mask";
:MASK:USER:SEG1:POINTS
-200.0000E-12,800.0001E-3,200.0000E-12,800.0001E
-3,200.0000E-12,1.0640,-200.0000E-12,1.0640;
:MASK:USER:SEG2:POINTS
-120.0000E-12,0.0000,-60.0000E-12,-175.0000E-3,0
.0000,-175.0000E-3,120.0000E-12,0.0000,0.0000,17
5.0000E-3,-60.0000E-12,175.0000E-3;
:MASK:USER:SEG3:POINTS
-200.0000E-12,-1.0640,200.0000E-12,-1.0640,200.0
000E-12,-800.0001E-3,-200.0000E-12,-800.0001E-3;
:MASK:AUTOSET:STANDARD INF2_5GE;
    
```

Figure 3-62: Mask file edited using a text editor

**Recalling a User Mask in the Plots Configure Menu**

To recall a User Mask file to the RT-Eye application, follow these steps:

1. From the menu bar of the RT-Eye application, select Plots> Configure.
2. Select On in the Mask area.
3. Select User as the Standard option.

## Taking Measurements

### About Taking Measurements

If you want to change trigger settings or localize the measurement, you should do so before you take any measurements.

---

*Note: If you select a reference waveform as the source, you need to recall and display the waveform on the oscilloscope before the application can take a measurement. To do so, refer to [recalling a waveform file](#).*

---

---

*Note: If an error message appears because there are not enough cycles from which to take a measurement, adjust the Horizontal setting on the oscilloscope to increase cycles.*

---

### **Localizing Measurements**

By specifying the trigger position, the starting point, and the length of the waveform, you can effectively filter out information that is not useful to analyze before taking a measurement.

To focus the application measurement on a part of the waveform, you can use the Configure Smart Gating menu. You can also adjust the Record Length, Scale, or pre-trigger information in the oscilloscope Horizontal menu, or the trigger level and slope in the Trigger menu.

You can also set up the File Preferences menu for the application to use only transition bits.

### **About Sequencing**

You use the Control Panel to start or stop the sequence of processes for the application and oscilloscope to acquire information from a waveform. The application then determines if the algorithm for the selected measurement can be applied to the waveform information. Sequencing is the steps to acquire waveform information, determine if the information is usable for the measurement, take the measurement, and display the results.

There are three Sequencing modes: Single Run, Single No Acq, and Free Run.

### Acquiring Data

To acquire data from waveforms and take measurements, follow these steps:

1. In the Control Panel (on the right side of the application display), select a Sequence mode.
2. The application uses the [Sequence mode](#) to acquire waveforms and take measurements when you select the Start command button. The choices are: Single Run, Free Run, and Single No Acq.
3. Select the  button for continuous acquisitions or for measurements on a new or existing acquisition.
4. If you select the Single Run or the Single No Acq mode, the application displays the results when the sequencing is complete.

If you select the Free Run mode or decide to stop sequencing,

select the  Stop button to stop the sequencing.

In Free Run mode, the sequencing also stops once the application has reached the limit set in the Configure Population menu.

---

***Note:** The application displays a status bar when it is busy sequencing. The status at the bottom of the Control Panel indicates Ready when the sequencing is complete. It may also indicate Stopping before indicating Ready.*

---

 **Tip** Use the  command button to delete all measurement results.

### Control Panel Functions

**Table 3-26: Control panel functions**

Command button	Description
Start	Start command button; use to start the sequencing based on the selected Sequence Mode.
Stop	Stop command button; use to stop the sequencing.
Clear Results	Clear Results command button; use to clear all previous results in the Results Summary menu, Results Details menu, Plot Summary window, and Plot Details window; data saved to files remains intact (.csv, .wfm files, etc).

### Sequence Mode Option Definitions

**Table 3-27: Sequence mode option definitions**

Mode	Description
Single Run	Acquires a new waveform if the source is Ch1, Ch2, Ch3, or Ch4; for all sources, the application sequences until complete and displays the results or plots (if set up).
Single No Acq	Recalculates the selected measurements without acquiring new data and displays the results or plots (if setup).
Free Run*	Continuously acquires waveforms and sequences until you select the Stop command button.
<b>*Sequencing stops when the sequencing reaches the population limit; plots display (if set up and enabled) when you select Stop.</b>	

### Chunking/Scan mode behavior of Eye Plot

In this mode, the waveform is analyzed from the Start value to the Stop value configured in Smart Gating tab. The number of scans depends upon the scan increment and size of the window values. For example, if an eye diagram is selected, then the eye diagram plot keeps updating with new result for each window.

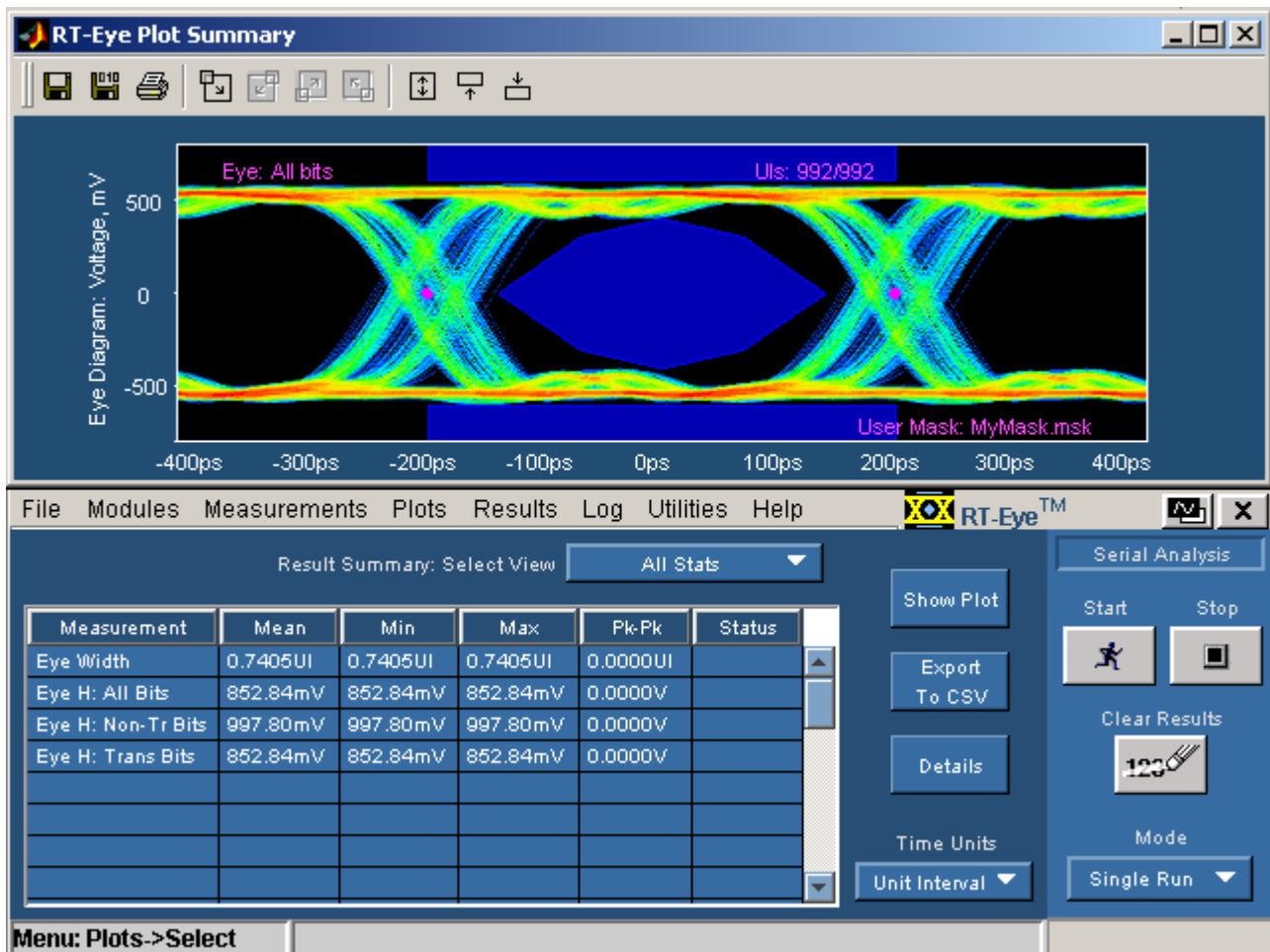

Figure 3-63: Scan mode behavior of eye plot

The RT-Eye application can be configured in different modes and the results vary accordingly. The modes are:

- Single shot, scan mode off
- Single shot, scan mode on
- Free run, scan mode on
- Free run, scan mode off

**Single shot, Scan mode off**

The application acquires and analyzes the entire waveform and then holds with the analyzed waveform on the oscilloscope display. The entire waveform (or the gated portion of the waveform, if cursor or smart gating is employed) is analyzed and the result is displayed in a single shot. For example, if an eye diagram is selected, then each data bit in the gated portion of the waveform appears in the center of the eye diagram exactly one time.

**Single shot, Scan mode on**

The application acquires and retains the entire waveform, and then analyzes the configured scan windows. After each scan window is analyzed, the results for that window are added to the cumulative results and the eye diagram, if displayed, accumulates the eye results from the latest window with all prior windows. Depending on the gating and scanning parameters, some bits in the waveform may not be analyzed or some may be analyzed two or more times. An option is available to select worst case results, in which case, the worst of all the scan windows analyzed is shown. An option is available to select worst case results in which case the worst of all the scan windows analyzed is shown.

**Free run, Scan mode off**

The application acquires the waveform, analyzes it, accumulates the results with any existing results, and refreshes all plots. The cycle repeats immediately. This continues until the Stop button is clicked or the population limit is reached.

**Free run, Scan mode on**

The application acquires the waveform and performs one analysis cycle on each scan window, thus updating the results and plots after each scan window. Once the configured number of scan windows has been analyzed, a new waveform is acquired and the measurement cycle is repeated. This continues until the Stop button is clicked or the population limit is reached.



**Control Panel**

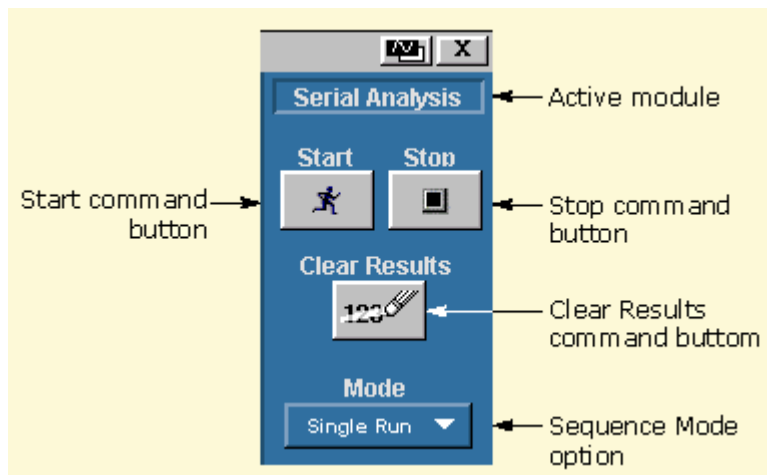

**Figure 3-64: Control Panel**

**About the Results**

There are two ways to view the results after an analysis is complete: statistical values or graphical plots.

If you enable the plots before taking measurements, the application shows the selected plots in a separate window in the oscilloscope part of the display. The application shows statistics in the application part of the display. When you use a Limits Module, the application also shows the results as Pass or Fail.

## Statistical Results

### About Viewing Statistics

There are two ways to view the statistical results of measurements: Results Summary Menu and Results Details Menu.

### Viewing Statistics

To view measurement statistics, select the Results Summary or the Results Details menu. The application displays results for the measurements of all acquisitions or for the current acquisition.

The Results Summary menu shows the current data and all acquisition data for each statistical value.

The Results Details menu contains statistical values for the following characteristics:

- Population
- Mean
- Standard deviation (StdDev)
- Maximum (Max)
- Minimum (Min)
- Pk-Pk

See the Results Summary menu for an example of the tabular listing of statistics of selected measurements.

See the Results Details menu for an example of details of selected measurements.

Results Summary Menu Options

Table 3-28: Result summary menu options

Option	Description
Select View	Bases the results summary on All Stats or Limits Status*.
(Table)	
Measurement	Lists selected measurements.
Mean	Lists a statistical value for the mean characteristic.
Min	Lists a statistical value for the minimum characteristic.
Max	Lists a statistical value for the maximum characteristic.
Pk-Pk	Lists a statistical value for the peak-to-peak characteristic.
Status	Displays if the measurement is Pass or Fail.
Show Plot	Updates and displays the Plot window, if enabled.
Export to CSV	Displays the Export to CSV file dialog where you can locate a suitable directory and enter an appropriate file name.
Details	Shortcut to the Results Details menu.
Time Units	Displays results in Unit Intervals, seconds, or the natural unit for the measurement, such as mV.

\* Only available when you enable measurement limits.

Results: Summary Menu

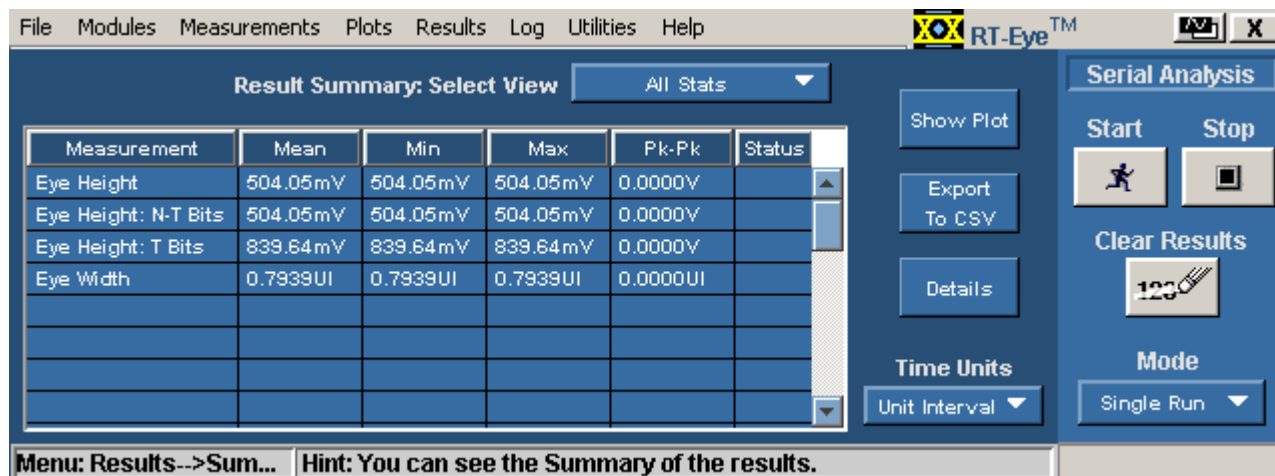

Figure 3-65: Results summary menu

### Results Details Menu Options

**Table 3-29: Results details menu options**

Option	Description
Select View	Displays details for the measurement selected as this option.
Show Plot	Displays the Plot window if enabled.
Export to CSV	Displays the Export to CSV file dialog where you can locate a suitable directory and enter an appropriate file name.
Summary	Shortcut to the Results Summary menu.
Time Units	Displays results based on Unit Intervals seconds, or the natural unit for the measurement, such as mV.

### Results: Details Menu

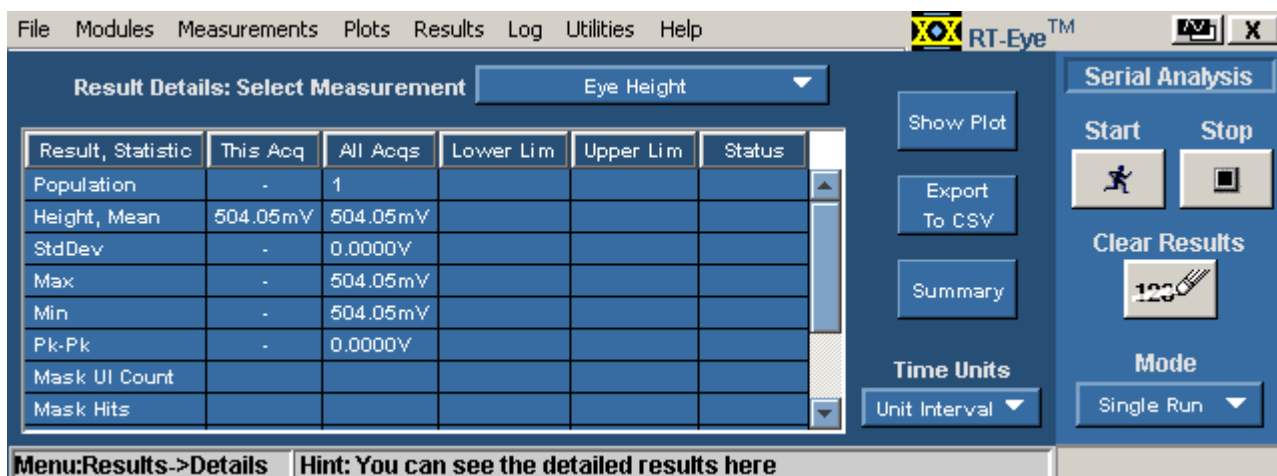



Figure 3-66: Results details menu

### **Saving Statistics to a .CSV File**

You can save the statistics to a "comma separated variable" file to import into a text editor, a spreadsheet, or an analysis tool. View the Results Summary menu or the Results Details menu.

To save the results summary or details to a "comma separated variable" (.csv) file, follow these steps:

1. Select either Results menu.
2. For the Results Details menu, select the measurement whose details you want to save from the Results Details Select View drop-down list.
3. For the Results Summary menu, Limits Status is only available if you enabled measurement limits before taking measurements.
4. Set the Time Units option to Seconds or to Unit Interval. To save both types of information, you need to save two .csv files.
5. Select the  button. The Save browser opens.
6. Enter a file name. The application appends the .csv suffix to the name.
7. Select the Save button to save the file.
  - If the oscilloscope is connected to a network, you can use the Explorer to move the file.
  - If the oscilloscope is not connected to a network, you can copy the file to a floppy disk.

## Plotting the Results

### About Plotting

The application can display the results as two-dimensional plots for easier analysis. Before you take measurements, you can set up the Plots Select and Plots Configure menus to define up to four plots. When enabled, the plots will display when the application completes sequencing.

The application uses MATLAB-based windows to display plots.

---

*Note: When taking measurements in the Free Run mode, you must stop the sequencing before you use the Plots Select or Plots Configure menus.*

---

---

*Note: Be sure to configure a printer before you print a plot.*

---

**Plot Type Definitions**

**Table 3-30: Plot type definitions**

Plot type	Description
Eye Diagram	Represents data for the eye diagram based on the recovered clock as the timing reference; used for mask testing.
Waveform with Bit Error Locator	Represents the acquired waveform. It is available for use with eye diagram mask tests to locate bit errors in the real-time waveform.
Histogram	Represents measurements sorted by value as a distribution of measurement values versus the number of times the value occurred.
Spectrum	Represents the frequency content computed using the FFT of the Time Trend plot.
Bathtub	Represents the Bit Error Rate versus the jitter eye opening for measurements that include Rj/Dj analysis.

**Measurements and Available Plots**

---

*Note: Measurements not listed are unsuitable for plots (Unit Interval, Differential Skew, Differential Voltage, High Amplitude, Low Amplitude, CM Voltage, and AC CM Voltage).*

---

**Table 3-31: Measurement and available plots**

Measurement	Eye Diagram	Histogram	Spectrum	Bathtub	Waveform
Eye Width/ Eye Height	Yes	No	No	No	Yes
Rise Time	No	Yes	No	No	No
Fall Time	No	Yes	No	No	No
Unit Interval	No	Yes	No	No	No
Bit Rate	No	Yes	No	No	No
Differential Skew	No	Yes	No	No	No
Differential Amplitude	No	Yes	No	No	No
De-Emphasis	No	Yes	No	No	No
Jitter@BER	No	No	No	Yes	No
TIE Jitter	No	Yes	Yes	No	No

### Plot Window Layouts

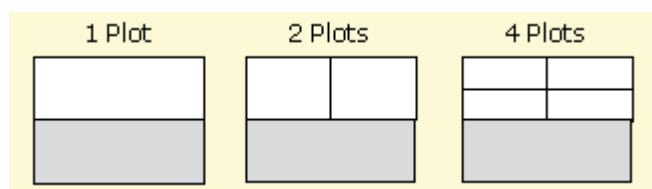

Figure 3-67: Plot window layouts

### Eye Diagram Plot Usage

The clock recovery used for Real-Time Eye (RT-Eye) rendering is software based. The ideal clock (jitter reference clock) is recovered from the serial bit stream. The actual locations of the rising and falling edges of the acquired waveform are then "rendered" with respect to the recovered clock, creating an eye diagram. The clock is recovered from a single waveform acquisition which means that trigger jitter is eliminated from the eye diagram.

If you use a CSA7000 series or a TDS6000/7000 series oscilloscope with Option SM, hardware (HW) clock recovery is also available through the Masks menu in the oscilloscope application. The HW clock recovery is based on phase-locked loop (PLL).

Eye diagrams created using HW PLL are called Equivalent Time (ET) eye diagrams and are susceptible to trigger jitter. The ET Eye diagram is useful as a first check of signal quality and for debug purposes. RT-Eye rendering provides high precision "de-jittered" eye diagram with a very small Jitter Noise Floor (JNF) required for compliance testing.



### RT-Eye (Real Time) Rendering

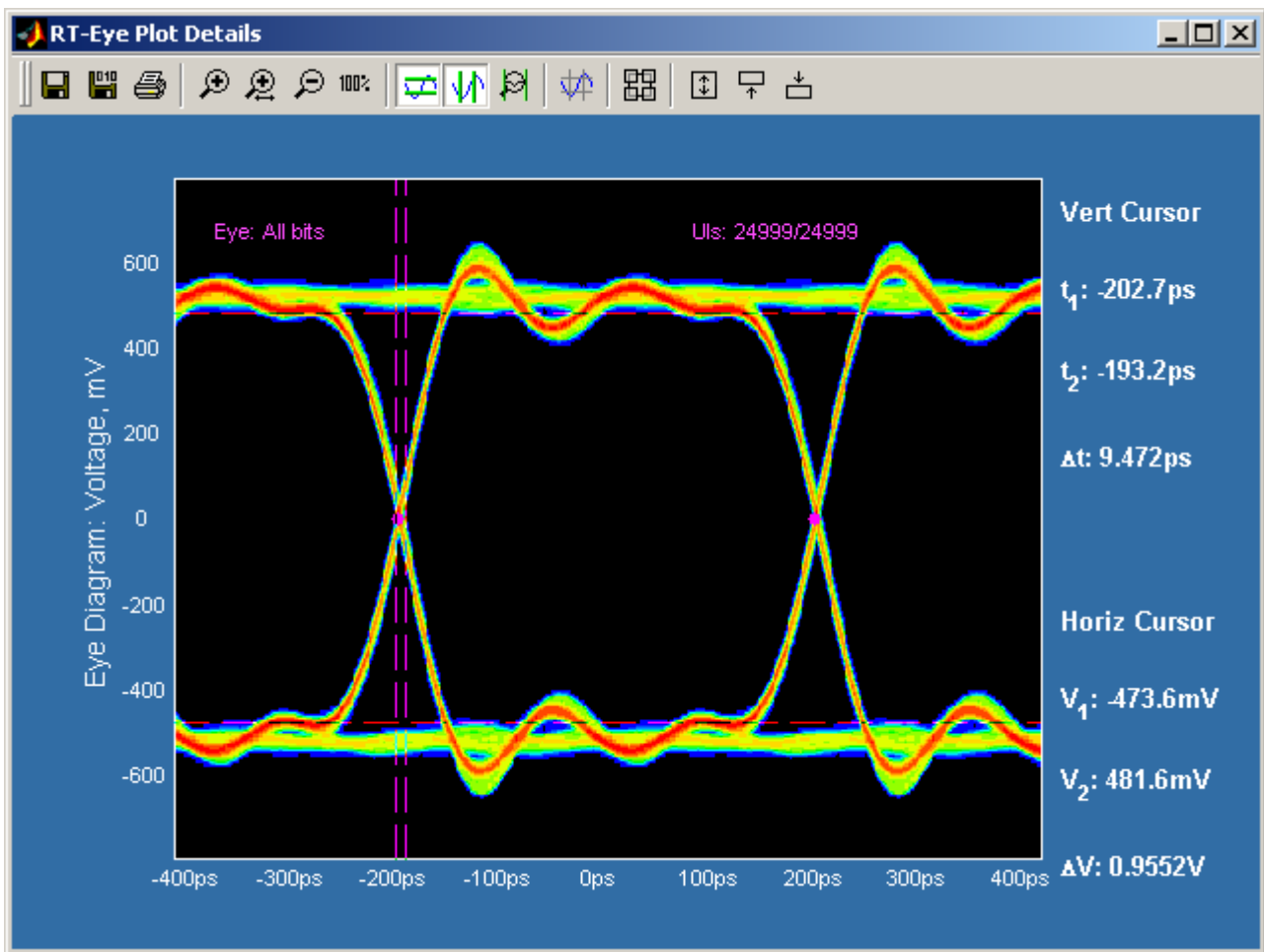

Figure 3-68: RT-Eye rendering

ET-Eye (Equivalent Time) Rendering

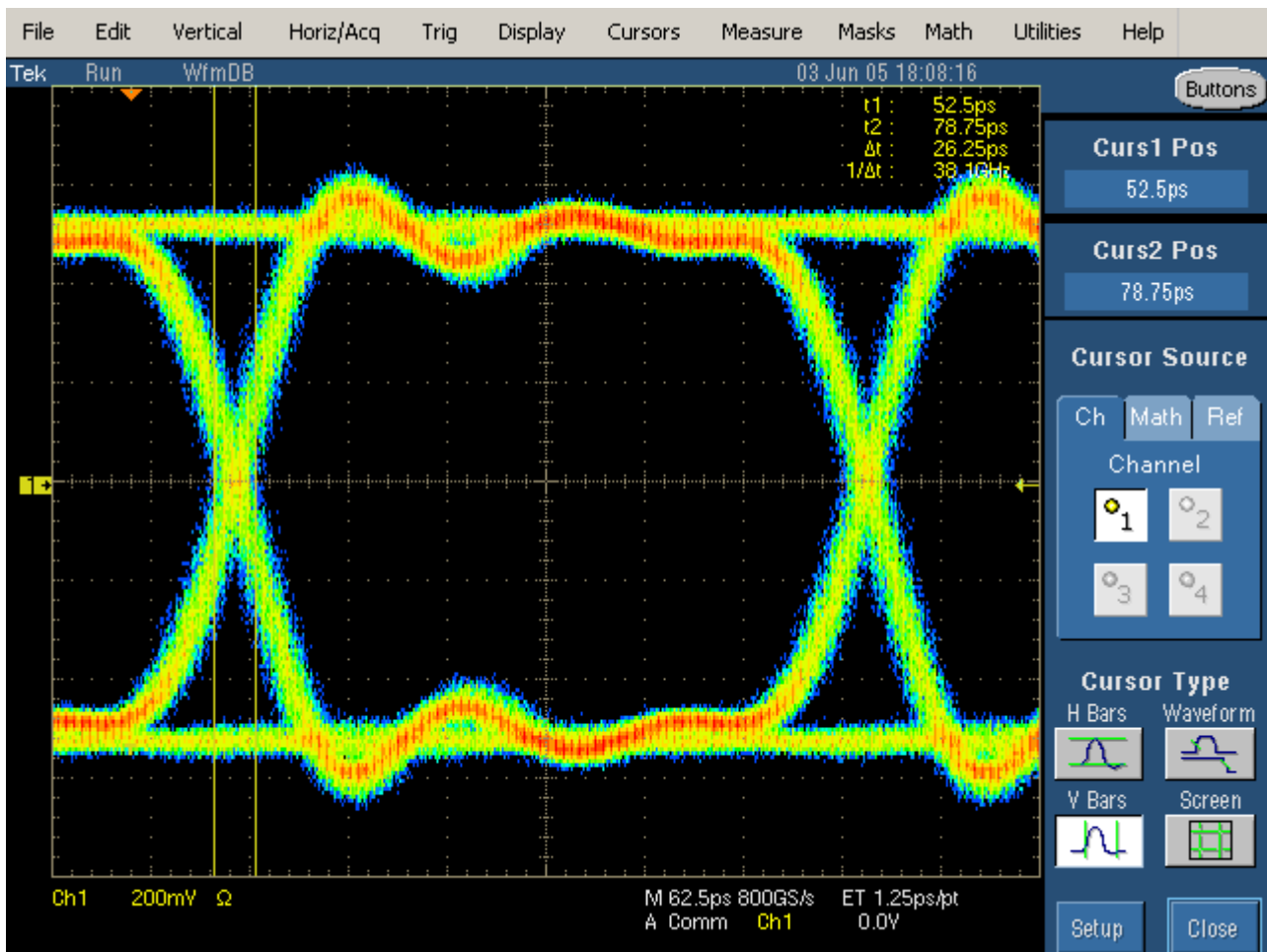

Figure 3-69: ET-Eye rendering

### Usage of Waveform with Bit Error Locator

You can find eye diagram mask failures on waveforms using the Bit Error Locator feature. The white on the mask shows waveform mask violations. The same violations can also be seen on pulse plot. The pulse plot shows the acquired waveform data similar to the oscilloscope screen. You can correlate the failures between the Eye Diagram and the waveform by looking at the red violations. From the waveform plot, and whether it failed on the rising or falling edge of the sample. This technique is useful for discovering data dependent behavior that may be causing bit errors. The waveform plot can be used in conjunction with the oscilloscope's waveform displays to time correlate failures due to crosstalk or power supply noise. For instance, Ch2 can be used to acquire the suspected offender signal and it can be compared to the serial data signal acquired on Ch1 for time correlation.

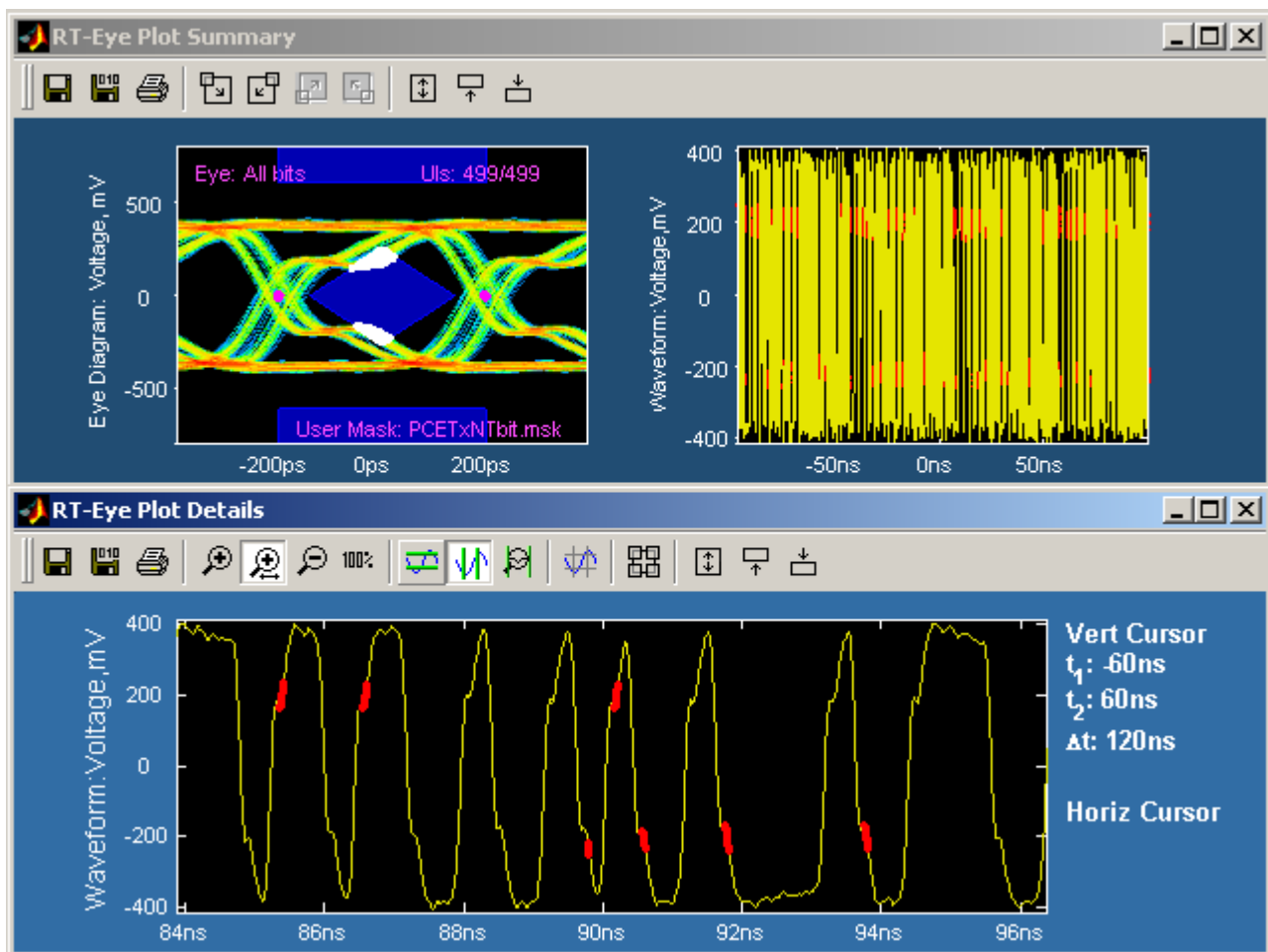

Figure 3-70: Waveform with bit error locator

### **Histogram Plot Usage**

Histogram plots display the results such that the horizontal axis represents the measurement values and the vertical axis represents the number of times that the value occurred. Unlike any other plot, a histogram plot accumulates measurements over multiple acquisitions, up to a total population size of 2.1 billion.

Histograms are particularly useful in analyzing jitter. A histogram of the Time Interval Error (TIE) represents the basis of jitter analysis using a histogram approach. In a histogram, Deterministic Jitter (Dj) is bounded in a system and shows up as a non-gaussian distribution. Random Jitter (Rj) is unbounded and amplitude will continue to grow the more population is acquired. The TIE histogram is a good first look analysis of jitter.

### **Spectrum Plot Usage**

A spectrum plot is the Fourier transform of measurement values versus time. This plot is useful in identifying frequency components that contribute to timing errors, such as modulation of the measurements. An example of where this is useful is plotting a "Jitter Spectrum". Jitter Spectrum is the FFT of the trend of time interval error. This reveals the frequency components of the output jitter.

Further analysis on the Jitter Spectrum can be used to separate Random Jitter (Rj) from Deterministic Jitter (Dj) as well as separate Dj components of Periodic Jitter (Pj) and other Dj components such as ISI and DCD. The frequency of periodic jitter spikes that do not correlate to frequencies contained in the data pattern can be a clue that you should look at frequencies of different components in your design as possible sources of jitter.

### Bathtub Plot Usage

Bathtub curves are the industry standard way of viewing the Jitter Eye Opening. A Bathtub curve represents a plot of the eye opening versus the BER (Bit Error Ratio). Most 8B/10B encoded copper standards call for Total Jitter to be measured at  $10^{-12}$  BER. The eye opening represented by the Bathtub Curve is what is left of the unit interval after the total jitter measurement is subtracted. A detailed discussion of bathtub analysis can be found in the MJSQ document at [www.t11.org](http://www.t11.org).

The Jitter Eye opening and the Total Jitter have the following relationship:

$$\text{Total Jitter} + \text{Jitter Eye Opening} = 1 \text{ Unit Interval}$$

## Selecting and Configuring Plots

### Selecting Plots for Configuration

Before you take measurements, you can set up plots in the Plots Select menu.

To select a plot to configure, follow these steps:

1. Select Plots>Select.
2. Select the On button.
3. Select a measurement in the Select Measurement column.
4. Select a plot type in the Select Subplot column.



**Tip** Use the  button as a short cut to the Measurements> Select menu.

**Plots Select Menu Options**

**Table 3-32:Plot select menu options**

Area	Option	Description
Select Subplot	Measurement	Select an active measurement to plot.
	Plot Type	Select the type of plot to depict.
Plots Display	On	Enables or disables the display of plots.
	Off	
Plots	Refresh	Updates the plot window when you deselect a plot or when you reselect a plot.

**Plots: Select Menu**

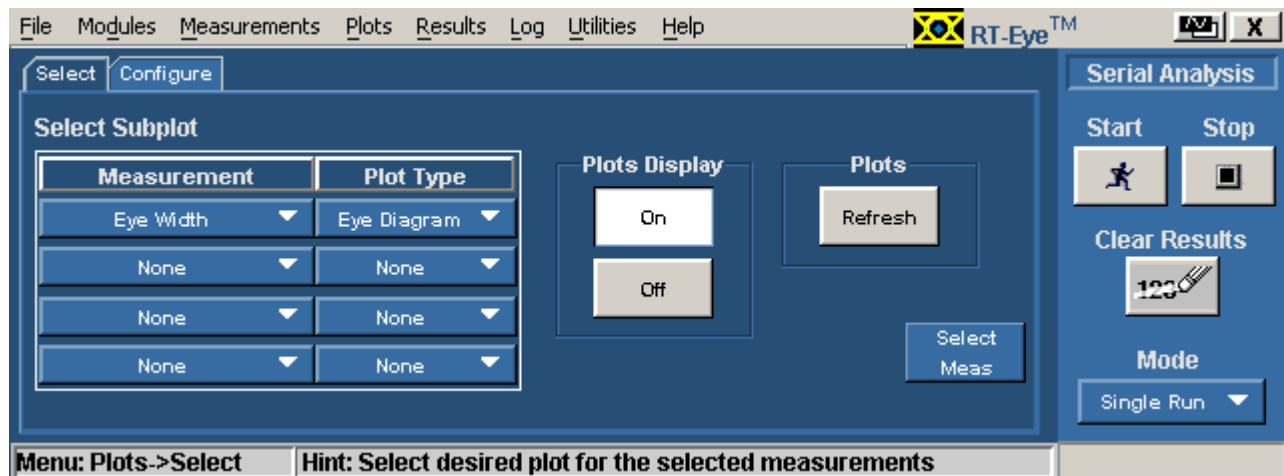

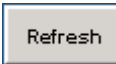

**Figure 3-71: Plots select menu**

### Configuring Plots

After you select the plots, you can further configure each measurement and plot combination. The options are relative to the selected plot type in the Subplot column.

To configure a plot, follow these steps:

1. Select the  tab.
2. Select a measurement in the Select Measurement column.
3. Select a plot type in the Select Subplot column. Plot options depend on the type of selected plot.
4. For the Eye Diagram plot, masks are available for many standards and you can create your own custom designed mask. For more information on User masks, refer to the [About Using User Masks](#) topic.
5. Configure the plot.
6. Select the  tab.
7. Select the  command button.

The Plot Summary Window updates and displays the selected plots. [View an example of the Plot Summary Window.](#)

Plots Configure Menu Options for an Eye Diagram

*Note: For more information, refer to [Eye Diagram Plot Usage](#).*

Table 3-33: Plots configure menu options for an eye diagram

Area	Option	Description
Bit Type	Transition	Renders an Eye Diagram only for transition bits.
	Non Transition	Renders an Eye Diagram only for nontransition bits.
	All	Renders an Eye Diagram for all bits.
Mask	On Off	Enables or disables the display and mask testing.
	Standard	Specifies a User-defined* mask or a mask based on a serial data standard, such as InfiniBand or PCI Express.
	Type**	Selects a type of mask specific to the selected standard; See list (receivers, cables, test points).
* Browse for a mask file to import from the <code>tdsrt-eye/Examples/Masks</code> directory.		
** Available when you select a serial data standard as the Standard option.		

Plots Configure Menu for an Eye Diagram

*Note: For more information, refer to [Eye Diagram Plot Usage](#).*

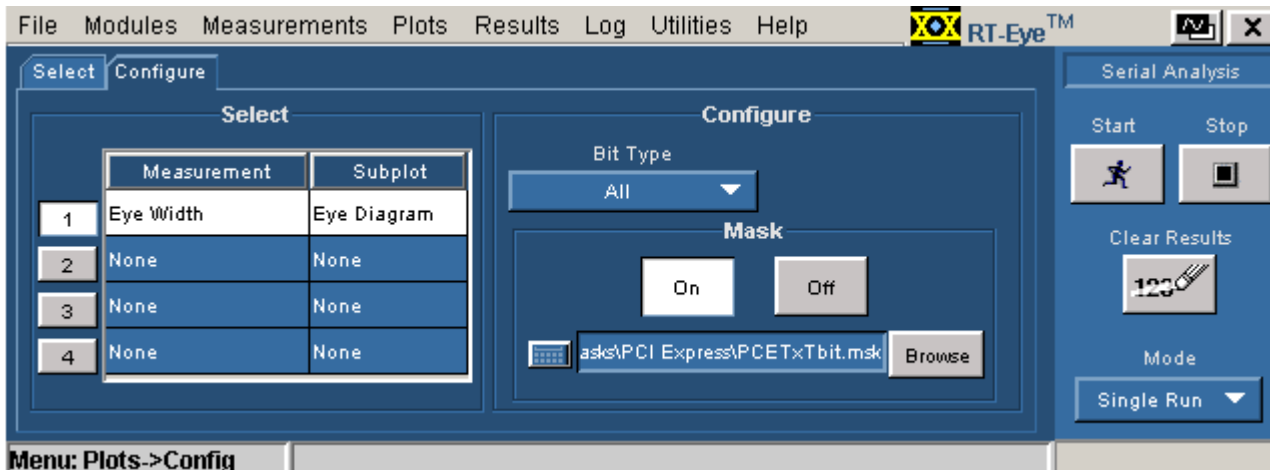

Figure 3-72: Plots configure menu for an eye diagram



**Plots Configure Menu Options for a Histogram**

*Note: For more information, refer to [Histogram Plot Usage](#).*

**Figure 3-34: Plots configure menu options for a histogram**

Option	Description
Vertical Axis	Sets the vertical axis in a linear scale (default) or in a logarithmic scale.
Bin Resolution	Defines resolution by time.

**Plots Configure Menu for a Histogram**

*Note: For more information, refer to [Histogram Plot Usage](#).*

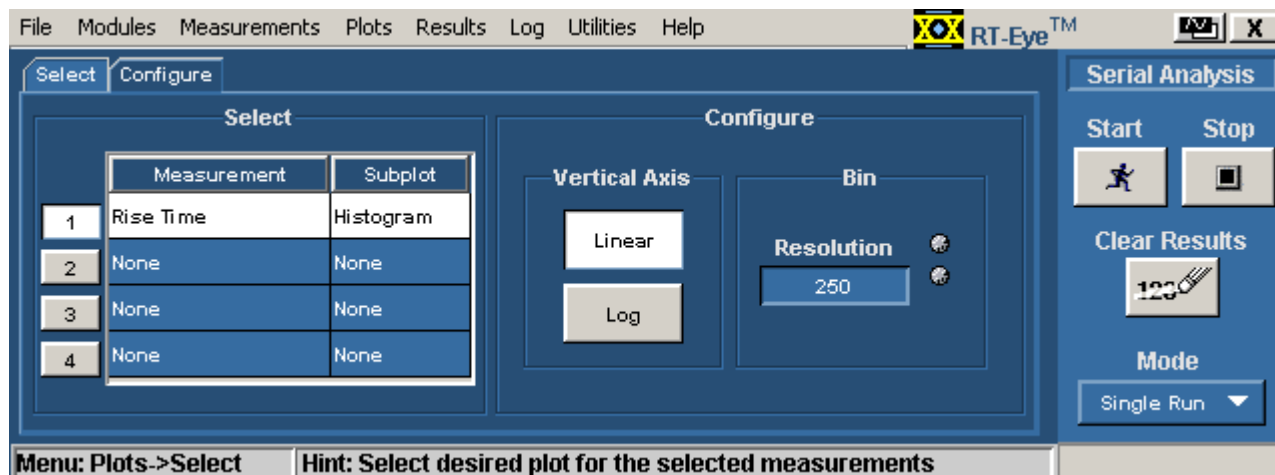

**Figure 3-73: Plots configure menu for a histogram**

**Plots Configure Menu Options for a Spectrum**

*Note: For more information, refer to [Spectrum Plot Usage](#).*

**Table 3-35: Plots configure menu options for a spectrum**

Option	Description
Vert. Scale	Depicts the vertical axis in a linear scale (default) or in a logarithmic scale.
Horiz. Scale	Depicts the horizontal axis in a linear scale (default) or in a logarithmic scale.

**Plots Configure Menu for a Spectrum**

*Note: For more information, refer to [Spectrum Plot Usage](#).*

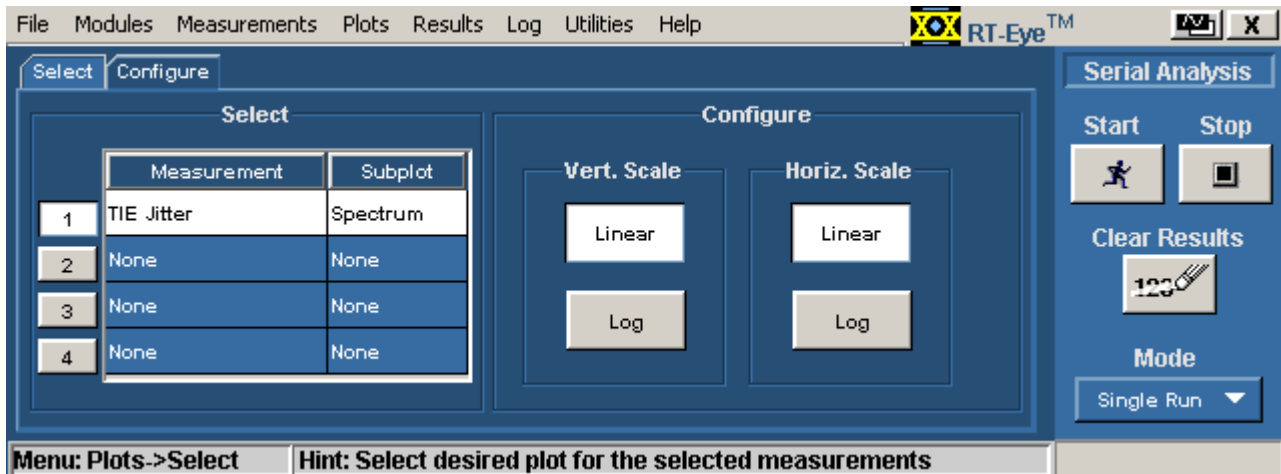

**Figure 3-74: Plots configure menu for a spectrum**

Plots Configure Menu Option for a Bathtub

*Note: For more information, refer to [Bathtub Plot Usage](#).*

Table 3-36: Plots configure menu option for a bathtub

Option	Description
Scale	Depicts both axes in logarithmic scale (default) or in linear scale.

Plots Configure Menu for a Bathtub

*Note: For more information, refer to [Bathtub Plot Usage](#).*

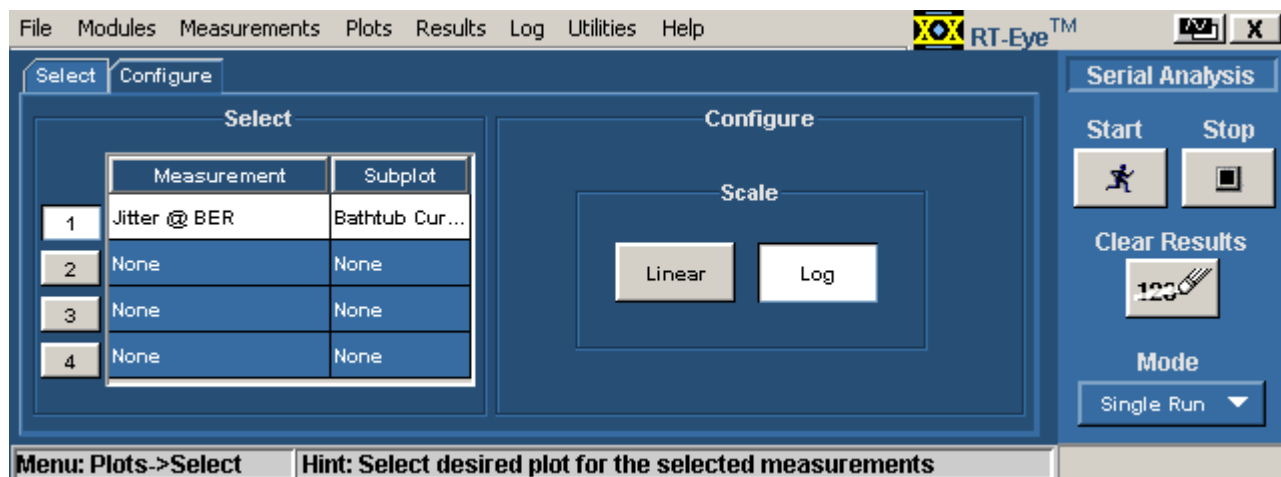



Figure 3-75: Plots configure menu option for a bathtub

## Viewing Plots

### About Viewing Plots

There are two windows you can use to view and analyze plots: Plot Summary and Plot Details. The application includes tools to help you size and position the window, display either window, and display the details of another plot directly from the details window.

After you select and configure a plot, select the  command button. When sequencing is complete, the Plot Summary Window appears with up to four plots. [View an example of a Plot Summary Window.](#)

If you reconfigure a plot and want to view the updated plot, follow these steps:

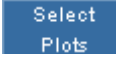
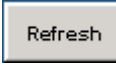
1. Select the  button.
2. Select the  command button.

The plots window updates according to any changes you made to the Plots Select or Plots Configure menus.

The Plot Details tools represent the plots by quadrant in the Plot Summary Window. [View Show Plot Details tools.](#) For example,

you can select the  tool to display details for the plot in the upper left quarter of the Plot Summary window. [View an example of a Plot Details Window.](#)

 **Tip** If you have a keyboard, you can use the alt-tab Window shortcut to quickly select a window for viewing.

 **Tip** If you have a second monitor, you can select and drag the title bar of the plot window to position it in the other monitor.

### Using a Separate Monitor to View Plots

If your oscilloscope setup includes a second monitor that extends the Windows desktop, you can select and drag the title bar of the plot window to position it in the second monitor. This allows you to simultaneously display a waveform on the oscilloscope, the RT-Eye measurement results, and the plot for easy viewing.

### Toolbar Functions in Plot Windows

The Plot Summary window includes the following toolbar:



The Plot Details window includes the following toolbar:

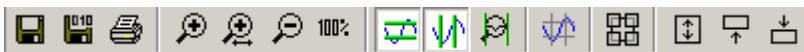

Some functions are specific to the Plot Summary window and others are specific to the Plot Details window. The next table lists the available functions in each type of plot window.

**Table 3-37: Plot details window options**

Tool icon	Function	Summary	Details
	Save	Yes	Yes
	Print	Yes	Yes
	View Details	Yes	No
	Size and position window	Yes	Yes
	Zoom	No	Yes
	Cursors	No	Yes
	Grid	No	Yes
	Return to Summary	No	Yes

### Plot Summary Window Example

This plot window includes save, print, view details, and size and position window functions.

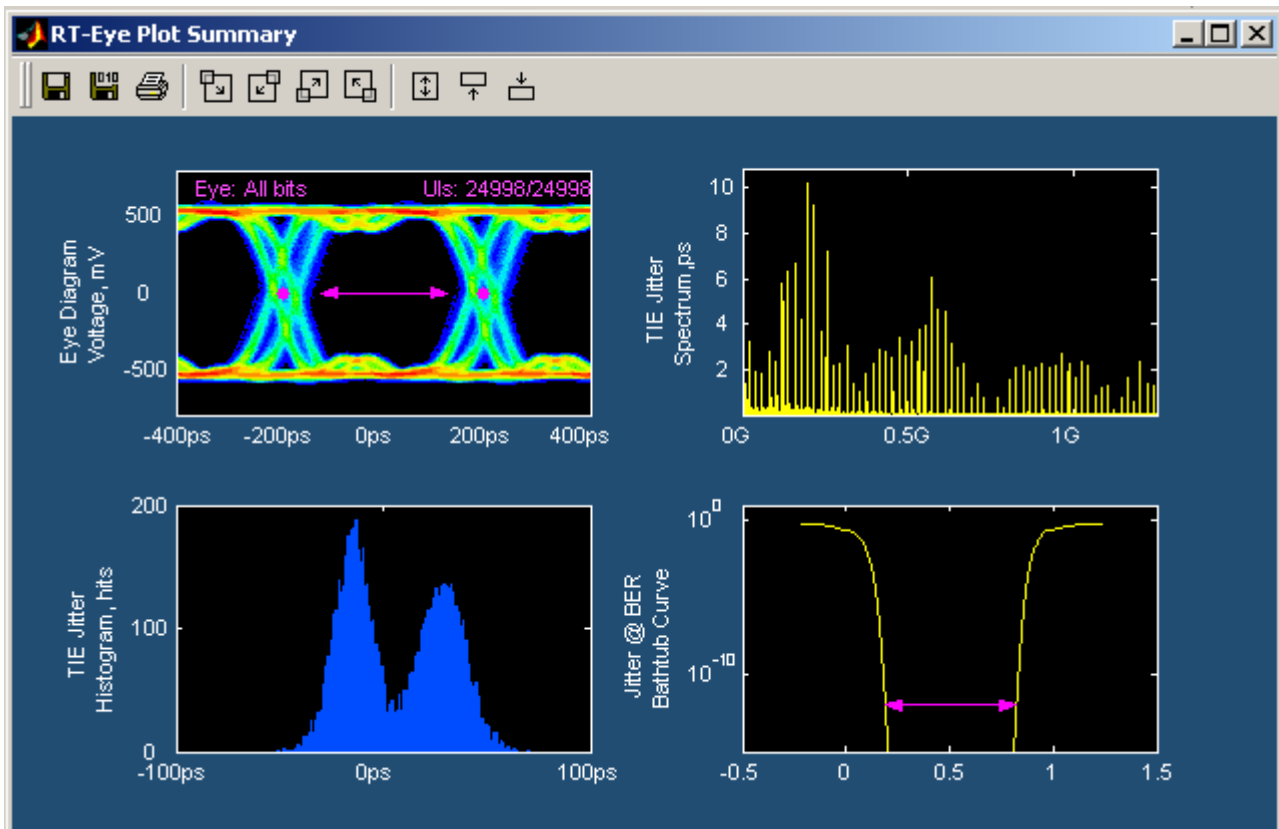

Figure 3-76: Plot summary window

### Plot Details Window Example

This plot window includes save, print, zoom, cursors, grid, view summary, and size and position window functions.

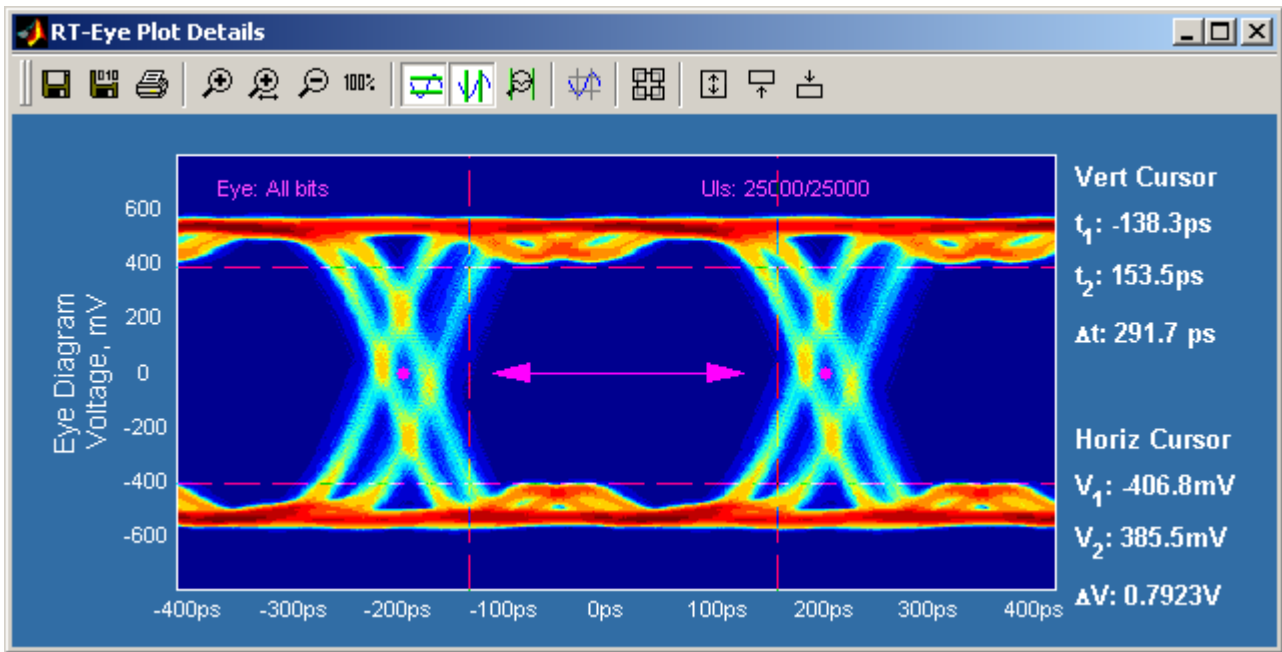

Figure 3-77: Plot details window

Plot Summary and Details Window Example

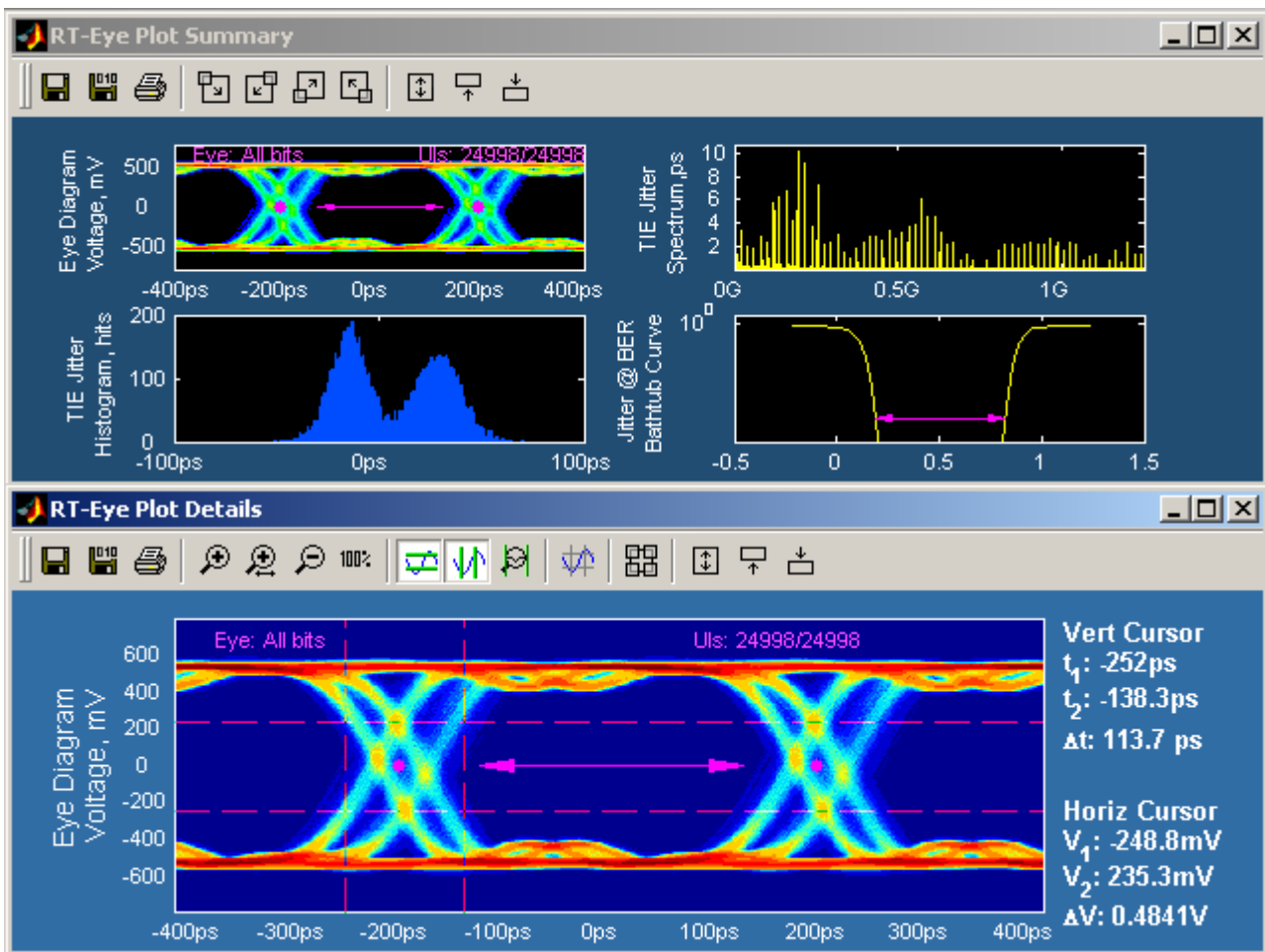





Figure 3-78: Plot summary and details window example



### Viewing a Plot in the Whole Display or in Half the Display

You can change the plot size to the whole display of the oscilloscope, or to half the display. When viewing a plot in half the display, you can position the plot in the upper or lower half.



-  enlarges the plot to fill the entire display
-  reduces the plot to half the display, if need be, and positions it in the upper half
-  reduces the plot to half the display, if need be, and positions it in the lower half

### Returning to the Plot Summary Window

To return to the Plot Summary window, select the  tool.

### Using Zoom and Cursors in a Plot

You can use the zoom and the cursors functions simultaneously in the Plot Details window. To do so, follow these steps:

- Select the  tool and draw a box around the area bound with the cursors.
- Use the cursors to take measurements.
- Repeat the previous steps if need be. You can zoom in by a magnification of 20X.
  
- Select the  and the  tools to display the horizontal and the vertical cursors.
- Move the cursors to bound the area you want to view more closely.

## Removing Plots

To remove a plot from a plot window, follow these steps:

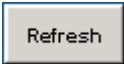

1. Select Plots> Select.
2. Select None for the measurement in the Select Measurement column.
3. Select the  command button.

The plot window updates and does not display the deselected plot.

## Using Zoom in a Plot

### About Using Zoom in a Plot





Once you have created a plot, you can use the Zoom tools in either plot window to examine the data at various scales. [View the Plot Zoom tools.](#)

 **Tip** You can quickly restore the view to display all the data. To do so, select the  tool.

 **Tip** If you prefer to move the cursors in the plot window with your finger, you can activate the Touch Screen on the oscilloscope.





### Plot Zoom Definitions

Table 3-38: Plot zoom definitions

Zoom type	Description
 In	Expands part of the plot; the data appears in more detail.
 Out	Contracts part of the plot; the data appears in less detail.
 X axis	Expands the horizontal axis only and retains the vertical axis.
 100%	Restores the plot to display all the data.

### Changing the Scale of Data in a Plot (Zoom)

To change the scale of the data in a Plot Details window, select one of the following plot zoom tools:



-  zooms in to expand the scale
-  zooms out to contract the scale
-  zooms in to expand the horizontal axis only
-  zooms in to restore all the data

When you select the  tool, you can use a select-drag-release action to expand part of the waveform (zoom in) by an arbitrary amount on both axes. After you select (touch with a finger or click with the mouse) and begin dragging, a bounding box shows what part of the waveform will be expanded upon release.

Select any part of the plot to expand the data by a factor of two (2X) equally on both axes. Double selecting expands the data to the maximum factor.

To contract an expanded part of the data (zoom out), select anywhere on the data. The view contracts to the values that existed before the most recent expansion of the data. Selecting multiple times will restore successively earlier views.

To expand the scale of the horizontal axis only by a factor of two (2X), click a part of the waveform. The plot retains the scale of the vertical axis.

 **Tip** You can quickly restore the view to the entire waveform. To do so, select the  tool.



## Using Cursors in a Plot

### About Using Cursors in a Plot

Cursors allow you to view numerical values associated with a plot based on cursor locations. There are two cursor modes: Horizontal-paired and Vertical-paired. Each mode displays two cursors. [View the Plot Cursor tools.](#)

### Plot Cursors Definitions



**Table 3-39: Plot cursors definitions**

Cursors type	Description
 Horizontal	Displays the vertical coordinate where each cursor touches the plot and the difference (delta) between the cursors.
 Vertical	Displays the horizontal coordinate where each cursor touches the plot and the difference (delta) between the cursors.
 Reset	Brings the cursors into the visible part of the plot.

### Using Cursors in a Plot

You can use cursors to read the coordinate where each cursor (line) touches the plot and also view the difference (delta) between the two cursors.

To use cursors in the Plot Details window, follow these steps:

1. Select one of the following cursor tools:
  - a.  to use Horizontal cursors
  - b.  to use Vertical cursors
  - c.  to bring the cursors into the visible plot
2. Select and drag either cursor to move the cursor to the desired part of the plot.

The cursor readout changes value to reflect the cursor position.

---

*Note: You can drag cursors only when the Zoom functions are disabled.*

---



**Tip** If you prefer to move the cursors in the plot window with your finger, you can activate the Touch Screen on the oscilloscope.

### Using Grid Points in a Plot

To display or remove cursor points in a Plot Details window,

select the  tool. Grids are not available in eye diagrams.

### Horizontal and Vertical Cursors in a Plot Example

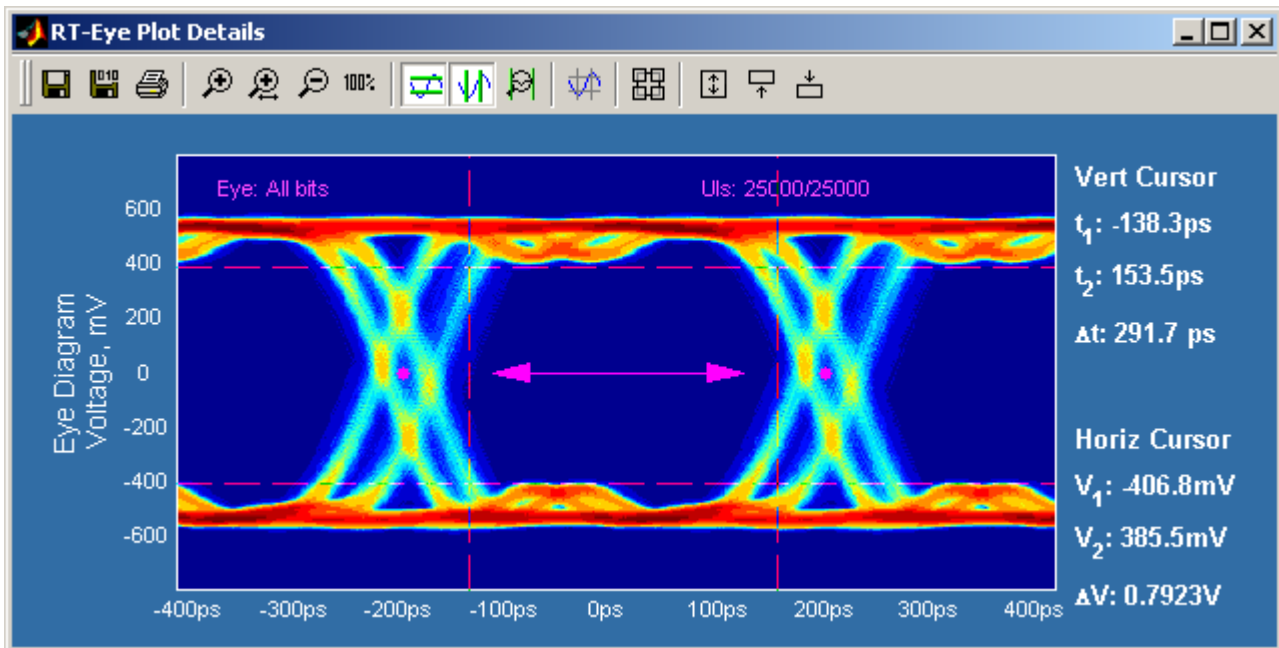

Figure 3-79: Horizontal and vertical cursors in a plot example



## Saving Plots to Files

### About Saving Plot Files

Both plot windows include the save plot file tools. However, the contents of saved plot files are dependent on the type of plot window: Summary or Detail. [View the Save Plot to a file command buttons.](#)



### Save Plot Files Definitions

Table 3-40: Save plot files definitions

File type	Description
 Graphic	Saves the contents of the plot window in the format you select from the list.
 Data	Saves the contents of the plot window as a binary .fig file.

### Saving Plot Files



To save a plot file, follow these steps:

1. Set up the plot window.
2. Select one of the following save plot file tools:
  -  to save the plot as graphic file
  -  to save a data file
3. Select the **Browse** button to select a directory and then enter a file name.
4. Select the **Save** button to save the plot file. The application saves the file.

## Printing Plots

### About Printing Plots

To send a plot to a printer, follow these steps:

1. Verify that a printer is configured.
2. Set up the plot window (with the zoom, cursor, or grid points functions).
3. Select the  tool.
4. The Plot Print dialog appears. [View the Plot Print Preview window.](#)
5. Select the  button and set up the options.
6. To customize the print of the plot, select the  tool.
7. The Page Setup menu that is a part of the MATLAB software appears. View the [Page Setup window](#)

---

*Note: The online help topics for the RT-Eye application do NOT describe how to use the MATLAB Page Setup menu. Refer to the MATLAB documentation for more information.*

---

Select the Print button to print the plot file. If you selected Print

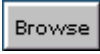
to File, use the  button to select a directory and then enter a file name. The application saves the file.



### Plot Print Preview Window

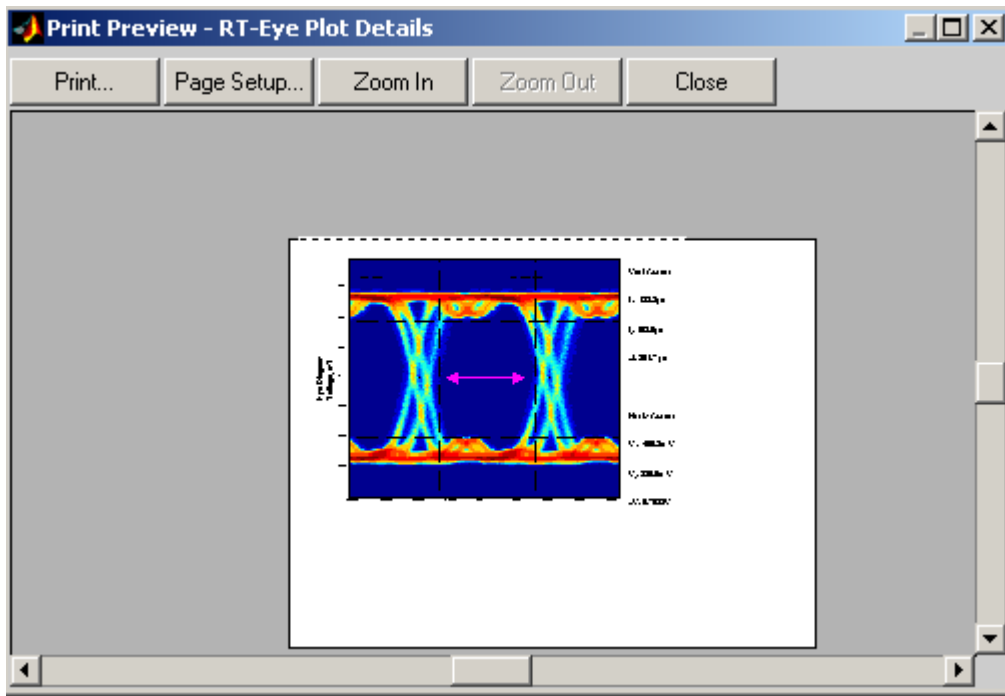

Figure 3-80: Plot print preview window

Plot Page Setup Window

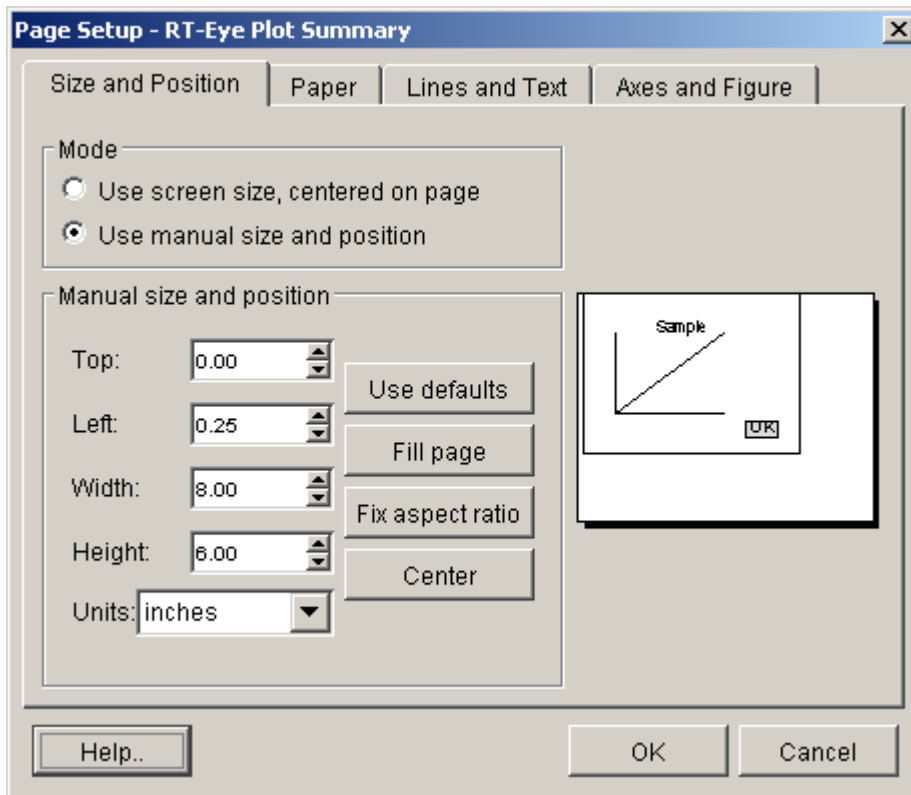

Figure 3-81: Plot page setup window

## Logging Worst Case Waveforms



### Saving Worst Case Waveforms from a Live Source

You can use the Log Worst Case menus to save the acquired waveforms whenever a selected measurement exceeds the highest or lowest prior value. When enabled, the waveforms are saved to a set of .wfm files.

The application also exports the contents of the files to a worstcasetable.csv file located in the Log directory.

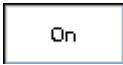
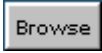
To log worst case waveforms, follow these steps:

1. Select Log> Worst Case> Configure.
2. Select the  button to enable logging.
3. Select the  button to select a directory.

4. Select the  command button in the Control Panel.
5. The application saves the waveforms with the worst case maximum and minimum values for all selected measurements in the `tdsrteye\modules\SerialAnalysis\waveforms` directory.
6. To disable logging, select the  button.

---

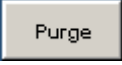
*Note:* Use the  button to delete all the `.wfm` files in the selected directory.

---

### Log Worst Case Configure Options

**Table 3-41: Log worst case configure options**

Option	Description
Log	Enables or disables saving the maximum and minimum values of the worst case waveforms to files for each source.
Choose Directory	Browse to select the directory in which to save the waveforms when the log worst case waveforms function is enabled.
Purge	Deletes all waveform files from the selected directory.

### Log: Worst Case Configure Menu

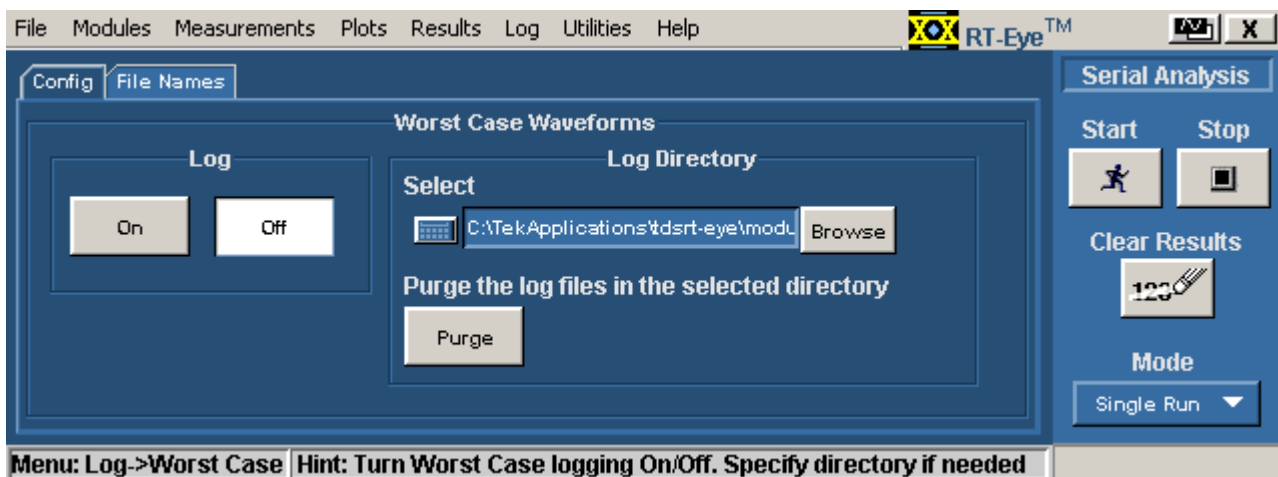

Figure 3-82: Log worst case waveform menu

### File Names of Worst Case Waveforms

The application automatically names the files for you. The file names include the following information:

- Type of measurement
- Whether the file is a maximum or minimum value waveform
- Date and time that the file was saved

File names appear after sequencing is complete and measurement results display.

### Log: Worst Case File Names Menu

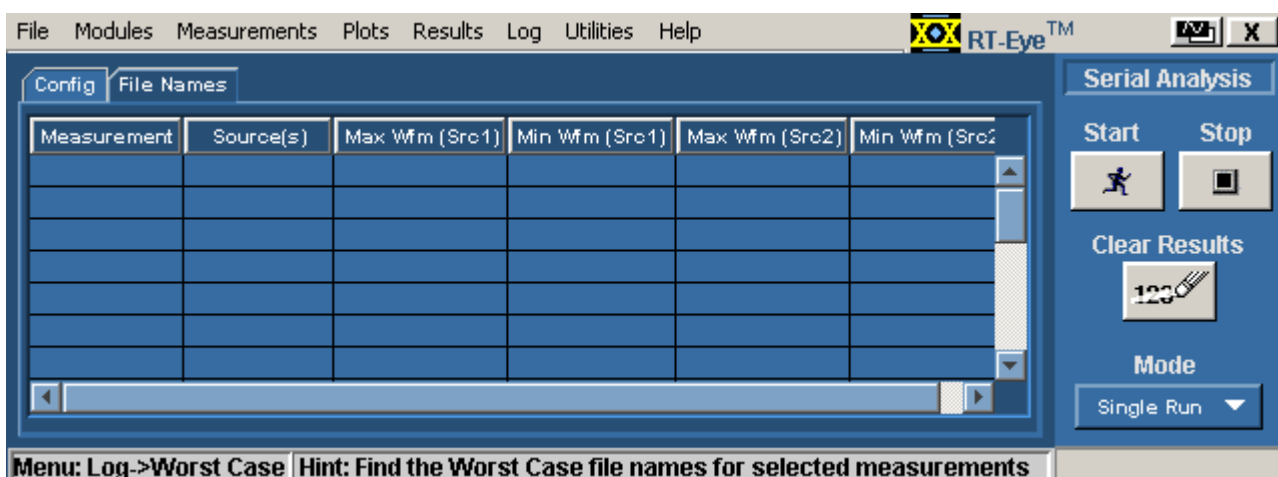

Figure 3-83: Log worst case file name menu

## Generating a Report

### About Generating a Report

You can use the Report Generator utility to customize and generate a compliance report to view later or to share with others. The utility is independent from the RT-Eye application, yet is accessible from the application.

---

*Note: The utility yields a .rpt file that can be viewed only from the Report Generator. You can select to export to an .rtf format file.*

---

### Report Generator File Directories

**Table 3-42: Report generator file directories**

Directory	Description
Reports	Default location where the utility stores reports.
Templates	Each .rpt template file defines the contents and layout of one page in the report; you can use existing page templates, edit templates or create new templates.
Layouts	Each .rpl layout file defines all the pages (template files) to include in a report; you can use an existing report layout, edit layouts or create new layouts.

## Directory Structure for the Report Generator Utility

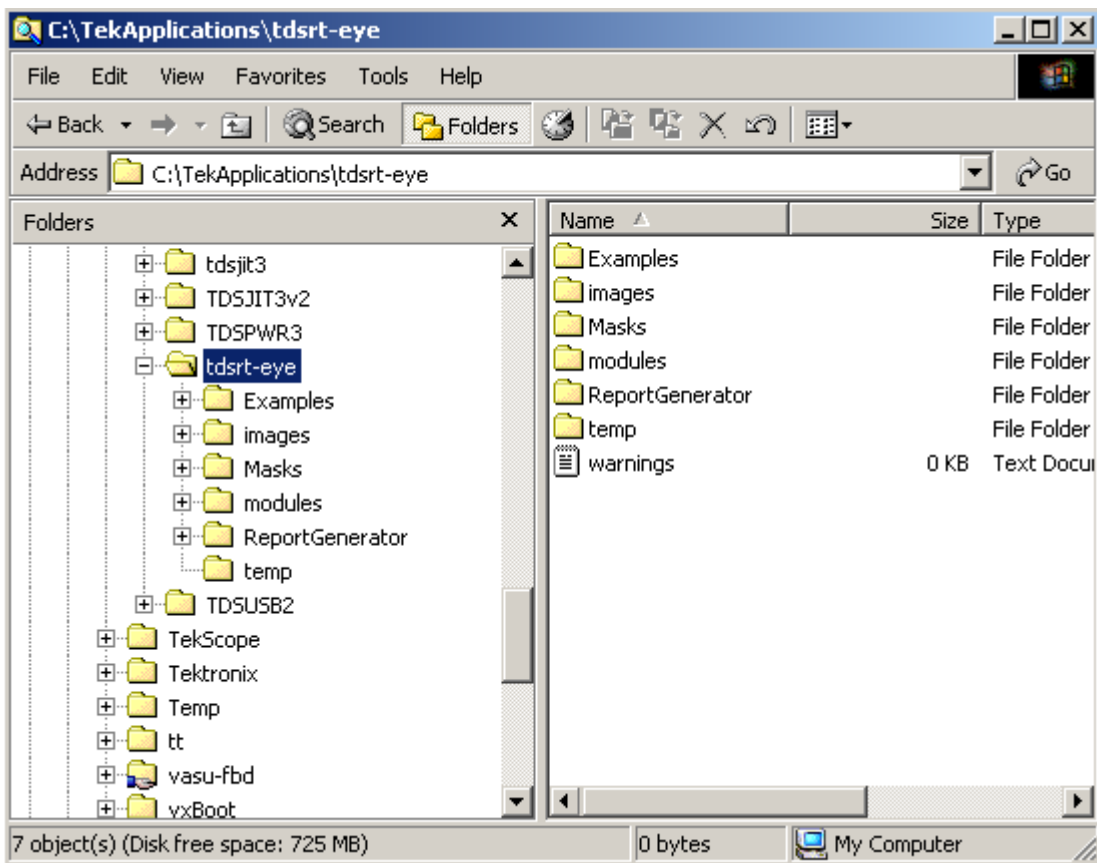



Figure 3-84: Directory structure for the report generator utility

### **Starting the Report Generator and Accessing the Online Help**

The online help for the Report Generator utility contains all the information you need to design and produce compliance report files. To start the report generator utility from the RT-Eye application and access the online help, follow these steps:

1. Select Utilities> Reports.
2. Select the Define Test Template or the Define Report Layout tab.
3. Select the  command button.
4. From the menu bar in the Report Generator window, select Help> Help Topics. The Help system for the utility appears.

You can refer to the online help topics for the Report Generator utility for information on how to do the following tasks:

- Use an existing test template or report layout
- Edit an existing test template or report layout
- Create a new test template or report layout
- Add Fields: Native, Oscilloscope, Serial Analysis

### Setting Up a Test Template and Layout for a Report

The Report Generator utility allows you to design the contents and layout of a report that reflects your unique needs. In addition to a predefined template for each page, there is also a predefined report that includes all the predefined pages.

### Generating and Printing a Report

To generate and print a report, follow these steps:

1. Select Utility> Reports.
2. Select the  tab.

Do not touch the screen. Wait while the Report Generator creates the report. The oscilloscope fills the display while the application takes a screen print. When complete, the oscilloscope display shrinks to half size and automatically the RT-Eye application reappears.

The report displays when it is complete. You may need to use the Alt+Tab key combination to bring the Report Generator window to the front.

3. You need to save the report to retain the file. To save the report, select File> Save from the menu bar of the Report Viewer. The report file is in a .rpt format and can only be viewed with the Report Viewer.

Later, you can use the Browse and View buttons in the Generate Report menu to open your saved report file.

4. To use a different file, edit a file, or create a new report layout (or test template) file, refer to the Report Generator online help.
5. To print the report, first verify that a printer is configured from the oscilloscope task bar.

6. From the Report Generator menu in the RT-Eye application,

select the  button.

You can also navigate to the saved file in the Report Generator window and send the file to a printer without having to open the file in the Report Viewer. To share a report with others, you may want to generate a smaller file. To do so, refer to the [Creating a PDF File of the Compliance Report](#) topic.

7. To export the report as an .rtf file, select File> Export to RTF from the menu bar of the Report Generator window. You can transfer the .rtf file to a personal computer, and view or print the file from a word processing program.



### Creating a PDF File of the Compliance Report

You can send a report file to a "virtual" printer to create a smaller and more portable PDF file of your compliance report. To create a PDF file, follow these steps:

1. Verify that a distiller program (for example, Adobe Acrobat Distiller 6.0) is configured from the oscilloscope task bar.
2. From the Report Generator menu in the RT-Eye application,

select the  button.

3. Select the Distiller from the Printer Name selection menu.

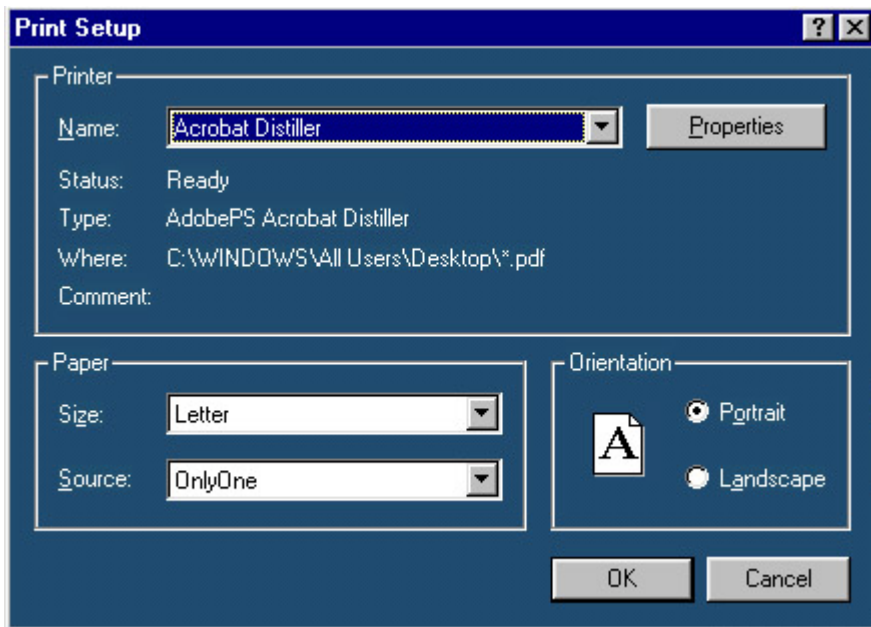

Figure 3-85: PDF creation of Compliance report

4. Send the report to the distiller (select OK).

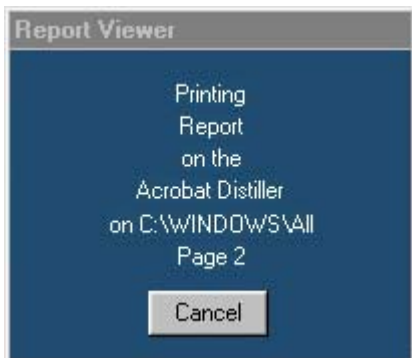

Figure 3-86: Print report status

5. When the PDF file is complete, you can use other features of the distiller to further enhance the report, such as add watermarks if available.

### Test Template Menu

*Note: Refer to the online help topics for the Report Generator utility for information on how to create a new test template or on how to edit an existing test template.*

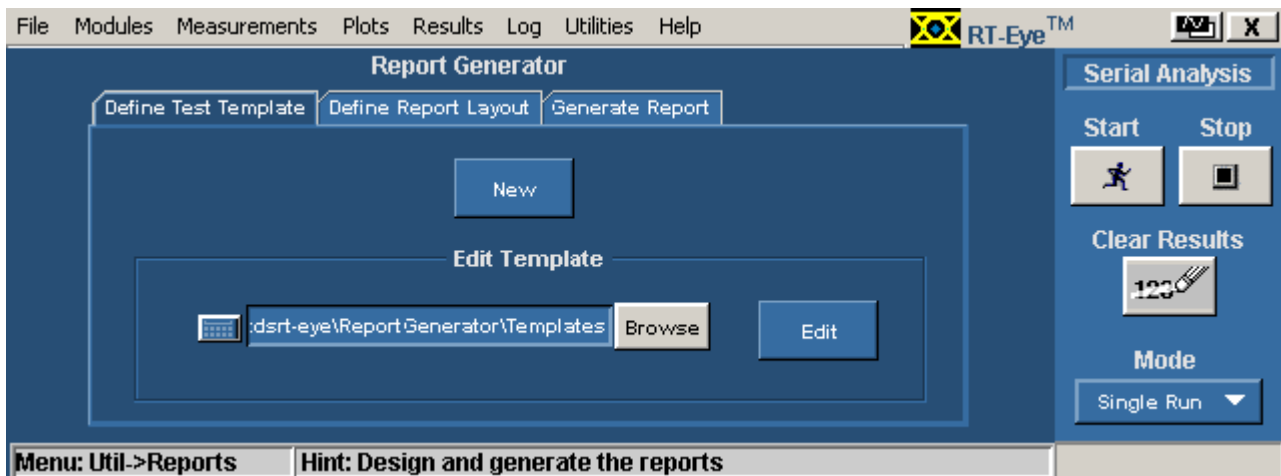

Figure 3-87: Test template menu

### Report Layout Menu

*Note: Refer to the online help topics for the Report Generator utility for information on how to create a new report layout or how to edit an existing report layout.*

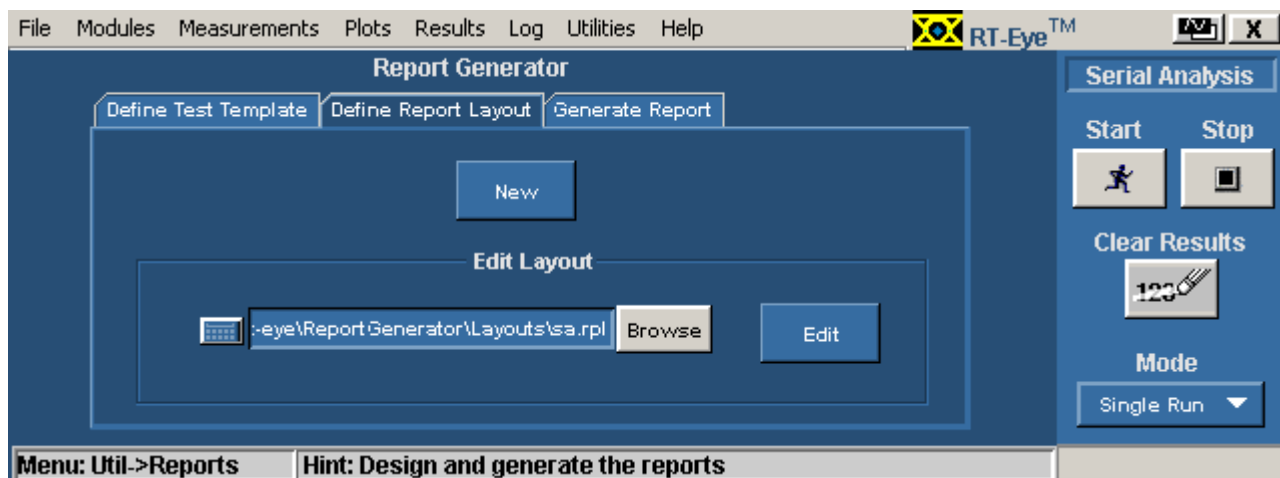

Figure 3-88: Report layout menu

### Report Generate Menu Options

Table 3-43: Report Generator menu options

Option	Description
Browse	Select a directory in which to save the report file and enter a file name; select a file for the template or layout and edit as needed.
Generate	Create a report.
View	View a report.
Print	Print a report.

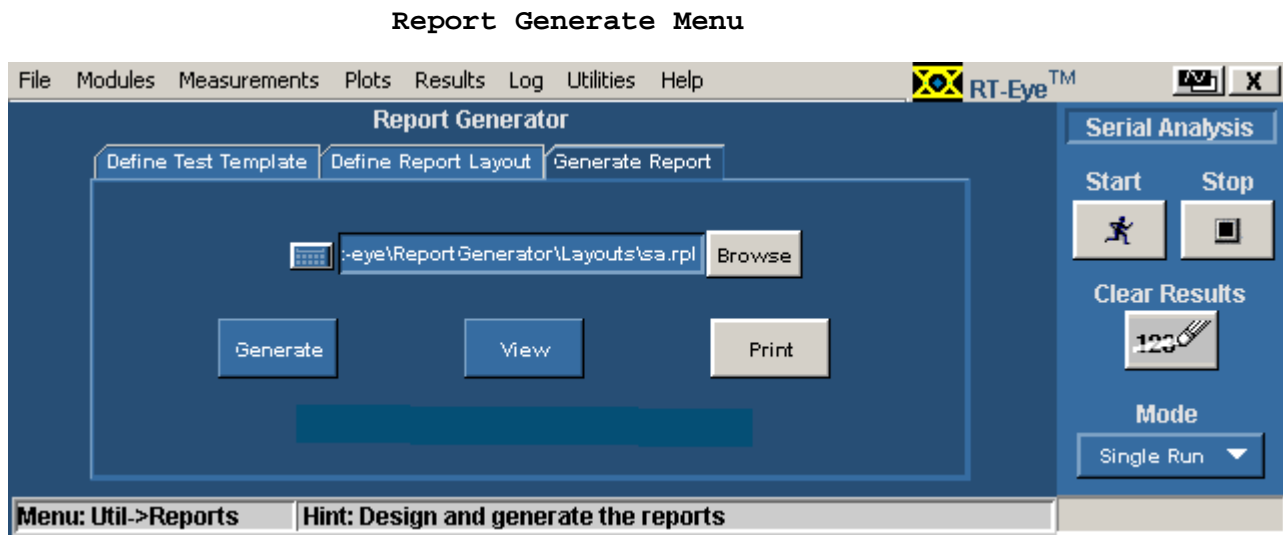

Figure 3-89: Report generator menu

### Report Generator Fields

You can use the fields in the report generator utility to customize the contents and layout of a report. The utility has the following groups of fields:

- Oscilloscope
- Application
- Native

### Application Fields General Information List

This is an example of the fields available for the general oscilloscope information in the report.

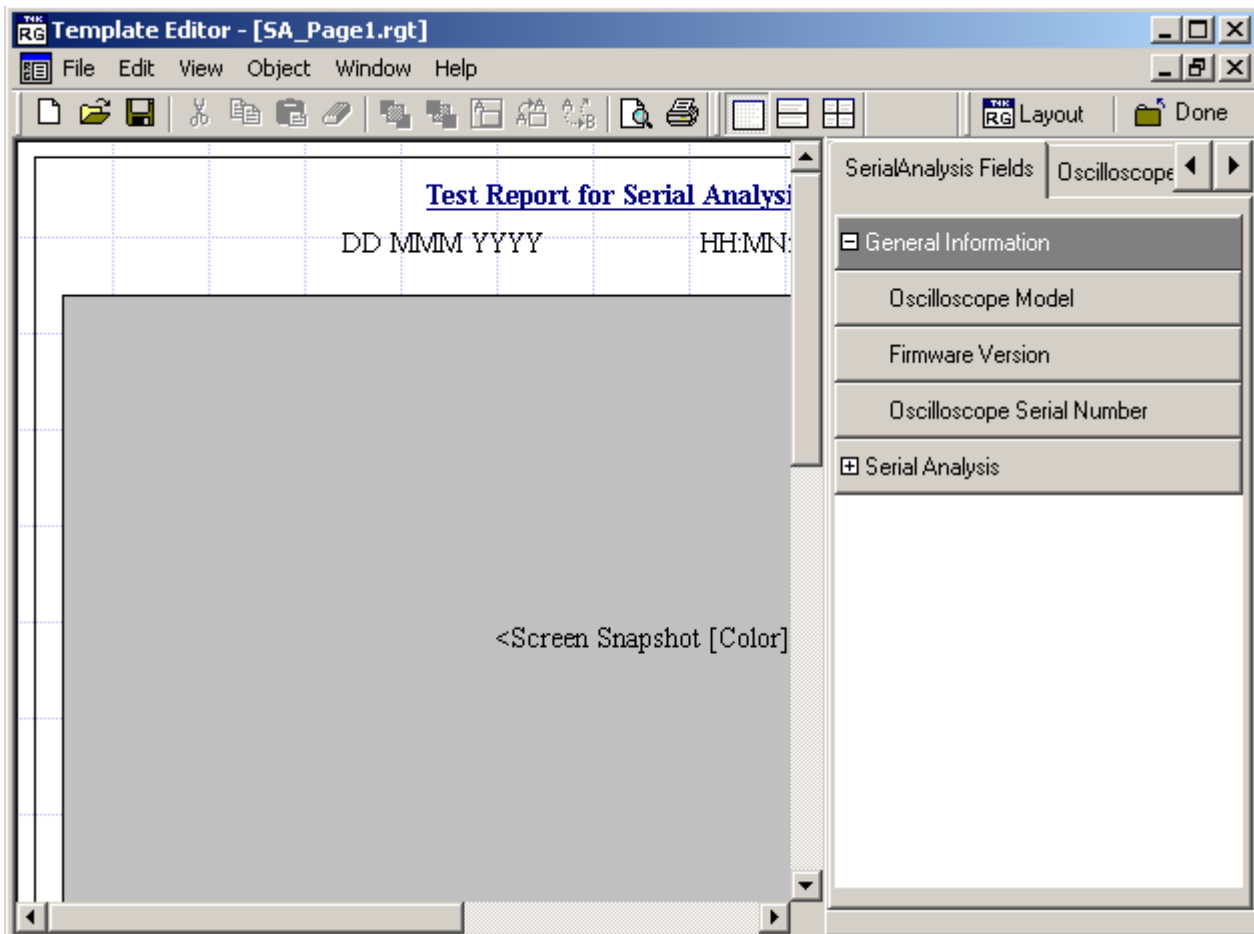

Figure 3-90: Application fields-general information

**Application Fields Configuration List and Ref Levels Example**

This is an example of the fields available for the configuration information. This example also shows the expanded list of fields available for the Ref Levels in the report.

SerialAnalysis Fields	Oscilloscope	SerialAnalysis Fields	Oscilloscope
<input checked="" type="checkbox"/> General Information		<input type="checkbox"/> Ref Levels	
<input type="checkbox"/> Serial Analysis		Ref Level Autoset Source	
<input checked="" type="checkbox"/> Configuration		Rise High Ref Level	
<input checked="" type="checkbox"/> Ref Level Autoset Setup		Rise Mid Ref Level	
<input checked="" type="checkbox"/> Gating		Rise Low Ref Level	
<input checked="" type="checkbox"/> Plots		Fall High Ref Level	
<input checked="" type="checkbox"/> Source		Fall Mid Ref Level	
<input checked="" type="checkbox"/> Ref Levels		Fall Low Ref Level	
<input checked="" type="checkbox"/> Jitter		Hysteresis	
<input checked="" type="checkbox"/> Population		<input type="checkbox"/> Jitter	
<input checked="" type="checkbox"/> Worst case waveforms		Clock Recovery Method	
Gating State		PLL Loop BW - Standard(...)	

**Figure 3-91: Application Fields Configuration List and Ref Levels Example**

**Application Fields Results List and Specific Measurements Example**

This is an example of the fields available for the measurement results information. This example also shows the expanded list of fields available for an EyeWidth/Eye Height measurement and for a Rise Time measurement in the report.

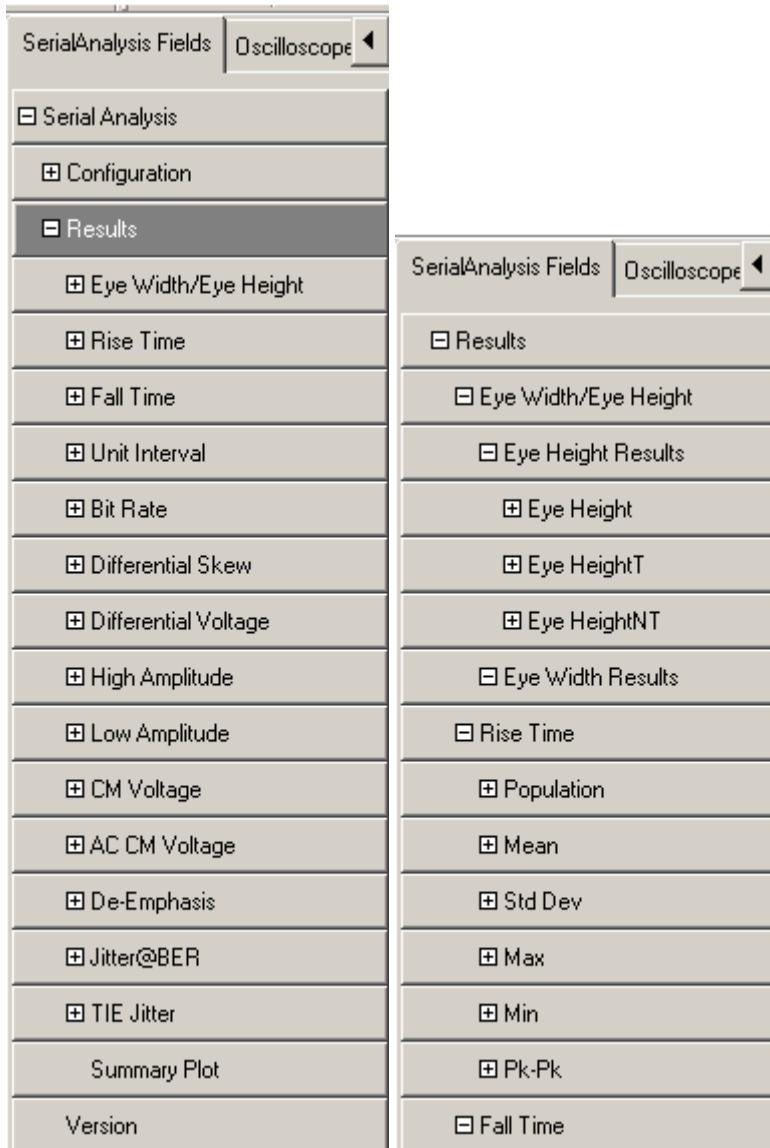

**Figure 3-92: Application Fields Results List and Specific Measurements Example**

### Oscilloscope Fields and Native Fields Lists

This is an example of the fields available for the oscilloscope controls and other miscellaneous features in the report, such as lines.

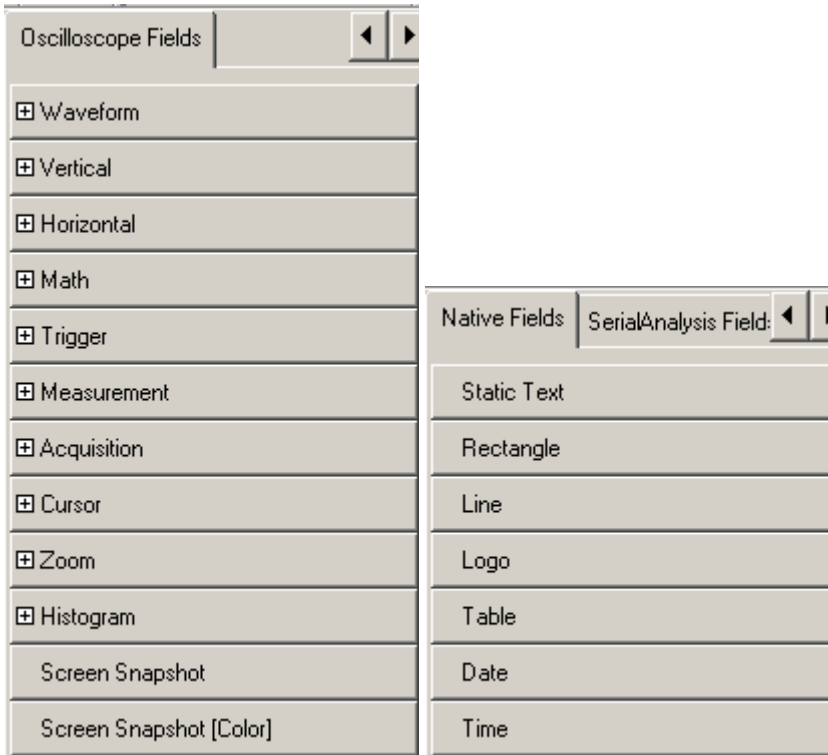

Figure 3-93: Oscilloscope Fields and Native Fields Lists





# Tutorial

## Introduction to the Tutorial

This tutorial teaches you how to set up the application, take measurements, and view the results.

Before you begin the tutorial, you must do the following tasks:

- Set up the oscilloscope
- Start the Application
- Recall the tutorial waveform

---

*Note: The screen captures shown are from a TDS7000 oscilloscope; there may be minor differences in the screens from other types of oscilloscopes.*

---

## Setting Up the Oscilloscope

To set up the oscilloscope, follow these steps:

1. In the oscilloscope menu bar, select File> Recall Default Setup to set the oscilloscope to the default factory settings.
2. Press the individual CH1, CH2, CH3, and CH4 buttons as needed to remove active waveforms from the display.

## Starting the Application

In the oscilloscope menu bar, select File> Run Application> RT-Eye Serial Compliance and Analysis.



The application starts up and displays the Measurements Select menu.

## Waveform Files

The application includes a waveform file to use with this tutorial. The file is from a PCE Express signal and is named RT-EyeTutorial.wfm.

## Recalling a Waveform File

To recall a waveform file, follow these steps:

1. In the oscilloscope menu bar, select File> Reference Waveforms> Reference Setup. Ref1 is the default memory location to recall a waveform file.
2. Select the  button for Recall Ref1 from File.
3. Navigate to the C:\TekApplications\ tds-rteye\examples\WFMs directory.
4. Select the RT-EyeTutorial.wfm file and then .
5. The oscilloscope recalls the waveform file to reference memory and displays the waveform when the recall is complete.
6. To return to the application, select the  button in the oscilloscope menu bar.

## Oscilloscope Reference Memory Setup Menu

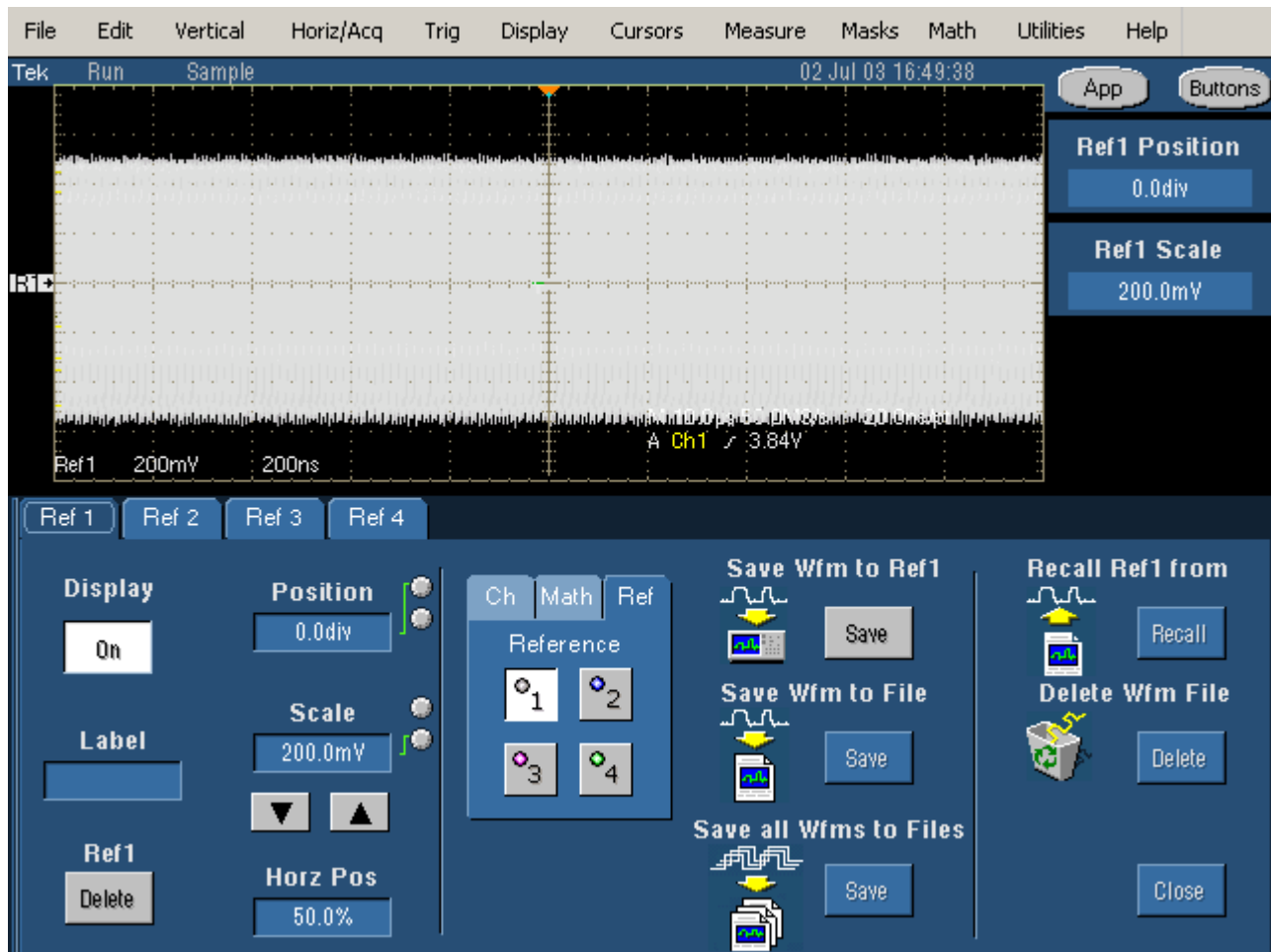

Figure 4-1: Oscilloscope Reference memory set up menu

## Taking an Eye Width Measurement

In this lesson, you will learn how to use the application to take an Eye Width/Eye Height measurement and view the results. This lesson teaches you how to do the following tasks:

- Select a measurement
- Configure a measurement
- Take measurements
- View the measurement results
- View a Real-Time Eye diagram
- Stop the application
- Return to the application



To perform these lessons, the application must be installed and enabled on the oscilloscope. See [Installation](#).

### Setting Up an Eye Width Measurement

To set up the application to take an Eye Width/Eye Height measurement, follow these steps:

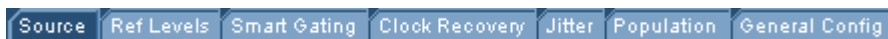
1. To set the application to default values, select File> Recall Default. The tutorial uses the default measurement and probe type. The [measurement selections vary depending on the Probe Type option](#): Differential or Single Ended.
2. Select the  button.
3. The Configure Source menu appears with tabs for other Configure menus.



4. Select Ref1 as the source. [View the waveform recalled to Ref1 and selected as the source](#).
5. Select the  tab. The Configure Ref Levels Menu appears.
6. Select the  command button. The application automatically calculates the appropriate reference voltage level values. [View the reference voltage level values as calculated by the application](#).

## Ref1 Selected as the Source

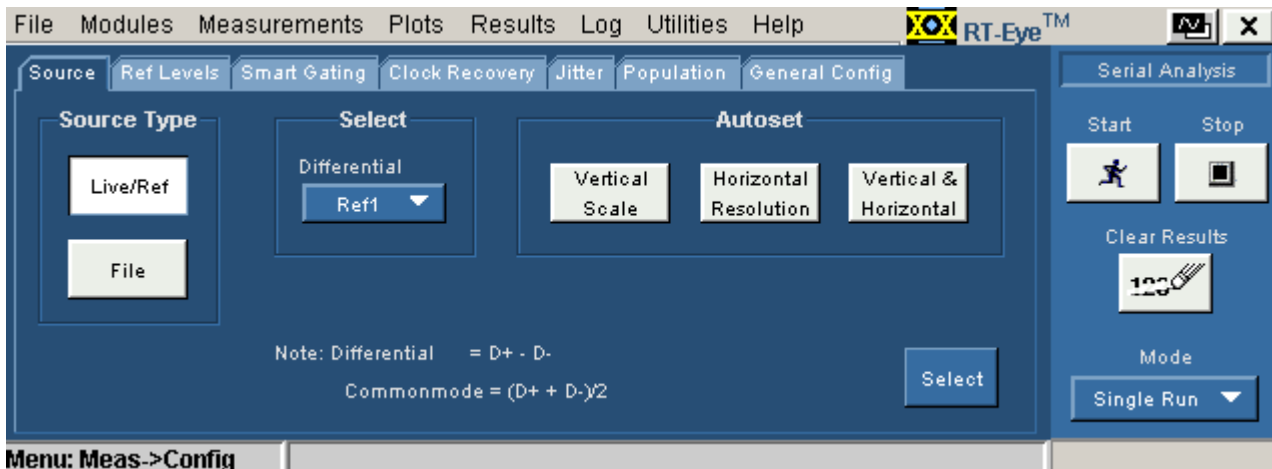

Figure 4-2: Ref1 as source

## Using Autoset for Reference Voltage Levels

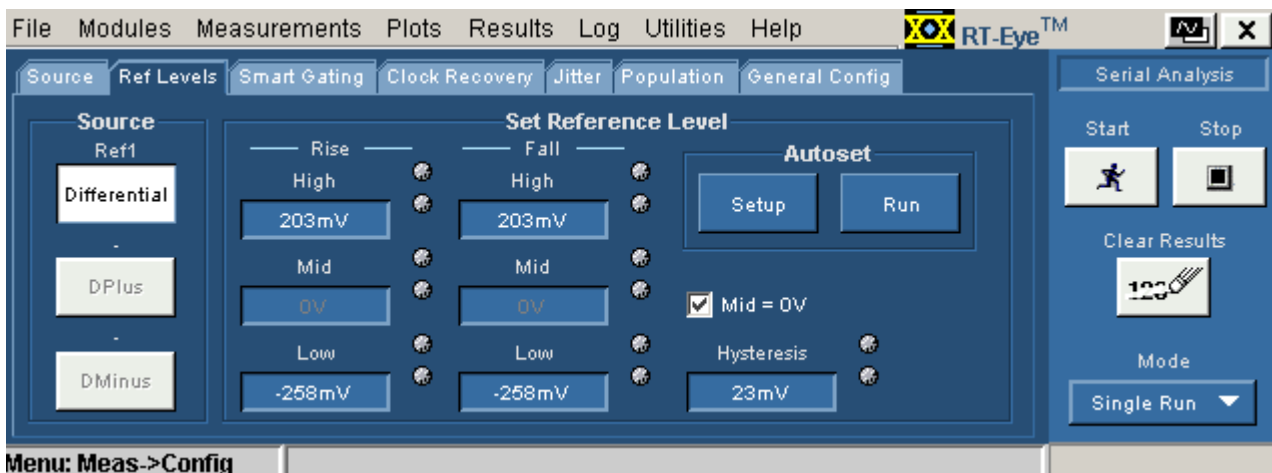



Figure 4.3: Using autoset for reference voltage levels

## Taking a Measurement and Viewing as an Eye Diagram

The default setup for the application includes an Eye Diagram plot. To take measurements and view the results as statistics and as a plot, follow these steps:

1. Select the  command button in the Control Panel. The application displays a real-time eye diagram that shows the characteristics of the waveform in a Plot Summary window.

2. You can view details of the results and details of the plot.

To do so, select the  command button in the

Results Summary menu and the  in the Plot Summary window. [View the details of the results and of the Eye diagram plot.](#)

3. You can use the Results Details: Select Measurement option to view details of other measurements.

## Results Summary and Plots Summary Window Example

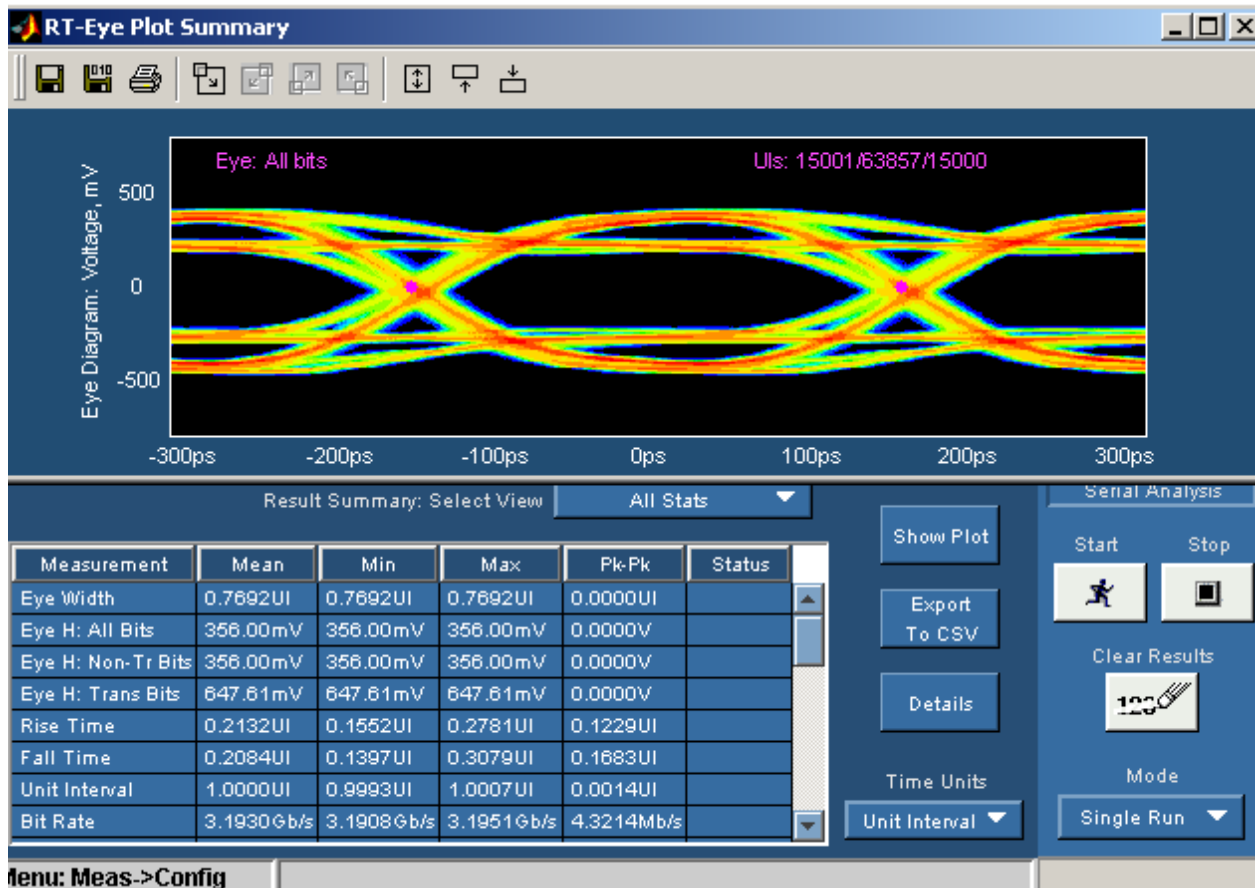

Figure 4-4: Results summary and plots summary window example



## Results Details and Plot Details Window Example

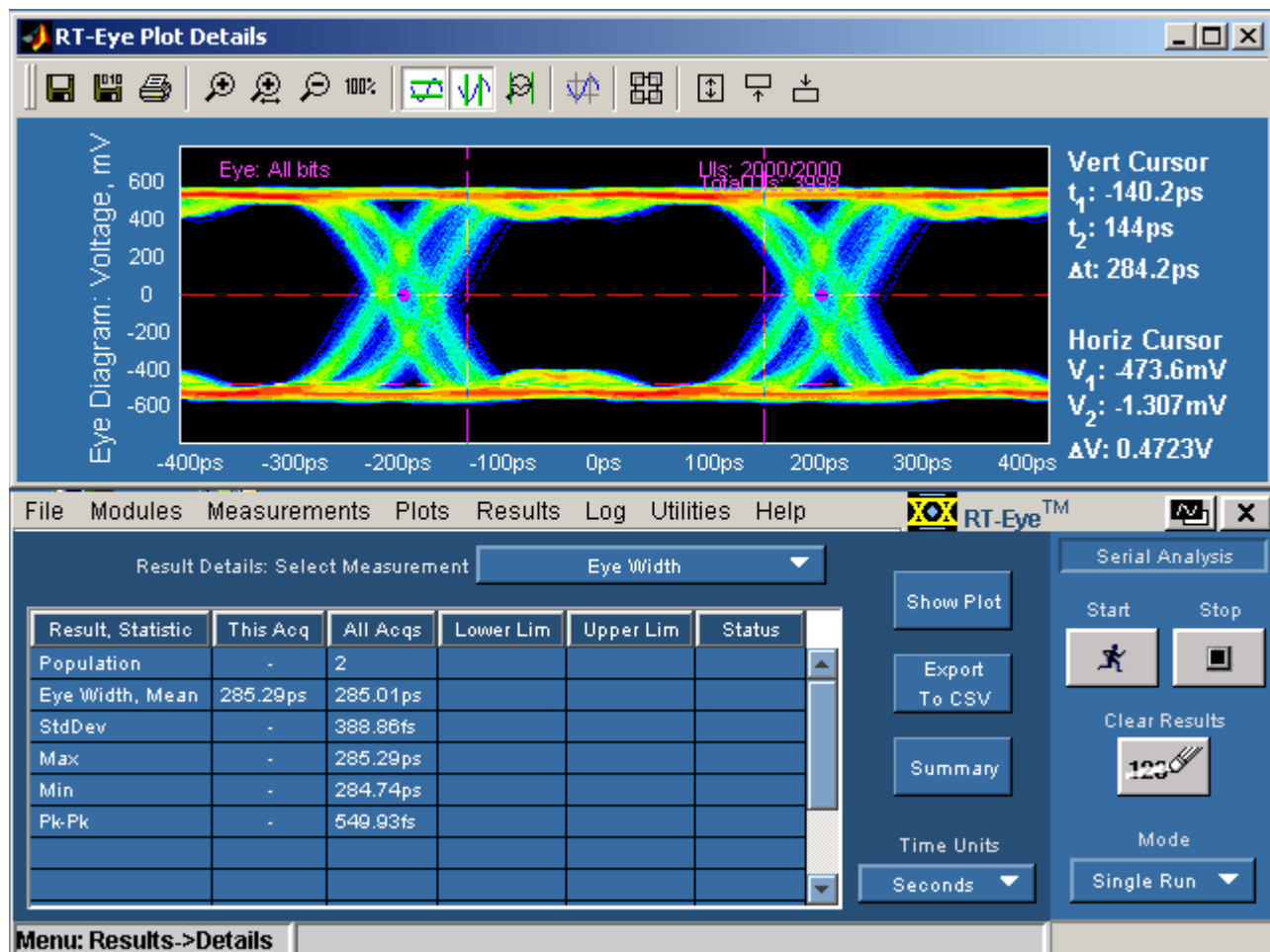

Figure 4-5: Results Details and Plot Details Window Example

## Ending a Tutorial Lesson

If you need more than one session to complete the tutorial lessons, you can stop the tutorial and return to it later. Refer to [Stopping the Tutorial](#) and [Returning to the Tutorial](#).

**Note:** The purpose of this tutorial is to familiarize you with the basic functions of the application, menus, and steps you may need to take if the quick method does not yield expected results.

### **Stopping the Tutorial**

If you need more than one session to complete the tutorial lessons, you can stop the tutorial and return to it later.

To save the application setup and stop your session, refer to [Saving a Setup File](#) and to [Exiting the Application](#).

### **Returning to the Tutorial**



To return to the tutorial setup, you can start the application and then recall the saved setup. To recall the application setup, refer to [Recalling a Saved Setup File](#).

## **Quick Method Concept**

There is a quick method you can use to take measurements that may yield reasonable results for your situation. The results from the quick method should indicate whether or not the setup is adequate. If it is not, then you can set up the application manually as shown in the first lesson.

### Quick Method to Take Measurements

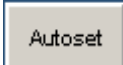
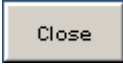
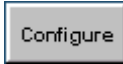
You can use the quick method to take measurements from channel (live) waveforms. To quickly take measurements, follow these steps:

1. Start the application (also clears previous results), and make your Probe Type and measurement selections in the Measurements> Select menu.
2. Select . The Autoset Summary menu appears
3. In the Autoset Summary menu, select . The application calculates and applies appropriate settings for the vertical scale and horizontal resolution of the source and values for the reference voltage levels.
4. If the values are acceptable, select .
5. If need be, select  to adjust the reference voltage levels in the Configure Ref Levels menu.
6. Select the  command button to take measurements.

When sequencing is complete, the application displays statistical results and a real-time eye diagram that shows the characteristics of the waveform. View the results of the Eye Width measurement as an Eye Diagram.

## Taking a TIE Jitter Measurement

In this lesson, you will learn how to use the application to take a TIE Jitter measurement on the waveform already recalled to the Ref1 location. This lesson teaches you how to do the following tasks:

- View the results as a Histogram, and a Spectrum plot
- Save statistical results to a .csv file
- View a .csv file with Wordpad or in a spreadsheet
- Generate a simple report





### Clearing Results

Before taking more measurements, be sure to clear the results.

To do so, select the  command button in the Control Panel.

### Setting Up a TIE Jitter Measurement and Plots

To set up, take, and plot a TIE Jitter measurement, follow these steps:

1. Clear any previous results.
2. Select Measurements> Select and deselect the Eye Width/Eye Height measurement (from the previous lesson). When you deselect a measurement, the application discards the corresponding options in the Plots menus.
3. Select the  measurement. The vertical scale, horizontal resolution and reference voltage levels were set for the source (Ref1) in the previous lesson.
4. Select the  button.
5. In the Select Subplot table, select TIE Jitter in the Measurement column and Histogram in the Plot Type column. Select the  command button. The application displays the Results Summary menu and the Histogram plot. View the results of the TIE Jitter measurement.
6. Select Plots> Select.
7. In the second row of the Select Subplot table, select TIE Jitter in the Measurement column and Spectrum in the Plot Type column.
8. Select  to update the plot window.

TIE Jitter Results with Histogram Example

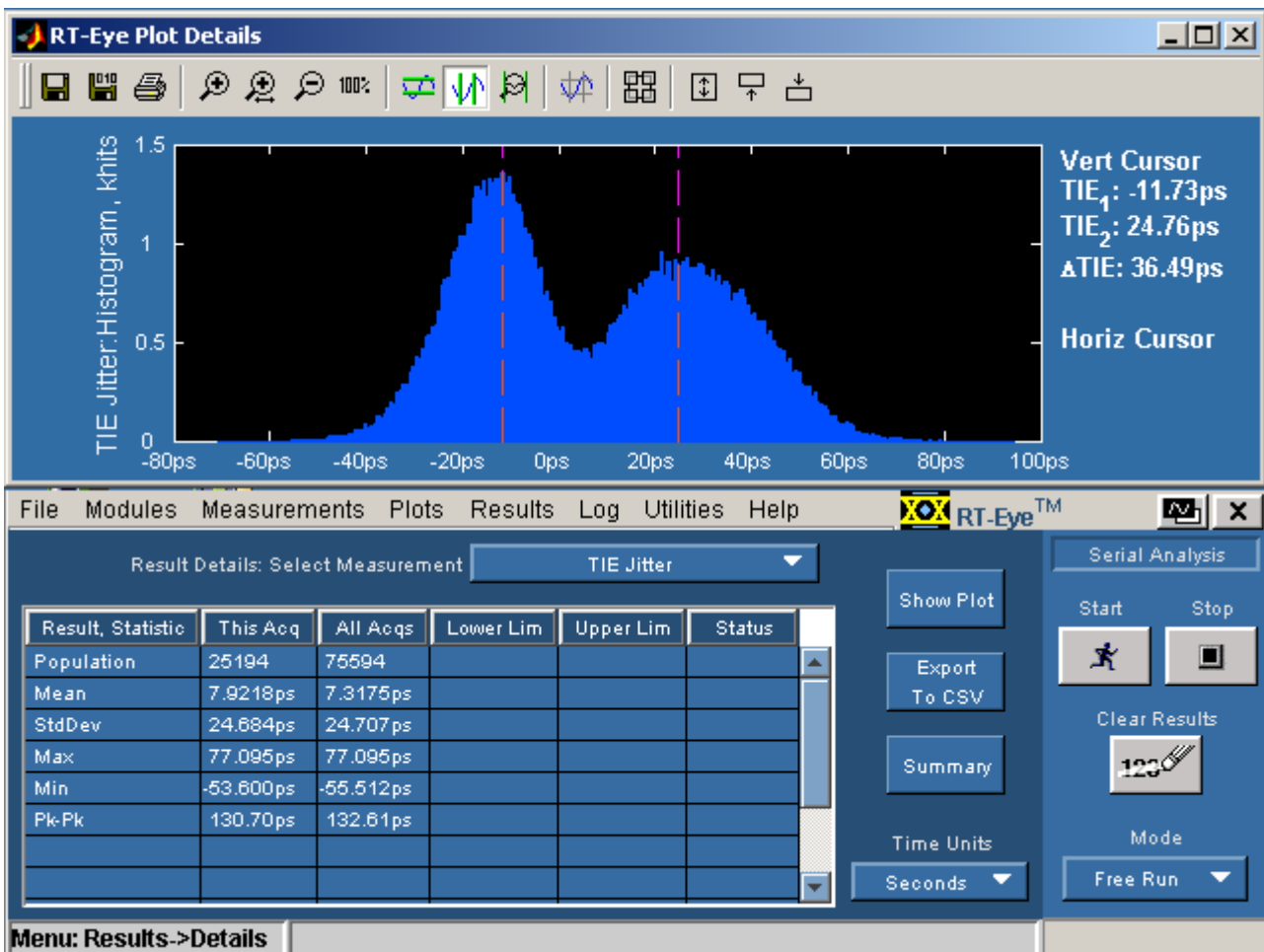

Figure 4-6: TIE jitter results with Histogram example

### TIE Jitter Histogram and Spectrum Plot Example

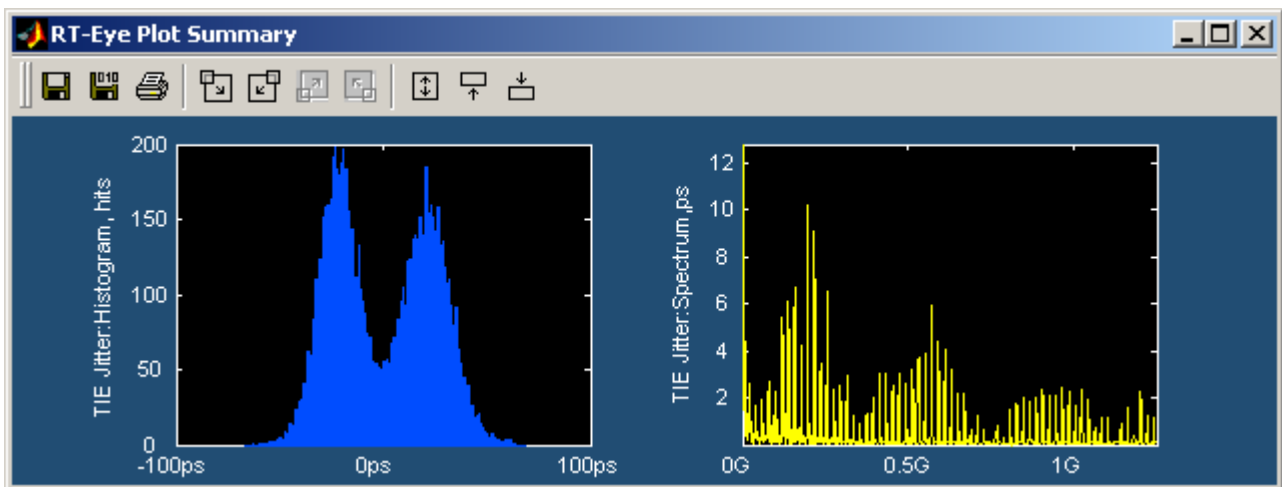

Figure 4-7: TIE Jitter Histogram and spectrum plot example

### Examples of Plot Details

Here are details from the plots in this lesson.

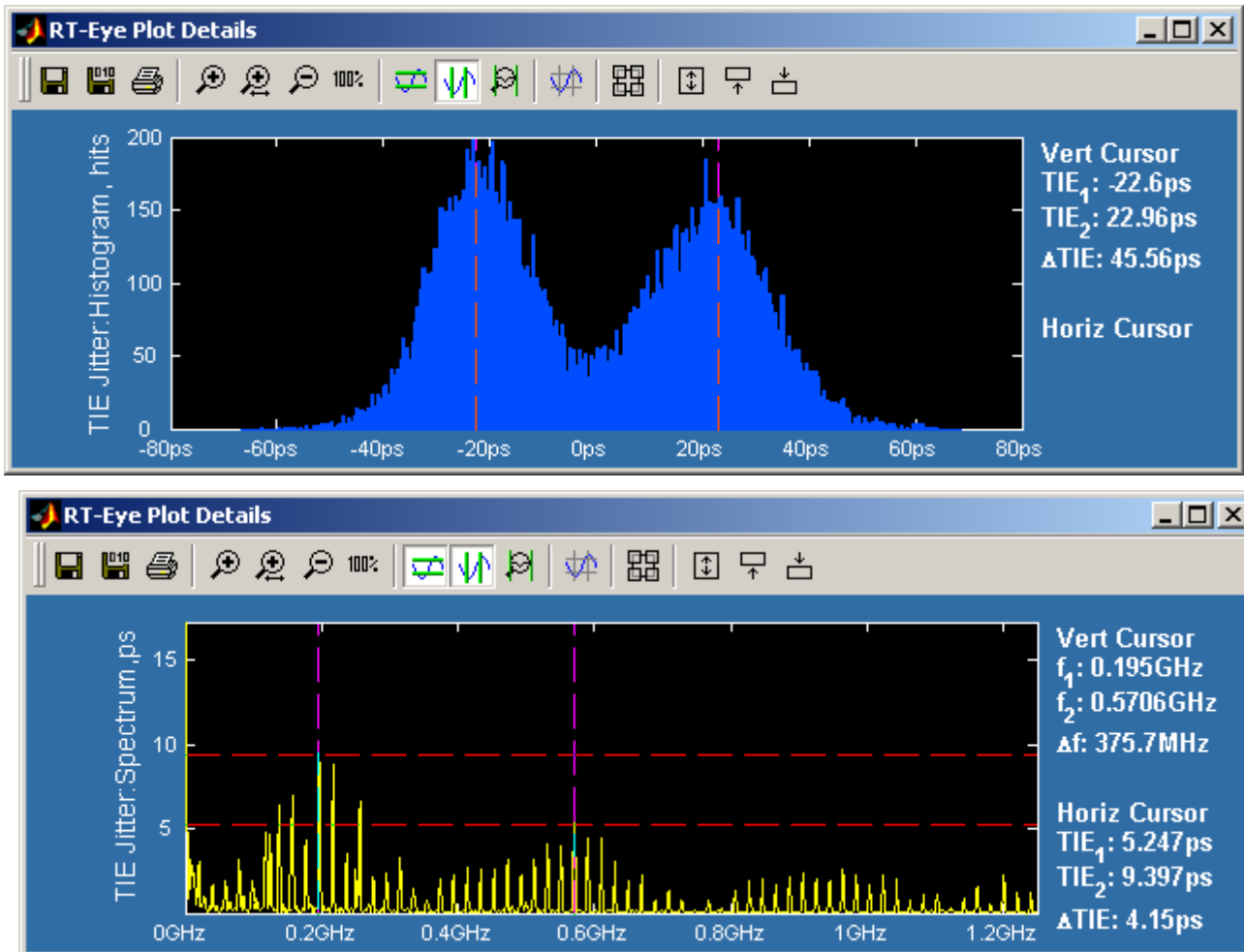

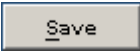

Figure 4-8: Example of plot details



### **Saving Statistical Results to a .CSV File**

To save the statistical results to a .csv (comma separated variable) file, follow these steps:

1. Select the  command button. The Save dialog appears.
2. Use the  command button to select a directory in which to save the .csv file in.
3. Enter a file name and select .
4. Start the Wordpad program on the oscilloscope and select File> Open.
5. Navigate and select the file you just created. View the .csv file with Wordpad.
6. Close the Wordpad program.
7. Copy the file to your PC, start a spreadsheet or other analysis program, and open the .csv file. You can customize the results to suit your analysis needs. View the .csv file as a spreadsheet.

### A .CSV File Viewed with Wordpad Example

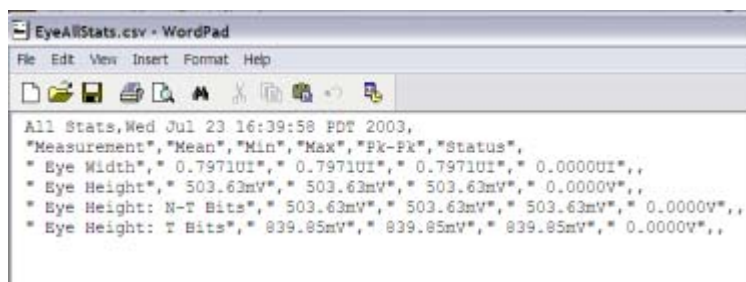

Figure 4-9:.CSV file viewed in wordpad

### A .CSV File Viewed in a Spreadsheet Example

	A	B	C	D	E	F
1	All Stats	Wed Jul 23 16:39:58 PDT 2003				
2	Measurement	Mean	Min	Max	Pk-Pk	Status
3	Eye Width	0.7971UI	0.7971UI	0.7971UI	0.0000UI	
4	Eye Height	503.63mV	503.63mV	503.63mV	0.0000V	
5	Eye Height: N-T Bits	503.63mV	503.63mV	503.63mV	0.0000V	
6	Eye Height: T Bits	839.85mV	839.85mV	839.85mV	0.0000V	
7						

Figure 4-10:.CSV file viewed in spreadsheet

## Generating a Simple Report

To generate a simple report, follow these steps:

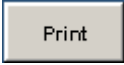
1. Select Utilities> Report. The Report Generator menu appears and is set to use the default Define Test Template and Define Report Layout definitions.
2. Select the  command button.
3. The application generates and displays the report. [View the simple report.](#)
4. To print the report, select the  command button.

---

*Note: Before the application can send the file to a printer, you need to check if the printer is set up from the Start menu (in the oscilloscope task bar).*

---

### Simple Report Example Page 1

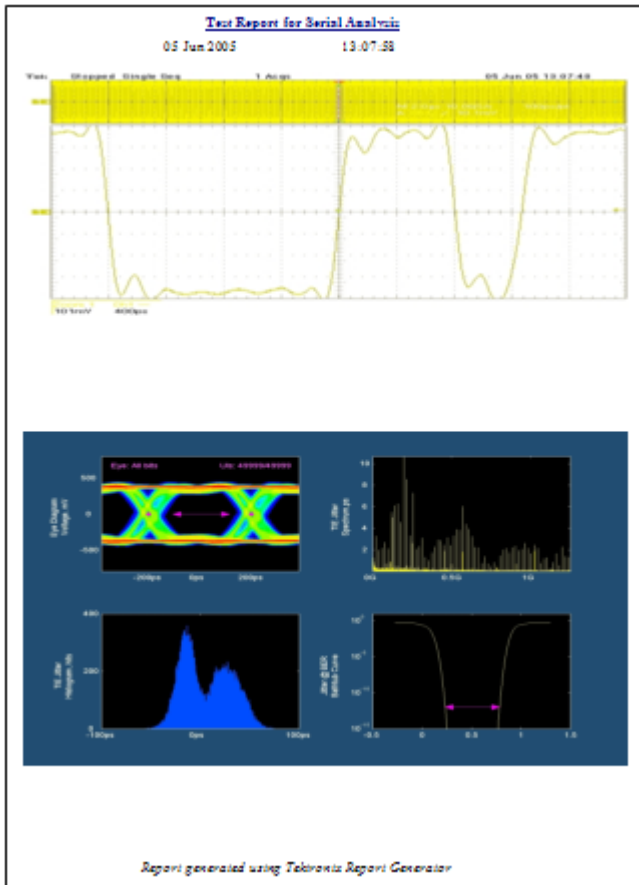

Figure 4-11: Simple report example Page 1

## Simple Report Example Page 2

<u>Eye Height Result</u>				
	Current	All	Li	Stat
<b>Populatio</b>	Current Acq : -	All Acqs : 1	Limit : -	Status : -
<b>Height,M</b>	Current Acq : 503.63n	All Acqs : 503.63mV	Limit : -	Status : -
<b>Std Dev</b>	Current Acq : -	All Acqs : 0.0000V	Limit : -	Status : -
<b>Max</b>	Current Acq : -	All Acqs : 503.63mV	Limit : -	Status : -
<b>Min</b>	Current Acq : -	All Acqs : 503.63mV	Limit : -	Status : -
<b>Pk-Pk</b>	Current Acq : -	All Acqs : 0.0000V	Limit : -	Status : -
<b>Mask UI</b>	Current Acq : 0.0000V	All Acq : 0.0000V	Limit : -	Status : -
<b>Mask</b>	Current Acq : 0.0000V	All Acq : 0.0000V	Limit : 0	Status : Pass
<u>Eye Height:Transition Bits - Result</u>				
	Current	All	Li	Stat
<b>Populatio</b>	Current Acq : -	All Acqs : 1	Limit : -	Status : -
<b>T</b>	Current Acq : 839.85	All Acqs : 839.85mV	Limit : -	Status : -
<b>Std Dev</b>	Current Acq : -	All Acqs : 0.0000V	Limit : -	Status : -
<b>Max</b>	Current Acq : -	All Acqs : 839.85mV	Limit : -	Status : -
<b>Min</b>	Current Acq : -	All Acqs : 839.85mV	Limit : -	Status : -
<b>Pk-Pk</b>	Current Acq : -	All Acqs : 0.0000V	Limit : -	Status : -
<b>Mask UI</b>	Current Acq : 0.0000	All Acq : 0.0000V	Limit : -	Status : -
<b>Mask</b>	Current Acq : 0.0000	All Acq : 0.0000V	Limit : 0	Status : Pass

Figure 4-12: Simple report example Page 2



# Serial Analysis Laboratory

## About the Serial Analysis Laboratory (Lab)

The Serial Analysis Laboratory presents a typical application example that highlights the compliance and analysis capabilities of the RT-Eye application, and will give you ideas on how to use the application to solve your own test problems. This lab covers and explores the following areas:

- Using the Serial Data Wizard to perform serial analysis on a 2.5 Gb/s serial bit stream
- Performing jitter measurements that are compliant to the T11.2 MJSQ using the spectrum approach to jitter analysis
- Saving and using MyTest
- Creating Limits Module File for custom Compliance Test
- Creating a Compliance Report
- Performing a PCI Express Compliance test (PCI Express Compliance Module required)

---

*Note: To use this lab, you must have the RT-Eye application installed, enabled and running on the oscilloscope. For information, see [Installation](#) and Starting the application.*

---

### Requirements:

- TDS/CSA7000 series oscilloscope (1.5 GHz and above) or TDS6000 series oscilloscope if you use a reference waveform.

Optionally, the Training Board 2 (P/N 020-2460-00) or Training Board 3 by Tektronix. A minimum bandwidth of 4 GHz is required for a live signal.

- RT-Eye Serial Data Compliance and Analysis software (Opt. RTE)

---

*Note: If your oscilloscope setup includes a second monitor, you can select and drag the title bar of the online help window to position it in the second monitor. This allows you to simultaneously display these lab exercises in the second monitor, the waveform (or a plot) on the oscilloscope, and the RT-Eye measurement results for easy viewing.*

---

## Recall Default Settings and Run RT-Eye SW

To ensure that your lab results match the results shown in these lab exercises, you will recall the default settings to the oscilloscope and to the RT-Eye application. To do so, follow these steps:

- Push the DEFAULT SETUP front-panel button to start from a known setup.
- From the oscilloscope application menu, select File> Run Application> RT-Eye Serial Compliance and Analysis on non-B models, or Applications > RT-Eye Serial Compliance and Analysis on B/C models

Will you be using a [Reference Waveform](#) File or a live signal from the [Training Board](#)?

## Reference Waveform File Setup

This lab uses a 2.5 Gb/s differential signal saved to

C:\TekApplications\tds-rteye\modules\SerialAnalysis\waveforms\examples\2\_5Gbps\_PRBS.wfm.

You can recall the waveform to reference memory, view the waveform, and analyze it with any RT-Eye compliance and analysis application. To recall the waveform file to reference memory, follow these steps:

1. Click the DEFAULT SETUP button on the front panel.
2. Push the CH1 front-panel button to turn off the Channel 1 waveform Push the CH1 front-panel button to turn off the Channel 1 waveform.
3. From the Oscilloscope application menu, select Reference Waveforms> Recall Wfm
4. Select Recall Ref1 from Wfm File
5. Browse to and select:  
C:\TekApplications\tdsrteye\modules\SerialAnalysis\waveforms\examples\2\_5Gbps\_PRBS.wfm as the waveform file.
6. Use the Zoom control to zoom in and view individual bits.
7. Select Measurement> Wizard, to run the Serial Data Wizard.

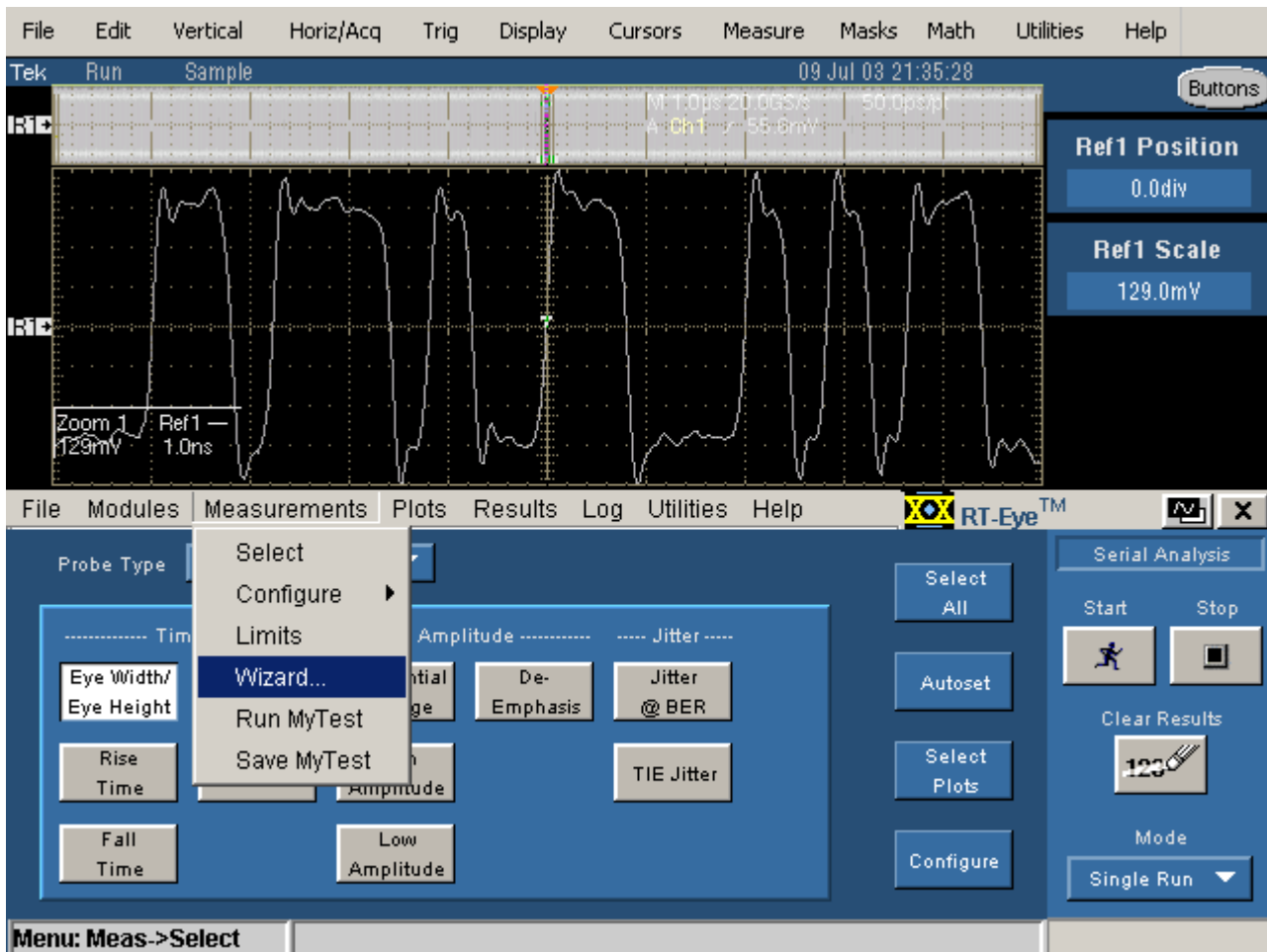

Figure 5-1: Select measurement wizard

8. Make Wizard Selections as shown in the yellow text in the following figure.



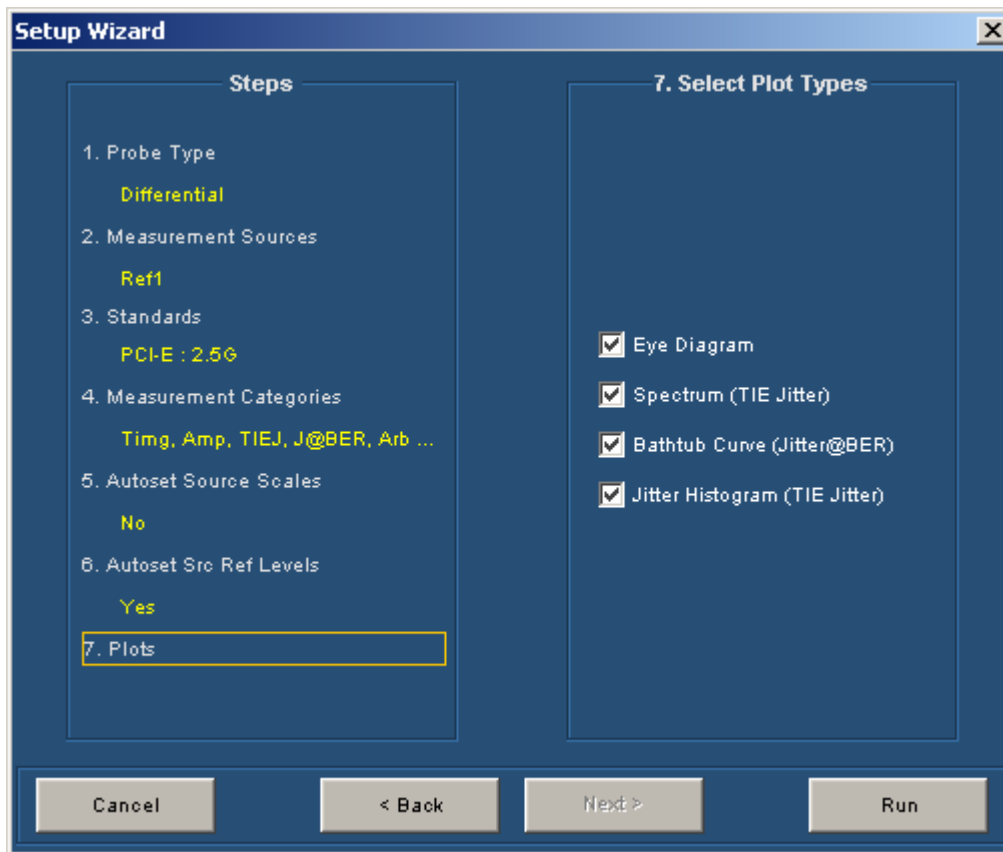

Figure 5-2: Plots selection

9. Proceed to Run the Analysis and View the Results.

## Training Board 2 - Live Signal Source

You can use the Training Board 2 or Training Board 3 to work through these exercises. To do so, use the 2.5 Gb/s PRBS signal. This signal has rise times of <math><100\text{ ps}</math>, and thus needs full sample rate (20 GS/s) to perform measurements accurately. You can use the following configurations:

- **TDS7000 Series (TDS7404):** Use P7380SMA with CH1 as the Differential Source for Analysis.
- **TDS6000 Series:** Use P7380SMA with CH1 as the Differential Source for Analysis or Use TCA-SMA Adapters on CH1 and CH3 as Single-Ended Sources for Analysis.

## Use P7380SMA with CH1 as the Differential Source for Analysis

1. Use the phase-matched SMA cables (provided with the P7380SMA probe) to connect the positive and negative leg of the 2.5Gb/s signal on the training board and CH 1 on the oscilloscope.
2. Connect the other end of the phase-matched cables to the "D+" and "D-" connections of the P7380SMA probe input.
3. Connect the TekConnect end of the P7380SMA probe to CH1 of the oscilloscope.
4. Push the AUTOSET front-panel button to view the differential signal.
5. Select Measurement> Wizard, to run the Serial Data Wizard.

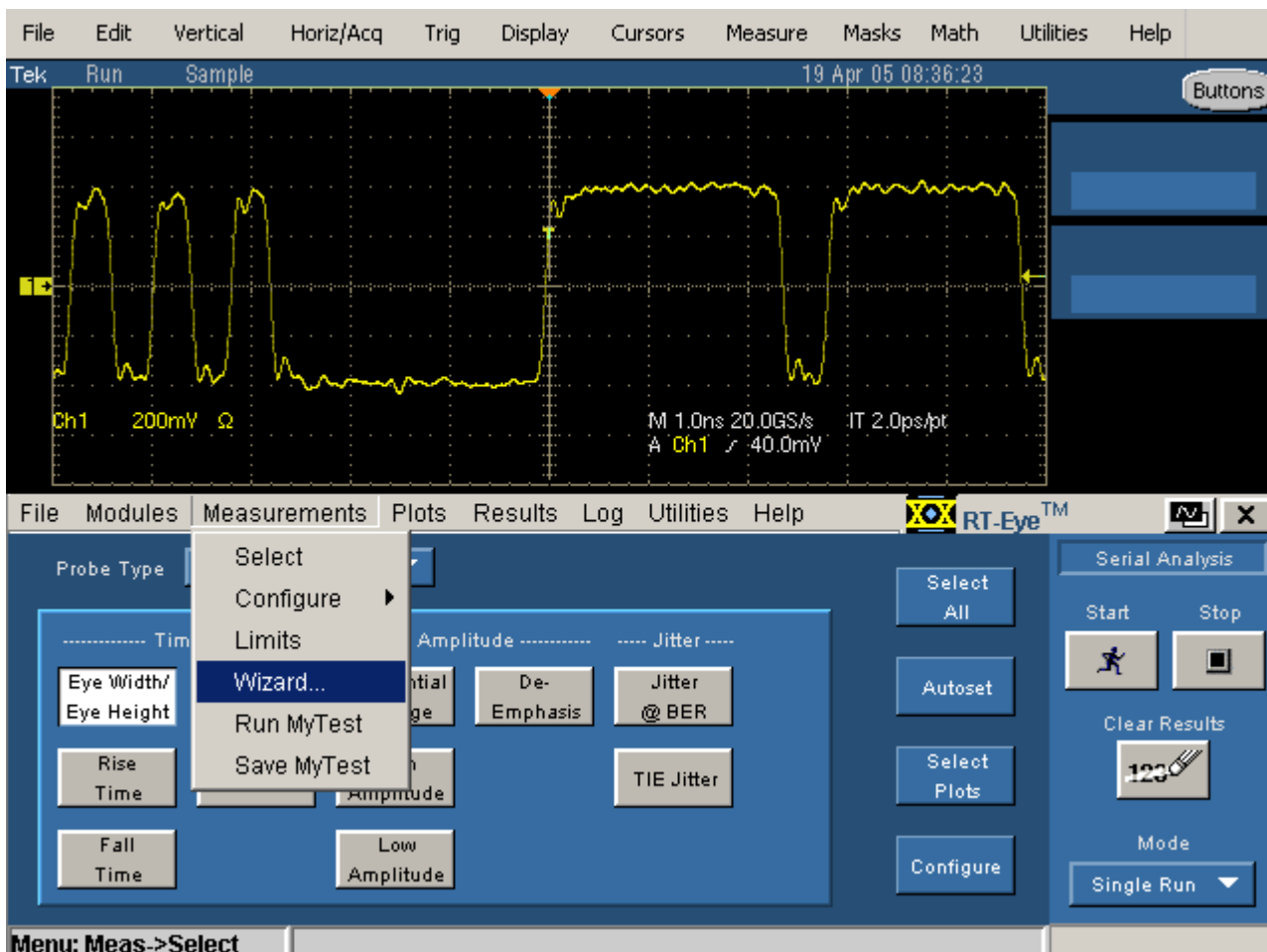

Figure 5-3: Select Wizard

6. Make Wizard Selections as shown in the yellow text in the following figure.

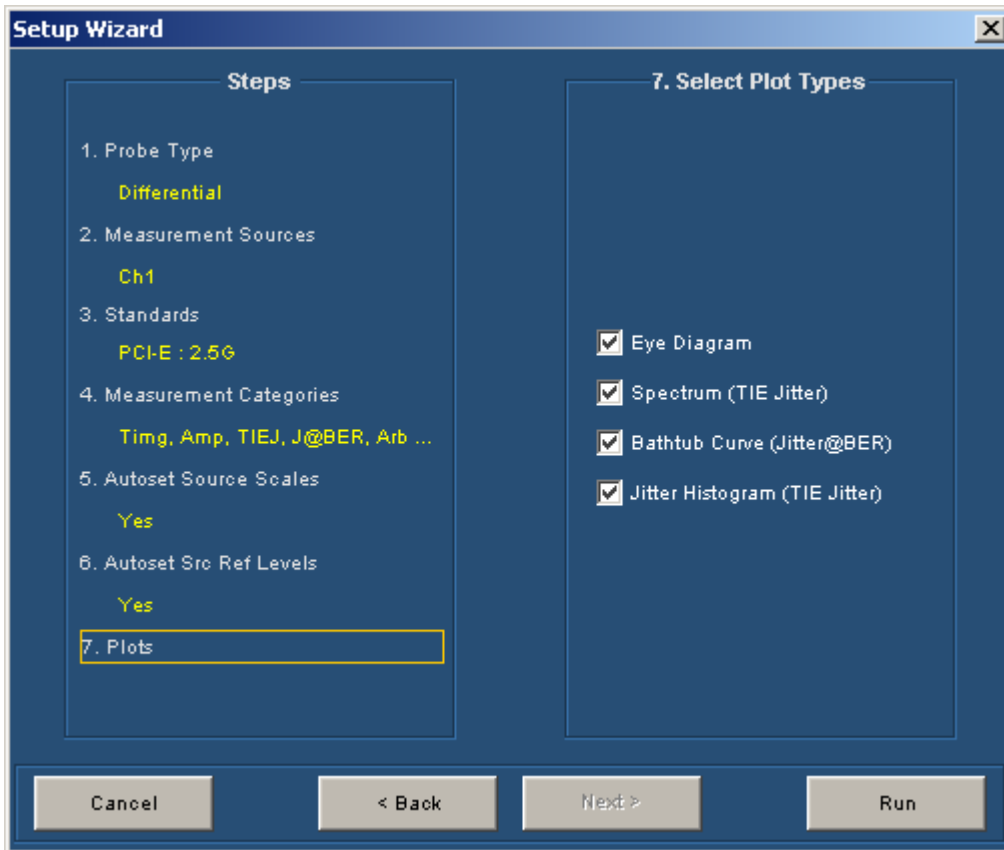

Figure 5-4: Plots

7. Proceed to Run the Analysis and View the Results.

## **Use TCA-SMA Adapters on CH1 and CH3 as Single-Ended Sources for Analysis**

1. Use a 1 Meter SMA cable and TCA-SMA adapter to connect between "D+" on the training board and CH1 on the oscilloscope.
2. Use another 1 Meter SMA cable and TCA-SMA adapter to connect between "D-" on the training board and CH3 on the oscilloscope.
3. Push the CH3 vertical channel button to display Ch3.
4. Push the AUTOSET front-panel button to view both signals.
5. Adjust both Ch1 and Ch3 to 200 mV/div to get a better view of the waveforms.
6. Select Measurement> Wizard to run the Serial Data Wizard.

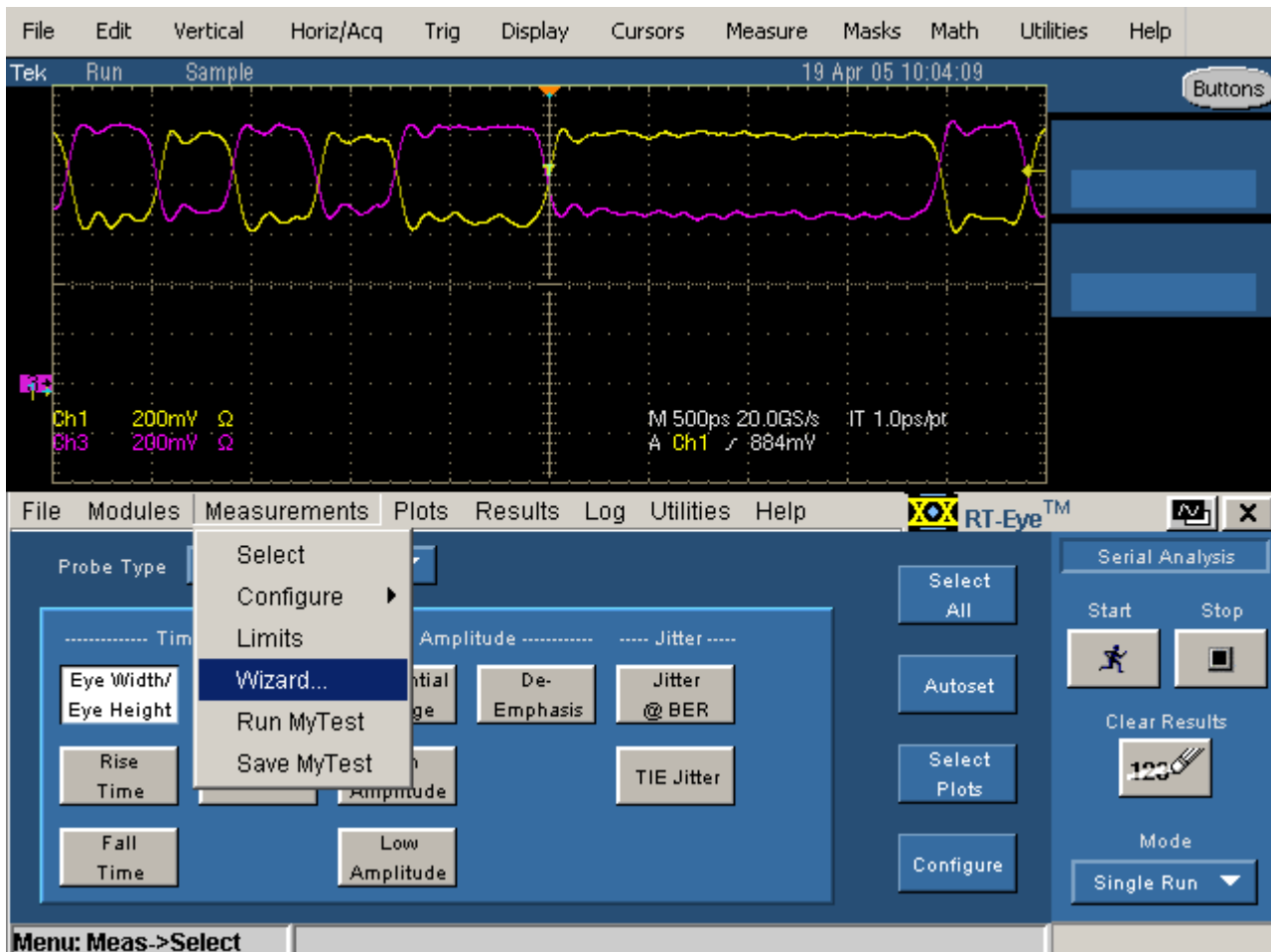

Figure 5-5: Measurement wizard screen

7. Make Wizard Selections as shown in the yellow text in the following figure.

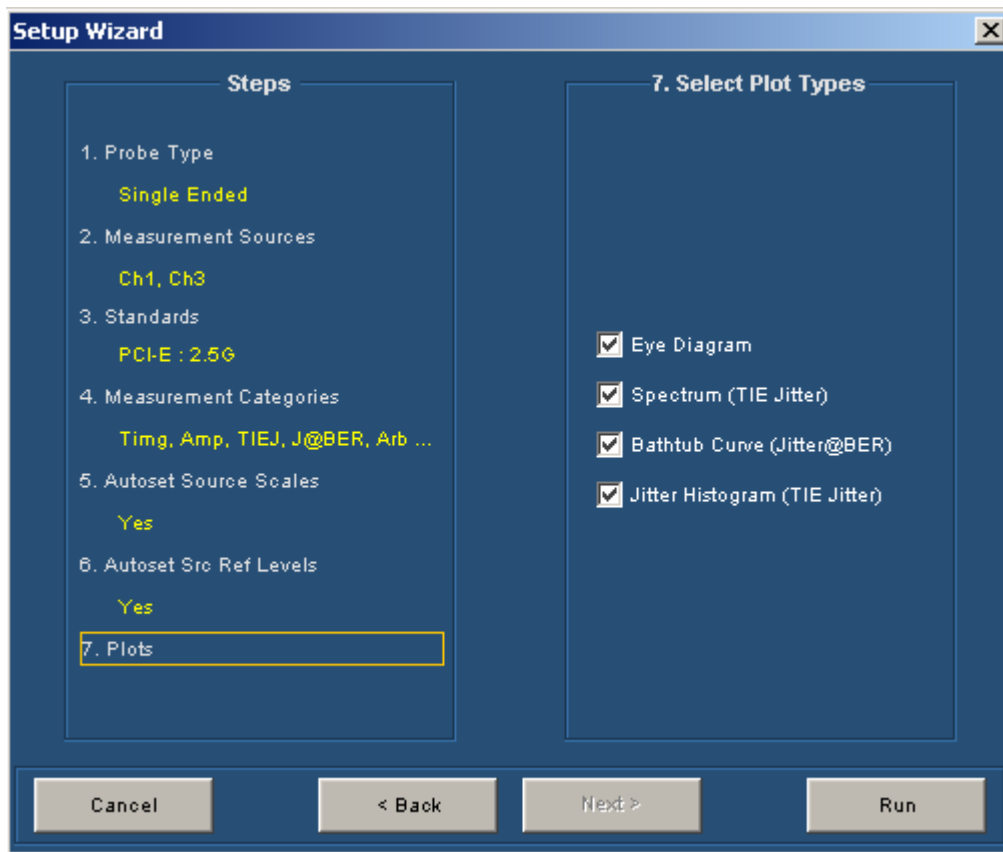

Figure 5-6: Types of plots selected

8. Proceed to Run the Analysis and View the Results.

## Run the Analysis and View the Results

1. Run the Analysis by clicking  in the Wizard.
2. The result of the analysis is displayed as shown in the following figure.

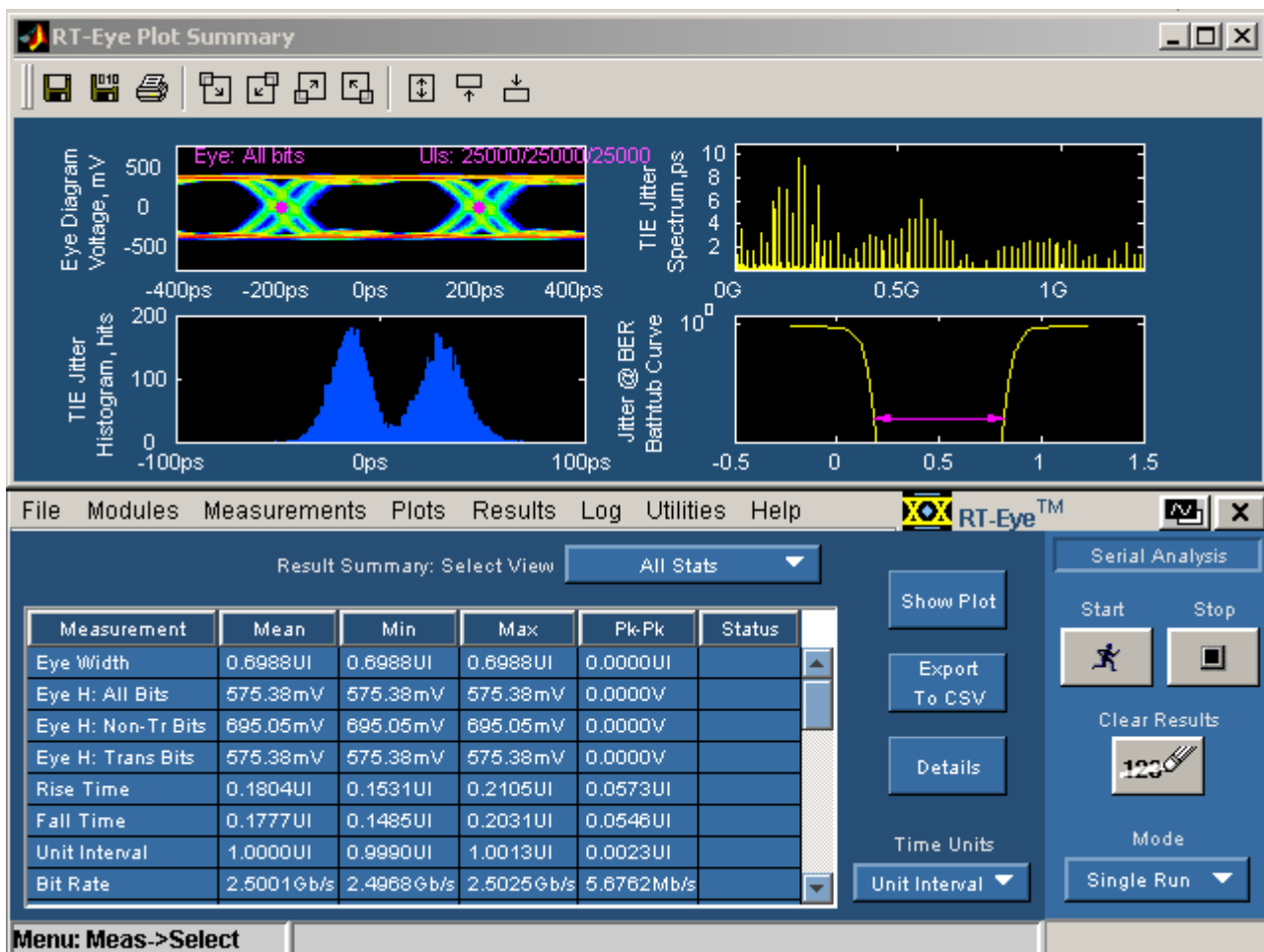

Figure 5-7: Analysis results

Statistics of measurement results are shown in the lower half of the oscilloscope display. The RT-Eye diagram and Mask are shown in the upper half of the oscilloscope display. You can change the Time units from UIs to seconds depending on what the standard calls for. The magenta dots in the Eye diagram represent the recovered clock. The Eye diagram shows statistical representation of the Eye diagram in an accumulated waveform database display. Multiple jitter plots (the TIE Jitter Histogram, Spectrum, and Bathhtub curve) are also displayed. Click the Details button to view the details of each measurement.

3. Proceed to [MJSQ Jitter Analysis](#).

## MJSQ Jitter Analysis

This section describes how to perform jitter analysis compliant with the T11.2 MJSQ methodology using the Spectrum Approach to Jitter Analysis. In the previous section, the default method (Arbitrary Pattern) was used as the Jitter method. To perform analysis consistent with T11.2 MJSQ "spectrum approach", a repeating pattern is used. The signal being used in this lab is a 127 bit PRBS repeating pattern. To change to the repeating pattern method, follow these steps:

1. Select Measurements> Configure> Jitter
2. Select Type> Repeating
3. Select Pattern> Custom
4. Input 127 UI into the Pattern Length Control.

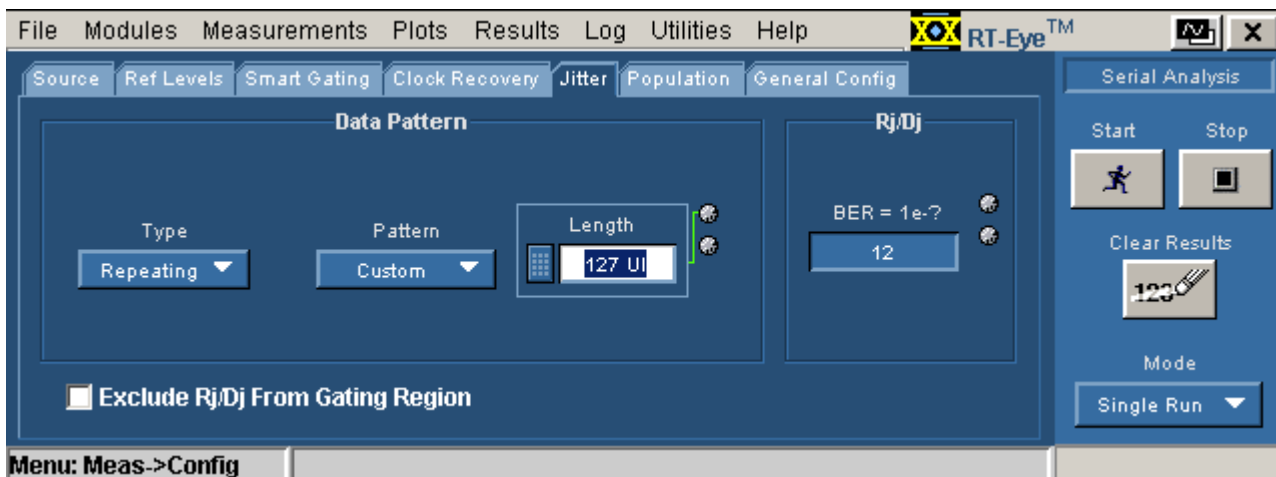

Figure 5-8: Jitter

5. Click Clear Results.
6. Click Start to perform the Analysis.
7. Select Jitter @ BER from the Results Details: Select Measurement pull-down.



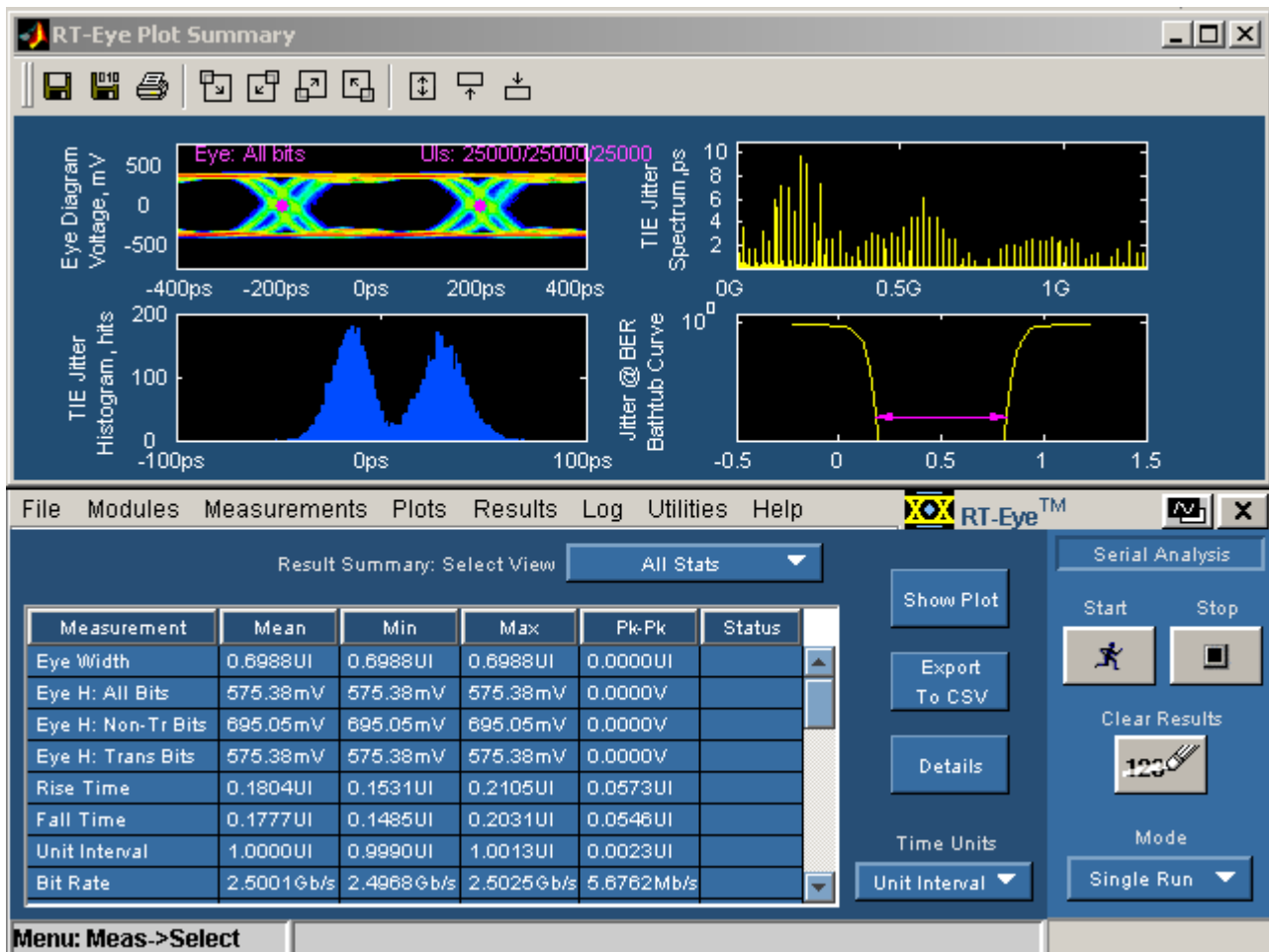

Figure 5-9: Results Summary

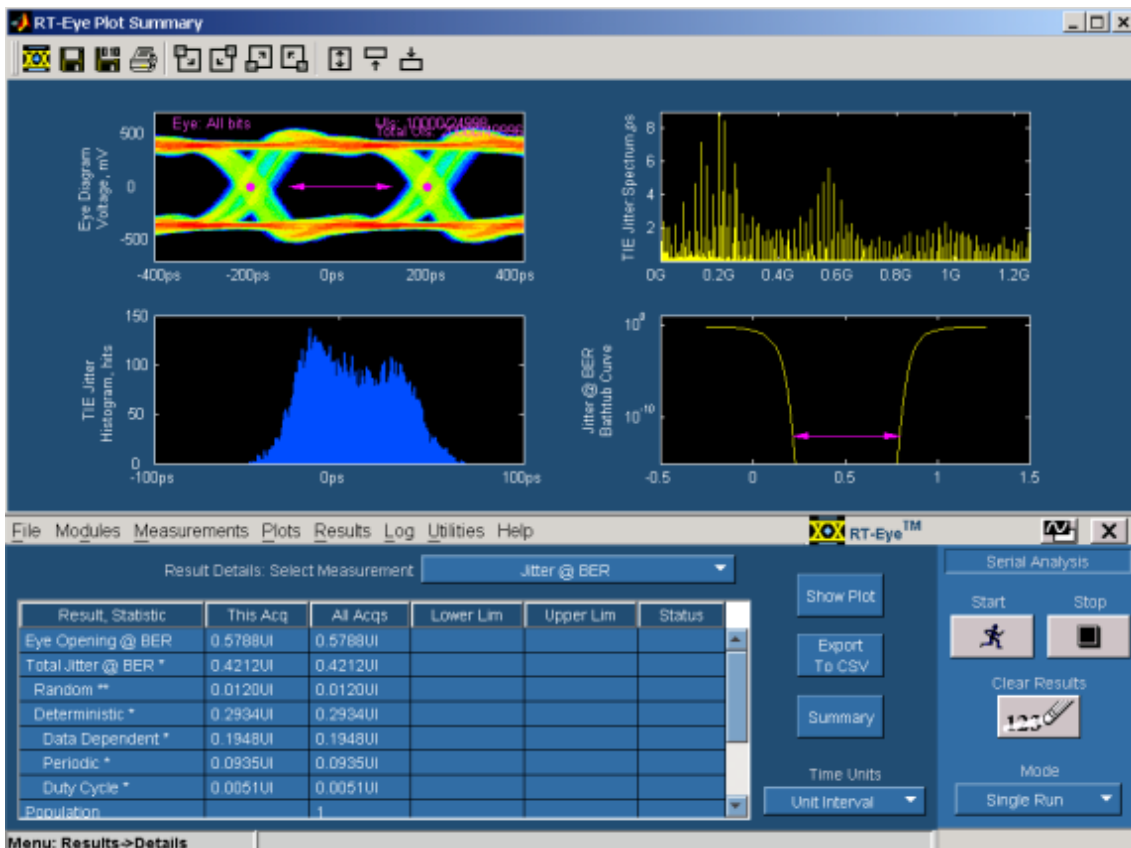

Figure 5-10: Results details

The three views of Jitter and the measurements provide a good way to see how Jitter measurements are made with the Spectrum Method of R<sub>j</sub>/D<sub>j</sub> separation. The TIE Histogram (lower left plot) is the traditional way of measuring jitter on an oscilloscope. This method is limited by the amount of statistical certainty that can be achieved in a reasonable amount of time. Thus, more advanced DSP methods are used to determine the Jitter Eye Opening, Total Jitter, Random Jitter, and Deterministic Jitter.

The TIE measurements are transformed into the frequency domain by performing an FFT on the raw TIE data, thus creating the jitter spectrum shown in the upper right plot. The spikes in the frequency domain represent Deterministic jitter. Further analysis can be done to determine which spikes are Duty Cycle Distortion (DCD) or Data Dependent (DDJ-also known as ISI), and which are Periodic (PJ). Once these values are removed (DJ), then what is left is a noise floor which represents the Random Jitter (RJ). These values are used to create the Cumulative Distribution Function (CDF), commonly known as the Bathtub Curve, shown in the lower right hand plot. The magenta line at 10<sup>-12</sup> BER represents the Jitter Eye Opening measurement.

The following equation can be solved using the measurement results:

$$\text{Jitter Eye Opening} + \text{Total Jitter} = 1\text{UI}$$

8. Proceed to [Using MyTest](#).

## Using MyTest

MyTest allows you to save your favorite test and run it automatically when you start the application. For example, now that you have performed the MJSQ jitter test, you can use the following procedure to save and run the MJSQ jitter test as MyTest.

1. Select Measurements> Save MyTest
2. Select File> Exit
3. Select **No** when the dialog asks if you want to save oscilloscope settings.
4. Push the DEFAULT SETUP front-panel button to start from a known setup.
5. From the Oscilloscope application menu, select File> Run Application> RT-Eye Serial Compliance and Analysis on non-B models, or Applications> RT-Eye Serial Compliance and Analysis on B or C models.
6. After you launch the RT-Eye application, select Run Mytest from the welcome dialog box. In this example, the MJSQ test is run automatically.

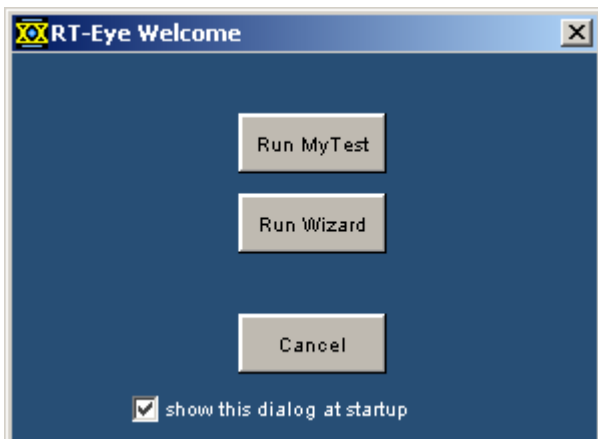

Figure 5-11: RT-Eye Welcome

The RT-Eye MyTest feature allows you to run your favorite test with a single click.

## Defining a Limits Module

This section demonstrates how to apply a limit to a measurement and create a custom Pass/Fail condition on the TIE jitter measurement described in the previous section.

1. Select the Measurement> Limits menu.
2. Select New under Measurement Limits Editor.
3. Select TIE Jitter as the Measurement.

4. Select Min as Statistic and Enter -60ps for limit.
5. Select the + button to add a measurement limit.
6. Select TIE Jitter as the Measurement.
7. Select Max as Statistic and Enter +60ps for limit.



**Figure 5-12: Measurement limits**

8. Click the Save As button.
9. Save file as Jitter.lim.
10. Close Limits Editor.
11. Select Limits> Browse.
12. Select Jitter as the Limits File.
13. Click Open.
14. Select Limits> On.
15. Return to Results> Details menu.
16. Click the Clear Results button.
17. Click the Start button.

Result	Statistic	This Acq	All Acqs	Lower Lim	Upper Lim	Status
Population		125	125			
Mean		221.59ps	221.59ps			
StdDev		22.66ps	22.66ps			
Max		82.56ps	52.56ps		60.00ps	FAIL
Min		-41.67ps	-41.67ps	-60.00ps		PASS
Pk-Pk		94.23ps	94.23ps			

**Figure 5-13: Results details**

18. The defined Pass/Fail status appears in the Status column of the Results panel. Proceed to Creating a Compliance Report.

## Creating a Compliance Report

This section demonstrates how to create a compliance report based on the previous analysis.

1. Select Utilities> Reports.
2. Click Generate. The resulting report can be exported to an RTF file format and read by other applications such as Microsoft Word. The report can also be printed to a PDF file if a PDF distiller is installed on the instrument.

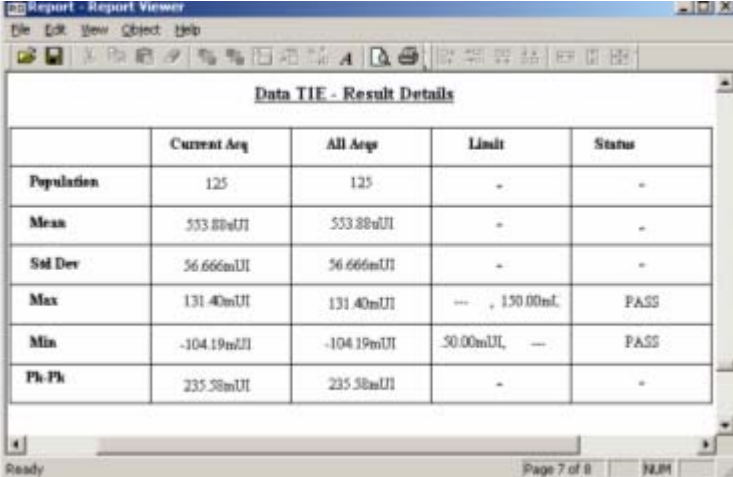

	Current Avg	All Aeps	Limit	Status
Population	125	125	-	-
Mean	553.88mUI	553.88mUI	-	-
Std Dev	56.666mUI	56.666mUI	-	-
Max	131.40mUI	131.40mUI	--- , 150.00mI	PASS
Min	-104.19mUI	-104.19mUI	-50.00mUI, ---	PASS
Ph-Ph	235.58mUI	235.58mUI	-	-

Figure 5-14: Report in PDF format

3. Proceed to PCI Express Compliance Test.

## PCI Express Compliance Tests

This section demonstrates how to perform a PCI Express Compliance Test. The PCI Express module must be present to complete this part of the lab. If your instrument does not have a PCI Express Compliance Module installed, proceed to Serial Analysis Lab Conclusion.

1. Select Modules> PCI Express from the RT-Eye menu.
2. Click the Select Required button.
3. Select Test Point> Driver.
4. Select the correct Probe Type (Single Ended or Differential) depending on your probe configuration.
5. Click the Autoset button.

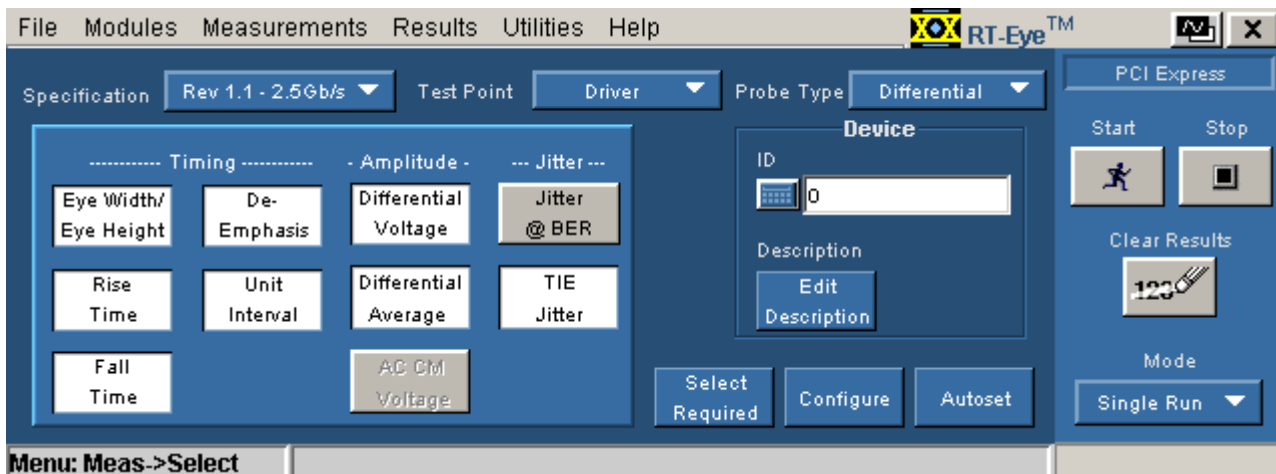

Figure 5-15: PCI express compliance test

6. Click the Start Button.

## Results of PCI Express Add in Card Compliance Test

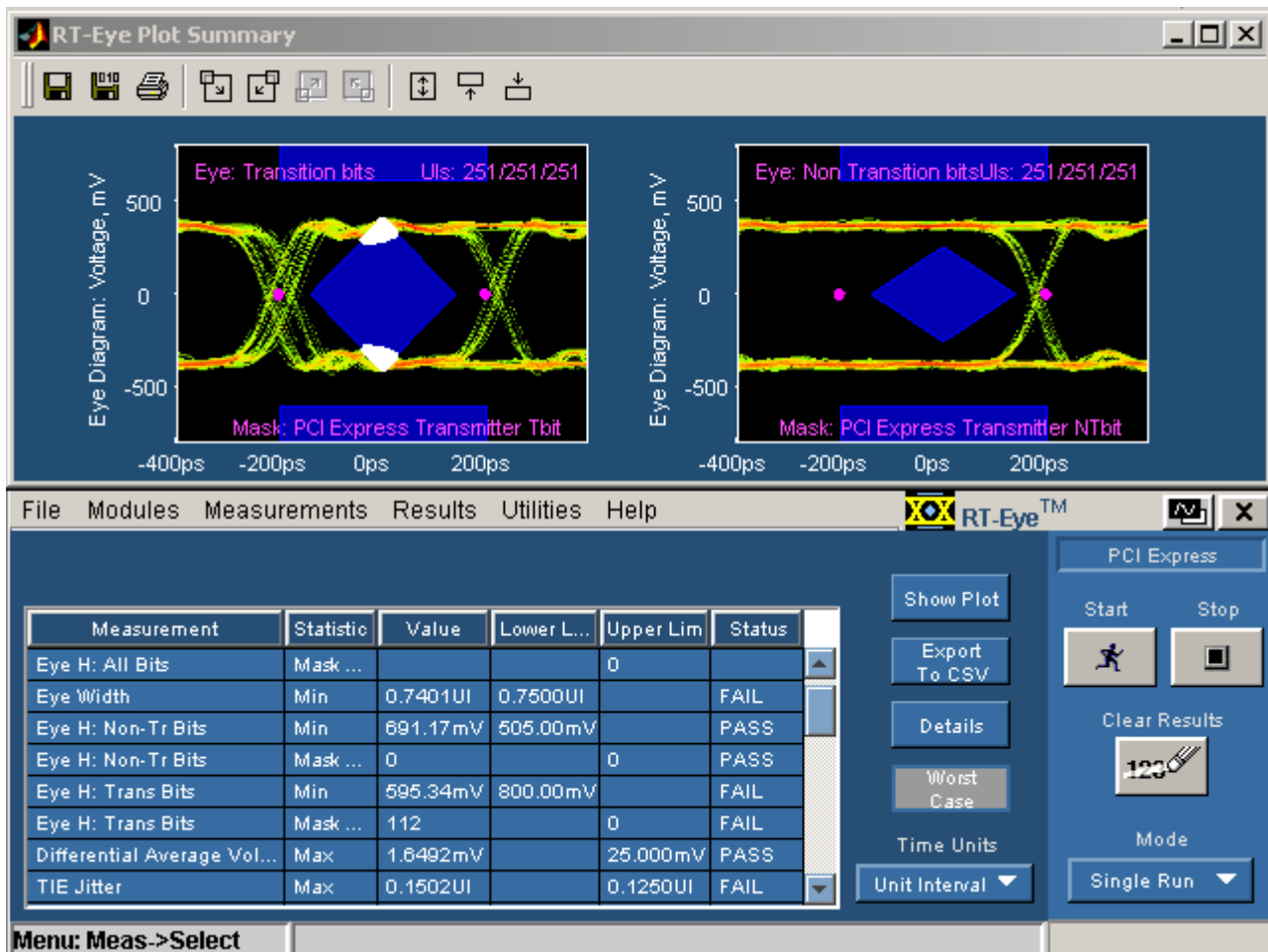

Figure 5-16: Results of PCI express Add in card compliance test

In this example, the signal under test fails the PCI Express compliance test. This is because the PCI Express specification calls for 3-4dB of De-emphasis on the nontransition bits (or pre-emphasis on transition bits). Since the signal does not have the proper level of de-emphasis, it fails the transition bit mask. The number of mask hits shows up in the compliance results as a mask failure.

7. Click the Clear Results button.
8. Return to the Measurement> Select menu.
9. Select Receiver as the Test Point.
10. Click the Select Required button.

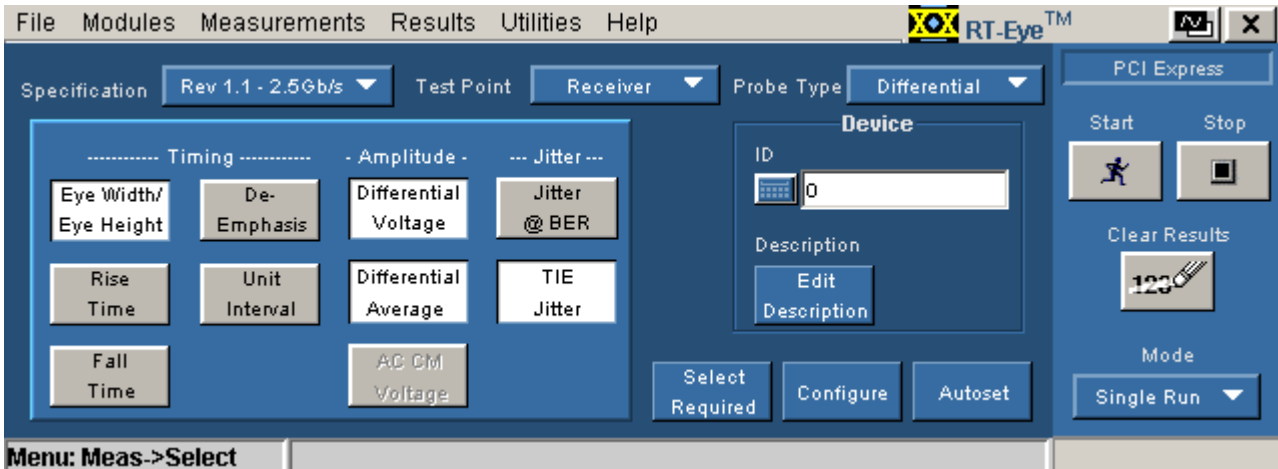

Figure 5-17: PCI express compliance test

11. Click the Start button.

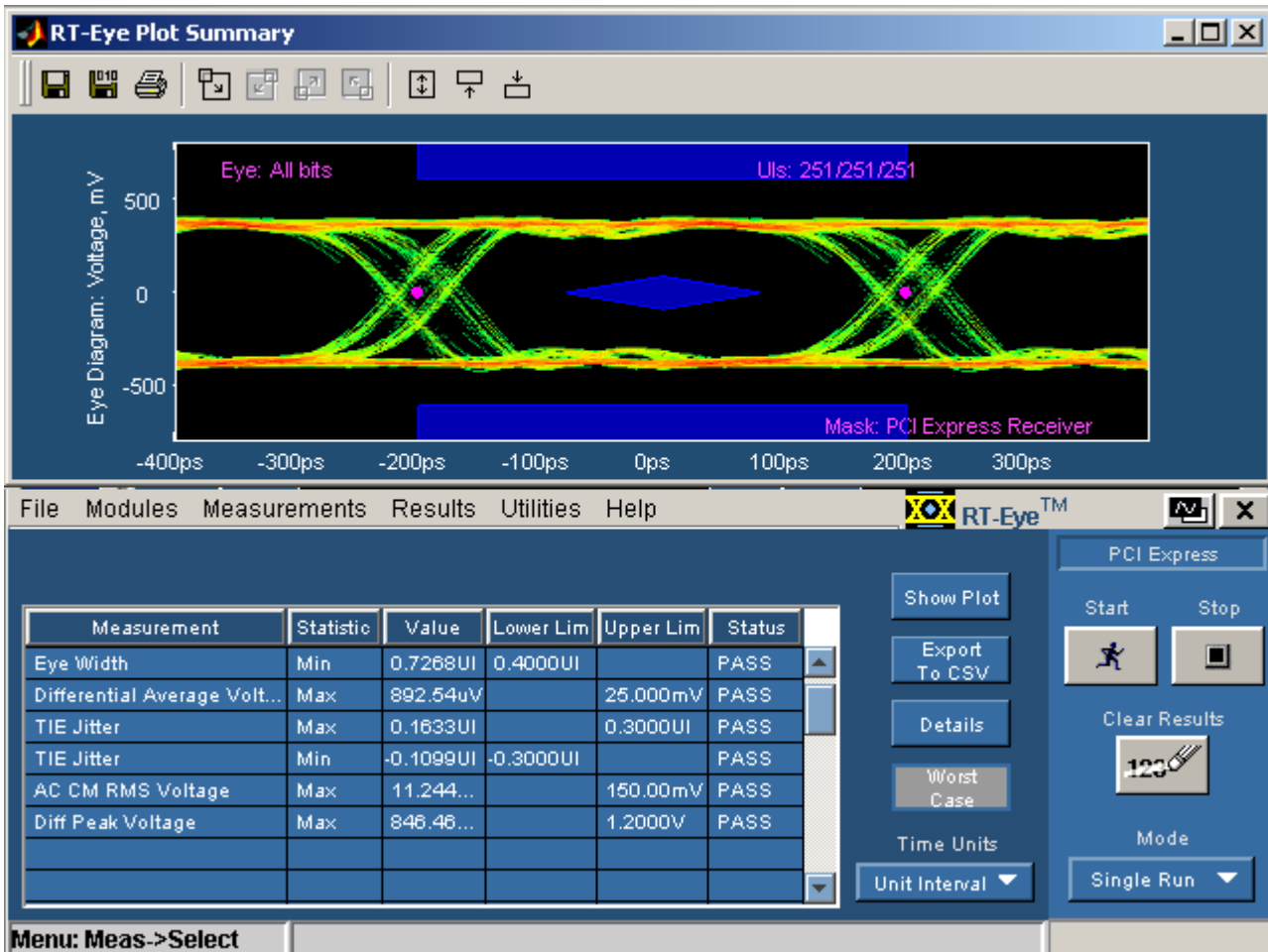

Figure 5-18: Results of PCI express compliance test



In the PCI Express Receiver test, there is a single Receiver Mask. This test is performed by probing a device close to the receiver pins of a SerDes. This signal passes the receiver compliance test.

**12.** Proceed to Serial Analysis Lab Conclusion.

## **Serial Analysis Lab Conclusion**

Congratulations! You have completed the RT-Eye Serial Analysis Lab. We hope that this has been helpful in understanding the capabilities of the RT-Eye software solution and will help you in the validation and compliance testing of your devices.





# Parameters

## About Application Parameters

This section describes the RT-Eye application parameters and includes the menu default settings. Refer to the user manual for your oscilloscope for operating details of other controls, such as front-panel buttons.

The parameter tables list the selections or range of values available for each option, the incremental unit of numeric values, and the default selection or value.

Refer to the GPIB topics for a complete list of the [GPIB Command Syntax](#). The topics include a complete list of the GPIB commands along with the arguments, variables, and variable values that correspond to the RT-Eye parameters.

---

***Note:** Unit values shown are valid when the FINE button is enabled on the oscilloscope.*

## File Menus Parameters

The File drop-down list includes the following command buttons:

- Recall Default
- Minimize
- Exit

**Table 6-1: File menu parameters**

Option	Parameters	Default setting
Recall	<Browser>	Default directory*
Save	<Browser>	Default directory*
Recall Recent	Lists up to five most recently saved or accessed setup files: 1. <setup file name> 2. <setup file name> 3. <setup file name> 4. <setup file name> 5. <setup file name>	Default directory*
Preferences	See File Preferences Menu Parameters topic, next	
* Refer to the Application Directories and Usage topic for default path names.		

## File Preferences Menu Parameters

The File Preferences menu includes the following command buttons:

- Cancel
- OK

**Table 6-2: File preferences menu parameters**

Option	Parameters	Default setting
Show Welcome Dialog at Startup	Set, Clear	Set
Show Autoset Summary when Autoset is selected	Set, Clear	Set
Enable high-performance eye rendering	Set, Clear	Set

## Control Panel Parameters

The Control Panel menu includes the following command buttons:

- Start
- Stop
- Clear Results

**Table 6-3: Control panel parameters**

Option	Parameters	Default setting
Mode	Single Run, Single No Acq, Free Run	Single Run

## Measurements Select Menu Parameters

Available measurements in the Measurements Select menu are dependant on the selection for the Probe Type option. Measurements available by area are as follows:

- Timing area: Rise Time, Fall Time, Unit Interval, Bit Rate, Eye Height, Eye Width, and Differential Skew
- Amplitude area: Differential Voltage, High Amplitude, Low Amplitude, CM Voltage, AC CM Voltage, and De-Emphasis
- Jitter area: Jitter@BER and TIE Jitter

---

**Note:** *The Differential Skew, CM Voltage, and AC CM Voltage measurements are added when you select Single Ended as the Probe Type option.*

---

## Autoset Summary Menu Parameters

The Autoset Summary menu includes the following command buttons:

- Autoset
- Configure
- Close

**Table 6-4: Autoset summary menu parameters**

Option	Parameters	Default setting
Do not show this menu again	Set, Clear	Clear

## Measurements Configure Menus

The application includes the following Measurements Configure menus:

- [Source](#) for Single Ended Probes or [Source](#) for Differential Probes
- Ref Levels
- Smart Gating
- Clock Recovery
- Jitter Method
- Population
- General Config

---

*Note: These menus are generally referred to as the Configure menus.*

---

The application automatically calculates parameters for reference voltage levels in the Ref Level Autoset Setup menu. Display the [Ref Level Autoset Setup menu parameters](#).

## Configure Source Menu Parameters for Differential Probes

The Configure Source menu includes the following command buttons in the Autoset area:

- Vertical Scale
- Horizontal Resolution
- Vertical & Horizontal

**Table 6-5: Source menu parameters for differential probes**

Option	Parameters	Default setting
Live/Ref Select Differential	Ch1, Ch2, Ch3, Ch4, Ref1, Ref2, Ref3, Ref4	Ch1
File Differential File	<Browser>	Default directory*
* Refer to the Application Directories and Usage topic for default path names.		

## Configure Source Menu Parameters for Single-Ended Probes

The Configure Source menu includes the following command buttons in the Autoset area:

- Vertical Scale
- Horizontal Resolution
- Vertical & Horizontal

**Table 6-6: Source menu parameters for single-ended probes**

Option	Parameters	Default setting
Live Select D+, D-	Ch1, Ch3 Ch1, Ch4 Ch2, Ch3 Ch2, Ch4	Ch1, Ch3
Ref	All combinations of two Ref waveforms	Ref1, Ref2
File Select File D+	<Browser>	Default directory*
File Select File D-	<Browser>	Default directory*
* Refer to the Application Directories and Usage topic for default path names.		



## Configure Ref Levels Menu Parameters

The Configure Ref Levels menu includes the following command buttons in the Autoset area:

- Setup
- Run

**Table 6-7: Reference level parameters**

Option	Parameters	Default setting
Source	Differential, DPlus*,DMinus*	Differential
Rise, High	10.00 V to -10.00 V in units of 1 mV	400 mV
Rise, Mid	10.00 V to -10.00 V in units of 1 mV	0 V
Rise, Low	10.00 V to -10.00 V in units of 1 mV	-400 mV
Fall, High	10.00 V to -10.00 V in units of 1 mV	400 mV
Fall, Mid	10.00 V to -10.00 V in units of 1 mV	0 V
Fall, Low	10.00 V to -10.00 V in units of 1 mV	-400 mV
Hysteresis	0 V to 10.00 V in units of 10 mV	30 mV
Mid = 0V**	Set, Clear	0 V (set)
* Only available when Single Ended is the Probe Type option.		
** 50% ( $V_{Ref\_MID}$ ) of signal swing if the option is clear.		

## Configure Ref Level Autoset Setup Menu Parameters

The Configure Ref Level Autoset Setup menu includes the following command buttons:

- OK
- Cancel

**Table 6-8: Reference level autoset set up menu parameters**

Option	Parameters*	Default setting
Rise, High	0 to 100% in units of 1%	80%
Rise, Mid	0 to 100% in units of 1%	50%
Rise, Low	0 to 100% in units of 1%	20%
Fall, High	0 to 100% in units of 1%	80%
Fall, Mid	0 to 100% in units of 1%	50%
Fall, Low	0 to 100% in units of 1%	20%
Hysteresis	0 to 50% in units of 1%	3%
* Where 0% = $\text{mean}(V_{EYE-HI-TRAN}(n))$ and 100% = $\text{mean}(V_{EYE-LO-TRAN}(n))$ .		

## Configure Smart Gating Menu Parameters

Table 6-9: Smart gating menu parameters

Option	Parameters	Default setting
Gating	Off, Cursors, Smart Gating	Off

## Configure Smart Gating Menu with Smart Gating Parameters

The value that displays under Stop shows the sum of the Length and Start options.

Table 6-10: Smart gating menu with smart gating parameters

Area	Option	Parameters	Default setting
Gating	Off	-	Off
	Cursors		
	Smart Gating		
Clock Recovery (CR) Window	Length	1 to 50 M	3.5k
	Start	1 to 50 M	1
	Stop	-	-
	Scan Incr	1 to 50 M	1
	#Scans	1 to 50 M	1
	Scan to End of Record	-	Selected
	Enable Scan	-	Cleared
Gating Units	Unit Intervals, Edges	-	Unit Intervals
Analysis Window (Relative to CR Window)	Same as Clock Recovery Window	Select, Clear	Selected
	Alignment*	Centered, User Defined	Centered
	Length*	1 to 50 M in increments of 1	250
	Start***	1 to 50 M in increments of 1	1.626k
	Stop	-	-
* Available when you clear the Same as Clock Recovery Window check box.			
** Available when you select User Defined as the Alignment option.			

## Configure Clock Recovery Menu Parameters

Table 6-11: Clock recovery menu parameters

Area	Option	Parameters	Default setting
Clock Recovery	Method	Const Clk: Mean, Const Clk: Median, PLL: Standard BW, PLL: User BW	PLL: Standard BW
Nominal Data Rate	On		Off
	Off		
	Bit Rate*	1 to 10 e <sup>9</sup> bits/second	2.5 Gb/s
PLL Loop BW	User BW**	10 kHz to 1 GHz	15 MHz
	Standard: b/s <sup>†</sup>	PCI-E: 2.5 G, 100BaseT: 125 M, 1394b S400b: 491.5 M, 1394b S800b: 983.0 M, 1394b S1600b: 1.966 G, FC133: 132.8 M, FC266: 265.6 M, FC531: 531.2 M, FC1063: 1.063 G, FC2125: 2.125 G, FC4250: 4.25 G, FC8500: 8.5 G, FBD1: 3.2 G, FBD2: 4.0 G, FBD3: 4.8 G, GB Ethernet: 1.25 G, IBA2500: 2.5 G, IBA_GEN2: 5.0 G, OC1: 51.8 M, OC3: 155 M, OC12: 622 M, OC48: 2.488 G, PCI_E_GEN2: 5.0 G, RIO125: 1.25 G, RIO250: 2.5 G, SAS3: 3.0 G, SAS6: 6.0 G, SAS15: 1.5 G, SerATAG1: 1.5 G, SerATAG2: 3.0 G, SerATAG3: 6.0 G, USB FS: 12 M, USB HS: 480 M, XAUI: 3.125 G, XAUI_GEN2: 6.25 G	PCI-E: 2.5 G
PLL	PLL Order <sup>‡</sup>	First, Second	First
	Damping	0.5 to 1.0	0.7
<b>* Available only when Nominal Data Rate is On.</b>			
<b>** Available only when Method is PLL: User BW.</b>			
<b>† Available only when Method is PLL: Standard BW.</b>			
<b>‡ Available only when Method is PLL: User BW or PLL: Standard BW.</b>			
<b>Damping is only available for Second Order PLL.</b>			

## Configure Jitter Menu Parameters

Table 6-12: Jitter menu parameters

Area	Option	Parameters	Default setting
Data Pattern	Type	Repeating, Arbitrary	Repeating
	Pattern	B2BTS1, CJTPAT, CSPAT, PCE-CTP, FBD-IBIST, Custom	CJTPAT
	Length*	1 to 200 k unit intervals	2.5 k UI
	Window Length <sup>†</sup>	2 to 16 unit intervals	5 UI
	Population <sup>†</sup>	5 to 5000 samples	100 samples
Rj/Dj	BER=1 e <sup>-2‡</sup>	2 to 15 (1e <sup>-2</sup> to 1e <sup>-15</sup> )	12 (BER = 1e <sup>-12</sup> )
* Available only when Type is Repeating.			
** Available only when Type is Repeating and Pattern is Custom.			
† Available only when Type is Arbitrary.			
‡ Available only when the Jitter@BER measurement is selected.			

## Configure Population Menu Parameters

Table 6-13: Population menu parameters

Area/option	Parameters	Default setting
Population Limit	On, Off	Off
Configure Limit By Limit	Acquisitions, Measurement	Acquisitions
	1 to 10 T in units of 1	1 K

## Configure General Config Parameters

Table 6-14: General config parameters

Option	Parameters	Default setting
Limit Rise/Fall measurements to transition bits only	Yes, No	No
Limit Amplitude measurements to transition bits only	Yes, No	No
Enable worst-case logging while in scan mode	Yes, No	Yes

## Measurements Limits Menu Parameters

Table 6-15: Measurement limits parameters

Option	Parameters	Default setting
Limits	On, Off	Off
Limits File Editor	Current, New	none
Limits File	<Browser>	Default directory*
* Refer to the Application Directories and Usage topic for default path names.		

## Results Menus

The application includes the following Results Menus:

- Summary
- Details

## Results Summary Menu Parameters

The Results Summary menu includes the following command buttons:

- Show Plot
- Export to CSV

Table 6-16: Results summary menu parameters

Option	Parameters	Default setting
Select View	All Stats, Limits Status*	All Stats
Time Units	Unit Intervals, Seconds	Unit Intervals
* Available only when Measurements Limits is enabled.		

## Results Details Menu Parameters

The Results Details menu includes the following command buttons:

- Show Plot
- Export to CSV

**Table 6-17: Results details menu parameters**

Option	Parameters	Default setting
Select View	<list of all selected measurements>	<first selected>
Time Units	Unit Intervals, Seconds	Unit Intervals

## Plots Select Menu Parameters

The Plots Select menu includes the following command button:

- Refresh

**Table 6-18: Plots select menu parameters**

Option	Parameters	Default setting
Measurement	<any selected measurement>	Eye Width
Plot Type	See Measurement and Available Plots topic	Eye Diagram
Plots Display	On, Off	On

## Eye Diagram Configure Menu Parameters

Table 6-19: Eye diagram configure menu parameters

Area/option	Parameters	Default setting
Bit Type	All, Transition, Non Transition	All
Mask	On, Off	Off
Standard	InfiniBand, PCI Express, User*	InfiniBand
Type for InfiniBand	Receiver, Cable, TP1, TP2, TP3, TP4, TP5, TP6, TP7, TP8, TP9, TP10	Receiver
for PCI Express	Receiver, Transmitter Tbit, Transmitter NTbit	Receiver
* When you select User, a file browser displays; refer to the User Mask topics.		

## Histogram Plot Configure Menu Parameters

Table 6-20: Histogram plot configure menu parameters

Option	Parameters	Default setting
Vertical Axis	Linear, Log	Linear
Bin Resolution	1 to 50 K in units of 1	250

## Spectrum Plot Configure Menu Parameters

Table 6-21: Spectrum plot configure menu parameters

Option	Parameters	Default setting
Vert. Scale	Linear, Log	Linear
Horiz. Scale	Linear, Log	Linear

## Bathtub Plot Configure Menu Parameter

Table 6-22: Bathtub plot configure menu parameters

Option	Parameter	Default setting
Scale	Linear, Log	Linear



## Log Worst Case Configure Menu Parameters

The Log Worst Case menu includes the following command button:

- Purge

**Table 6-23: Log worst case configure menu parameters**

Option	Parameters	Default setting
Log	On, Off	Off
Choose Directory	<Browser>	Default directory*
* Refer to the Application Directories and Usage topic for default path names.		

## Utilities Report Generator Menus Parameters

There are no parameters for the Report Generator utility menus.

## Help Menu

There are no parameters for the Help menu.

# Algorithms

## About Measurement Algorithms

The RT-Eye application can take measurements from one or two serial data waveforms. The number of waveforms used by the application depends on the probe selected in the Probe Type option of the Measurements> Select menu.



**Tip** The Algorithms book includes Field Notes that you may use to ensure good measurement results.

## Oscilloscope Setup Guidelines

For all measurements, use the following guidelines to set up the oscilloscope:

1. The signal is any channel, reference, or math waveform.
2. The vertical scale for the waveform must be set so that the waveform does not exceed the vertical range of the oscilloscope.
3. The sample rate must be set small enough to capture sufficient waveform detail and avoid aliasing.
4. Longer record lengths increase measurement accuracy (though at the same time decrease measurement speed)

## Test Methodology

The application performs the measurement according to the following steps:

1. Imports the current waveform.
2. For timing measurements, checks that there are a minimum number of edges in the waveform to calculate the measurement as follows:
  - Single edge: Rise Time, Fall Time
  - Two cycle-start edges: Unit Interval
  - Three cycle-start edges: TIE
  - Jitter measurements require at least 50 pattern repeats for RjDj analysis; accuracy may be degraded for fewer than 100 pattern repeats
  - Two edges on each of two waveforms: Differential Skew
3. Performs the measurement.
4. Displays the results as statistics where you can save the results to a .csv file.
5. Displays the results as a plot if defined and enabled.

## Measurements

**Table 7-1: Measurements**

Button name	Measurement names	Applicable module test
<b>Timing</b>		
Eye Width/ Eye Height	Eye Width Eye Height Eye Height: Transition Bits Eye Height: Non-Transition Bits	Eye Height: All Eye Width: Infiniband-Cable Assembly, PCI Express, Serial Analysis.
Rise Time	Rise Time	All. Applied to $v_{D+}$ and $v_{D-}$ in PCI Express w/ Single-Ended Probes.
Fall Time	Fall Time	All. Applied to $v_{D+}$ and $v_{D-}$ in PCI Express w/ Single-Ended Probes.
Unit Interval	Unit Interval	Infiniband-Driver, PCI-Express, Serial Analysis.
Bit Rate	Bit Rate	Serial Analysis.
Differential Skew*	Differential Skew	Serial Analysis.
<b>Amplitude</b>		
Differential Voltage	Differential Amplitude	Infiniband-Driver/Receiver, Serial Analysis.
	Differential Peak Voltage	PCI Express.
Differential Average		PCI Express-Driver.
High Amplitude	High Amplitude	Serial Analysis.
Low Amplitude	Low Amplitude	Serial Analysis.
CM Voltage*	CM Voltage	Infiniband-Driver/Receiver, PCI Express, Serial Analysis.
AC CM Voltage*	AC CM Voltage	Serial Analysis.
	AC CM RMS Voltage	InfiniBand and PCI-Express Driver.
	AC CM Pk Voltage	PCI-Express Receiver
De-Emphasis	De-Emphasis	PCI-Express Driver, Serial Analysis.
<b>Jitter</b>		
Jitter @ BER	Jitter @ BER Jitter: Eye Opening Jitter: Total (TJ) Jitter: Deterministic (DJ) Jitter: Random (RJ)	Infiniband-Driver/Receiver, Serial Analysis RJ only available in Serial Analysis.
TIE Jitter	TIE Jitter	Infiniband-Cable Assembly, PCI Express, Serial Analysis.
* Available only when Single Ended is the Probe Type option in the Measurements Select menu.		

## Notation in Algorithms

### About Notation in Algorithms

All measurements are made on one of several voltage waveforms. Timing measurements are based on edge locations in the waveform or on clock edge times derived from the waveform edge locations. Amplitude measurements are made on the entire waveform or on waveform values based on recovered clock times. To represent measurements as formulas, the algorithm descriptions follow notational rules.

### Notational Rules

Table 7-2: Notational rules

Notation	Use
Lower case character	Reserved for fundamental signals or measurements. For instance, sampled waveforms are of the form $v(i)$ and edge times are of the form $t(n)$ . The character is indicative of the units of the quantity, such as $v$ for a voltage and $t$ for a time. They are always indexed.
Upper case character	Used for a quantity that is fixed or for a measurement. The character is indicative of the units of the quantity, such as $V$ for a voltage and $T$ for a time.
Subscripts	Used to identify the variable, measurement or quantity.
Indices variables	Indices for variables or measurements have multiple values over the course of an acquisition. The indices are between parentheses. If the index is a measurement, it will have statistics for both the current acquisition and all acquisitions (accumulated). Non-indexed measurements that have a single result for the entire waveform will only have all acquisition statistics.

## Summary Definitions of Fundamental Signals and Measurements

The next several topics list the annotation of the signals and measurements as they appear in the algorithm specific to each measurement. The algorithms comprise the following types of annotation:

- [Waveforms](#)
- [Edge Time Threshold Voltages](#)
- [Crossing Times](#)
- [Recovered Clock Times](#)
- [Eye Center Voltages](#)

### Waveforms

**Table 7-3: Waveforms**

Waveform	Definition
$i$	Index into sampled voltage waveforms
$v_{D+}(i)$	Positive conductor (D+) voltage acquired with a single ended probe
$v_{D-}(i)$	Negative conductor (D-) voltage acquired with a single ended probe
$v_{DIFF}(i)$	Differential voltage signal acquired with either a differential probe or calculated from two single ended probe signals: $= v_{D+}(i) - v_{D-}(i)$
$v_{CM}(i)$	Common mode voltage calculated from two single ended probe signals: $= (v_{D+}(i) + v_{D-}(i))/2$

## Edge Time Threshold Voltages

Table 7-4: Edge time threshold voltages

Edge Time Threshold Voltage	Definition
$V_{REF-HI}$	High level reference voltage
$V_{REF-MID}$	Mid level reference voltage
$V_{REF-LO}$	Low level reference voltage
$V_{HYST}$	Hysteresis voltage; minimum voltage swing required at any threshold before a crossing is recognized

## Crossing Times

Table 7-5: Crossing times

Crossing Time	Definition
$n$	Index into array of crossing times
$t$	Interpolated time when $v_{DIFF}$ crosses a $V_{REF}$
$t_{HI}(n)$	When $v_{DIFF}(t)$ crosses $V_{REF-HI}$
$t_{DAT}(n)$	When $v_{DIFF}(t)$ crosses $V_{REF-MID}$
$t_{LO}(n)$	When $v_{DIFF}(t)$ crosses $V_{REF-LO}$
$t_{D+HI}(n)$	When $v_{D+}(t)$ crosses $V_{D+REF-HI}$
$t_{D+MID}(n)$	When $v_{D+}(t)$ crosses $V_{D+REF-MID}$
$t_{D+LO}(n)$	When $v_{D+}(t)$ crosses $V_{D+REF-LO}$
$t_{D-HI}(n)$	When $v_{D-}(t)$ crosses $V_{D-REF-HI}$
$t_{D-MID}(n)$	When $v_{D-}(t)$ crosses $V_{D-REF-MID}$
$t_{D-LO}(n)$	When $v_{D-}(t)$ crosses $V_{D-REF-LO}$

## Recovered Clock Times

Table 7-6: Recovered clock times

Recovered Clock Time	Definition
$t_{R-CLK}(n)$	Recovered clock edge times referenced to the UI boundaries: = $PLL(t_{MID})$ for PLL based clock recovery = $CCR(t_{MID})$ for Constant Clock based clock recovery
$i_{UI-TRAN}(n)$	List of transition UIs immediately following a transition
$i_{UI-NTRAN}(n)$	List of non-transition UIs not immediately following a transition
$t_{R-DAT}(n)$	Recovered data edge times: = $t_{R-CLK}(i_{UI-TRAN}(n))$
$UI(n)$	Unit Interval (UI): = $t_{R-CLK}(n+1) - t_{R-CLK}(n)$

## Eye Center Voltages

Table 7-7: Eye center voltages

Eye Center Voltage	Definition
$v_{EYE}(n)$	Voltage at middle of a UI: = $v_{DIFF}(t_{R-CLK}(n) + UI_{AVG}/2)$
$v_{EYE-TRAN}(n)$	Voltage at middle of a transition UI*: = $v_{EYE}(i_{UI-TRAN}(n))$
$v_{EYE-NTRAN}(n)$	Voltage at middle of a non-transition UI*: = $v_{EYE}(i_{UI-NTRAN}(n))$
$v_{EYE-HI}(n)$	High voltage at middle of a UI*: = $\text{subset}(v_{EYE}(n) \geq 0)$
$v_{EYE-LO}(n)$	Low voltage at middle of a UI*: = $\text{subset}(v_{EYE}(n) < 0)$
$v_{EYE-HI-TRAN}(n)$	High voltage at middle of a transition UI*: = $v_{EYE-HI}(i_{UI-TRAN}(n))$
$v_{EYE-HI-NTRAN}(n)$	High voltage at middle of a non-transition UI*: = $v_{EYE-HI}(i_{UI-NTRAN}(n))$
$v_{EYE-LO-TRAN}(n)$	Low voltage at middle of a transition UI*: = $v_{EYE-LO}(i_{UI-TRAN}(n))$
$v_{EYE-LO-NTRAN}(n)$	Low voltage at middle of a non-transition UI*: = $v_{EYE-LO}(i_{UI-NTRAN}(n))$
* A subset of $v_{EYE}(n)$ .	



## Timing Measurements

### About Timing Measurements

Timing measurements are all based on either Crossing Times or Recovered Clock Times. Crossing times are dependent on Ref Level thresholds. Recovered Clock Times are affected by the clock recovery method specified in Clock Recovery and Jitter Configuration.

### Eye Width Measurement

The Eye Width measurement is the *measured* minimum horizontal eye opening at the zero reference level as shown in the eye diagram.

$$T_{EYE-WIDTH} = UI_{AVG} - TIE_{Pk-Pk}$$

Where:

$UI_{AVG}$  is the average  $UI$

$TIE_{Pk-Pk}$  is the Peak-Peak  $TIE$

### Rise Time Measurement

The Rise Time measurement is the time difference between when the  $V_{REF-HI}$  reference level is crossed and the  $V_{REF-LO}$  reference level is crossed on the rising edge of the waveform.

$$t_{RISE}(n) = t_{HI+}(i) - t_{LO+}(j)$$

Where:

$t_{RISE}$  is a Rise Time measurement

$t_{HI+}$  is a set of  $t_{HI}$  for rising edges only

$t_{LO+}$  is a set of  $t_{LO}$  for rising edges only

$i$  and  $j$  are indexes for nearest adjacent pairs of  $t_{LO+}$  and  $t_{HI+}$ .

$n$  is the index of rising edges in the waveform

Rise time can be limited to only rising edges of consecutive transitions in the File Preferences menu. In the PCI-Express module, Rise Time is taken independently on each single-ended waveform sources when you use two single-ended probes as the signal source.

Rise Time for  $v_{D+}(t)$  is as follows:

$$t_{D+RISE}(n) = t_{D+HI+}(i) - t_{D+LO+}(j)$$

and for  $v_{D-}(t)$

$$t_{D-RISE}(n) = t_{D-HI+}(i) - t_{D-LO+}(j)$$

**Fall Time Measurement**

The Fall Time measurement is the time difference between when the  $V_{REF-HI}$  reference level is crossed and the  $V_{REF-LO}$  reference level is crossed on the falling edge of the waveform.

$$t_{FALL}(n) = t_{LO-}(i) - t_{HI-}(j)$$

Where:

$t_{FALL}$  is a Fall Time measurement

$t_{HI-}$  is a set of  $t_{HI}$  for falling edges only

$t_{LO-}$  is a set of  $t_{LO}$  for falling edges only

$i$  and  $j$  are indexes for nearest adjacent pairs of  $t_{LO-}$  and  $t_{HI-}$

$n$  is the index of falling edges in the waveform

Fall time can be limited to only falling edges of consecutive transitions in the File Preferences menu. In the PCI-Express module, Fall Time is taken independently on each single-ended waveform source when you use two single-ended probes as the signal source.

Fall Time for  $v_{D+}(t)$  is as follows:

$$t_{D+FALL}(n) = t_{D+LO-}(i) - t_{D+HI-}(j)$$

and for  $v_{D-}(t)$

$$t_{D-FALL}(n) = t_{D-LO-}(i) - t_{D-HI-}(j)$$

### Rising Edge Measurement

The Rising Edge measurement or Rising Edge Rate measurement is defined as the ratio of voltage difference between  $V_{REFCLK-DIFF-IH}$  and  $V_{REFCLK-DIFF-IL}$  to the time difference between the crossing of  $V_{REFCLK-DIFF-IH}$  reference level and the crossing of  $V_{REFCLK-DIFF-IL}$  reference level on the rising edge of the waveform.

$$ER_{RISE}(n) = \frac{V_{REFCLK-DIFF-IH} - V_{REFCLK-DIFF-IL}}{t_{RISE-IH}(i) - t_{RISE-IL}(j)}$$

Where:

$ER_{RISE}$  is a rising edge rate measurement

$V_{REFCLK-DIFF-IH}$  is a predefined high voltage reference level

$V_{REFCLK-DIFF-IL}$  is a predefined low voltage reference level

$t_{RISE-IH}$  is a set of time when  $V_{REFCLK-DIFF-IH}$  reference level is crossed on rising edges

$t_{RISE-IL}$  is a set of time when  $V_{REFCLK-DIFF-IL}$  reference level is crossed on rising edges

$i$  and  $j$  are indexes for nearest adjacent pairs of  $t_{RISE-IH}$  and  $t_{RISE-IL}$ .

$n$  is the index of rising edges in the waveform

The rising edge measurement is required for reference clock measurements in PCI-Express and FB-DIMM modules. In these two modules, rising edge is taken on differential signal, the value of  $V_{REFCLK-DIFF-IH}$  and  $V_{REFCLK-DIFF-IL}$  is specified as 150mV and -150mV respectively as shown in the following diagram.

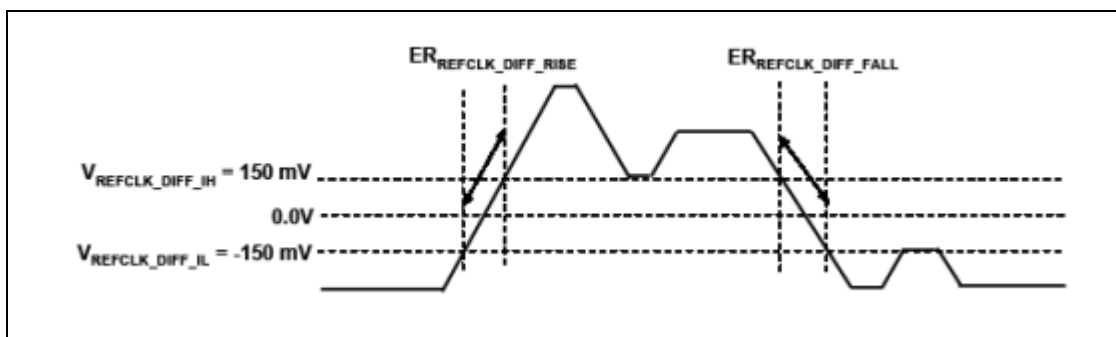

Figure 7-1: Rising edge measurement

### Falling Edge Measurement

The Falling Edge measurement or Falling Edge Rate measurement is defined as the ratio of voltage difference between  $V_{REFCLK-DIFF-IH}$  and  $V_{REFCLK-DIFF-IL}$  to the time difference between the crossing of  $V_{REFCLK-DIFF-IL}$  reference level and the crossing of  $V_{REFCLK-DIFF-IH}$  reference level on the falling edge of the waveform.

$$ER_{FALL}(n) = \frac{V_{REFCLK-DIFF-IH} - V_{REFCLK-DIFF-IL}}{t_{FALL-IL}(i) - t_{FALL-IH}(j)}$$

Where:

$ER_{FALL}$  is a falling edge rate measurement

$V_{REFCLK-DIFF-IH}$  is a predefined high voltage reference level

$V_{REFCLK-DIFF-IL}$  is a predefined low voltage reference level

$t_{FALL-IH}$  is a set of time when  $V_{REFCLK-DIFF-IH}$  reference level is crossed on falling edges

$t_{FALL-IL}$  is a set of time when  $V_{REFCLK-DIFF-IL}$  reference level is crossed on falling edges

$i$  and  $j$  are indexes for nearest adjacent pairs of  $t_{FALL-IL}$  and  $t_{FALL-IH}$

$n$  is the index of falling edges in the waveform

The falling edge measurement is required for reference clock measurements in PCI-Express and FB-DIMM modules. In these two modules, falling edge is taken on differential signal, the value of  $V_{REFCLK-DIFF-IH}$  and  $V_{REFCLK-DIFF-IL}$  is specified as 150mV and -150mV respectively as shown in the [Rising Edge Measurement](#) diagram.

**Unit Interval Measurement**

The Unit Interval measurement calculates the cycle duration of the recovered clock.

$$UI(n) = t_{R-CLK}(n+1) - t_{R-CLK}(n)$$

$$UI_{AVG} = Mean(UI(n))$$

Where:

$t_{R-CLK}$  is a recovered clock edge

$n$  is the index to UI in the waveform

**Bit Rate Measurement**

The Bit Rate measurement calculates the baud (such as frequency) of the recovered clock.

$$BR(n) = 1/UI(n)$$

Where:

$UI$  is the associated Unit Interval measurement

$n$  is the index to UI in the waveform

**Differential Skew Measurement**

The Skew measurement is the time delay between the two single-ended waveform sources.

$$t_{SKEW}(n) = t_{D+MID}(n) - t_{D-MID}(n)$$

Where:

$t_{SKEW}$  is the Skew measurement

$t_{D+MID}$  is the mid level crossing time of  $V_{D+}$

$t_{D-MID}$  is the mid level crossing time of  $V_{D-}$

$n$  is the index to edges in the waveform

## Amplitude Measurements

### About Amplitude Measurements

Some amplitude measurements can be limited to only the high or only the low amplitude of consecutive transitions in the File Preferences menu.

### Eye Height Measurement

The Eye Height measurement is the *measured* minimum vertical eye opening at the UI center as shown in the plot of the eye diagram. There are three types of Eye Height values.

#### Eye Height:

$$V_{EYE-HEIGHT} = V_{EYE-HI-MIN} - V_{EYE-LO-MAX}$$

Where:

$V_{EYE-HI-MIN}$  is the minimum of the High voltage at mid UI

$V_{EYE-LO-MAX}$  is the maximum of the Low voltage at mid UI

#### Eye Height – Transition:

$$V_{EYE-HEIGHT-TRAN} = V_{EYE-HI-TRAN-MIN} - V_{EYE-LO-TRAN-MAX}$$

Where:

$V_{EYE-HI-TRAN-MIN}$  is the minimum of the High transition bit eye voltage at mid UI

$V_{EYE-LO-TRAN-MAX}$  is the maximum of the Low transition bit eye voltage at mid UI



**Eye Height – Non-Transition:**

$$V_{EYE-HEIGHT-NTRAN} = V_{EYE-HI-NTRAN-MIN} - V_{EYE-LO-NTRAN-MAX}$$

Where:

$V_{EYE-HI-NTRAN-MIN}$  is the minimum of the High non-transition bit eye voltage at mid UI

$V_{EYE-LO-NTRAN-MAX}$  is the maximum of the Low non-transition bit eye voltage at mid UI

### Differential Amplitude Measurement

The Differential Amplitude measurement calculates the change in voltage level across a transition in the differential waveform.

$$v_{DIFF-AMP}(n) = |v_{DIFF-LEVEL}(i) - v_{DIFF-LEVEL}(i+1)|$$

Where

$n$  is the index of transitions of interest

$i$  is the index of UI (bit) locations preceding/following the transition

$v_{DIFF-LEVEL}$  is the state level of the unit interval (bit period)

$$v_{DIFF-LEVEL} = \text{mean}(v_{DIFF}(j))$$

Where

$j$  is the sample index; in the previous equation,  $j$  spans the samples that fall in the center 30% of UIs  $i$  or  $i+1$ .

$v_{DIFF}$  is the differential voltage.

---

**Note:** Eligible transitions are all transitions (Blue and Red) or consecutive transitions (Red only). This is set in the File Preferences menu.

---

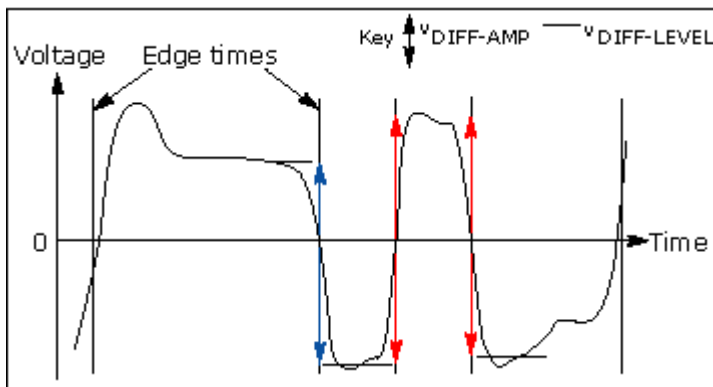

Figure 7-2: Differential voltage

**Differential Peak Voltage Measurement**

The Differential Peak Voltage measurement returns two times the larger of the Min or Max statistic of the differential voltage waveform.

$$V_{DIFF-PK} = 2 * \text{Max}(\text{Max}(v_{DIFF}(i)); \text{Min}(v_{DIFF}(i)))$$

Where:

$i$  is the index of all waveform values

$v_{DIFF}$  is the Differential voltage signal

**Differential Average Measurement**

The Differential Average measurement returns the Mean of the differential voltage waveform.

$$V_{DIFF-AVG} = \text{Mean}(v_{DIFF}(i))$$

Where:

$i$  is the index of all waveform values

$v_{DIFF}$  is the Differential voltage signal

**High Amplitude Measurement**

The High Amplitude measurement calculates the mode of all differential waveform values greater than zero.

$$V_{HI} = \text{Mode}(v_{DIFF}(i) > 0)$$

Where:

$v_{DIFF}$  is Differential voltage signal

$i$  is the index of all waveform values

**Low Amplitude Measurement**

The Low Amplitude measurement calculates the mode of all differential waveform values less than zero.

$$V_{LO} = Mode(v_{DIFF}(i) < 0)$$

Where:

$v_{DIFF}$  is Differential voltage signal

$i$  is the index of all waveform values

**CM Voltage Measurement**

The Common Mode Voltage measurement (also called DC Common Mode) calculates the mean of the Common Mode voltage waveform.

$$V_{CM} = Mean(v_{CM}(i))$$

Where:

$v_{CM}$  is the Common Mode voltage signal

$V_{CM}$  is the Common Mode voltage signal

$i$  is the index of Common Mode waveform values

**AC CM Voltage Measurement**

The AC Common Mode Voltage measurement calculates the AC statistics of the Common Mode voltage waveform with the DC value removed.

$$v_{AC-CM}(i) = v_{CM}(i) - V_{CM}$$

Where:

$i$  is the index of all waveform values

$v_{AC-CM}$  is the AC Common Mode voltage signal

$v_{CM}$  is the Common Mode voltage signal

$V_{CM}$  is the DC Common Mode voltage signal

**AC CM RMS Voltage Measurement**

The AC Common Mode RMS Voltage measurement calculates the RMS statistic of the Common Mode voltage waveform with the DC Value removed.

$$V_{AC-RMS-CM}(i) = RMS(v_{AC-CM}(i))$$

Where:

$i$  is the index of all waveform values

$V_{AC-RMS-CM}$  is the RMS of the AC Common Mode voltage signal

$v_{AC-CM}$  is the AC Common Mode voltage signal

### De-Emphasis Measurement

The De-Emphasis measurement calculates the ratio of any non-transition eye voltage (2<sup>nd</sup>, 3<sup>rd</sup>, etc. eye voltage succeeding an edge) to its nearest preceding transition eye voltage (1<sup>st</sup> eye voltage succeeding an edge). In the accompanying diagram, it is the ratio of the **Black** voltages over the **Blue** voltages. The results are given in dB.

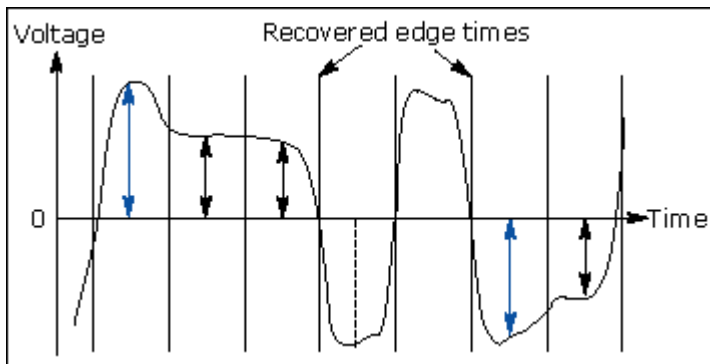

Figure 7-3: De-emphasis measurement

$$DEEM(m) = dB \left( \frac{v_{EYE-HI-NTRAN}(m)}{v_{EYE-HI-TRAN}(n)} \right)$$

or

$$DEEM(m) = dB \left( \frac{v_{EYE-LO-NTRAN}(m)}{v_{EYE-LO-TRAN}(n)} \right)$$

Where:

$v_{EYE-HI-TRAN}$  is the High voltage at mid UI following a positive transition

$v_{EYE-LO-TRAN}$  is the Low voltage at mid UI following a negative transition

$v_{EYE-HI-NTRAN}$  is the High voltage at mid UI following a positive transition bit

$v_{EYE-LO-NTRAN}$  is the Low voltage at mid UI following a negative transition bit

$m$  is the index for all non-transition UIs

$n$  is the index for the nearest transition UI preceding the UI specified by  $m$

## Jitter Measurements

### About Jitter Measurements

In the context of this RT-Eye analysis package, the term Jitter is used solely in relation to timing errors between data signal edges and recovered clocks. The two measurements in this category are TIE Jitter and Jitter @ BER. TIE Jitter is a direct measurement of the time difference (error) between data edges and associated clock edges, which is recovered from the data signal edges. Jitter @ BER is the label for Random and Deterministic Jitter analysis (Rj/Dj) on a TIE Jitter measurement.

The purpose of the Rj/Dj analysis is two fold: to decompose the TIE into component elements and to extrapolate jitter measurements (Total Jitter or Eye Opening) @ BERs that would require very large data sets for direct measurement.

TIE, and therefore Jitter @ BER, correlates to Eye Diagram statistics. A time Histogram at the eye crossing (at the mid reference voltage level) is the same as Histogram Plot of the TIE Jitter measurement on the same signal.

The method of clock recovery has a big impact on Jitter results.

### Jitter @ BER Measurement

The Rj/Dj measurement calculates the deterministic and random components of jitter. The jitter is obtained from the TIE measurements. Rj is the random jitter and is assumed to be Gaussian having flat spectrum. The Rj measurement calculates the RMS value of the random jitter.

Dj is the deterministic jitter. It is predictable and can be generated consistently under known circumstances. Dj has a spectrum of impulses when the data signal has a repeating pattern. The Dj measurement calculates the peak-to-peak value of the deterministic jitter. Tj is the total jitter, which is composed of Dj and Rj. The Tj measurement calculates the peak-to-peak value of the total jitter at the specified BER.

Dj comes from multiple sources:

- Periodic jitter (PJ) from periodic interference that is not correlated to the data
- Data dependent jitter (DDJ) from interference of nearby edges (also called ISI or Inter-Symbol Interference)
- Duty Cycle Distortion jitter (DCD) from slew rate differenced between rising and falling edges.

Two methods of jitter measurements are supported. The first method is a spectrum analysis based approach (default) when the data pattern is repetitive. A clock waveform is always repetitive. Other repetitive testing data patterns are used, such as the CJTPAT data pattern.

The second method is Rj/Dj separation method is arbitrary pattern analysis based approach when the data pattern is not necessarily repetitive. It is useful for long PRBS data patterns. The data is virtually non-repetitive within a single acquisition for extremely long data pattern.



### Spectrum Analysis based Rj/Dj Separation on Repeating Pattern

Dj components can be identified in a jitter spectrum under a set of conditions. PJ will appear as spectral impulses regardless of the conditions. DDJ and DCD will appear as spectral impulses provided that the data signal is a repeating pattern. The frequencies of DDJ and DCD spectral impulses are at harmonics of the (Bit Rate / Pattern length). The remaining spectral energy is attributed to Rj. Dj components are spectrally separated from Rj.

The Dj measurement is the peak-to-peak value of the inverse fourier transform of the deterministic jitter spectral components. Tj is the total jitter, which is composed of Dj and Rj. The Tj measurement calculates the peak-to-peak value of the total jitter. Rj is assumed to be near Gaussian. The Rj measurement is the calculated RMS value of random jitter.

A Jitter PDF is formed by convolving Gaussian distribution of Rj and Histograms of Dj. A Bathtub curve is calculated from the left and right side CDFs of the Jitter PDF. The Bathtub curve will yield TJ and Eye Opening ( $T_{EYE-OPEN}$ ). View the Bathtub Curve: [BER versus Decision Time Diagram](#).

The application calculates the measurements using the following equation:

$$Dj = Max(Dj^{Time}) - Min(Dj^{Time})$$

$$Rj = RMS(tie - Dj^{Time})$$

$$TJ_{PDF} = normalizedHistogram(Dj) * GaussianPDF(Rj)$$

$$TJ = TJ_{Max} - TJ_{MIN}$$

$$T_{EYE-OPEN} = UI - TJ$$

Where:

$Dj$  is the Deterministic jitter

$Rj$  is the Random jitter

$TJ$  is the Total jitter

$TJ_{PDF}$  is the PDF of the Total jitter

$TJ_{MIN}$  is the minimum value at the Bathtub curve at a given BER

$TJ_{Max}$  is the maximum value at the Bathtub curve at a given BER

$Dj^{Time}$  is the time domain record of the  $Dj$  component of

jitter obtained by performing an inverse FFT of the  $Dj$  components of the TIE spectrum.

$tie$  is the time domain record of measured TIE jitter.

Additionally,  $Dj$  is further decomposed as follows:

$$PJ = Max(PJ^{Time}) - Min(PJ^{Time})$$

$$DCD = |Mean(DCDDDJ_{Rise}^{Time}) - Mean(DCDDDJ_{Fall}^{Time})|$$

$$DDJ = Max(DCDDDJ^{Time}) - Min(DCDDDJ^{Time}) - DCD$$

Where:

$PJ$  is the periodic jitter

$DCD$  is the duty cycle jitter

$DDJ$  is the data dependent (or ISI) jitter

$PJ^{Time}$  is the time domain record of the  $PJ$  component of jitter obtained by performing an inverse FFT of the  $PJ$  components of the TIE spectrum.

$DCDDDJ^{Time}$  is the time domain record of the

$DCD + DDJ$  component of jitter obtained by performing an

inverse FFT of the  $DCD + DDJ$  components of the TIE spectrum.

$DCDDDJ_{Rise}^{Time}$  is  $DCDDDJ^{Time}$  on rising edges only.

$DCDDDJ_{Fall}^{Time}$  is  $DCDDDJ^{Time}$  on falling edges only.

**Arbitrary Pattern Analysis based Rj/Dj Separation**

When the data pattern is non-repeating, Pj still has a spectrum of impulses while DCD+DDJ no longer has a spectrum of impulses. Therefore, Dj no longer has a spectrum of impulses.

The DCD+DDJ value is obtained through the arbitrary data pattern analysis method, which is based on the assumption that any given bit is affected by a finite number of preceding bits. By averaging all events where the current bit is preceded by a particular bit sequence, for example, the current bit is preceded by the bit sequence 1001101, the DCD+DDJ with such a pattern is obtained because PJ and RJ are not correlated to a particular data sequence and thus are averaged out.

If each bit is assumed to be affected by N preceding bits, there are a total of  $2^N$  possible data sequences. The sequence length N is a configurable parameter. To get statistically sound average values, a population limit is the other configurable parameter that prevents using an average value without enough population. Only DCD+DDJ values obtained from data sequences with a population above the limit are used to calculate DCD+DDJ values.

After each edge is associated with a DCD+DDJ value, with known total jitter, the PJ+Rj value for each bit is then obtained by subtracting DCD+DDJ from TJ.

Separation of DDJ and DCD from DCD+DDJ is the same as that in the [spectrum based Rj/Dj separation method](#).

PJ and Rj are then separated from PJ+Rj using the spectrum analysis method. PJ has a spectrum of impulses. Rj has a flat spectrum. Not all of the edges DCD+DDJ can be determined because of their associated data sequences, which have low populations and are treated as if there are no edges when performing PJ and Rj separation.

The histogram of Dj is a convolution of the histogram of DCD+DDJ and the histogram of PJ.

All other aspects of the arbitrary pattern analysis based Rj/Dj separation are the same as those of the [spectrum analysis based Rj/Dj separation](#).

### Rj/Dj Separation based on Dual-Dirac Model

The Dual-Dirac model based Rj/Dj separation method fits the Bathtub curve to a theoretical model of Rj and Dj where Rj has a Gaussian distribution and Dj has a distribution of two Dirac impulses with the same height. Curve fitting at different BER levels in Bathtub curve yields the standard deviation value of Rj and peak-to-peak value of Dj. The Bathtub curve is obtained from the spectrum analysis based or the arbitrary pattern analysis based Rj/Dj separation methods. Rj and Dj based on the Dual-

Dirac model can be denoted as  $RJ_g$  and  $DJ_{dd}$ .

After  $RJ_g$  and  $DJ_{dd}$  are obtained, Tj can be calculated using this formula:

$$TJ(BER) = 2Q(BER) \times RJ_g + DJ_{dd}$$

Where Q is the function of BER that has a value of about 7 when

$BER = 10^{-12}$ . The Eye opening is computed in the same way as it is computed in the spectrum analysis based Rj/Dj separation.

The Dual Dirac model based Rj/Dj separation method is used in PCI-Express and FB-DIMM modules.

Dj does not usually have a pure Dual-Dirac distribution. So the

value of  $RJ_g$  is often greater than the value of Rj obtained from the spectrum analysis based or the arbitrary pattern analysis

based Rj/Dj separation. The value of  $DJ_{dd}$  is often less than that of Dj.

Refer to [www.T11.org](http://www.T11.org) for a detailed description of Rj/Dj separation based on Dual-Dirac model.

### Jitter Measurements Field Notes

Data pattern generation techniques vary from one serial data standard to another. Refer to the Standards Methods Of Implementation (MOIs) documents for specific details on how to set up those system-to-broadcast testable data/test patterns.

Both PCI Express and InfiniBand serial data traffic test patterns are interspersed with Skip Ordered Sets (SOSs) on regular intervals. When conducting jitter measurements that require repeated data sets (such as for Jitter @ BER), you will need to set up the acquisition system to acquire between these non-deterministic Skip Characters. Refer to the Standards MOIs documents for specific details on how to set up the system to work under these conditions.

### TIE Jitter Measurement

The *measured* time difference between a data edge and a recovered clock edge.

$$tie(n) = t_{R-DAT}(n) - t_{DAT}(n)$$

Where:

$t_{DAT}$  is the original data edge

$t_{R-DAT}$  is the recovered data edge (for example, the recovered clock edge corresponding to the UI boundary of  $t_{DAT}$ )

$n$  is the index of all edges in the waveform

### TIE Jitter Filtering Measurement

TIE Jitter Filtering measurement is used to apply a pre-defined filter to TIE jitter to get filtered TIE jitter measurement.

$$TIE_{REFCLK-FILTERED}(s) = H(s) \cdot TIE_{REFCLK}(s)$$

Where:

$TIE_{REFCLK-FILTERED}$  is the frequency domain representation of a

filtered TIE jitter  $tie_{REFCLK-FILTERED}$

$H$  is the transfer function of a pre-defined filter

$TIE_{REFCLK}$  is the frequency domain representation of a TIE jitter

before filtering  $tie_{REFCLK}$

The TIE jitter filtering measurement is required by PCI-Express and FB-DIMM modules for reference clock measurements. In these two modules, the filter is used to emulate the effects of variation of the jitter transfer function of PLLs between transmitters and receivers; transport delays between them; differences in the propagation delays in the devices, and the phase tracking bandwidth of the clock phase recovery circuitry. One such transfer function  $H(s)$  is defined as

$$H(s) = \left[ \frac{2s\zeta_1\omega_1 + \omega_1^2}{s^2 + 2s\zeta_1\omega_1 + \omega_1^2} e^{-sT_1} - \frac{2s\zeta_2\omega_2 + \omega_2^2}{s^2 + 2s\zeta_2\omega_2 + \omega_2^2} \right] \left[ \frac{s}{s + \omega_3} \right]$$

Where the parameters  $\zeta_i$ ,  $\omega_j$  and  $T_1$  are pre-defined. An  $H(s)$  has a magnitude frequency response as follows:

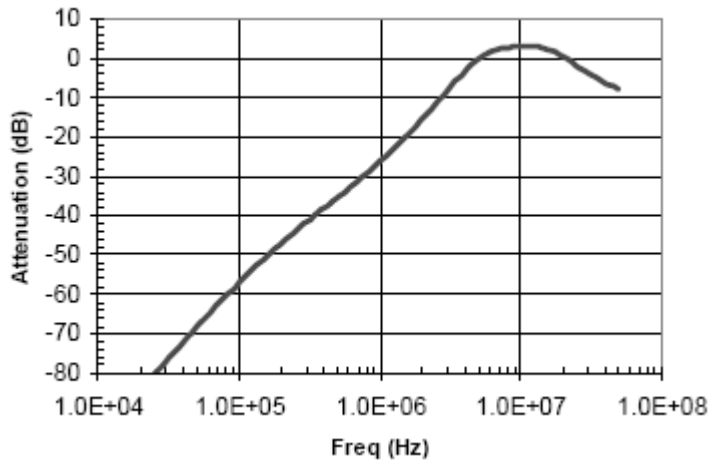

Figure 7-4: Frequency response of H(s)

## Statistics

### About Statistics

The application calculates statistics for all selected measurements. The application displays the following statistics in the Results menus:

- Maximum value
- Minimum value
- Mean value
- Standard deviation value
- Peak-Peak value
- Population

### Maximum Value

The application calculates this statistic using the following equation:

$$\text{Max}(x) = \text{Highest value of } x$$

### Minimum Value

The application calculates this statistic using the following equation:

$$\text{Min}(x) = \text{Lowest value of } x$$

### Mean Value

The application calculates this statistic using the following equation:

$$\text{Mean}(x) = \bar{x} = \frac{1}{N} \sum_{n=0}^{N-1} x(n)$$



**Standard Deviation Value**

It may seem odd that the equation for the estimate of the Standard Deviation contains a  $1/(N-1)$  scaling factor. If you knew the true mean of  $X$  and used in place of the estimated mean  $\bar{X}$ , then you would, in fact, scale by  $1/N$ . But,  $\bar{X}$  is an estimate and is likely to be in error (or bias), causing the estimate of the Standard Deviation to be too small if scaled by  $1/N$ . This is the reason for the scaling shown in the equation. (Refer to Chapter 9.2 in A. Papoulis, *Probability, Random Variables, and Stochastic Processes*, McGraw Hill, 1991.)

The application calculates this statistic using the following equation:

$$StdDev(x) = \sigma_x = \sqrt{\frac{1}{(N-1)} \sum_{n=0}^{N-1} (x(n) - \bar{x})^2}$$

**Peak-to-Peak Value**

The application calculates this statistic using the following equation:

$$PkPk(x) = Max(x) - Min(x)$$

**Population Value**

Population is the total number of data points applied to the displayed statistics.

# GPIB

## About the GPIB Program

An example of a GPIB program that can execute the RT-Eye application is included with the application. The oscilloscope hard disk includes the example file, rt-eyectrl.c. On the hard drive, the file resides in the C:\TekApplications\tdsrt-eye\Examples\RemoteCtrl directory.

The example shows how a GPIB program executes the application to do the following tasks:

- Start the application
- Recall a setup
- Take a measurement
- Check for an error
- Exit the application

## Guidelines to GPIB Programming

The application includes an example file of a GPIB program. Your GPIB program should comply with the following guidelines:

- The application startup must complete before sending additional GPIB commands to the application; query the variable *application*; it will return "TDSRT-EYE" when the application startup is complete
- Recall a setup file from GPIB to select measurements and set up the application
- The measurements cycle must complete before data is queried; query the variable *SequencerState*; it will return "Ready" when sequencing is complete
- The *resultFor* and *resultAcq* variables must be set before querying results; pause a second after setting each variable
- The error variable should be checked to ensure that an error has not occurred because of a measurement command problem; the *measError* variable returns errors specific to the measurement selected by *resultFor*

## Program Example

The program example shows how to communicate to the RT-Eye application using remote GPIB commands. The program includes the following steps:

- Start up the application
- Recall a setup
- Take a measurement
- Display results or errors
- Exit the application

In the example, you will recall a setup file named `rt-eyectrl.c` (setup). You can use the File> Save function in the application to save setup files according to your own needs.

## GPIB Commands

### Introduction to GPIB Command Syntax

With knowledge of the GPIB command syntax, you can design a GPIB program to do the following tasks:

- Start the RT-Eye application
- Recognize an active application with GPIB protocol
- Program and read application setup parameters
- Sequence measurements
- Read measurement results
- Generate reports

### **GPIB Reference Materials**

To use GPIB commands with your oscilloscope, you can refer to the following materials:

- The `rt-eyectrl.c` file on the oscilloscope hard drive (located in the `c:\TekApplications\tdsrt-eye\Examples\RemoteCtrl` directory) for an example of a GPIB program that can execute the application
- The GPIB Program Example topic for guidelines to use while designing a GPIB program
- The Parameters topics for range of values, minimum units and default values of parameters
- The programmer information in the online help of your oscilloscope

### **Starting and Setting Up the Application using GPIB**

To start the RT-Eye application, you must send the oscilloscope the following GPIB command:

```
application:activate "RT-Eye Serial Compliance and Analysis"
```

---

*Note: The name of the application in the previous string is identical to the name of the application from the oscilloscope Run Application list.*

---

The application uses the GPIB `VARIABLE:VALUE` command with arguments to execute some features. The set of GPIB commands does not include the variable names and variable values necessary to select and configure the measurements in the GPIB program.

You must manually set up the application and oscilloscope, selecting and configuring the measurements that you want to use with your GPIB program, and save them in a setup file in the default setup folder for that module. To save a setup file, refer to [Saving a Setup File](#). Use the name of the saved setup file as the value for the "recallName" variables in your GPIB program.

## Variable: Value RT-Eye Command

### Description

This command accepts string arguments for a control or data variable and a value to which to set the argument.

### Syntax

VARIABLE:VALUE "<variable name>",<variable value>"

---

*Note: The arguments <variable name> and <variable value> are required in the order indicated.*

---

VARIABLE:VALUE? <variable name> for query.

 **CAUTION.** Commands are case and space sensitive. Your program will not operate correctly if you do not follow the capitalization and spacing precisely.

**Variable: Value RT-Eye Command Arguments and Queries  
(Part 1)**

**Table 8-1: Variable value RT-eye command arguments and queries (part1)**

Group/name	Value	Function	Query returns
application	{exit}	Terminates the active application	Returns <i>TDSRT-EYE</i> when the application is active
version	Query only		Returns the version number of the application
<b>Sequencer</b>			
sequencerMode	{SingleNoAcq, FreeRun, Single}	Sets the sequencer mode	Returns the sequencer mode
sequencerState	{Stop, Sequencing}	Sends the Measurement Sequencing command	Returns {Most recent setting, Ready}; <i>Ready</i> indicates that the value was processed
reset	{Results}	Clears the active measurement results and plots	Returns {Most recent setting, Ready}; <i>Ready</i> indicates that the value was processed
<b>Active module</b>			
module	{SerialAnalysis, InfiniBand, PCIExpress,SATA,SAS ,FB-DIMM}	Switches to the specified module **	Returns the active module
<b>Recall setup</b>			
setup*	{Default, Recall}	Performs the Recall Default setup function	Returns {Most recent setting, Ready}; <i>Most recent setting indicates</i> that the value is being processed; <i>Ready</i> indicates that the value was processed
recallName	Any string from 1 to 40 characters: A to Z, 0 to 9, or special characters like “.”	Sets the Recall setup file name; file name extension of .ini is optional	Returns the name of the set up file to be recalled (without an extension)
recallDirectory	Query only		Returns the current setting (determined from module command) of recall directory default, such as <i>InfiniBand\setup</i>
*Query may return an error code if command fails.			
**Refer to the online help in the SATA and SAS modules for their Variable:Value commands and queries.			



**Variable:Value RT-Eye Command Arguments and Queries  
(Part 2)**

**Table 8-2: Variable value RT-eye command arguments and queries (part 2)**

Group/name	Value	Function	Query returns
<b>Source scaling</b>			
sourceAutoset***	{Vert, Horiz, vertAndHoriz}	Starts the automatic scaling if the sources are channel waveforms	Returns {Most recent setting, Ready}; Ready indicates that the value was processed
<b>Source ref levels</b>			
refLevelAutoset***	{Run}	Performs Ref Level Autoset for the for all active sources; Active sources are Differential when Differential is the Probe Type or Differential, Dplus and Dminus when Single-Ended is the Probe Type.	Returns {Most recent setting, Ready}; Ready indicates that the value was processed
<b>Report generator setup</b>			
reportGen*	{Now}	Exports content from current measurements into a report template/layout where the template/layout are default or as specified in the recalled setup file; concatenates the Template name and a timestamp for the file name	{ <i>Most recent setting</i> , Ready} Ready indicates report has been created and saved.
<b>Compliance module only</b>			
reportDeviceID	Any string from 1 to 40 characters: A to Z, 0 to 9, or special characters like “.”	Specifies the device ID field for report generation	Returns the specified DeviceID; applies to compliance modules only
<b>Result variables</b>			
resultFor	{Measurement Name}	Specifies the measurement that is the source for detailed results queries; refer to the tables between this one and the error codes table	Returns the selected measurements for the queries associated with the resultFor command
resultAcq	{All, Current}	Specifies the measurement result group as the most recent acquired or as an accumulation of all the measurements in the current session	Returns the current value
* Query may return an error code if command fails.			
** Serial Analysis module only.			

## Measurements Results Queries

 **CAUTION:** Before you query for the measurement results, be sure to insert a one second delay after the resultFor and the resultAcq commands to allow the statistics variables to refresh.

You need to use the VARIABLE:VALUE? form to enter measurement results queries in your GPIB program. Before you can do this, you must first set the measurement with the resultFor command. You can select the current or all acquisition statistics with the resultAcq command.

The next several tables list the measurement results queries for the measurement selected in the resultFor variable.

### Measurements Results Queries Variable Names (Part 1)

Table 8-3: Measurement results queries variable names (part 1)

Variable name	Query returns for measurement
<b>Statistics for all measurements selected with resultFor</b>	
max	Returns the maximum measurement value.
mean	Returns the mean measurement value.
min	Returns the minimum measurement value.
pkpk	Returns the peak-to-peak measurement value.
population	Returns the number of measurements used to the current statistics.
stdDev	Returns the standard deviation measurement set.
<b>Other for non-statistical information that appears in the Results menus.</b>	
value	Returns a generic message for measurements with no statistical results, such as for amplitude measurements.
maskUIControl	Returns the number of UIs examined for mask hits.
maskHits	Returns the number of UIs containing one or more mask hits.
<b>Limits</b>	
statusMax	Pass or Fail status; Pass when the measurement is below the maximum limit or Fail.
statusMin	Pass or Fail status; Pass when the measurement is above the minimum limit or Fail.
status	Pass or Fail status; Pass when the measurement passes the compliance test or Fail; also applies to the RT-Eye analysis with limits defined.
<b>Misc</b>	
measUnits	Returns a units string for the measurement, such as s for seconds.

## Measurements Results Queries Variable Names (Part 2)

Table 8-4: Measurement results queries variable names (part 2)

Variable name	Query returns for measurement
<b>Jitter@BER only</b>	
dataDependent	Returns the data dependent jitter component of the TIE measurement.
dutyCycle	Returns the duty cycle jitter component of the TIE measurement.
deterministic	Returns the deterministic jitter component of the TIE measurement.
periodic	Returns the periodic jitter component of the TIE measurement.
random	Returns the estimated random jitter component of the TIE measurement.
totalJitter	Returns the estimated total jitter component at the BER of the TIE measurement.
eyeOpening	Returns the estimated eye opening at the BER of the TIE measurement.
Population	Returns the population when resultAcq variable is set to "All".
<b>Messages return strings if there are problems; refer to the Error Codes tables.</b>	
resultForStatus	Returns one of the following strings: "Active" when the value of <i>resultFor</i> is an active measurement. "Inactive" when the value of <i>resultFor</i> is a known measurement that's not active. "Unknown" when the value of <i>resultFor</i> is an unknown measurement. Any of the results specified in this table are not valid unless this variable is "Active".
error	Returns a general error.
warning	Returns a warning from the most recent measurement.
measError	Returns a measurement specific error.

## Serial Analysis Measurement Names for the resultFor Variable

Table 8-5: Serial analysis measurement names for the resultFor variable

Measurement Names	Results when resultAcq=				
	All Stats	And ...	Current Stats	Value	And ...
Eye Width	Yes			Yes	
Eye Height	Yes	maskUICount, maskHits		Yes	maskUICount, maskHits
Eye Height Transition Bits	Yes	maskUICount, maskHits		Yes	maskUICount, maskHits
Eye Height Non-Transition Bits	Yes	maskUICount, maskHits		Yes	maskUICount, maskHits
Rise Time	Yes		Yes		
Fall Time	Yes		Yes		
Unit Interval	Yes		Yes		
Bit Rate	Yes		Yes		
Differential Skew*	Yes		Yes		
Differential Amplitude	Yes		Yes		
High Amplitude	Yes			Yes	
Low Amplitude	Yes			Yes	
CM Voltage*	Yes			Yes	
AC CM Voltage*	Yes		Yes		
De-Emphasis	Yes		Yes		
Jitter @ BER		Jitter @ BER variables; see previous topic			Jitter @ BER variables; see previous topic
Eye Opening	Yes	eyeOpening		Yes	eyeOpening
Total Jitter	Yes	totaljitter		Yes	totalJitter
Deterministic Jitter	Yes	deterministic		Yes	deterministic
TIE Jitter	Yes		Yes		
* Added when the Probe Type option is Single Ended.					

## InfiniBand Driver Measurement Names for the resultFor Variable

Table 8-6: Infiniband driver measurement names for the resultFor variable

Measurement Names	Results when resultAcq=				
	All Stats	And ...	Current Stats	Value	And ...
Eye Height	Yes	maskUICount, maskHits		Yes	maskUICount, maskHits
Eye Height Transition Bits	Yes	maskUICount, maskHits		Yes	maskUICount, maskHits
Eye Height Non-Transition Bits	Yes	maskUICount, maskHits		Yes	maskUICount, maskHits
Rise Time	Yes		Yes		
Fall Time	Yes		Yes		
Unit Interval	Yes		Yes		
Differential Amplitude	Yes		Yes		
CM Voltage*	Yes			Yes	
Eye Opening	Yes			Yes	eyeOpening
AC CM RMS Voltage*	Yes			Yes	
Jitter @ BER		Jitter @ BER variables; see previous topic			Jitter @ BER variables; see previous topic
Total Jitter	Yes			Yes	totalJitter
Deterministic Jitter	Yes			Yes	deterministic
* Added when the Probe Type option is Single Ended.					

## InfiniBand Receiver Measurement Names for the resultFor Variable

Table 8-7: Infiniband receiver measurement names for the resultFor variable

Measurement Names	Results when resultAcq=				
	All Stats	And ...	Current Stats	Value	And ...
Eye Height	Yes	maskUICount, maskHits		Yes	maskUICount, maskHits
Differential Amplitude	Yes		Yes		
CM Voltage*	Yes			Yes	
Eye Opening	Yes			Yes	eyeOpening
Jitter @ BER		Jitter @ BER variables; see previous topic			Jitter @ BER variables; see previous topic
Total Jitter	Yes			Yes	totalJitter
Deterministic Jitter	Yes			Yes	deterministic

\* Added when the Probe Type option is Single Ended.

## InfiniBand Cable Assembly Measurement Names for the resultsFor Variable

Table 8-8: Infiniband cable assembly measurement names for the resultFor variable

Measurement Names	Results when resultAcq=				
	All Stats	And ...	Current Stats	Value	And ...
Eye Width	Yes			Yes	
Eye Height	Yes	maskUICount, maskHits		Yes	maskUICount, maskHits
TIE Jitter	Yes		Yes		

\* Added when the Probe Type option is Single Ended.

## PCI Express Measurement Names for the resultFor Variable for any Test point except Reference clock

Table 8-9: PCI Express measurement names for the resultFor variable for any test point except reference clock

Measurement Names	Results when resultAcq=				
	All Stats	And ...	Current Stats	Value	And ...
Eye Width	Yes			Yes	
Eye Height	Yes	maskUICount, maskHits		Yes	maskUICount, maskHits
Eye Height Transition Bits	Yes	maskUICount, maskHits		Yes	maskUICount, maskHits
Eye Height Non-Transition Bits	Yes	maskUICount, maskHits		Yes	maskUICount, maskHits
Rise Time*	Yes		Yes		
Fall Time**	Yes		Yes		
Unit Interval	Yes		Yes		
Differential Peak Voltage	Yes			Yes	
Differential Average Voltage	Yes			Yes	
De-Emphasis	Yes		Yes		
AC CM RMS Voltage†	Yes			Yes	
TIE Jitter	Yes		Yes		
* For Single Ended two measurements: Rise Time D+ and Rise Time D-.					
** For Single Ended two measurements: Fall Time D+ and Fall Time D-.					
† Added when the Probe Type option is Single Ended.					

## PCI Express Reference Clock Measurement Names for the resultFor Variable

Table 8-10: PCI Express measurement names for the resultFor variable

Measurement Names	Results when resultAcq=				
	All Stats	And ...	Current Stats	Value	And ...
High Voltage	Yes			Yes	
Low Voltage	Yes			Yes	
Differential Peak Voltage	Yes			Yes	
Rising Edge	Yes		Yes		
Falling Edge	Yes		Yes		
Period	Yes		Yes		
Duty Cycle	Yes		Yes		
Jitter @ 6 BER		Jitter @ BER variables†			Jitter @ BER variables†
Jitter @ 12 BER		Jitter @ BER variables†			Jitter @ BER variables†
TIE Jitter	Yes		Yes		
* All measurements are available only for differential probe.					
† Jitter @ BER variables are defined in the topic Measurement Result Queries Variable Names Part 2					



## FBDIMM Transmitter Measurement Names for the resultFor Variable

Table 8-11: FBDIMM transmitter measurement names for the resultFor variable

Measurement Names	Results when resultAcq=				
	All Stats	And ...	Current Stats	Value	And ...
Eye Width	Yes			Yes	
Eye Height	Yes	maskUICount, maskHits		Yes	maskUICount, maskHits
Eye Height Transition Bits	Yes	maskUICount, maskHits		Yes	maskUICount, maskHits
Eye Height Non-Transition Bits	Yes	maskUICount, maskHits		Yes	maskUICount, maskHits
Bit Rate	Yes		Yes		
Rise Time	Yes		Yes		
Fall Time	Yes		Yes		
Differential Peak Voltage	Yes			Yes	
De-Emphasis	Yes		Yes		
AC CM Pk Voltage†	Yes			Yes	
CM Voltage††	Yes			Yes	
Jitter @ BER		Jitter @ BER variables*			Jitter @ BER variables*
TIE Jitter	Yes		Yes		
† Available only If Probe Type option is Single-Ended.					
†† Available only If Probe Type option is Single-Ended and Swing Type selection is Large or Small.					
* Jitter @ BER variables are defined in the topic Measurement Result Queries Variable Names Part 2.					

## FBDIMM Receiver Measurement Names for the resultFor Variable

Table 8-12: FBDIMM receiver measurement names for the resultFor variable

Measurement Names	Results when resultAcq=				
	All Stats	And ...	Current Stats	Value	And ...
Eye Width	Yes			Yes	
Eye Height	Yes	maskUICount, maskHits		Yes	maskUICount, maskHits
Bit Rate	Yes		Yes		
Rise Time	Yes		Yes		
Fall Time	Yes		Yes		
Differential Peak Voltage	Yes			Yes	
AC CM Pk Voltage†	Yes			Yes	
CM Voltage†	Yes			Yes	
Jitter @ BER		Jitter @ BER variables**			Jitter @ BER variables
TIE Jitter	Yes		Yes		
† Available only if Probe Type option is Single-Ended.					
** Jitter @ BER variables are defined in the topic Measurement Result Queries Variable Names Part 2.					

## FBDIMM Reference Clock Measurement Names for the resultFor Variable

*Note: All measurements are available only for differential probe.*

Table 8-13: FBDIMM reference clock measurement names for the resultFor variable

Measurement Names	Results when resultAcq=				
	All Stats	And ...	Current Stats	Value	And ...
High Voltage	Yes			Yes	
Low Voltage	Yes			Yes	
Rising Edge	Yes		Yes		
Falling Edge	Yes		Yes		
Frequency	Yes		Yes		
Duty Cycle	Yes		Yes		
Jitter @ BER		Jitter @ BER variables†			Jitter @ BER variables†
TIE Jitter	Yes		Yes		

† Jitter @ BER variables are defined in the topic Measurement Result Queries Variable Names Part 2.

## GPIB Commands Error Codes

Table 8-14: GPIB commands error codes

Code	Description
E101	No measurements have been selected; select a measurement.
E103	Record length changed in between.
E105	Unable to initialize measurement sequence.
E107	Unable to enable and display requested signal source.
E108	Reduce record length or number of measurements, sequencing stopped.
E109	Setup file is corrupted or there is another problem with recall.
E151	Level too high for primary Vref High - Autoset Ref Level.
E202	Upper range should be more than Lower range.
E300	Oscilloscope signal acquisition failure due to PC memory limitation.
E301	Sequencing was stopped; a timeout occurred while acquiring signal from the oscilloscope; check the signal or trigger level.
E302	Waveform Math operation failed.
E400	Measurement failed to complete successfully.
E408	Missing data file or crossing times file.
E410	Number of edges is not sufficient for a measurement.
E417	Not enough Record Length for required analysis window.
E420	Could not complete RjDj separation; less than 50 pattern repeats detected.
E424	No edges or UI of required type are found in waveform; check the Vref threshold or record length.
E425	Not enough good bits to perform arbitrary RjDj separation. Increase the record length or make more acquisitions.
E430	Invalid Pattern Length.
E435	Not enough edges to perform arbitrary RjDj separation. Increase record length.
E440	Signal is unstable. Clock Recovery failed.
E471	Time constant to remove the data edges is not correct. Adjust time constant within the range or acquire more data edges.
E702	File not found; stopping sequencer.
E703	I/O Error; stopping sequencer.
E704	Unable to write worst case file; stopping sequencer.
E800	File not found.
E801	File already exists.
E802	Cannot create the file.
E803	Illegal character(s) in the file name.
E804	Cannot create the directory.
E805	Application .ini file successfully recalled, but the .set file was not recalled because it was not found or was corrupted.
E806	Invalid CSV File/Incompatible CSV Files.
E807	Invalid wfm File.
E999	A recognized error has occurred.
E1001	Process did not complete; no signal.
E1002	Process did not complete; signal exceeds top of scale.
E1003	Process did not complete; signal exceeds bottom of scale.
E1004	Process did not complete; signal removed.
E1005	Process did not complete; failed to measure rising and falling edge speed.
E1006	Process did not complete; Horizontal resolution at maximum.

## GPIB Commands Warning Codes

Table 8-15: GPIB commands warning codes

Code	Description
W999	An unspecified warning has occurred.
W410	Number of edges is not sufficient for a measurement.
W402	RjDj separation accuracy not guaranteed; less than 100 pattern repeats detected.
W701	Worst case waveform logging timed out while saving; stopping the sequencer.