



**AWG5200 Series  
Arbitrary Waveform Generators  
Printable Help Document**







**AWG5200 Series  
Arbitrary Waveform Generators  
Printable Help Document**

Copyright © Tektronix. All rights reserved. Licensed software products are owned by Tektronix or its subsidiaries or suppliers, and are protected by national copyright laws and international treaty provisions.

Tektronix products are covered by U.S. and foreign patents, issued and pending. Information in this publication supersedes that in all previously published material. Specifications and price change privileges reserved.

TEKTRONIX and TEK are registered trademarks of Tektronix, Inc.

Microsoft and Windows are registered trademarks of Microsoft Corporation.

MATLAB is a registered trademark of The Mathworks, Inc.

Supports Product Software Version 6.1 and above.

Help part number: 076-0406-00

PDF of Help system part number: 077-1334-00

### **Contacting Tektronix**

Tektronix, Inc.  
14150 SW Karl Braun Drive  
P.O. Box 500  
Beaverton, OR 97077  
USA

For product information, sales, service, and technical support:

- In North America, call 1-800-833-9200.
- Worldwide, visit [www.tek.com](http://www.tek.com) to find contacts in your area.

# Table of Contents

## Introduction

Introduction .....	1
Product software .....	2
Documentation .....	2
Support information .....	3
Analysis and connectivity support .....	4

## Working with the AWG

AWG mode window	
AWG mode general overview .....	5
AWG workspace tabs .....	6
Run state control .....	15
Screen interface features via touchscreen and mouse .....	15
Toolbar .....	19
Waveform list	
Working with the waveform list .....	21
Adding a waveform .....	23
Saving a waveform .....	28
Apply corrections .....	28
Assign a waveform to a channel .....	29
Modify waveform .....	31
Modify markers .....	35
Waveform properties .....	38
Applying waveform corrections	
Applying correction file .....	40
Apply S-Parameters	
Apply S-Parameters .....	41
S-Parameter file descriptions .....	44
Aggressor signals .....	46
Sequence list	
Sequence list .....	46
Adding a sequence .....	47
Saving a sequence .....	49
Assigning tracks to a channel .....	49
Edit a sequence .....	51
Sequence properties .....	52
General setup	
General setup overview .....	53

Enable all channels on play .....	53
Apply recommended settings on assignment .....	54
Channel setup	
Channel setup introduction .....	54
Enable outputs / relay state .....	55
Channel output path .....	57
Amplitude .....	57
Markers .....	60
Resolution (bits) .....	61
Couple channel settings .....	61
Channel color .....	63
Output Options	
Output Options .....	63
DAC Options	
DAC Options .....	65
I/Q Modulator	
I/Q Modulator .....	67
Clock setup	
Clock introduction .....	69
Sample Rate .....	69
Clock and Reference Sources .....	70
Clock output .....	73
Trigger setup	
Trigger control .....	73
Trigger input settings .....	76
Trigger timing .....	78
Skew setup	
Adjust skew .....	80
Sync (synchronization)	
Sync (synchronization) .....	84
Aux Out setup	
Aux Out setup .....	85
Sequence Editor	
Sequence tab overview .....	86
Sequences - creating and editing	
Editing tools .....	86
Sequence create and edit toolbar .....	88
Copy and paste guidelines .....	92
Sequence settings	
Sequence settings .....	92
Forcing jumps	
Forcing jumps introduction .....	93

Force Jump To... button .....	94
Force jump here .....	96
Jump timing	
Jump timing .....	96
Pattern jump	
Creating a Pattern jump .....	97
Jump priority	
Jump execution order .....	99
Flags	
Sequence flags .....	100
Subsequence editing	
Subsequence editing .....	102
Sequencer batch compiler	
Sequencer batch compiler .....	103
Capture and Playback	
Capture/Playback introduction .....	110
Captured Signal List	
Adding (importing) IQ data files .....	111
Removing Signals .....	113
Editing signals .....	113
Adding signals from files	
Adding signals from files .....	115
Adding signals from waveform list	
Adding signals from waveform list .....	117
Capturing signals from instruments	
Capturing signals from instruments .....	118
Connecting to an oscilloscope .....	119
Connecting to a spectrum analyzer .....	121
Compiling I/Q signals	
Compiling I/Q signals .....	122
Waveform plug-ins	
Waveform plug-ins introduction .....	124
Basic waveform	
Basic waveform .....	125
Equation editor	
Equation editor overview .....	128
Limitations .....	130
Tips on using the equation editor .....	130
Basic keywords	
Basic keywords .....	132
Waveform functions	
Waveform functions .....	133

Correlation .....	139
Code conversion.....	141
Differentiation .....	145
Integration.....	147
Convolution.....	148
Math functions	
Math functions.....	149
Math operators	
Math operators.....	150
Equation examples	
Equation examples .....	151
Table editor	
Table editor .....	160
Precompensation plug-in	
Precompensation plug-in.....	164
Waveform requirements	
Waveform specifications and notes .....	165
File formats (creating)	
File formats (creating).....	165
Sequence file format	
Sequence file format (.seq).....	166
Waveform file format	
Waveform file format (.wfm).....	168
Matlab waveform file format	
MATLAB waveform file format.....	173
MATLAB waveform file example .....	176
MATLAB IQ file example .....	177

## Controls and connectors

Front-panel controls and connectors	
Front-panel controls .....	181
Front-panel connectors.....	182
Rear panel connectors	
Rear-panel connectors.....	183

## Working with Functions

Functions home window overview .....	187
--------------------------------------	-----

## Diagnostics

Diagnostics .....	189
-------------------	-----



## Calibration

Calibration.....	193
------------------	-----

## Enhancements and plug-ins

Enhancements for your instrument .....	195
--	-----

## Licensing

Licensing overview.....	197
How to purchase a license .....	197
How to install a license .....	199
How to return a license .....	200

## Index



## Introduction

Your Arbitrary Waveform Generator (AWG) combines world-class signal fidelity with ultra high-speed mixed signal simulation and a graphical user interface. The easy-to-use interface is built on the Microsoft Windows platform and is fully compatible with a wide range of PC hardware and software accessories, such as networked instruments.

### AWG and Functions mode selection

The generator has two modes of operation, the Arbitrary Waveform Generator (AWG) mode and the Functions mode. Access to either mode of operation is from the Home tabs of your instrument by selecting either the AWG or Functions button.

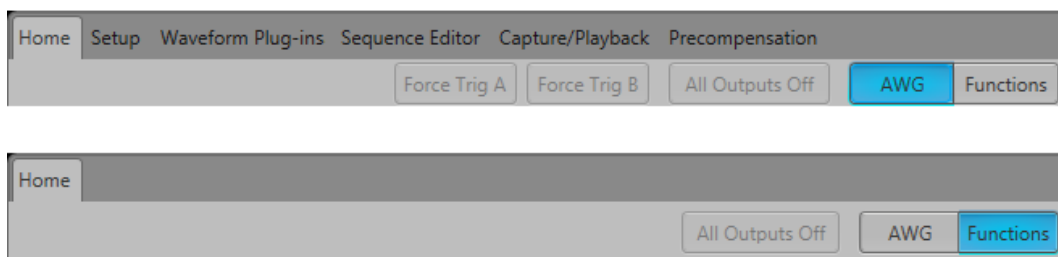

- **AWG** displays the arbitrary waveform generator Home screen with access to all AWG controls, playing any waveshape from a file.
- **Functions** displays the Home screen with controls to generate basic waveshapes, such as sine waves, square waves, and triangle waves.

The AWG and Functions modes work independently from each other, but they both use the Analog Output connectors to play out their waveforms.

### Controls

Several methods of controlling the instrument are provided.

- Capacitive touchscreen interface.  
Use the touchscreen to control all operations of the instrument. Or use in conjunction with a mouse, keyboard, and front-panel controls. You can enable or disable the touchscreen from the Utilities menu. The capacitive touchscreen is designed to operate with direct skin contact or use of a capacitive type stylus.
- Keyboard and mouse
- Front-panel controls
- Remote control via the programmable interface

## External display

Enhanced viewing of the AWG display is easily accomplished by attaching an external monitor to the VGA connector provided on the rear of the instrument.

By default, the VGA output is set to duplicate the AWG's display, but you can use the Windows display controls to change how the instrument uses an external display.

## Product software

The instrument includes the following software and related documents:

- System software

The system software is a specially configured version of Microsoft Windows, which is preinstalled and enables you to install other compatible applications. For instructions on how to restore Microsoft Windows, refer to the Installation and Safety manual that is shipped with your instrument. Do not attempt to substitute any version of Windows that is not specifically provided by Tektronix for use with your instrument.

- Product software

The product software is the instrument application and runs on Microsoft Windows. It provides the user interface (UI) and all other instrument control functions.

- Release notes

The release notes contain information on updates and known issues that are not included in other product documentation.

## Documentation

The following table lists the primary documentation available for this product.

All listed documents are available on the Tektronix Web site (<http://www.tek.com/manual/downloads>).

To read about	Use these documents
Installation and Safety	Read the Installation and Safety manual for general information about how to prepare your instrument for use and basic operating instructions. This manual is provided with the instrument. Tektronix part number 071-3529-xx.
Operation and user interface help	Access the application help from the Help menu for information on all controls and on-screen elements. The application help is part of the product software. A PDF of the help system is available, Tektronix part number 077-1334-xx.

To read about	Use these documents
Programming commands	Access the programmer manual for the syntax of remote control commands. Tektronix part number 077-1337-xx.
Specifications and performance verification procedures	This technical reference document provides the complete instrument specifications. Procedures are provided to verify the instrument is operating to the warranted specifications. Tektronix part number 077-1335-xx.

## Support information

Tektronix offers the following services in support of their products:

- **Technical Support.** For application-related questions about a Tektronix product, see [Contacting Tektronix](#).
- **Service Support.** For service-related questions about a Tektronix product, see [Contacting Tektronix](#).

Tektronix also offers extended warranty and calibration programs as options on many products. Contact your local Tektronix distributor or sales office.

## Analysis and connectivity support

Tektronix Windows-based arbitrary waveform generators support industry-standard software tools, applications and protocols. The integrated Windows desktop of these models enables popular commercial programs or custom-written applications to run on the instrument.

The instrument includes tools that you can install to support data import or export for use with data-analysis tools. The following tools are supported:

- TekVISA

TekVISA is a library of industry-standard compliant software components, organized according to the standard VISA model established by the VXIplug&play Systems Alliance. Use TekVISA in software to write interoperable instrument drivers to handle communicating between software applications and your instrument.

TekVISA must be the only VISA type software installed. If other VISA software is installed, connectivity will be impaired or disabled.

- VXI-11.2 LAN Server

The VXI 11.2 LAN Server provides software connectivity between your instrument and remote PCs over an Ethernet LAN. This tool is a client-side component built-in with TekVISA on each remote PC; you must install another copy of TekVISA to make use of its client-side component.

- IVI Drivers

IVI drivers conform to specifications produced by the IVI Foundation. IVI drivers provide a standard interface to different classes of instruments, including oscilloscopes and spectrum analyzers.

Tektronix IVI-COM driver supports easy waveform transfer from third party software, such as MATLAB.

## AWG mode general overview

Selecting the AWG mode button displays the controls for operating the arbitrary waveform generator.

- [Toolbar \(see page 19\)](#): contains tools to access help, restore the interface layout, and work with setups, open and save files.
- [Workspace tabs \(see page 6\)](#): contain tabs to change the workspace view (which includes the graphical waveform display area).
  - **Home** tab contains the waveform plot area and various controls for quick access.
  - **Setup** tab contains the settings to control the channel outputs, clocks, and triggers.
  - **Waveform Plug-ins** tab contains the selections for optional waveform creation applications. A basic waveform creation application is included as a standard plug-in.
  - **Sequence Editor** tab contains the sequence editor to create and edit sequences. (Option SEQ (Sequencing) is required to display this tab.)
  - **Capture/Playback** tab contains the controls to import baseband I/Q data files (captured from an instrument such as a spectrum analyzer or oscilloscope) and compile them into a waveform for playout. You can also import files created with other tools such as MATLAB.
  - **Utilities** tab contains system, preferences settings, and instrument information.
  - **Precompensation** tab contains the settings to create correction files to be used with a waveform file. The Precompensation plug-in must be installed to display this tab. To use the plug-in, it must be licensed.
- [Play/Stop button \(icon\) \(see page 15\)](#): starts and stops the playout of a waveform. This function is the same as the front-panel Play/Stop button.
- **AWG/Functions buttons**: switches the instrument between the arbitrary waveform generator (AWG) mode and the basic waveshape generator (Functions) mode. The workspace tabs change in conjunction with the selected instrument modes.
- [Waveform List \(see page 21\)](#) and [Sequence List \(see page 46\)](#): contains the waveforms and sequences available for use.
- **Status area**: displays user messages to indicate possible problems or status.
- **All outputs off button**: provides you with an easy way to quickly disconnect all analog, marker, and flag outputs. (The output connectors are electrically floating.)

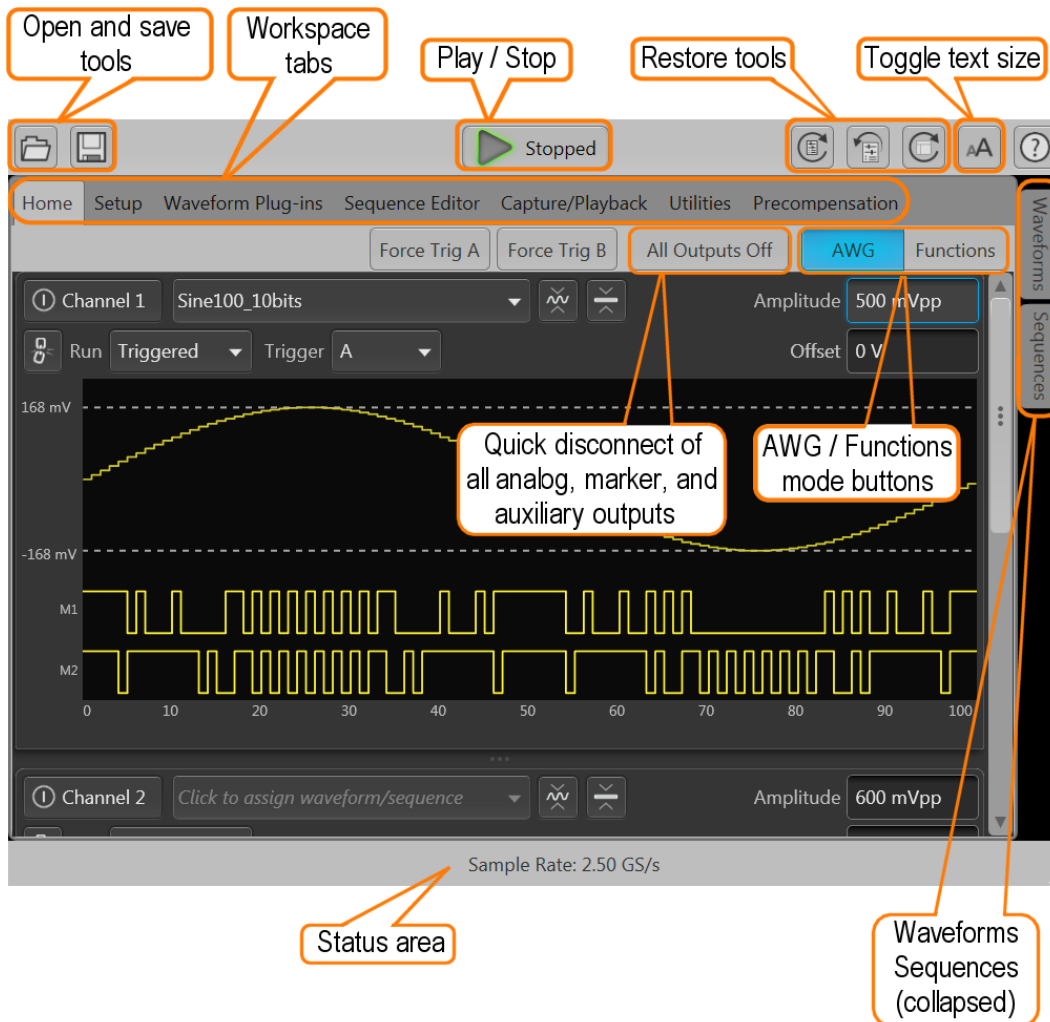

## AWG workspace tabs

The AWG workspace panel is the main working area for setting up and controlling waveform payout.

Tabs at the top of the screen display different views and settings.

- [Home tab \(with waveforms\) \(see page 7\)](#)
  - Displays waveform, cursors, markers
  - Provides buttons for waveform output control
  - Provides quick access to triggering



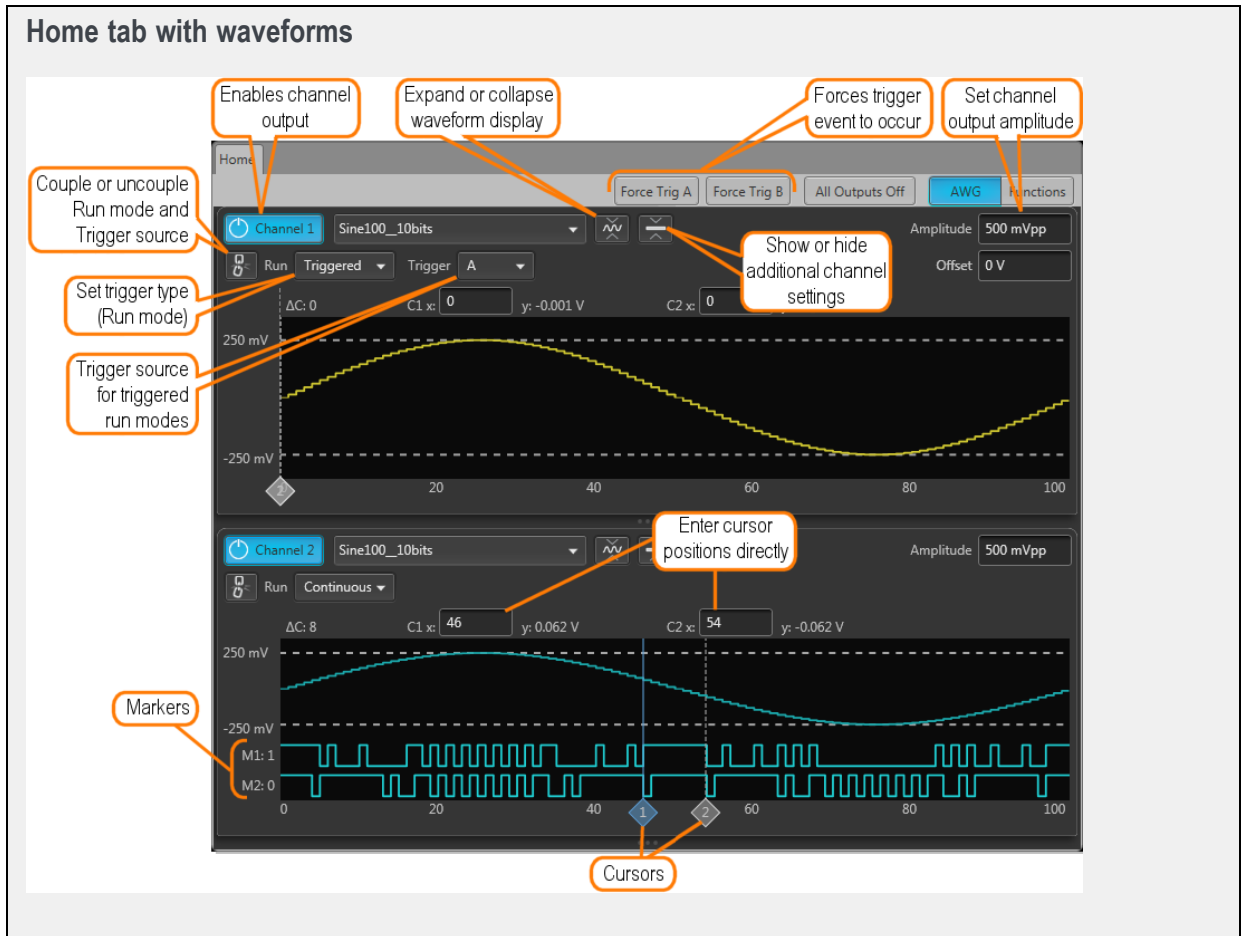

- [Home tab \(with sequence\) \(see page 8\)](#)
  - Displays the sequence track assigned to the channel
  - Provides buttons for waveform output control
  - Provides quick access to force a jump to another location in the sequence

**Home tab with sequence**

Enables channel output

Force an immediate jump to a selected sequence step

Forces trigger event to occur

Set channel output amplitude

Force Trig A Force Trig B All Outputs Off AWG Functions

Channel 1 Sequence\_11 - Track 1 Amplitude 500.0 mVpp

Force Jump To... Current step: 1 Offset 0 V

	Wait	Track	Flag	Repeat	Event	Jump to	Go to
1	TrigA	Wave_2	H	1	TrigA	Last	Next
2	Off	Wave_15		3	Off		Next
3	TrigA	Wave_1	L	1	TrigB	End	7
4	Off	Wave_9		1	Off		Next
5	Off	Wave_4	T L	1	Off		Next
6	TrigB	Wave_10	H	1	Off		Next
7	Off	Wave_5		1	TrigA	First	Next
8	Off	Wave_11		1	Off		Next

Sequence step currently playing

Sequence track display (cannot be edited in Home tab)

- [Home tab \(with IQ waveform\) \(see page 9\)](#)
  - Displays both the I and Q components of an IQ waveform
  - Displays center frequency

---

**NOTE.** To display and play an IQ waveform, the digital up-converter (DIGUP) must be licensed.  
 IQ waveforms and real waveforms cannot be assigned to channels at the same time.

---

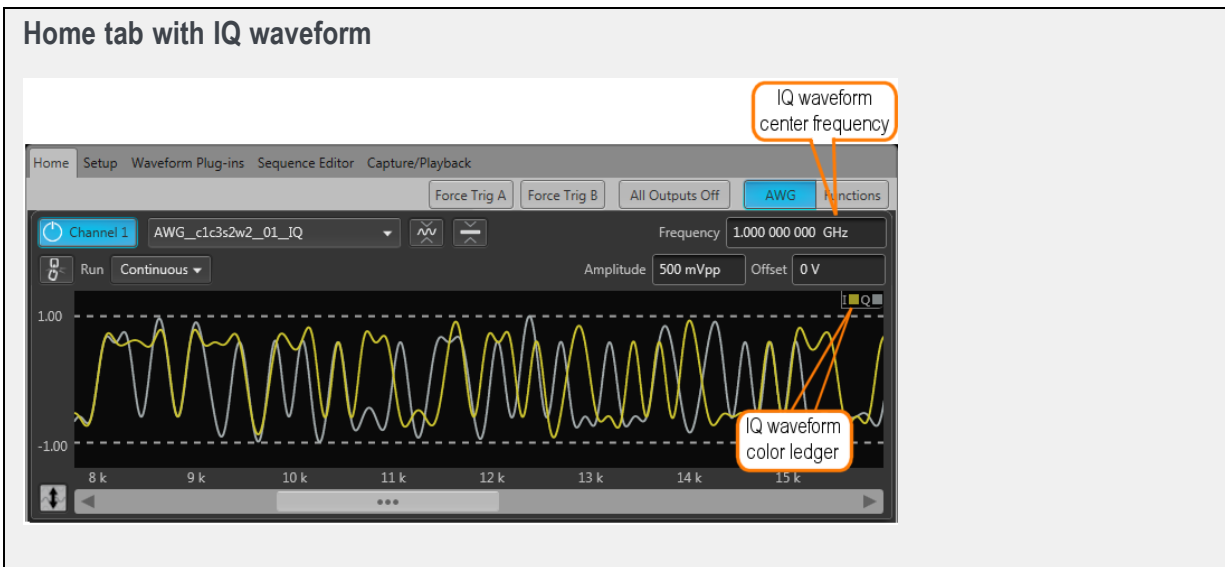

- [Setup tab \(see page 9\)](#)
  - Adjust Channel settings
  - Adjust Clock settings
  - Adjust Trigger settings
  - Adjust relative timing of output signals
  - Define Auxiliary outputs (Flags)
  - Enable instrument to instrument synchronization

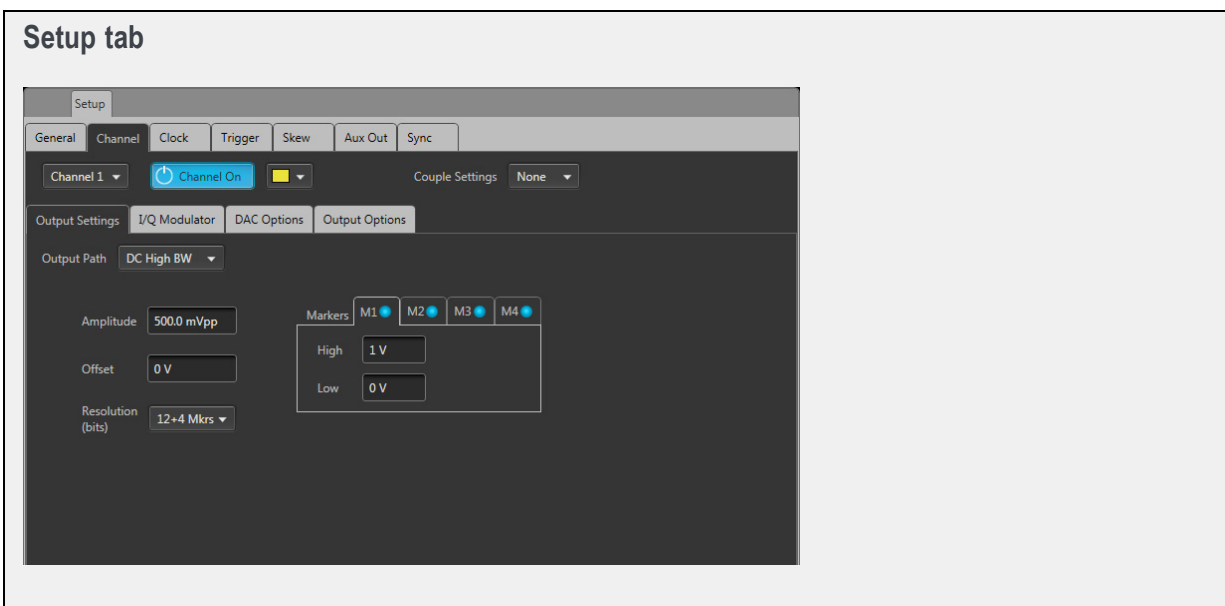

- [Waveform plug-ins tab \(see page 11\)](#)
  - Standard waveform plug-in applications are located here, which includes:
    - Basic Waveform editor
    - Equation Editor
    - Table Editor

---

**NOTE.** *The standard waveform plug-ins are documented in this help system. Optional waveform plug-ins have their own unique help systems.*

---

- Optional waveform plug-in applications are added here.

---

**NOTE.** *Optional waveform plug-ins have their own unique help systems are not documented in this help system. Use the help button within the Waveform Plug-ins tab to access the Optional waveform plug-in's help system.*

---

- Create different types of waveforms based on selected waveform plug-in

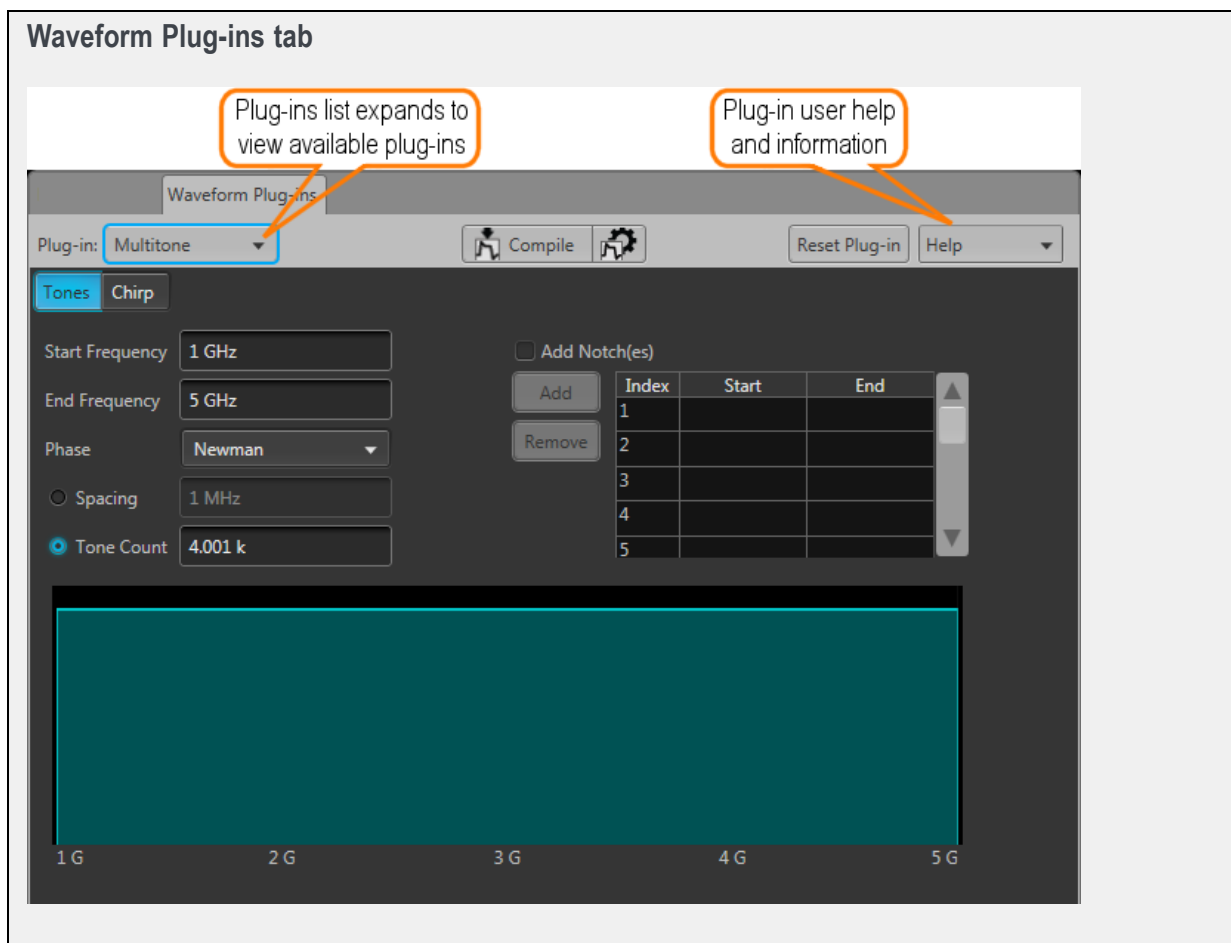

- [Sequence Editor tab \(see page 12\)](#)
  - Create sequences
  - Edit existing sequences
  - Enable Pattern Jump and specify the pattern jump table
  - Sequencing (SEQ) license required

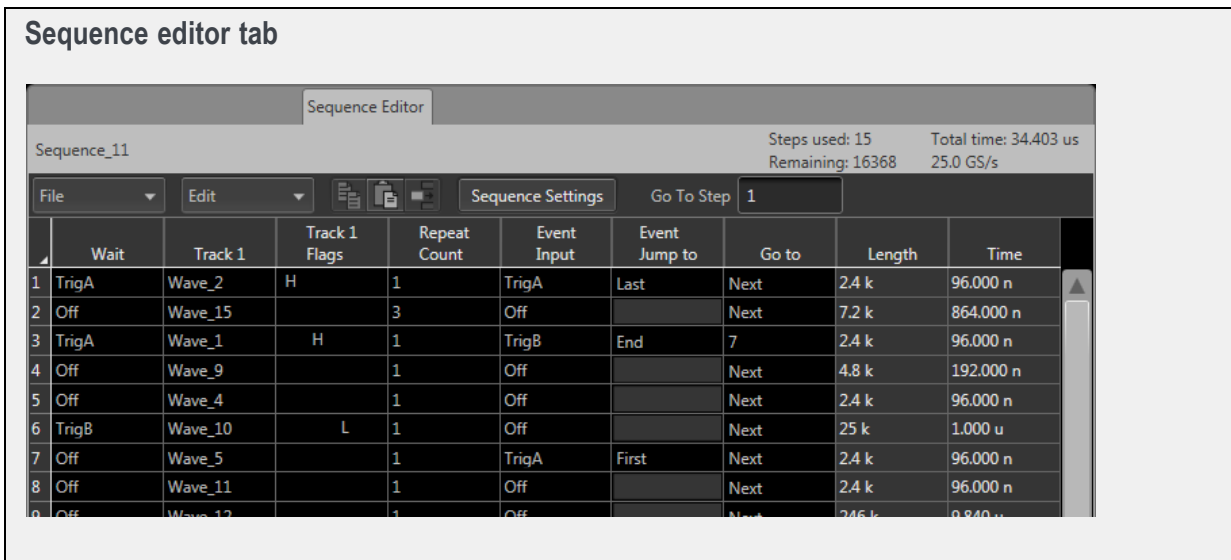

- [Capture/Playback tab \(see page 12\)](#)
  - Import baseband IQ waveforms and up-convert imported waveforms to RF waveforms.
  - Acquire live baseband IQ waveforms from an oscilloscope or spectrum analyzer and up-convert the acquired waveforms to RF waveforms.

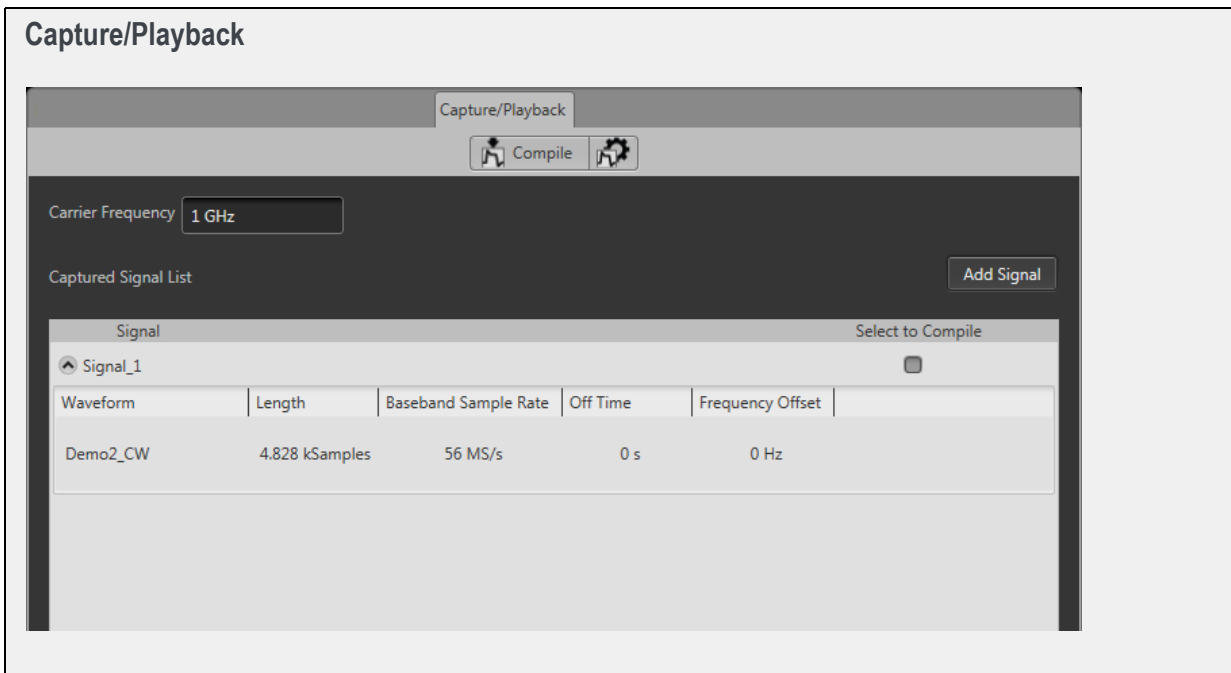

- [Utilities tab \(see page 13\)](#)

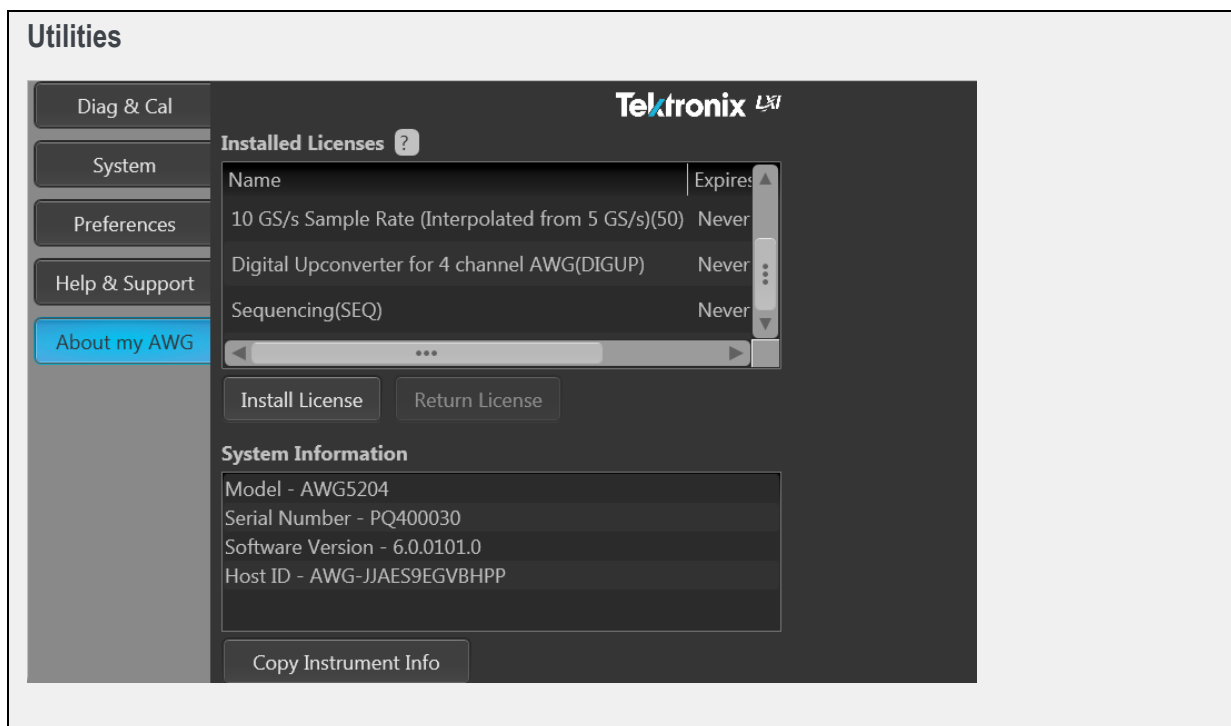

- **Diag & Cal** button: Displays the dialog screen to show the current state of the diagnostics and calibration. The instrument incorporates a temperature sensor that continuously monitors the instrument's internal temperature. If the internal temperature changes more than 5 °C from its previous calibration temperature, a status message appears requesting that you to perform a self-calibration. You can run the calibration routine at any time if your application requires optimum performance. See [Calibration \(see page 193\)](#) for more information about self-calibration. See [Diagnostics \(see page 189\)](#) for more information about performing diagnostic routines.
- **System** button: System provides information about the instrument's GPIB address and Security controls.

The GPIB Address setting lets you set the instrument's identity when using a GPIB converter for the programmable interface. Refer to the AWG5200 Series Programmers manual for complete details about the programmable interface.

Security controls allow you to lock the instrument's display screen. When locked, all front-panel controls are disabled except for the power button.

You can also choose to disable the ability of the external SourceXpress application to connect and control the instrument. SourceXpress has the ability to connect to, and control, the instrument directly from its interface.

- **Preferences** button: Preferences provides access to (brightness controls, error message controls, and text size).
  - Enable or disable the touchscreen
  - Choose to hide the pop-up error messages, forcing the errors to only show in the Status bar at the bottom of the screen.
  - Brightness Controls lets you adjust the intensity levels of the display screen and the front-panel LEDs.
  - Choose to reduce the size of the text and elements of the user interface.
- **Help & Support** button: Help & Support provides links to where you can obtain additional product help and documentation.
- **About my AWG** button: About my AWG provides you with detailed information about your instrument, such as installed options, licenses, and the product's software version. This information is helpful when contacting Tektronix about your instrument. Use the **Copy Instrument Info** button to copy and paste the instrument information into another application such as an email program.

The **Install License** and **Return License** buttons are used to manage optional plug-in application licensing. See [Enhancements for your instrument \(see page 195\)](#).

- [Precompensation tab \(see page 14\)](#)

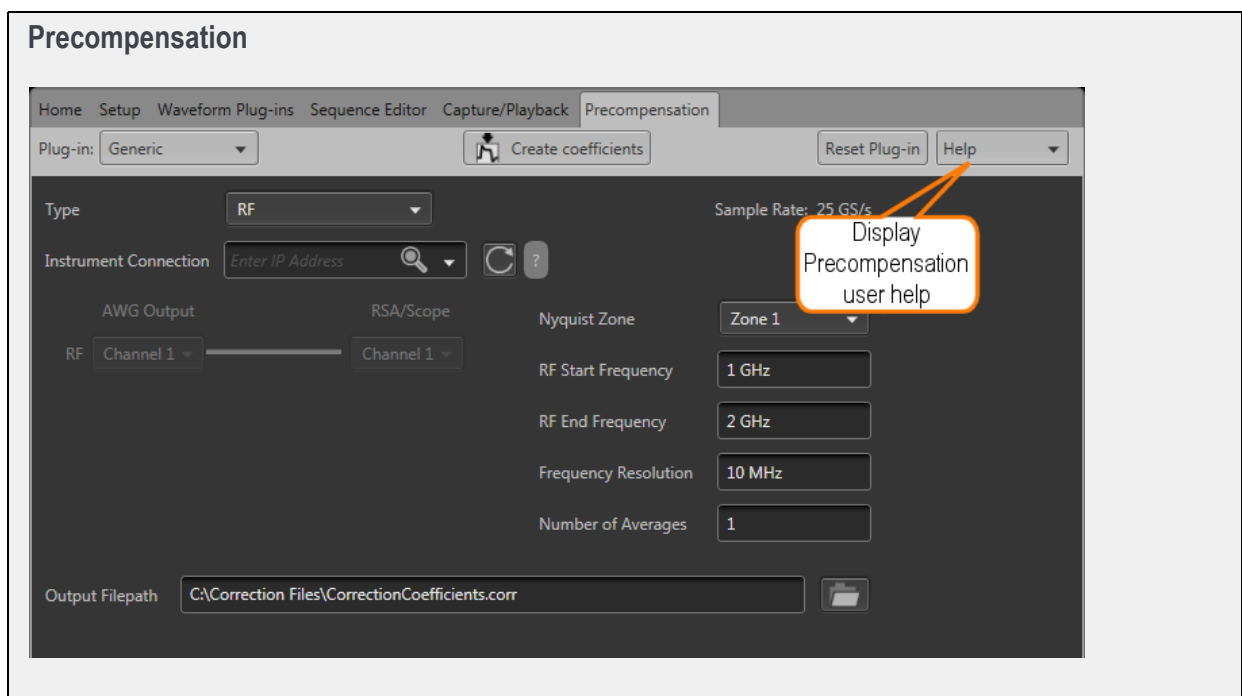

The Precompensation tab allows you to create correction files to be used with a waveform file.



---

**NOTE.** *The Precompensation tab only appears if the Precompensation plug-in is installed. To use the plug-in, it must be licensed. Refer to [Licensing \(see page 197\)](#).*

---

The Precompensation tab has its own user help (and is not described here). Press the help button on the Precompensation tab to access its user manual.

## Run state control





You start and stop the waveform playout using the Play button. For a waveform to be output through the Analog Output connector, the Channel output must be enabled.

The condition of the outputs (output level or disconnected) when waveform playout has been stopped or is waiting for a trigger event, is defined in the [Output Options \(see page 63\)](#) dialog box.

### Run state status indicators

The play button in the graphical interface changes appearance to indicate the waveform playout status. Below are the various indicators.

Table 1:

 Stopped	Not lighted – stopped (or idle) with no waveforms being played.
 Playing	Green with sine wave – currently playing a waveform.
 Waiting	Green with T symbol – waiting for a trigger event to begin waveform playout.
 Busy	Yellow with clock symbol – the instrument is busy and playout is temporarily inhibited.
 Error	Red – An error is preventing the waveform playout.

The front-panel Play button also indicates the playout status with various colors. See [Front-panel controls \(see page 181\)](#) for a description of its status indicators.

## Screen interface features via touchscreen and mouse

The graphical user interface (GUI) is designed with some features that are only accessible via the touchscreen or right and left mouse clicks.

Left mouse click on settings

Touch (or left mouse click) on any control or setting selects or activates that control.

Pull down lists

Selections with a triangle incorporate a pull-down list. Touch (or left mouse click) on the triangle to display the list.



Numerical control settings

A setting that requires a numerical value has an additional menu accessed by touching and holding (or right mouse click) the setting.

The settings menu allows you to quickly set the value to its default, minimum, or maximum values. Cutting, copying, and pasting values is allowed. Pasting an invalid value results with the instrument setting the value to the nearest valid value.

Some settings allow you to change the units used for the setting. For instance, amplitude can be set in Vpp or dBm. Phase adjustments can be set in degrees or time.

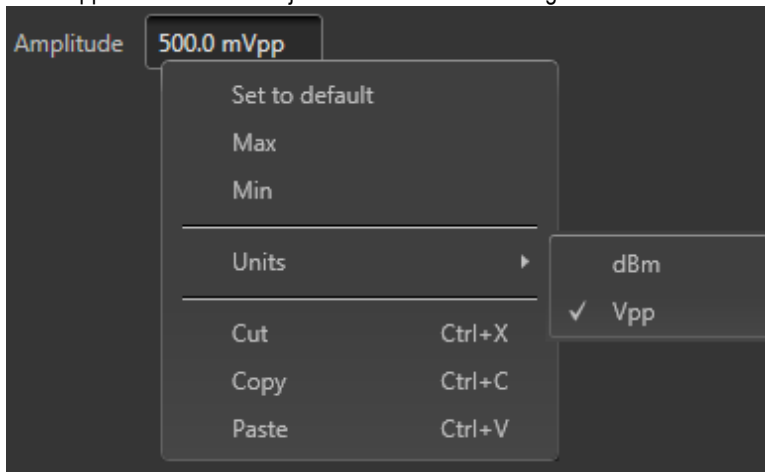

Drag and drop

Use the touchscreen (or left mouse) to drag a waveform or a sequence (from the waveform list or sequence list) onto the waveform display area. Existing waveforms or sequences are replaced. If the previous waveform or sequence was currently playing, the new waveform or sequence starts playing immediately.

Zooming

Use the touchscreen (or left mouse click) to drag a zooming box over the portion of a waveform you want to expand.

- Zoom In: Drag the zoom box from left to right to zoom in on that section of the waveform. The boxed portion is centered in the graph.
- Zoom Out: Drag the zoom box from right to left to zoom out. The boxed portion is centered in the graph.



You can also use the icon to quickly return the waveform to its full display.

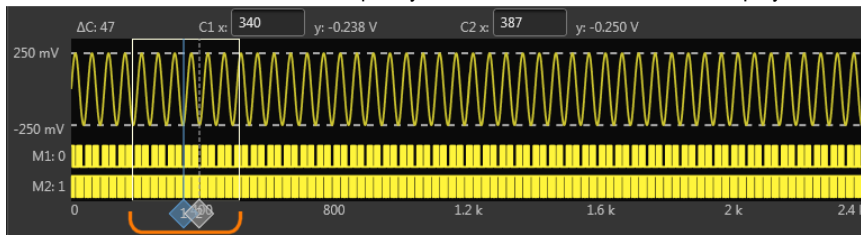

Expanded display

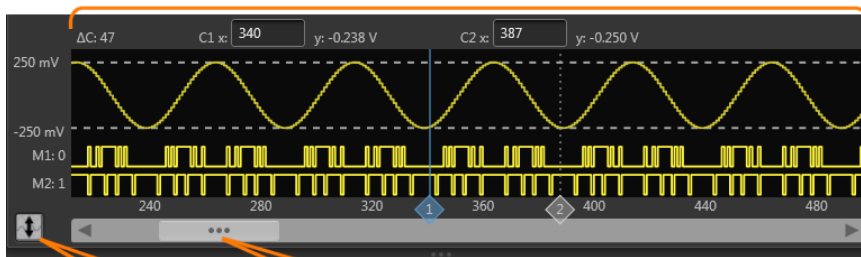

Return to full display

Pan

When zoomed in, you can pan through the waveform using the scroll bar below the waveform.

## Waveform menu

The waveform graphical area contains a menu for various actions.

Touch and hold the touchscreen (or right mouse click) anywhere in the waveform area to display the waveform menu.

- Show cursors toggles the measurement cursor display on or off (default is off). You can drag the cursors into position or enter their position directly in the waveform display area. The cursor display control affects all channels.
- Show Analog toggles the waveform display on or off (there is no default setting). If the waveform display is off, it remains off until it is turned back on. The analog waveform display control is independent for each channel.
- Show Markers lets you select which markers you want to display or hide. Markers are off by default. See the [Resolution \(bits\) \(see page 61\)](#) setting to enable markers. The markers display control is independent for each channel.
- Y Axis toggles the vertical graph axis between Volts and Normalized (default is Volts). The Y Axis control affects all channels.
- X Axis toggles the horizontal axis between Seconds and Samples (default is Samples). The X Axis control affects all channels.
- Grid display (default is off). The grid display control affects all channels.

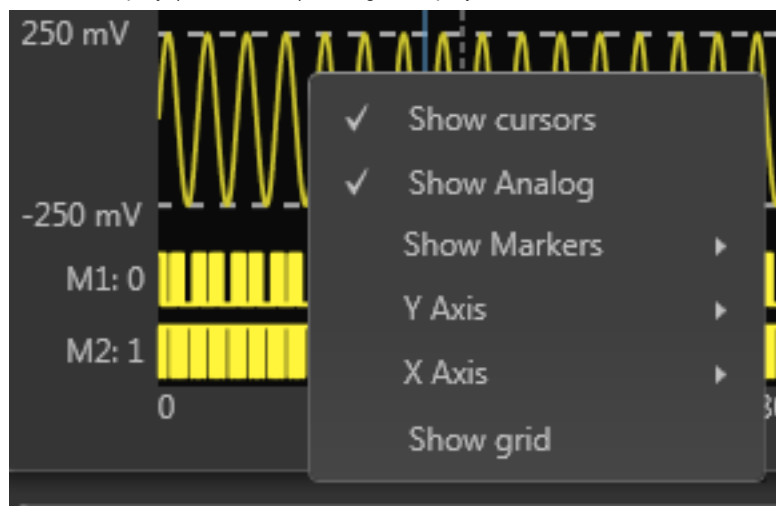

Window panel resizing

The various window panels can be adjusted in size where-ever two panels are divided. Touch and hold the touchscreen (or right mouse click) to grab the 3 dot indicator and slide to increase or decrease the panel size.

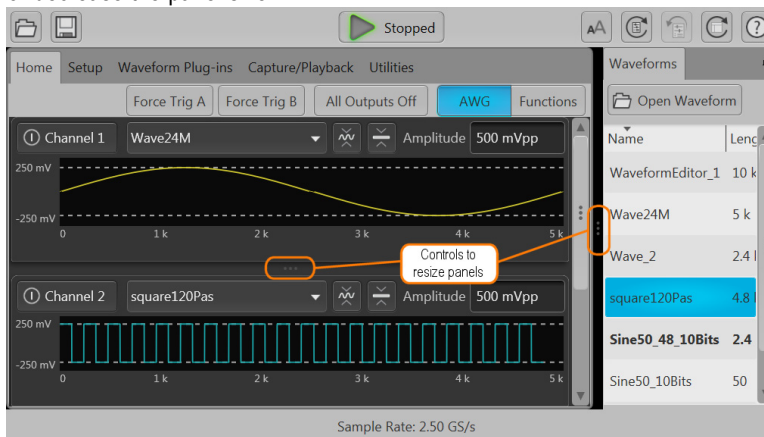

Undocking and docking tabs

Any tab can be undocked from the GUI. This allows you to reposition a tab to a new location or completely separate it from the main GUI. Touch and hold the touchscreen (or left mouse click) to grab a tab and slide it to a new area. The docking icon displays that you can use to choose how you want to dock (reposition) the tab.

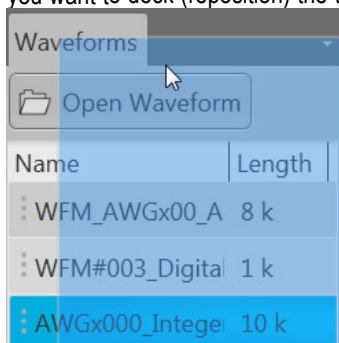

Use the Reset Window Layout button (in the Toolbar) to return the display to the factory settings.

## Toolbar

The [toolbar](#) (see page 21) provides access to various setup actions.

**NOTE.** The AWG mode and Functions mode utilize the same Toolbar. Any action taken by the tools buttons affects both modes. For example, restoring the default setup affects both the Functions mode and AWG mode.

Table 2:



**Open File** allows you to open any of the supported file types.

A windows Open dialog box opens to the most recent location accessed. Use this window to navigate to saved files. In the Open dialog box, you can set the window to display all supported file types or restrict the window to display a certain type of file.

The action taken depends on the file type opened.

- Setup files: Opening a saved setup file returns the instrument to the settings saved with the setup file. Waveforms and/or sequences saved with the setup file are also restored, removing all existing waveforms and sequences.
- Waveform files: Opening a waveform file from the toolbar allows you to select one waveform file at a time to load into the Waveform List. (Matlab files that contain more than one waveform will have all waveforms loaded into the Waveform List. See [Adding a waveform \(see page 23\)](#) for more information.
- Sequence files: Opening a sequence file from the toolbar allows you to select one sequence file at a time to load into the Sequence List. If the sequence file contains subsequences, these are also placed in the Sequence List. All waveforms used in the sequence are loaded into the Waveform list. See [Adding a sequence \(see page 47\)](#) for more information.

A windows Open dialog box opens to most recent location accessed. Use this window to navigate to your files.

The factory location is C:\Program Files\Tektronix\AWG5200\Samples.

For more advanced options to add waveforms or sequences, use the Open icons located within the Waveform List and Sequence List panels.



**Save Setup** saves the current settings as a setup file, allowing you to easily return the instrument to a known setup. A windows Save As dialog box opens to the most recent location accessed. Use this window to navigate to where you want to save the setup file.

In the Save As window, you can choose to save the setup file (which includes all waveforms and sequences) or save the setup file without the waveforms or sequences.

Choosing to save the setup file with waveforms and sequences also saves the waveforms listed in the Capture/Playback signal list.

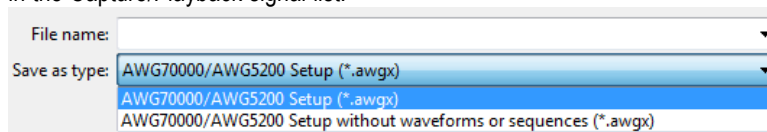

The factory location is C:\Program Files\Tektronix\AWG5200\Samples.



The Play/Stop button starts and stops the playout of a waveform in both the AWG mode and the Functions mode. This operates the same as the front-panel Play/Stop button.

The button changes appearance to indicate the current playout status. Refer to [Run state control \(see page 15\)](#).







Reset to Default Setup returns all instrument settings to their factory settings.

**NOTE.** *The contents of the Waveform List, Sequence List, and Captured Signal List are removed.*

*Restoring the default setup does not re-enable the graphical waveform display if [Show Analog \(see page 15\)](#) is toggled off.*

This control does not reset any installed Waveform Plug-in applications or the Precompensation application (if installed).

Table 2: (cont.)

	Restore Last Setup returns the instrument to the most recent setup that was accessed.
	Reset Window Layout returns all window panels (moved or undocked) to their original locations.
	Toggle the font size (large or small) used in the user interface.
	The User Manual button displays the instrument help system. <b>NOTE.</b> Plug-in applications have their own help system and display an additional help button to display their User Manual.

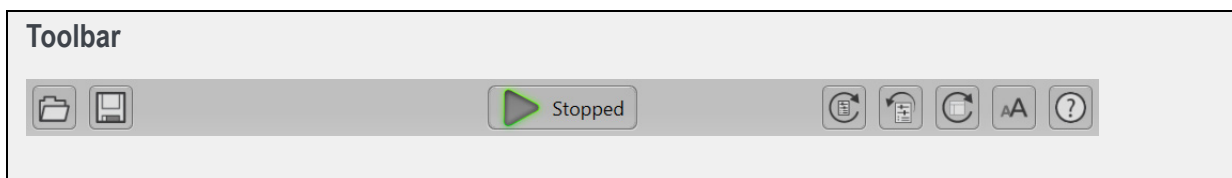

## Working with the waveform list

The Waveform List contains the waveforms available for payout.

You can drag and drop a waveform from the Waveform list onto the channel’s graph area, assigning that waveform to play on the channel. See below when working with IQ waveforms.

Touch and hold or right-mouse click on a waveform to display a pop-up menu of tools to modify waveforms, assign a waveform to a channel, save, remove waveforms, and view a waveform’s properties.

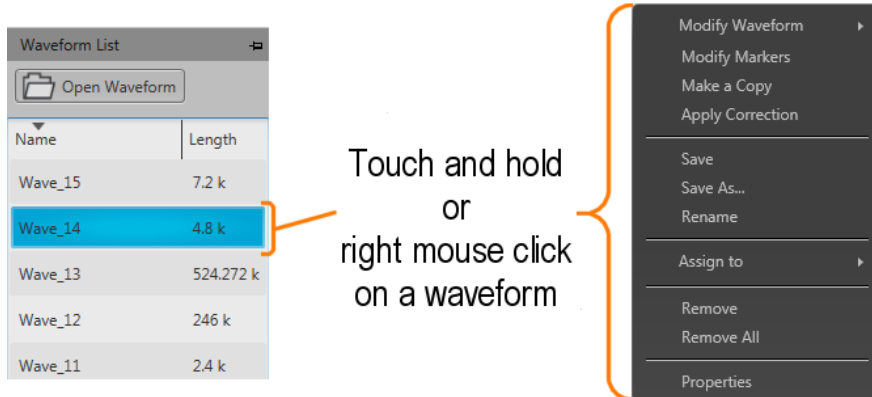

### IQ waveforms (display)

When adding an IQ waveform to the Waveforms List, the I and Q components are separated and a sublist is created under the IQ waveform. Use the arrow next to the IQ waveform name to expand or collapse the sublist.

You can assign the IQ waveform to a channel, or use the sublist to assign the I or Q components to a channel for playback.

---

**NOTE.** *IQ waveforms and real waveforms cannot be assigned to channels at the same time.*

---

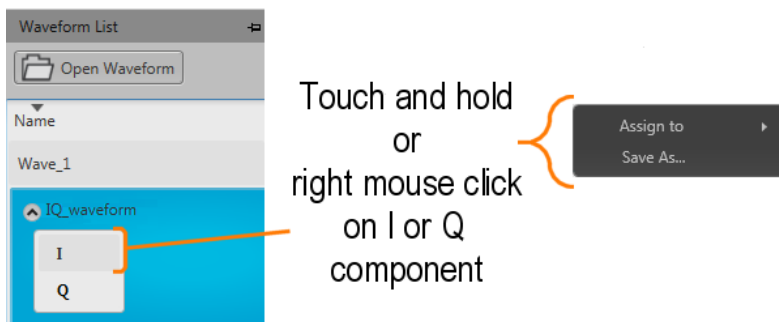

### IQ waveform (create)

If you have I and Q waveform files, you can use the Waveform list to combine them into an IQ waveform. From within the Waveform List, select both the I and Q waveforms.

---

**NOTE.** *The waveform selected first becomes the I waveform. The waveform selected second becomes the Q waveform.*

---

With the selections made, display the right-click menu and select Make IQ Waveform. The I and Q waveforms must be of equal length.

A new IQ waveform is generated using the first selected waveform as the I component and the second selected waveform as the Q component. Hovering over the menu displays a tool tip showing which waveform is I and which waveform is Q.



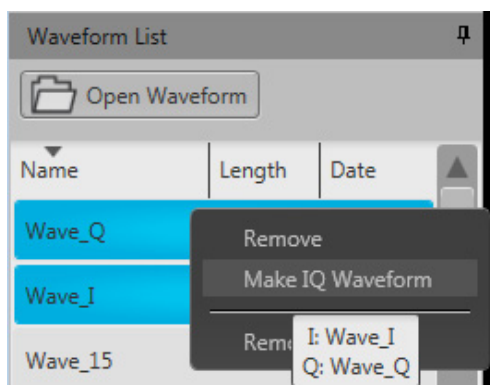

The name of the IQ waveform generated uses the name of the I waveform (without suffix "\_I" or "\_Q") and is appended with "\_IQ".

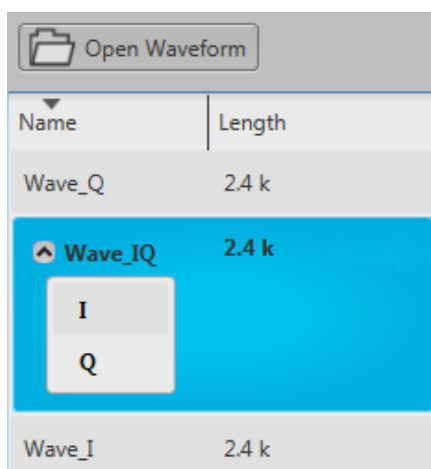

## Adding a waveform

To add a waveform to the Waveform List, select the Open Waveform button. This opens a Windows dialog box that allows you to navigate to a stored waveform, setup file, or sequence file. (You can load waveforms contained in Setup files and sequence files without loading the setup or sequence.)

If the waveform is a valid waveform type, the waveform is added to the Waveform List. Once a waveform is in the Waveform List, it can be assigned to a channel for playout. Click [here](#) to see the list of valid waveform file types.

Valid file types	Description
.AWGX file format	Setup file created by Tektronix AWG5200/AWG70000 Series instruments, or SourceXpress. Setup files can contain multiple waveforms and multiple sequences. <b>NOTE.</b> <i>Opening a setup file from the Waveform List does not restore the instrument settings, only the waveforms contained in the setup file are restored.</i>
.WFMX file format	Setup file created by Tektronix AWG5200/AWG70000 Series instruments, or SourceXpress. See <a href="#">Waveform file format (see page 168)</a> for information about the format of this type of waveform file.
.AWG file format	Setup file created by Tektronix AWG5000 or AWG7000 Series instruments. <b>NOTE.</b> <i>The Tektronix AWG5000 or AWG7000 Series instruments had predefined waveforms available for use.</i>  <i>Saved setup files that used predefined waveforms did not save the actual waveform data with the setup, only the waveform name. Hence, importing setup files that used predefined waveforms will not import the waveforms. To import these types of waveforms, first copy and rename the predefined waveform, then save the setup file before importing.</i>
.WFM file format	Created by Tektronix AWG5000/7000 Series instruments. Created by Tektronix AWG400/500/600/700 Series instruments. Created by Tektronix TDS/DPO/MSO/DSA Series instruments.
.ISF file format	Created by Tektronix TDS/DPO/MSO/DSA Series instruments.
.PAT file format	Created by Tektronix AWG400/500/600/700 Series instruments.
.IQT file format	Created by Tektronix RSA3000 Series instruments.
.TIQ file format	IQ waveforms created by Tektronix RSA6000/5000 Series, SPECMON Series, MDO4000 Series instruments or SignalVu-PC.
.TFW file format	Created by Tektronix AFG3000 Series instruments.
.TXT file format	Created by Tektronix AWG5000 or AWG7000 Series instruments.
.RFD file format	Created by Tektronix RFX100 RFXpress Advanced RF/IF/IQ waveform software.
.SXD file format	Created by Tektronix SDX100 SerialXpress high-speed serial data signals software.
.MAT file format	Matlab file type (Level 5 or Level 7.3) for AWG5200 Series. Matlab file type for RSA6000/5000 Series and SPECMON Series. See <a href="#">Matlab waveform file creation (see page 173)</a> for information on Matlab file requirements for the AWG.
.TMP file format	Midas BLUE file type. (Data Type 1000; Scalar and complex data; 8-, 16-, 32-, 64-bit integer and 32- and 64-bit float data format type.)
.PRM file format	Midas BLUE file type. (Data Type 1000; Scalar and complex data; 8-, 16-, 32-, 64-bit integer and 32- and 64-bit float data format type.)
CDIF file format	Midas BLUE file type. (Data Type 1000; Scalar and complex data; 8-, 16-, 32-, 64-bit integer and 32- and 64-bit float data format type.)

**With Sequencing (SEQ) licensed, the following files types are also valid waveform sources.**

Valid file types	Description
.SEQX file format	Sequence file created by Tektronix AWG5200 Series instruments. (Also can be a subsequence.)
.SEQ file format	Sequence file created by Tektronix AWG400, AWG500, AWG600, or AWG700 Series instruments. (Also can be a subsequence.) See <a href="#">Sequence file format (see page 166)</a> for information about the format of this type of sequence file.

If selecting a file type containing multiple waveforms (.AWGX, .MAT, .AWG, .SEQX), you are presented with the [Available Waveforms dialog box \(see page 25\)](#) that lists all waveforms contained in the file. You can load all the waveforms or select a subset of the waveforms.

**NOTE.** When opening a setup file (.AWGX) from the Waveform List, only the waveforms are extracted; instrument settings contained in the setup file are not restored. Use the Open File in the [Toolbar \(see page 19\)](#) to restore both the settings and waveforms from a .AWGX setup file.

If you want any of the waveforms (extracted from a setup file) to be available outside of the setup file, select and save each individual waveform.

**NOTE.** If using the Channel workspace to load a waveform from a setup type file, you are only allowed to choose one waveform since the waveform is directly assigned to the channel.

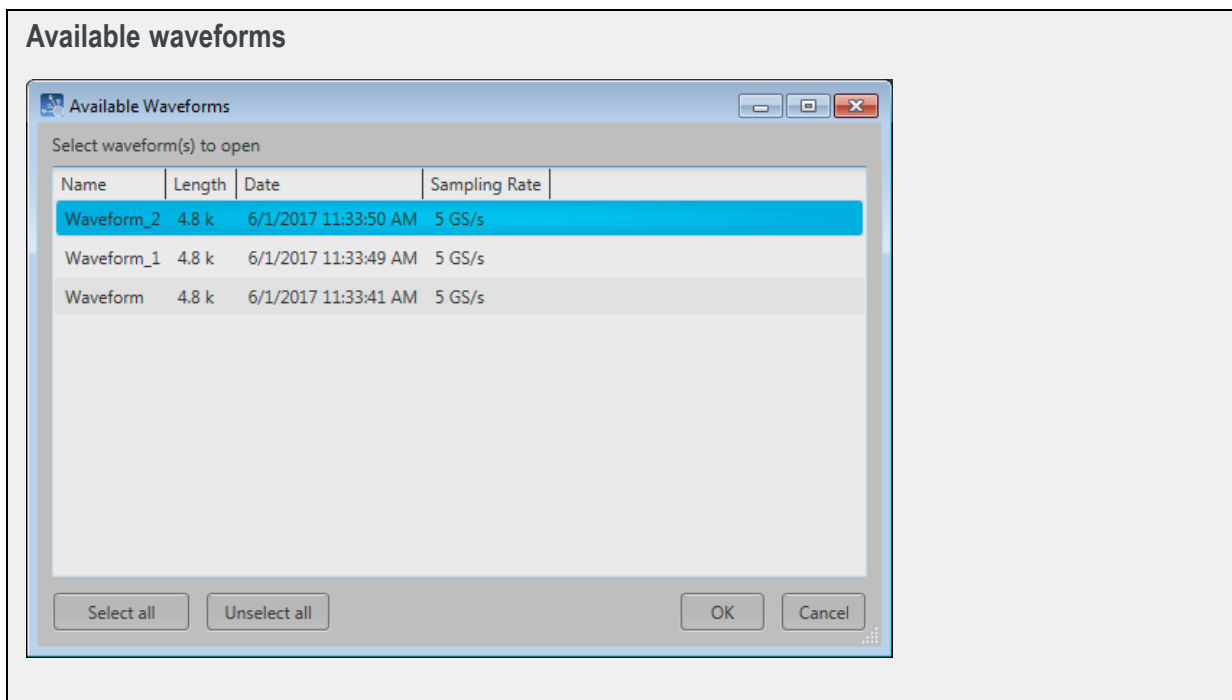

### Non-native analog files

When adding analog waveform file types that are not native to the AWG, you are presented with the [Importing Waveform dialog screen](#) to normalize (rescale) the waveform while adding to the waveform list.

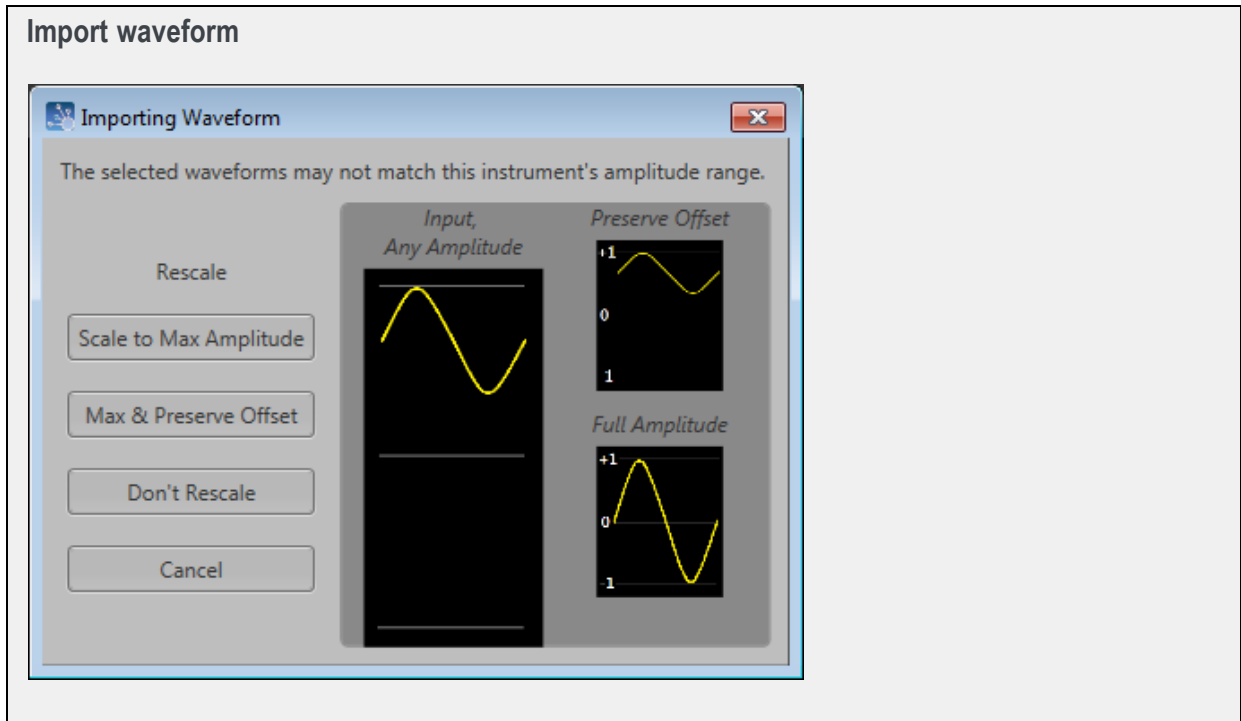

### Digital text waveform file

When adding a digital text (.TXT) waveform file, the [Import Digital Waveform Text File](#) dialog box displays to specify the digital bit resolution of the file before the waveform is added to the waveform list.

Choose from the following:

- **12 Bits (waveform + 4 markers):** For 16 bit files that use 12 bits for data, and 4 bits for markers.
- **13 Bits (waveform + 3 markers):** For 16 bit files that use 13 bits for data, and 3 bits for markers.
- **14 Bits (waveform + 2 markers):** For 16 bit files that use 14 bits for data, and 2 bits for markers.
- **15 Bits (waveform + 1 marker):** For 16 bit files that use 15 bits for data, and 1 bit for a marker.
- **16 bits:** For 16 bit files without markers.

It's important to know the details of your waveform before you import so you do not affect the integrity of the waveform. For instance, selecting 16 bits for a waveform that is intended to use 12 bits for data and four bits for markers will add the marker bits to the waveform data and markers will not be available.

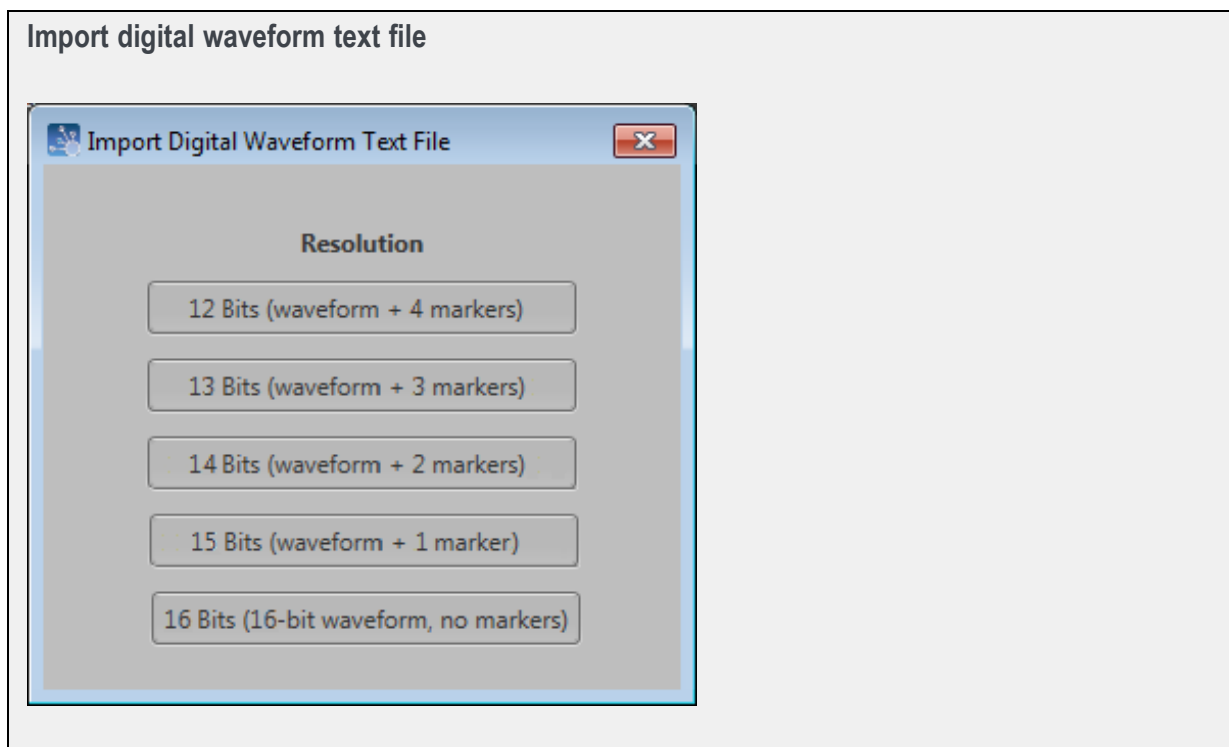

---

**NOTE.** If Sequencing is licensed, waveforms are also added to the waveform list when loading a sequence file or setup file that contains a sequence.

---

### IQ waveforms

When adding an IQ waveform, the waveform is added to the Waveform list along with a sublist of its I and Q components. If the Digital Up Converter (DIGUP) is licensed, you can assign the IQ waveform directly to a channel on the home screen. Otherwise, only the individual I or Q components can be assigned.

---

**NOTE.** IQ waveforms and real waveforms cannot be assigned to channels at the same time. Although the I and Q components of an IQ waveform can be assigned to channels along with real waveforms.

---

---

**NOTE.** You can select to modify an IQ waveform even without a Digital Up Converter (DIGUP) license. The modify dialog screen supports displaying IQ waveforms. See the section [Modify waveform dialog screen \(see page 32\)](#).

---

### Multi-waveform select

Through the Open Waveform menu in the Waveform List, you can select multiple waveform files to load into the waveform list at once.

To select a contiguous block of files, click the first file in the block. Then hold down the Shift key as you click the last file in the block. This will select not only those two files, but everything in between.

To select multiple files that are not a contiguous block, click one file. Then hold down the Ctrl key while you click each additional desired file.

If your selection includes sequence files or setup files, all waveforms saved with those file types are loaded into the waveform list.



**CAUTION.** Loading groups of waveforms will overwrite any existing waveform of the same name in the Waveform List without warning.

**NOTE.** Multiple file selection is available via the Open Waveform menu. Loading waveforms from the Open File menu (in the tool bar) or from the pull-down list in the graphical waveform area does not support multiple file selection.

## Saving a waveform

To save a waveform, touch and hold on a waveform (or right mouse click) and select Save or Save As. This opens a Windows dialog box that allows you to navigate to a location to save the waveform.

Click here to see the list of valid waveform file types.

Valid file types	Description
.WFMX file format	Native waveform file.
.WFM file format	Tektronix AWG400/500/600/700 series waveform file. Maximum waveform size is limited to <200 M.
.TXT file format	Waveform file.
.TIQ	Valid for IQ waveforms.

## Apply corrections

Right click on any waveform (or two waveforms for I/Q correction) and select the Apply Corrections menu.

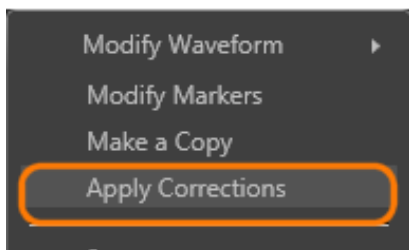

With the Apply Corrections dialog screen, you can choose to apply a correction file.

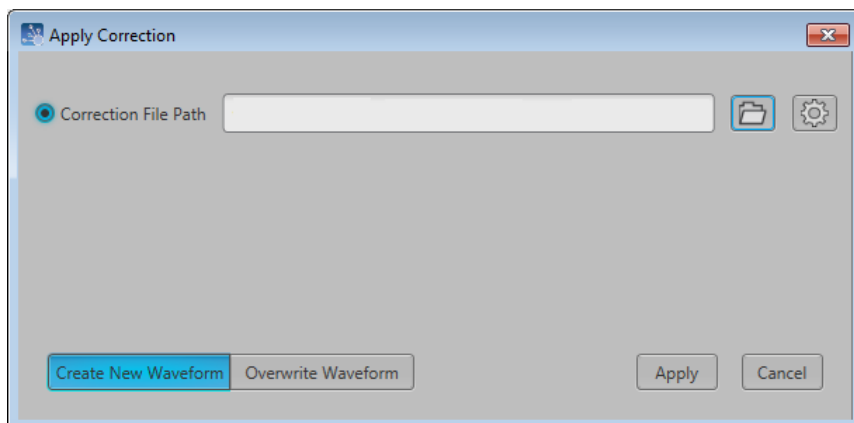

For information about applying a correction file, see:

- [Apply correction file \(see page 40\)](#)

## Assign a waveform to a channel

To play a waveform, you need to assign it to a channel.

There are several methods to assign a waveform to a channel.

- Drag a waveform from the Waveforms list onto a channel's plot area.
- Touch and hold (or right mouse click) on a waveform name in the Waveforms list and use the pop-up window to assign it to a channel.

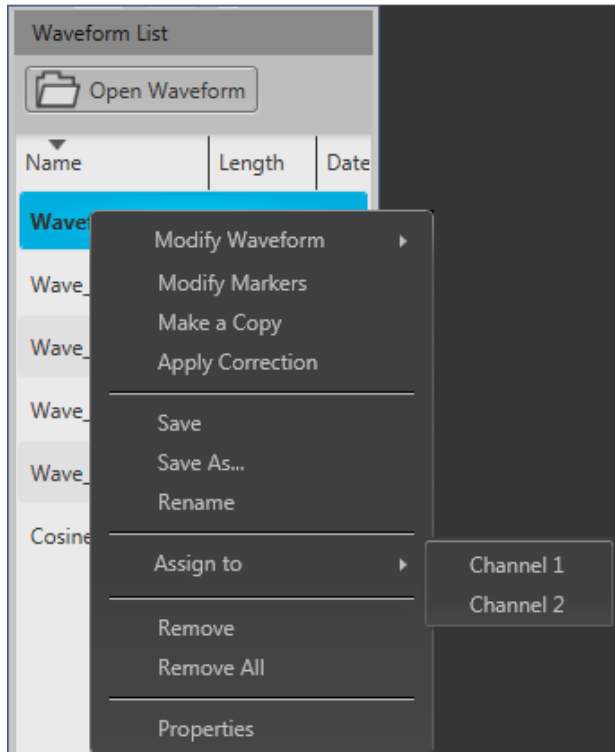

To assign an IQ waveform, the Digital Up Converter (DIGUP) must be licensed. Otherwise, only the I or Q components can be assigned. IQ waveforms display the following menu for assigning the waveforms.

When an IQ waveform is assigned to a channel, both the I and Q components are displayed in the same plot, superimposed on each other. See [Home tab \(with IQ waveform\) \(see page 9\)](#) for an example of the display.

---

**NOTE.** *IQ waveforms and real waveforms cannot be assigned to channels at the same time.*

---

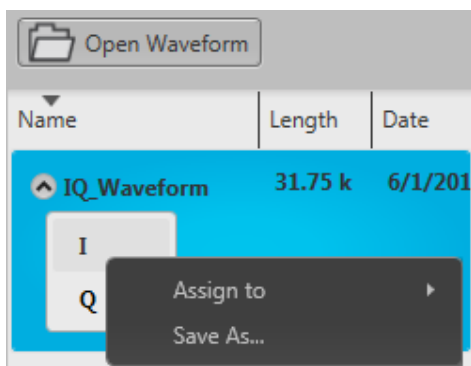



- Use the drop-down list in the channel's plot area to assign the channel to play a waveform.
  - Load a waveform from the Waveform list
  - Browse for a waveform file. (Opens a Windows browser screen to navigate to saved files.) Opening a sequence file while browsing for a waveform opens a dialog box displaying the waveforms available in the sequence.
  - Choose from previously loaded waveforms (maximum of two displayed)

See the section [Assigning tracks to a channel \(see page 49\)](#) about assigning sequences.

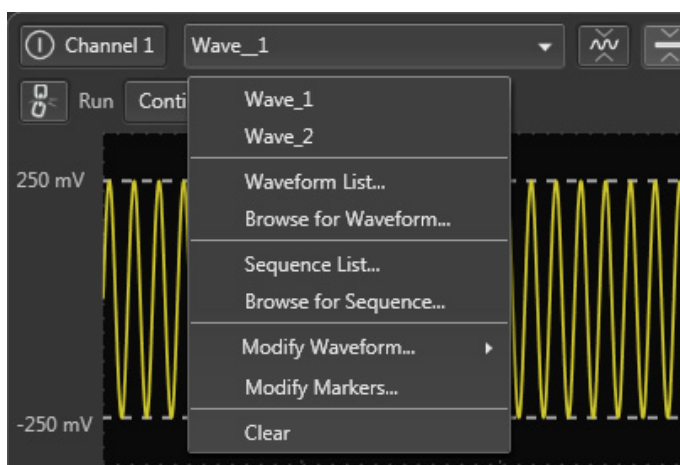

## Modify waveform

You can select any waveform contained in the Waveform List to modify it or create a new waveform based on the existing waveform. But note the following conditions:

- Any waveform can be modified by selecting Modify Waveform → {Sample Rate/Length / Scale/Offset / Rotate/Shift / Invert/Reverse / Pattern}. Select one of these waveform modifiers displays the [Modify Waveform \(see page 32\)](#) dialog screen.
- If selecting a waveform that was created with a Waveform Plug-in, a menu choice is added to take you directly to the specific Waveform Plug-in editor screen. Refer to the section about [Waveform Plug-ins \(see page 124\)](#).
- With an S-Parameter license, you also have the option to apply S-Parameters to the waveform. Refer to the section about [Applying S-Parameters \(see page 41\)](#).

Select a waveform in the Waveform List, touch and hold (or right mouse click) to display the waveform operations.

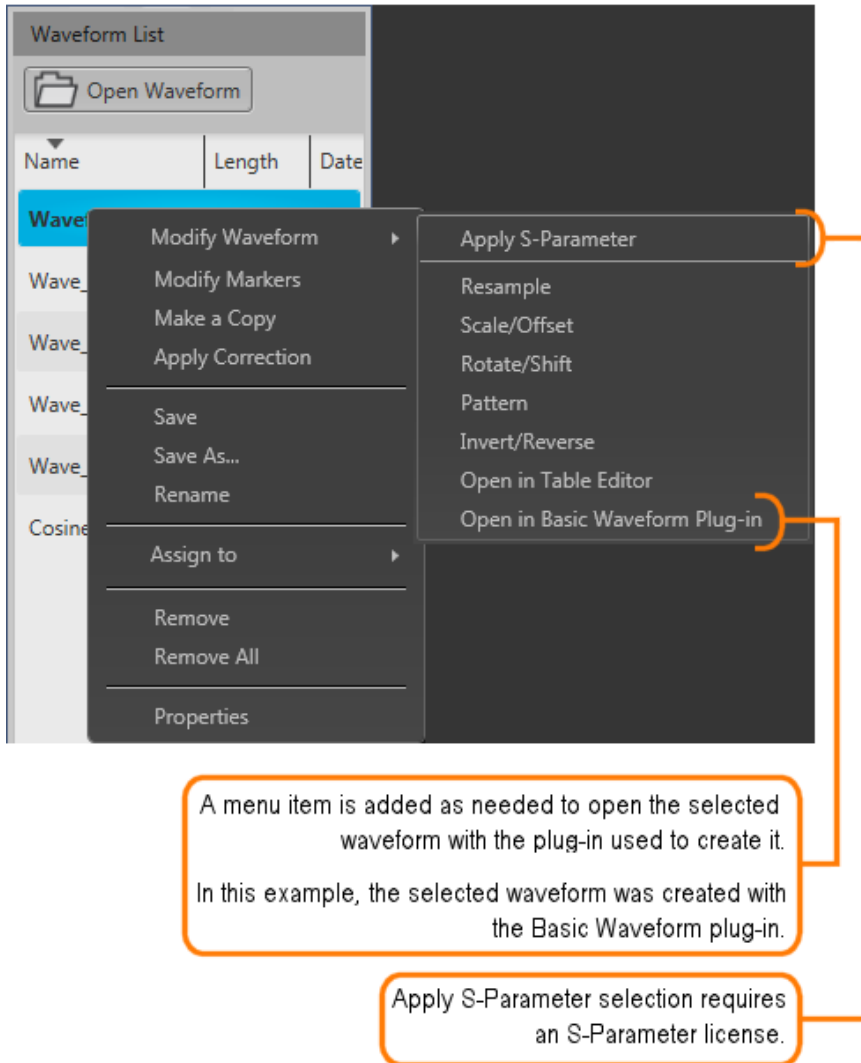

Select one of the waveform modifiers to display the [Modify waveform dialog screen \(see page 32\)](#).

### Modify waveform dialog screen

The Modify Waveform dialog screen provides you with the controls and settings to modify a waveform and save it as a new waveform or overwrite the original waveform.

All operations that are available on the home screen waveform display (such as zooming, cursors, and menu operations) are also available in the waveform display.

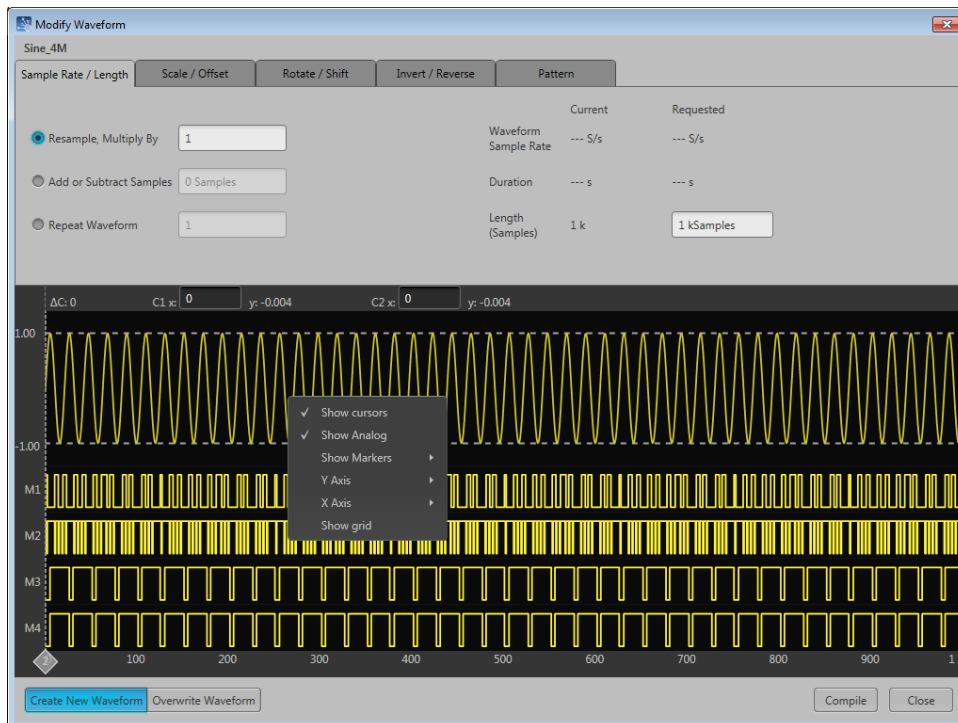

If modifying an IQ waveform, the I and Q waveforms are displayed. The I waveform color uses the color assigned to the channel; the Q waveform is shown in gray.

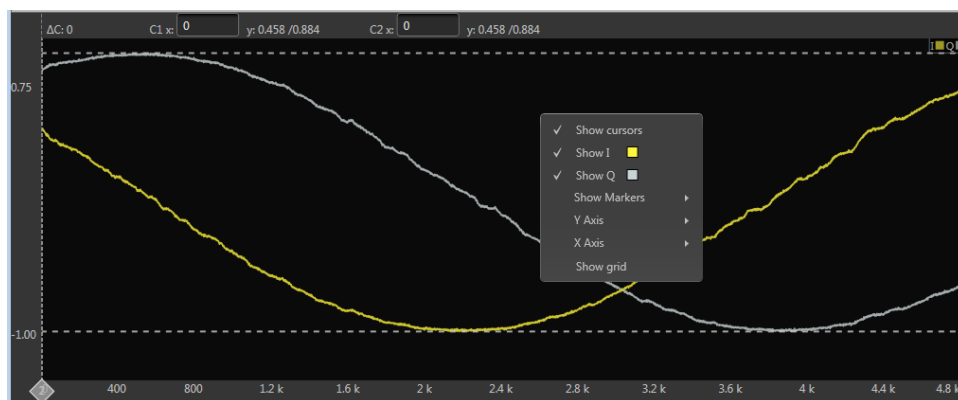

Here are tips and notes about using the Modify Waveform feature:

- The waveform must be in the Waveform List.
- Only one modification is allowed at a time, requiring you to compile the new waveform for each modification. This avoids any uncertainty of modifications since some modifications can affect other characteristics.
- Some modifications may cause a reduction in fidelity to the new waveform.

- The waveform displayed in the dialog screen represents the waveform being modified. After compiling, the resulting waveform is displayed.
- New or modified waveforms are placed in the Waveform List, but are not automatically saved to the hard drive (or other location). They do become part of the setup file if the setup is saved. To make a modified waveform available for use in other setups, select the modified waveform and use Save or Save As to save the waveform.

**Sample Rate / Length tab**

Resample, Multiply By	Enter a value to Increases the number of samples of the waveform. You can also request a sample rate which will automatically enter the correct multiplication factor to obtain the requested sample rate.
Add or Subtract Samples	Adds or removes samples from the end of the waveform. Adding samples repeats the last sample of the waveform. You can also request a specific length (number of samples) which will automatically enter the number of samples to add or remove.
Repeat Waveform	Duplicates the waveform the defined number of times. You cannot enter a value less than one. You can also request a specific length (number of samples) which will automatically enter the duplication factor.

**Scale / Offset tab**

Scale

Multiplier	The Multiplier box allows define a multiplication factor to modify the output amplitude and offsets. Only the analog data is modified. Markers are not affected.
Maximum amplitude	The Maximum amplitude adjusts all values to obtain the full scale amplitude of the instrument. Select the Preserve offset setting If you wish to retain the existing offset value.
Add Offset	Adds normalized offset to the waveform's current DC offset. Scale is not adjustable when adding offset.
Range	You can apply the modifications to the entire waveform (All Samples) or between the cursors.

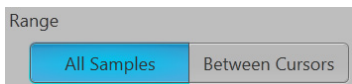

If you select Between Cursors, position the two cursors on the displayed waveform in order to define where the pattern is applied. (If cursors are not displayed, they are automatically enabled).

**NOTE.** Range is not available when modifying an IQ waveform.

**Rotate / Shift tab**

Rotate waveform, wrap samples	Enter a value in degrees or number of samples to rotate the waveform horizontally. Rotating the waveform takes the end of the waveform (defined by the degrees or samples) and moves it to the front of the waveform.
Shift waveform, repeat sample to fill	Enter a value in degrees or number of samples to shift (or move) the waveform horizontally. Shifting moves the waveform and repeats the first waveform sample value to fill in the waveform.

**Rotate / Shift tab**

Apply Rotation/Shift To  
 Rotation and Shift is available for the analog data and the markers.

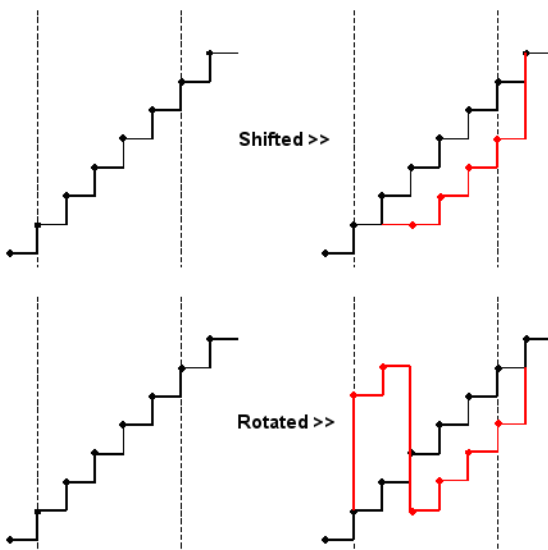

**Invert/Reverse**

Invert	Select which components of the waveform you wish to invert.
Reverse	Select which components of the waveform you wish to reverse.
Range	Select the range of samples you want to invert or reverse. All samples affects the entire analog and marker signals. Between Cursors
All Samples	All samples affects the entire analog and marker signals.
Between Cursors	You can define a particular segment of the waveform to invert or reverse. If cursors are not displayed, they are automatically enabled. Move the cursors to define the affected area. The waveform display has the same control functions as those for the waveform in the Home tab, such as zooming.

**Pattern tab**

See the [Modify markers \(see page 35\)](#) section on using the Pattern features.

## Modify markers

You can select any waveform contained in the Waveform List to modify the waveform markers.

Select a waveform, touch and hold (or right mouse click) to display the waveform operations.

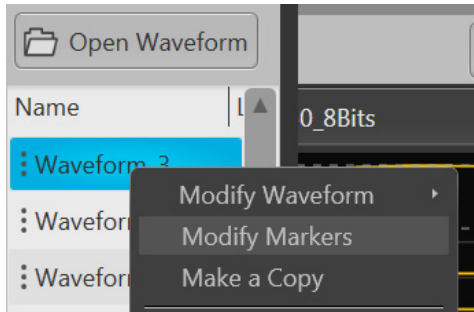

Select Modify Markers to display the Pattern editor tab in the Modify Waveform dialog screen.

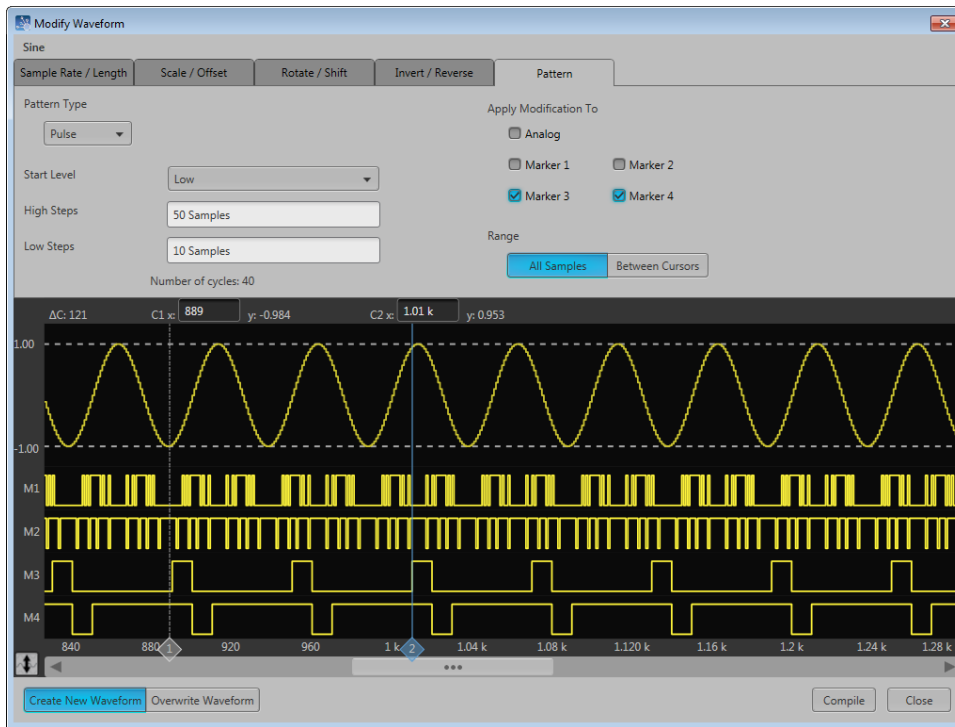

The pattern editor allows you to modify the Analog waveform and/or Markers. Once you've defined your changes, you need to compile the new waveform. By default, a new waveform is created (based on the existing name) and is placed in the Waveform List.

The controls are described below.

**Pattern Type.** Three patterns are available:

- **High:** The sample points (all samples or between cursors) are set to their high values. Marker samples are set to 1. The analog waveform samples are set to the waveform maximum value.
- **Low:** The sample points (all samples or between cursors) are set to their low values. Marker samples are set to 0. The analog waveform samples are set to the waveform minimum value.
- **Pulse:** The sample points (all samples or between cursors) alternate between their high and low values for the defined number of samples.

When choosing Pulse, additional settings are displayed:

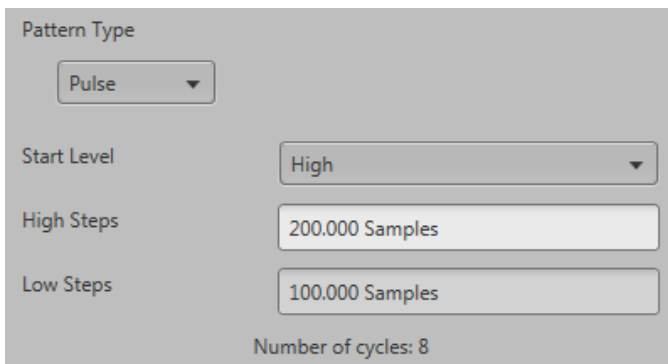

**Start Level** defines whether the cycle of pulses start from their high or low value.

**High Steps** defines how many sample points are set to high.

**Low Steps** defines how many sample points are set to low.

The combined number of samples for the High and Low steps are limited to the number of samples available in the waveform

The number of pulse cycles is calculated and displayed. The number of cycles based on the number of samples used for the high and low steps and if it's being applied to the entire waveform or between cursors.

---

**NOTE.** An invalid pulse definition (such as 0 samples for the high or low steps) will not let the waveform compile.

---

**Apply Modifications To.** The modifications can be applied to the analog waveform and the markers. By default, only the markers are selected.

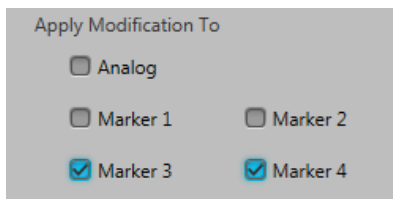

**Range.** You can apply the pattern modifications to the entire waveform (All Samples) or between the cursors.

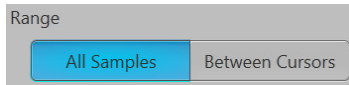

If you select **Between Cursors**, position the two cursors on the displayed waveform in order to define where the pattern is applied. (If cursors are not displayed, they are automatically enabled.)

The waveform display has the same control functions as those for the waveform in the Home tab, such as zooming.

## Waveform properties

You can select any waveform in the Waveform List to view its properties.

Select a waveform, touch and hold (or right mouse click) to display the waveform operations.

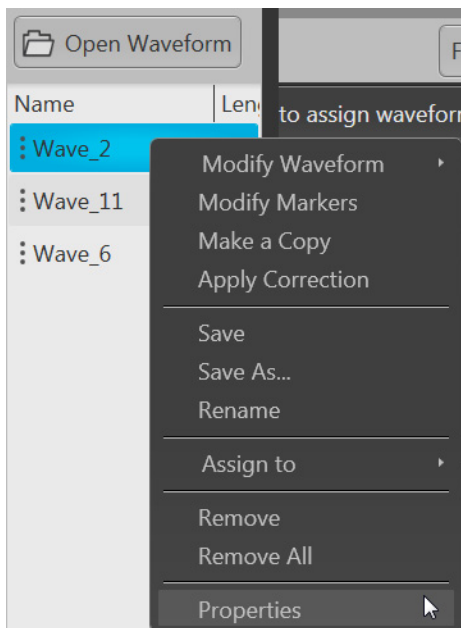

Select **Properties** to display the Waveform Properties dialog screen.



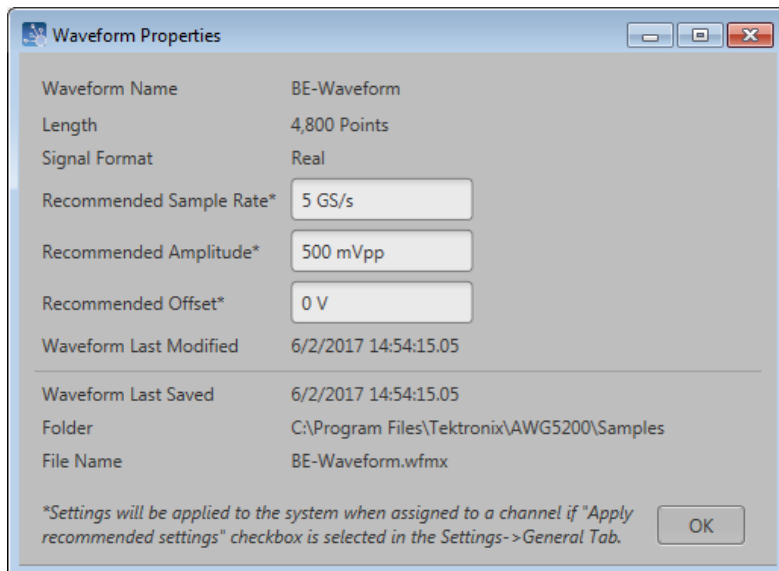

The Waveform Properties dialog screen provides many details about the waveform that are static (not able to modify), such as the name, length, and signal format.

The Signal Format displays the type of waveform, which will show one of the following:

**Real:** Waveform containing data other than I, Q, or IQ.

**I:** Waveform contains I data.

**Q:** Waveform contains Q data.

**IQ:** Waveform contains IQ data.

The items you are able to modify include:

- **Recommended Sample Rate:** Typically defined by the waveform when it was created, you can change the recommend sample rate as needed.
- **Recommended Amplitude:** Typically defined by the waveform when it was created, you can change the recommend amplitude as needed.
- **Recommended Offset:** Typically defined by the waveform when it was created, you can change the recommend offset as needed.
- **Recommended Frequency:** IQ waveforms only. Typically defined by the waveform when it was created, you can change the recommend frequency as needed.

Recommended settings are used when the system is defined to use the sequence settings instead of the system settings during pload. Refer to [General setup \(see page 53\)](#) to enable use of the recommended settings.

## Applying correction file

Correction files for waveforms can contain two types of coefficients, RF coefficients or IQ coefficients.

- RF coefficients can be applied to Real, I, or Q files. Select a single waveform and apply the correction file.
- IQ coefficients must be applied to two waveforms, I and Q. Select the two waveforms (high lighting both at the same time) and apply the correction file.

A window opens to allow you to navigate to the saved coefficient file (correction file).

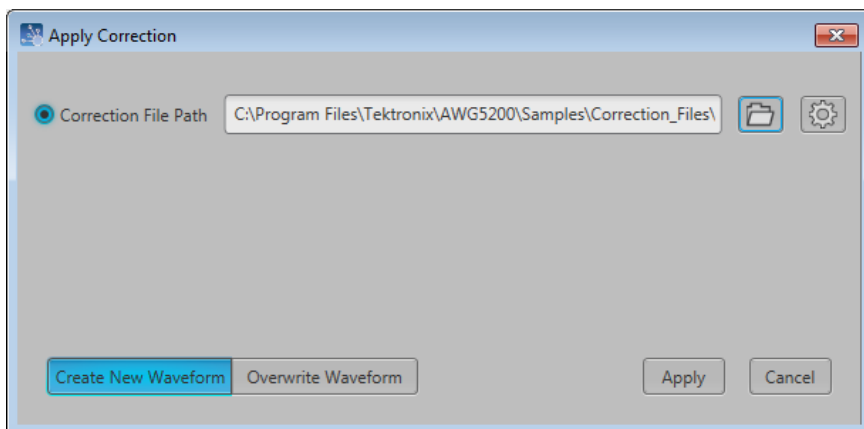

Use the browse folder icon to navigate to a saved correction file.

Choose to either create a new waveform or overwrite the existing waveform.

Once a valid file path is entered, the Correction Settings icon  is enabled. Select the Setting icon to display the Frequency Response screen.

If applying an RF correction file, the Frequency Response screen shows plot information and provides Advanced options to apply a Gaussian filter or remove  $\text{Sin}(x)/x$  distortions.

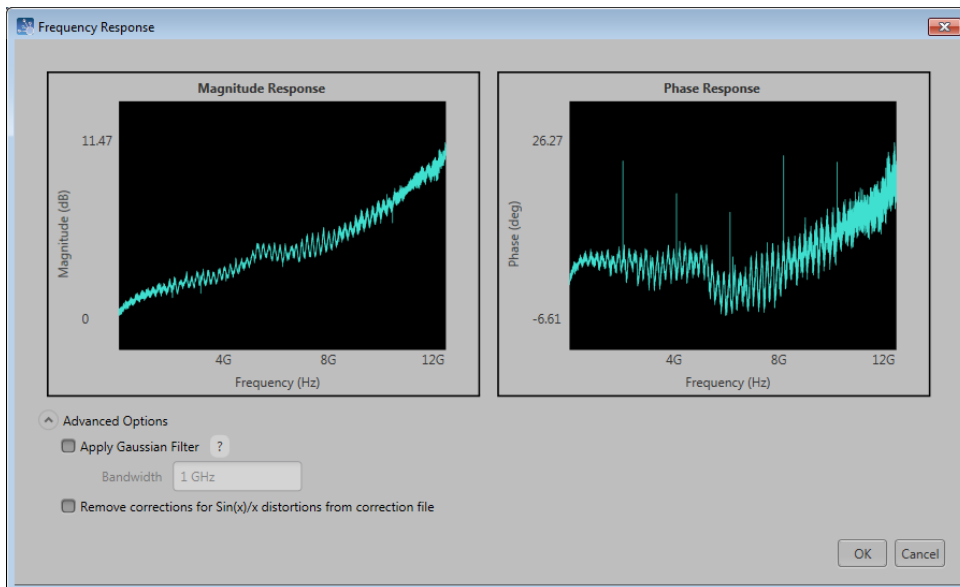

If applying an I/Q correction file (to a pair of I and Q waveforms), the Frequency Response screen shows plot information and provides Advanced options to apply a skew.

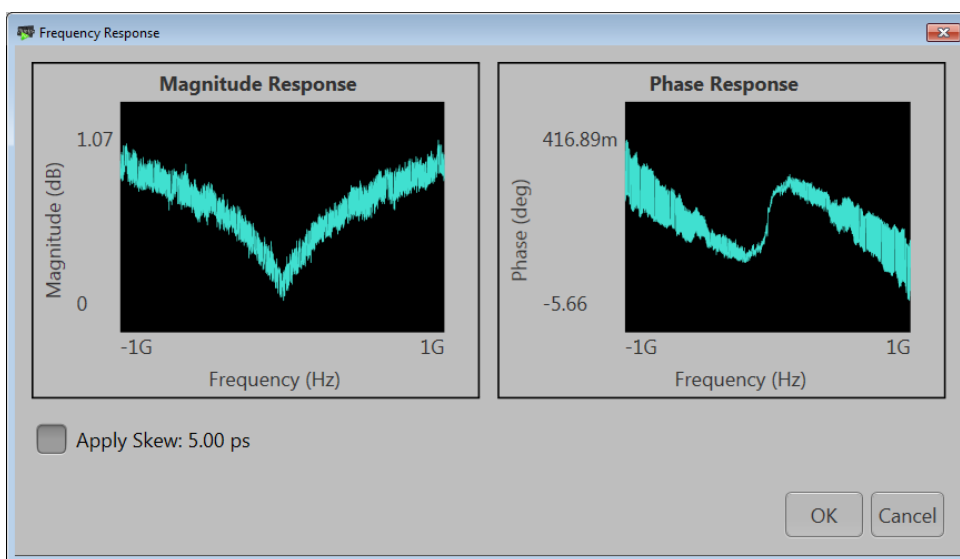

## Apply S-Parameters

S-Parameters (scattering parameters) can be applied to RF waveforms or IQ waveforms in the Waveform List.

**NOTE.** *The S-Parameter selection becomes available only if an S-Parameter license is currently installed.*

Selecting to apply S-Parameters displays the Apply S-Parameter dialog screen, allowing you to select the S-Parameter file and define its characteristics.

Below is a sample S-Parameter dialog screen with the Number of Ports set to 4. If an IQ waveform is being modified, the S-Parameters dialog screen provides additional selections to apply the parameters to the I component, Q component, or both I and Q.

The dialog screen changes to accommodate the Number of Ports selected.

The information provided for S-Parameters applies to both the Non-Cascading and Cascading modes.

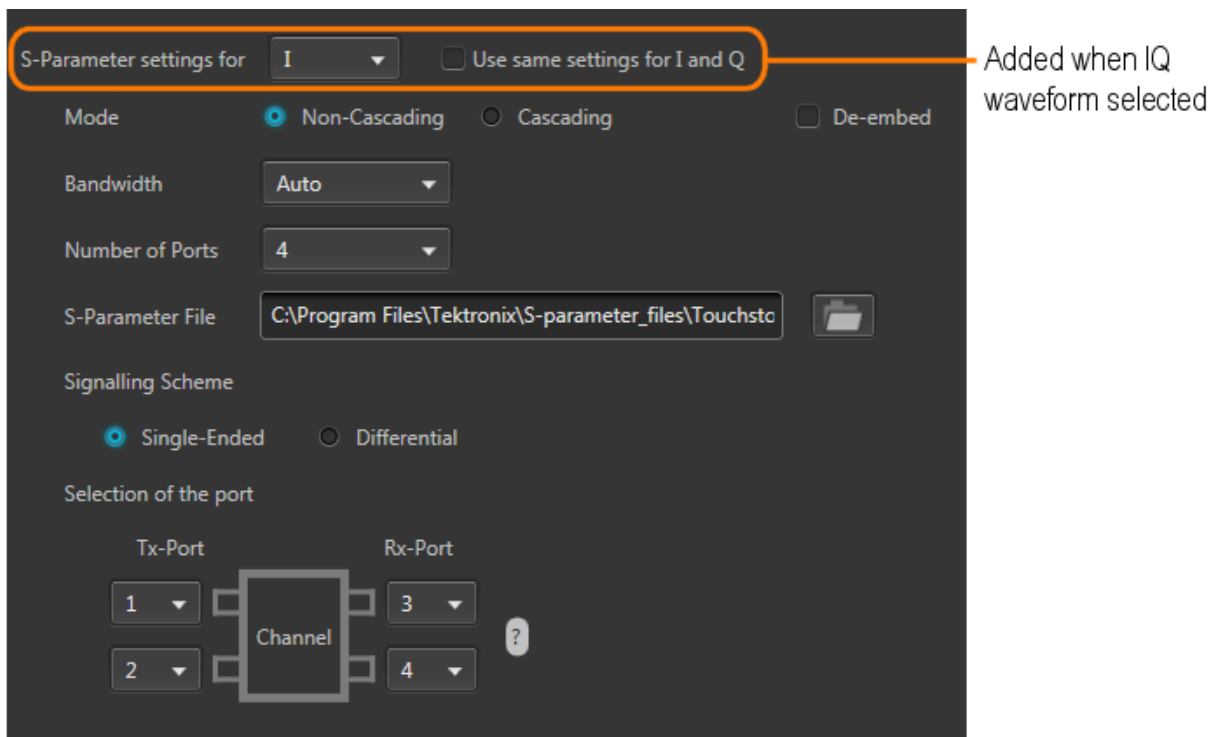

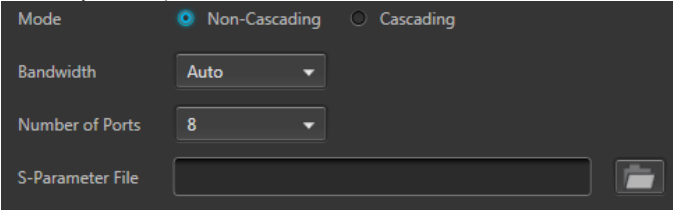
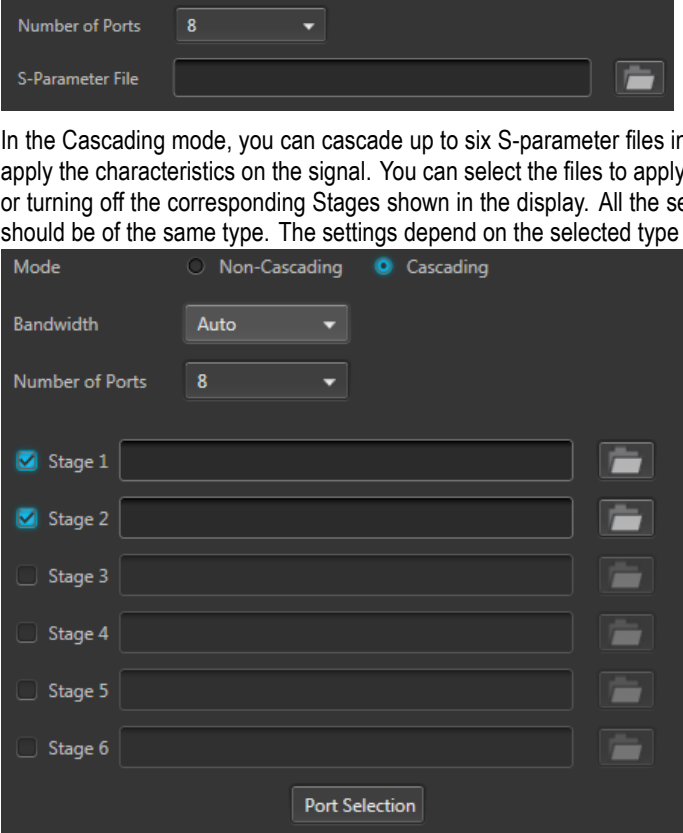
Item	Description
Mode	<p>Select Non-Cascading or Cascading S-parameter mode.</p> <p>In the Non-Cascading mode, you apply S-parameter characteristics on the signal from only one S-parameter file.</p>
	
	<p>In the Cascading mode, you can cascade up to six S-parameter files in Stages and apply the characteristics on the signal. You can select the files to apply by turning on or turning off the corresponding Stages shown in the display. All the selected files should be of the same type. The settings depend on the selected type of file.</p>
	
	<p>The files supported are s1p, s2p, s4p, s6p, s8p, and s12p.</p>
De-embed	<p>Check the box to invert the S-Parameters from the signal. This removes the effects of the component (for which the S-Parameters were created) from the signal path.</p>
(Non-Cascading mode)	
Cascading De-embed	
(Cascading mode)	
Bandwidth	<p>Auto – The bandwidth is defined at the point where the signal rolls off to -60 dB. If this results in a bandwidth greater than the instrument supports, the bandwidth is set to ½ of the waveform’s sample rate (i.e. Nyquist Frequency).</p> <p>Full Bandwidth – The bandwidth is set to ½ of the waveform’s sample rate (i.e. Nyquist Frequency).</p> <p>Manual – The bandwidth can set by the user from 1 Hz to ½ of the maximum sample rate of the instrument. If the set Bandwidth is greater than the Nyquist (Sample rate of the waveform/2), then the software limits the bandwidth to ½ of the waveform’s sample rate. A warning message is provided.</p>

Item	Description
Number of Ports	Choose the number of ports. The port matrixes supported are 1, 2, 4, 6, 8, and 12. The number of ports selected determines: <ul style="list-style-type: none"> <li>• The type of S-Parameter file to apply</li> <li>• The Signalling Scheme choice</li> <li>• The port matrixes available</li> </ul>
S-Parameter File	Navigate to the Touchstone file to apply to the signal. The type of Touchstone files that you are able to open is dependent on the number of ports selected. For instance, only .s4p files can be opened if the Number of Ports is set to 4. The files supported are s1p, s2p, s4p, s6p, s8p, and s12p.
Signalling Scheme (Only for 4, 8, and 12 ports)	Single-Ended: If the data is single-ended, you must map the port numbers as used in the file to physical locations in your link. Differential: If the data is differential, you must select the data layout in the file.
Selection of the port (No port selection for 1 Port environments)	Use the diagrams to map the ports for the transmitter ports (Tx-Port) and the receiver ports (Rx-Port). When choosing the number of Ports, you are presented with an active diagram of the ports. The diagram presented reflects the Number of Ports selected and the Signalling Scheme (if appropriate for the ports selected).
Victim Aggressor and Both (Only for 8 and 12 ports)	Victim: The default setting with no cross-talk effects. Aggressor: Select this to activate aggressor signal parameters, adding the effect of cross-talk.
Port Selection	The Port Selection button is available only when in Cascading mode. Press the Port Selection button to display an active dialog screen to map the ports for the transmitter ports (Tx-Port) and the receiver ports (Rx-Port) for each stage.

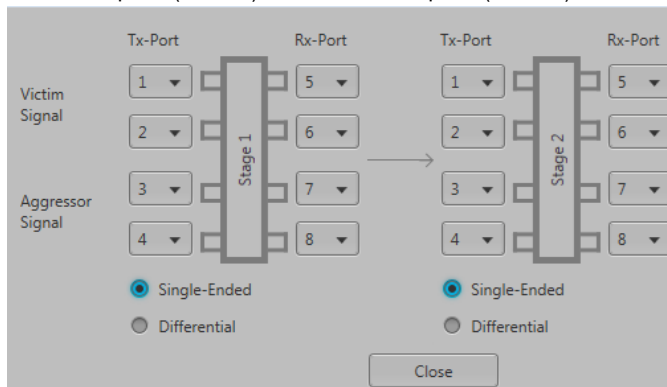

## S-Parameter file descriptions

### 1-port

Files with one port of data contain only one S-parameter file (s1p) so they do not require any further input.

## 2-port

Files with data for two ports contain four S-parameters as a 2x2 matrix. These are Touchstone 2-port files (s2p). A dialog box is created to define the 2-port mapping.

## 4-Port

Files with data for four ports contain 16 S-parameters as a 4x4 matrix. These are Touchstone 4-port files (s4p). They may contain single-ended or differential data. A dialog box is created to define the 4-port mapping for either single-ended or differential data.

- If the data is single-ended, you must map the port numbers as used in the file to physical locations in your link.

You can select the port for both transmitter and receiver from the drop-down list. Each drop-down list has ports from 1 to 2.

- If the data is differential, you must select the data layout in the file.

## 6-port

Files with data for six ports contain 36 S-parameters as a 6x6 matrix. These are Touchstone 6-port files (s6p). A dialog box is created to define the 6-port mapping.

## 8-Port

Files with data for eight ports contain 64 S-parameters as an 8x8 matrix. These are Touchstone 8-port files (s8p). They may contain single-ended or differential data. A dialog box is created to define the 8-port mapping for either single-ended or differential data.

- If the data is single-ended, you must map the port numbers as used in the file to physical locations in your link.

You can select the port for both transmitter and receiver from the drop-down list. Each drop-down list has ports from 1 to 4.

- If the data is differential, you must select the data layout in the file.

## 12-Port

Files with data for 12 ports contain 144 S-parameters as an 12x12 matrix. These are Touchstone 12-port files (s12p). They may contain single-ended or differential data. A dialog box is created to define the 12-port mapping for either single-ended or differential data.

- If the data is single-ended, you must map the port numbers as used in the file to physical locations in your link.

You can select the port for both transmitter and receiver from the drop-down list. Each drop-down list has ports from 1 to 6.

- If the data is differential, you must select the data layout in the file.

## Aggressor signals

8 and 12 port S-parameters allows you to activate aggressor signal parameters and to add the effect of cross-talk. 12 port S-parameters allows 2 Aggressor signal parameters.

Aggressors can be added in either Non-Cascading Mode or Cascading Mode.

The Aggressor signal parameters include:

Item	Description
Signal	Choose the type of aggressor signal with the dropdown list: <ul style="list-style-type: none"> <li>• Clock: Indicates that the aggressor signal is a clock pattern.</li> <li>• PBRs: Also choose the number of bits</li> <li>• File: Indicates that the aggressor signal is another pattern file. Navigate to the Pattern file</li> <li>• Same as victim: The signal flow of the aggressor is same as the victim.</li> </ul>
Data Rate	Specify the data rate (in bps) of the signal. This is not available when the Aggressor signal is set to be the same as the victim.
Aggressor Amplitude	Enter the signal amplitude. This is not available when the Aggressor signal is set to be the same as the victim.
Crosstalk Type	Choose the type of crosstalk of the aggressor signal. <ul style="list-style-type: none"> <li>• Near-End Crosstalk</li> <li>• Far-End Crosstalk</li> <li>• Both</li> </ul>

## Sequence list

The Sequence List contains the available sequences. Sequencing (SEQ) must be licensed.

To add a sequence to the list, see [Adding a sequence \(see page 47\)](#).

To play a sequence track, it needs to be assigned to a channel. Refer to [Assigning tracks to channels](#).

Touch and hold or right-mouse click on a sequence to display a pop-up menu of tools to modify, rename, save, copy, and remove sequences.

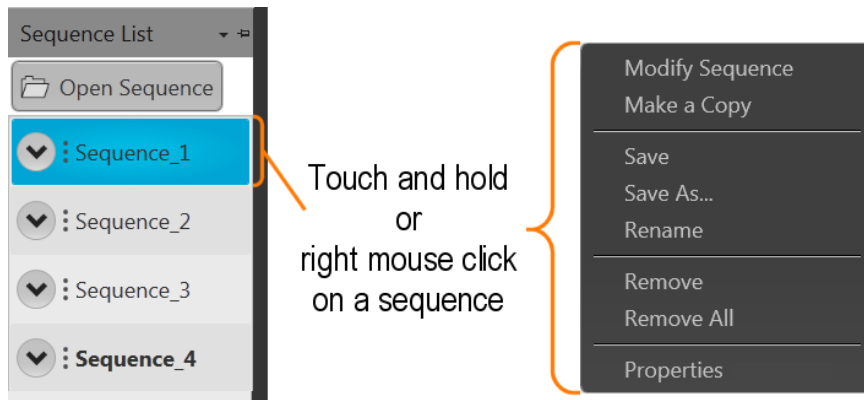



Item	Description
Modify Sequence	Opens the Sequence tab and loads the selected sequence into the sequence editor. Refer to the section <a href="#">Sequence create and edit toolbar (see page 88)</a> .
Make a Copy	Creates a copy of the selected sequence and places the copy in the Sequence List. The copy is renamed by adding a numerical suffix to the end of the original name.
Save	Saves the sequence to the specified location.
Save As ...	Opens a window to save the sequence with a new file name. This only changes the file name, it does not change the sequence name that appears in the Sequence List.
Rename	Changes the sequence name currently displayed in the Sequence List. Use Save or Save As ... to save the sequence with the new name.
Remove	Use remove to remove the selected sequence(s).
Remove All	Remove All removes all sequences from the Sequence List.
Properties	Displays information about the sequence. Refer to the section <a href="#">Sequence properties (see page 52)</a> .

## Adding a sequence

To add a sequence to the Sequence List, select the Open Sequence button. This opens a Windows dialog box that allows you to navigate to a saved sequence or setup file. If the sequence or setup file is a valid file type, the sequences are added to the Sequence List and waveforms (used in the sequence) are added to the Waveform List. Once a sequence is in the Sequence List, a sequence track can be assigned to a channel for payout.

[Assigning tracks to a channel \(see page 49\)](#)

Click here to see a list of valid sequence file types.

Valid sequence file types	Description
.SEQX file format	Sequence file created by Tektronix AWG5200 Series instruments.
.AWGX file format	Setup file created by Tektronix AWG5200 Series instruments. Setup files can contain multiple sequences and multiple waveforms.
	<b>NOTE.</b> Opening a setup file from the Sequence List does not restore the instrument settings, only the sequences contained in the setup file are restored along with any waveforms used in the sequences.

Valid sequence file types	Description
.AWG file format	<p>Setup file created by Tektronix AWG5000 or AWG7000 Series instruments.</p> <p><b>NOTE.</b> The Tektronix AWG5000 or AWG7000 Series instruments had predefined waveforms available for use.</p> <p>Saved setup files that used predefined waveforms did not save the actual waveform data with the setup, only the waveform name. Hence, importing setup files that used predefined waveforms will not import the waveforms. To import these types of waveforms, first copy and rename the predefined waveform, then save the setup file before importing.</p> <p><b>NOTE.</b> The Tektronix AWG5000 or AWG7000 Series instruments supported subsequencing (using another sequence as a step in a sequence). Subsequences are imported as another sequence and added to the Sequences list.</p>
.SEQ file format	<p>Sequence file created by Tektronix AWG400, AWG500, or AWG600 Series instruments.</p>

If selecting a setup type file containing multiple sequences, you are presented with the [Available Sequences](#) dialog box that lists all sequences contained in the setup file. You can load all sequences or select a subset of the sequences. Waveforms that are part of any sequence are added to the Waveform List.

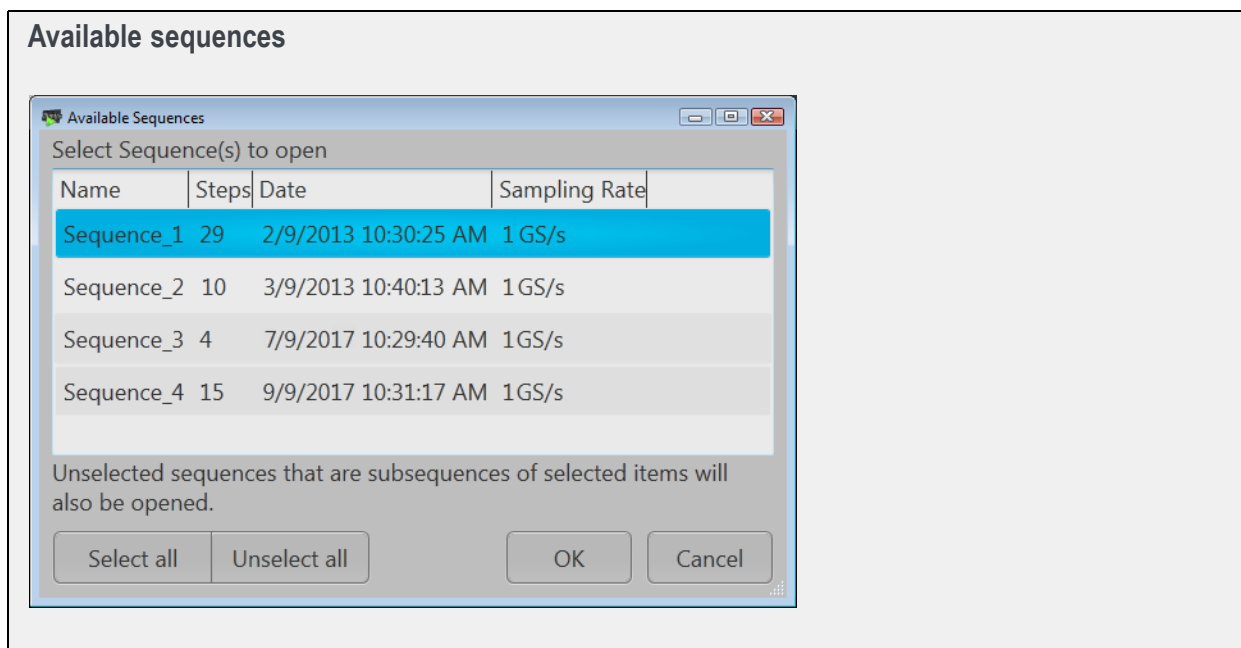

**NOTE.** When opening an AWG5200 Series setup file (.AWGX) from the Waveform or Sequence lists, only waveforms and sequences are extracted; instrument settings contained in the setup file are not restored. Use the Open File in the [Toolbar \(see page 19\)](#) to restore the settings, waveforms, and sequences from a .AWGX setup file.

If you want any of the waveforms or sequences (extracted from a setup file) to be available outside of the setup file, select and save each individual waveform.

### Multi-sequence select

Through the Open Sequence menu in the Sequence List, you can select multiple sequence files to load into the sequence list at once.

To select a contiguous block of files, click the first file in the block. Then hold down the Shift key as you click the last file in the block. This will select not only those two files, but everything in between.

To select multiple files that are not a contiguous block, click one file. Then hold down the Ctrl key while you click each additional desired file.



---

**CAUTION.** *Loading a group of sequences will overwrite any existing sequence of the same name in the Sequence List without warning.*

---



---

**NOTE.** *Multiple sequence selection is not available from the Open File menu in the tool bar or from the pull-down list in the graphical waveform area.*

---

## Saving a sequence

To save a sequence, touch and hold on a sequence (or right mouse click) and select Save or Save As. This opens a Windows dialog box that allows you to navigate to a location to save the sequence.

Click [here](#) to see the list of valid sequence file types.

Valid file types	Description
.SEQX file format	Native sequence file.
.SEQ file format	Sequence file for AWG5000 and AWG7000 series instruments. See <a href="#">Sequence file format (see page 166)</a> for information about the format of this type of sequence file.

## Assigning tracks to a channel

A sequence can consist of up to eight different tracks. (A minimum of one track is required). To play a sequence track, you need to assign a track to a channel.

There are several methods to assign a sequence track to a channel.

- Drag an entire sequence onto any channel's plot area. This always assigns Track 1 to Channel 1. If the sequence has multiple tracks, Track 2 is assigned to Channel 2, and so on until all tracks of the sequence are assigned or all channels have been assigned a track. This is the track assignment regardless of which channel you drag the sequence to.

**NOTE.** Dragging a sequence in the plot area will overwrite an existing waveform or sequence track currently assigned to any channel that the sequence will use.

- Drag a track from a sequence onto a channel’s plot area. This assigns the specific track to a specific channel.
- Touch and hold (or right mouse click) on a sequence track in the Sequence List and use the pop-up window to assign it to a channel.

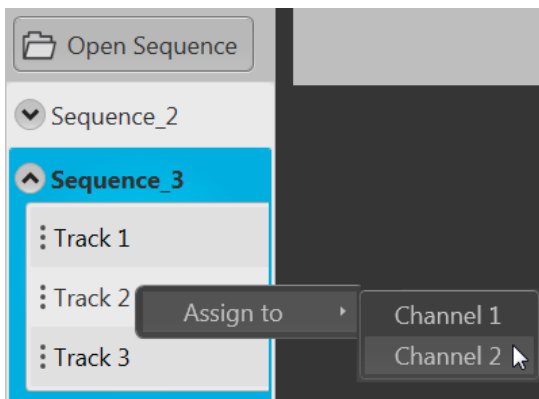

- Use the drop-down list in the channel’s plot area to assign the channel to play a sequence track. You can choose sequence tracks from sequences already loaded into the Sequence List or you can browse for sequence files. When browsing, you select the sequence file, and then select the track to assign to the channel.

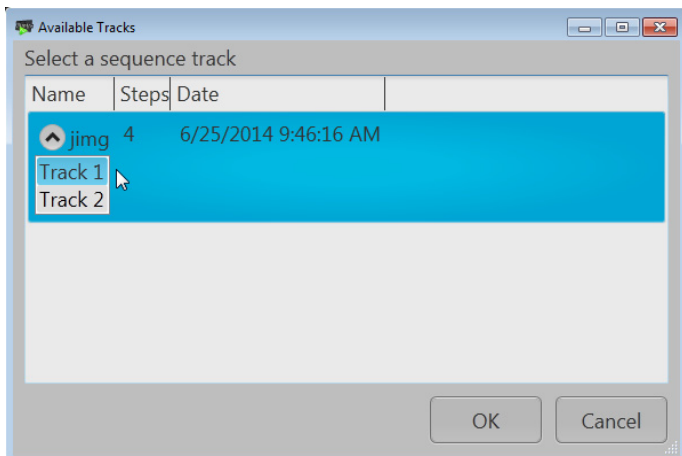

- When assigning tracks from the same sequence to more than one channel, the channels are coupled together. This requires that the waveforms be of equal length for each step of the tracks. In this case, the **Force Jump To...** button actions are coupled together. See [Forcing Jumps \(see page 93\)](#) for more information about the Force Jump To button.
- You can drag and drop (assign) a specific track from different sequences onto the channel’s graph area.

This gives you the freedom to play any track from any sequence. Since the tracks are from different sequences, the channels are not coupled together.

- You can mix playing sequence tracks and waveforms at the same time.

### Assigning tracks containing IQ waveforms

If the Digital Up Converter (DIGUP) is licensed, IQ waveforms can be assigned to a channel for payout. Hence a sequence that contains an IQ waveform can be played.

---

**NOTE.** *Sequence tracks cannot mix IQ waveforms and real waveforms together in the same track.*

---

If the Digital Up Converter (DIGUP) is not licensed, IQ waveforms cannot be assigned to a channel for payout, only their I or Q components can be assigned.

Sequence tracks that contain an IQ waveform provide a drop down menu for you to choose which component of the IQ waveform you want the channel to play. If a track contains multiple IQ waveforms, the I or Q selection applies to all IQ waveforms in the track.

## Edit a sequence

You can select any sequence contained in the Sequence List to modify it or create a new sequence based on the existing sequence. Select any sequence in the list, touch and hold (or right mouse click) to display the sequence operations. Selecting Modify sequence opens the sequence in the Sequence tab window for editing.

---

**NOTE.** *You cannot edit a sequence from the Home tab. See [Sequence tab overview \(see page 86\)](#).*

---

## Sequence properties

You can select any sequence contained in the Sequence List to view its properties.

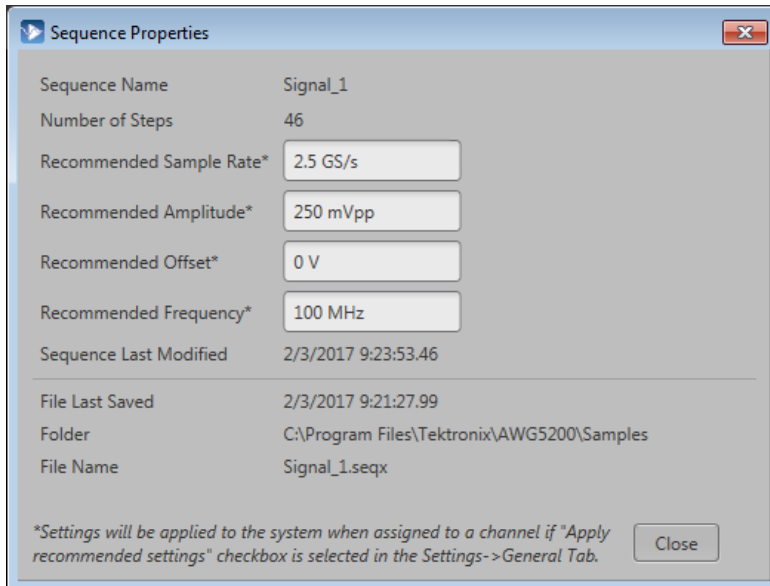

The Sequence Properties dialog screen provides many details about the Sequence that are static (not able to modify).

The items you are able to modify include:

- **Recommended Sample Rate:** This is typically defined by the sequence when it was created. You can change the recommended sample rate as needed.
- **Recommended Amplitude:** This is typically defined by the sequence when it was created. You can change the recommended amplitude as needed.
- **Recommended Offset:** This is typically defined by the sequence when it was created. You can change the recommended offset as needed.
- **Recommended Frequency:** This is typically defined by the sequence when it was created and is only displayed if the sequence contains an IQ waveform. You can change the recommended frequency as needed.

Recommended settings are used when the system is defined to use the sequence settings instead of the system settings during playout. Refer to [General setup \(see page 53\)](#) to enable use of the recommended settings.

## General setup overview

The [General tab](#) under Setup displays the controls to enable or disable certain global actions that are not channel dependent.

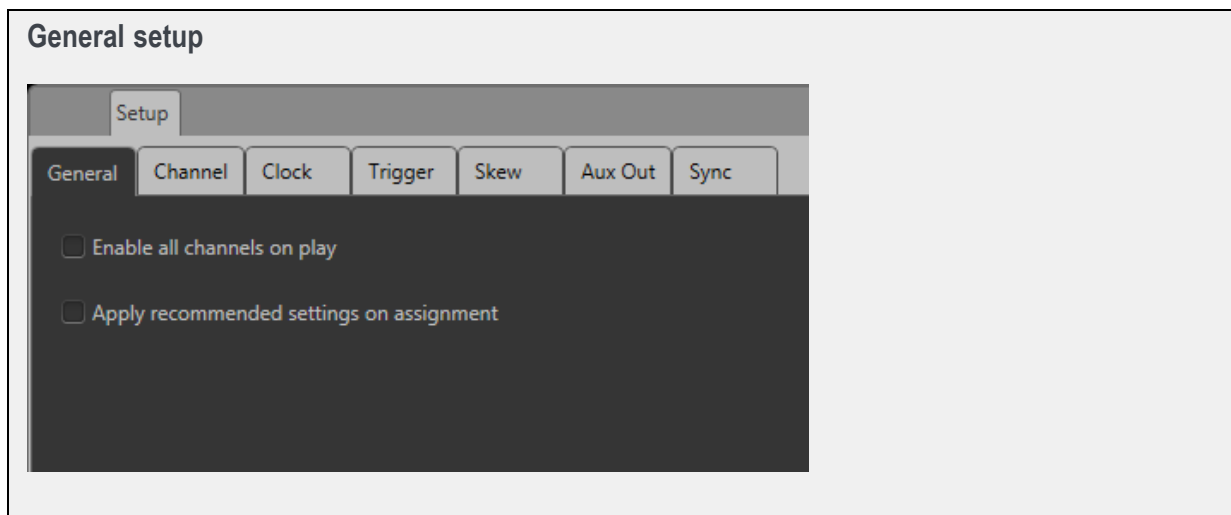

Use the General setup tab to:

- [Enable all channels on play \(see page 53\)](#)
- [Apply recommended settings on assignment \(see page 54\)](#)

## Enable all channels on play

When enabled, all channels (loaded with a valid waveform or valid sequence) are enabled when the playout is initiated either from the user interface or the front-panel Play button. All Outputs Off control is not affected.

Other conditions about this control:

- This control is disabled at the initial (first) startup of the AWG application.
- Restoring the factory default settings does not reset this control.
- Restarting the system does not reset this control.
- This setting is not saved as part of a setup file.

## Apply recommended settings on assignment

When enabled, the system attempts to use the waveform's recommended settings (sample rate, amplitude, and offset) when the waveform is assigned to a channel. This includes waveforms within sequence tracks assigned to a channel.

Other conditions about this control:

- If the waveform is of an IQ type, the recommended frequency is also used.
- If a recommended value is not included with the waveform, the current system value remains unchanged.
- If a recommended value is not supported by the instrument, a warning message is displayed.

## Channel setup introduction

The [Channel tab](#) under Setup displays the controls to adjust and control the channel and marker outputs.

Each channel has the same controls. Use the Channel pull-down list to select the channel you wish to adjust. Except for the Couple Settings control, all settings are independent for each channel, unless the Couple Settings is active. Refer to the [Couple channel settings \(see page 61\)](#) section for information about how coupling works.

From the Channel setup page, you can:

- [Enable/disable the channel output \(see page 55\)](#)
- [Select the Channel output path \(see page 57\)](#)
- [Set the Analog output amplitude \(see page 57\)](#)
- [Set the Resolution \(bits\) \(see page 61\)](#)
- [Set the Marker values \(see page 60\)](#)
- [Change the Channel color \(see page 63\)](#)



- [Set the Output Options \(see page 63\)](#)
  - Output conditions of the Analog and Marker outputs when not actively playing a waveform
- [Set the DAC Options \(see page 65\)](#)
  - Using Interpolation and  $\sin(x)/x$  correction
- [Adjust the I/Q Modulator \(see page 67\)](#)
  - Using Interpolation and center frequency

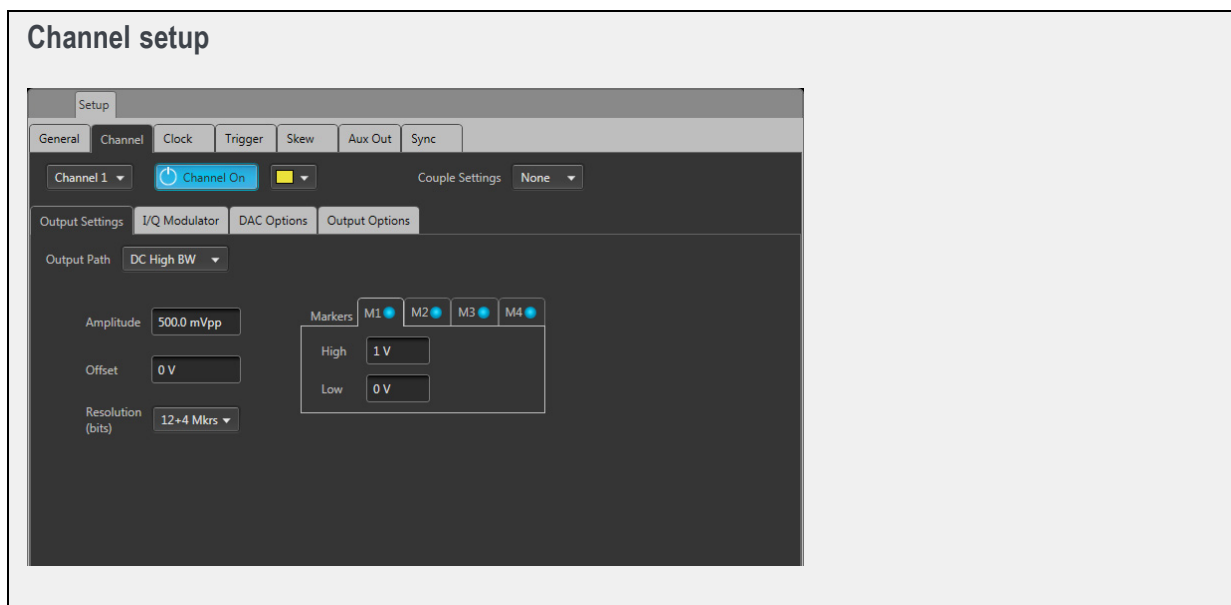

## Enable outputs / relay state

From the Setup → Channel tab, the Channel On/Off button internally connects and disconnects the Analog outputs, Marker outputs, and Aux outputs (using internal relays). When disconnected, the outputs are electrically floating. Use the Channel select pull-down list to choose which channel to control. Refer to [Output options \(see page 63\)](#) for further information about output conditions.

The Channel tab (in Setup) and the Channel button icon displays the status of the channel's output.

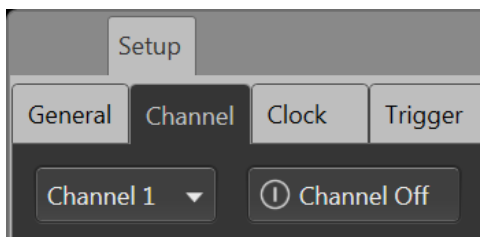

The channel output is not enabled (outputs are electrically disconnected).

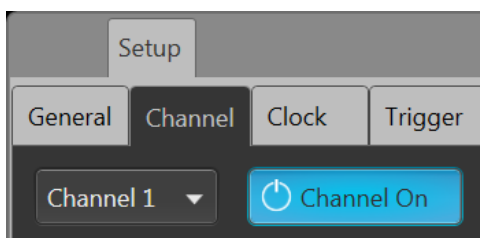

The channel output is enabled (outputs are electrically connected).

In this state, the waveform playout will proceed if there are no errors preventing playout, a trigger is supplied as defined by the Run mode, and the All outputs off is not activated.

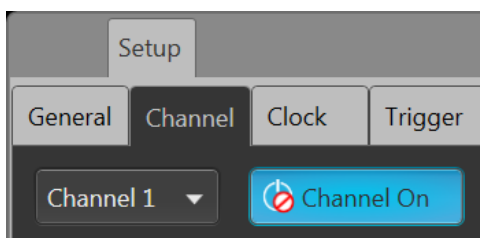

The channel is enabled but the All outputs off is active and the channel, markers, and flag outputs are disconnected.

---

## Channel output path

The channel output path selector determines the signal path when the channel's output is enabled.

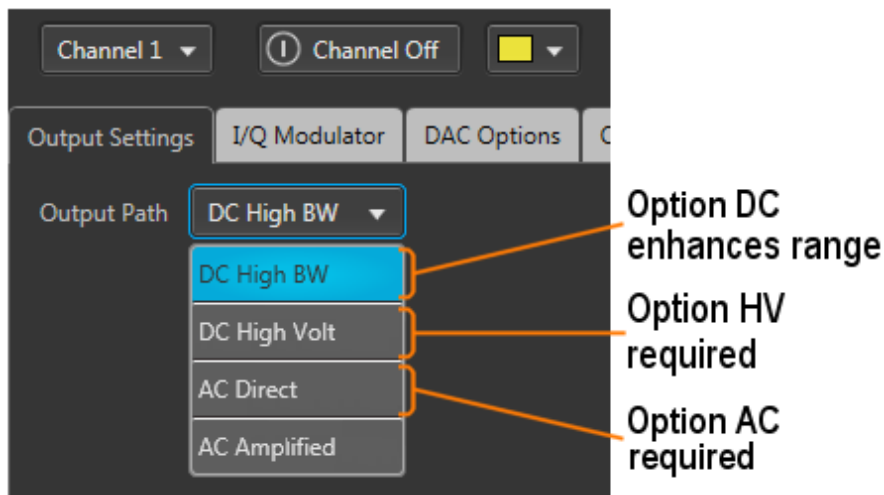

All channel setup controls operate as explained in the [Channel Setup \(see page 54\)](#) section.

- **DC High BW:** Outputs via the analog (+) and (–) differential output connectors, measured in units of volts. This is the default signal path. If Option DC is licensed, a greater amplitude range is available for this output path.
- **DC High Volt (Option HV):** Outputs via the analog (+) and (–) differential output connectors, measured in units of volts. DC High Volt provides greater amplitude range compared to the DC High BW output path.
- **AC Direct:** Outputs via the channel's single-ended AC connector, measured in units of dBm. The AC output uses the (+) connector of the channel's analog pair.
- **AC Amplified (Option AC):** Outputs via the channel's single-ended AC connector, measured in units of dBm. AC Amplified provides additional amplification compared to the AC Direct output path. The AC output uses the (+) connector of the channel's analog pair.

Refer to [Amplitude \(see page 57\)](#) for information about the ranges of these settings.

## Amplitude

The amplitude sets the analog output level of the differential (+) to (–) outputs. The selected output mode determines the available range and bandwidth. The amplitude can be set in volts or dB.

The level shown on the Channel Setup tab is the same amplitude shown on the Home tab.

### DC High BW output path

The output amplitude is adjustable from 25 mV<sub>p-p</sub> to 750 mV<sub>p-p</sub> for single-ended output. The differential output (+) to (-) is 50 mV<sub>p-p</sub> to 1.5 V<sub>p-p</sub>. The offset range is -2 V to 2 V.

If option DC is licensed, the upper limit of the output is increased to 1.5 V<sub>p-p</sub> for single-ended output and 3 V<sub>p-p</sub> for differential output.

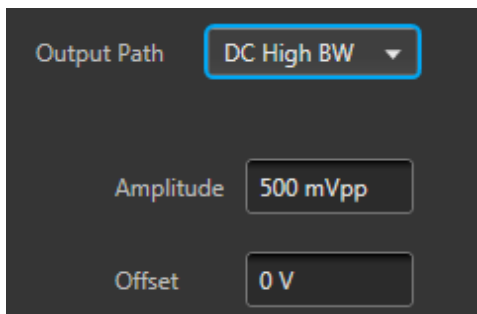

The level can be set independently for each channel, unless the Couple settings has been selected. See [Couple channel settings \(see page 61\)](#).

### DC High Volt output path

The HV option must be licensed to enable this output path.

The output amplitude is adjustable from 10 mV<sub>p-p</sub> to 5 V<sub>p-p</sub> for single-ended output. The differential output (+) to (-) is 20 mV<sub>p-p</sub> to 10 V<sub>p-p</sub>. The offset range is -2 V to 2 V.

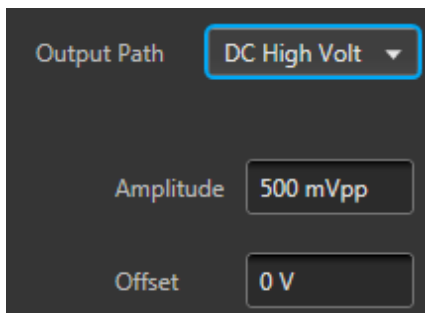

The level can be set independently for each channel, unless the Couple settings has been selected. See [Couple channel settings](#).

### AC Direct output path

AC Direct uses the single-ended AC output connector (+) of the channel.

The output is scaled in dBm with a range from -17 dBm to -5 dBm.

You can add a DC Bias to the output. Once a value is entered, you can enable and disable the DC Bias without re-entering a value. The range is  $-5\text{ V}$  to  $5\text{ V}$ .

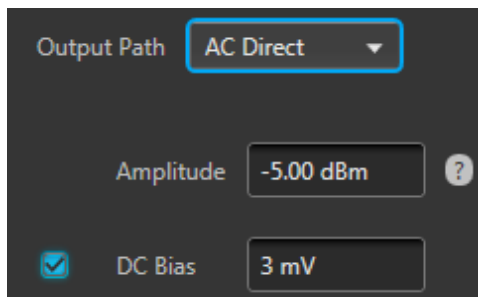

The amplitude output is calibrated with a 100 MHz sinewave. When playing waveforms at other frequencies, the output amplitude may need to be adjusted to achieve the desired level.

### AC Amplified output path

The AC Amplified output path requires Option AC.

AC Amplified uses the single-ended AC output connector (+) of the channel.

When set to AC Amplified, the output is scaled in dBm but has a higher amplitude output compared to the AC Direct output path.

The typical adjustable range is from  $-85\text{ dBm}$  to  $+10\text{ dBm}$ .

You can add a DC Bias to the output. Once a value is entered, you can enable and disable the DC Bias without re-entering a value. The range is  $-5\text{ V}$  to  $5\text{ V}$ .

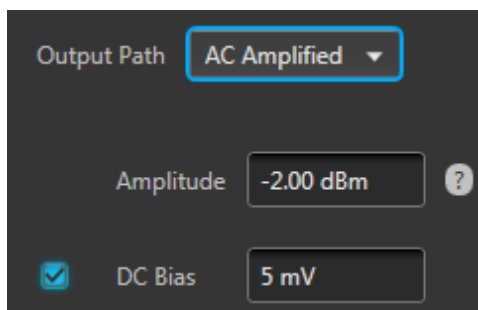

The amplitude output is calibrated with a 100 MHz sinewave. When playing waveforms at other frequencies, the output amplitude needs to be adjusted to achieve the desired level.

## Markers

Each analog output channel is capable of providing up to four markers.

To enable the markers, the bit resolution for the channel must be set to include markers. Each marker uses one bit (out of the possible 16). See [Resolution bits \(see page 61\)](#).

The voltage settings of the High and Low levels range between  $-500$  mV and  $+1.75$  V.

The High and Low settings are inter-dependent, requiring a minimum of  $200$  mV separation or a maximum of  $1.75$  V separation between the settings. Adjusting either value forces a change to the other value, if necessary, to maintain the minimum separation.

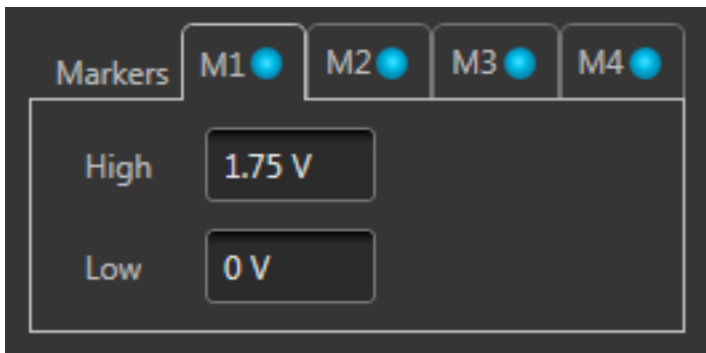

### Marker logic state timing

Marker outputs can change logic states on any sample point in the waveform. But once the logic state changes, it must remain in that state long enough to satisfy the minimum pulse width requirement of  $400$  ps.

## Resolution (bits)

The bit resolution selection tells the instrument how your waveform was created, either with or without markers, and sets the channel accordingly.

**NOTE.** *It's important to know if the waveform you intend to assign to a channel is intended to use markers.*

- Selecting 16+0 Mkr indicates that your waveform is using the entire 16 bits for the waveform.
- Selecting 15+1 Mkr indicates that your waveform is using 15 bits for the waveform and the least significant bits for a single marker.
- Selecting 14+2 Mkrs indicates that your waveform is using 14 bits for the waveform and the two least significant bits for markers.
- Selecting 13+3 Mkrs indicates that your waveform is using 13 bits for the waveform and the three least significant bits for markers.
- Selecting 12+4 Mkrs indicates that your waveform is using 12 bits for the waveform and the four least significant bits for markers.

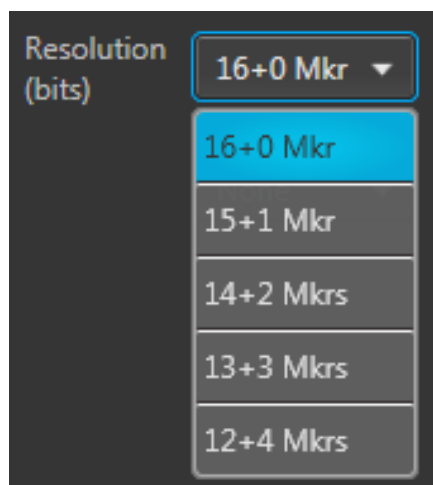

The resolution is selectable for each channel.

## Couple channel settings

To ease the setup of multiple channels, you have the ability to couple the settings of the channels together, allowing you to change channel settings simultaneously.

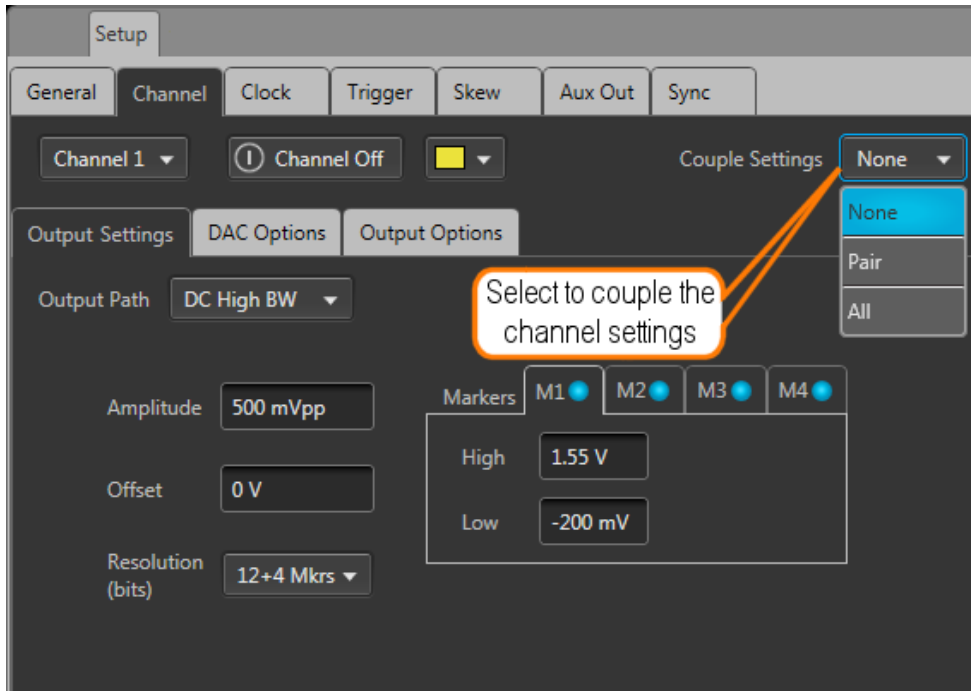

Coupling	Description
None	No channel coupling.
ALL	When the Couple settings is set to ALL, the Channel 1 settings initially overwrite the settings of all other channels. Once coupled, you can use any channel to make changes, but the changes to linked settings always affects both channels.
PAIR	When the Couple settings is set to PAIR, the initial settings are derived from the odd numbered channel of each pair. (For example, CH1 to CH2, CH3 to CH4, etc. for all available channels.) Once coupled, you can use either channel of a pair to make changes, but the changes to linked settings always affects both channels in the pair. <b>NOTE.</b> With a two-channel instrument, selecting PAIR performs the same type of coupling as selecting ALL.

The following channel settings are coupled together:

- Output path
- Channel amplitude
- Resolution (bits)
- Marker High and Low values
- Stop state
- Wait state



---

**NOTE.** The channel coupling does not affect the Run Mode coupling. The Run Mode coupling is set from the Home tab.

---

## Channel color

Use the channel color selection to change the screen color used to display the channel's plot display area on the home tab.

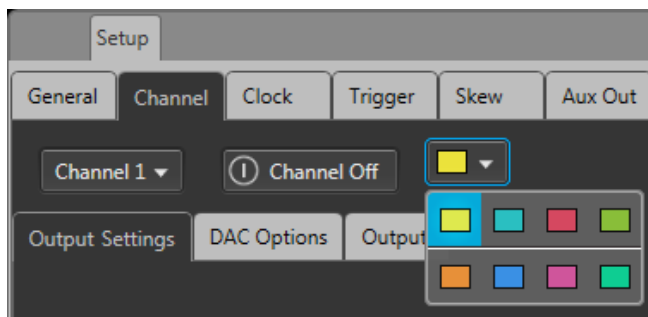

The color is used in the following displays and lights

- Waveform plots (on Home tab)
- Marker plots (on Home tab)
- Front-panel LED for the channel analog output. (The channel LEDs light when the channel is enabled for output.)

## Output Options

The Output Options tab is accessed from the Channel screen of the Setup tab.

The settings allow you to define the state of the outputs when the channel is enabled but a waveform is not actively being played out (such as stopped with the play button, waiting for a trigger event, or assigning a waveform to a channel).

- When a channel's output is off, its analog outputs and marker outputs are electrically disconnected from the instrument (floating).
- When a channel's output is enabled, the outputs are electrically connected to the instrument, preparing to play out a waveform.

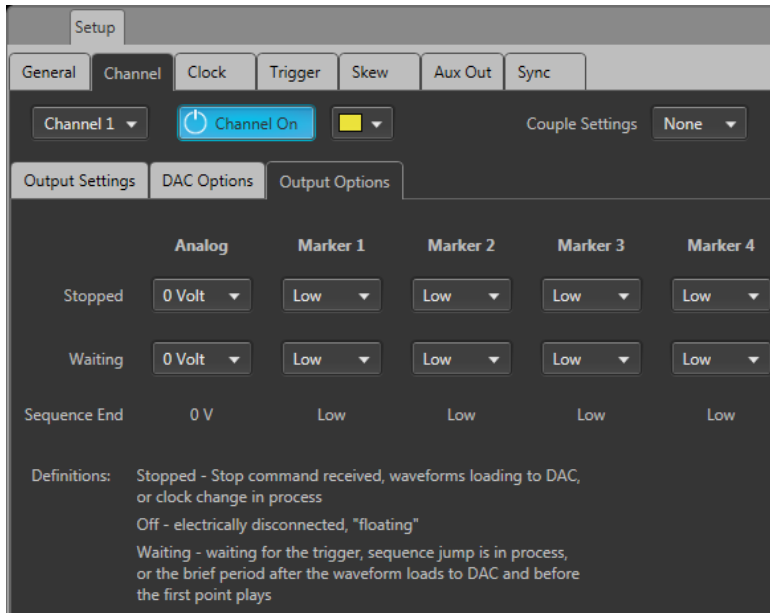

## Output value when stopped or waiting

A channel's analog outputs and marker outputs have various output conditions:

- Playing – The waveform (and markers if active) are being output.
- Stopped – Waveform playout has been stopped. This can be due to pressing the Play button to stop the waveform playout, the waveform is loading, or a clock change is in progress.
- Waiting – The instrument is waiting for a trigger event, or the brief time between when a waveform has finished loading and playout starts.
- Sequence End – This is only displayed if Sequencing is available. These are the channel's Analog and Marker outputs when the end of a sequence is reached. The instrument continues to output the indicated values.

### Analog output settings

Stopped state	0 Volt – Output is set to 0 volts.
	Off – Output is disconnected (floating). There is no electrical connection between the output connector and the instrument.
Waiting state	0 Volt – Output is set to 0 volts.
	First Point – Output is set to the value of the first point of the waveform.
Sequence End state	0 Volt – Output is set to 0 volts.

### Marker outputs settings

Stopped state	Low – Output is set to a logic low.
	Off – Output is disconnected (floating). There is no electrical connection between the output connector and the instrument.

**Marker outputs settings**

Waiting state	Low – Output is set to a logic low.
	High – Output is set to a logic high.
	First Point – Output is set to the value of the first point of the waveform.
Sequence End state	Low – Output is set to a logic low.

The stopped and waiting states are set independently of each other unless you’ve chosen to couple the channel settings.

## DAC Options

The DAC Options tab lets you make adjustments to the signal before reaching the DAC. The DAC settings are independent for each channel. The block diagram included is an active diagram, depicting the signal path as you make changes.

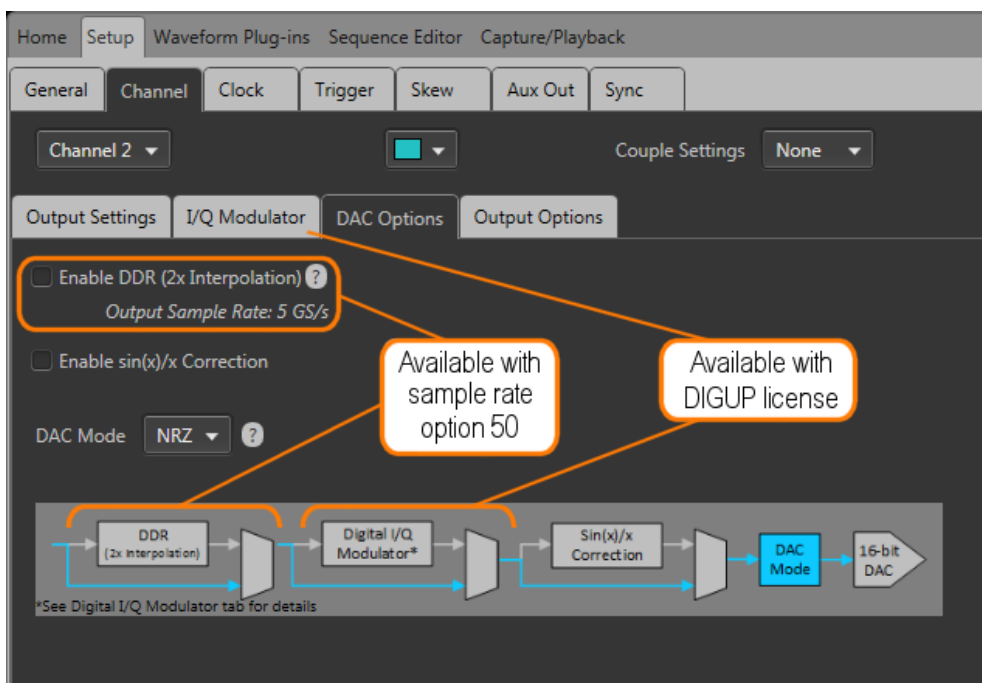

- Enable DDR (2x Interpolation) – Available when option (x)50 (increased sampling rate) is installed. DDR (Double Data Rate) doubles the output sampling rate for the channel by using interpolation filters. This also doubles the Nyquist band, moving the image further away from the fundamental frequency. The plot below shows an example of the amplitude versus frequency response with a clock frequency of 5 GHz. As the clock frequency changes, the plot response scales with the frequency.

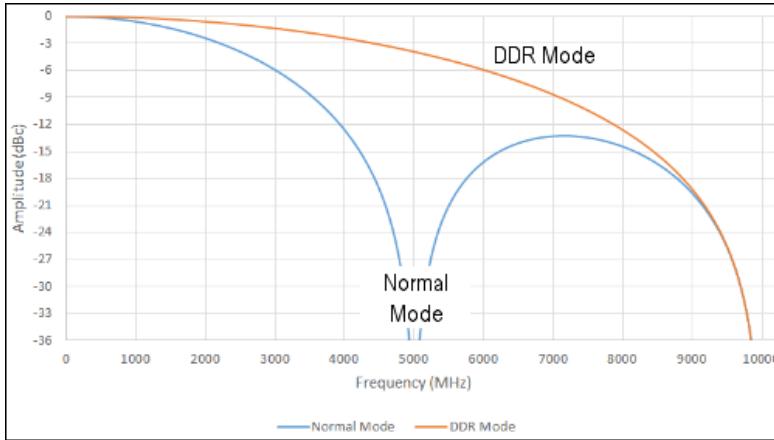

The following illustration shows how the Nyquist images move when DDR is enabled.

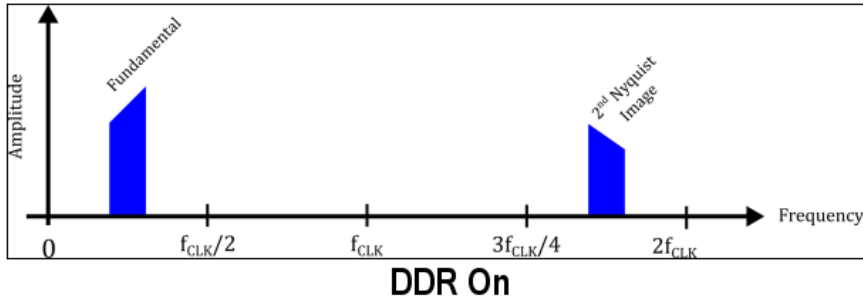
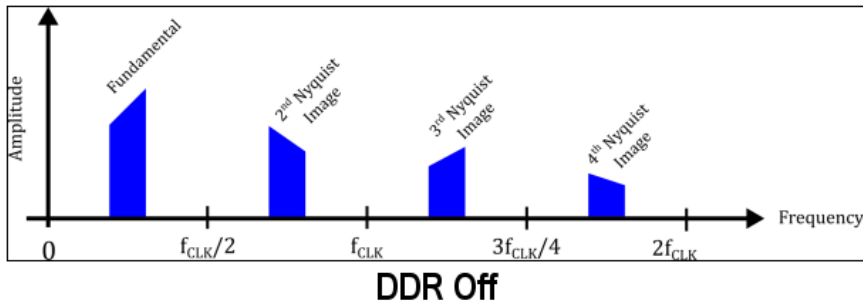

DDR is disabled when the DAC mode is set to Mix or RZ. When DDR is enable, the only DAC mode available is NRZ.

DDR can be enabled from this screen or the I/Q Modulator screen if the Digital Up Conversion (DIGUP) is licensed for use on the generator.

- Enable  $\sin(x)/x$  Correction – Add the  $\text{Sin}(x)/x$  filter to the signal path to create a flat output response from the DAC.
- DAC Mode – Select the operation mode of the DAC. The modes provides the ability to place a carrier anywhere in the first three Nyquist zones. See the plot below for characteristics of each mode.
  - NRZ: Normal operating mode.
  - RZ: The rising edge clocks data and the falling edge clocks zero.
  - Mix: The falling edge sample is the complement of the rising edge sample value. (Not available when DDR is enabled.)

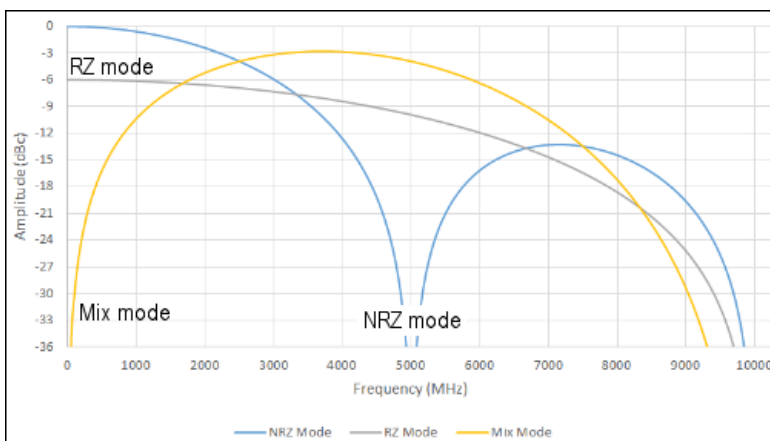

## I/Q Modulator

The I/Q Modulator tab is available if the Digital Up Conversion (DIGUP) is licensed for use on the generator.

The modulator is automatically activated when an IQ waveform is assigned to the channel. The modulator is bypassed when a real waveform is assigned to the channel.

When the Digital Up Converter (DIGUP) is licensed, IQ sample pairs are fed to the IQ modulator and the result is sent to the DAC. The I/Q Modulator tab lets you make adjustments to the signal before reaching the DAC. The DAC settings are independent for each channel. The block diagram included is an active diagram, depicting the signal path as you make changes.

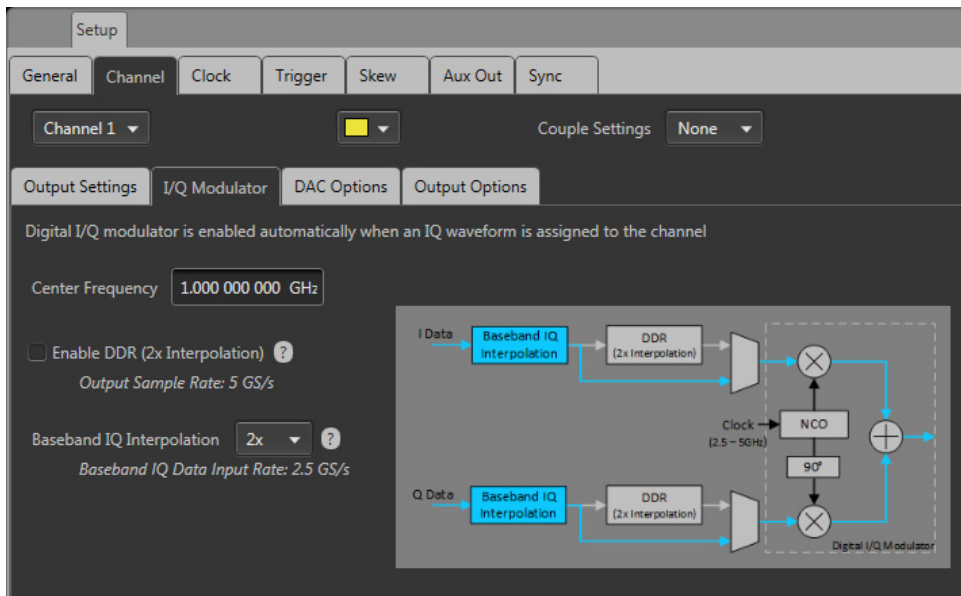

---

**NOTE.** If you select a channel with no waveform assigned, the I/Q Modulator tab is active, allowing you to enable DDR and set the IQ Interpolation. These settings will be in effect if an IQ waveform is assigned to the channel. The center frequency can not be set until an IQ waveform is assigned.

---

- Center Frequency – The center frequency of the IQ waveform can be adjust from 1 Hz to 1/2 the output sample rate. The available output sample rate is affected by the instrument’s sample rate option (2.5 GS/s or 5 GS/s) and whether or not DDR is enabled.
- Enable DDR (2x Interpolation) – Enabling DDR, doubles the output sample rate for the channel by using interpolation filters. This also doubles the Nyquist band, moving the image further away from the fundamental frequency.

---

**NOTE.** DDR does not double the instrument sampling clock rate. DDR only doubles the output sampling rate.

When an IQ waveform is assigned to any channel, the instrument’s sample rate can not be adjust below 2.5 GS/s.

---

DDR can be enabled from this screen or the DAC Options screen.

- Baseband IQ Interpolation – The IQ Interpolation divides the baseband IQ data input rate. 2x is the default setting, dividing the baseband IQ data input rate to 1/2 the instrument’s sampling rate. You can choose to further divide this by factors of 2x or 4x.

Generating IQ waveforms at lower sampling rates reduces the waveform's size.

## Clock introduction

The [Clock Setup](#) determines the waveform output sample rate and the source used to drive the sample clock signal. The Reference In signal input is provided to help you synchronize the AWG to your system using your own reference signal, and the Reference Out signal performs a similar function by making the AWG's internal frequency source available to other equipment.

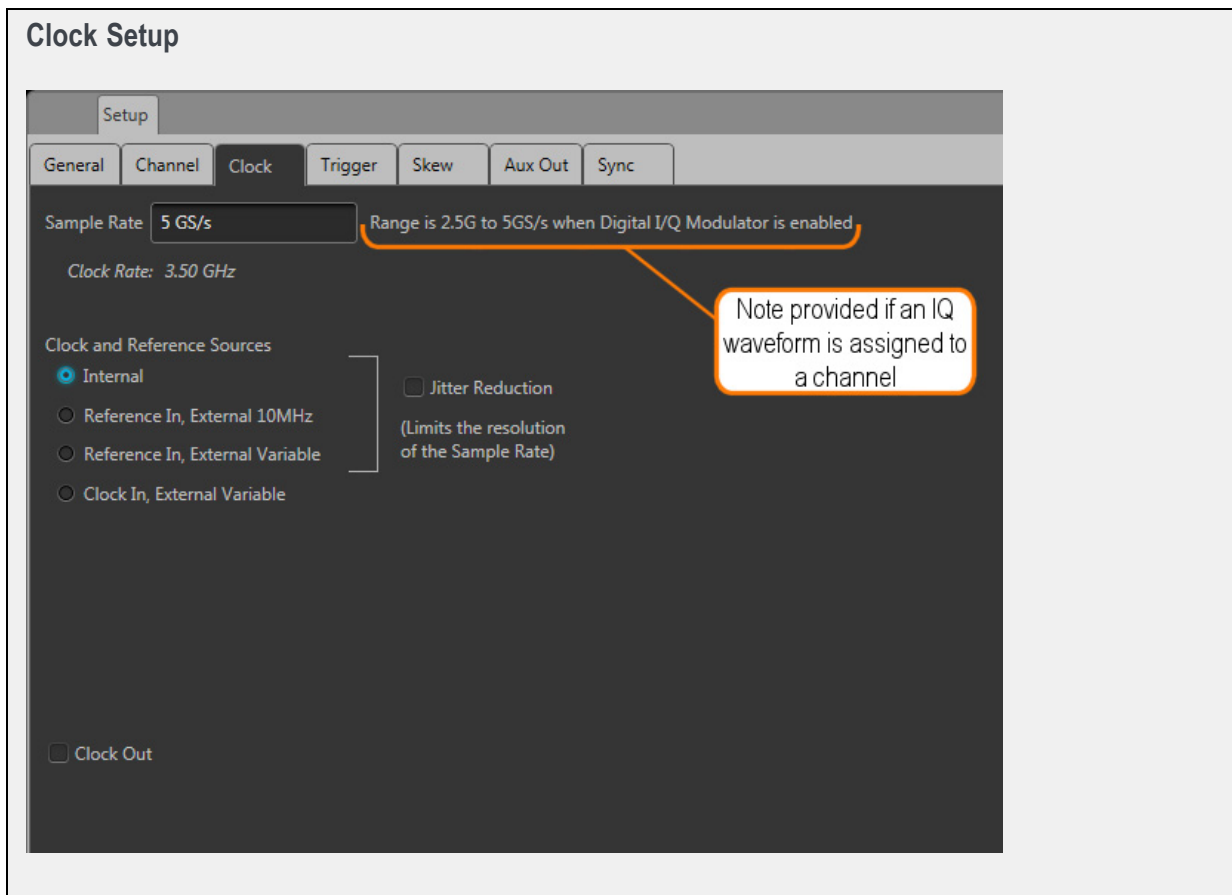

## Sample Rate

The Sample Rate box allows you to set your desired sampling rate. When setting Clock and Reference Source to Internal or Reference In, External 10 MHz, the instrument automatically creates the sampling rate (based on a 10 MHz reference signal). When the reference source is set to use an external variable signal, you can still enter a sampling rate, but its value must be a multiple of the reference signal.

Below the Sample Rate box, the actual clock rate is given.

See [Clock and Reference Sources \(see page 70\)](#) for more detailed information about sampling rates and reference signals.

## Clock and Reference Sources

The Clock and Reference Sources controls let you choose what signal source you want to use as a frequency reference for the clock signal. The following table describes each of the settings and how the clock signals are derived.

You can refer to the simplified block diagram to help understand how the choices affect the signal paths.

Internal	For general use, this method is usually adequate. The clock is derived from the instrument's internal 10 MHz oscillator as the reference signal. The reference is automatically multiplied or divided, based on the selected Sample Rate.
Reference in, External 10MHz	Use this selection if you want to use your own 10 MHz system frequency as a reference. The clock is derived from the 10 MHz signal applied to the Reference In connector. The reference is automatically multiplied or divided, based on the selected Sample Rate.
Reference In, External Variable	Use this selection if you want to use your own system frequency as a reference. This reference frequency must be between 35 MHz and 250 MHz. The clock is then derived from the signal applied to the Reference In connector. When this selection is chosen, use the External Reference Details controls to set or calculate the Sample Rate based on the reference in frequency.

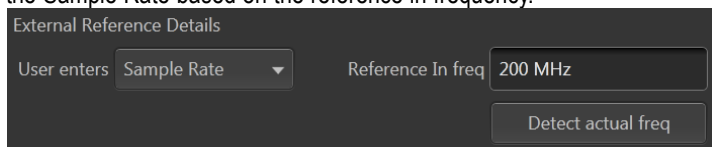

The first item to enter is the Reference In frequency. You can enter the value manually or use the **Detect actual freq** button to measure the frequency of the applied signal.

After you have the frequency value, you can set the Sample Rate or calculate the Sample Rate.

With the **User enters** pull-down list, you have three choices:

- **Sample Rate:** you enter the Sample Rate directly and the Reference In signal is multiplied or divided as needed to obtain the desired Sample Rate.
- **Multiplier:** Enter a value to multiply the Reference In signal, calculating the Sample Rate.
- **Divider:** Enter a value to divide the Reference In signal, calculating the Sample Rate. If an IQ waveform is assigned to a channel, Divider is not available.



Clock In, External Variable

Use this selection if you want to provide your own system clock signal applied to the Clock In connector. The clock signal must be between 2.5 GHz and 5 GHz.

When this selection is chosen, use the External Clock Details controls to set or calculate the Sample Rate based on the clock in frequency.

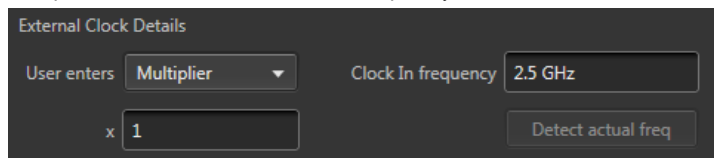

The first item to enter is the **Clock In frequency**. You can enter the value manually or use the **Detect actual freq** button to measure the frequency of the applied signal.

After you have the frequency value, you can set the Sample Rate or calculate the Sample Rate.

With the **User enters** pull-down list, you have two choices:

- Multiplier: Enter a value to multiply the Clock In signal, calculating the Sample Rate.
- Divider: Enter a value to divide the Clock In signal, calculating the Sample Rate. If an IQ waveform is assigned to a channel, Divider is not available.

Jitter Reduction

Jitter Reduction limits the resolution setting of the Sample Rate when using the internal clock or an external reference.

Clock Out

Click to enable the Clock Out signal. The Clock Out signal is based on the Sample Rate and helps you synchronize the AWG to your system or DUT, or to synchronize multiple AWGs.

When enabled, the actual clock frequency is reported.

Clock Out is not available when the clock source is set to Clock In, External Variable.

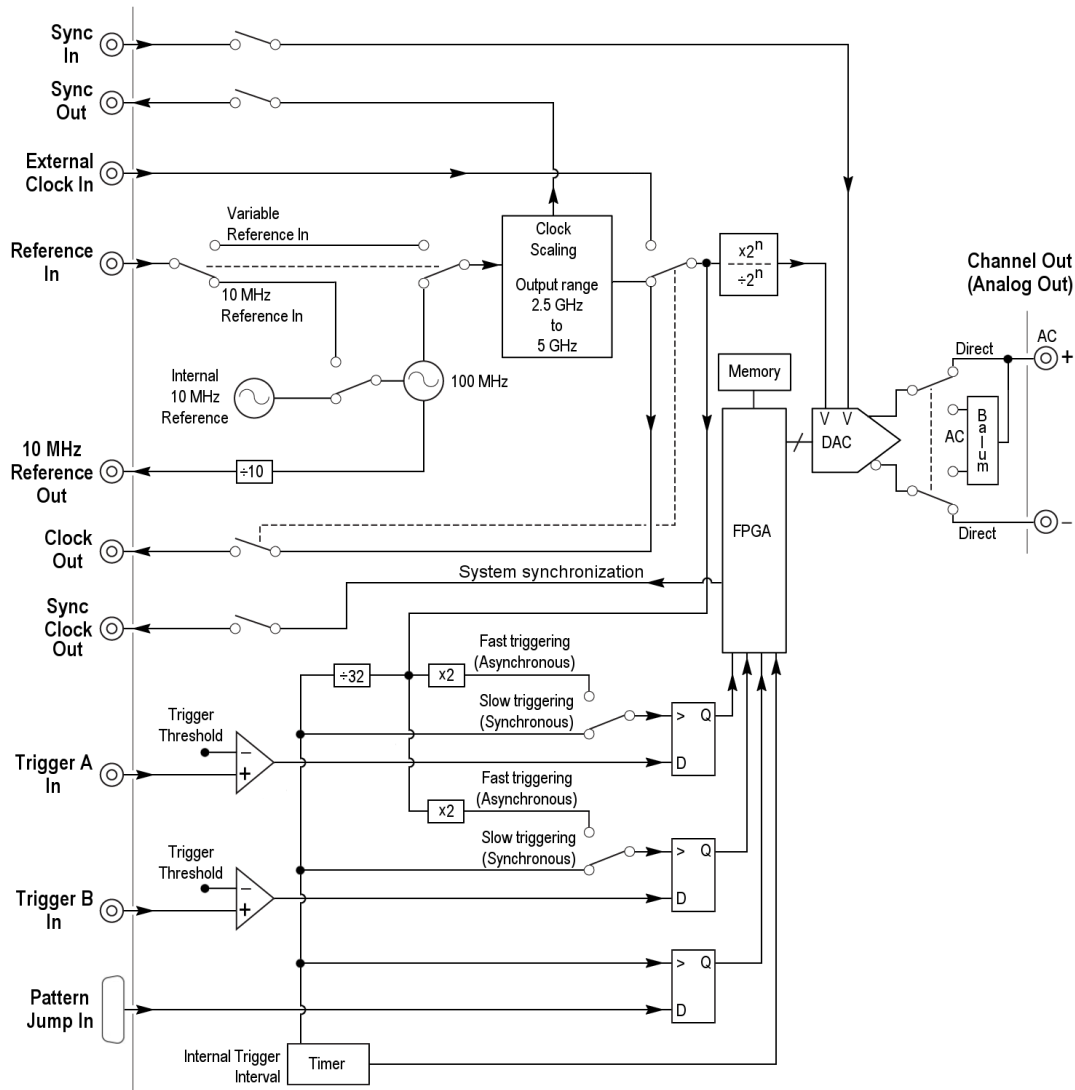

Clock and Trigger block diagram

## Clock output

The Clock Out signal is provided to help you synchronize the AWG to your system or DUT, or to synchronize multiple AWGs. Click the box to enable the output.

The Clock Out frequency is a ratio based on the Sample Rate setting. The Clock Out readout (in the clock settings panel) provides the actual clock out frequency. (The frequency value is shown only when Clock out is enabled.)

---

**NOTE.** *The Clock Out frequency will free-run if using an external variable reference and the instrument loses lock with the signal. Lock can be lost if there is no valid signal applied to the reference input or the actual signal frequency is different than the value entered in the **Reference In freq** dialog box.*

---

## Trigger control

Triggers control when a waveform starts to output, after the Play button has been pressed. A trigger event is necessary when the instrument's Run Mode is set to a triggered condition.

Trigger control ([Run mode \(see page 73\)](#), [Trigger Source \(see page 74\)](#), [Trigger coupling \(see page 75\)](#)) is accessed from the AWG Home tab and is unique for each channel unless the Run modes have been coupled together.

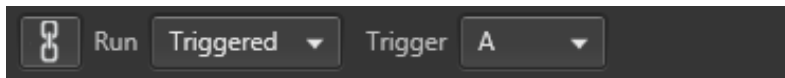

### Run mode

Triggers ([Run mode](#)) control when a waveform is output after the Play button is pressed. Each channel can use independent Run modes and trigger events.

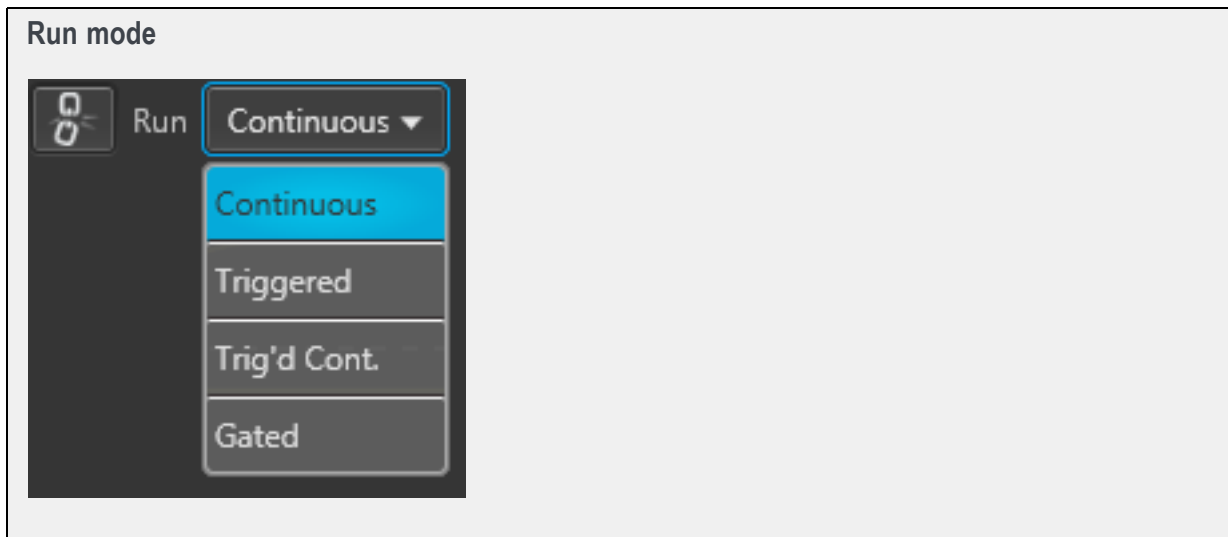

Run mode (accessed from the AWG Home tab) has four selections:

- **Continuous:** Waveform play out starts when the Play button is pressed, without the need for a trigger event. The waveform continues to repeat until stopped by the user.
- **Triggered:** Waveform play out starts when the trigger event occurs. Waveform playout stops after one complete waveform cycle and remains stopped until the next trigger event. Using a triggered run mode requires that you select the trigger source. See [Trigger source \(see page 74\)](#).

Waveform playout cannot be retriggered until the current waveform playout completes an entire cycle on all channels.

- **Trig'd Cont.:** Waveform playout starts when a trigger event occurs. Once a trigger event occurs, waveform plays continuously until stopped by the user. (Retriggering is not required nor has any effect.) Using a triggered run mode requires that you select the trigger source. See [Trigger source \(see page 74\)](#).
- **Gated:** Waveform playout starts when a trigger event occurs. The waveform continues to play while the trigger is enabled. Using a triggered run mode requires that you select the trigger source. See [Trigger source \(see page 74\)](#).

### Trigger source

The [trigger source](#) selection only appears when the Run mode is set to a triggered mode (Triggered or Trig'd Cont.).

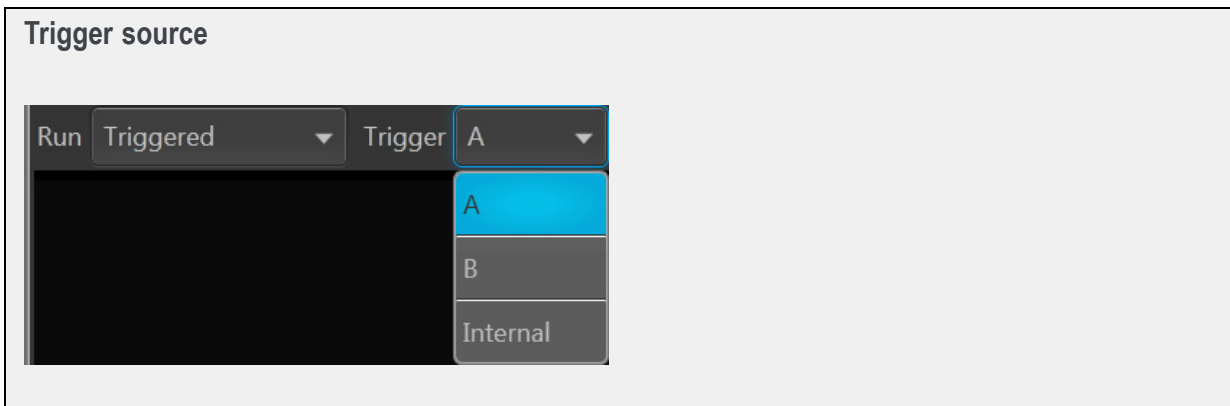

The trigger sources available include:

- **A:** The A External Trigger input (rear-panel Trigger Inputs) is used as the source for a trigger event. The A Force Trigger button is also active.
- **B:** The B External Trigger input (rear-panel Trigger Inputs) is used as the source for a trigger event. The B Force Trigger button is also active.
- **Internal:** An internally generated trigger signal is used as the trigger source. (The A and B Force Trigger buttons are not active.)

Internal trigger source is not available when the Run mode is set to Gated.

When using a trigger event to start the waveform ployout, you need to define the trigger parameters. Use the Trigger setup window (located in the Setup tab). See [Trigger input settings \(see page 76\)](#).

---

**NOTE.** Each channel can use an independent trigger source or use the same trigger source for all channels by coupling the triggers together.

---

### Trigger coupling

You have the ability to couple the Run mode and Trigger source together, allowing you to change triggering mode settings to all channels simultaneously.

When triggering is initially linked, the Channel 1 settings overwrite all other channels. But once coupled, you can use any channel to make changes.

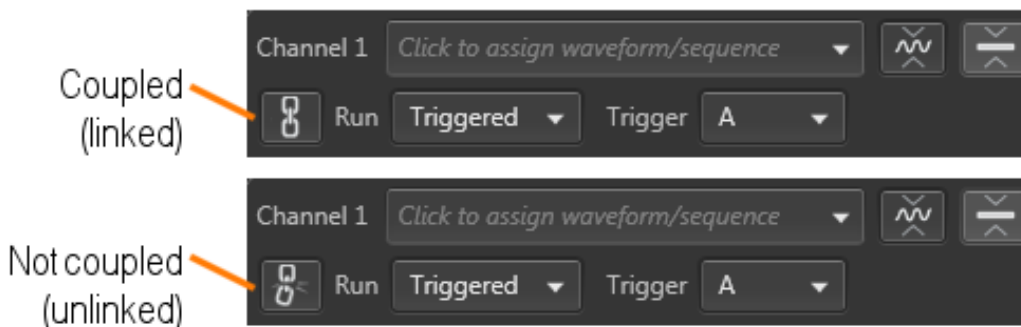

## Trigger input settings

When using a trigger source (Internal or External), you need to define the signal requirements to cause a trigger event.

Use the [Trigger setup screen](#) (located in AWG Setup tab).

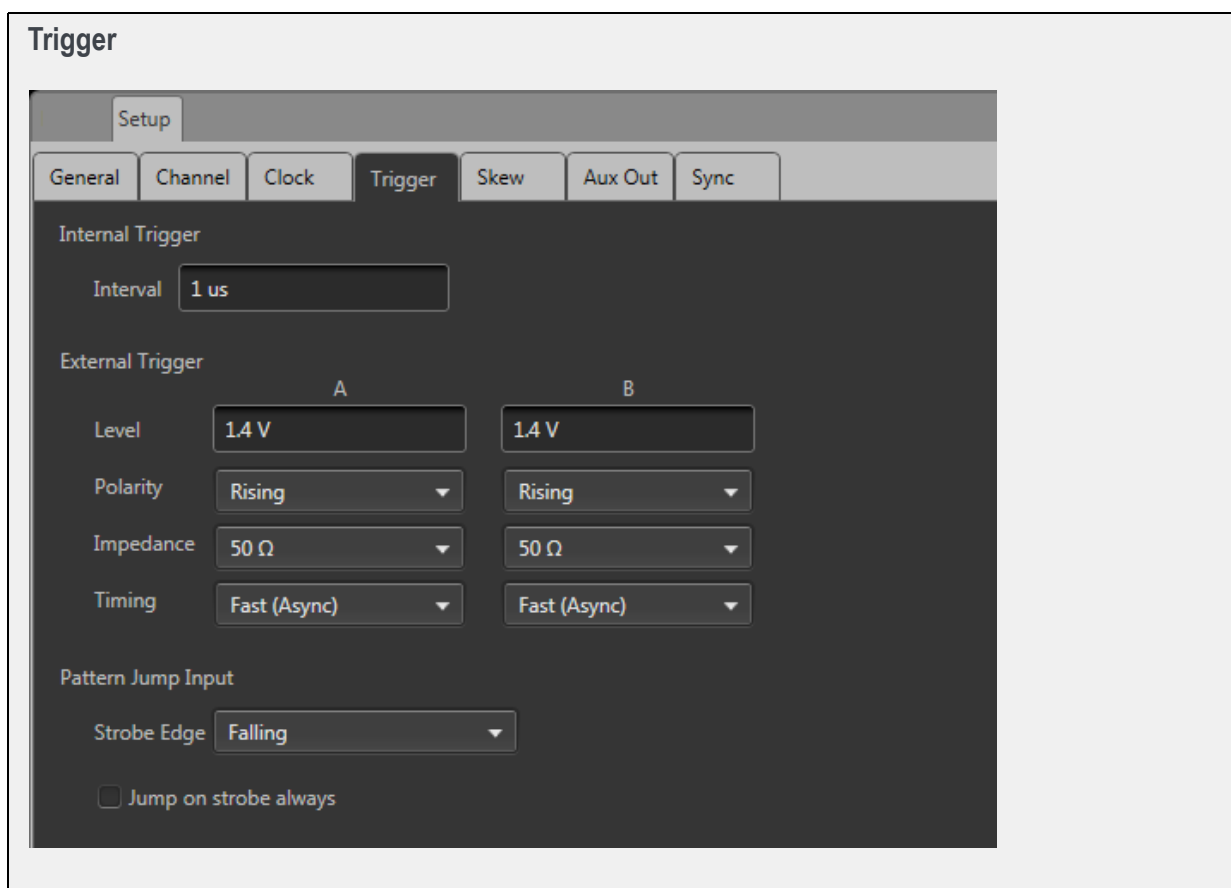

### Internal Trigger

When the trigger selection is set to Internal (AWG Home screen), the trigger event is generated from the instrument's internal clock.

The only setting for the internal trigger is the interval (1  $\mu$ s to 10 s) at which the trigger signal is generated.

### External Trigger

The instrument has two external trigger inputs, A and B. Use the Trigger screen to define the trigger conditions of each input.

Two channel instruments can use independent trigger sources for each channel.

Item	Description
Level	Trigger Level sets the threshold that the external trigger input signal must cross for a trigger event to occur. Select values from -5 V to 5 V.
Polarity	<a href="#">Trigger Polarity</a> sets which slope to use (rising or falling edge) of the external trigger input signal for a trigger event to occur.

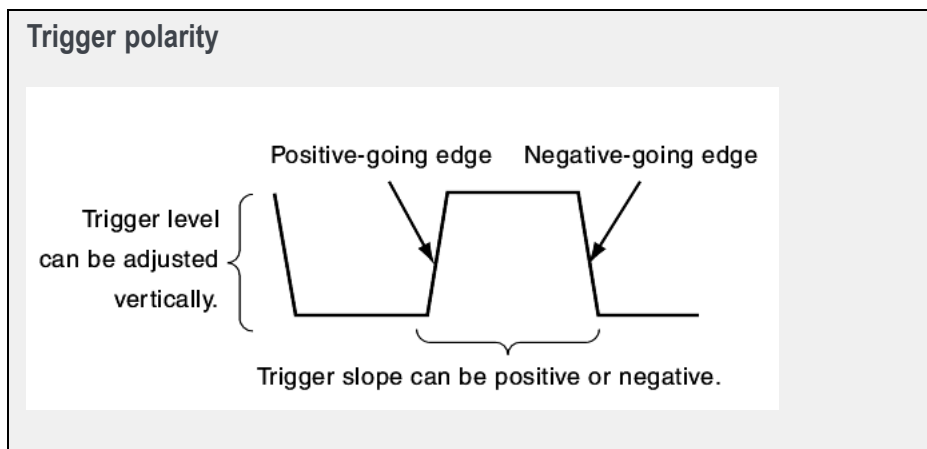

Impedance	Trigger Impedance sets the impedance of the External Trigger inputs to match the impedance of the external source driving the external trigger input signal. See <a href="#">Rear-panel connectors (see page 183)</a> .
Timing	Trigger Timing is the trigger timing speed in relation to the frequency of the sampling clock speed. Trigger timing is selectable between Fast or Slow for when using an external input: <ul style="list-style-type: none"> <li>■ Fast (Asynchronous) triggering provides the smallest delay between the trigger event and starting the waveform payout.</li> <li>■ Slow (Synchronous) triggering slows the trigger clock rate to provide a longer setup time, making it easier to align timing events between equipment.</li> </ul> See <a href="#">Trigger timing (see page 78)</a> for more information about asynchronous and synchronous trigger timing.

### Pattern Jump Input

When using Sequencing, the Pattern Jump Input is available as a trigger source.

Item	Description
Strobe Edge	Sets which slope to use (rising or falling edge) of the pattern jump strobe input signal for a trigger event to occur.
Jump on strobe always	A jump based on a pattern requires two things: a strobe edge and an address change at the Pattern Input connector. With this checked, a jump always occurs on the strobe edge.

See [Creating a Pattern jump \(see page 97\)](#) for more information.

## Trigger timing

The Timing control in the Trigger setup window allows you to select the method most suited to your application.

Fast (Async) is appropriate for situations like these:

- You do not need trigger timing uncertainty better than  $\pm (\text{sample clock period}) / 2$ .
- You are using a single trigger event to start AWG output.
- You want to minimize trigger uncertainty without synchronizing the AWG to your external system or device under test (DUT).

Slow (Sync) is useful if your application is like one of these examples:

- You need to minimize trigger uncertainty and have the ability to synchronize your trigger signal to the AWG clocks using one or more of these signal inputs/outputs: Reference In, Reference Out, Clock Out, or Sync Out.
- You are using a trigger signal from your system to the AWG to achieve tight alignment between the AWG and your external system.
- You are synchronizing multiple AWGs.

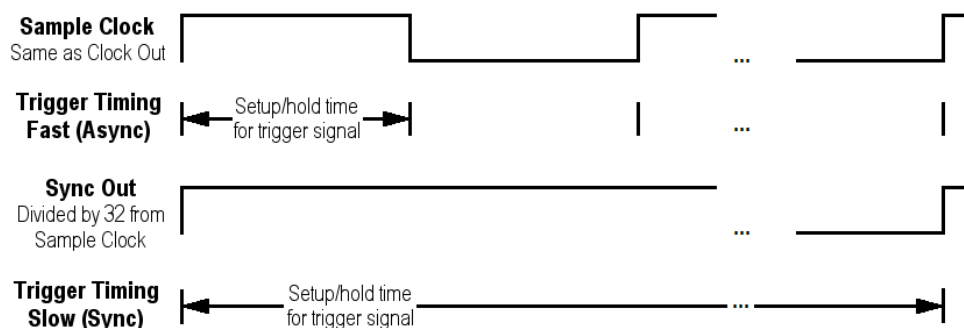

Async and Sync timing diagram



To understand the difference between these choices, you need some background on the AWGs internal clock signals.

- The internal sample clock signal is what causes the DAC to output waveform samples.
- The DAC's output sample rate is generally a multiple of the sample clock or divided down from the sample clock.
- The sample clock is always a value between 2.5 GHz and 5 GHz, while the sample rate can be anywhere from 298 Samples/s to 5 GSamples/s.

The Clock Out signal is the same as the internal sample clock. The Sync Out is another timing signal provided. The Clock Out signal can be used in synchronizing the AWG to your external device or system. The Sync Out signal is used to directly synchronize an AWG5200 series instrument with another AWG5200 series instrument.

The AWG determines when a trigger event has occurred by comparing the trigger input signal's voltage level against the trigger level you have set in the Trigger setup window. This comparison occurs at the rising and falling edges of the Sample Clock signal for Fast trigger timing, and at the rising edge of the Sample Clock signal divided by 32 if Slow trigger timing is selected.

The Sample Clock period for Fast (Async) trigger timing can be as short as 200 ps (for 5 GS/s sample rate). If the trigger signal applied to the AWG misses its setup/hold window by being either too early or too late, it will be recognized in the previous or next cycle, leading to a 400 ps uncertainty for Fast (Async) mode if you do not use one or more of the clock signals to synchronize your trigger events to the AWG sample clock.

Minimum trigger uncertainty is achieved by using a shared clock and/or reference signals to insure that your trigger event arrives at a consistent location within the selected Trigger Timing clock cycle. The Sample Clock period for Slow (Sync) trigger timing is 32 times longer than for the Fast (Async) trigger timing. This extra time makes it easier for your system to assert the trigger event within the setup/hold window.

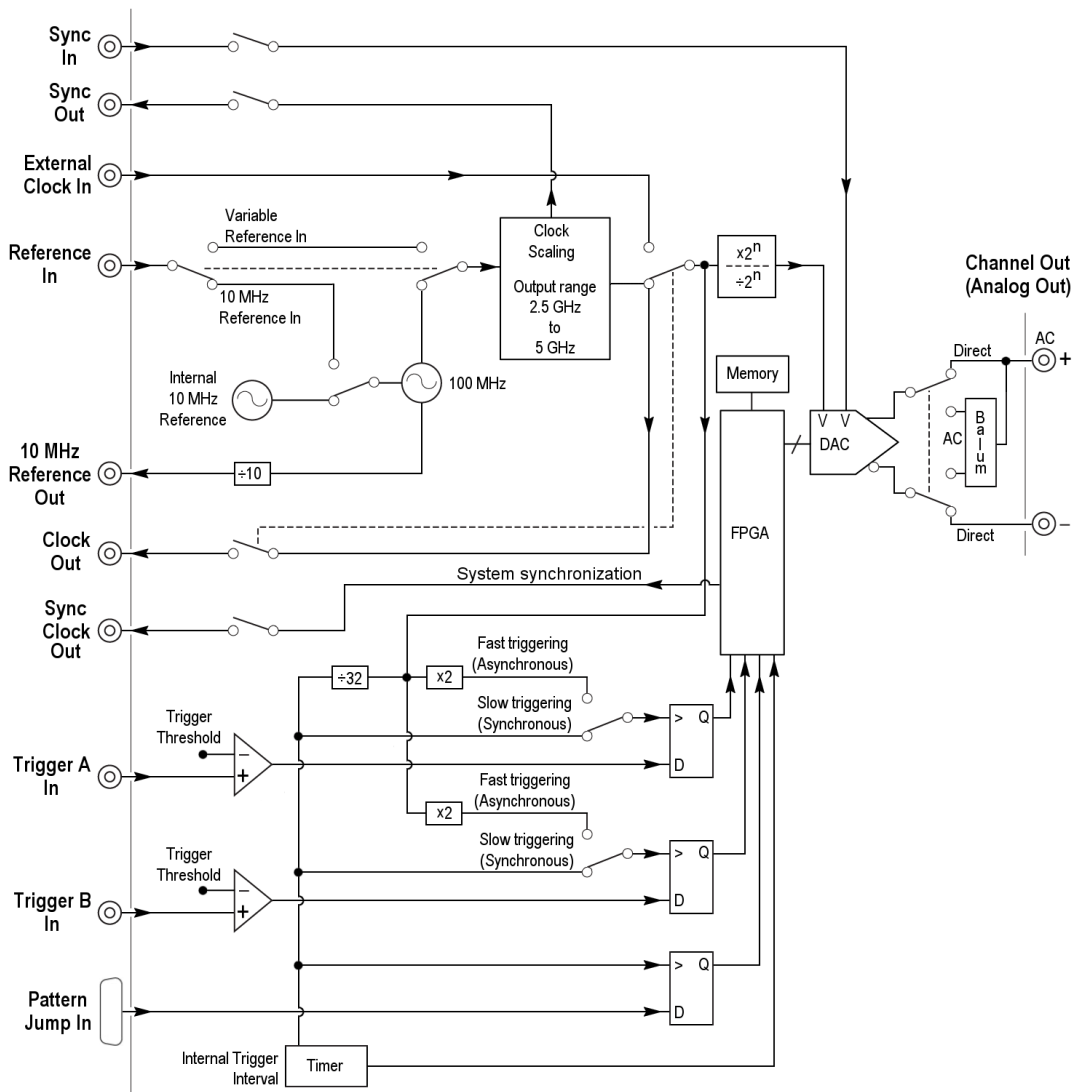

Clock and Trigger block diagram

## Adjust skew

The [Skew adjustments](#) is accessed from the Setup tab.

The Skew and delay adjustments dialog screen is used to:

- Adjust the relative timing (skew) between the analog channels
- Adjust the relative timing (delay) of the marker outputs (for each channel)
- Adjust the phase of all output signals relative to the system clock

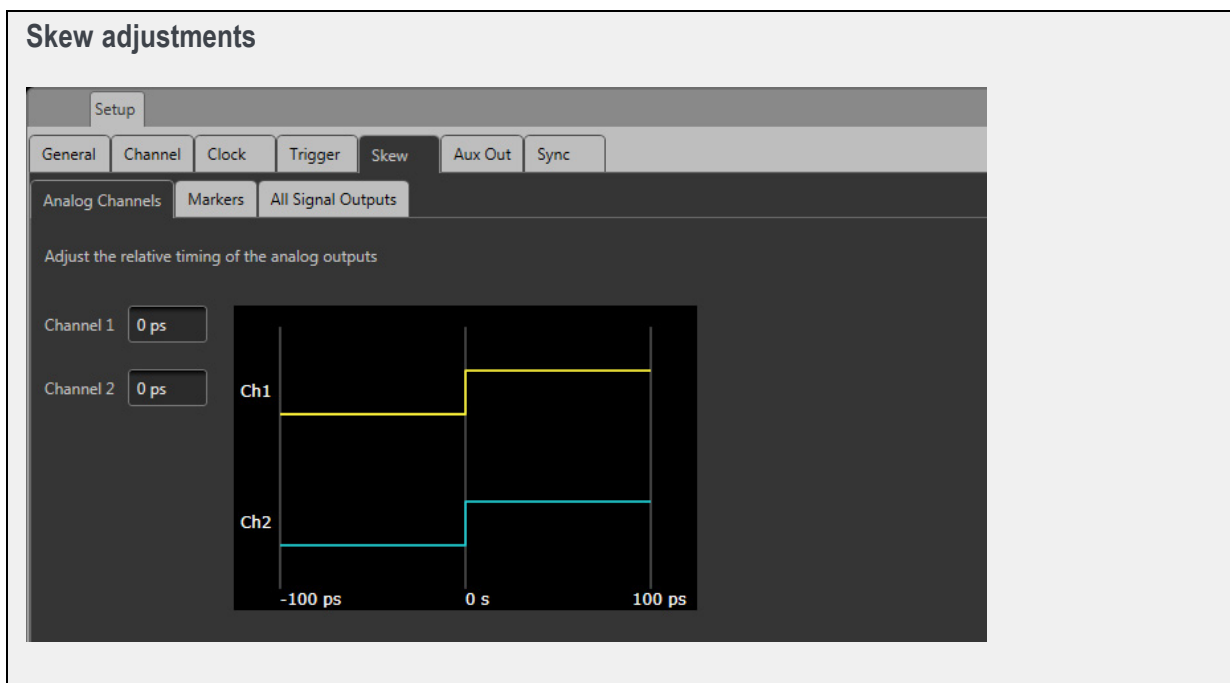

### Analog channel skew adjustments

With multi-channel instruments, the channel outputs might not always be perfectly aligned, due to many factors such as a differences in cable lengths.

In the Setup menu, select the Skew tab and then the Analog Channels tab to display the channel skew. You can adjust the relative timing of every available channel output within the range of  $\pm 2$  ns.

---

**NOTE.** *Adjusting channel skew is best accomplished by viewing the outputs of the channels on an oscilloscope while adjusting.*

---

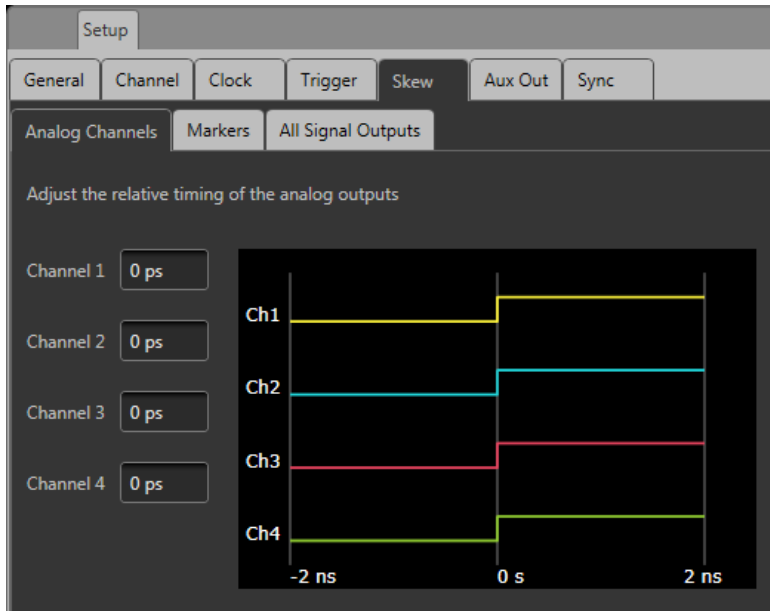

### Marker delay adjustment

The Marker Delay adjustment is accessed from the Skew tab in the Setup tab.

Four markers are available for each channel. Use the Channel pull-down list to select which markers to adjust.

You can adjust the relative timing of each marker within the range of  $\pm 2$  ns. The marker delay is referenced to the channel's analog output.



### Signal output phase adjustment

The Phase adjustment for all signal outputs is accessed from the Skew tab in the Setup tab.

The Phase adjustment allows you to adjust the phase of all signal outputs (except for clocks) to synchronize output signals between multiple instruments. The phase adjustment is relative to the system clock and can be adjusted in degrees or time.

When adjusting as degrees, the range is  $\pm 8640^\circ$ .

When adjusted in time, the range is based on the system clock. At 5 GS/s, the range is  $\pm 4.8$  ns. At 2.5 GS/s, the range is 9.6 ns.

Outputs from the Analog channels, Markers, and Aux output connectors are all affected.

The phase adjustment is only useful when the instrument is externally triggered.

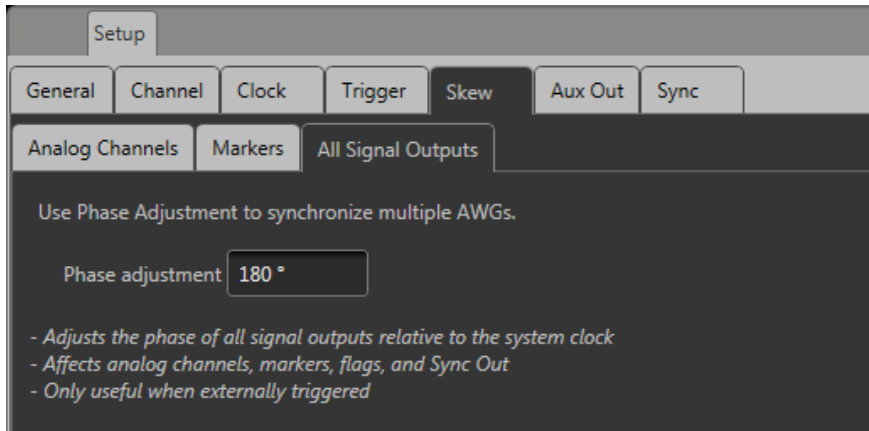

## Sync (synchronization)

The Sync tab is used to prepare the instrument for use in a synchronized system, synchronizing the outputs of multiple instruments.

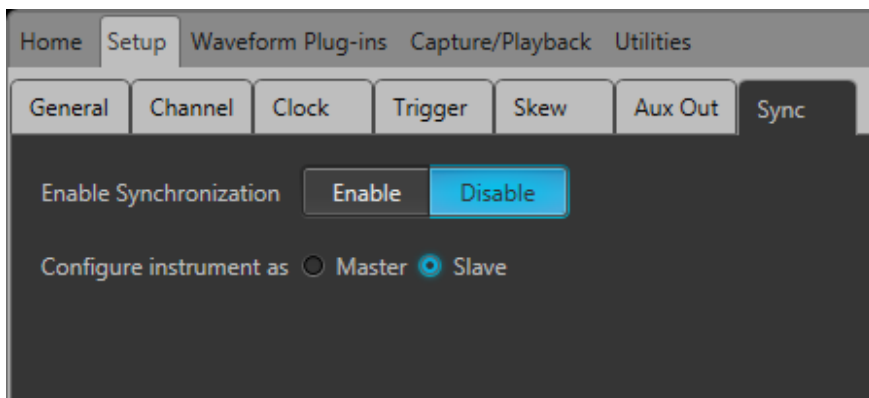

---

**NOTE.** This synchronization can only be used to synchronize AWG5200 series waveform generators.

---

### Using synchronization

1. Configure the instrument as either the Master or Slave.

Select if the instrument is the Master (supplying the synchronization signal) or the Slave (receiving the synchronization signal).

Selecting Master causes the following actions:

- Aux Out controls are disabled. Flags for sequencing are not available on the Master instrument.

2. Select Enable to prepare the instrument for synchronization.

Selecting Enable causes the following action:

- Sync Clock Out (on rear panel) is activated and provides a synchronization signal if the instrument is the Master.
- Sync In (on rear panel) is activated to accept the sync signal from the Sync Clock Out connector.

Each instrument to be included in the synchronized system must have synchronization enabled and the proper type selected (Master or Slave).

By default, Synchronization is disabled.

## Aux Out setup

The Aux Out tab allows you to configure the outputs of the Auxiliary output connectors on the rear panel.

---

**NOTE.** The Aux Out tab is disabled and Flags are not available when Synchronization is enabled and the instrument type is set to Master. Refer to [Synchronization \(see page 84\)](#)

---

The number of available Auxiliary outputs is dependent on the instrument model.

AWG5202: 1 – 4

AWG5204: 1 – 4

AWG5208: 1 – 8

For each output, define the flag to output and from which channel.

The flags available are A – D.

The channels available is dependent on the instrument model.

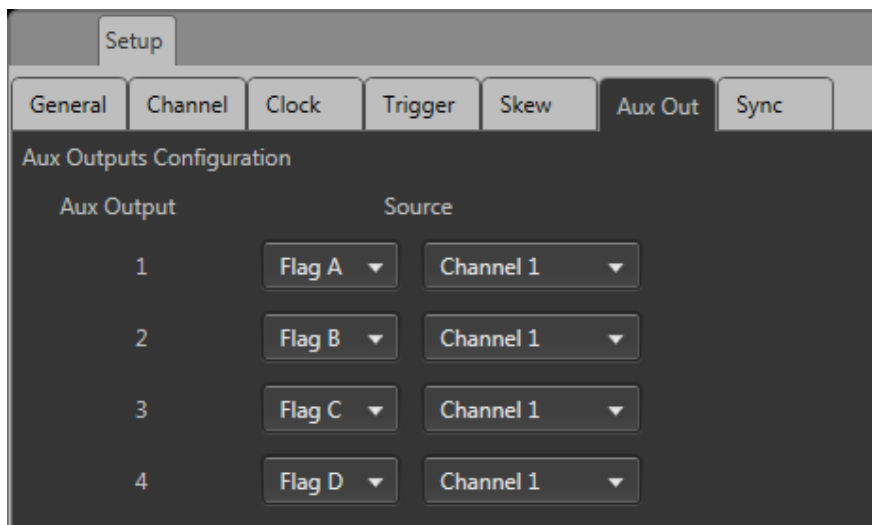

See the [Sequence flags \(see page 100\)](#) section for information about setting up flags.

## Sequence tab overview

It is sometimes necessary to create long, complicated waveform files. Where waveforms are repeated, waveform sequencing can save you a lot of memory-intensive waveform programming.

A sequence consists of data using a combination of multiple waveforms or subsequences. Specify the sequence (output order) and output the waveforms. Waveforms are controlled by a sequence definition that uses Wait (waiting for trigger), Repeat (number of repetitions), Event Jump To (jumping to event information), and Go To (modifying output order).

Pattern jump is another method to control a sequence, allowing you to jump to a specified position in a sequence, depending on a digital pattern applied to the Pattern Jump In connector. Refer to [Pattern Jump \(see page 97\)](#) for additional information.

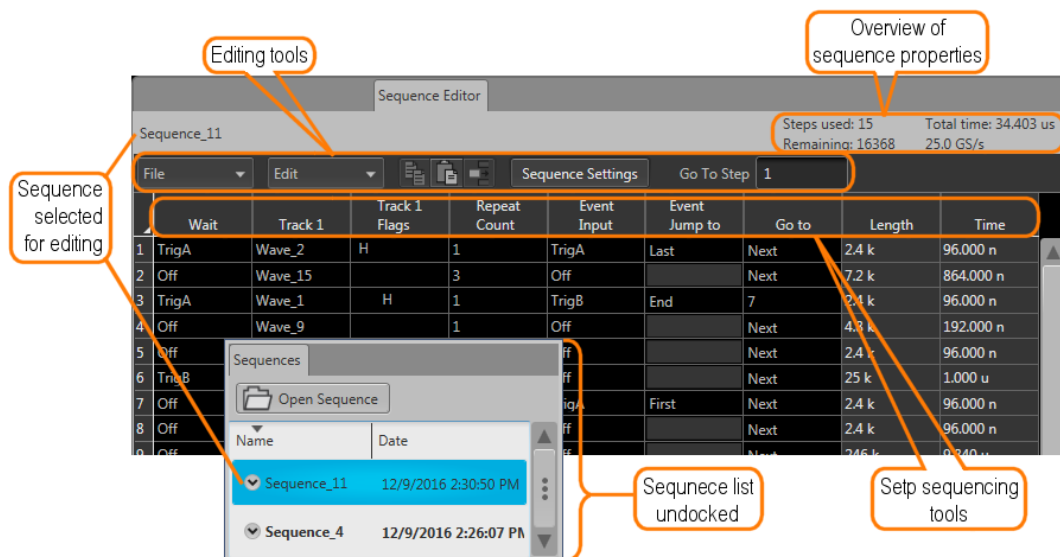

## Editing tools

The editing tool bar in the sequence table provides tools that perform functions that can affect the entire sequence or functions specific to a step's cell.





The File drop-down list contains the following menu selections.

- **Save:** Applies all changes to the opened sequence.
- **Save As:** Saves the opened sequence as a new sequence with a new name. Both the Sequences list and windows directory are updated.
- **Open:** Displays a windows directory. Use the Windows directory to navigate to saved sequences.
- **Recent:** Displays the list of sequences currently in the Sequences list.
- **New:** Creates a new empty sequence.
- **Properties:** Displays the properties of the opened sequence.
- **Rename:** Opens a dialog box to rename the opened sequence. A renamed sequence only appears in the Sequences list.



The Edit drop-down list contains the following menu selections.

- **Copy:** Copies the selected items in the sequence editing table. A copy initiated from here allows you copy entire columns or rows in the sequence editing table.
- **Paste:** Pastes the data from the copy clipboard. When pasting data copied from a cell or column, you can only paste into the same column. This can be within the same sequence or a different sequence.
- **Paste – insert steps:** Use this selection to copy an entire step and paste it in the sequence as a new step.
- **Reset selection to default:** This changes all the selected cells to their default values.
- **Insert step:** Use this to insert a new step into the sequence. The new step is inserted directly above the currently selected step.
- **Insert steps...:** Use this to insert a defined number of new steps. New steps are inserted directly above the currently selected step.

See the [Copy and paste guidelines \(see page 92\)](#) for some general information about how copy and paste functions work in a sequence table.



Copy icon: Copies the selected items in the sequence editing table. A copy initiated from here allows you copy entire columns or rows in the sequence editing table.



Paste icon: Pastes the data from the copy clipboard. When pasting data copied from a cell or column, you can only paste into the same column. This can be within the same sequence or a different sequence.



Insert step icon: Use this to insert a new step into the sequence. The step is inserted above the currently selected step.

---

**Sequence Settings**

The Sequence Settings button displays a dialog screen to set the following:

- Jump Timing: Determines when a jump occurs
- Enable Pattern Jump: Enabling a jump to occur based on a digital pattern.
- A link to the pattern jump editor
- Adjust the sampling rate
- Enable the Flag Repeat

Refer to [Sequence Settings \(see page 92\)](#) for details about the settings available in the Sequence Setting dialog screen.

**Go To Step 1**

The Go To Step lets you jump directly to a step within the sequence to view and edit the step.

## Sequence create and edit toolbar

Sequences are a series of individual waveforms or subsequences that you can use to create long waveform files. A subsequence is simply an existing sequence that is assigned to a step in a sequence.

Use the [Sequence tab](#) to create a new sequence or edit existing sequences.

To create a sequence, you start by assigning a waveform or sequence to play in the step of a sequence track. Continue building your sequence by assigning waveforms (or other defined sequences) to successive steps. By default, each step of a sequence plays in order of the numbered steps. When the sequence reaches the final step, the sequence naturally ends.

**Sequence tab**

	Wait	Track 1	Track 1 Flags	Repeat Count	Event Input	Event Jump to	Go to	Length	Time
1	TrigA	Wave_2	H	1	TrigA	Last	Next	2.4 k	96.000 n
2	Off	Wave_15		3	Off		Next	7.2 k	864.000 n
3	TrigA	Wave_1	H	1	TrigB	End	7	2.4 k	96.000 n
4	Off	Wave_9		1	Off		Next	4.8 k	192.000 n
5	Off	Wave_4		1	Off		Next	2.4 k	96.000 n
6	TrigB	Wave_10	L	1	Off		Next	25 k	1.000 u
7	Off	Wave_5		1	TrigA	First	Next	2.4 k	96.000 n
8	Off	Wave_11		1	Off		Next	2.4 k	96.000 n
9	Off	Wave_12		1	Off		Next	2.4 k	96.000 n

**NOTE.** Sequencing is only one level deep. This means a sequence step can have only one subsequence. A subsequence cannot contain another subsequence.

Each step can have conditions set that impact the playout of the sequence, such as triggers and jumps.

Use the Step sequencing tools to design your sequence.

To edit a subsequence, touch and hold or double click on the subsequence indicator in the step column. See [Subsequence editing \(see page 102\)](#) for details on the subsequence editor.

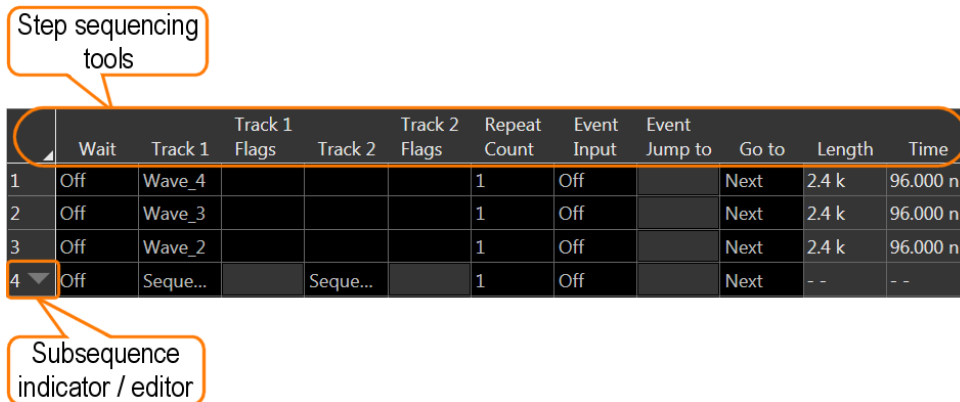



Table 3: Step editor toolbar

Item	Description
 Step number column	<p>The first column in the Sequence editor are the numbered steps. These step numbers define the play sequence and are used as the targets for the Event Jumps, Pattern Jumps, Force Jump, and Go to features.</p> <p>The maximum number of steps allowed in a sequence is 16,383 steps. This includes steps contained within subsequences. For example, a sequence numbering to 1000 steps would actually have 1500 steps if a subsequence of 500 steps is part of the sequence.</p> <p>When using a subsequence, the steps in the subsequence are only counted one time, meaning that you can reference the same sequence multiple times without increasing the step count multiple times.</p>
	<p>Defines the condition required for the step to start playing the assigned waveform.</p> <ul style="list-style-type: none"> <li>■ Off: No waiting, the waveform plays immediately.</li> <li>■ Trig A: The step does not start until a trigger signal is received on the Trigger A input or a Force Trigger A event is received.</li> <li>■ Trig B: The step does not start until a trigger signal is received on the Trigger B input or a Force Trigger B event is received.</li> <li>■ Internal: A jump occurs when the internal trigger event occurs. See <a href="#">Trigger input settings (see page 76)</a> to adjust the internal trigger interval.</li> </ul>

**Table 3: Step editor toolbar (cont.)**



Item	Description
	<p>The Track columns contain the name of the waveform or subsequence to play at each step. Up to eight tracks are available for a sequence.</p> <p>To load a waveform into a step, open the Waveform List, select a waveform and drag the waveform into the track step.</p> <p>If the Digital Up Converter (DIGUP) is licensed, IQ waveforms can be assigned to a channel for payout. Hence a sequence that contains an IQ waveform can be played.</p> <p><b>NOTE.</b> <i>Sequence tracks cannot mix IQ waveforms and real waveforms together in the same track.</i></p> <p>To load a subsequence into a step, open the Sequence List and drag a sequence name in the track step. This sequence now becomes a subsequence.</p> <p>Once a waveform or sequence is assigned to a step, you can use the copy and paste functions to populate other steps within the sequence.</p> <p>To add a new track, right-click on any of the Track column headings and select Add Track. A new track is added after the last track.</p> <p>To remove a track, right-click on the Track column you want to remove and select Remove Track.</p> <p>To play a sequence track, you must assign the track to a channel, even if there is only one track in the sequence. Use the Home tab to assign sequence tracks to channels. <a href="#">See Assigning tracks to a channel (see page 49).</a></p> <p>Typically, you would not modify a sequence track when the sequence track is playing. But with Dynamic Loading enabled (from the General tab of the Setup menu), you can open (edit) a sequence that is playing and load a new waveform into a step. If Dynamic loading is not enabled, this action would cause the sequence to stop playing. See <a href="#">Enable dynamic loading</a> for addition information and limitations.</p>
	<p>The Flags column allows you to place indicators (flags) within a sequence to provide a status of the sequence. The flags are output to the Flag Outputs on the rear panel. Refer to <a href="#">Sequence Flags (see page 100)</a> for more information about the types of flags and their configuration.</p>
	<p>The Repeat Count column defines how many times the waveform or subsequence plays for the step in the sequence.</p> <ul style="list-style-type: none"> <li>■ &lt;enter count&gt;: Enter the number of times to repeat the waveform. The maximum repeat count for a step is 4294967296 (2<sup>32</sup>).</li> <li>■ ∞: Use infinity to continuously play the waveform until a jump condition occurs.</li> <li>■ 1: The waveform plays one time.</li> </ul>

Table 3: Step editor toolbar (cont.)

Item	Description
Event Input	<p>Defines the event which will cause a jump to occur in the sequence step. If an event triggers a jump, the sequence uses the Event Jump to definition and skips the Go to definition.</p> <ul style="list-style-type: none"> <li>■ Off: A jump is not active for the step. Off is the default setting.</li> <li>■ Trig A: A jump occurs if a trigger signal is received on the Trigger A input or a Force Trigger A event is received. Otherwise, the sequence uses the Go to definition.</li> <li>■ Trig B: A jump occurs if a trigger signal is received on the Trigger B input or a Force Trigger B event is received.</li> <li>■ Internal: A jump occurs when the internal trigger event occurs. See <a href="#">Trigger input settings (see page 76)</a> to adjust the internal trigger interval.</li> </ul> <p><b>NOTE.</b> Refer to the <a href="#">Jump Execution Order (see page 99)</a> table to see the order in which jump conditions are executed.</p>
Event Jump to	<p>Defines which step to jump to when the Event Input condition is met. The Event Input condition must be set before you can define the jump.</p> <ul style="list-style-type: none"> <li>■ &lt;enter step&gt;: Enter the step number to jump to if the Event Input condition is met.</li> <li>■ Next: The sequencer jumps to the next step in the sequence.</li> <li>■ First: The sequencer jumps to the first step in the sequence.</li> <li>■ Last: The sequencer jumps to the last step in the sequence.</li> <li>■ End: The sequence ends. The Analog and Marker outputs are set to the values defined in <a href="#">Output Options (see page 63)</a> dialog screen.</li> </ul>
Go to	<p>Defines the next step in the sequence to play when the step has finished playing its waveform. This is where the sequence continues if no other defined events occur.</p> <ul style="list-style-type: none"> <li>■ &lt;enter_step&gt;: Enter a specific step in the sequence to jump to.</li> <li>■ Next: The sequence goes to the next step in the sequence. This is the default setting. If Next is chosen for the last step in the sequence, the sequence ends.</li> <li>■ First: The sequence jumps to the first step in the sequence.</li> <li>■ Last: The sequence jumps to the last step in the sequence.</li> <li>■ End: The sequence stops when finished with this step.</li> </ul> <p><b>NOTE.</b> Refer to the <a href="#">Jump Execution Order table</a> to see the order in which jump conditions are executed.</p>

Table 3: Step editor toolbar (cont.)

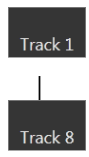
Item	Description
Length	<p>Displays the size of the waveform assigned to the step.</p> <p><b>NOTE.</b> <i>The Length display becomes invalid if the sequence has more than one track and the waveforms assigned to the step are different sizes.</i></p> <p>If you are attempting to play multiple tracks of a sequence on a two channel instrument, each step of the tracks must use identical length waveforms.</p>
Time	<p>The displayed time is based on the waveform size, sample rate, and the repeat count.</p> <p><b>NOTE.</b> <i>The Time display becomes invalid if the sequence has more than one track and the waveforms assigned to the step are different sizes.</i></p>

## Copy and paste guidelines

In the sequence tab, you can use the Edit menu or right-mouse click to copy and paste items within the same sequence or to other sequences.

There are some general guidelines to know:

- Within the same sequence, you can only copy and paste within the same column type. For instance, you can copy a Wait setting and paste it to another Wait step but not to the Event Input.

You can copy and paste from one track to another, since these contain information of the same type.

- Using the Edit menu, you can copy a selected column and paste it into another sequence.

If you copy a Track column, you can paste into another track within the same sequence or to another sequence.

- If pasting a range of copied cells exceeds the current number of steps, new steps are added.

## Sequence settings

The [sequence settings](#) dialog box provide the following settings:

- Jump Timing – Jump timing determines when an event jump in the sequence occurs. Refer to [Jump timing \(see page 96\)](#) for more information on these settings.

Refer to [Jump priority \(see page 99\)](#) for a description of the order in which the different types of jumps are acted upon by the system.

- Enable Pattern Jump – This enables the pattern jump event feature. A jump occurs when the system detects a defined digital pattern on the Pattern Jump connector on the rear panel. Use the Edit pattern jump table button to display the pattern jump table editor. See Pattern jump table for information about

creating a pattern jump. Refer to [Pattern jump \(see page 97\)](#) for more information on using the pattern jump feature and creating a pattern jump event.

- Flag Repeat – Enabling the Flag Repeat feature causes the flag (or flags) for that step to repeat if the sequence step is set to repeat (using the Repeat Count setting).

The default setting is off (not enabled). This means that the flags are set the first time the waveform is played for a sequence step. Repeating the step will not cause the flag to repeat.

When enabled, the flag is set each time the waveform plays for each time the step is repeated.

---

**NOTE.** *The Repeat Flag feature is only useful when using the Toggle or Pulse flags. Since flags remain in their set state (unless changed by another step or the sequence ends), repeating a high or low flag would not cause any change to the flag output.*

---

Additional settings (sample rate, amplitude, offset, and frequency) are available from the sequence's properties dialog screen. These are recommended settings that are applied when the sequence is assigned to a channel. Refer to [Sequence properties \(see page 52\)](#).

Refer to [General setup \(see page 53\)](#) to enable use of the recommended settings.

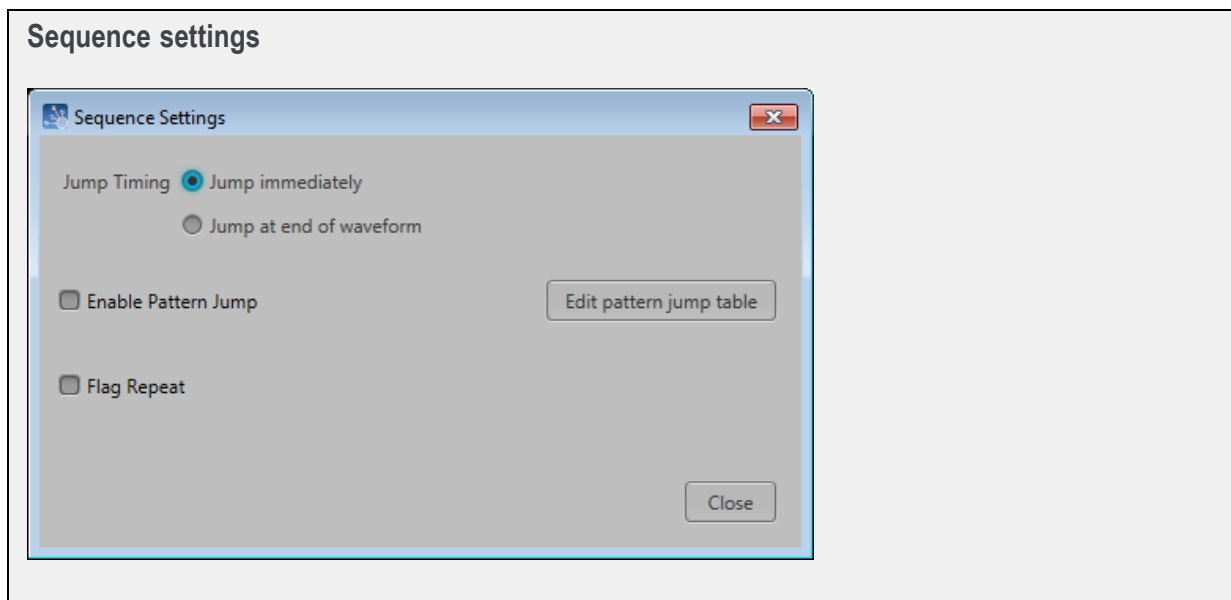

## Forcing jumps introduction

There are two methods to force an immediate jump to a specific step in a sequence:

- [Force Jump To... \(see page 94\)](#) button located on the Home tab for each channel. This jump operates differently (uncoupled or coupled) depending on how sequence tracks are assigned for multi-channel instruments.
- **Force Jump Here** menu selection accessed directly from a step in the sequence.

**NOTE.** As with any jump, when the jump actually occurs is dependent on the [Jump Timing \(see page 96\)](#) control in the Sequence Settings dialog screen.

*You cannot force a jump into a subsequence. You can only jump to the step containing the subsequence.*

## Force Jump To... button

The **Force Jump To...** button (from the Home tab) allows you to interrupt the current sequence track by causing a jump to a specific step in the running sequence track.

You can run sequence tracks on any or all available channels. If the tracks assigned to each channel is from a different sequence, then the Force Jump To button operates in the uncoupled mode. If any of the channels have tracks assigned to them that come from the same sequence, then the button operates in the coupled mode. In this case, a force jump action occurs on all channels involved, regardless of which channel is used to initiate the jump.

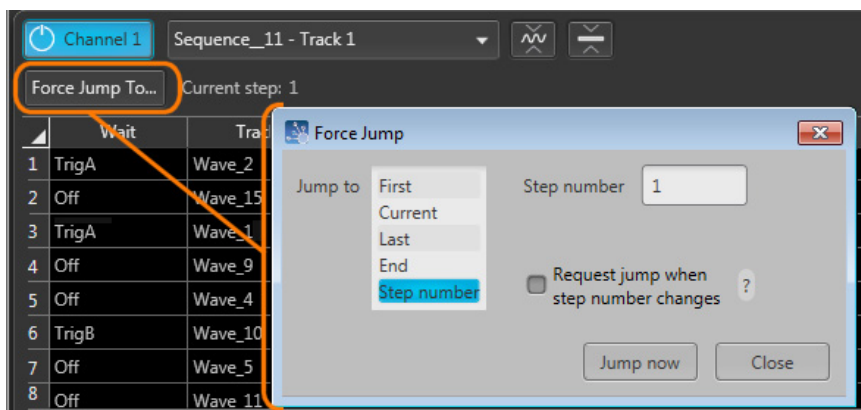

Use the Jump to list to select a step in the sequence.

- First, Current, Last, and End all select the indicated step within the sequence playing. Selecting any of these requires you to press the Jump now button to initiate the jump.
- Step number allows you to specify a particular step in the sequence to jump to. You can enter step numbers directly with a keypad (front-panel or keyboard) or scrolling to a step number with the front-panel general purpose knob, a mouse scroll wheel, or keyboard up/down arrows. You can use the Jump now button to initiate the jump.



If the **Request jump when step number changes** is checked, the jump occurs whenever the step number is changed. You can change the step number with the front-panel general purpose knob or keypad. You can also change the step number with a keyboard or mouse scroll wheel.

**CAUTION.** *When using a scrolling action to change the step number while the **Request jump when step number changes** is checked, it's possible to cause an unintended step to play. For example, if step 2 is currently playing, and you want to jump to step 4 using a scrolling method, you will pass through the number 3, which will cause step 3 to play.*

### Force Jump To button - synchronized

When playing tracks from the same sequence on multiple channels, the sequence jumps must occur together for all channels. This is true whether playing the same track or different tracks of the sequence on multiple channels. In this case, a force jump action occurs on all channels involved, regardless of which channel is used to initiate the jump.

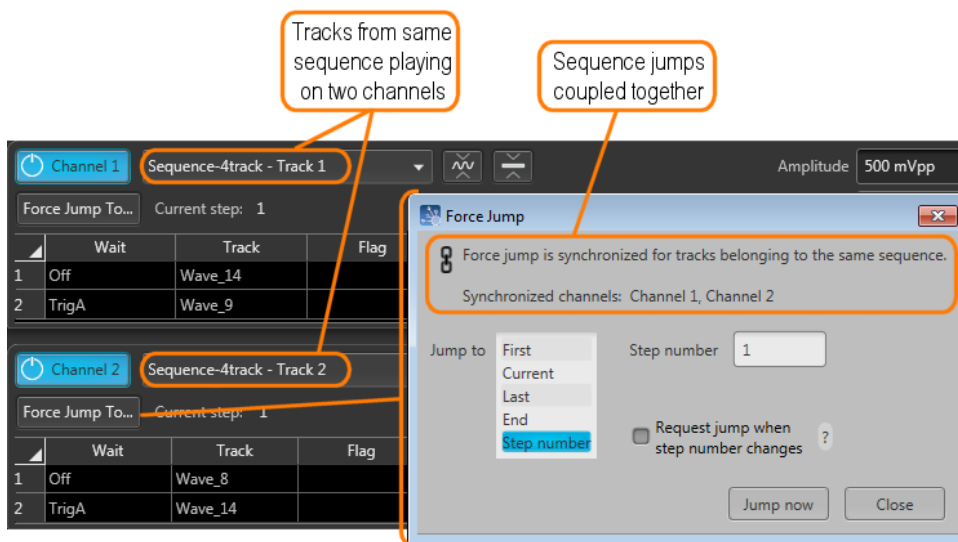

## Force jump here

You can also force a jump directly to a step in the sequence from within the sequence display.

Go to the step you want to jump to, touch and hold (or right-mouse click) somewhere on the row of the step number and select Force jump here.

The sequence will immediately jump to the selected step. If the sequence is playing on more than one channel, the Force jump here displays the coupled icon and the forced jump will affect all channels using the same sequence.

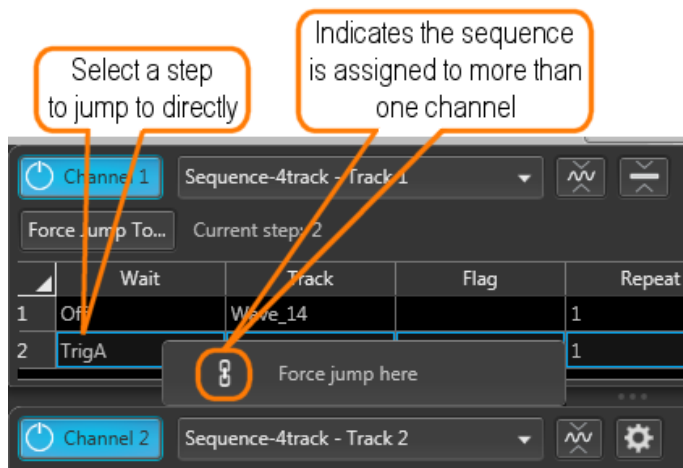

## Jump timing

Jump timing determines when an event jump in the sequence occurs. This affects all types of event jumps

You can access the jump timing settings in two ways: either from the [Sequence Settings](#) dialog screen in the Edit menu or directly from the Jump button.

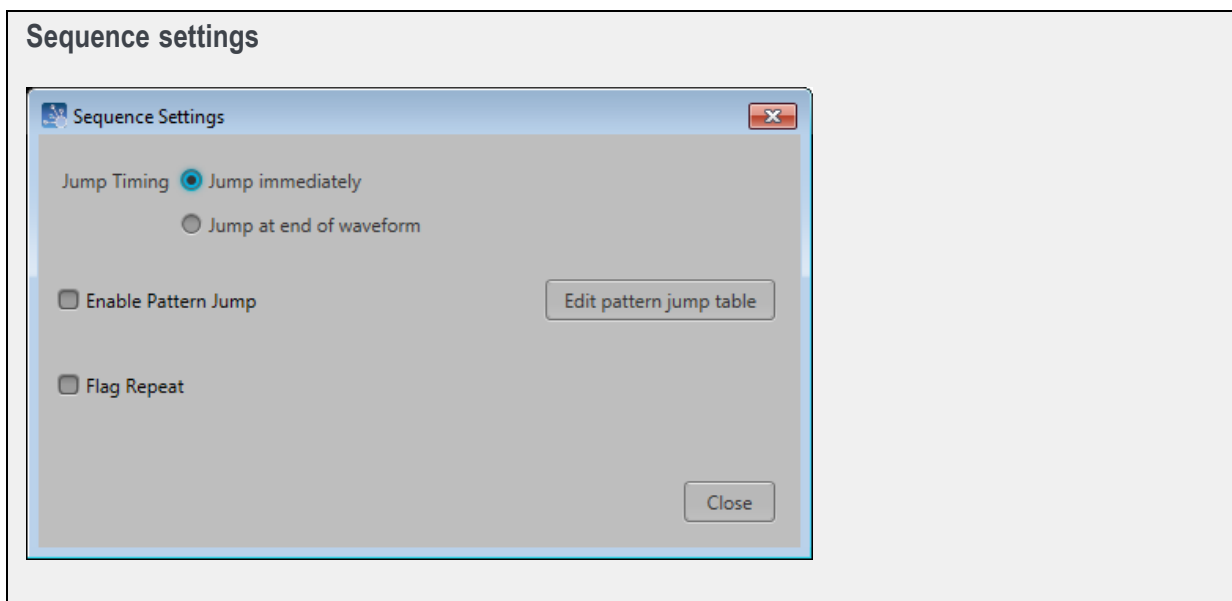

- Jump Timing – Jump timing determines when an event jump in the sequence occurs.
  - Jump immediately – A jump occurs at the time the jump event occurs, stopping the playout of the waveform currently playing.
  - Jump at end of waveform – A jump occurs only after the currently playing waveform completes its playout.

If the waveform is defined to repeat (using the Repeat Count setting in the Sequence editor), the end of waveform occurs when the waveform finishes its current cycle.

Refer to [Jump priority \(see page 99\)](#) for a description of the order in which the different types of jumps are acted upon by the system.

## Creating a Pattern jump

Pattern Jump is another type of event jump to cause a change in the sequencing of waveforms with the use of an external digital pattern applied to the Pattern Jump In connector on the rear panel.

As with any other event jump, Pattern Jump allows you to jump to a specified position in a sequence.

Use the Pattern Jump Table to define your sequencing jumps. The Pattern Jump editing table is available from the Sequence Settings dialog screen in the Sequence tab.

---

**NOTE.** *The Strobe Edge is used to clock in the pattern jump inputs. The Strobe Edge is configured in the Trigger tab under Setup.*

---

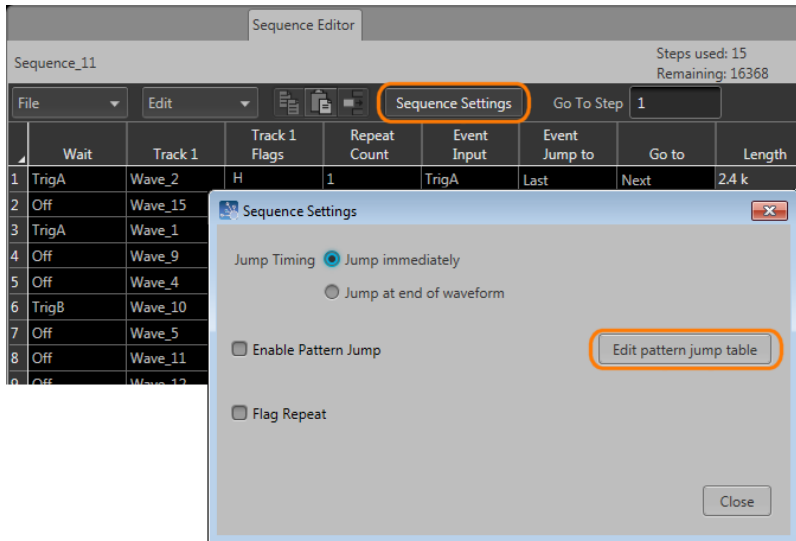

## Pattern jump table

Use the Pattern Jump Table to select the input patterns to initiate a jump. The number of available input patterns (to use for sequence jumps) depends on the Strobe Edge configuration. The input patterns cannot be edited.

### Strobe edge

### Available patterns

Rising or Falling	256 predefined input patterns available. 0000 0000 — 1111 1111
-------------------	---

To use the jump table, simply go to a corresponding input pattern and select the step in the sequence you want the sequence to jump to when that pattern is applied to the Pattern Jump In connector.

A strobe signal is used to control the pattern input. Patterns are clocked in on the edge of the strobe signal. The strobe edge is configured in the [Trigger tab \(see page 76\)](#) under the Setup tab.

**NOTE.** The step entered in the Jump to Step column must be a valid step number within the sequence being edited.

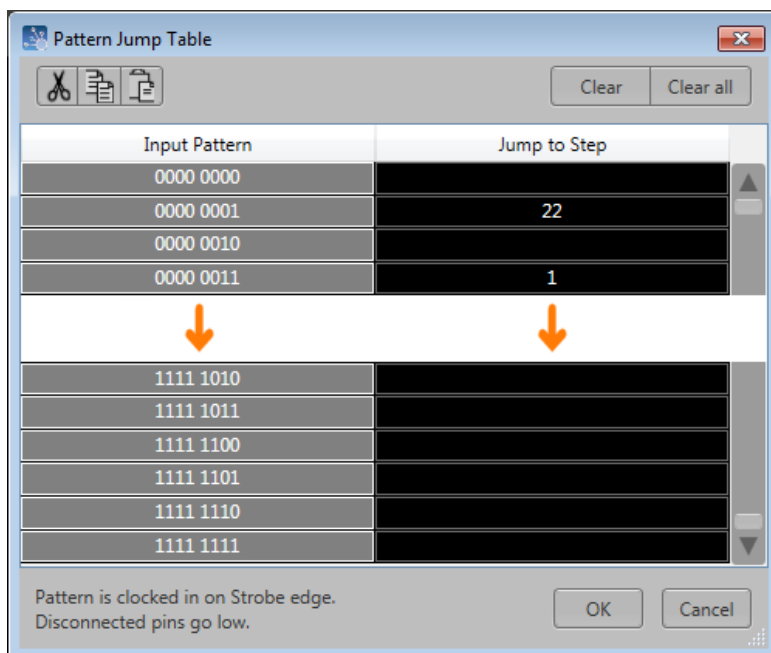

See [Pattern Jump In connector \(see page 185\)](#) table for a list of the pin assignments for the Pattern Jump In connector.

## Jump execution order

There are a number of ways that a jump can be initiated in a sequence. Some types of jumps take precedence over other types of jumps.

Below is the order in which jumps are executed by the system.

1. Force Jump – Pressing the **Force Jump to...** button (from the Home tab) allows you to initiate a jump anytime anywhere within the sequence. A force jump takes precedence over all other types of jumps regardless of the current step of the sequence.
2. Pattern Jump – If Pattern Jump is enabled and the defined pattern occurs, this jump takes precedence over the Event Jump or Go to jump. The Pattern Jump is independent of any step of the sequence.
3. Event Jump – If an Event Jump is defined for a step, this jump takes precedence over the Go to jump.
4. Go to Jump – Go to is the default jump destination for a step if no other jumps occur.

---

**NOTE.** All jump types are dependent on the [Jump Timing \(see page 96\)](#) setting, either causing the jump to occur immediately or at the end of the waveform currently playing.

---

## Sequence flags

Sequence flags provide you the ability to add indicators within the sequence to help identify the state of the sequence. And since Flags are not part of a waveform file (unlike Markers), the waveforms are able to use the full resolution of the instrument.

These flags are output via the Aux Output connectors on the rear panel. The Aux Outputs must be configured in the [Aux Out tab \(see page 85\)](#) in the Setup tab.

---

**NOTE.** Flags for sequencing are not available when Synchronization is enabled and the Instrument type is set to Master. See [Using synchronization](#).

---

A flag can be placed on any step within a sequence track. The flag signals the start of the waveform playback for that sequence step. So if there is a wait condition, the flag is not set until the condition is met.

The flags column is divided into four sections, corresponding to the four outputs available (A, B, C, D). To help identify the flag locations, the following illustration shows that a flag has been set in each possible location.

	Wait	Track 1	Track 1 Flags	
1	Off	Wave_4	H	Step 1, Flag A set to High
2	Off	Wave_3	L	Step 2, Flag B set to Low
3	Off	Wave_2	T	Step 3, Flag C set to Toggle
4	Off	Seque...	P	Step 4, Flag D set to Pulse

A B C D

To set a flag, either touch or double click on the flag cell. The following dialog appears:

There are four flag outputs (A, B, C, D) available for each channel. The flag outputs are located on the rear panel (Flag Outputs).

Each flag has the following possible states:

- No Action: This is the default state for all flags. The flag output is at 0 V at default.
- High: The designated flag output is set to high (3.3 V into 50 Ω).
- Low: The designated flag output is set to low (0 V).

- Toggle: The designated flag output toggles from its previous state, from High to Low or Low to High.
- Pulse: A pulse is sent to the designated flag output. The pulse direction is determined by the current state of the flag output. If the current state is low, the result is a positive pulse. If the current state is high, the result is a negative pulse.

The pulse width is determined by the sample rate with the formula:  $600/\text{Sample Clock}$ .

Flag outputs remain in their set state until the sequence ends or the flag is set again by another sequence step. You can quickly disconnect the flag outputs using All Outputs Off, either in the graphical interface or with the front panel button. (The output connectors are electrically floating while all outputs off is engaged.)

---

**NOTE.** *Be careful when defining flag outputs. It's possible to redefine a flag's output within the same sequence, easily leading to undesired results.*

---

All Aux outputs are terminated into  $50\ \Omega$  and have short circuit protection to ground.

### Sequence flag timing

A sequence flag is initiated by the start of the waveform ployout associated with the step. The flag is set before the waveform ployout begins. The timing of the waveform ployout from a flag's transition change is illustrated below, followed with the formulas to calculate the delays.

Flags also have a repeatability window. This means there may be a slight difference in the delay time of a flag's transition in successive changes. See the timing illustration below to help explain these delays.

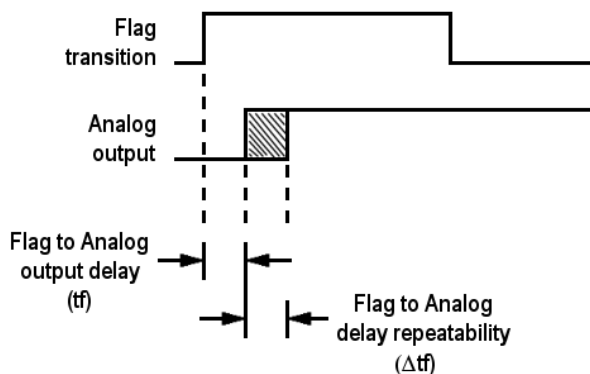

**Timing calculations.** Use the formulas below to calculate the actual flag delay and flag repeatability window.

- Flag to Analog output delay (tf):

$$\text{Flag to Analog output delay (tf)} = \frac{-291.5}{\text{sampling clock} \times 2} + 9.76 \text{ ns } (\pm 5 \text{ ns})$$

- Flag to Analog output delay repeatability ( $\Delta\text{tf}$ ):

If  $\frac{\text{Waveform length}}{240} = \text{Integer value}$ , then  $(\Delta\text{tf}) \leq 200 \text{ ps}$

If  $\frac{\text{Waveform length}}{240} = \text{Noninteger value}$ , then  $(\Delta\text{tf}) \leq \frac{120}{\text{sampling clock}}$

### Flag stability

To ensure flag positions are stable, relative to the waveform, the waveform size needs to be in increments of 64 samples.

## Subsequence editing

Subsequences are simply a sequence that is inserted as part of another sequence.

There are two methods to edit a subsequence:

- Open the sequence (to be used as a subsequence) directly from the Sequence List. This opens the sequence in the main sequence editor. See [Sequence create and edit toolbar \(see page 88\)](#) for information about the sequence editing toolbar for editing a sequence.
- Open the subsequence from within the main sequence. When a sequence is being used as a subsequence, a subsequence editor is provided. The subsequence editor provides you with only the functions subsequencing supports.

To edit a subsequence with the subsequence editor, display the main sequence in the Sequence window. When a sequence is being used as a Subsequence, an arrow icon is displayed in the step number. Touch and hold or double-click the icon to display the subsequence editor.

Subsequence editing is performed the same as editing any sequence, but with the following limitations:

- Subsequences do not use any Wait conditions. If a wait condition is built into a sequence, the wait conditions are ignored if the sequence is used as a subsequence.
- Subsequences do not support Event Jumps or Pattern Jumps. If a jump is built into a sequence, the jumps are ignored if the sequence is used as a subsequence.
- You cannot jump or go to a step to the main sequence from a subsequence.
- If the subsequence uses a step definition of End (end of sequence) in the Go to column, it is redefined as Last (last step of the subsequence)
- If a sequence containing wait conditions and jump conditions is loaded into a sequence (thus becoming a subsequence), the wait conditions and jump conditions are ignored.
- A subsequence cannot be set to loop the entire subsequence. (For example, you cannot modify the Go to setting of the last step of a subsequence.) To repeat or loop a subsequence, you must set the Repeat Count of the sequence step (containing the subsequence) to a value other than 1.



	Track	Event Input	Event Jump to	Go to	Length	Time
1	Wave_4	Off		Next	2.4 k	96.000 n
2	Wave_3	Off		Next	2.4 k	96.000 n
3	Wave_2	Off		End	2.4 k	96.000 n
4	Sequenc...	Off		Next	9.6 k	384.000 n

	Track 1	Track 1 Flags	Repeat Count	Go to
4.1	Wave_1		1	Next
4.2	Wave_2		1	4.4
4.3	Wave_3		1	Next
4.4	Wave_4		1	Next

Step 4 contains a subsequence

Touch and hold or double-click to open subsequence editor

Subsequence editor

	Track 1	Track 1 Flags	Repeat Count	Go to
4.1	Wave_1		1	Next
4.2	Wave_2		1	4.4
4.3	Wave_3		1	Next
4.4	Wave_4		1	Next

Subsequence step numbering

Subsequence editing tools

Close subsequence editor

Step 4 contains a subsequence

Subsequence Go To locations remain within subsequence

## Sequencer batch compiler

The batch compiler provides a method to create sequences and waveforms using an Excel spreadsheet (.CSV file type) and then importing the file into the AWG. The comma delimited file type (.CSV) must be used.

To import the batch compiler file, you must use the Open File folder from the toolbar.

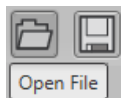

Opening the file compiles all defined waveforms and loads the sequence into the Sequences tab and loads all waveforms into the Waveforms tab.

The waveforms created by the batch compiler are limited to:

- Basic waveforms via the use of the Basic Waveform plug-in
  - Create sine waves, square waves, triangle waves, ramps, noise, and DC
- RF waveforms via the use of the RF Generic Signal plug-in. A license for the RF Generic Signal plug-in is required.
  - Create AM, FM, and PM Analog Modulation signals

### Creating a batch compile file (.CSV)

The .csv file must be created with very specific information in the proper cells. Deviating from this design will likely create an invalid file. The following information defines the rows, columns, and cell content required to create the batch file.

---

**NOTE.** The Samples directory (C:/Program Files/Tektronix/AWG5200/Samples) contains a sample batch file (Batch Compile Example.csv) that you can use as a basis to create your own batch file. The sample batch file contains the proper header information and basic track definitions.

---

**Header information.** The first four lines in column A must use the content as shown.

	A	B
1	AWG Sequence Definition	
2	Sequence Name	MySequence
3	Sample Rate	1.00E+09
4	Waveform Name Base	BCTest_#Frequency_#Length

**Table 4: Batch compiler header information**

Line	Column A	Column B (Optional)
Line 1 Mandatory	AWG Sequence Definition	blank
Line 2 (Optional)	Sequence Name	Enter a name for your sequence. If omitted, the system will generate a unique name.

**Table 4: Batch compiler header information (cont.)**

Line	Column A	Column B (Optional)
Line 3 (Optional)	Sample Rate	Enter the sampling rate to use. If omitted, the system calculates the sample rate based on the waveform frequency specified.
Line 4 (Optional)	Waveform Name Base	Enter the base name for the waveform files. Use the following syntax: <base name> [#Frequency_#Length_#Marker1_#Marker2....] The base name is used for all waveforms. You can also include any of the waveform parameters by including the parameter column heading, preceded by a # sign. If omitted, the system will generate unique names.

**Track information.** Following the header information is the start of the track definitions. You can create up to eight tracks containing multiple waveforms.

Each new track definition must start by creating a row with the name “Track” in cell A. This row signifies where the definition of each track begins.

The following row contains the headings for the waveform parameters. Note that some headings are global definitions while some headings define elements for each waveform. And the required and optional elements change based on the waveform editor you invoke (Basic or RF). See the tables below that describe the column contents depending on the waveform editor chosen.

A track can have many waveforms, with each waveform creating a new step in the sequence. The waveform definitions continue for the Track until another “Track” row is encountered. When defining multiple tracks, each track must contain the same number of waveform definitions.

The following illustrates the spreadsheet representing the columns for creating a basic waveform (using the Basic Waveform plug-in).

A	B	C	D	E	F	G
Track						
Wait	Repeat	Event Input	Event Jump To	GoTo	Flags	Waveform Name

H	I	J	K	L	M	N	O
Frequency	Length	Marker1	Marker2	Editor	Waveform Type	Amplitude	Offset

The following illustrates the spreadsheet representing the columns for creating an RF waveform (using the RF Generic Signal plug-in).

A	B	C	D	E	F	G
Track						
Wait	Repeat	Event Input	Event Jump To	GoTo	Flags	Waveform Name

H	I	J	K	L	M	N
Frequency	Length	Marker1	Marker2	Editor	Modulation Type	Modulation Type Parameter

O	P	Q	R	S
Amplitude	Phase	Modulating Signal	Modulating Frequency	Modulating Phase Offset

---

**NOTE.** Creating an RF waveform uses the RF Generic Signal plug-in. The RF Generic Signal must be licensed for use.

---

**Table 5: Batch compiler header: editor = Basic Waveform plug-in**

Column		
A	Wait	Optional: Wait condition. This is a global setting for all tracks and must be defined in the first track. Syntax: <Off   TrigA   TrigB   Internal> If omitted, set to Off.
B	Repeat	Optional: Repeat element. This is a global setting for all tracks and must be defined in the first track. Syntax: <<Integer>   ∞> If omitted, set to 1.
C	Event Input	Optional: Event input. This is a global setting for all tracks and must be defined in the first track. Syntax: <Off   TrigA   TrigB   Internal> If omitted, set to Off.

**Table 5: Batch compiler header: editor = Basic Waveform plug-in (cont.)**

Column		
D	Event Jump To	Optional: Event jump. This is a global setting for all tracks and must be defined in the first track. Syntax: <<step number>   Next   First   Last   End> If omitted, set to Next.
E	Go To	Optional: Go To element. This is a global setting for all tracks and must be defined in the first track. If omitted, set to Next.
F	Flags	Optional: Flag element. If defining flags, you must define all four flags. Use semicolons (;) to separate the flag definitions. Syntax: <FlagA;FlagB;FlagC;FlagD> Values include: Toggle   High   Low   Pulse   NoChange If omitted, set to NoChange.
G	Waveform Name	Optional: Waveform name. This supersedes the Waveform Name Base in the header information. If omitted, the Waveform Name Base is used.
H	Frequency	Specifies the frequency of the waveform to be compiled.
I	Length	Specifies the length in sample points of the waveform to be compiled. If omitted, the system calculates the length.
J	Marker1	Optional: Marker1 value. Syntax: <0   1> If omitted, set to 0.
K	Marker2	Optional: Marker2 value. Syntax: <0   1> If omitted, set to 0.
Add column	Marker3	Optional: Marker3 value. Syntax: <0   1> If omitted, set to 0.
Add column	Marker4	Optional: Marker4 value. Syntax: <0   1> If omitted, set to 0.
<p><b>NOTE.</b> The sample batch file provided includes columns for two Markers. AWG5200 series can support up to four marker columns. This changes the column assignments of the remaining parameters.</p>		

**Table 5: Batch compiler header: editor = Basic Waveform plug-in (cont.)**

Column		
L	Editor	Optional: Editor to use to compile waveform. Syntax: <Basic Waveform> If omitted, set to Basic Waveform. Use Parameter columns to set the Basic Waveform function. The Basic Waveform editor supports all functions of the Basic Waveform plug-in.
M	Waveform Type	Defines the type of waveform to create when Editor = Basic Waveform. Syntax: <Function=[Sine   Square   Triangle   Ramp   Noise   DC]> If omitted, set to Sine.
N	Amplitude	Sets the peak-to-peak amplitude. Syntax: <Amplitude=[variable]> If omitted, set to 500 mV <sub>pp</sub> .
O	Offset	Defines the offset. Syntax: <Offset=[variable]> If omitted, set to 0.

**Table 6: Batch compiler header information: editor = RF Generic Signal plug-in**

Column		
A	Wait	Optional: Wait condition. This is a global setting for all tracks and must be defined in the first track. Syntax: <Off   TrigA   TrigB   Internal> If omitted, set to Off.
B	Repeat	Optional: Repeat element. This is a global setting for all tracks and must be defined in the first track. Syntax: <<Integer>   ∞> If omitted, set to 1.
C	Event Input	Optional: Event input. This is a global setting for all tracks and must be defined in the first track. Syntax: <Off   TrigA   TrigB   Internal> If omitted, set to Off.
D	Event Jump To	Optional: Event jump. This is a global setting for all tracks and must be defined in the first track. Syntax: <<step number>   Next   First   Last   End> If omitted, set to Next.

**Table 6: Batch compiler header information: editor = RF Generic Signal plug-in (cont.)**

Column		
E	Go To	Optional: Go To element. This is a global setting for all tracks and must be defined in the first track. If omitted, set to Next.
F	Flags	Optional: Flag element. If defining flags, you must define all four flags. Use semicolons (;) to separate the flag definitions. Syntax: <FlagA;FlagB;FlagC;FlagD> Values include: Toggle   High   Low   Pulse   NoChange If omitted, set to NoChange.
G	Waveform Name	Optional: Waveform name. This supersedes the Waveform Name Base in the header information. If omitted, the Waveform Name Base is used.
H	Frequency	Specifies the frequency of the waveform to be compiled.
I	Length	Specifies the length in sample points of the waveform to be compiled. If omitted, the system calculates the length.
J	Marker1	Optional: Marker1 value. Syntax: <0   1> If omitted, set to 0.
K	Marker2	Optional: Marker2 value. Syntax: <0   1> If omitted, set to 0.
L	Editor	Optional: Editor to use to compile waveform. Syntax: <RF Generic Signal> Use the Parameters columns to define the RF Generic Signal. The RF Generic Signal editor supports analog modulation only. If omitted, set to the Basic Waveform plug-in and uses the Basic Waveform plug-in default settings.
M	Modulation Type	Defines the type of waveform to create when Editor = RF Generic Signal. Syntax: <Modulation Type=[AM   FM   PM]> If omitted, set to AM.

**Table 6: Batch compiler header information: editor = RF Generic Signal plug-in (cont.)**

Column		
N	Modulation Type Parameter	<p>Defines the base modulation type parameter.</p> <p>Modulation Type = AM Syntax: &lt;AM Index=[variable] If omitted, set to 50.</p> <p>Modulation Type = FM Syntax: &lt;Frequency Deviation=[variable] If omitted, set to 100000.</p> <p>Modulation Type = PM Syntax: &lt;Phase Deviation=[variable] If omitted, set to 10.</p>
O	Amplitude	<p>Defines the carrier amplitude.</p> <p>Syntax: &lt;Amplitude=[variable] If omitted, set to -6.24 dBm.</p>
P	Phase	<p>Defines the carrier phase.</p> <p>Syntax: &lt;Phase=[variable] If omitted, set to 0.</p>
Q	Modulating Signal	<p>Defines the modulating signal type.</p> <p>Syntax: &lt;Modulating Signal=[Sinusoidal   Triangular   Square] If omitted, set to Sinusoidal.</p>
R	Modulation Frequency	<p>Defines the frequency of the modulating signal.</p> <p>Syntax: &lt;Modulation frequency=[variable] If omitted, set to 1000000.</p>
S	Phase Offset	<p>Defines the Phase offset of the modulating signal.</p> <p>Syntax: &lt;Phase Offset=[variable] If omitted, set to 0.</p>

## Capture/Playback introduction

The Capture/Playback tab allows you to import IQ data files. Once imported, you then use the compile function to up-convert and create RF waveform files for playout. The newly created waveform files are added to the Waveform List. Sequences are created if the Sequencing option is available.

The Capture/Playback feature allows you to import IQ data from files that were captured from other instruments such as spectrum analyzers and oscilloscopes or you can connect to an instrument and capture the data directly.

---

**NOTE.** Import also supports other files created with other tools such as *MATLAB*.

---



The Capture and Playback feature is best suited for instruments with Sequencing enabled. Without Sequencing, you are limited to compiling Signals containing only one waveform.

From the Capture/Playback tab, you can:

- Create (Add) Signals (Signals are made up of one or more waveforms) by:
  - Importing individual I and Q waveform files together
  - Importing combined IQ waveform files
  - Adding IQ waveform files from the Waveform List
  - Acquiring live data from a connected instrument
- Compile baseband waveforms into RF
- Multiple waveforms can be compiled into sequences if Sequencing is enabled
- Adjust output carrier frequency and sampling rates
- Add and remove waveforms to/from Signals

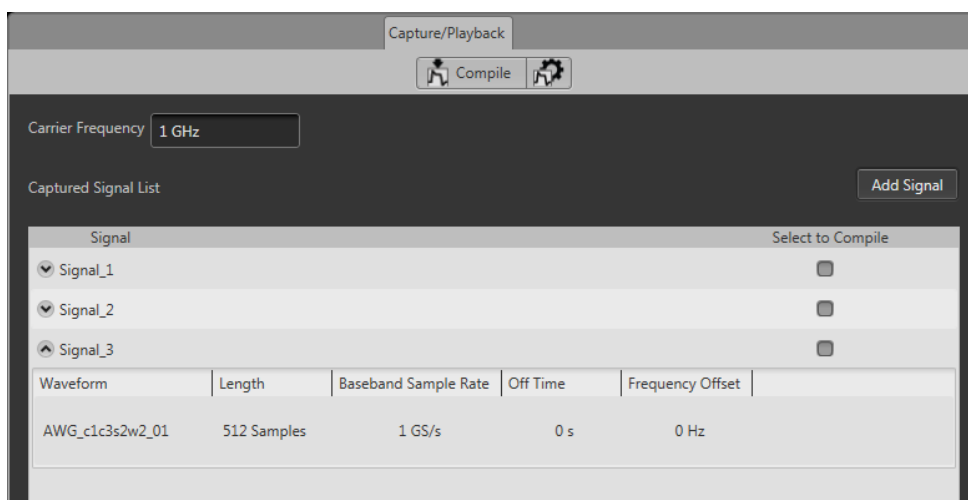

## Adding (importing) IQ data files

To playout an IQ waveform file, you first need to import or capture the waveform files and convert them into Signals that are added to the Capture/Playback screen.

Press the Add Signal button to display the dialog screen that allows you to add your IQ waveform files to create a Signal.

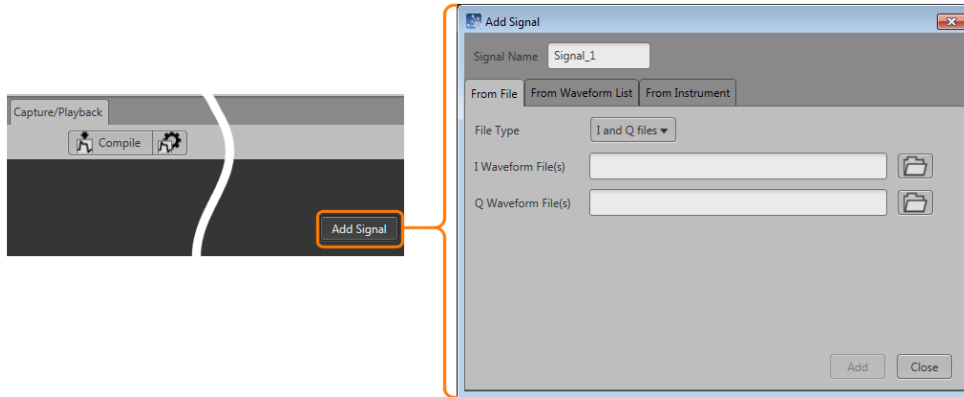

Refer to the following topics about adding/capturing I/Q signals.

- [Adding signals from files \(see page 115\)](#)
- [Adding signals from waveform list \(see page 117\)](#)
- [Capturing signals from instruments \(see page 118\)](#)

Once you've selected and added your file(s) from the Add Signal dialog screen, entries are made in the Captured Signal List. As shown in this example, several Signals have been added to the list.

Each signal in the Captured Signal List contains an icon to expand or collapse the signal, displaying the signal's contents (waveforms).

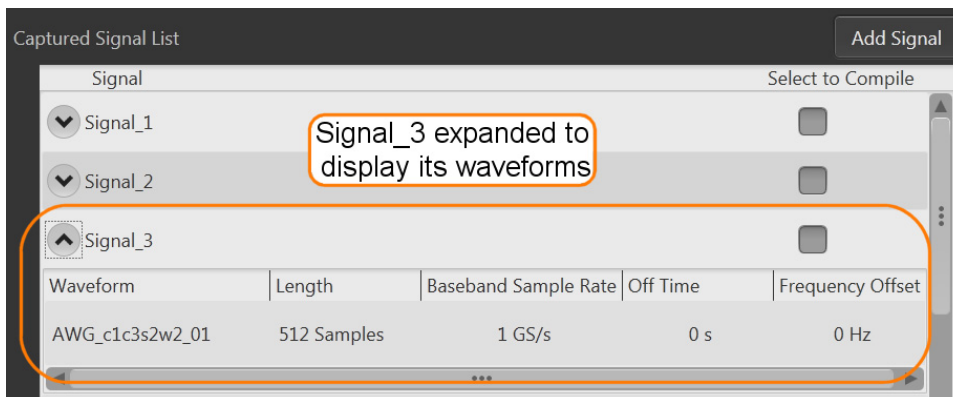

Once the initial Signal is created, you can edit the Signal by adding or removing waveforms and making adjustments to certain waveform parameters. See [Editing Signals \(see page 113\)](#).

## Removing Signals

To remove a Signal (or all Signals) from the Captured Signal List, move the cursor into the List area. Touch and hold (or right-mouse click) on a Signal name to display the menu selection to either remove a selected signal or remove all signals.

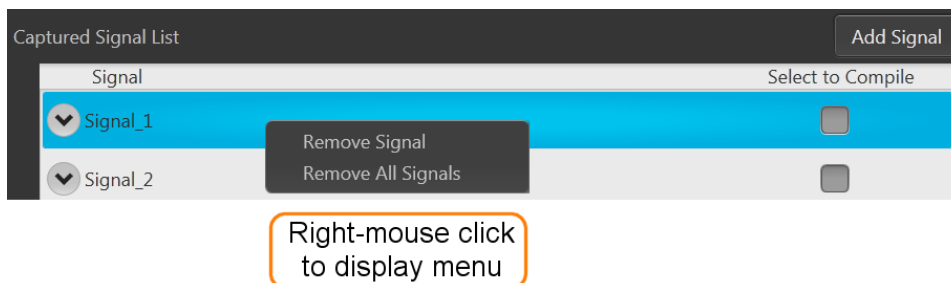

## Editing signals

Signals appearing in the Captured Signal List can be modified in various ways.

- Adding additional waveforms to the Signal
- Removing waveforms from the Signal
- Adjusting waveform parameters

### Adding and removing waveforms

When a Signal is created, it appears in the Captured Signal List. If you expand the signal (by pressing the expand icon ) , you'll see the waveform(s) contained in the Signal and their parameters.

With the Signal expanded, touch and hold (or right-mouse click) on the waveform name area to display the menu selection to either remove individually selected waveforms or remove all waveforms.

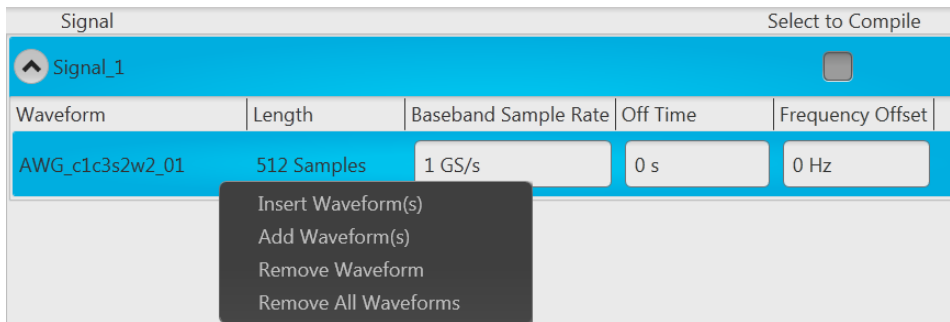

Item	Description
Insert Waveforms(s)	Use to insert additional waveforms to a Signal. Inserted waveforms are added before the first waveform in the Signal.
Add Waveforms(s)	Use to add additional waveforms to a Signal. Added waveforms are added after the last waveform in the Signal.
Remove Waveform and Remove All Waveforms	Use these selections to either remove the selected waveform or all waveforms from a Signal.

### Adjusting waveform parameters

Each waveform contained within a Signal has user adjustable parameters. These parameters are then used when compiling the waveforms. See the [Compile settings \(see page 122\)](#) for additional information about compiling.

With the Signal expanded, touch and hold (or right-mouse click) on one of the parameter areas to display the menu selection to set the parameters. You can also directly edit the parameters by placing the cursor within the parameter window.

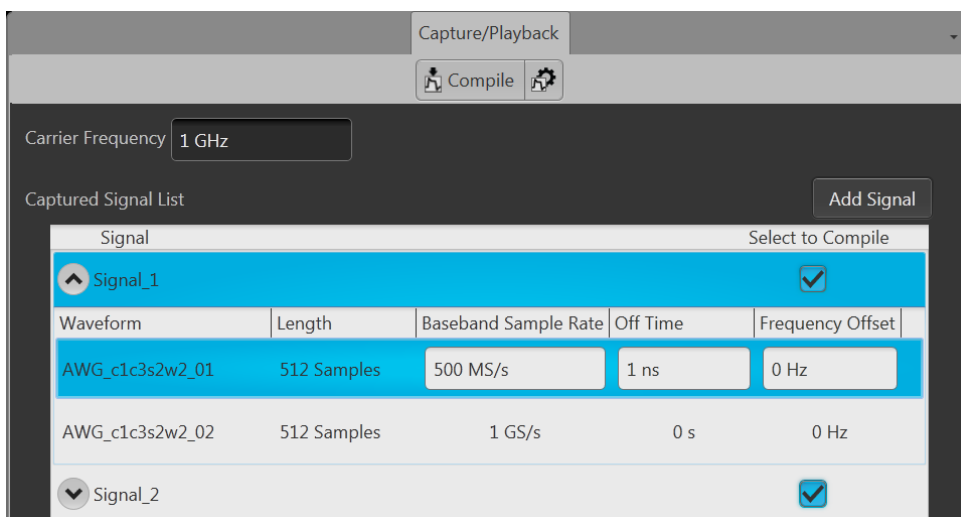

Item	Description
Carrier Frequency (affects all waveforms in all Signals)	Carrier Frequency is a global setting for all waveforms in all Signals. The carrier frequency is adjustable from 1 kHz to the maximum sampling rate of the instrument.
Baseband Sample Rate	The Baseband Sample Rate is initially read from the input waveform files (if included in the imported file). You can adjust the sampling rate, but the compiled waveform must meet the minimum <a href="#">waveform requirements</a> (see page 165).
Off Time	This ensures a specified amount of zero playout time occurs at the end of the selected waveform. This effectively creates a pulsed waveform.  <b>NOTE.</b> The compile process may add zero playout to the end of a waveform if the waveform doesn't meet the length requirement.
Frequency Offset	The Frequency Offset is an adjustment related to the set Carrier Frequency for the waveform.

## Adding signals from files

The Add Signal dialog screen allows you to navigate to your saved IQ waveforms, either the individual I and Q components or a combined IQ waveform, depending on the File Type selected.

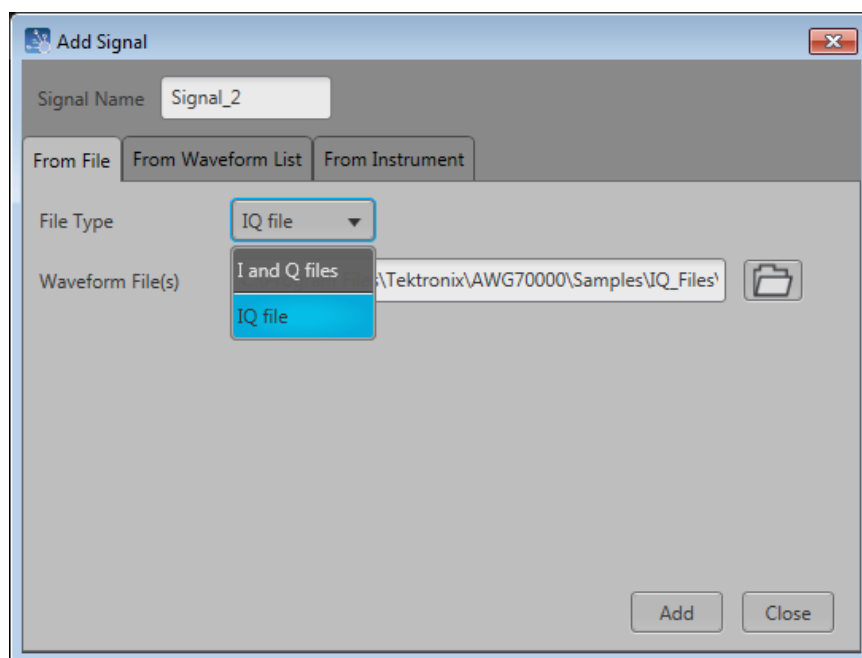

Item	Description
Signal Name	<p>This is the resulting name of the waveform when compiling the IQ waveforms.</p> <p>The default Signal Name uses "Signal" and the base name and increments the numerical digit each time a new signal is created.</p> <p>You can edit this field to create your own signal name, but subsequent creations always start with the base name of Signal.</p>
File Type	<p>Chose the type of source file to import.</p> <p><b>IQ file:</b> Imports a single file that contains both the I and Q data. File format extensions include .wfm, .txt, .rfd, and .mat.</p> <p><b>I and Q files:</b> Use this selection to import individual I and Q data files. During the import, the I and Q files are combined into a single waveform file.</p> <p>When importing individual I and Q files, marker data is obtained from the I file. File format extensions include .iqt, .tiq, .mat, .tmp, and .prm.</p>
 Browse	<p>Use the folder icon(s) to navigate to the location of your I and Q or IQ waveform files, depending on your File Type selection.</p> <p>When selecting files to add, you are able to select multiple files at a time. Note the following conditions:</p> <p><b>IQ file type:</b> When selecting combined IQ files, the imported files appear in the Signal in the order in which they appear in the Windows Open dialog box.</p> <p>IQ import recognizes these file types: .wfm, .iqt, .tiq, .mat, .tmp, .prm, .cdif.</p> <p><b>I and Q files:</b> When adding I and Q files, you can import a single set of files (1 I and 1 Q file) or you can import multiple I and Q files.</p> <p>I and Q files must always be imported as pairs.</p> <p>When selecting multiple I and Q files, the number of selected I files must match the number of selected Q files. Each I file and each Q file is combined into one waveform during import. The order in which the files appear in the Windows Open dialog box is very important because this will be the order that the files are combined and created.</p> <p>Marker data is obtained from the I file.</p> <p>I and Q import recognizes these file types: .wfm, .txt, .rfd, .mat.</p>

Once you select the waveform (or waveforms) and choose to add the waveform(s), you are presented with the [Importing Waveform](#) dialog screen to normalize (rescale) the waveforms as they are imported.

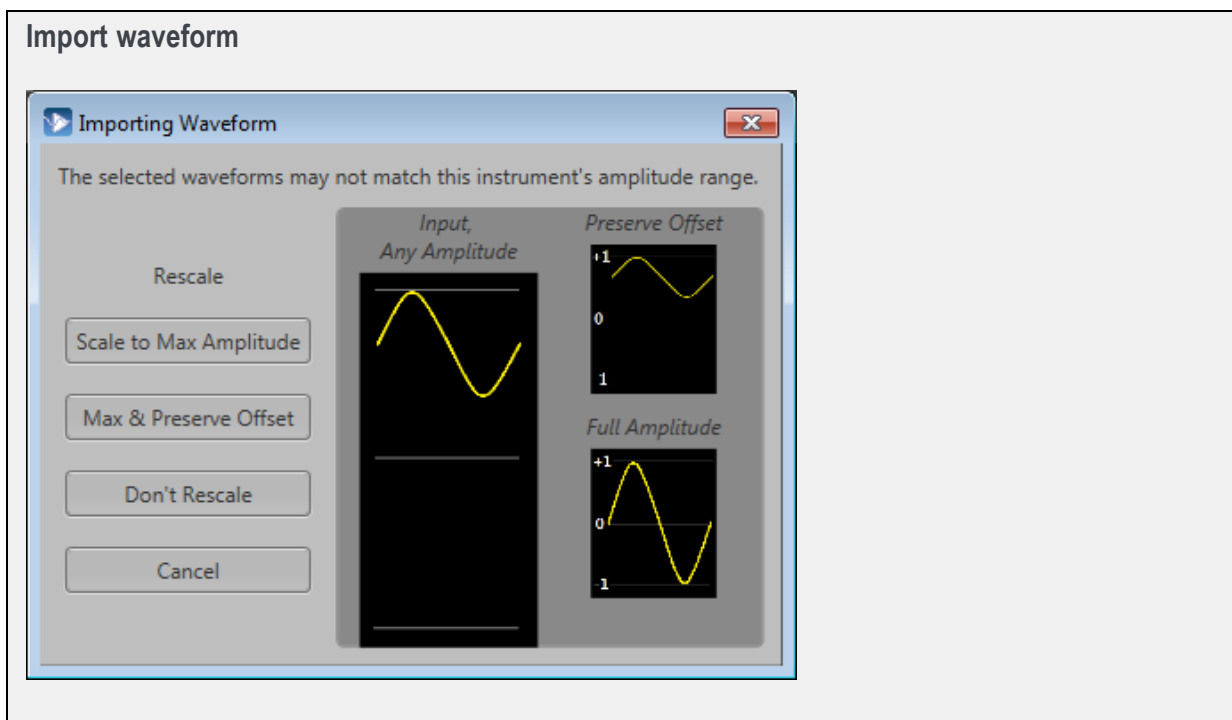

## Adding signals from waveform list

The Add Signal dialog screen allows you add IQ waveforms directly from the Waveform List.

When selecting the From Waveform List tab, the tab displays the available IQ waveforms to select.

---

**NOTE.** Only IQ waveforms are displayed.

---

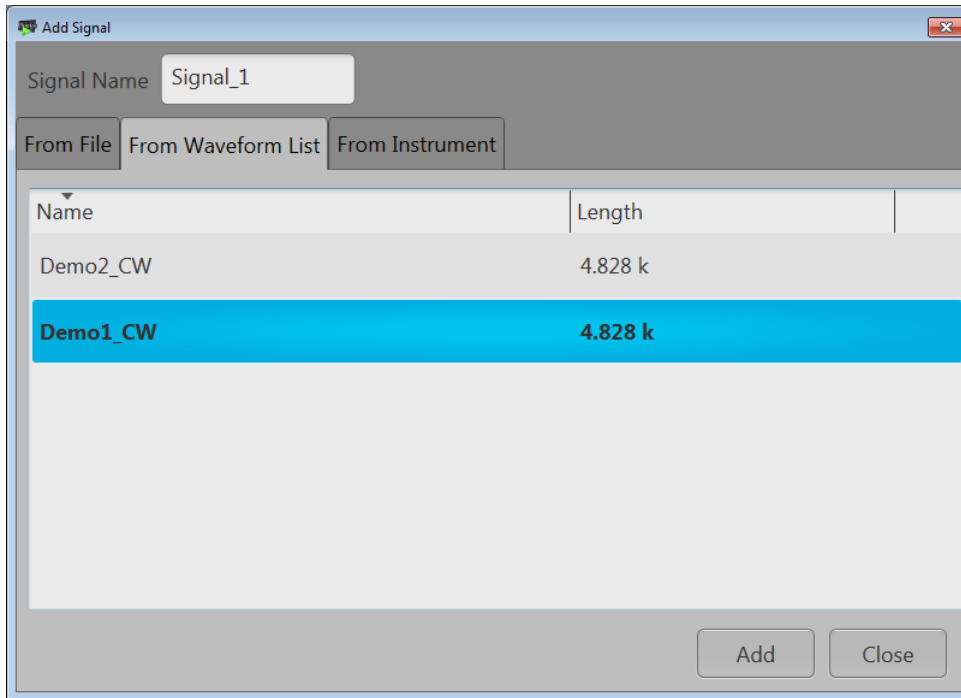

Select the IQ waveform you wish to add to the signal. Only one file can be selected at a time.

### Drag and drop

When using the From Waveform List tab, you can also drag and drop IQ waveforms onto existing signals or create new signals by dropping the file onto a blank area of the Captured Signal List.

The following actions occur, depending on where you drop the IQ waveform:

- Dropping an IQ waveform on an existing signal appends the waveform to the signal.
- Expanding an existing Signal and then dropping an IQ waveform on a waveform within the Signal inserts the IQ waveform in front of the waveform in the signal.
- Dropping an IQ waveform in the blank area of the Captured Signal List creates a new signal containing the IQ waveform.

## Capturing signals from instruments

With the AWG instrument connected to a computer network, you can connect to an oscilloscope or spectrum analyzer (on the same network) and capture I/Q data directly from the instrument.

The connectivity tab provides a window for you to enter the computer name (hostname) or IP address of a networked instrument you wish to connect to.



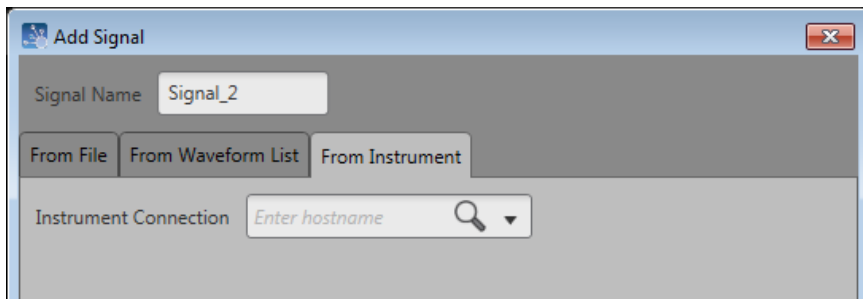

After entering the hostname or IP address, select the magnifying glass (or press Return) to initiate searching for the instrument. When the connection is established, the From Instrument tab expands to provide additional controls. The content of the tab changes depending on if you're connected to an oscilloscope or a spectrum analyzer.

To obtain the hostname or IP address of an instrument, go to the target instrument, select Computer > Properties and note the computer name or IP address.

- Oscilloscopes supported:
  - DPO70000 Series
  - MSO70000 Series
  - DPO70000SX Series
  - DPO7000 Series
- Spectrum Analyzers supported:
  - RSA5000 Series
  - RSA6000 Series

You can continue to connect to addition instruments using the Instrument Connection window. Use the pull-down list to view all available instruments. Select on any instrument in the list to make it the active connection and the source for importing data. The following example shows several connected instruments. Select the  next to any instrument name to disconnect.

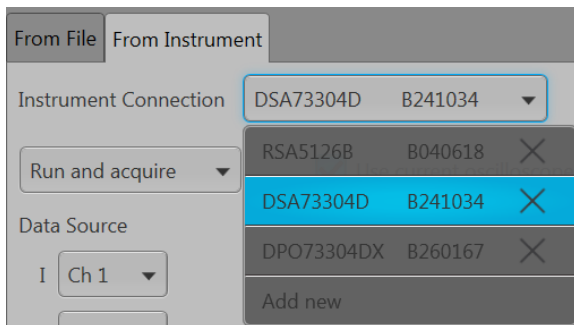

### Connecting to an oscilloscope

When connected to an oscilloscope, the From Instrument tab changes to include features and setting relevant to the oscilloscope. In the example shown, we've connected to a DPO73304SX instrument.

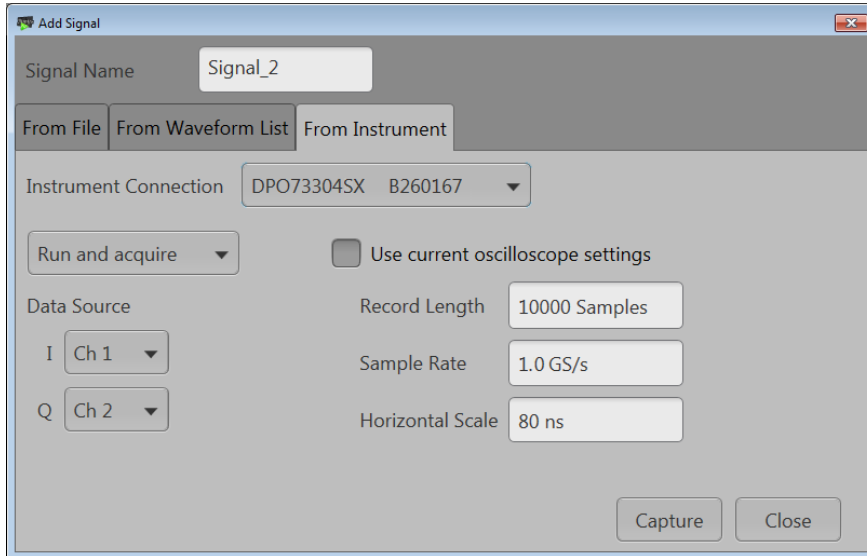

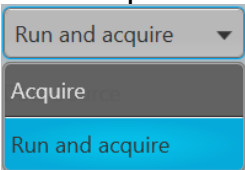
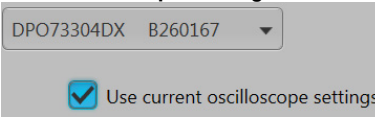
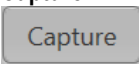
Item	Description
<p><b>Acquire and Run and acquire</b></p> 	<p><b>Acquire:</b> The waveform from the connected source is transferred to the AWG.</p> <p><b>Run and acquire:</b> The connected instrument is issued a single event run command. Once the acquisition is complete, the waveform is transferred to the AWG.</p>
<p><b>Use Oscilloscope Settings</b></p>  <p><input type="checkbox"/> Use current oscilloscope settings</p> <p>Record Length: 10000 Samples</p> <p>Sample Rate: 1.0 GS/s</p> <p>Horizontal Scale: 80 ns</p>	<p>By default, the Use Current Oscilloscope Settings is checked and the AWG does not adjust any oscilloscope parameters.</p> <p>If “Use Current Oscilloscope Settings” is checked, the oscilloscope parameters are used and the parameters settings are hidden from view.</p> <p>When unchecking the Use Current Oscilloscope Settings, you are presented with dialog boxes to set:</p> <ul style="list-style-type: none"> <li>• Record Length</li> <li>• Sample Rate</li> <li>• Horizontal Scale</li> </ul> <p>The initial values presented in the dialog boxes are the current oscilloscope settings. Changes made to the settings are immediately applied to the oscilloscope.</p>
<p><b>Capture</b></p> 	<p>Imports the data from the connected instrument and adds the signal it to the Captured Signal List.</p>

## Connecting to a spectrum analyzer

When connected to a spectrum analyzer, the From Instrument tab changes to include features and setting relevant to the analyzer. In the example here, we've connected to a RSA5126B spectrum analyzer.

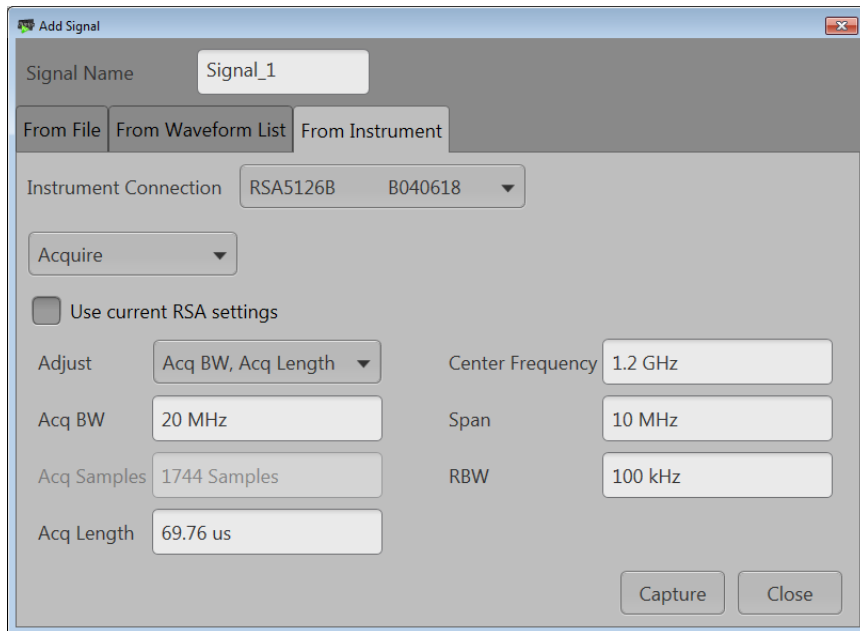

Item	Description
<p><b>Run and acquire</b></p>	<p><b>Acquire:</b> The waveform from the connected source is transferred to the AWG.</p> <p><b>Run and acquire:</b> The connected instrument is issued a single event run command. Once the acquisition is complete, the waveform is transferred to the AWG.</p>
<p><b>Use RSA Settings</b></p>	<p>By default, the Use Current RSA Settings is checked and the AWG does not adjust any analyzer parameters.</p> <p>If "Use Current RSA Settings" is checked, the RSA parameters are used and the parameter settings are hidden from view.</p>

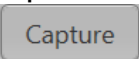
Item	Description
	<p>When unchecking the Use Current RSA Settings, you are presented with dialog boxes to set:</p> <ul style="list-style-type: none"> <li>• Acquisition Bandwidth</li> <li>• Acquisition Samples</li> <li>• Acquisition Length</li> <li>• Center Frequency</li> <li>• Span</li> <li>• RBW</li> </ul> <p>The initial values presented in the dialog boxes are the current RSA settings. Changes made to the settings are immediately applied to the analyzer.</p>
<p><b>Capture</b></p> 	<p>Imports the data from the connected instrument and adds the signal it to the Captured Signal List.</p>

## Compiling I/Q signals

The Signals listed in the Captured Signal List will be up-converted to user-defined carrier frequencies when compiled.

Use the Select to Compile check boxes to select the Signal (or Signals) you want to compile, and then click the Compile button.

Each waveform in each selected Signal is then compiled, based on the [waveform parameters \(see page 114\)](#) selected and the Capture & Playback [Compile Settings \(see page 122\)](#).

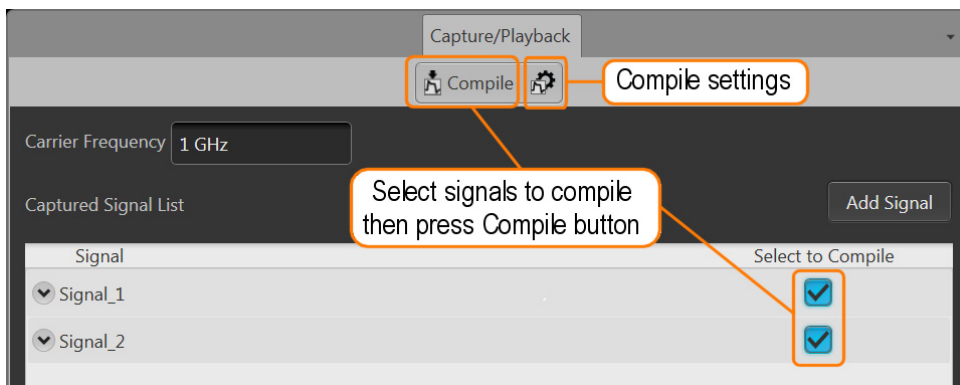

### Compile settings

The Capture and Playback compile settings dialog box lets you select the output sampling rate and the handling of the compiled waveforms and sequences.

These settings are used for all compilations of all selected Signals.

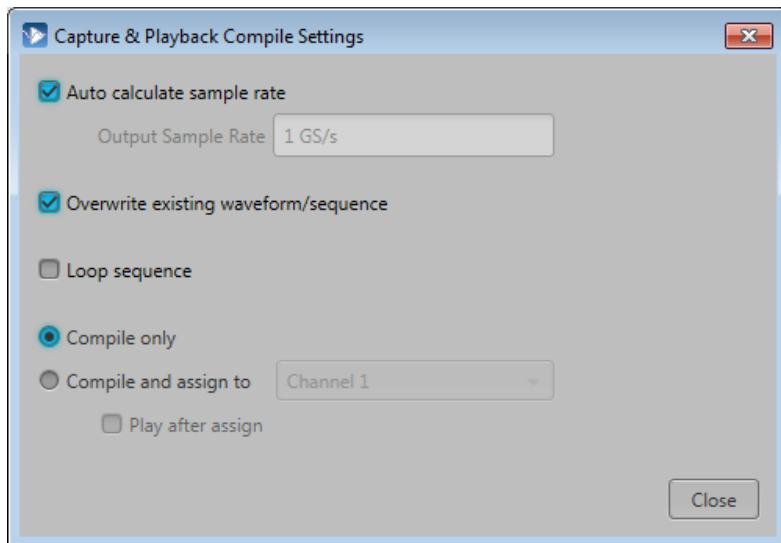

Item	Description
Auto calculate sample rate	Check this setting to allow the application to calculate the best output sample rate. The automatic setting is selected by default. If you uncheck this setting, you must enter a sample rate but the compiled waveform must meet the minimum <a href="#">waveform requirements (see page 165)</a>
Overwrite existing waveform/sequence	Check this setting to overwrite any preexisting waveforms or sequences with the same name. This is checked by default. If you uncheck this setting, the compile process fails if a duplicate name is encountered.
Loop sequence	Check this setting if you want the compiled sequence to loop on itself. This sets the GoTo parameter of last sequence step to the First step.
Compile only	With this selected, the compiled waveforms are entered into the Waveform List. If Sequencing (SEQ) is licensed, a sequence is created and entered into the Sequence List (in addition to entering the waveforms into the Waveform List). If the Waveform List or Sequence List is closed or not in focus, the tabs flash, indicating waveforms or sequences are being added.

Item	Description
Compile and assign to	<p>With this selected, the compile process runs as above, but the waveform or sequence is assigned to the selected channel.</p> <p>If Sequencing (SEQ) is licensed, the sequence is assigned to the channel. If Sequencing is not licensed, the single compiled waveform is assigned to the channel.</p> <p>If the Waveform List or Sequence List is closed or not in focus, the tabs flash, indicating waveforms or sequences are being added.</p>
Play after assign	When "Compile and assign to" is selected, you can set the waveform or sequence to start playout immediately.

## Waveform plug-ins introduction

The [Waveform Plug-ins tab](#) provides access to the available waveform creation plug-in applications. Three plug-ins are provided as a standard plug-ins. As other waveform creation plug-ins are installed, they are added to the Plug-ins pull-down list.

Waveform plug-ins allows you to quickly create and edit various types of waveforms for use. The plug-in list continues to grow as you install new plug-ins. Any waveforms created with a plug-in can be saved for reuse or for additional editing at a later time.

Optional plug-ins appearing in the pull-down list have their own help systems.

---

**NOTE.** *Waveforms created (compiled) using a Waveform plug-in are placed in the Waveforms list. Use the Waveforms list to save or edit waveforms created by a plug-in.*

---

The standard plug-ins available include:

- [Basic Waveform \(see page 125\)](#)
- [Equation editor \(see page 128\)](#)
- [Table editor \(see page 160\)](#)

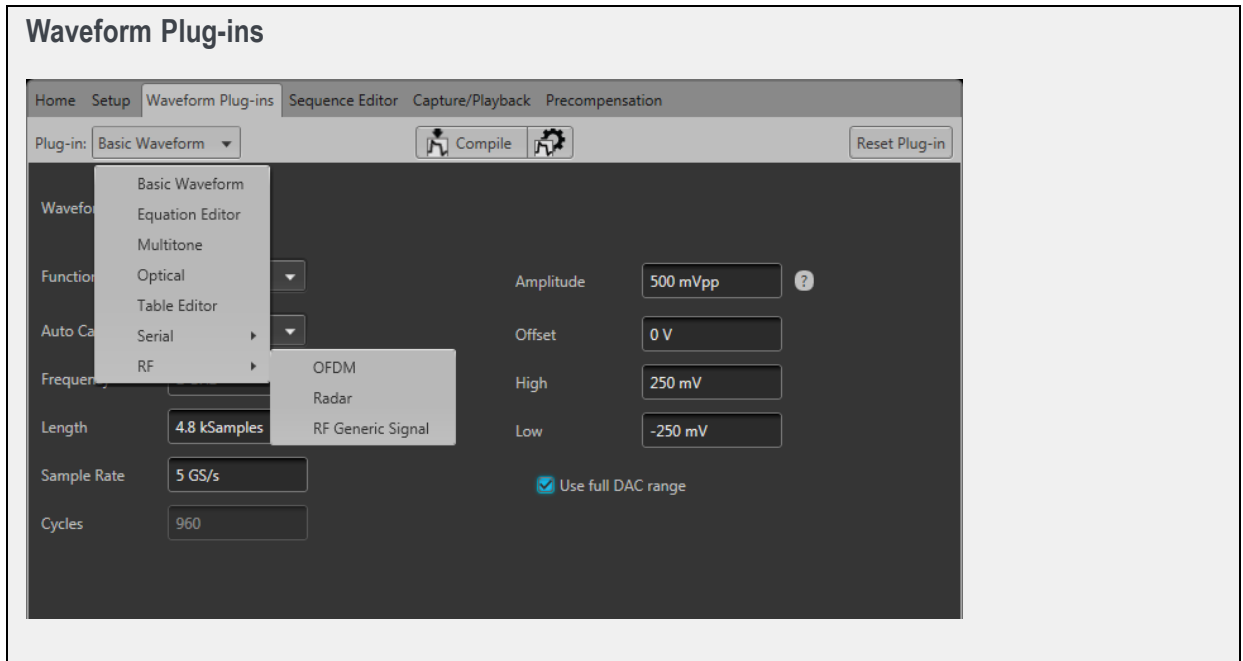

## Basic waveform

The Basic Waveform application is provided as a standard plug-in.

This plug-in provides a method to quickly and easily create simple waveforms such as sine waves, square waves, and others. The compiled waveforms are placed in the Waveforms tab.

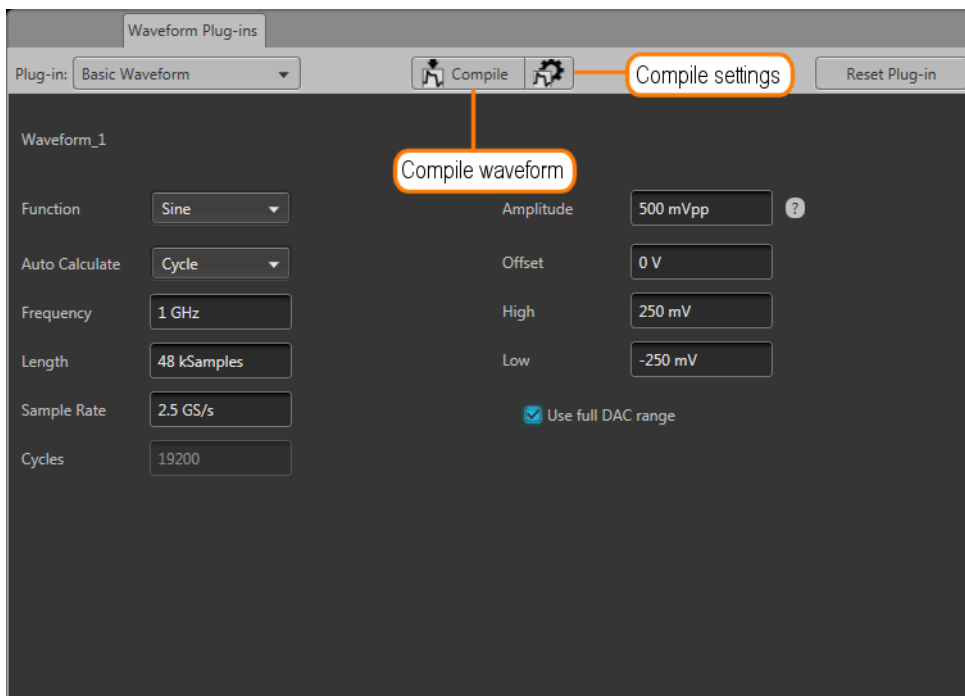

Item	Description
Plug-in:	Select Basic Waveform. Other plug-ins installed appear in the pull-down list but are not described here.
Compile	Use the compile button to create the new or modified waveform. How the waveform is named and the actions taken are controlled in the Compile Settings dialog screen. If the Waveforms list is closed or not in focus, the Waveforms tab flashes, indicating waveforms are being added.
Compile Settings	Use the Compile Settings parameters to set the actions taken each time you press the Compile button.

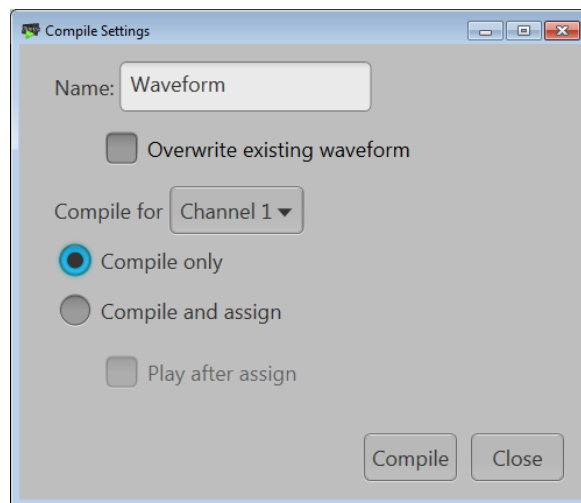

**Name:** Enter a name for the compiled waveform. If the name already exists in the Waveform List, the name is appended with an underscore suffix such as “Waveform\_1”.

**Overwrite existing waveform:** If checked, waveforms in the Waveform List are overwritten without warning. This selection is particularly useful to modify existing waveforms without creating new waveforms.

**Compile for:** Select the playout channel intended for the compiled waveform. The channel selection is also used to set the amplitude and offset range. Multi-channel instruments may have differing channel output capabilities. This is the channel used when **Compile and assign** is selected.

**Compile only:** Creates the waveform and places it in the Waveform List.

**Compile and assign:** Creates the waveform, places it in the Waveform List, and assigns it to the channel selected with the **Compile for** selection.

**Play after assign:** When checked, automatically loads the waveform and starts the waveform playout.

When waveforms are compiled, they are placed in the Waveform List, but are not saved to the hard drive. To save to the hard drive, save the waveform from the Waveform List.

Reset Plug-in	Returns Basic Waveform plug-in settings to their default values. This control affects only the Basic Waveform plug-in application. This instrument application settings are not affected.
---------------	--



Item	Description
Function	Choose the type of waveform to create. Selections include: Sine wave, Square wave, Triangle, Ramp, Noise, DC.
Auto Calculate	Choose one of the waveform properties that you want the instrument to calculate (based on the other waveform properties). Only one property can be automatically calculated. The chosen property to calculate is grayed out and cannot be edited.
Frequency	Set the waveform frequency. The available range is dependent on the instrument model and installed options. The available frequency range is also affected by the Length and Sampling Rate settings.
Length (Advanced)	Determines the length (size) of the waveform. The minimum and maximum waveform length is dependent on the instrument model and installed options. The Length is affected by the Frequency and Sample Rate and settings.
Sample Rate	Sets the suggested sampling rate of the waveform. The minimum and maximum sampling rate is dependent on the instrument model and installed options. The sampling rate is affected by the Frequency and Length and settings.
Cycles	Sets the number of times the waveform will repeat.
Amplitude	Defines the peak-to-peak amplitude of the waveform. Changing the amplitude causes the instrument to recalculate the High and Low values. With a 0 V Offset, the High and Low values are one half the amplitude.
Offset	Defines the offset value (center) of the waveform. Changing the offset value causes the High and Low values to change to accommodate the difference, but the total amplitude is not affected. This limits the amount of offset that can be applied.

Item	Description
High and Low	<p>Defines High and Low values of the waveform amplitude.</p> <p>The High and Low values are initially one half the amplitude of the waveform (with an offset of 0 V). Changing these values causes the Amplitude value to adjust.</p> <p>Changing the High and Low to uneven values cause a change to the Offset value.</p>
Use full DAC range	<p>Using the full DAC range when compiling waveforms results in waveforms with the best resolution. This feature is enabled by default.</p> <p>When enabled:</p> <p>If the selected offset and amplitude are within the range of the instrument's hardware, then the compiled waveform is compiled using the full DAC range and the compiled waveform's recommended amplitude and offset properties are set to the requested amplitude and offset values.</p> <p>If the selected offset and amplitude will result in a compiled waveform that does not take advantage of the full DAC range, the instrument adjusts the compiled waveform's recommended amplitude and offset values to use the full DAC range.</p> <p>If the system cannot achieve the full DAC range, a warning message is displayed.</p> <p>When disabled:</p> <p>The waveform is compiled using the specified amplitude and offset values and the compiled waveform's recommended amplitude is set to the maximum value and the recommended offset is set to 0.</p> <p>The control is not available for a DC waveform.</p>

## Equation editor overview

The Equation editor is provided as a standard plug-in.

The Equation editor is an ASCII text editor that allows you to create, edit, load, and compile equation waveform definitions into a waveform using the Waveform Programming Language (WPL). Use WPL to generate a waveform from a mathematical function, perform calculations between two or more waveform files, and use loop and conditional branch commands to generate waveform values.

Compile the equation file to generate the described waveforms and sequences and place them into the Waveforms List and Sequence List.

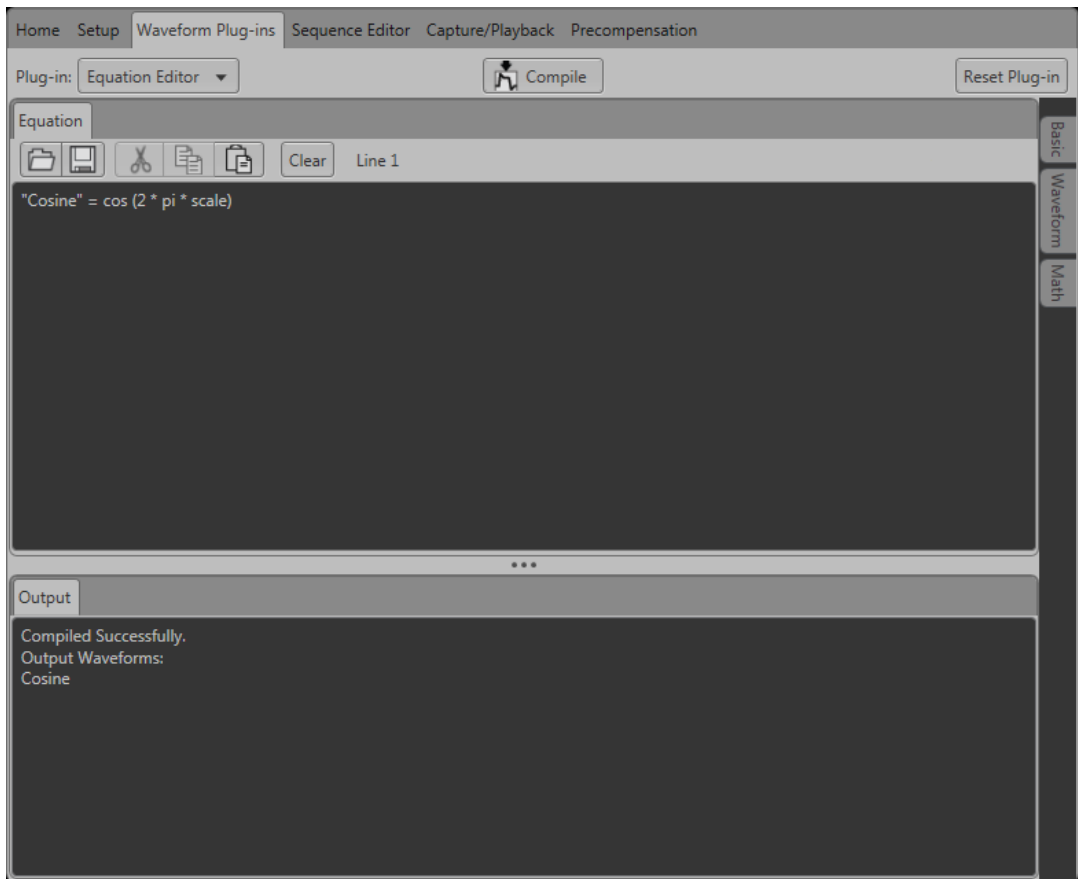

Item	Description
Toolbar	Provides edit operations, such as open, save, cut, copy, paste, and clear. The Line position shows the cursor position in the equation.
Equation editor window	Use this area to enter text and/or equation information.
Output window	Displays the compile results. If the compilation fails, an error message is displayed. It also displays the list of waveform and sequence files created after successful compilation.
Compile	Compiles the currently loaded equation file. The status of the compilation is displayed in the output window. Generated waveforms and sequences are placed into the Waveforms List and Sequence List.
Basic tab	Opens a window that provides basic keywords to use while constructing an equation.
Waveform tab	Opens a window that provides waveform functions to use while constructing an equation.
Math tab	Opens a window that provides math functions to use while constructing an equation.

See also:

- [Basic keywords \(see page 132\)](#)
- [Waveform functions \(see page 133\)](#)
- [Math functions \(see page 149\)](#)
- [Math operators \(see page 150\)](#)
- [Equation examples \(see page 151\)](#)

## Limitations

The limitations of the Waveform Programming Language are as follows:

- The Equation editor allows you to open and compile equation files (.equ) that are compatible with the AWG400/500/600/700/5000/7000 series instruments.
- The compiler can support equation files with a maximum of 10,000 lines or 800,000 characters.
- References to a waveform file in an equation file should be created by the equation file or exist before the equation file is compiled. (The equation file cannot refer to anything other than waveforms created by the equation file or existing waveform files.)
- The .wfm or .wfm extension is optional on the left side of an assignment operator. If omitted, the file will still be created without an extension and automatically imported into the waveform list.
- Compilation is dependent on the available memory and other resources of the instrument, such as model and instrument options.

## Tips on using the equation editor

- Waveform names
  - Waveform names use double quotes.
  - Waveform names are not required to begin with an alphabetical character (unlike variables).
  - Waveform names are case sensitive.
  - Waveform names may contain underscores(\_) and dashes(-).
  - Waveform names can be a concatenation of strings using a colon (:).
  - The maximum number of characters is 256 which includes any extension that will be ignored.

---

**NOTE.** *When creating a file, it's best practice to ensure the filename does not already exist by placing a Delete "filename" in the equation prior to the creation of the file. This ensures the equation creates a new file rather than appending to an existing file.*

---

- Equations
  - An equation script (ES) has one or more statements and/or waveform operations.
  - The compiler is an interpretive implementation and does each statement sequentially.
  - Each statement is evaluated from left to right.
  - Any error terminates the compile. No statements after the error are executed.
- Statements
  - A statement has a identifier, assignment and an expression.
  - All spaces, line feeds and tabs are ignored unless inside a string.
  - All text from a single quote (‘) to the end of a line is regarded as a comment.
- Variables
  - The first character must be an alphabetical character.
  - Alphabetical characters are case-insensitive.
  - User-defined variables do not need to be declared before using them.
  - User-defined variables are 64-bit floating-point decimal numbers.
  - User-defined variables initial values are undefined.
  - A maximum of 100 variables may be included in a program
- Paths
  - Files can have the full path or they can reference the working path which is “C:\ProgramData\Tektronix\AWG\AWG70k\EquationEditor”.
  - Relative paths in the equation editor syntax must include a “.” or “..”.

- Markers
  - Markers do not have names but are an extension of a waveform in the form of a “.markerN” where “N” is the marker name such as “.marker1”.
  - The marker extension is not case sensitive like waveform names are.
  - Markers can be assigned in a statement in which every point for a marker will be evaluated for every point in the analog set of points.
- Assignment
  - The assignment is a single equal sign “=”. In a statement that has more than one “=”, going from left to right, the first “=” is an assignment, all others to the right are treated as a “Boolean relational operation”.

## Basic keywords

The Equation editor has built-in keywords and functions to easily create equations. These commands insert correctly-formatted keywords or functions into the text file at the current cursor position. Inserted keywords are treated as ordinary text if you need to edit them.

The basic keywords are grouped into two types, predefined variables and control statements.

The following table lists the predefined variables that you can use as part of a waveform equation expression.

Item	Description
clock	Sets the current instrument sample clock rate.
size	Sets the current waveform record length.
time	Current data time value, starting at 0. Read only. Only useable within an equation expression.
point	Current data point number value, starting at 0. Read only. Only useable within an equation expression.
scale	Returns the current scale value that increase 0 to 1. Read only. Only useable within an equation expression.
pi	The number pi ( $\pi$ ). Use the pi character from the symbol list.

The following table lists the control statements that you can use as part of a waveform equation expression.

Item	Description
if	Provides control statements to execute expressions when a condition resolves to true or false.
then	Provides control statements to execute expressions when a condition resolves to true or false.
else	Provides control statements to execute expressions when a condition resolves to true or false.
endif	Defines the end of the if statement.
for	Provides a structure for executing one or more equation expressions a defined number of times.
next	Provides control statements to execute expressions when a condition resolves to false.

Item	Description
step	Defines the size of the loop count increments.
to	Defines the upper limit of the loop count increment.

## Waveform functions

The waveform functions are listed as follows:

### bpf

The bpf statement creates a new waveform file by passing the specified waveform file through a band-pass filter.

**Syntax** "output\_filename" = bpf("filename1", cutoff\_freq\_lo, cutoff\_freq\_hi, taps, atten)

**Arguments** "output\_filename" is the complete file name (file name and extension) to contain the filtered waveform data. The argument can include a relative or absolute path name. Enclose the file name within double quotation marks.

"filename1" is the complete (file name and extension) name of the source file for the band-pass filter operation. The file must be on the active drive. The argument can include a relative or an absolute path name. Enclose the file name within double quotation marks.

cutoff\_freq\_lo is the band-pass filter low-frequency cutoff value. Enter the value as a real or scientific notation number or as an expression that resolves to a valid number.

cutoff\_freq\_hi is the band-pass filter high-frequency cutoff value. Enter the value as a real or scientific notation number or as an expression that resolves to a valid number.

taps is the number of delay elements that composes the digital filter. The range of taps is 3 to 101. Enter the integer value as an odd number.

atten is the inhibit zone attenuation factor (in dB). The range of attenuation is 21 dB to 100 dB. Enter the integer value.

**Example** "filtered.wfm" = bpf("sine.wfm", 3.0e6, 5.0e6, 101, 35)

### brf

The brf statement creates a new waveform file by passing the specified waveform file through a band-rejection filter.

**Arguments** "output\_filename" is the complete file name (file name and extension) to contain the filtered waveform data. The argument can include a relative or absolute path name. Enclose the file name within double quotation marks.

"filename1" is the complete (file name and extension) name of the source file for the band-pass filter operation. The file must be on the active drive. The argument can include a relative or absolute path name. Enclose the file name within double quotation marks.

cutoff\_freq\_lo is the band-reject filter low-frequency cutoff value. Enter the value as a real or scientific notation number or as an expression that resolves to a valid number.

cutoff\_freq\_hi is the band-reject filter high-frequency cutoff value. Enter the value as a real or scientific notation number or as an expression that resolves to a valid number.

taps is the number of delay elements that composes the digital filter. The range of taps is 3 to 101. Enter the integer value as an odd number.

atten is the inhibit zone attenuation factor (in dB). The range of attenuation is 21 dB to 100 dB. Enter the integer value.

**Example** "filtered.wfm" = brf("sine.wfm", 3.0e6, 5.0e6, 101, 45)

**code**

The code statement executes code conversion from a source waveform containing digital or analog information to another digital waveform. For example, it converts a file to one of several digital formats, such as, NRZ, RZ, or Manchester codes. All marker values in the output file are set to 0. Refer to [Code conversion \(see page 141\)](#).

<b>Syntax</b>	<code>"output_filename" = code("filename1", "code-conversion-table")</code>
<b>Arguments</b>	<p>"output_filename" is the complete file name (file name and extension) to contain the code-converted waveform data. The argument can include a relative or absolute path name. Enclose the file name within double quotation marks.</p> <p>"filename1" is the complete (file name and extension) name of the source file for the code conversion operation. The file is 0 1 pattern data. If the file is an analog waveform file, this function reads as 1 if the data value is equal to or larger than 0.5, and 0 if the value is less than 0.5. The argument can include a relative or absolute path name. Enclose the file name within double quotation marks.</p> <p>"code-conversion-table" is the text file containing a code conversion table in text form. Use the files that are saved with the Code Conversion table in the waveform or pattern editor. You can also create those text files, each line of which is composed of the following five fields delimited by comma (,):</p> <p style="padding-left: 40px;">Past source, Current source, Next source, Past output, Output code</p> <p>Refer to <a href="#">Code Conversion (see page 141)</a>.</p>
<b>Example</b>	<code>"C1.wfm" = code("C0.wfm", "nrz.txt")</code>

**conv**

The conv statement executes convolution between the waveform data of two specified files. All marker values in the output file are set to 0.

Refer to [Convolution \(see page 148\)](#) for additional information.

<b>Syntax</b>	<code>"output_filename" = conv("filename1", "filename2")</code>
<b>Arguments</b>	<p>"output_filename" is the complete file name (file name and extension) to contain the resultant convolution waveform. The argument can include a relative or absolute path name. Enclose the file name within double quotation marks.</p> <p>"filename1" and "filename2" are the complete (file name and extension) names of the source files for the convolution operation. Both files must be on the active drive. The argument can include a relative or absolute path name. Enclose each file name within double quotation marks.</p>
<b>Example</b>	<code>"newsine.wfm" = conv("sine.wfm", "sine2x.wfm")</code>

**copy**

The copy statement copies the specified file name to a new file name and/or location on the current drive.

<b>Syntax</b>	<code>copy("source_file", "target_file")</code>
<b>Arguments</b>	<p>"source_file" is the complete file name (path, file name and extension) to the file that you want to copy. The file must be located on the active drive. The argument can include a relative or absolute path name. Enclose the file name within double quotation marks.</p> <p>"target_file" is the complete file name (path, file name and extension) to the location to which you are copying the source file. The target file must be located on the active drive. The argument can include a relative or absolute path name. Enclose the file name within double quotation marks.</p>
<b>Example</b>	<code>copy("sine.wfm", "/test_dir/sine2.wfm")</code>



**corr**

The corr statement executes correlation between the waveform data of two specified files. All marker values in the output file are set to 0. There are no restrictions on the data lengths of the two waveforms.

Refer to [Correlation \(see page 139\)](#) for more information.

**Syntax** "output\_filename" = corr("filename1", "filename2")

**Arguments** "output\_filename" is the complete file name (file name and extension) to contain the resultant correlation waveform. The argument can include a relative or absolute path name. Enclose the file name within double quotation marks.

"filename1" and "filename2" are the complete (file name and extension) names of the files on which you are performing the correlation. Both files must be on the active drive. The argument can include a relative or absolute path name. Enclose each file name within double quotation marks.

**Example** "newsine.wfm" = conv("sine.wfm", "sine2x.wfm")

**data**

The data statement writes the defined data points to the specified file. The number of <expression>s specified must equal the number of points. All marker values will be 0. At least one <expression> must be included.

**Syntax** "output\_filename" = data(data\_defn, data\_defn, ...)

**Arguments** "output\_filename" is the complete file name (file name and extension) to contain the expanded waveform and marker data. The argument can include a relative or absolute path name. Enclose the file name within double quotation marks.

data\_defn is a value that defines the data point value. The first data point value starts at point 0 in the resulting waveform. You must include at least one data definition expression. Separate each definition with a comma.

**NOTE.** Use this command to create a waveform file that does not meet the instrument waveform minimum data requirement. If you create such a file, open it in a waveform editor, and then attempt to save it, the instrument displays a dialog box asking you to correct the problem. If you attempt to load the waveform in the Setup screen, the instrument displays an error message stating that the file does not have enough data points.

**Example** "foo.wfm" = data(1, 0, .2, .4, .5)

**delete**

The delete statement deletes the specified file name from the current drive.

**Syntax** delete("filename")

**Arguments** "filename" is the complete file name (path, file name and extension) to the file that you want to delete. The file must be located on the active drive. The argument can include a relative or absolute path name. Enclose the file name within double quotation marks.

**Example** delete("/test\_dir/wvfrms/sine2x.wfm")

**diff**

The diff statement performs a differentiation operation on a specified file. The output file retains all marker values of the input file. Refer to [Differentiation \(see page 145\)](#) for information about the differentiation algorithm.

**Syntax** "output\_filename" = diff("filename")

**diff**

---

<b>Arguments</b>	"output_filename" is the complete file name (file name and extension) to contain the resultant waveform. The argument can include a relative or absolute path name. Enclose the file name within double quotation marks.  "filename" is the complete (file name and extension) name of the file on which you are performing the differentiation operation. The file must be on the active drive. The argument can include a relative or absolute path name. Enclose the file name within double quotation marks.
------------------	--

---

**Example** "diffwave.wfm" = diff("log\_swp.wfm")

---

**expand**

The expand statement horizontally expands (scales) the waveform and marker data of the specified waveform file and writes it to a new file.

---

**Syntax** "output\_filename" = expand("filename", expand\_multiplier)

---

<b>Arguments</b>	"output_filename" is the complete file name (file name and extension) to contain the expanded waveform and marker data. The argument can include a relative or absolute path name. Enclose the file name within double quotation marks.  "filename" is the complete (file name and extension) name of the file on which you are performing the expand operation. The file must be on the active drive. The argument can include a relative or absolute path name. Enclose the file name within double quotation marks.  expand_multiplier is an integer value specifying how much to expand the waveform data. The value must be greater than one. Values less than or equal to one result in the output waveform being the same as the input waveform.
------------------	---

---

**Example** "longswp.wfm" = expand("lin\_swp.wfm", 2)

---

**extract**

The extract statement extracts the specified portion of a waveform file and writes it to a new file. The marker data is also extracted. Specify the start and end points to extract the data. Waveform data starts at point 0.

---

**Syntax** "output\_filename" = extract("filename", start\_point, end\_point)

---

<b>Arguments</b>	"output_filename" is the complete file name (file name and extension) to contain the extracted waveform and marker data. The argument can include a relative or absolute path name. Enclose the file name within double quotation marks.  "filename" is the complete (file name and extension) name of the source file for the extract operation. The file must be on the active drive. The argument can include a relative or absolute path name. Enclose the file name within double quotation marks.  start_point is the location of the first data point to extract from the input file. This is an integer value. The starting point value must be less than or equal to the ending point value or an error occurs during compilation.  end_point is the location of the last data point to extract from the input file. This is an integer value. The ending point value must be greater than or equal to the starting point value or an error occurs during compilation.
------------------	---

---

**NOTE.** Use this command to create a waveform file that does not meet the instrument waveform minimum data requirement. If you create such a file, open it in a waveform editor, and then attempt to save it, the instrument displays a dialog box asking you to correct the problem. If you attempt to load the waveform in the Setup screen, the instrument displays an error message stating that the file does not have enough data points.

---

**Example** "shortsin.wfm" = extract("sine.wfm", 0, 511)

---

**hpf**

The hpf statement creates a new file by passing the specified waveform file through a high-pass filter.

**Syntax** "output\_filename" = hpf("filename1", cutoff\_freq, taps, atten)

**Arguments** "output\_filename" is the complete file name (file name and extension) to contain the filtered waveform data. The argument can include a relative or absolute path name. Enclose the file name within double quotation marks.

"filename1" is the complete (file name and extension) name of the source file for the high-pass filter operation. The file must be on the active drive. The argument can include a relative or absolute path name. Enclose the file name within double quotation marks.

cutoff\_freq is the high-pass filter cutoff frequency. Enter the value as a real or scientific notation number or as an expression that resolves to a valid number.

taps is the number of delay elements that composes the digital filter. The range of taps is 3 to 101. Enter the integer value as an odd number.

atten is the inhibit zone attenuation factor, in dB. The range of attenuation is 21 dB to 100 dB. Enter the integer value.

**Example** "filtered.wfm" = hpf("sine.wfm", 3.25e5, 2, 25)

**integ**

The integ statement performs an integration operation on a specified file. The output file retains all marker values of the input file. Refer to [Integration \(see page 147\)](#) for information about the integration algorithm.

**Syntax** "output\_filename" = integ("filename")

**Arguments** "output\_filename" is the complete file name (file name and extension) to contain the resultant waveform and marker data. The argument can include a relative or absolute path name. Enclose the file name within double quotation marks.

"filename" is the complete name (path, file name and extension) of the source file for the integration operation. The file must be on the active drive. The argument can include a relative or absolute path name. Enclose the file name within double quotation marks.

**Example** "intwave.wfm" = integ("sineswp.wfm")

**join**

The join statement joins (concatenates) two waveform files (waveform and marker data) into a single file. The clock sample rate in the first file sets the clock sample rate for the output file waveform. You can only concatenate waveform (.wfm) files. The output file retains all marker values of the input file. Marker data is embedded in the waveform data as the ninth and tenth bits in an 8-bit waveform.

**Syntax** "output\_filename" = join("filename1", "filename2")

**Arguments** "output\_filename" is the complete file name (file name and extension) to contain the concatenated files. The argument can include a relative or absolute path name. Enclose the file name within double quotation marks.

"filename1" and "filename2" are the complete names (path, file name, and extension) of the files you are concatenating. Both files must be on the active drive. The argument can include a relative or absolute path name. Enclose each file name within double quotation marks.

**Example** "newsine.wfm" = join("sine.wfm", sine2.wfm")

**lpf**

The lpf statement creates a new file by passing the specified waveform file through a low pass filter.

**Syntax** "output\_filename" = lpf("filename1", cutoff\_freq, taps, atten)

**lpf**

**Arguments** "output\_filename" is the complete file name (file name and extension) to contain the filtered waveform data. The argument can include a relative or absolute path name. Enclose the file name within double quotation marks.

"filename1" is the complete (file name and extension) name of the source file for the low pass filter operation. The file must be on the active drive. The argument can include a relative or absolute path name. Enclose the file name within double quotation marks.

cutoff\_freq is the low pass filter cutoff frequency. Enter the integer value.

taps is the number of delay elements that composes the digital filter. The range of taps is 3 to 101. You must enter the integer value as an odd number.

atten is the inhibit zone attenuation factor, in dB. The range of attenuation is 21 dB to 100 dB. Enter the integer value.

**Example** "filtered.wfm" = lpf("sine.wfm", 10.454e2, 2, 30)

**norm**

The norm statement performs a normalization operation on a specified file waveform data. Normalization scales the waveform within a  $\pm 1.0$  range, and retaining the offset. The output file retains all marker values of the input file.

**Syntax** "output\_filename" = norm("filename1")

**Arguments** "output\_filename" is the complete file name (file name and extension) to contain the resultant waveform. The argument can include a relative or absolute path name. Enclose the file name within double quotation marks.

"filename1" is the complete (file name and extension) name of the file on which you are performing the normalization operation. The file must be on the active drive. The argument can include a relative or absolute path name. Enclose the file name within double quotation marks.

**Example** "intwave.wfm" = norm("sineswp.wfm")

**pn**

The pn statement creates a pseudo-random waveform using a shift register. You can specify the register size (1 to 32) and XOR feedback tap position. The initial values of the registers are set to one. If you omit the tap position specifier, a default maximum data length tap setting is used.

**Syntax** "output\_filename" = pn(reg\_size [, tap\_position ...])

**Arguments** "output\_filename" is the complete file name (file name and extension) to contain the pseudo-random waveform. The argument can include a relative or absolute path name. Enclose the file name within double quotation marks.

reg\_size specifies the number of registers in the pseudo-random generator. This is an integer value from 1 to 32.

tap\_position specifies the register positions to 'tap' for XOR feedback to the register input. A tap does an XOR operation on the output signal and the specified register and passes the result to the next-lower tap position or the register input (register 1), whichever it encounters first.

**Example** "random.wfm" = pn(12, 3, 6, 8)

**rename**

The rename statement renames the specified file name to a new file name and/or location on the current

**Syntax** rename("source\_file", "target\_file")

**rename****Arguments**

"source\_file" is the complete file name (path, file name and extension) to the file that you want to rename. The file must be located on the active drive. The argument can include a relative or absolute path name. Enclose the file name within double quotation marks.

"target\_file" is the complete file name (path, file name and extension) to the location to which you are renaming the source file. The target file must be located on the active drive. The argument can include a relative or absolute path name. Enclose the file name within double quotation marks.

**Example**

```
rename("/test_dir/sine.wfm", "/test_dir/old_sine.wfm")
```

**write**

The write statement writes the specified text to a new file name and/or location on the current drive. If an output file already exists, the source file contents are appended to the end of the existing file.

**Syntax**

```
write("output_filename", "text" [, "text" ...])
```

**Arguments**

"output\_filename" is the complete file name (path, file name, and extension) to the file that you want to write. The file must be located on the active drive. The argument can include a relative or absolute path name. Enclose the file name in double quotation marks.

"text" is the text string enclosed in double quotation marks. If you need to use a double quotation mark as part of the text, precede each double quotation character with a slash character (\). For example:

This function writes a text to a \"ABC.TXT\" in text form."

In a similar way, the following codes can be used in text strings:

\n – LF

\r – CR

\t – Tab

\\ – Backslash

\" – Double-quote

**Example**

```
write("sine.wfm", "This is a comment line.")
```

## Correlation

The operation expressed by the following equation is called correlation. With respect to a discrete system, correlation  $y(n)$  of a certain waveform  $x(n)$  and a second one  $h(i)$  is expressed by the following equation.  $N$  is the number of items of data.

$$y(n) = \sum_{t=0}^{N-1} x(i) h(n+1)$$

### Periodic

Periodic enables you to specify whether the two-waveforms must be regarded as periodic during calculation. Below is an example showing differences between non-periodic and periodic waveforms.

Waveform A = a0, a1, a2, a3, a4 (5 points)

Waveform B = b0, b1, b2 (3 points)

For non-periodic case:

$\langle A, B \rangle =$ 
  
 $a_0b_2,$ 
  
 $a_0b_1+a_1b_2,$ 
  
 $a_0b_0+a_1b_1+a_2b_2,$ 
  
 $a_1b_0+a_2b_1+a_3b_2,$ 
  
 $a_2b_0+a_3b_1+a_4b_2,$ 
  
 $a_3b_0+a_4b_1,$ 
  
 $a_4b_0,$ 
  
 0, (8 points)

---

The data length of the waveform created is the total of the number of points of the two-waveform files.

For periodic case:

$A \times B =$ 
  
 $a_0b_0+a_1b_1+a_2b_2,$ 
  
 $a_1b_0+a_2b_1+a_3b_2,$ 
  
 $a_2b_0+a_3b_1+a_4b_2,$ 
  
 $a_3b_0+a_4b_1+a_0b_2,$ 
  
 $a_4b_0+a_0b_1+a_1b_2,$ 
  
 (5 points)

---

Waveforms A and B are regarded as periodic during calculation. The count of the operation of the sum of the products is equivalent to the length of the shorter waveform. The resulting cycle of the waveform equals the same as the longer waveform. The actual output segment of the waveform corresponds to one cycle. The starting point value of the waveform equals the sum of products that is obtained with the starting point values of waveforms A and B added.

Unlike convolution, the result of  $A \times B$  and  $B \times A$  are different in correlation.  $B \times A$  is calculated as follows:

For non-periodic case:

$B \times A =$ 
  
 $b_0a_4,$ 
  
 $b_0a_3+b_1a_4,$ 
  
 $b_0a_2+b_1a_3+b_2a_4,$ 
  
 $b_0a_1+b_1a_2+b_2a_3,$ 
  
 $b_0a_0+b_1a_1+b_2a_2,$ 
  
 $b_1a_0+b_2a_1,$ 
  
 $b_2a_0,$ 
  
 0, (8 points)

---

For periodic case:

$$BxA = \begin{matrix} b0a0+b1a1+b2a2, \\ b0a4+b1a0+b2a1, \\ b0a3+b1a4+b2a0, \\ b0a2+b1a3+b2a4, \\ b0a1+b1a2+b2a3, \\ (5 \text{ points}) \end{matrix}$$

## Code conversion

You can select the coding system to use when outputting pattern strings. If the code is affected by the immediately preceding data, the data item just before the first item of data will be calculated as 0. The following tables show the coding systems.

Using the code conversion table, the bit pattern can be converted to another code. The following figure shows an image of how the code conversion table is used.

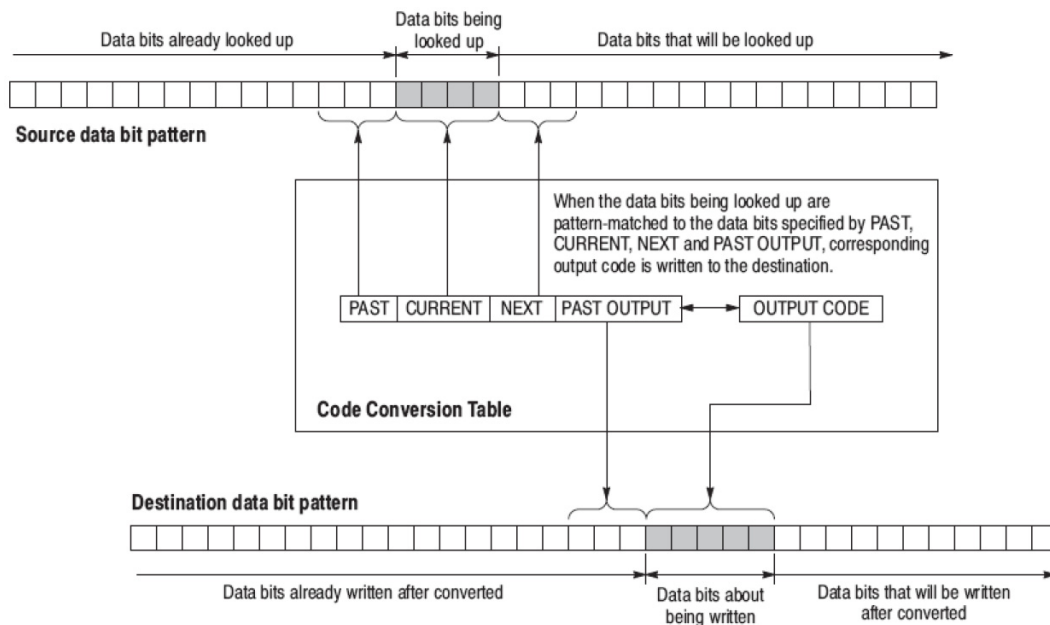

This part inputs the binary bit pattern and converts the transition from 1 to 0 or 0 to 1 to a series of positive and negative pulses. The following table lists the available code conversion types:

Code conversion	Description
NRZ	Converts a transition from 0 to 1 to a positive pulse, and from 1 to 0 to a negative pulse. This conversion considers the input data as representing a direction of magnetization.
NRZI	Generates a pulse when the input data is 1. The first pulse is always positive, and after this, the pulse polarity toggles for every input data value of 1. This conversion considers the input data as representing the disk writing data.

## Examples

In following examples, data bits to be written in the tables are introduced. And input and output data bit pattern example is following each table.

- Inverting bit of the NRZ data.

Past	Current	Next	P.OUT	Output code
	0			1
	1			0

### Example

Input	0	1	0	0	1	1	0	0	0
Output	1	0	1	1	0	0	1	1	1

- Converting NRZ data to NRZI.

Past	Current	Next	P.OUT	Output code
	1		0	1
	1		1	0
	0		0	0
	0		1	1

### Example

Input	0	1	0	0	1	1	0	0	0
Output	0	1	1	1	0	1	1	1	1

- Converting NRZ data to NRZI-2. Two bit are generated for each input bit.

Past	Current	Next	P.OUT	Output code
	1		0	01
	1		1	10
	0		0	00
	0		1	11

### Example

Input	0	1	0	0	1	1	0	0	0
Output	00	01	11	11	10	01	11	11	11

- Converting NRZ data to FM. Two bit are generated for each input bit.



Past	Current	Next	P.OUT	Output code
	0		0	11
	0		1	00
	1		0	10
	10		1	01

**Example**

Input	0	1	0	0	1	1	0	0	0
Output	11	01	00	11	01	01	00	11	00

- Converting NRZ data to BI-PHASE. Two bit are generated for each input bit.

Past	Current	Next	P.OUT	Output code
	0			00
	1			10

**Example**

Input	0	1	0	0	1	1	0	0	0
Output	01	10	01	01	10	10	01	01	01

- Converting NRZ data to RZ. Two bit are generated for each input bit.

Past	Current	Next	P.OUT	Output code
	0		0	01
	1		0	10

**Example**

Input	0	1	0	0	1	1	0	0	0
Output	00	10	00	00	10	10	00	00	00

- Output bit is always set to 1 when input bit changes from 1 to 0 or 0 to 1.

Past	Current	Next	P.OUT	Output code
0	1			1
1	0			1
	1			0
	0			0

**Example**

Input	0	1	0	0	1	1	0	0	0
Output	0	1	1	0	1	0	1	0	0

- Converting NRZ data to 1-7 RLL (Run-length Limited Codes).

Past	Current	Next	P.OUT	Output code
	0000		1	100000
	0000		0	011111
	0001		00	111111
	0001		01	111111
	0001		10	000000
	0001		11	000000
	0010		01	111110
	0010		10	000000
	0010		00	111110
	0010		11	000001
	0011		1	100001
	0011		0	011110
	01		0	100
	01		0	011
	10		01	111
	10		10	000
	10		00	111
	10		11	000
	11		01	110
	11		10	001
	11		00	110
	11		11	001
	0			0
	1			1

**Example**

Input	01	10	11	0010	10	0011	11	0001	0011	10	0000
Output	011	000	110	0000	111	1000	110	0000	0111	000	0111
			1			01		00	10		111

**Code conversion table**

The code conversion table is only a text file. You can create the code conversion tables using a text editor on your PC or other computer.

The format is in the form of <past>,<current>,<next>,<past.out>,<output>.

nrz.txt	nrzi.txt	nrzi-2.txt
,0,,1	,1,,0,1	,1,,0,01
,1,,0	,1,,1,0	,1,,1,10
	,0,,0,0 ,	,0,,0,00
	0,,1,1	,0,,1,11
fm.txt	bi-phase.txt	rz.txt
,0,,0,11	,0,,0,1 ,	,0,,0,0 ,
,0,,1,00	1,,10	1,,10
,1,,0,10		
,1,,1,01		
custom.txt	1-7rill.txt	
0,1,,1	,0000,,1,100000	
1,0,,1	,0000,,0,011111	
,1,,0	,0001,,00,111111	
,0,,0	,0001,,01,111111	
	,0001,,10,000000	
	,0001,,11,000000	
	,0010,,01,111110	
	,0010,,10,000001	
	,0010,,00,111110	
	,0010,,11,000001	
	,0011,,1,100001	
	,0011,,0,011110	
	,01,,1,100 ,01,,0,011	
	,10,,01,111 ,10,,10,000	
	,10,,00,111	
	,10,,11,000	
	,11,,01,110 ,11,,10,001	
	,11,,00,110	
	,11,,11,001	
	,0,,0	
	,1,,1	

## Differentiation

The diff( function calculates the central deviation as the differential value. The equation below expresses the central deviation when the function  $f(x)$  is given at even intervals of  $\Delta x$ .

$$f'(x) = \frac{f(x + \Delta x) - f(x - \Delta x)}{(2\Delta x)}$$

In actual practice, when function  $f(x)$  is expressed by  $n$  values, the differential value  $f'(x_i)$  at point  $x_i$  is given by the following equation:

$$f'(x_i) = n \frac{|f(x_{i+1}) - f(x_{i-1})|}{2}$$

Here, “ $n$ ” is the number of waveform points and “ $i$ ” is an integer in the range,  $i=1, 2, \dots, n$ . The

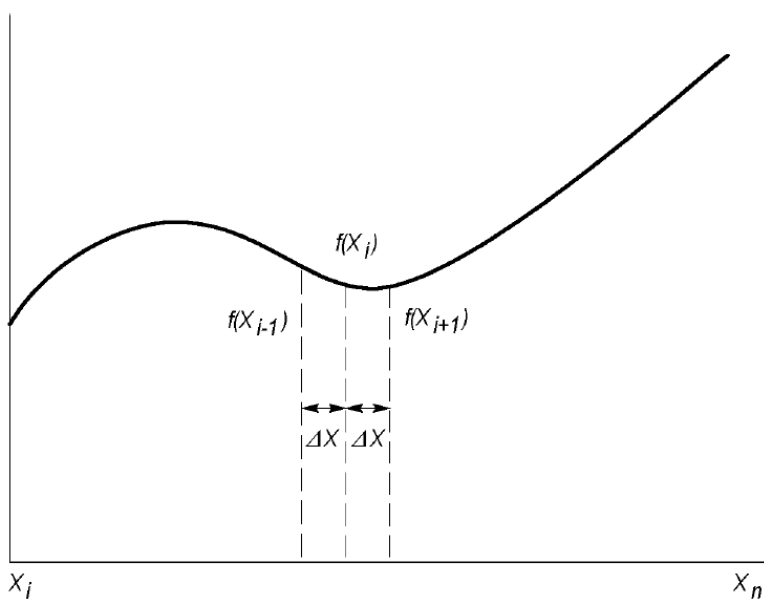

The values at the first and last points are obtained from the following equations rather than from the center deviation:

First point

$$f'(x_1) = \frac{n |-3f(x_1) + 4f(x_2) - f(x_3)|}{2}$$

Last point

$$f'(x_n) = \frac{n |f(x_{n-2}) - 4f(x_{n-1}) - 3f(x_n)|}{2}$$

## Integration

The integ function integrates numerically based on a trapezoidal formula. The trapezoidal formula is expressed with the following equation:

$$\int f(x) dx = \sum_{i=1}^n \frac{f(x_{i-1}) + f(x_i)}{2} \cdot \Delta x$$

$$= \Delta \frac{X}{2} \{ \Delta f(X_1) + 2f(X_2) + 2f(X_3) + \dots + 2f(X_{n-1}) + f(X_n) \}$$

Here, n is the number of waveform points and i is an integer in the range  $i = 1, 2, \dots, n$ .

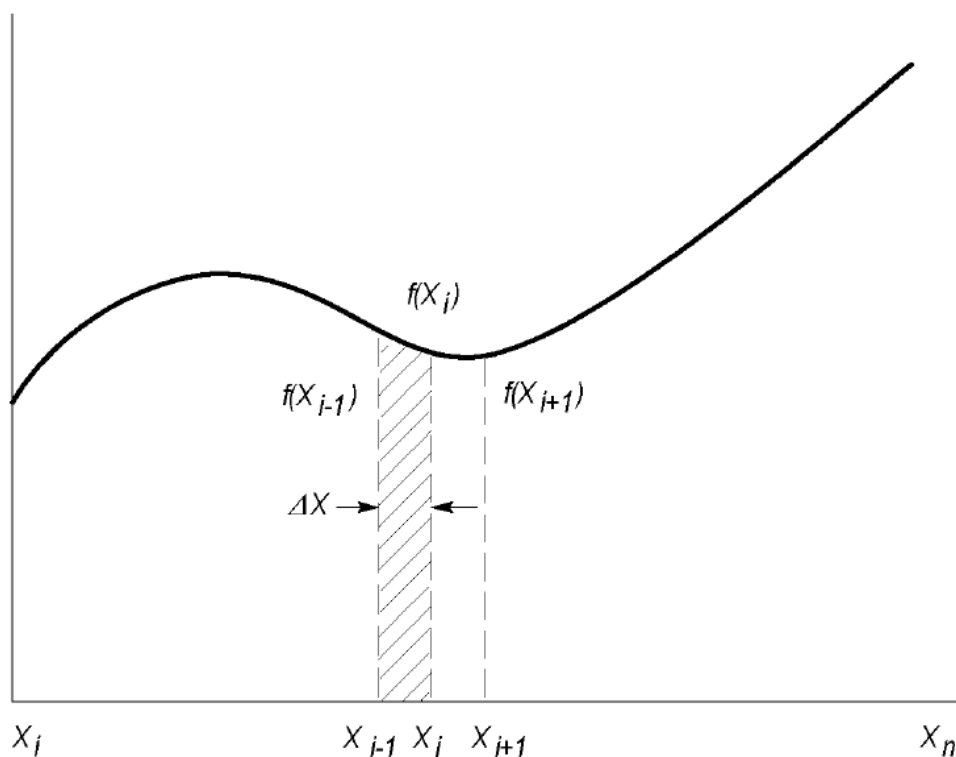

The integration is actually calculated with the following formula:

$$\int f(x) \Delta x = 1/2 \{ f(x_1) + 2f(x_2) + 2f(x_3) + \dots + 2f(x_{n-1}) + f(x_n) \}$$

However, the imaginary initial value  $f(x_0)$  always takes a value of 0.

## Convolution

The operation expressed by the following equation is called convolution. With respect to a discrete system, convolution  $y(n)$  of a certain waveform  $x(n)$  and a second one  $h(i)$  is expressed by the following equation.  $N$  is the number of items of data.

$$y(n) = \sum_{t=0}^{N-1} x(i) h(n-i)$$

### Periodic

Periodic enables you to specify whether the two-waveforms must be regarded as periodic during calculation. Below is an example showing differences between non-periodic and periodic waveforms.

Waveform A = a0, a1, a2, a3, a4 (5 points)

Waveform B = b0, b1, b2 (3 points)

For non-periodic case:

<A,B> =

- a0b0,
- a0b1+a1b0,
- a0b2+a1b1+a2b0,
- a1b2+a2b1+a3b0,
- a2b2+a3b1+a4b0,
- a3b2+a4b1,
- a4b2,
- 0, (8 points)

---

The data length of the waveform created is the total of the number of points of the two-waveform files.

For periodic case:

AxB =

- a0b2+a1b1+a2b0,
- a1b2+a2b1+a3b0,
- a2b2+a3b1+a4b0,
- a3b2+a4b1+a0b0,
- a4b2+a0b1+a1b0,
- (5 points)

---

Waveforms A and B are regarded as periodic during calculation. The count of the operation of the sum of the products is equivalent to the length of the shorter waveform. The resulting cycle of the waveform equals the same as the longer waveform. The actual output segment of the waveform corresponds to one

cycle. The starting point value of the waveform equals the sum of products that is obtained with the starting point values of waveforms A and B added.

## Math functions

The following table lists the programming language math functions that you can use as part of a waveform equation expression.

Item	Description
abs( 	Absolute value of a
acos( 	Arc cosine of a
and	Logical AND
asin( 	Arc sine of a
atan( 	Arc tangent of a
ceil( 	Minimum integer greater than or equal to a
cos( 	Cosine of a
cosh( 	Hyperbolic cosine of a
exp( 	Exponential function of base of natural logarithm for a
floor( 	Maximum integer less than or equal to a
int( 	Truncation (Same as floor(a) if a >= 0; same as ceil(a) if a < 0)
log( 	Natural logarithm of a
log10( 	Base 10 logarithm of a
max( 	Returns larger (maximum) value of a and b
min( 	Returns smaller (minimum) value of a and b
noise( 	Generates pseudo Gaussian distribution white noise signal with a standard deviation (= RMS) of 1
or	Logical OR
pow( 	Exponentiation (bth power of a, or a^b) A negative value may be specified for a only if b is an integer. Otherwise, NaN will result. The pow function returns one of the following values: If b = 0: Always 1 If b ≠ 0 and a = 0: Always 0 If b ≠ 0 and a < 0 and b is a positive integer: axb If b ≠ 0 and a < 0 and b is a negative integer: Reciprocal of ax(-b) If b ≠ 0 and a < 0, NaN (Not a Number)
rnd( 	Returns a random number in the 0 to 1 range. Generated base seed = (253 x seed + 1)% 16777216, return seed/16777216. Seed is a 32-bit unsigned integer.
round( 	Rounds off the value of a to an integer

Item	Description
saw(	Saw tooth wave with a cycle of $2\pi$ and an amplitude $\pm 1$ . If $a = -2\pi, 0, 2\pi, 4\pi, \text{ or } 6\pi, \text{ etc.}$ , the value is $-1$ . The value approaches 1 at points immediately before these. (This function will not take the value 1.0.)
sinc(	Same as $\sin(a)/a$ , except that 1 results if $a=0$
sign(	Sign of $a$ (1 if $a > 0$ ; $-1$ if $a < 0$ ; 0 if $a = 0$ )
sin(	Sine value of $a$
sinh(	Hyperbolic sine value of $a$
sqr(	Rectangular wave with a cycle of $2\pi$ and an amplitude $\pm 1$ . If $k$ is even: For $a = k\pi$ to $(k+1)\pi$ , $\text{sqr}$ returns $-1$ , except $+1.0$ when $a$ equals $(k+1)\pi$ . If $k$ is odd: For $a = k\pi$ to $(k+1)\pi$ , $\text{sqr}$ returns $+1$ , except $-1.0$ when $a = (k+1)\pi$ .
sqrt(	Square root value of $a$
srnd(	Sets the random number generator seed value. Seed is 0 to 231-1. Default value is 0.
tan(	Tangent value of $a$
tanh(	Hyperbolic tangent value of $a$
tri(	Triangular wave with a cycle of $2\pi$ and an amplitude $\pm 1$ . If $a = 0$ , the value is 0. If $a = 0.5\pi$ , it is 1.0. If $a = \pi$ , it is 0.0. If $a = 1.5\pi$ , it is $-1$ .

## Math operators

The following tables lists the programming language math operators that you can use as part of waveform equation expressions.

Item	Description
<b>Unary operations</b>	
-	Inverts the sign.
+	No effect
<b>Binary operations</b>	
+	Addition
-	Subtraction
*	Multiplication
/	Division
^	Exponentiation



**Binary relational operations**

=	If both side values are equal, 1 results. Otherwise 0 results.
<>	If both side values are not equal, 1 results. Otherwise 0 results.
>	If the left side value is larger than the right side value, 1 results. Otherwise 0 results.
>=	If the left side value is larger than or equal to the right side value, 1 results. Otherwise 0 results.
<	If the left side value is smaller than the right side value, 1 results. Otherwise 0 results.
<=	If the left side value is smaller than or equal to the right side value, 1 results. Otherwise 0 results.

**Binary conditional operators**

and	If both side values are not 0, 1 results. Otherwise 0 results.
or	If both side values are 0, 0 results. Otherwise 1 results.

The operator priorities are as follows, starting with higher priority at the top of the list. Operators on the same line have equal priority.

^
- (unary), + (unary)
*, /
=, <>, >, >=, <, <=
and, or

## Equation examples

This section provides example equations to help illustrate using the equation editor. The equations can be copied and pasted into the equation editor to generate the described waveforms.

<a href="#">Example 1 (see page 151)</a>	Describes how to create a square wave with two markers.
<a href="#">Example 2 (see page 152)</a>	Describes how to create a waveform file.
<a href="#">Example 3 (see page 154)</a>	Describes how to use 'for' loop and 'if' conditional branch statements.
<a href="#">Example 4 (see page 155)</a>	Describes how to put comments, and how to create sequence file.
<a href="#">Example 5 (see page 157)</a>	Describes how to use marker data and how to use the binary relational operations in the assignment statement.
<a href="#">Example 6 (see page 159)</a>	Describes how to handle specific point data in the waveform file using the extract(), join() and integ() function, and also the for and if statements.

### Example 1

This example creates a square wave with two markers.

```
clock = 10e9 'Recommended sample rate
```

```

size = 2400
"Square2pt5"=sqr(2.5 * 2 * pi * scale) * -1
"Square2pt5".Marker1 = (point= 480)
"Square2pt5".Marker1 = "Square2pt5".Marker1 + (point= 960)
"Square2pt5".Marker2 = (point <= 5)

```

This example shows 3 basic statement components: Left Hand Side (LHS) assignment, Right Hand Side(RHS), and clock as a variable.

The first line sets the recommended sample rate to 10 GS along with a comment. The sample rate is added to the properties of the waveform.

The second line assigns the reserved keyword size to be 2400.

The third line generates the waveform.

The fourth line modifies marker1. The keyword point refers to the current data point being evaluated, one of the 2400 points of the waveform, being processed. The first “=” is the assignment. The next “=” is treated as “==” or “isEqual”. When marker1 is being processed, the “point=480” is evaluated. For data point 0 to 479 the test will return a 0. For data point 480, the test will return a 1. For the rest of the data points, the test will be 0.

The fifth line modifies (adds to) marker1 with another pulse at 960.

The 6th line creates a pulse of 6 points starting at 0 (the beginning of marker2). Every data point from 0 to 5 is true (1) and is assigned to marker2.

The following figure shows the waveform generated by the above example.

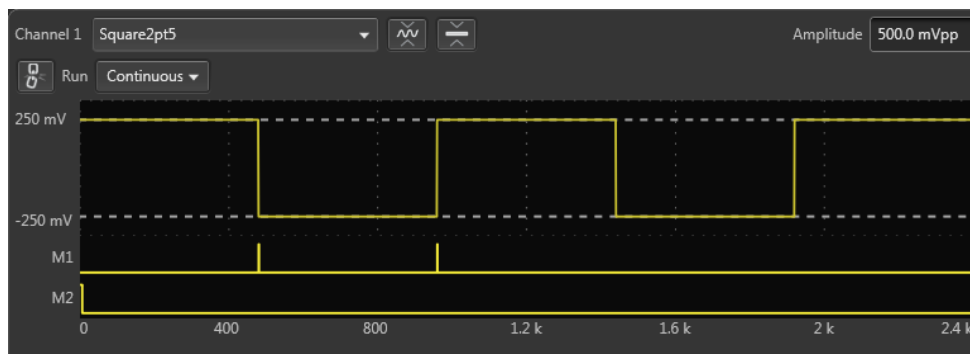

## Example 2

This example creates three waveform files: a.wfm, b.wfm, and c.wfm.

```

size = 2000
"a.wfm" = cos (2 * pi * scale)
size = 1512

```

```
"b.wfm" = cos (2 * pi * scale)
```

```
"c.wfm" = "a.wfm" * "b.wfm"
```

The first and third lines define the waveform record length (in points). You can change the record length any time within an equation; all created files use the last-set size value. When you do not define the waveform record length, the instrument uses the default length of 1000.

The second line generates the waveform a.wfm with 2000 data points. The scale is the system-used variable to fit the generated waveform within the  $\pm 1.0$  vertical scale range.

The waveforms b.wfm and c.wfm have point sizes of 1512.

Waveform c.wfm is generated by multiplying the a.wfm and b.wfm waveforms.

When you perform the operation between the waveforms which have different point sizes, the lowest point size among them is used. Therefore the c.wfm will have the point size of 1500.

The following figures shows the waveforms generated by the above example.

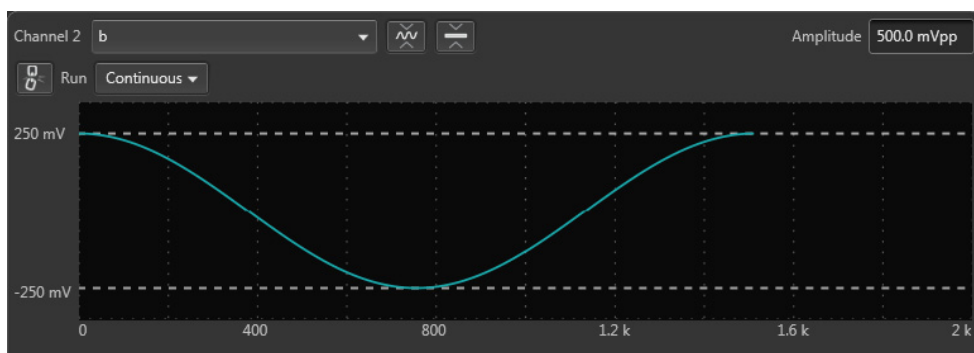
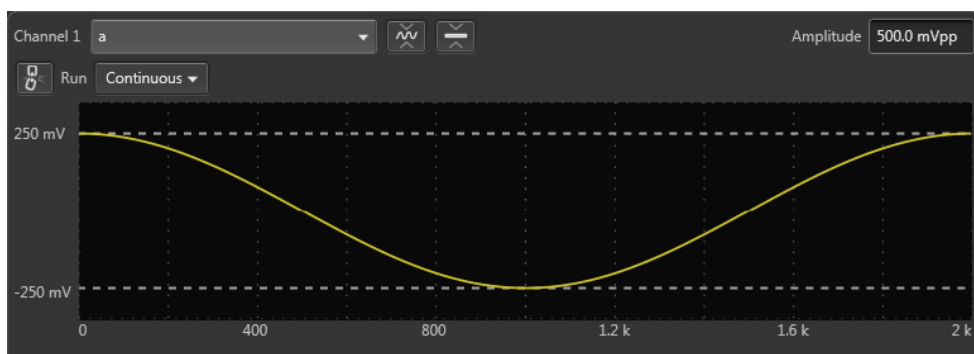

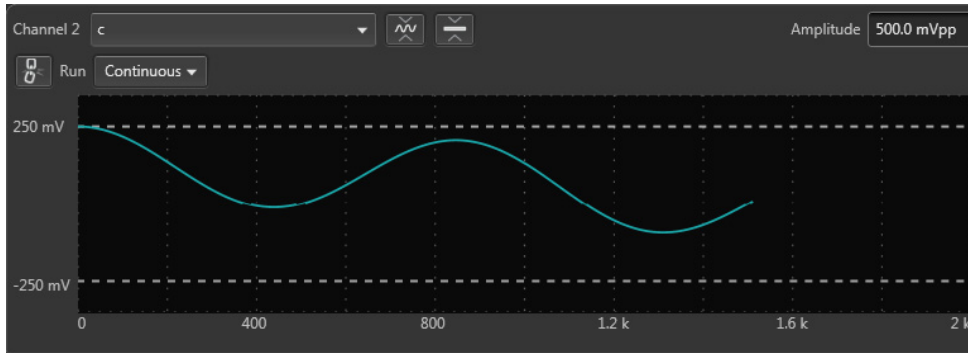

### Example 3

This example demonstrates using the for and if statements.

```

num = 30
for i = 1 to num
  if i = 1 then
    "t.wfm"=cos(2*pi*scale)
  else
    "t.wfm"="t.wfm"+cos(2*pi*i*scale)
  endif
next
"t.wfm"="t.wfm"/num

```

Num and i are user-defined variables. I is used as part of the for loop parameter. The statements placed between the for and next keywords repeat 30 times while the i increments by 1 for each loop.

The conditional branch statement must start with the if keyword and end with the endif keyword. In this example, if  $i = 1$ , the equation creates the waveform t.wfm. When  $i \neq 1$ , the newly created waveform and the one created in the previous loop are added, and the result is stored in the waveform t.wfm. The resultant waveform is then normalized.

The following figure shows the waveform generated by the previous example:

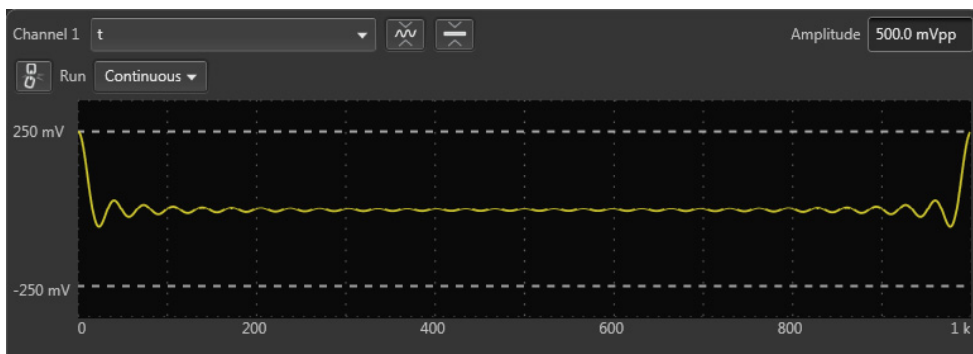

#### Example 4

The following example creates one sequence file and four waveforms.

```
delete("test.seq")
size=1000
clock=1e9
num=4
'write sequence file header
write("test.seq","MAGIC 3002\n")
write("test.seq","LINES ":num:"\n")
for i = 1 to num
  'create a waveform file
  "test":i:".wfm" = sin(2 * pi * i * scale)
  'add line to sequence file
  rep = num * I
  write("test.seq","\\"test":i:".wfm\\","\\"",":rep:"\n")
next
```

The first line deletes the sequence file named “test.seq”. This is the name of the sequence file that will be created by the example. We want to ensure the file does not already exist. If the file does not exist, the command is ignored.

The size and clock keywords are the system valuables representing the waveform record length, in points, and the sampling clock frequency. They are set to 1000 points and 1.0 GS/s in this example.

The comment text on line 5 starts with a single quotation (!) character. Comment text is effective until the end of the line containing the single quote character.

The write command writes the specified text to the specified file. If the file being written to exists, the write command appends the specified string to the end of the file. The first argument is the file name. The second argument and subsequent arguments are strings which are written to the file. The string must be enclosed in double quotation marks. To use a variable as a string, you must place the colon (:) before and after the variable.

For example: "test":i:".wfm"

In the above example, if the variable *i* is currently 4, the value of the string will be text4.wfm. The slash is used as an escape character, and precedes the double quotation marks in a string. The '\n' inserts an end of line (EOL) character in the file.

The sequence file is a text file which has the number 3002 on the first line of the text and the number of lines (for example LINES 4) on the second line.

The following figures show the four waveforms generated by this example and the sequence file.

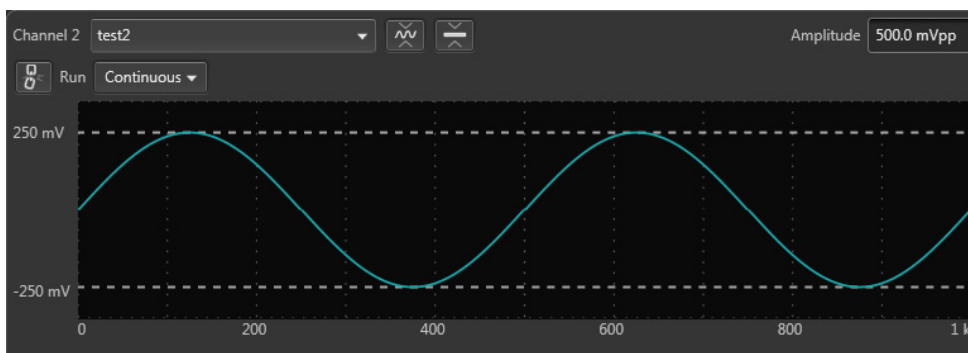
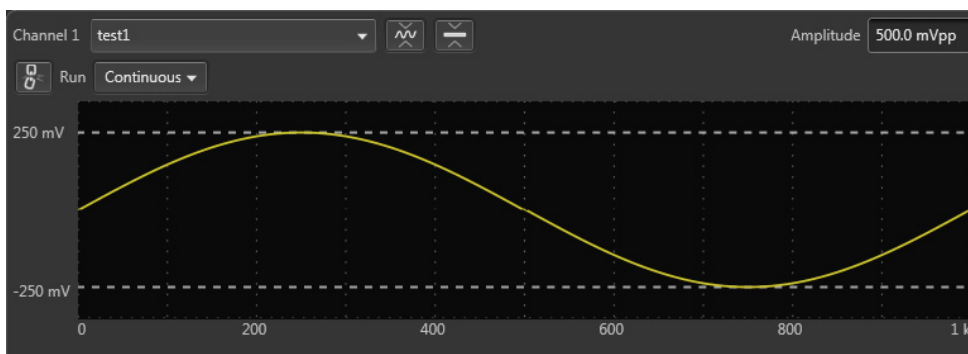

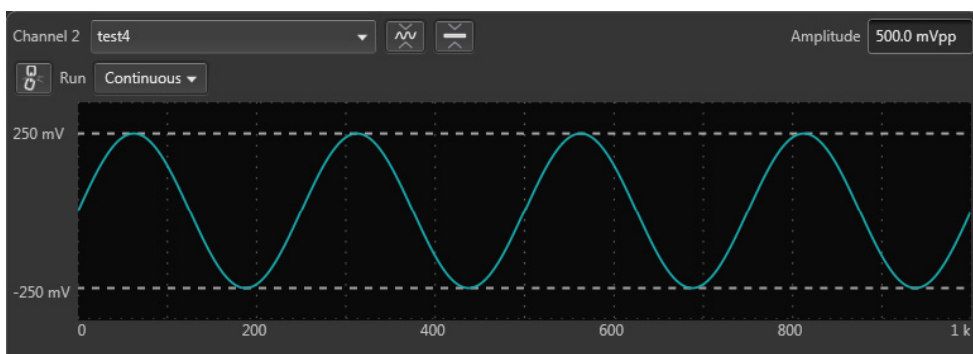
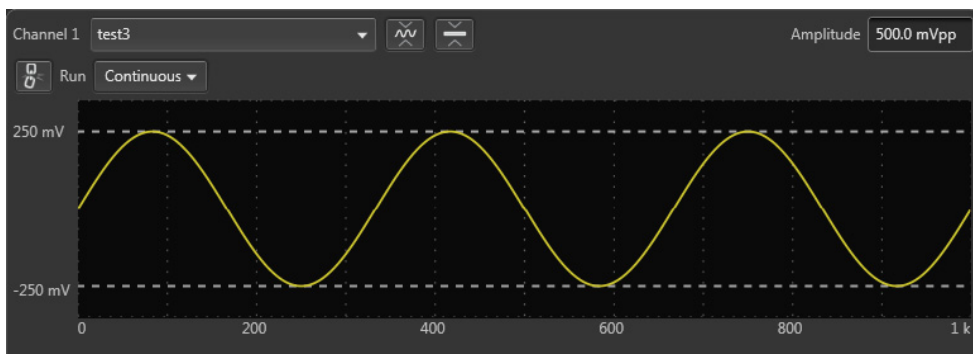

Channel 1 test - Track 1 Amplitude 500.0 mVpp

Force Jump To... Current step: --

	Wait	Track	Flag	Repeat	Event	Jump to	Go to
1	Off	test1		4	TrigA	Next	Next
2	Off	test2		8	TrigA	Next	Next
3	Off	test3		12	TrigA	Next	Next
4	Off	test4		16	TrigA	Next	Next

### Example 5

This example shows how to use Boolean relational operations between a waveform and its marker data.

```
"MOD.wfm" = sin (2 * pi * scale)
```

```
"MOD01.wfm" = "MOD.wfm"
```

```
"MOD01.wfm".marker1 = "MOD01.wfm" >= 0.5
```

```
"MOD01.wfm".marker2 = "MOD01.wfm" <= -0.5
```

```
"MOD02.wfm" = ("MOD01.wfm".marker1 = "MOD01.wfm".marker2) / 2
```

The Boolean relational operation results in 1 if the condition is true, and 0 if the condition is false. Therefore the MOD01.wfm marker1 signal is 1 if the waveform data is greater than or equal to 0.5, and 0 for all other values. Likewise, the marker2 signal is 1 if the waveform data is less than or equal to -0.5, and 0 for all other values.

The Boolean relational operation results in 1 if the condition is true, and 0 if the condition is false. Therefore the MOD01.wfm marker1 signal is 1 if the waveform data is greater than or equal to 0.5, and 0 for all other values. Likewise, the marker2 signal is 1 if the waveform data is less than or equal to -0.5, and 0 for all other values.

The results are shown in the following figures:

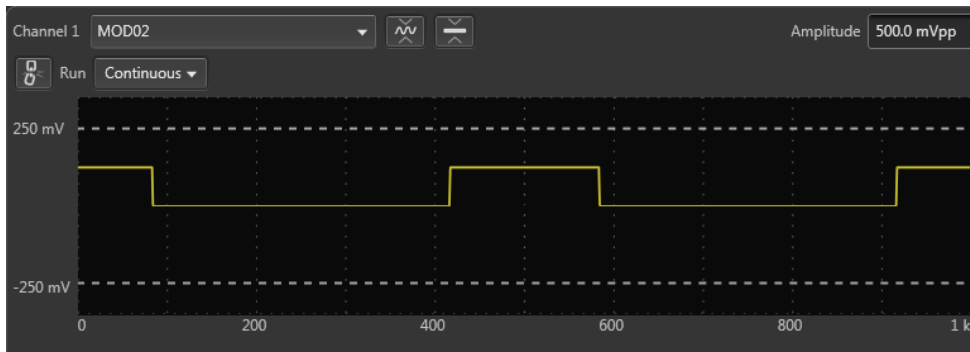
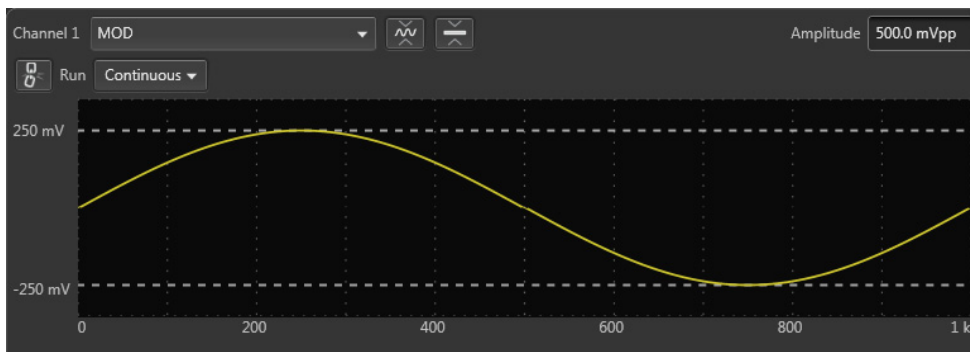
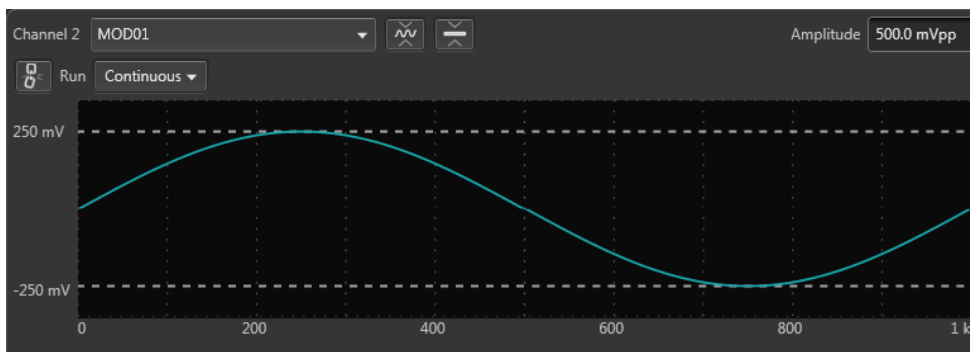



### Example 6

This example applies a 7-point smoothing operation to a noise waveform.

The equation uses the `extract()`, `integ()` and `join()` functions, and also `for` and `if` control statements. Although you do not have any other method to perform smoothing with the instrument, this is not a preferable way to apply a smoothing operation. Refer to this example for learning how to use these functions and control statements.

You can change the number of smoothing points by changing the value of the variable `nump`. The greater the value of `nump`, the faster the instrument can finish the compile.

```
' simple smoothing (7 points)
nump = 7
extp = nump - 1
nsht = extp / 2
size = 960
"NOISE.wfm" = noise()
"NOISE.wfm" = norm("NOISE.WFM")
cc = 1
for i = nsht to (size - nsht -1) step 1
  sp = i - nsht
  ep = i + nsht
  "TEMP1.wfm" = extract("NOISE.wfm", sp, ep)
  "TEMP1.wfm" = integ("TEMP1.wfm")
  "TEMP2.wfm" = extract("TEMP1.wfm", extp, extp)
  "TEMP2.wfm" = "TEMP2.wfm" / nump
  if cc = 1
  then
    "SMOOTH.wfm" = "TEMP2.wfm"
  else
    "SMOOTH.wfm" = join("SMOOTH.wfm", "TEMP2.wfm")
  endif
  cc = cc + 1
next
delete("TEMP1.wfm")
delete("TEMP2.wfm")
```

In this example, the following occurs:

- The `noise()` function generates a noise waveform into the file NOISE.wfm, in which the waveform data are normalized using the `norm()` function.
- The `extract()` function extracts the data sp through ep and stores them into the file TEPM1.wfm.
- The `integ()` function integrates the 7-point data. The data of last point is the amount of 7-point data. This last data is divided by 7 and concatenated to the file SMOOTH.wfm.
- The `for` statement shifts the points to be read by one point for each loop and repeats these procedures.
- The temporary files are deleted.

The following figure shows the noise waveforms before (upper) and after (lower) 7-point smoothing.

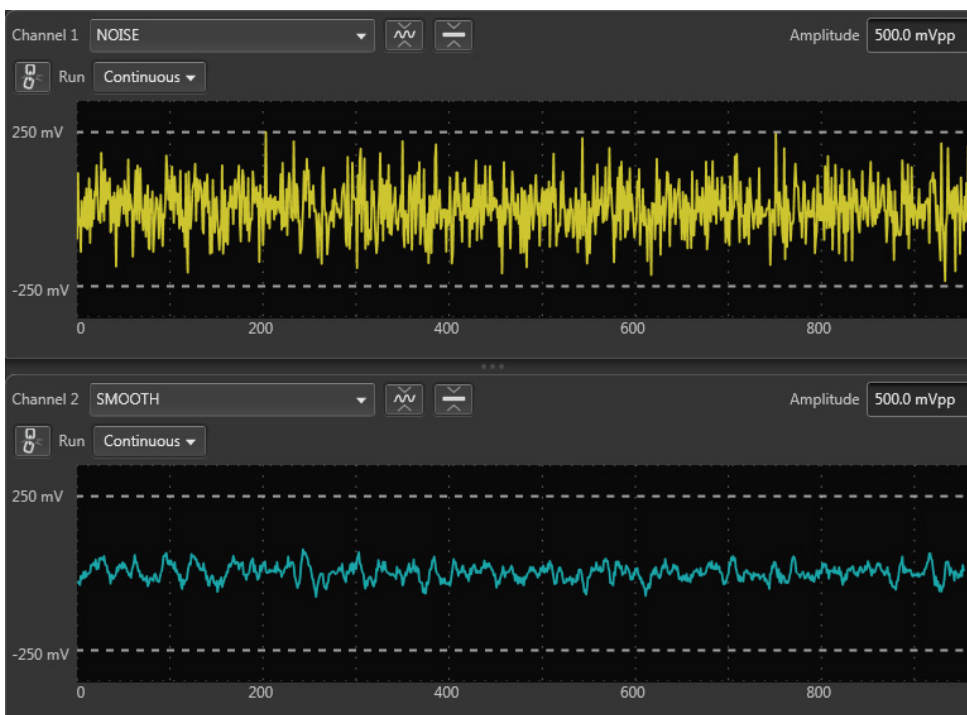

## Table editor

The Table Editor plug-in allows you to display any waveform's sample points in table format. Using the table, you can then directly modify any sample point of the waveform, including marker data.

Samples	Data (Normalized)	M1	M2	M3	M4
0	-0.00392150972038507	1	1	0	0
1	0.121568694710732	1	1	0	0
2	0.247058898210526	1	0	0	0
3	0.364705950021744	1	1	0	0
4	0.482353031635284	0	1	0	0
5	0.584313809871674	1	1	0	0
6	0.686274588108063	0	1	0	0
7	0.772549152374268	0	1	0	0
8	0.843137383460999	1	0	0	0
9	0.905882477760315	0	1	0	0
10	0.952941298484802	0	1	1	1
11	0.98431384563446	0	1	1	1
12	1.0000011920929	0	1	1	1
13	1.0000011920929	0	1	1	1
14	0.98431384563446	0	1	1	1
15	0.952941298484802	0	1	1	1
16	0.905882477760315	0	1	1	1
17	0.843137383460999	1	0	1	1
18	0.772549152374268	0	1	1	1
19	0.686274588108063	0	1	1	1

The table is able to display up to 2 G samples at a time. If viewing waveforms larger than this, once you reach the end of the table, a navigation bar is displayed to load the next 2 G of sample points. This continues until you reach the final sample point of the waveform.

In the partial view below, we've reached the end of the table, and we need to click on the navigation bar to load the next set of samples.

1 999 999 998	0.905882477760315	0	1	1	1
1 999 999 999	0.843137383460999	1	0	1	1
2 000 000 000	0.772549152374268	0	1	1	1

Click to go to sample points 2000000000 to 4000000000

A similar navigation bar appears at the top of the table bar to go back to previous samples.

### Toolbar operations

The tool bars in the table editor provides several functions.



The File drop-down list contains the following menu selections.

- **New...:** Displays the New Waveform dialog screen to create a new waveform. See [New Waveform \(see page 163\)](#) for details about the waveform creation parameters.
- **Open...:** Displays a windows directory. Use the Windows directory to navigate to a saved waveform files or sequence files. You can select multiple files and all waveforms are added to the Waveforms list.
  - Opening a sequence file displays a window of all waveforms included within the sequence. Choose any or all waveforms. The selected waveforms are added to the Waveforms list. (The sequence is not added to the Sequences list.)
- **Recent:** Displays the list of waveforms that have been opened in the Table Editor during the current session. The waveform must be available in the Waveforms list.
- **Save:** Opens a Windows navigation screen to allow you to name (or rename) and save the waveform currently in the Table Editor to the hard drive or any available devices.
- **Save As:** Saves the opened sequence as a new waveform with a new name.
- **Properties:** Displays the properties of the opened waveform.



Copy icon: Copies the selected cells in the Table Editor to the clipboard.



Paste-replace icon: Pastes the data from the copy clipboard to the table. Paste from this menu always rights over the existing data in the cell.

The data being pasted must match the data type for the cells.

For example, you can not paste marker data into a waveform data cell.

You can also paste data from an Excel spreadsheet, replacing data in any number of cells (rows).



Insert row icon: Use this to insert a new row into the Table Editor. The row is inserted above the currently selected row and the values are set to zero.

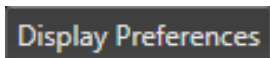

The Display Preferences button displays a dialog screen to set the following:

- **Data:** View the waveform data as either Normalized or in Volts. When volts is selected, you must select which channel to use as the amplitude reference.
- **Points:** Select to view the waveform sample points as sample number or seconds.
- **Show Analog:** Enable or disable viewing the Data column.
- **Show Marker (1 — 4):** Enable or disable viewing the available Markers columns.



The Go To Row lets you jump directly to a row within the waveform to view and edit the row.

### Right-click menu operations

The table editor window provides many additional editing operations with the right-click menus available within the various columns of the table editor.

Samples column

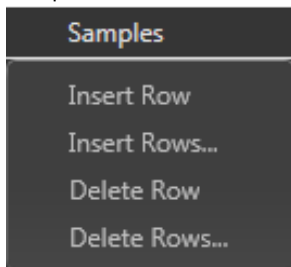

- **Insert Row:** Inserts one new row above the currently selected sample row. The data and marker values are set to 0.
- **Insert Rows...:** Displays a pop-up window to enter multiple rows. The rows are inserted above the currently selected row. The data and marker values are set to 0.
- **Delete Row:** Deletes the currently selected row.
- **Delete Rows...:** Displays a pop-up window to enter a range of rows to delete.

Data column

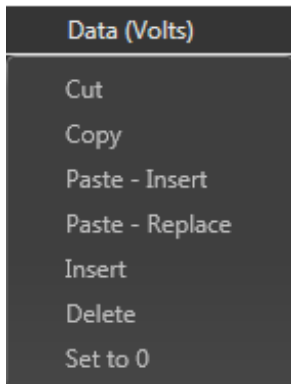

- **Cut:** Cuts the selection and places it in the clipboard. You can cut and paste from one waveform to another.
- **Copy:** Copies the selection and places it in the clipboard. You can copy and paste from one waveform to another.
- **Paste - Insert:** Inserts the clipboard contents into the table, creating a new sample point above the current selected cell/row. Other columns will have data cells added to the end, keeping all column length even.
- **Paste - Replace:** Inserts the clipboard contents into the selected cell.
- **Insert:** Inserts a new cell to the column, above the currently selected cell. Other columns will have data cells added (0 value) to the end, keeping all column length even.
- **Delete:** Deletes the currently selected cell. The column will have a data cell added (0 value) to the end.
- **Set to 0:** Sets the value to 0.

The Data column splits into two data columns (I Data and Q Data) when viewing an IQ waveform.

Markers column

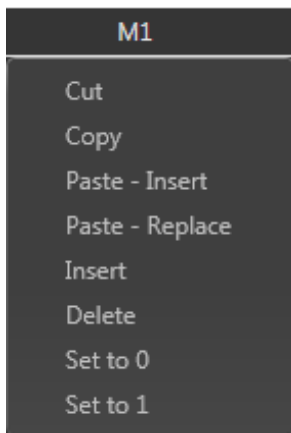

Same functions as the Data column except for the Set to 1 selection. Markers can only be set to 0 or 1.

**New Waveform**

Selecting New... from the Table Editor File menu displays the New Waveform dialog screen.

The new waveforms created have the waveform data and marker values set to zero.

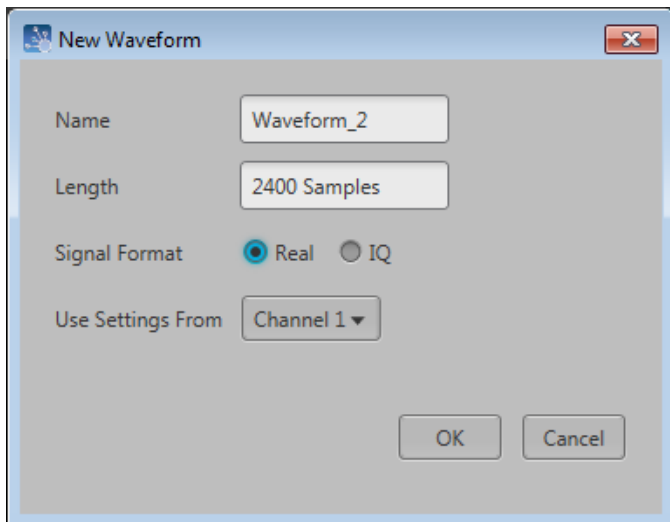

Name	Enter a name for the waveform. If the name already exists in the Waveforms list, the name is appended with an underscore suffix such as "Waveform_1".
Length	Enter the number of sample points. The minimum and maximum number of points is dependent on the instrument model.
Signal Format	Select Real to describe the waveform as an RF type waveform. Select IQ to describe the waveform as IQ data. When selecting IQ, both an I and Q waveform is created.
Use Settings From	Specify the channel to use as the settings source.

When waveform is created, it is placed in the Waveform List, but is not saved to the hard drive. To save to the hard drive, save the waveform from the Waveform List.

## Precompensation plug-in

The Precompensation tab allows you to create correction files to be used with a waveform file.

**NOTE.** *The Precompensation tab only appears if the Precompensation plug-in is installed. To use the plug-in, it must be licensed. Refer to [Licensing \(see page 197\)](#).*

The Precompensation tab has its own user manual (and is not described here). Press the help button on the Precompensation tab to access its user manual.

## Waveform specifications and notes

This section contains information about waveform characteristics and minimum requirements when importing. These characteristics and requirements also apply to waveforms imported with a sequence.

**Table 7:**

Item	Description
Granularity	1 point If the waveform does not meet the granularity requirement, the waveform cannot be loaded if the set Run mode requires a trigger event.
Minimum length	Continuous run mode: 1 sample Triggered or sequence run modes: Real waveform: 2400 samples Complex waveform: 1200 samples
Maximum length	2 G
Number of bits	In 16-bit mode, all 16 bits are used for the analog waveform and marker outputs are not available. In 15-bit mode, one marker (M1) is available, and 15 bits are used for the analog waveform. In 14-bit mode, two markers (M1 & M2) are available, and 14 bits are used for the analog waveform. In 13-bit mode, three markers (M1 & M2 & M3) are available, and 13 bits are used for the analog waveform. In 12-bit mode, four markers (M1 & M2 & M3 & M4) are available, and 12 bits are used for the analog waveform.

## File formats (creating)

This section provides information about the formatting of certain file formats to aid in the construction of these types of files, externally.

Information about these three files types is provided.

File suffix	Description
.seq	<a href="#">Sequence files (.seq file format) (see page 166)</a>
.wfm	<a href="#">Waveform files (see page 168)</a> (.wfm native file format)
.mat	<a href="#">Waveform files using MATLAB (see page 173)</a>

## Sequence file format (.seq)

Tektronix AWG5200 series instruments can read sequence files created with other Tektronix AWGs (such as the AWG400, 700 series). These instruments produced files using the .seq file extension and were ASCII files.

Being a simple ASCII file, you can create these types of sequence files on a PC or other computer with an ASCII text editor.

The sequence file must conform to the format described below.

---

**NOTE.** *Waveform files referenced in the sequence file must reside in the same directory location as the sequence file.*

---

The ASCII file must follow this format:

```
MAGIC 3002
LINES <number>
<line description>
<line description>
...
<line description>
TABLE_JUMP 0,0,0,0,0,0,0,0,0,0,0,0,0,0,0,0
LOGIC_JUMP -1,-1,-1,-1
JUMP_MODE LOGIC
JUMP_TIMING ASYNC
STROBE 0
```

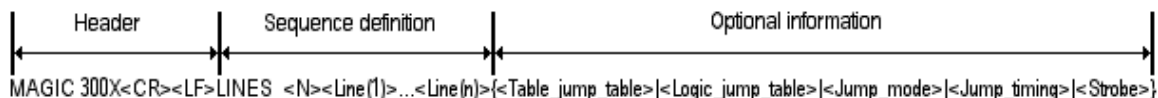



where	contains
Header	MAGIC<space>300x<CR><LF> X = 1 – 8 represents the number of tracks for which sequences are defined in the file.
Sequence definition	LINES<space><N><Line(1)><Line(2)>...<Line(N)> <N> is the number of lines (or steps) that follow.
<Line Description>	<Ch1_file_name>,<Ch2_file_name>,...<ChX_file_name>,<Repeat_Count>[,<F1>[,<F2>[,<F3>...[,<F13>]
<ChX_file_name>	<string> is the waveform or pattern file name for the specified channel. All channels must be present.
<Repeat_Count>	<NR1> is the repeat count for the line. 0 = Infinity 1 to 65536 for repeat count
<F1>	<Wait_Trigger> = <NR1> specifies whether or not to wait for a trigger. 0 = Off 1 = Trigger A 2 = Trigger B 3 = Internal Trigger
<F2>	<Goto-1> = <NR1> specifies whether or not to go to the next line. 0 = Off 1 = On
<F3>	<Logic_jump_target> = <NR1> is the line number for the Logic-Jump 0 = Off -1 = Next -2 = Table Jump 1 to 65535 = Line number
<F4>	<Goto N> = <NR1> is the jump to line N value
<F5>	<Event_Input> = <NR1> specifies the event input 0 = Off (will overrule the Logic_jump_target if selected) 1 = Trigger A 2 = Trigger B 3 = Internal Trigger

where	contains
<F6>   <F13>	Channel Flags <Ch1_Flags> = <string> specifies, in 4 character blocks, channel flag values. Four flag values are specified per flag group – Flag A, Flag B, Flag C, and Flag D. Each flag can have one of five values: N = No Change H = High L = Low T = Toggle P = Pulse Example Flag usage: <F6/Ch1_Flags> = TLHP <F7/Ch2_Flags> = LNPN This will set Channel 1 flags to Toggle, Low, High, and Pulse respectively. The next field will set Channel 2 flags to Low, No Change, Pulse, and No Change respectively.
Optional Information	{<Table_jump_table> <Logic_jump_table> <Jump_mode> <Jump_timing> <Strobe>}
<Table_jump_table>	TABLE_JUMP<space><Jump_target(1)>,<Jump_target(2)>,...<Jump_target(n)><CR><LF> <Jump_target(n)> = <NR1> is the line number to the Table-Jump or 0 (Off). The default is Off.
<Logic_jump_table>	LOGIC_JUMP<space><Jump_on/off(1)>,<Jump_on/off(2)>,<Jump_on/off(3)>,<Jump_on/off(4)><LF> <Jump_on/off(n)> = <NR1> sets the Logic-Jump on or off. <NR1> = 0 is Off, 0 is On, and <0 is Ignore. The default is Ignore.
<Jump_mode>	JUMP_MODE<space>{LOGIC TABLE SOFTWARE}<CR><LF> sets the jump mode. The default is TABLE.
<Jump_timing>	JUMP_TIMING<space>{SYNC ASYNC}<CR><LF> sets the jump mode. The default is ASYNC.
<Strobe>	STROBE<space><NR1><CR><LF> determines whether or not to use the STROBE signal from the EVENT IN connector on the rear panel. <NR1>=0 is Off, ≠0 is On. The default is Off.

## Waveform file format (.wfmX)

The waveform file format (.wfmX) contains all the primary and auxiliary data associated with the waveform data required (for both the hardware and software). The file is a binary XML file containing the metadata information and the waveform sample data. The XML file type is particularly useful with its expandable nature and quick parsing.

Some instruments/applications tag their waveforms with Amplitude and Offset values used to acquire the waveform.

The AWG5200 series allow you to specify the amplitude and offset values to use when playing that waveform.

## Primary requirements

The waveform file contains the following information:

- Marker data
- Waveform data
- Recommended playback parameters including recommended sample rate
- Amplitude and offset
- Samples are interpreted as Little Endian.

## Waveform sample data

The waveform data can consist of the following types of data:

- Samples consisting of single precision float data + 1 byte of marker data.
- Samples consisting of complex (I and Q) data + 1 byte of marker data.

## Waveform metadata elements

Element	Description	Req.	Opt.
<b>DataFile</b>			
Version	The version that waveform was created under. Currently, the proper format for .wfm files is version 0.2. This parameter is contained within the DataFile element with a tag of "version". Proper usage example: <code>&lt;DataFile version="0.2"&gt;</code>	X	
<b>DataDescription</b>			
NumberSamples	The number of samples contained in the waveform (length). It is a "long" integer value, no decimals. Proper usage example: <code>&lt;NumberSamples&gt;4800&lt;/NumberSamples&gt;</code>	X	
MarkersIncluded	Helps determine if markers are included in the data file or not. It is a boolean value. Only "true" and "false" are valid values. Proper usage example: <code>&lt;MarkersIncluded&gt;&gt;true&lt;/MarkersIncluded&gt;</code>	X	
NumberFormat	This value is "Single". Element must be: <code>&lt;NumberFormat&gt;Single&lt;/NumberFormat&gt;</code>	X	
Endian	This value is "Little". Element must be: <code>&lt;Endian&gt;Little&lt;/Endian&gt;</code>		X

Element	Description	Req.	Opt.
Timestamp	A guide for when the waveform was last saved. The element uses Microsoft's standard date and time formatting. Proper usage example: <Timestamp>2016-09-12T13:36:47.2147485-07:00</Timestamp>		X
<b>ProductSpecific</b>			
RecSamplingRate	Indicates the ideal sample rate in Hertz during playback of the stored waveform. If the system setting is enabled to apply recommended settings upon channel assignment, then the recommended sample rate will be applied to the system clock. Proper usage example: <RecSamplingRate>5000000000</RecSamplingRate>		X
RecAmplitude	Indicates the ideal amplitude in pk-pk Volts during playback of the stored waveform. If the system setting is enabled to apply recommended settings upon channel assignment, and if the instrument is capable of setting the amplitude, then the recommended amplitude will be applied to the assigned channel. Proper usage example: <RecAmplitude>1</RecAmplitude>		X
RecOffset	Indicates the ideal offset in Volts during playback of the stored waveform. If the system setting is enabled to apply recommended settings upon channel assignment, and if the instrument is capable of setting an offset, then the recommended offset will be applied to the assigned channel. Proper usage example: <RecOffset>1</RecOffset>		X
RecFrequency	Indicates the ideal frequency in Hertz during playback of the stored IQ waveform. This field is only relevant for waveforms with a Signal Format of IQ. Proper usage example: <RecFrequency>2000000000</RecFrequency>		X
SerialNumber	Indicates the serial number of the instrument that this waveform was saved from. It is only for archival purposes and does not affect software behavior. Proper usage example: <SerialNumber>B0000001</SerialNumber>		X
SoftwareVersion	Indicates the software version that this waveform was saved from. It is only for archival purposes and does not affect software behavior. Proper usage example: <SoftwareVersion>6.0.058.0</SoftwareVersion>		X
UserNotes	This parameter is not being used or populated. There is no location within the software that displays user modifiable notes. However, if the user would like to store information in this parameter, it will be imported. Proper usage example: <UserNotes>My notes go here</UserNotes>		X

Element	Description	Req.	Opt.
SignalFormat	Indicates whether the samples in the file are Real (standard) or Complex (IQ). Valid values are: "Real", "I", "Q", and "IQ". Proper usage example: <code>&lt;SignalFormat&gt;Real&lt;/SignalFormat&gt;</code> Defaults to "Real".		X
<b>CreatorProperties</b>			
name	This field is primarily meant to populate fields in the Plug-in editors. This field it typically empty. Proper usage example: <code>&lt;CreatorProperties name="" /&gt;</code>	X	

### Waveform and marker data

The waveform and marker data immediately follows the Waveform metadata elements. In the file, all data samples are written, then all marker data is written.

For example, if you have 1k samples, then the file would contain 4k bytes (4 bytes per data sample) followed by 1k marker bytes.

**Regular data files.** For regular data files, the data is normalized (-1 to +1) and stored as a float, and the markers as a byte:

D=Data, M=Marker

D1, D2, D3, ...Dn, M1, M2, M3, ...Mn.

**Complex data files.** For complex data files, I and Q data is normalized (-1 to +1) and is stored as floats, and the markers as a byte:

I=I-Data, Q=Q-Data, M=Marker

I1, I2, I3, ...In, Q1, Q2, Q3, ...Qn, M1, M2, M3... Mn

**Marker bits.** Marker bits are stored in LSB fashion: XXXX XXMM (with Marker 1 being the LSB). If there are 4 markers, Marker 4 would be the MSB.

### Waveform examples

**Example 1.** The following is an example of the minimum requirements for the waveform metadata section in a .wfm file.

```
<DataFile version="0.2">
  <DataSetsCollection>
    <DataSets version="1">
      <DataDescription>
        <NumberSamples>4800</NumberSamples>
        <MarkersIncluded>>true</MarkersIncluded>
        <NumberFormat>Single</NumberFormat>
      </DataDescription>
      <ProductSpecific name="">
        <CreatorProperties name="" />
      </ProductSpecific>
    </DataSets>
  </DataSetsCollection>
  <Setup />
</DataFile>
```

---

Waveform data and marker data to immediately follow.

---

**Example 2.** The following is an example of a typical metadata section, including optional parameters, for a waveform metadata section in a .wfmX file.

```

<DataFile offset="000001274" version="0.2">
  <DataSetsCollection>
    <DataSets version="1">
      <DataDescription>
        <NumberSamples>4800</NumberSamples>
        <MarkersIncluded>>true</MarkersIncluded>
        <Timestamp>2016-09-12T13:36:47.2147485-07:00</Timestamp>
      </DataDescription>
      <ProductSpecific name="">
        <RecSamplingRate>5000000000</RecSamplingRate>
        <RecAmplitude>1</RecAmplitude>
        <RecOffset>1</RecOffset>
        <RecFrequency>2000000000</RecFrequency>
        <SerialNumber />
        <SoftwareVersion>6.0.058.0</SoftwareVersion>
        <UserNotes />
        <Thumbnail />
        <SignalFormat>Real</SignalFormat>
        <CreatorProperties name="" />
      </ProductSpecific>
    </DataSets>
  </DataSetsCollection>
  <Setup />
</DataFile>

```

Waveform data and marker data to immediately follow.

---

## MATLAB waveform file format

Tektronix AWG5200 series instruments can read waveform files created with MATLAB (.MAT), a third party software application. MATLAB files can contain multiple waveform data sets (including marker data) and can support files greater than 2 GB. Waveforms created with MATLAB must meet the requirements of an AWG5200 waveform.

This section defines the proper elements and conditions that the MATLAB file must be met to create an AWG waveform file.

### MATLAB versions supported

The following versions of MATLAB files are supported.

- MATLAB version 7.3 (supports files larger than 2 GB)
- MATLAB version 5 (supports files less than 2 GB)

---

**NOTE.** Verify that MATLAB is configured to save as one of the supported versions. (The default selection may not be appropriate.)

*Waveform files saved as other versions will not import.*

---

### AWG MATLAB waveform elements

Waveform elements for an AWG MATLAB file format waveform must be contained in the same .mat file.

Each waveform will be grouped together by a trailing numerical value.

- For example - given the following elements: Waveform\_Name\_1, Waveform\_Data\_1, Waveform\_Name\_2, Waveform\_Data\_2, Waveform\_M1\_2, Waveform\_M2\_2, two complete waveforms can be formed:
  - The first waveform will have the name identifier from Waveform\_Name\_1 and the data held in Waveform\_Data\_1.
  - The second waveform will have the name identifier from Waveform\_Name\_2 and the data held in Waveform\_Data\_2. Additionally, the second waveform will have Marker 1 and Marker 2 data.

**Table 8: MATLAB required elements**

Element	Condition
Waveform_Name_#	The MATLAB file must have the "Waveform_Name_#" specified. The "Waveform_Name_#" must contain a string value denoting the waveform name.
Waveform_Data_#	The AWG MATLAB file must have the "Waveform_Data_#" specified. The "Waveform_Data_#" must contain an array of data values (representing waveform samples) in one of the types: double, single, or UInt16. Ideally, double and single should have values scaling from -1 to 1, and UInt16 should have values ranging from 0 to 65535.



**Table 9: MATLAB optional elements**

Element	Condition
Waveform_M1_#	<p>The AWG MATLAB file can contain marker 1 data, having the "Waveform_M1_#" specified.</p> <p>The "Waveform_M1_#" must contain a UInt8 array of marker values for the waveform's Marker 1. Only 1 and 0 are considered valid values.</p> <p>The length of the marker array must match that of the AWG MATLAB file format waveform data array length.</p>
Waveform_M2_#	<p>The AWG MATLAB file can contain marker 2 data, having the "Waveform_M2_#" specified.</p> <p>The "Waveform_M2_#" must contain a UInt8 array of marker values for the waveform's Marker 2. Only 1 and 0 are considered valid values.</p> <p>The length of the marker array must match that of the AWG MATLAB file format waveform data array length.</p>
Waveform_Sampling_Rate_#	<p>The AWG MATLAB file can contain the sampling rate, having the "Waveform_Sampling_Rate_#" specified.</p> <p>The "Waveform_Sampling_Rate_#" must contain a "Double" value, indicating the waveform's suggested sampling rate.</p> <p>The specified sampling rate is the waveform's recommended sampling rate, but it will not directly change any sampling rate settings of the instrument.</p>
Waveform_Amplitude_#	<p>The AWG MATLAB file can contain the waveform amplitude, having the "Waveform_Amplitude_#" specified.</p> <p>The "Waveform_Amplitude_#" must contain a "Double" value, indicating the unique waveform's suggested amplitude.</p> <p>The specified amplitude is the waveform's recommended amplitude, but will not directly change any amplitude settings of the instrument.</p>
Waveform_Signal_Format_#	<p>The AWG MATLAB file can contain the waveform signal format having the "Waveform_Signal_Format_#" specified.</p> <p>The "Waveform_Signal_Format_#" must contain a 'String' value indicating the unique waveform's signal format.</p> <p>Signal format indicates whether a Waveform is of the format type: Real, I, or Q.</p>

## MATLAB waveform file example

The following MATLAB coding example demonstrates how to create a MATLAB file that:

- creates a small, simple sinusoidal waveform with markers
- saves the waveforms into separate files
- saves the waveforms into a single file

### MATLAB waveform coding example

```
%% Create Sinusoid

x = 2399;
t = 0:1:x;
baseWfm = sin(2*pi*1/x*t); % Generate Sine Wave
baseMarkers = uint8(square(2*pi*1/x*t,50));

%% Create Waveform 1 (Double)
Waveform_Name_1 = 'MyDoubleWfm';
Waveform_Data_1 = baseWfm; %already a double array
Waveform_M1_1 = baseMarkers; %already uint8 array
Waveform_M2_1 = baseMarkers;
save('AWG_Double', '*_1', '-v7.3'); % MAT 7.3 Can save > 2GB

%% Create Waveform 2 (Single)
Waveform_Name_2 = 'MySingleWfm';
Waveform_Data_2 = single(baseWfm);
save('AWG_Float', '*_2', '-v7.3');

%% Save All Waveforms
save('All_Wfms.mat', 'Waveform_*', '-v7.3');
```

## MATLAB IQ file example

The following MATLAB coding example demonstrates how to create a MATLAB file that:

- creates a complex signal
- creates and saves an I waveform
- creates and saves a Q waveform

### MATLAB IQ file coding example

```
clear;clc;

%% Create Complex Signal
nConstellationPoints=4; % Number of Constellation Points
numSymbols=1000; % Number of Symbols
samplesPerSymbol=10; % Samples per symbol
% For the Symbol Rate of 1M the Sampling Rate would be 10M
% Symbol Rate = Sampling Rate / Samples per Symbol

alpha=0.35; % RC Filter Rolloff (Alpha)
convLength=21; % Convolution Length
baseDataPattern=mod(randi(nConstellationPoints,1,numSymbols),nConstellationPoints); % Creates
the base data
y=pskmod(baseDataPattern,nConstellationPoints, pi/4); % Creates the PSK modulation
rrcfilter = rcosdesign(alpha,convLength, samplesPerSymbol); % Create the filter coefficients
IQData = upfirdn(y, rrcfilter, samplesPerSymbol); % Filter and Interpolation

clear nConstellationPoints numSymbols samplesPerSymbol alpha convLength
clear baseDataPattern y rrcfilter

%% Retrieve IQ Data
iData = real(IQData);
```

```
qData = imag(IQData);

%% Normalize to +1/-1
maxI = max(abs(iData));
maxQ = max(abs(qData));
maxMax = max(maxI, maxQ);
iData = iData / maxMax;
qData = qData / maxMax;

IQData = iData + 1i*qData; % Re-set I and Q data
plot(IQData)

clear maxI maxQ maxMax

%% Create I Waveform
Waveform_Name_1 = 'MyI_Waveform';
Waveform_Data_1 = iData;
Waveform_Sampling_Rate_1 = 10e9;
Waveform_Signal_Format_1 = 'I';

save('MAT - MAT5 - AWG - I Waveform', '*_1', '-v6');
save('MAT - HDF5 - AWG - I Waveform', '*_1', '-v7.3');

%% Create Q Waveform
Waveform_Name_2 = 'MyQ_Waveform';
Waveform_Data_2 = qData;
Waveform_Sampling_Rate_2 = 10e9;
Waveform_Signal_Format_2 = 'Q';

save('MAT - MAT5 - AWG - Q Waveform', '*_2', '-v6');
save('MAT - HDF5 - AWG - Q Waveform', '*_2', '-v7.3');
```

```
%% Save Files
save('MAT - MAT5 - AWG - Complex Waveforms.mat', '*_1', '*_2', '-v6');
save('MAT - HDF5 - AWG - Complex Waveforms.mat', '*_1', '*_2', '-v7.3');

%% Create Invalid Waveforms
%Too many waveforms
Waveform_Name_3 = 'TooManyWfms';
Waveform_Data_3 = Waveform_Data_2;

save('MAT - MAT5 - AWG - Invalid Too Many Complex Waveforms', '*_1', '*_2', '*_3', '-v6');
save('MAT - HDF5 - AWG - Invalid Too Many Complex Waveforms', '*_1', '*_2', '*_3', '-v7.3');

%Mismatching Sample Rates
Waveform_Sampling_Rate_2 = 1e9; %1G & 10G

save('MAT - MAT5 - AWG - Invalid Complex SR Mismatch Waveforms', '*_1', '*_2', '-v6');
save('MAT - HDF5 - AWG - Invalid Complex SR Mismatch Waveforms', '*_1', '*_2', '-v7.3');
```



## Front-panel controls

The instrument features the following [front-panel](#) controls.

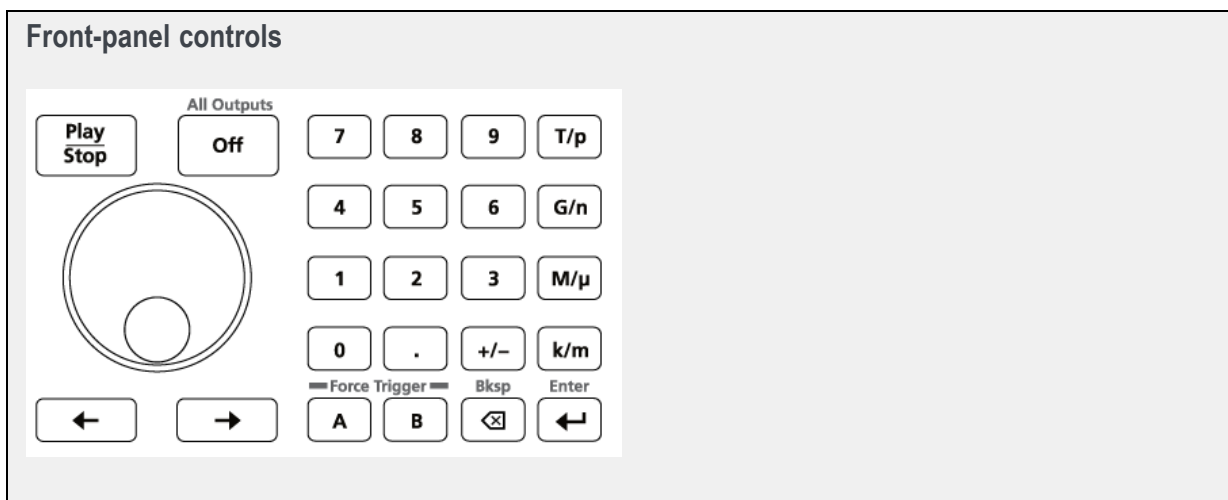

Table 10:

Item	Description
Play/Stop	<p>The Play/Stop button starts or stops playing the waveform.</p> <p>The Play button displays the following lights:</p> <ul style="list-style-type: none"> <li>■ No light – no waveform playing</li> <li>■ Green – playing waveform</li> <li>■ Flashing green – preparing to play waveform</li> <li>■ Amber – play out temporarily inhibited due to settings change</li> <li>■ Red – Error preventing play out</li> </ul> <p>When a waveform is playing, it is only present at the output connectors if the following conditions are met:</p> <ul style="list-style-type: none"> <li>■ The channel is enabled</li> <li>■ The All Outputs Off is not active (outputs are connected)</li> </ul> <p>The Play button icon in the screen interface has additional indicators for more waveform playout status. See <a href="#">Play button (icons)</a> (see page 15).</p>
General purpose knob	<p>The general purpose knob is used to increment or decrement values when a setting is enabled (selected) for change.</p> <p><b>NOTE.</b> <i>The general purpose knob operation mimics the actions of the up and down arrow keys on a keyboard as defined by the Windows operating system. Because of this, rotating the knob when a desired control is not selected may result in seemingly odd behavior of the control or accidental changes to some other control.</i></p>
Left and Right Arrow buttons	<p>The Arrow buttons are used change (select) the focus of the cursor in the Frequency control box when and IQ waveform is assigned to the channel. The Digital Up Converter (DIGUP) must be licensed to assign IQ waveforms to a channel.</p>

Table 10: (cont.)

Item	Description
Numeric Keypad	<p>The numeric keypad is used to directly enter a numeric value into a selected control.</p> <p>Units prefix buttons (T/p, G/n, M/μ, and k/m) are used to complete an input with the numeric keypad. You can complete your entry by pushing one of these prefix buttons (without pressing the Enter key).</p> <p>If you push the units prefix buttons for frequency, the units are interpreted as T (tera-), G (giga-), M (mega-), or k (kilo-). If you push the buttons for time or amplitude, the units are interpreted as p (pico-), n (nano-), μ (micro-), or m (milli-).</p>
Force Trigger (A and B)	<p>The A and B Force Trigger buttons generate a trigger event. This is only effective when the Run mode is set to Triggered or Triggered Continuous.</p>
All Outputs Off	<p>The All Outputs Off button provides a quick disconnect of the analog outputs, marker outputs, and Auxiliary outputs (whether those outputs are enabled or not). All Outputs Off overrides the output enable controls.</p> <p>Other outputs are not affected.</p> <p>When activated, this button lights, the outputs are electrically disconnected, and the channel lights are turned off.</p> <p>When the All Outputs Off is deactivated, the outputs return to their defined state.</p>

## Front-panel connectors

The instrument features the following [front-panel connectors](#).

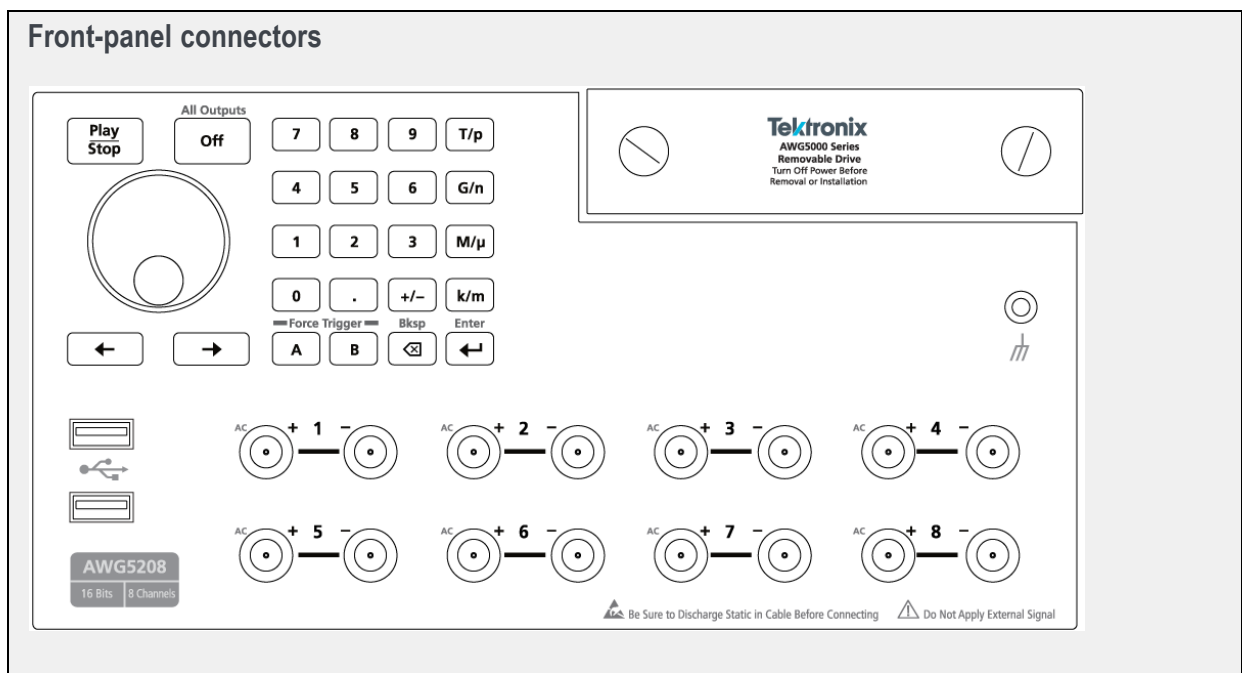



Connector	Description
Analog + and – Output AWG5202 – two channels AWG5204 – four channels AWG5208 – eight channels	These connectors supply differential analog signals. The connectors are direct outputs from the internal DAC.  The channel LEDs light to indicate when the channel is enabled and the output is electrically connected. The LED color matches the user defined waveform color.  The output connector utilizes the Planar Crown® Universal Connector System, providing you the ability to easily replace a damaged connector.  Each connector pair provides a single-ended AC output (via the channel's + output connector).  The AC output provides additional amplification and filtering. The differential outputs and the AC output cannot be used simultaneously. The output is selected in the Channel Setup menu.  The instruments ship with SMA type adapters installed but you also have the ability to use a variety of different connector types.
USB	Two USB2 connectors.
Removable hard disk drive (HDD)	The HDD contains the operating system, product software and all user data. By removing the HDD, user information such as setup files and waveform data is removed from the instrument.
Chassis ground	Banana type ground connection.

## Rear-panel connectors

The instrument features the following [rear-panel connectors](#):

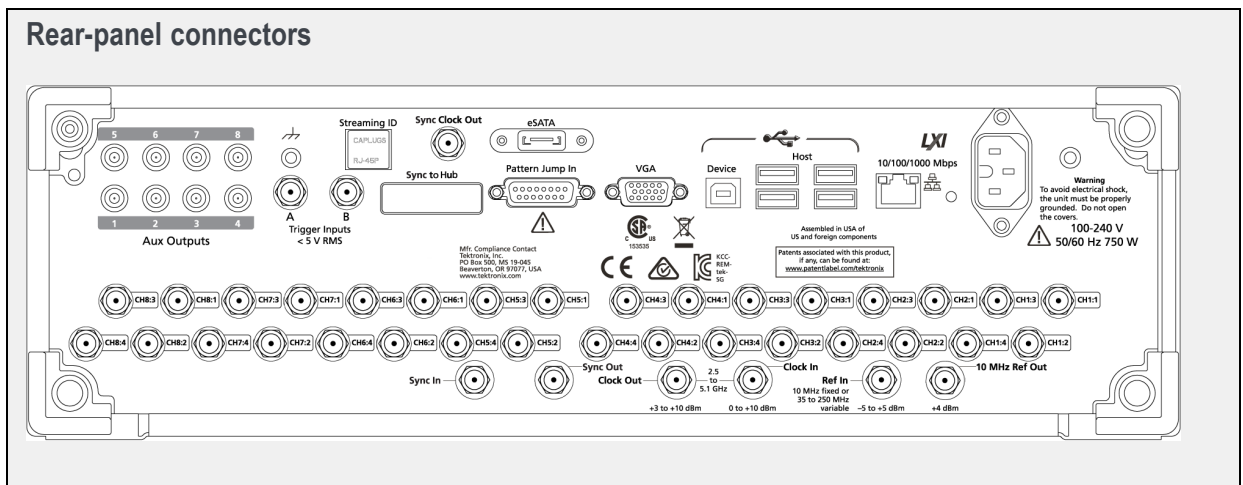

Connector	Description
Aux Outputs AWG5202 and AWG5204 – Four provided AWG5208 – Eight provided	SMB connectors to supply output flags to mark the state of sequences. These outputs are not affected by the All Outputs Off state.
Streaming ID	RJ-45 connector for future enhancement.
eSATA port	eSATA port to connect external SATA devices to the instrument.
Marker outputs Four markers provided with each channel	These SMA type connectors supply marker signals. These outputs are affected by the All Outputs Off state.
Sync Clock Out	SMA type output connector used to synchronize the outputs of multiple AWG5200 series instruments. This output is not affected by the All Outputs Off state.
Sync Out	Connector for future enhancement.
Sync In	SMA type connector to input an external synchronization signal from an AWG5200 series instrument.
LAN	RJ-45 connector to connect the instrument to a network. TCP/IP port 59557 is required to be open for the WCF (Windows Communication Foundation) connection. For example, when communicating through a router.
VGA	VGA video port to connect an external monitor to view a larger copy of the instrument display (duplicate) or to extend the desktop display. To connect a DVI monitor to the VGA connector, use a DVI-to-VGA adapter.
USB Host	Four USB3 Host connectors (type A) to connect devices such as a USB mouse, keyboard, or other USB devices. Tektronix does not provide support or device drivers for USB devices other than the mouse and keyboard optional accessories.
USB Device	USB Device connector (type B) to connect an external device, such as a printer. Tektronix does not provide support or device drivers for USB devices.
Pattern Jump In	15-pin DSUB connector to provide a logic pattern used for sequencing. <a href="#">See Pattern Jump In (see page 185)</a> pin assignment.
Sync to Hub	Connector for future enhancement.
Clock In	SMA type input connector to provide a variable clock signal.
Clock Out	SMA type connector to provide a high speed clock that is related to the sample rate. This output is not affected by the All Outputs Off state.
Ref In	SMA type input connector to provide a reference timing signal (variable or a fixed 10 MHz).
10 MHz Reference Out	SMA type output connector to provide a 10 MHz reference timing signal. This output is disabled when the system is set to use an external clock signal. This output is not affected by the All Outputs Off state.

Connector	Description
Trigger Inputs A and B	SMA type input connectors for external trigger signals.
Power	Power cord input.

Pattern Jump In connector			
Pin number	Signal	Pin number	Signal
1	GND	9	GND
2	Data bit 0	10	Data bit 4
3	Data bit 1	11	Data bit 5
4	Data bit 2	12	Data bit 6
5	Data bit 3	13	Data bit 7
6	GND	14	GND
7	Strobe	15	GND
8	GND		



## Functions home window overview

The Functions mode is used to generate basic waveshapes, such as sine waves, square waves, and triangle waves, allowing you to quickly play a signal out of the analog outputs.

Generating a basic waveshape is relatively easy. Simply select the waveshape and then set its characteristics.



### Toolbar

The toolbar provides access to various setup actions. The AWG mode and Functions mode utilize the same Toolbar. Any action taken by the buttons in the toolbar affects both modes. For example, restoring the default setup affects both the Functions mode and AWG mode.

See [Toolbar \(see page 19\)](#) in the AWG mode section for details.

## Play/Stop

The Play/Stop button starts and stops the playout of a waveform. This function is the same as the front-panel Play button. The screen icon changes appearance to indicate the Run Status.

See [Run state icons \(see page 15\)](#) in the AWG mode section and the [Front-panel controls \(see page 181\)](#) section for descriptions of the indicators.

## Workspace

The Functions workspace is controlled by the workspace tabs.

- Home displays the controls and settings to generate the basic waveshapes.
- Utilities is a global tab between the AWG mode and the Functions mode. See Utilities in [AWG workspace \(see page 6\)](#).

## Enable channel outputs

The Channel On/Off button operates the same for the Functions mode as the AWG mode. See the section [Enable outputs / relay state \(see page 55\)](#) for information about the various modes and displays.

## Channel output path selection

The Channel output path button operates the same for the Functions mode as the AWG mode. See the section [Channel output path \(see page 57\)](#) for information about the various modes and displays.

## Notes about the Function generator mode

Additional items to note about using the Function generator mode:

- The Frequency / Period are always coupled
- A message is displayed to warn you if the selected settings are not using the full DAC range. Using a combination of voltage settings (Amplitude, High and Low values) that result in a waveform amplitude that is less than 250 mV (one half the full 500 mV range) causes a reduction of resolution. Using an Offset value other than 0 V has the same effect.
- The graphical display includes a right-click menu to:
  - Show cursors
  - Set the Y-axis units to either Volts or Normalized
  - Set the X-axis units to either Samples or Seconds
  - Show the background grid
- As with the AWG mode, the Functions mode has the Status area at the bottom of the screen (for messages) and the All outputs off button to quickly disconnect the analog output connectors.
- Markers can not be created.

## Diagnostics

Two types of diagnostics are provided to verify the functionality of your instrument:

- Power-on self test (POST) – Every time you power on the instrument, the instrument automatically performs the POST internal diagnostics.
- Full Diagnostics – You can run the entire set of diagnostics routines (or a subset) from the System menu.

### Selecting the diagnostic routines

Select the **Utilities** workspace tab, then **Diag & Cal**. Then select the **Diagnostics & Calibration** button. Click the **Diagnostics** button to display the diagnostic routines.

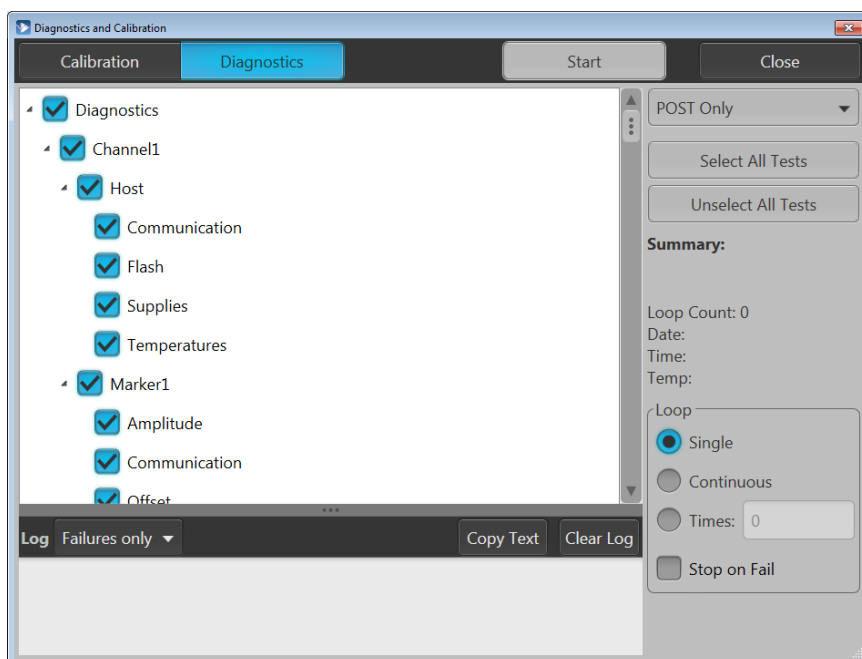

The left side of the diagnostic screen lists the tests available. The list is dependent on the type of diagnostics selected to run, POST Only or Full diagnostics

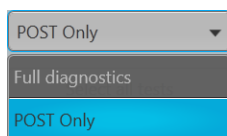

If POST Only is selected, all POST diagnostic tests are preselected, but you can deselect categories of tests, but not tests within a category.

If Full diagnostics is selected, no tests are preselected. You can check the categories of tests you wish to perform. In the full diagnostic mode, you can select and deselect categories and tests within a category.

You can also use the Select all tests or Unselect all tests buttons to easily reset the test selections.

## Loop settings

Use the loop choices to determine the test cycles.

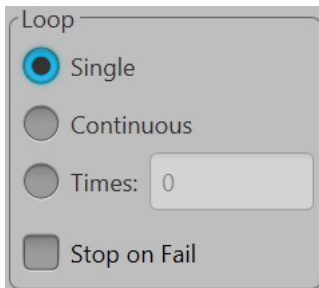

- **Single** makes one pass through the selected tests.
- **Continuous** continually runs through the selected tests until aborted.
- **Times** lets you define how many times to run the selected tests.
- **Stop on Fail** stops the diagnostics if a selected test fails, regardless of the Loop selection.

## Summary

The summary section provides a quick review of the tests (Pass or Fail) and system information. This information is blank until a diagnostic routine is run.

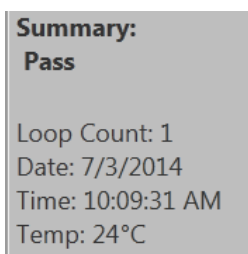

## Log

The Log area provides the results of the diagnostic tests. You can choose the what to display:

- **All results** lists the results of every selected diagnostic test, including the date, time, and temperature.
- **Failures only** lists only those tests that fail.



The **Copy text** button places the log information into the Windows clipboard, which you can then paste into other applications.

**Clear log** simply empties the results.



## Calibration

Your instrument was calibrated at the factory and tested before shipping. Changes in operating temperature can affect hardware performance, so if your application requires optimum performance, you should run the self-calibration utility before performing critical tests. The instrument automatically alerts you if the current internal temperature is more than 6 °C above or below the temperature at which the calibration was last run.

The calibration utility is a one-button operation and does not require any external signals or equipment. Before calibrating, make sure the instrument's internal temperature has stabilized. Allow the instrument to run for at least 20 minutes under the environmental conditions in which it will operate after the calibration.

Select the **Utilities** workspace tab, then **Diag & Cal** to display the Diagnostics and Calibration dialog screen showing the current status of the instrument. Click the **Diagnostics & Calibration** button to display the Diagnostics and Calibration screen and select **Calibration**. All available tests and adjustments are run; you are not allowed to select or unselect the items in the calibration list.

Click **Start** to begin the process. The **Start** button changes to **Abort** while the calibration is in process. At any time, you can click the **Abort** button to stop the calibration and revert to the previous calibration data. If the calibration is allowed to finish and there are no errors, the new calibration data is applied. The pass/fail result is shown in the right-hand panel of the Calibration page, along with the associated date, time, and temperature information.

Calibration data is automatically stored in non-volatile memory. If for some reason you don't want to use the calibration data from the most recent self-calibration, click the **Restore factory cal** button. This loads the original calibration data shipped with the instrument.



## Enhancements for your instrument

Your instrument can be enhanced by several different methods:

- **Software enhancements:** Enhancements ordered at the time of your purchase are pre-installed. These can also be purchased post sales and may require the installation of software in addition to installing a license to activate.
- **Hardware enhancements:** Features that require/enable hardware on the instrument. These can be ordered with the purchase of the instrument or as a post-purchase addition.

---

**NOTE.** *Some hardware enhancements may require the installation of additional hardware.*

---

- **Plug-ins:** Applications that enhance a host application and require a license to activate. (In this case, the AWG5200 instrument application is enhanced). Plug-ins designed to operate with an AWG5200 series instrument are also able to operate with the SourceXpress Waveform Creation software. Plug-ins with a floating license can be moved between instruments or SourceXpress.

A Licensing scheme (via the Tektronix web site) is used to host your license files where you can check-out or check-in your purchased licenses.

See [Licensing overview \(see page 197\)](#).

To view and install licenses, select About my AWG from the Utilities menu.

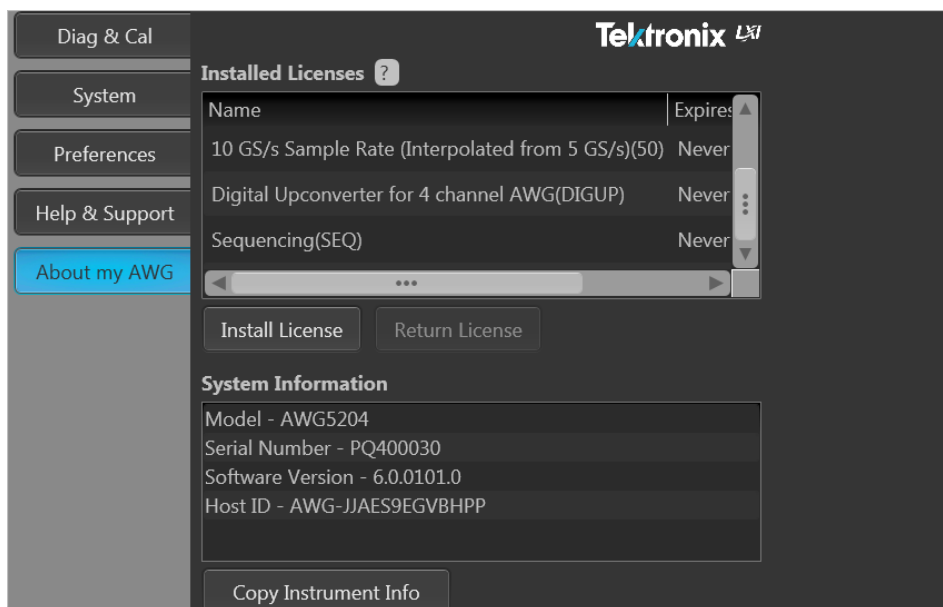



## Licensing overview

License files are used to enable optional features. These can be software features or a hardware features. For example, a waveform plug-in or sequencing.

A Licensing scheme is used to host your license files. The product license administration is through Tektronix Asset Management System (TekAMS). TekAMS has an easy to use web based interface that provides:

- Inventory of all the licenses in the company account
- Ability to check out a floating license
- Ability to check in a floating license

The Tektronix Asset Management System is available at <http://www.tek.com/products/product-license>.

To view and install licenses, select About my AWG located in the Utilities tab.

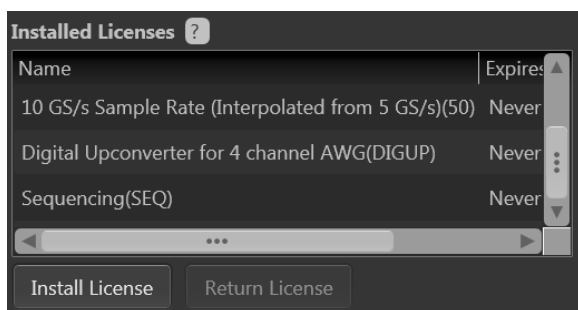

Generally, to properly install and activate a plug-in, follow these steps.

1. Purchase a license from Tektronix. See [How to purchase a license \(see page 197\)](#).
2. Store the license file in a location available to the application. This can be on the instrument's drive, a USB flash drive, or any networked drive.
3. If not already installed, obtain the software installation file. For instance, waveform plug-ins have their own installation file and are available for download from the Tektronix web site.
4. Install the license file. See [How to install a plug-in license \(see page 199\)](#).

## How to purchase a license

Contact your local Tektronix Account Manager to purchase a license. After purchasing, you will receive an email listing the licenses purchased. The email also contains the URL to the Tektronix Asset Management System (TekAMS) that enables you to manage your licenses.

Floating Licenses provide the ability to move the license from an instrument or a personal computer to another by checking in a license from an instrument or PC and checking it out to another.

The Tektronix Asset Management System (<http://www.tek.com/products/product-license>) provides an inventory of the license(s) in your account. If a license is a Floating license, it also enables you to check out or check in the license.

There are two different types of licenses available for plug-ins:

<b>License type</b>	<b>Description</b>
Node-Locked License	This license is permanently assigned to a specific Hostid or product model/serial number. Node Locked Licenses provide your own copy of the application on your instrument or personal computer.
Floating License	This license can be moved between different Hostids or product models. Use the Tektronix Asset Management system to check in and check out floating licenses.



## How to install a license

License files are used to enable optional applications.

---

**NOTE.** Applications may have been previously installed, but without a license, you cannot create waveforms.

---

1. Select About my AWG located in the Utilities tab.
2. Select the Install License button to display the license file selection screen and browse to the location where you've stored the license file.

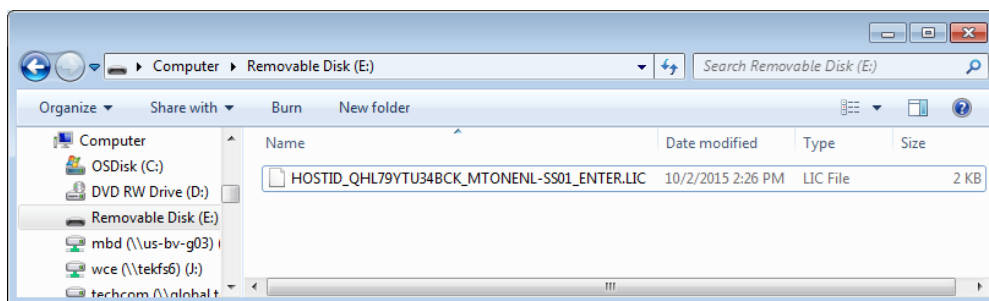

3. Select the license file and select Open.
4. After the successful installation is finished, the name of the feature is listed along with the expiration date and time.

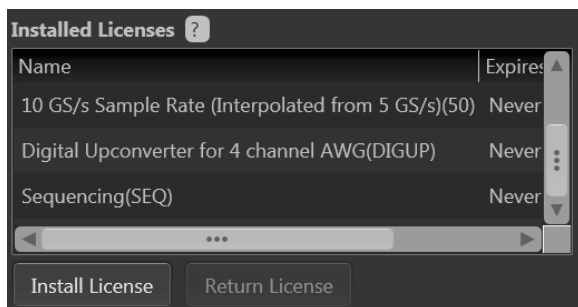

Floating licenses display the expiration date for that feature. The expiration date for a floating license is defined when the license is checked out from the Tektronix Asset Management system. After the license expires, the application is automatically disabled and the license on the TekAMS is free to be assigned to a different host.

Node locked license have no expiration date.

## How to return a license

You can return a floating license to the Tektronix Asset Management System (TekAMS). After a floating license is returned to the TekAMS, it becomes available to be assigned to a different host.

---

**NOTE.** *Only floating licenses can be returned and reassigned to different hosts.*

---

When assigning a license, you need to specify the host id or instrument and include the duration the feature is to be enabled on the host. This is all done on the Tektronix Asset Management System (TekAMS) web site. After the license expires, the feature is automatically disabled on the host and the license on the TekAMS is free to be assigned to a different host.

1. Select About my AWG in the Utilities tab. Under Installed Licenses, select the license to return and select Return License. (A confirmation box is displayed in order to continue.)

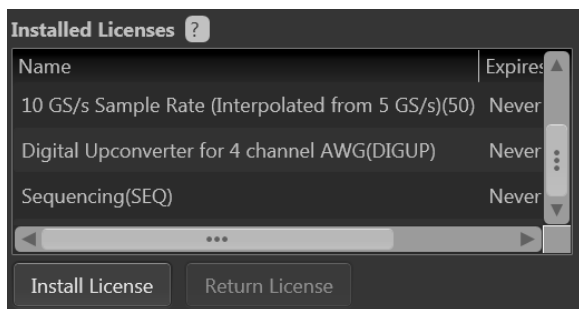

After confirming to continue, a license exit file will be created. You need to provide a name for the exit file and browse to a location to save the license exit file.

---

**NOTE.** *The next step creates and saves the exit file. Once the exit file is created, the application will immediately become nonfunctional (unable to compile).*

---

2. Browse to the location where you would like to place the exit file (for example, a network drive or a USB flash drive), and select Save to generate the exit file.
3. Login to your account on TekAMS (Tektronix Asset Management system) and upload the exit file. Once the license is returned successfully, it can be re-assigned to a different host or instrument.

# Index

## Symbols and Numbers

10 MHz reference output, 184  
2x interpolation, 65

## A

A (external trigger), 75  
about my AWG, 14  
AC amplified output path  
  amplitude, 59  
AC output, 183  
adding a sequence, 47  
adding a waveform, 23  
adding multiple waveforms, 23  
adjust skew, 80  
aggressor, 46  
all outputs off, 5  
all outputs off button, 182  
all signal outputs  
  phase adjustment, 83  
amplitude  
  AC amplified, 59  
  AC direct, 58  
  DC high BW output, 57  
  DC high volt output, 58  
analog outputs  
  AC output, 183  
  front-panel connectors, 183  
  LED color, 183  
apply coefficients, 28  
apply corrections, 28  
apply recommended settings, 54  
arrow buttons, 181  
assign a waveform to a  
  channel, 29  
assign sequence track, 49  
async, 78  
asynchronous trigger timing, 78  
aux outputs, 184  
AWG  
  capture/playback tab, 6  
  home tab, 6  
  sequence tab, 6  
  setup tab, 6

  utilities tab, 6  
AWG mode  
  overview, 5  
  selecting, 5  
AWG workspace, 6

## B

B (external trigger), 75  
Baseband IQ interpolation, 68  
basic keywords, 132  
basic waveform editor, 125  
basic waveshapes  
  generating, 187  
batch compiler  
  for sequences, 103  
brightness controls, 14

## C

calibration, 13  
  temperature, 13  
  utility, 193  
capacitive touchscreen, 1  
capture, 110  
capture signals from  
  instruments, 118  
capture/playback, 110  
  adding signals from files, 115  
  adding signals from waveform  
  list, 117  
  capture I/Q data, 111  
  capturing signals from  
  instruments, 118  
  compile, 122  
  connect to oscilloscope, 119  
  connect to spectrum  
  analyzer, 121  
  editing signals, 113  
capture/playback tab  
  AWG, 12  
Center Frequency, 68  
change units, 16  
channel  
  skew, 80  
  channel color, 63  
  channel coupling, 61  
  channel markers, 60  
  channel output path  
    AC, 57  
    DC amplified, 57  
    direct, 57  
  channel resolution, 61  
  channel setup, 54  
  channel skew, 81  
  channels  
    enable all, 53  
  chassis ground, 183  
  clock  
    external, 71  
    internal, 70  
  clock and reference selections, 70  
  clock in, 184  
  clock out, 71  
    frequency, 73  
  clock selections, 70  
  clock setup, 69  
  coefficients, 28  
  coefficients file  
    apply, 40  
  color  
    front-panel LEDs, 63  
    markers, 63  
    waveforms, 63  
  connectivity support  
    IVI drivers, 4  
    TekVISA, 4  
  connectors  
    front-panel, 182  
    rear-panel, 183  
  continuous, 74  
  controlling your AWG, 1  
  correction file  
    apply, 40  
  correction files, 28  
  corrections, 28  
  couple channel settings, 61  
  couple settings, 54  
  coupled sequence, 95

- create
  - IQ waveforms, 22
- create sequence, 88
- cursor display, 18
- cursors, 6

## D

- DAC modes
  - Mix, 67
  - NRZ, 67
  - RZ, 67
- DAC options, 65
- DDR
  - Double Data Rate, 65
- default layout, 21
- default setup
  - restore, 20
- delay
  - marker, 82
  - markers, 80
- detect actual frequency, 70
- diagnostics, 13
  - log, 190
  - loop settings, 190
  - summary, 190
  - utility, 189
- Digital up conversion
  - DIGUP, 65
- DIGUP, 67
  - Digital up conversion, 67
- disable outputs, 55
- display
  - external, 2
- docking, 19
- documentation, 2
- Double Data Rate
  - DDR, 67
- drag and drop, 16
- duplicate display, 184
- dynamic loading
  - tracks, 90

## E

- edit sequence, 51
- edit subsequence, 89
- enable all channels on play, 53

- Enable instrument synchronization, 9
- enable outputs, 55
- enhancements, 195
- equation editor
  - basic keywords, 132
  - imitations, 130
  - math functions, 149
  - math operators, 150
  - overview, 128
  - waveform functions, 133
- error message controls, 14
- error messages
  - hiding, 14
- eSATA port, 184
- event input, 91
- event jump, 99
- event jump to, 91
- extend display, 184
- external 10MHz, 70
- external clock, 71
- external clock details, 71
- external clock input, 184
- external display, 2
- external monitor, 184
- external reference details, 70
- external trigger
  - impedance, 77
  - level, 77
  - polarity, 77
  - timing, 77
- external variable, 70

## F

- factory calibration
  - restore, 193
- file and utilities
  - functions mode, 188
- file formats, 23
  - construction of, 165
  - .mat, 173
  - .seq, 166
  - .wfm, 168
- file types, 23
- flag outputs, 100
- flag repeat
  - sequences, 93
- flag stability, 102

- flag timing, 101
- flags, 100
- floating license, 198
- font size, 21
- force jump, 7
  - force jump here, 96
  - force jump to, 94
- force jump here, 96
- force jump to, 94
- force trig, 74
- force trigger, 6
- force trigger button, 182
- forcing jumps, 93
- formats
  - valid files, 23
- front-panel
  - connectors, 182
- front-panel controls, 181
- front-panel LEDs
  - color, 63
- full diagnostics, 189
- functions mode
  - overview, 187
  - selecting, 187

## G

- gated, 74
- general purpose knob, 181
- general settings, 53
  - apply recommended settings, 53
  - enable all channels on play, 53
- go to, 91
- go to jump, 99
- GPIB address, 13
- graphical interface features, 15
- grid display, 188
- ground, 183
- GUI features, 15

## H

- hard drive
  - front-panel, 183
- help button, 21
- home tab
  - IQ waveform, 8

- sequence, 7
  - waveforms, 6
- I**
- I/Q data files, 110
  - I/Q modulator, 67
  - I/Q signals
    - compile, 122
  - I/Q waveform
    - importing, 111
  - impedance
    - trigger, 77
  - import
    - analog waveform, 26
    - digital waveform, 26
    - IQ waveform, 27
    - IQ waveforms, 22
    - waveform requirements, 165
  - import sequence, 47
  - import waveform, 23
  - install a license, 199
  - install licenses, 14
  - install options, 14
  - instrument information, 14
  - instrument interface, 5
  - interface
    - AWG mode, 5
    - functions mode, 187
  - internal trigger, 75
    - interval, 76
  - interval
    - internal trigger, 76
  - IQ waveform
    - import, 27
  - IQ waveform display, 8
  - IQ waveforms
    - create, 22
    - importing, 22
- J**
- jitter reduction, 71
  - jump execution order, 99
  - jump timing, 96
    - jump at end of waveform, 97
    - jump immediately, 97
- L**
- LAN connector, 184
  - last setup, 21
  - layout
    - default, 21
  - LED color
    - analog outputs, 183
  - left mouse click, 16
  - length, 92
  - level
    - trigger, 77
  - license
    - install, 199
    - purchase, 197
    - reassign, 200
    - return, 200
    - types, 198
    - uninstall, 200
  - license file, 197
  - licenses, 14
  - licensing, 197
  - lock display, 13
  - loop settings, 190
- M**
- marker
    - alignment, 60
    - delay, 80
    - pulse width, 60
    - timing, 60
  - marker color, 63
  - marker delay, 82
  - marker display, 18
  - marker output
    - front-panel connector, 184
  - markers, 60
    - modify, 35
  - master, 84
  - .mat
    - file format, 173
  - .mat format, 166
  - math functions, 149
  - math operators, 150
  - MATLAB
    - IQ file coding example, 177
    - IQ file example, 177
    - optional elements, 175
    - required elements, 174
    - versions supported, 173
    - waveform coding
      - example, 176
    - waveform elements, 174
    - waveform file example, 176
  - MATLAB waveform files, 173
  - minimum trigger uncertainty, 79
  - Mix, 67
  - modify markers, 35
    - pattern type, 36
  - modify waveform, 31
  - modules, 124
  - mouse click
    - left, 16
    - right, 16
  - multi-sequence select, 49
  - multi-waveform select, 27
- N**
- node-Locked license, 198
  - normalize waveform, 26
  - normalized
    - Y axis, 18
  - NRZ, 67
  - numeric keypad, 182
  - numerical control settings, 16
- O**
- offset, 31
  - open file, 20
  - open setup, 20
  - option key, 195
  - options, 195
  - options and upgrades, 195
  - output condition, 15
  - output flags, 100
  - output options, 64
  - output path, 57
  - output value
    - sequence end, 64
    - when stopped, 64
    - while waiting, 64
  - outputs
    - enable/disable, 55

- P**
- pan, 17
  - panel resizing, 19
  - pattern, 31
  - pattern jump, 88
    - edit, 97
  - pattern jump in, 184
  - pattern jump input
    - strobe edge, 77
  - pattern jump table, 98
  - performance verification, 3
  - phase adjustment
    - all signal outputs, 83
  - play button
    - indicators, 15
  - play/stop button, 188
  - playback
    - I/Q data, 110
  - plug-ins, 195
    - basic waveform, 125
    - table editor, 160
  - polarity
    - trigger, 77
  - port for WCF, 184
  - POST, 189
  - power-on self test, 189
  - precompensation plug-in, 164
  - precompensation tab, 14
  - product software, 2
  - programmable interface, 13
  - programming commands, 3
  - properties
    - sequence, 52
    - waveform, 38
  - pull down lists, 16
  - purchase a license, 197
- R**
- rear-panel
    - connectors, 183
  - recommended amplitude, 52
  - recommended frequency, 39
  - recommended offset, 39
  - recommended sample rate, 52
  - recommended settings, 53
  - reference
    - external, 69
    - internal, 69
  - reference clock input, 184
  - reference in, 184
  - reference selections, 70
  - reference signal, 69
  - relative timing
    - channels, 80
    - markers, 80
  - relay state, 55
  - release notes, 2
  - removable hard drive, 183
  - repeat count, 90
  - repeat flag
    - sequences, 93
  - resample, 31
  - rescale waveform, 26
  - resize font, 21
  - resizing panel, 19
  - resizing windows, 19
  - resolution, 61
  - restore default layout, 21
  - restore default setup, 20
  - restore factory cal, 193
  - restore last setup, 21
  - restore layout, 19
  - return a license, 200
  - right mouse click, 16
  - rotate, 31
  - run mode, 73
    - continuous, 74
    - gated, 74
    - triggered, 74
    - triggered continuous, 74
  - run state control, 15
  - RZ, 67
- S**
- S-Parameters, 31
    - aggressor, 44
    - apply, 41
    - cascading, 43
    - de-embed, 43
    - differential, 44
    - file types, 44
    - IQ, 42
    - non-cascading, 43
    - number of ports, 44
    - RF, 42
    - selection of the port, 44
    - signalling scheme, 44
    - single-ended, 44
    - victim, 44
  - sample rate
    - setting, 69
  - samples
    - X axis, 18
  - save setup
    - capture and playback, 20
    - with sequences, 20
    - with waveforms, 20
    - without sequences, 20
    - without waveforms, 20
  - saving
    - sequence file formats, 49
    - waveform file formats, 28
  - saving a sequence, 49
  - saving a waveform, 28
  - scale, 31
  - screen interface features, 15
  - seconds
    - X axis, 18
  - security, 13
  - self-calibration, 13
  - .seq
    - file formats, 166
  - .seq format, 166
  - sequence
    - add, 47
    - adding, 46
    - adding waveforms, 90
    - assign to channel, 46
    - batch compiler, 103
    - copy, 87
    - coupled, 95
    - creating toolbar, 88
    - edit, 51
    - edit button, 87
    - editing toolbar, 88
    - editing tools, 86
    - end output value, 64
    - event input, 91
    - event jump, 99
    - event jump to, 91
    - file button, 87
    - flag stability, 102
    - flag timing, 101

- flags, 90
- force jump, 99
- go to, 91
- go to jump, 99
- go to step, 88
- import, 47
- insert step button, 87
- jump execution order, 99
- length, 92
- modify, 46
- open, 20
- paste button, 87
- pattern jump, 97
- properties, 52
- repeat count, 90
- saving, 46
- subsequence, 102
- time, 92
- tracks, 90
- wait, 89
- sequence end
  - output value, 64
- sequence file format, 166
- sequence flags, 100
- sequence list, 46
- sequence properties
  - format, 52
  - length, 52
  - recommended amplitude, 52
  - recommended frequency, 52
  - recommended offset, 52
  - recommended sample rate, 52
- sequence saving
  - file formats, 49
- sequence settings, 92
  - flag repeat, 92
  - jump timing, 92
  - pattern jump, 92
- sequence steps, 89
- sequence tab
  - AWG, 11
- sequence track
  - assign to channel, 49
- service support, 3
- setup
  - channel, 54
  - default, 20

- open, 20
- save, 20
- setup file
  - opening, 48
- setup tab
  - AWG, 9
- shift, 31
- show analog, 18
- show cursor, 18
- show markers, 18
- signal format
  - defined, 52
- sin(x)/x correction, 67
- size
  - text, 14
- skew, 80
- skew adjustments, 80
- slave, 84
- software update, 2
- SourceXpress
  - connection control, 13
- specifications, 3
- status area, 5
- status indicators, 15
- stop/play button, 188
- stopped
  - output value, 64
- Streaming ID, 184
- strobe edge, 77
- subsequence, 89
- subsequence editing, 102
- support information, 3
- sync, 78
- sync clock out, 85
- sync in, 85
- sync out, 184
- sync to hub, 184
- synchronization, 9
  - master, 84
  - slave, 84
  - using, 84
- synchronize
  - multiple AWGs, 78
- synchronous trigger timing, 78
- system information, 13
- system software, 2

## T

- table editor, 160
  - copy button, 162
  - file button, 162
  - go to row, 162
  - insert step button, 162
  - paste button, 162
  - preferences, 162
  - right-click menu, 162
- tabs
  - reposition, 19
- TCP/IP
  - port, 184
- technical support, 3
- TekAMS, 197
- Tektronix Asset Management System, 197
- TekVISA, 4
- temperature
  - warning, 13
- text size, 14
- time, 92
- timing
  - markers, 60
  - trigger, 77
- tools panel, 19
- touchscreen, 15
  - enable and disable, 1
  - on/off, 14
- track
  - assign to channel, 49
- track flags, 90
- tracks, 90
  - adding waveforms, 90
  - dynamic loading, 90
- trigger
  - impedance, 77
  - level, 77
  - polarity, 77
  - timing, 77
- trigger control, 73
- trigger input settings, 76
- trigger inputs, 74
- trigger source, 185
  - A external, 74
  - B external, 74
  - internal, 74

trigger timing  
  async, 78  
  asynchronous, 77  
  sync, 78  
  synchronous, 78  
trigger uncertainty, 79  
triggered, 74  
triggered continuous, 74  
triggers  
  event modes, 73  
  run mode, 73  
types of licenses, 198

## U

undocking, 19  
uninstall licenses, 14  
units  
  changing, 16  
upgrades, 14  
USB connector, 184  
  front-panel connector, 183  
USB Device, 184  
utilities  
  calibration, 193  
  diagnostics, 189  
utilities tab  
  AWG mode, 13

## V

valid waveform file types, 23  
VGA, 184

VGA output, 2  
volts  
  Y axis, 18

## W

wait, 89  
waiting  
  output value, 64  
waveform  
  adding, 21  
  assign to channel, 29  
  modify, 31  
  normalize, 21  
  open, 20  
  properties, 38  
  saving, 21  
waveform color, 183  
waveform display, 18  
waveform file format, 168  
waveform functions, 133  
waveform granularity, 165  
waveform length, 165  
waveform list, 21  
waveform menu, 18  
waveform plug-ins, 124  
waveform plug-ins tab  
  AWG, 10  
waveform properties  
  format, 39  
  length, 39  
  recommended amplitude, 39

  recommended frequency, 39  
  recommended offset, 39  
  recommended sample rate, 39  
  signal format, 39  
waveform requirements, 165  
waveform saving  
  file formats, 28  
waveform select, 27  
waveform specifications, 165  
waveform types  
  valid file types, 23  
waveforms tab, 21  
WCF  
  port, 184  
.wfm  
  file formats, 168  
.wfm format, 166  
window resizing, 19  
Windows Communication  
  Foundation, 184  
windows software, 2

## X

X axis, 18

## Y

Y axis, 188

## Z

zoom, 17