



AFG31000 Series Arbitrary Function Generator
User's Manual



077-147-302



AFG31000 Series Arbitrary Function Generator
User's Manual

tek.com



077147302

Copyright © Tektronix. All rights reserved. Licensed software products are owned by Tektronix or its subsidiaries or suppliers, and are protected by national copyright laws and international treaty provisions.

Tektronix products are covered by U.S. and foreign patents, issued and pending. Information in this publication supersedes that in all previously published material. Specifications and price change privileges reserved.

TEKTRONIX and TEK are registered trademarks of Tektronix, Inc.

Contacting Tektronix, Inc.

Tektronix, Inc.
14150 SW Karl Braun Drive
P.O. Box 500
Beaverton, OR 97077
USA

For product information, sales, service, and technical support:

- In North America, call 1-800-833-9200.
- Worldwide, visit tek.com to find contacts in your area.

Warranty

Tektronix warrants that the product will be free from defects in materials and workmanship for a period of three (3) years from the date of original purchase from an authorized Tektronix distributor. If the product proves defective during this warranty period, Tektronix, at its option, either will repair the defective product without charge for parts and labor, or will provide a replacement in exchange for the defective product. Batteries are excluded from this warranty. Parts, modules and replacement products used by Tektronix for warranty work may be new or reconditioned to like new performance. All replaced parts, modules and products become the property of Tektronix.

In order to obtain service under this warranty, Customer must notify Tektronix of the defect before the expiration of the warranty period and make suitable arrangements for the performance of service. Customer shall be responsible for packaging and shipping the defective product to the service center designated by Tektronix, shipping charges prepaid, and with a copy of customer proof of purchase. Tektronix shall pay for the return of the product to Customer if the shipment is to a location within the country in which the Tektronix service center is located. Customer shall be responsible for paying all shipping charges, duties, taxes, and any other charges for products returned to any other locations.

This warranty shall not apply to any defect, failure or damage caused by improper use or improper or inadequate maintenance and care. Tektronix shall not be obligated to furnish service under this warranty a) to repair damage resulting from attempts by personnel other than Tektronix representatives to install, repair or service the product; b) to repair damage resulting from improper use or connection to incompatible equipment; c) to repair any damage or malfunction caused by the use of non-Tektronix supplies; or d) to service a product that has been modified or integrated with other products when the effect of such modification or integration increases the time or difficulty of servicing the product.

THIS WARRANTY IS GIVEN BY TEKTRONIX WITH RESPECT TO THE PRODUCT IN LIEU OF ANY OTHER WARRANTIES, EXPRESS OR IMPLIED. TEKTRONIX AND ITS VENDORS DISCLAIM ANY IMPLIED WARRANTIES OF MERCHANTABILITY OR FITNESS FOR A PARTICULAR PURPOSE.

TEKTRONIX' RESPONSIBILITY TO REPAIR OR REPLACE DEFECTIVE PRODUCTS IS THE SOLE AND EXCLUSIVE REMEDY PROVIDED TO THE CUSTOMER FOR BREACH OF THIS WARRANTY. TEKTRONIX AND ITS VENDORS WILL NOT BE LIABLE FOR ANY INDIRECT, SPECIAL, INCIDENTAL, OR CONSEQUENTIAL DAMAGES IRRESPECTIVE OF WHETHER TEKTRONIX OR THE VENDOR HAS ADVANCE NOTICE OF THE POSSIBILITY OF SUCH DAMAGES.

[W16 – 15AUG04]

Table of Contents

List of Figures	ix
Important safety information	xv
Important safety information	xv
General safety summary	xv
To avoid fire or personal injury	xv
Terms in this manual	xvii
Service safety summary	xvii
Symbols and terms on the product	xviii
Compliance information	xix
EMC compliance	xix
EC Declaration of Conformity – EMC	xix
Australia / New Zealand Declaration of Conformity – EMC	xx
Safety compliance	xx
EU declaration of conformity – low voltage	xx
Equipment type	xx
Safety class	xx
Pollution degree descriptions	xx
Pollution degree rating	xxi
IP rating	xx
Measurement and overvoltage category descriptions	xx
Mains overvoltage category rating	xx
Environmental considerations	xx
Product end-of-life handling	xx
Preface	xxiii
Getting started	xxiii
General features and benefits	xxiii
Key performance specifications	xxiii
General model information	xxiv
Accessories	xxiv
Standard accessories	xxiv
Optional accessories	xxv
Contact information	xxv
Extended warranty	xxv
Getting started	1
Before installation	1
Operating requirements	1

Check and protect connectors.....	2
Floating ground.....	3
Protect your DUT.....	4
Equivalent output circuits.....	5
Protection from overheating.....	5
Clean the instrument.....	6
Instrument interface.....	6
Front-panel overview.....	6
Shortcut keys (front panel).....	7
Default setup.....	8
Adjust waveform settings.....	9
Select waveform.....	10
Basic function modes.....	13
Rear panel overview.....	14
USB interface.....	15
Channel selection.....	15
Output on and off.....	15
Remote communications options.....	15
Operating basics.....	19
Power the instrument.....	19
Touchscreen interface.....	20
Basic mode default screen.....	20
Advanced mode default screen.....	21
ArbBuilder settings.....	22
Add or remove an app.....	23
Utility menu.....	25
Function introduction.....	27
Basic mode.....	27
Touchscreen swipe areas.....	27
Create a pulse waveform.....	29
Open or save arbitrary waveforms.....	30
Create noise or DC.....	31
Create a burst waveform.....	31
Sweep a waveform.....	34
Modulate a waveform.....	36
Trigger out.....	42
Align two-channel signals.....	43
Set up load impedance.....	44
Invert waveform polarity.....	45
Add noise.....	47
Add an external signal.....	48
Create a differential signal.....	50
External reference clock.....	51
Synchronize multiple instruments.....	52
USB flash drive.....	56
Save or recall instrument setup.....	57
Save a screen image.....	57
Tutorials.....	57
Tutorial: How to select a waveform and adjust settings.....	58
Tutorial: How to create a sine waveform.....	58
InstaView overview.....	59
Using InstaView.....	59
Change settings.....	65

Advanced mode	67
Advanced output modes	68
Advanced sequence list	68
Advance waveform list	69
Advanced setting bar	70
Sequence table	72
Sequence mode	73
Tutorial: How to use advanced mode.....	76
Making advanced mode connections	76
Using advanced mode	77
Utility menu options.....	84
System menu settings.....	85
Diagnostics and calibration functions.....	89
Input and output interface	92
Security menu settings.....	93
Firmware menu settings.....	94
License.....	96
Help	96
ArbBuilder	97
Create an arbitrary waveform.....	98
Create a standard waveform	98
Create a waveform using equations.....	99
Open a waveform with ArbBuilder.....	107
Draw a waveform with ArbBuilder	108
Edit a waveform with ArbBuilder	109
Send a waveform to CH1/CH2.....	114
Modify an arbitrary waveform.....	114
ArbExpress information	115
ArbExpress information.....	115
ArbExpress software	116
Basic operations.....	118
Application examples	121
Application examples	121
Lissajous patterns	121
Measurement of filter characteristics	124
Motor speed control by pulse-width modulation	126
Carrier null (frequency modulation).....	127

List of Figures

Figure 1: AFG31000 Series two-channel front panel.....	1
Figure 2: AFG31000 Series front-panel inputs and outputs	2
Figure 3: AFG31000 Series floating ground	3
Figure 4: High and low voltage limits	4
Figure 5: AFG output circuits	5
Figure 6: AFG31000 Series front-panel overview.....	6
Figure 7: Amplitude button active	7
Figure 8: High button active	8
Figure 9: Default button message.....	8
Figure 10: Touchscreen	11
Figure 11: Select continuous function.....	11
Figure 12: Sine waveform select.....	12
Figure 13: Select Arb waveform.....	12
Figure 14: Sin(x)/x waveform select.....	13
Figure 15: AFG31000 Series rear-panel connectors	14
Figure 16: Type A and B USB connectors	15
Figure 17: TekVISA instrument selection, Talker Listener.....	16
Figure 18: AFG31000 Series two-channel front view	19
Figure 19: Touchscreen main display	20
Figure 20: One-channel AFG home screen.....	21
Figure 21: Two-channel advanced mode home screen.....	21
Figure 22: One-channel sequence screen.....	22
Figure 23: ArbBuilder home screen	22
Figure 24: Add Apps icon active	23
Figure 25: Navigating to the downloaded app	24
Figure 26: New app available	24
Figure 27: Bottom swipe area	27
Figure 28: Bottom swipe area tabs	28
Figure 29: Top swipe area	28
Figure 30: Pulse period width	29
Figure 31: Bottom swipe area	30
Figure 32: ArbBuilder tab	31
Figure 33: Burst pulse waveform	32
Figure 34: Gated burst waveform	33

Figure 35: Sweep waveform settings	34
Figure 36: Oscilloscope sweep waveform	35
Figure 37: Oscilloscope amplitude modulation waveform	36
Figure 38: Waveform-modulation equations	37
Figure 39: Modulation type.....	38
Figure 40: Select pulse	39
Figure 41: Select modulation	39
Figure 42: PWM source settings	40
Figure 43: Deviation settings	40
Figure 44: Shape settings	41
Figure 45: CH1 frequency 5 MHz	43
Figure 46: Align Phase CH1 and CH2	44
Figure 47: Copy channel 1 to channel 2	45
Figure 48: Invert channel 1 and channel 2 wave polarity	46
Figure 49: Inverted sine wave	46
Figure 50: No noise	47
Figure 51: Waveform after noise is added	48
Figure 52: External signal before noise	49
Figure 53: External signal after noise	49
Figure 54: Bottom swipe area	50
Figure 55: Ch2 tab and CH1 Complement button	50
Figure 56: MultiSync instruments tab 1	52
Figure 57: MultiSync instruments tab 2.....	53
Figure 58: MultiSync Units tab 3	53
Figure 59: MultiSync instruments tab 4.....	54
Figure 60: MultiSync instruments tab 5.....	54
Figure 61: Master instrument waveform	55
Figure 62: Master and subordinate before sync	55
Figure 63: Master and subordinate after sync	56
Figure 64: Equipment for InstaView tutorial	60
Figure 65: AFG31000 InstaView setup with connections overview	61
Figure 66: Scope 1 M Ω	62
Figure 67: Set up InstaView on the AFG31000 instrument	63
Figure 68: Select channel one	63
Figure 69: BNC trigger connect - InstaView.....	64
Figure 70: Delay dialog	64
Figure 71: CH1 oscilloscope 1 M Ω - InstaView	65

Figure 72: Frequency 5 MHz - InstaView.....	65
Figure 73: Frequency 5 MHz - scope.....	66
Figure 74: Amplitude 2 VPP - Scope InstaView.....	66
Figure 75: Amplitude 2 Vpp - InstaView.....	67
Figure 76: Advanced mode default screen	67
Figure 77: One-channel sequence screen.....	68
Figure 78: Waveform list	69
Figure 79: Settings bar	70
Figure 80: Channel scale and offset	70
Figure 81: Timing	71
Figure 82: Sequence table	71
Figure 83: Sequence table	72
Figure 84: Sequence mode.....	73
Figure 85: Continuous mode.....	74
Figure 86: Triggered mode.....	74
Figure 87: Gated mode	75
Figure 88: Thumbnail	75
Figure 89: Equipment setup	76
Figure 90: Advanced icon on the Home screen.....	77
Figure 91: Empty Waveform list.....	77
Figure 92: Predefined button.....	78
Figure 93: Select from the Waveform List.....	78
Figure 94: Drag and drop waveforms	79
Figure 95: Go To field, change to 1	79
Figure 96: Change to results.....	80
Figure 97: Set repeat function.....	80
Figure 98: Swipe left-to-right to select the box.....	81
Figure 99: Manual trigger	82
Figure 100: Manual trigger button.....	83
Figure 101: Single triggered waveforms	83
Figure 102: Utility home screen	84
Figure 103: System settings.....	85
Figure 104: Utility button	86
Figure 105: Erase instrument setups and waveforms	87
Figure 106: Language selection.....	88
Figure 107: Diagnostics and calibration.....	89
Figure 108: Diagnostics and calibration.....	90

Figure 109: Run system diagnostics	91
Figure 110: Run self-calibration	92
Figure 111: I/O Interface options	93
Figure 112: Security menu settings	93
Figure 113: Update firmware menu	94
Figure 114: Update firmware.....	95
Figure 115: License update.....	96
Figure 116: ArbBuilder home screen	97
Figure 117: ArbBuilder home tab	98
Figure 118: ArbBuilder New Waveform	98
Figure 119: ArbBuilder main screen	99
Figure 120: ArbBuilder equation file with soft keyboard	100
Figure 121: ArbBuilder equation file.....	100
Figure 122: ArbBuilder soft keyboard	101
Figure 123: ArbBuilder equation editor ribbon	105
Figure 124: ArbBuilder equation text editor	105
Figure 125: ArbBuilder compile succesfully	105
Figure 126: ArbBuilder Preview	106
Figure 127: ArbBuilder log waveform.....	106
Figure 128: ArbBuilder options.....	107
Figure 129: ArbBuilder freehand	108
Figure 130: ArbBuilder open a waveform	109
Figure 131: ArbBuilder edit toolbar	109
Figure 132: ArbBuilder highlight waveform data to cut	109
Figure 133: ArbBuilder invert	110
Figure 134: ArbBuilder invert final.....	110
Figure 135: ArbBuilder mirror.....	111
Figure 136: ArbBuilder mirror final	111
Figure 137: ArbBuilder waveform display zone	112
Figure 138: ArbBuilder shift rotate	113
Figure 139: ArbBuilder Waveform to CH1/CH2	114
Figure 140: ArbBuilder successfull send message	114
Figure 141: ArbExpress menu bar	116
Figure 142: ArbExpress toolbar	116
Figure 143: ArbExpress shortcut view	117
Figure 144: ArbExpress status bar	117
Figure 145: ArbExpress waveform display	117

Figure 146: ArbExpress marker area	117
Figure 147: ArbExpress blank sheet	118
Figure 148: ArbExpress standard waveform.....	119
Figure 149: ArbExpress equation editor	119
Figure 150: ArbExpress math application	120
Figure 151: ArbExpress Transfer	120
Figure 152: Set the waveform pattern.....	121
Figure 153: Lissajous Pattern Displayed	122
Figure 154: Lissajous pattern change displayed	122
Figure 155: Change the phase CH1 to -19.....	123
Figure 156: Lissajous pattern changes	123
Figure 157: AFG31000 Series connected to an oscilloscope.....	124
Figure 158: Measure frequency characteristics	125
Figure 159: Duty rate changes motor speed.....	126
Figure 160: PWM	127
Figure 161: Carrier waveform frequencies.....	128
Figure 162: Carrier waveform null.....	128

Important safety information

Important safety information

This manual contains information and warnings that must be followed by the user for safe operation and to keep the product in a safe condition.

To safely perform service on this product, additional information is provided at the end of this section. See [Service safety summary](#) (on page 17).

General safety summary

Use the product only as specified. Review the following safety precautions to avoid injury and prevent damage to this product or any products connected to it. Carefully read all instructions. Retain these instructions for future reference.

Comply with local and national safety codes.

For correct and safe operation of the product, it is essential that you follow generally accepted safety procedures in addition to the safety precautions specified in this manual.

The product is designed to be used by trained personnel only.

Only qualified personnel who are aware of the hazards involved should remove the cover for repair, maintenance, or adjustment.

Before use, always check the product with a known source to be sure it is operating correctly.

This product is not intended for detection of hazardous voltages.

Use personal protective equipment to prevent shock and arc blast injury where hazardous live conductors are exposed.

While using this product, you may need to access other parts of a larger system. Read the safety sections of the other component manuals for warnings and cautions related to operating the system.

When incorporating this equipment into a system, the safety of that system is the responsibility of the assembler of the system.

To avoid fire or personal injury

Use proper power cord. Use only the power cord specified for this product and certified for the country of use.

Do not use the provided power cord for other products.

Use proper voltage setting. Before applying power, make sure that the line selector is in the proper position for the source being used or make sure the line voltage is corrected based on the published specifications.

Ground the product. This product is grounded through the grounding conductor of the power cord. To avoid electric shock, the grounding conductor must be connected to earth ground. Before making connections to the input or output terminals of the product, make sure that the product is properly grounded.

Do not disable the power cord grounding connection.

Power disconnect. The power cord disconnects the product from the power source. See instructions for the location. Do not position the equipment so that it is difficult to operate the power cord; it must remain accessible to the user at all times to allow for quick disconnection if needed.

Connect and disconnect properly. Do not connect or disconnect instruments while they are connected to a voltage source.

Use only connectors and adapters supplied with the product, or indicated by Tektronix to be suitable for the product.

Observe all terminal ratings. To avoid fire or shock hazard, observe all ratings and markings on the product. Consult the product manual for further ratings information before making connections to the product. Do not exceed the Measurement Category (CAT) rating and voltage or current rating of the lowest rated individual component.

Do not apply a potential to any terminal, including the common terminal, that exceeds the maximum rating of that terminal.

Do not float the common terminal above the rated voltage for that terminal.

Do not operate without covers. Do not operate this product with covers or panels removed, or with the case open. Hazardous voltage exposure is possible.

Avoid exposed circuitry. Do not touch exposed connections and components when power is present.

Do not operate with suspected failures. If you suspect that there is damage to this product, have it inspected by qualified service personnel.

Disable the product if it is damaged. Do not use the product if it is damaged or operates incorrectly. If in doubt about safety of the product, turn it off and disconnect the power cord. Clearly mark the product to prevent its further operation.

Examine the exterior of the product before you use it. Look for cracks or missing pieces.

Use only specified replacement parts.

Wear eye protection. Wear eye protection if exposure to high-intensity rays or laser radiation exists.

Do not operate in wet/damp conditions. Be aware that condensation may occur if a unit is moved from a cold to a warm environment.

Do not operate in an explosive atmosphere.

Provide proper ventilation. Refer to the installation instructions in the manual for details on installing the product so it has proper ventilation.

Slots and openings are provided for ventilation and should never be covered or otherwise obstructed. Do not push objects into any of the openings.

Provide a safe working environment. Always place the product in a location convenient for viewing the display and indicators.

Avoid improper or prolonged use of keyboards, pointers, and button pads. Improper or prolonged keyboard or pointer use may result in serious injury.

Be sure your work area meets applicable ergonomic standards. Consult with an ergonomics professional to avoid stress injuries.

Use care when lifting and carrying the product. This product is provided with handles for lifting and carrying.

Use only the Tektronix rack-mount hardware specified for this product.

Keep product surfaces clean and dry. Remove the input signals before you clean the product. Inspect the instrument as often as operating conditions require. To clean the exterior surface, perform the following steps:

1. Remove loose dust on the outside of the instrument with a lint-free cloth. Use care to avoid scratching the clear glass display filter.
2. Use a soft cloth dampened with water to clean the instrument. Use an aqueous solution of 75% isopropyl alcohol for more efficient cleaning.



CAUTION. Avoid getting moisture inside the unit during external cleaning. Use only enough cleaning solution to dampen the cloth or swab. To avoid damage to the instrument, do not expose it to sprays, liquids, or solvents, and do not use any abrasive or chemical cleaning agents.

Terms in this manual

These terms may appear in this manual:



WARNING. Warning statements identify conditions or practices that could result in injury or loss of life.



CAUTION. Caution statements identify conditions or practices that could result in damage to this product or other property.

Service safety summary

This section contains additional information required to safely perform service on the product. Only qualified personnel should perform service procedures. Read this *Service safety summary* and the General safety summary before performing any service procedures.

To avoid electric shock. Do not touch exposed connections.

Do not service alone. Do not perform internal service or adjustments of this product unless another person capable of rendering first aid and resuscitation is present.

Disconnect power. To avoid electric shock, switch off the product power and disconnect the power cord from the mains power before removing any covers or panels, or opening the case for servicing.

Use care when servicing with power on. Dangerous voltages or currents may exist in this product. Disconnect power, remove battery (if applicable), and disconnect test leads before removing protective panels, soldering, or replacing components.

Verify safety after repair. Always recheck ground continuity and mains dielectric strength after performing a repair.

Symbols and terms on the product

These terms may appear on the product:

- DANGER indicates an injury hazard immediately accessible as you read the marking.
- WARNING indicates an injury hazard not immediately accessible as you read the marking.
- CAUTION indicates a hazard to property including the product.



When this symbol is marked on the product, be sure to consult the manual to find out the nature of the potential hazards and any actions which have to be taken to avoid them. (This symbol may also be used to refer the user to ratings in the manual.)

The following symbol(s) may appear on the product:



CAUTION
Refer to Manual



Earth Terminal



Chassis Ground



Protective Ground
(Earth) Terminal



Mains Disconnected
OFF (Power)



Mains Connected
ON (Power)



Off



On



WARNING
High Voltage

Compliance information

This section lists the EMC (electromagnetic compliance), safety, and environmental standards with which the instrument complies.

EMC compliance

EC Declaration of Conformity – EMC

Meets intent of Directive 2014/30/EU for Electromagnetic Compatibility. Compliance was demonstrated to the following specifications as listed in the Official Journal of the European Communities:

EN61326-1 : 2013, EN61326-2-1 : 2013 EMC requirements for electrical equipment for measurement, control, and laboratory [use](#) ^{1,2,3}.

NOTE. Equipment may not meet the immunity requirements of applicable listed standards when test leads and/or test probes are connected due to coupling of electromagnetic interference onto those leads/probes. To minimize the influence of electromagnetic interference, minimize the loop area between the unshielded portions of signal and associated return leads, and keep leads as far away as possible from electromagnetic disturbance sources. Twisting unshielded test leads together is an effective way to reduce loop area. For probes, keep the ground return lead as short as possible and close to the probe body. Some probes have accessory probe tip adapters to accomplish this most effectively. In all cases, observe all safety instructions for the probes or leads used.

- CISPR 11:2009+A1 2010. Radiated and conducted emissions, Group 1, Class A
- IEC 61000-4-2:2008. Electrostatic discharge immunity
- IEC 61000-4-3:2006+A1:2007+A2:2010. RF electromagnetic field immunity
- IEC 61000-4-4:2012. Electrical fast transient/burst immunity
- IEC 61000-4-5:2014+A1:2017. Power line surge immunity
- IEC 61000-4-6:2013. Conducted RF immunity
- IEC 61000-4-11:2004+A1:2017. Voltage dips and interruptions immunity

EN 61000-3-2:2014. AC power line harmonic emissions

EN 61000-3-3:2013. Voltage changes, fluctuations, and flicker

¹ This product is intended for use in nonresidential areas only. Use in residential areas may cause electromagnetic interference.

² Emissions which exceed the levels required by this standard may occur when this equipment is connected to a test object.

³ For compliance with the EMC standards listed here, high quality shielded interface cables should be used.

Australia / New Zealand Declaration of Conformity – EMC

Complies with the EMC provision of the Radiocommunications Act per the following standard, in accordance with ACMA:

CISPR 11:2009. Radiated and Conducted Emissions, Group 1, Class A, in accordance with EN 61326-1:2013.

Safety compliance

This section lists the safety standards with which the product complies and other safety compliance information.

EU declaration of conformity – low voltage

Compliance was demonstrated to the following specification as listed in the Official Journal of the European Union:

Low Voltage Directive

- EN 61010-1-2010. Safety Requirements for Electrical Equipment for Measurement, Control, and Laboratory Use – Part 1: General Requirements.
- EN 61010-2-030-2010. Safety Requirements for Electrical Equipment for Measurement, Control, and Laboratory Use – Part 2-030: Particular requirements for testing and measuring circuits.

Equipment type

Test and measuring equipment.

Safety class

Class 1 – grounded product.

Pollution degree descriptions

A measure of the contaminants that could occur in the environment around and within a product. Typically the internal environment inside a product is considered to be the same as the external. Products should be used only in the environment for which they are rated.

- Pollution degree 1. No pollution or only dry, nonconductive pollution occurs. Products in this category are generally encapsulated, hermetically sealed, or located in clean rooms.
- Pollution degree 2. Normally only dry, nonconductive pollution occurs. Occasionally a temporary conductivity that is caused by condensation must be expected. This location is a typical office/home environment. Temporary condensation occurs only when the product is out of service.
- Pollution degree 3. Conductive pollution, or dry, nonconductive pollution that becomes conductive due to condensation. These are sheltered locations where neither temperature nor humidity is controlled. The area is protected from direct sunshine, rain, or direct wind.
- Pollution degree 4. Pollution that generates persistent conductivity through conductive dust, rain, or snow. Typical outdoor locations.

Pollution degree rating

Pollution degree 2 (as defined in IEC 61010-1). Rated for indoor, dry location use only.

IP rating

IP20 (as defined in IEC 60529).

Measurement and overvoltage category descriptions

Measurement terminals on this product may be rated for measuring mains voltages from one or more of the following categories (see specific ratings marked on the product and in the manual).

- Category II. Circuits directly connected to the building wiring at utilization points (socket outlets and similar points).
- Category III. In the building wiring and distribution system.
- Category IV. At the source of the electrical supply to the building.

NOTE. Only mains power supply circuits have an overvoltage category rating. Only measurement circuits have a measurement category rating. Other circuits within the product do not have either rating.

Mains overvoltage category rating

Overvoltage category II (as defined in IEC 61010-1).

Environmental considerations

This section provides information about the environmental impact of the product.

Product end-of-life handling

Observe the following guidelines when recycling an instrument or component:

Equipment recycling. Production of this equipment required the extraction and use of natural resources. The equipment may contain substances that could be harmful to the environment or human health if improperly handled at the product's end of life. To avoid release of such substances into the environment and to reduce the use of natural resources, we encourage you to recycle this product in an appropriate system that will ensure that most of the materials are reused or recycled appropriately.



This symbol indicates that this product complies with the applicable European Union requirements according to Directives 2012/19/EU and 2006/66/EC on waste electrical and electronic equipment (WEEE) and batteries. For information about recycling options, check the Support/Service section of the Tektronix Web site (www.tek.com).

Battery recycling. This product contains a small installed lithium metal button cell. Please properly dispose of or recycle the cell at its end of life according to local government regulations.

Perchlorate materials. This product contains one or more type CR lithium batteries. According to the state of California, CR lithium batteries are classified as perchlorate materials and require special handling. See www.dtsc.ca.gov/hazardouswaste/perchlorate for additional information.

Transporting batteries. The small lithium primary button cell contained in this equipment does not exceed 1 gram of lithium metal content per cell, and the cell type has been shown by the manufacturer to comply with the applicable requirements of the UN Manual of Tests and Criteria Part III, Sub-section 38.3. Consult your carrier to determine which lithium battery transportation requirements are applicable to your configuration, including to its re-packaging and re-labeling, prior to reshipment of the product by any mode of transport

Preface

Getting started

Thank you for choosing a Tektronix product. The AFG31000 Series Arbitrary Function Generator (AFG) instruments are high-performance instruments with built-in waveform generation applications, real-time waveform monitoring called InstaView™, and an improved user interface for higher test efficiency.

General features and benefits

The AFG31000 Series Arbitrary Function Generators (AFG) provide pulse and function generation with arbitrary waveform capability.

These instruments provide the following features and benefits:

- Dual operation, either using a nine-inch capacitive touchscreen or front-panel keys with navigation wheel, ensure usability and flexibility.
- InstaView™ technology allows you to see the actual waveform of the device under test (DUT) in real time, without the need for an oscilloscope and probe. This eliminates the uncertainty caused by unmatched impedance.
- Shallow menu tree ensures fast and easy browsing, locating, and changing settings.
- Built-in ArbBuilder for arbitrary waveform creation and editing eliminates the need to connect to a PC or use a USB flash drive to load arbitrary waveforms.
- Instrument output is protected from overvoltage and overcurrent, minimizing the possibility of damaging the instrument.

Key performance specifications

The AFG31000 Series instruments provide pulse and function generation with arbitrary waveform capability. The instruments include the following key performance specifications:

- One or two-channel models.
- Output amplitude range: 1 mV_{pp} to 10 V_{pp} with 50 Ω loads.
- Basic Direct Digital Synthesis (DDS) mode.
- 25 MHz, 50 MHz, 100 MHz, 150 MHz, or 250 MHz sine waveforms (AFG model-dependent).
- 250 MS/s, 500 MS/s (Advanced mode only), 1 GS/s, or 2 GS/s sampling rate.
- 14-bit DAC vertical resolution.
- AFG mode supports continuous, modulation, sweep, and burst run modes.
- AFG mode supports 128K points of arbitrary waveform memory per channel.
- Advanced mode supports continuous, sequence, gated, and trigger modes.
- Advanced mode supports 16M points of arbitrary waveform memory per channel (you have the option to get 128M points based on your license).
- Up to 256 steps in sequence mode with loop, jump, and wait events.
- Variable sampling clock: 1 μS/s up to 2 GS/s.
- Minimum waveform length: 168 points with granularity of one point.

General model information

This manual provides operation information for the following products. Unless otherwise noted, "AFG31000 Series" refers to the models in the following table.

Table 1: AFG31000 models

Model	Bandwidth	Sample rate	Channel	Waveform memory size	Optional
AFG31021	25 MHz	250 MS/s	1	16 MS/CH	128 MS/CH
AFG31022	25 MHz	250 MS/s	2	16 MS/CH	128 MS/CH
AFG31051	50 MHz	1 GS/s	1	16 MS/CH	128 MS/CH
AFG31052	50 MHz	1 GS/s	2	16 MS/CH	128 MS/CH
AFG31101	100 MHz	1 GS/s	1	16 MS/CH	128 MS/CH
AFG31102	100 MHz	1 GS/s	2	16 MS/CH	128 MS/CH
AFG31151	150 MHz	2 GS/s	1	16 MS/CH	128 MS/CH
AFG31152	150 MHz	2 GS/s	2	16 MS/CH	128 MS/CH
AFG31251	250 MHz	2 GS/s	1	16 MS/CH	128 MS/CH
AFG31252	250 MHz	2 GS/s	2	16 MS/CH	128 MS/CH

Each AFG31000 Series provides a:

- 25 MHz to 250 MHz function signal generator
- 20 MHz to 160 MHz pulse generator

The AFG31000 Series also provides 14-bit vertical resolution.

Accessories

Standard accessories

Unpack the instrument and verify that you received all items listed as standard accessories. Check the www.tek.com for the most current information.

Available power cords are listed in the following table.

Table 2: Available power cords

Option	Location	Attributes	Part number
A0	North America	120 V, 60 Hz	161-0066-00
A1	Universal European	220 V, 50 Hz	161-0066-09
A2	United Kingdom	240 V, 50 Hz	161-0066-10
A3	Australia	240 V, 50 Hz	161-0066-13
A5	Switzerland	220 V, 50 Hz	161-0154-00
A6	Japan	100 V, 50/60 Hz	161-0298-00
A10	China	50 Hz	161-0304-00
A11	India	50 Hz	161-0400-00
A12	Brazil	60 Hz	161-0357-00
A99	N/A	no power cord	N/A

Optional accessories

The following optional accessories are recommended for your instrument.

Table 3: Optional accessories

Description	Part number
50 Ω BNC cable, double-shielded, 250 cm (98 in)	012-1256-XX
GPIB interface cable, double-shielded, 200 cm (79 in)	012-0991-XX

NOTE. To ensure the EMC compliance listed in the specifications, connect only high-quality shielded cables to this instrument. High-quality shielded cables are typically braid and foil types that have low-impedance connections to shielded connectors at both ends.

Contact information

If you have any questions after you review the information in this documentation, please contact your local Tektronix office, sales partner, or distributor. You can also call the corporate headquarters of Tektronix in North America at 1-800-833-9200. Visit tek.com to find contacts in your area.

Extended warranty

Additional years of warranty coverage are available on many products. These valuable contracts protect you from unbudgeted service expenses and provide additional years of protection at a fraction of the price of a repair. Extended warranties are available on new and existing products. Contact your local Tektronix office, sales partner, or distributor for details (refer to [Contact information](#) (on page 25) for details).

Getting started

Before installation

Inspect the instrument carton for external damage. If the carton is damaged, notify the carrier. Remove the instrument from its package and make sure that it has not been damaged in transit. Verify that the carton contains the instrument and its standard accessories.

Operating requirements

Place the instrument on a cart or bench, observing the following clearance requirements:

- Sides: 50 mm (2 in)
- Rear: 50 mm (2 in)

Before operating the instrument, make sure that the ambient temperature is between 0 °C to 50 °C.

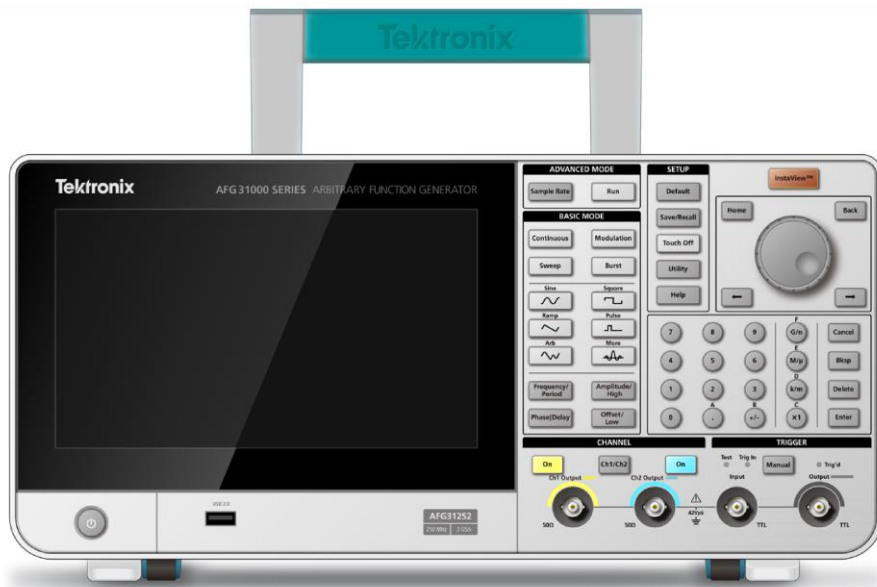

Figure 1: AFG31000 Series two-channel front panel



CAUTION. To ensure proper cooling, keep both sides of the instrument clear of obstructions.

Check and protect connectors

The source voltage and frequency should be between 100 V to 240 V and 47 Hz to 63 Hz.

The instrument will also support 115V, 360-440Hz.



WARNING. To reduce the risk of fire and shock that may cause personal injury or death, make sure that the mains supply voltage fluctuations do not exceed 10% of the operating voltage range.

To check input and output connectors:

1. Locate the output connectors on the front panel.
2. Locate the input connectors on the front panel.

NOTE. When connecting a cable, make sure to distinguish the input connector from the output connectors to avoid making the wrong connection.

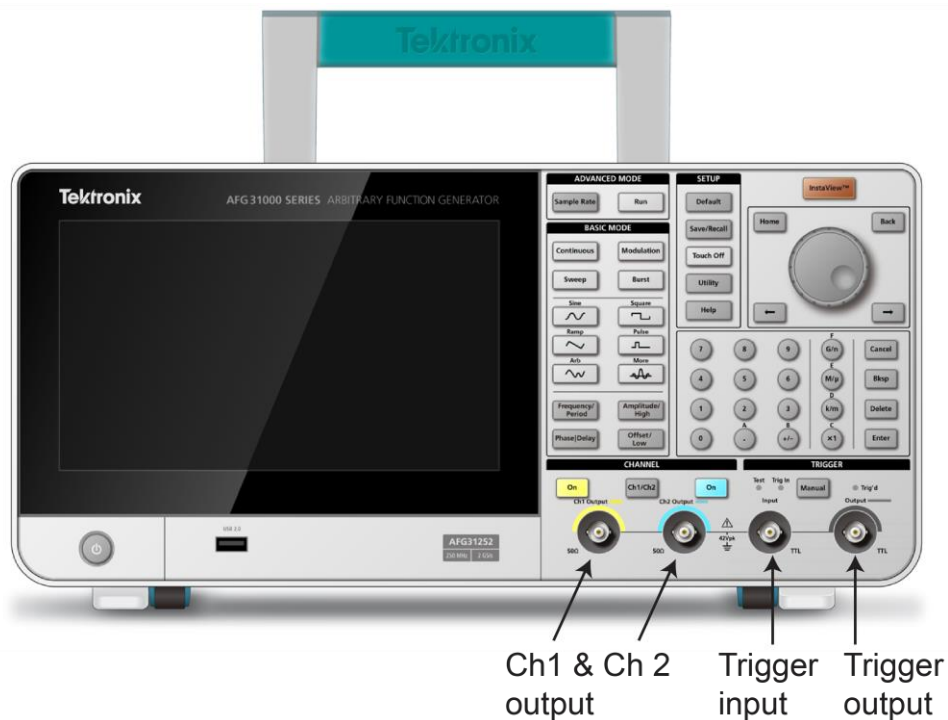

Figure 2: AFG31000 Series front-panel inputs and outputs

The instrument input and output connectors are floating inputs and outputs (see [Floating ground](#) (on page 3) for more information).



WARNING. To avoid personal injury or death due to electric shock, do not apply voltages in excess of 42 V_{pk} to any BNC connector ground or to the chassis ground.



CAUTION. Do not short output pins or apply external voltages to output connectors, because this will cause damage to your instrument. Also, do not apply more than +5 V to the Trigger Input connector, which may cause damage to your instrument.

Floating ground

Because the common ground (input and output channel common) of the AFG31000 Series is electrically isolated from the chassis ground (the instrument chassis and ground line of the AC connector), you can make a floating connection between the instrument and other equipment.

All the signal output connectors are connected to the common ground, and the remote interface connector is connected to the chassis ground.



WARNING. To avoid personal injury due to electric shock, use this product so that the sum of the floating voltage and the output voltage of the instrument does not exceed $42 V_{pk}$. Do not touch the center of the BNC connector while the equipment and instrument are in use.



CAUTION. The maximum rated voltage between the chassis ground and common ground is $42 V_{pp}$ (DC + peak AC). When the potential voltage between the chassis ground and common ground goes over $42 V_{pp}$, the internal protective circuit is activated to protect the circuits. However, voltages continuously exceeding $42 V_{pp}$ may cause the internal circuits in the instrument to be damaged.

When a potential voltage exists between the chassis ground and common ground, a short circuit from output to ground causes the instrument internal fuse to open and the output is stopped. If the fuse opens, you need to contact your local Tektronix Service Support. When a potential voltage exists between the common ground and chassis ground, short-circuiting between them may lead to excessive current flow and the internal or external circuits may be damaged.

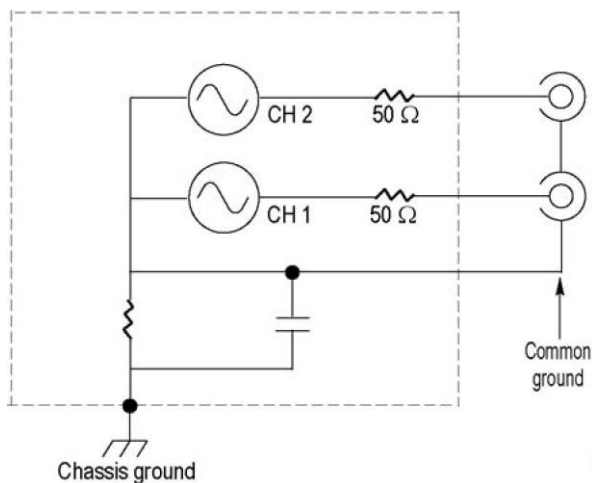

Figure 3: AFG31000 Series floating ground

Protect your DUT

Use caution when you connect the instrument channel output to your device under test (DUT). To avoid damage to your DUT, follow the steps below to set the limit values for high level and low level.

To protect your DUT:

1. Make note of the CH1 or CH2 high voltage and low voltage.
2. Swipe the bottom area up and select **Ch1** or **Ch2**.
3. Make sure that the limits are set appropriately for the device under test (DUT).
 - Default high limit: 500 mV
 - Default low limit: -500 mV

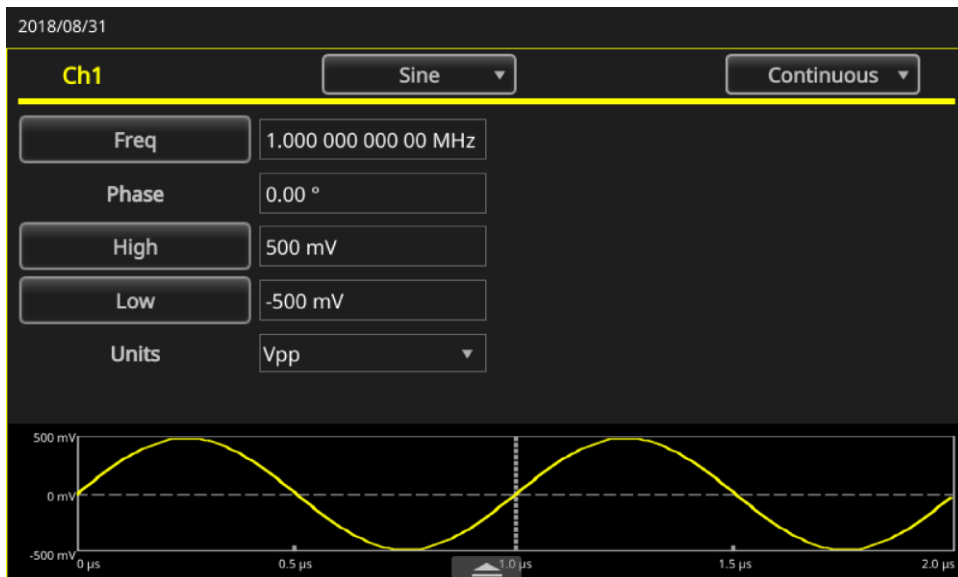

Figure 4: High and low voltage limits

Equivalent output circuits

The following figure shows the equivalent output circuits for the AFG31000 Series Arbitrary Function Generator instruments.

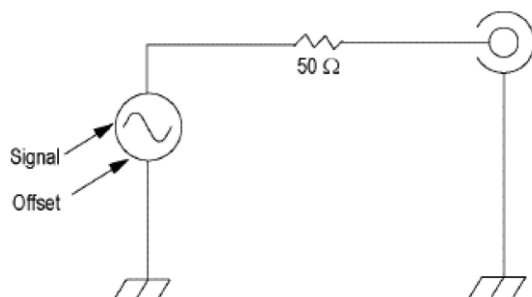

Figure 5: AFG output circuits

The following table shows the output window (minimum and maximum levels) for a sine waveform when you change the load impedance (L). Load impedance affects the output window.

Table 4: Output window for a sine waveform

Instruments	Minimum amplitude	Maximum amplitude
31021	5 V to -5 V (10 V _{pp})	10 V to -10 V (20 V _{pp})
31022	5 V to -5 V (10 V _{pp})	10 V to -10 V (20 V _{pp})
31051	5 V to -5 V (10 V _{pp})	10 V to -10 V (20 V _{pp})
31052	5 V to -5 V (10 V _{pp})	10 V to -10 V (20 V _{pp})
31101	5 V to -5 V (10 V _{pp})	10 V to -10 V (20 V _{pp})
31102	5 V to -5 V (10 V _{pp})	10 V to -10 V (20 V _{pp})
31151	2.5 to -2.5 (5 V _{pp})	5 V to -5 V (10 V _{pp})
31152	2.5 to -2.5 (5 V _{pp})	5 V to -5 V (10 V _{pp})
31251	2.5 to -2.5 (5 V _{pp})	5 V to -5 V (10 V _{pp})
31252	2.5 to -2.5 (5 V _{pp})	5 V to -5 V (10 V _{pp})

Protection from overheating

The internal temperature of the AFG31000 Series instrument is monitored. A warning message is displayed if the internal temperature reaches a specified level and signal output is automatically turned off.

If the warning message appears, check for the following conditions:

- The ambient temperature requirement is correct.
- The required cooling clearance has been provided.
- The instrument fan is working properly.

Clean the instrument

Inspect the instrument as often as operating conditions require. To clean the exterior surface:

1. Remove the power cord from the rear of the instrument before cleaning.
2. Remove loose dust from the outside of the instrument with a lint-free cloth. Use care to avoid scratching the display.
3. Use a soft cloth, dampened with isopropyl alcohol, to clean the instrument.

NOTE. Use 70% isopropyl alcohol for more efficient cleaning. To avoid damaging the instrument, do not use any abrasive or chemical cleaning agents. Do not allow the instrument to get wet inside. Use only enough alcohol to dampen the cleaning cloth.

Instrument interface

The following topics present an overview of the AFG31000 Series instrument interface.

Front-panel overview

The following figure shows the front panel of a dual-channel model.

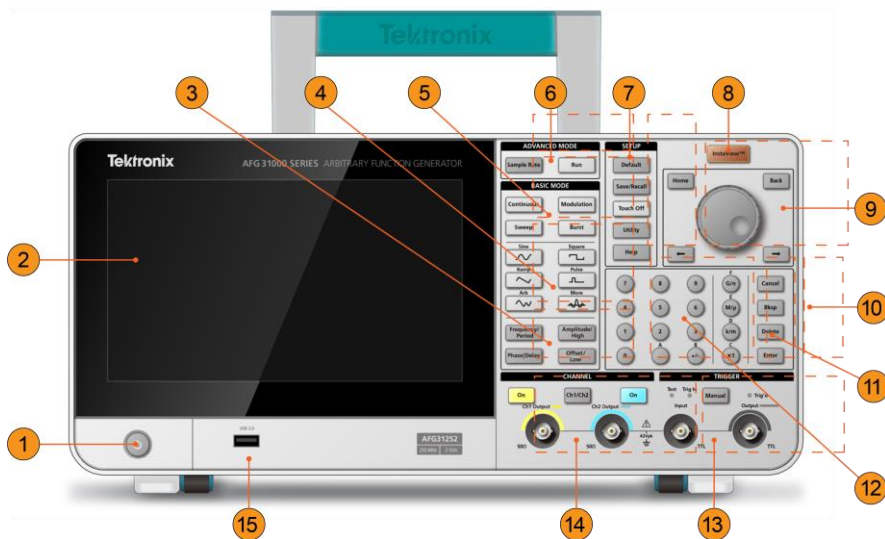

Figure 6: AFG31000 Series front-panel overview

1. Power switch
2. Touchscreen
3. Shortcut buttons: Frequency/Period, Amplitude/High, Phase/Delay, Offset/Low
4. Waveform function keys: Sine, Ramp, Arb, Square, Pulse, and More
5. Basic Mode buttons: Continuous, Sweep, Modulation, and Burst
6. Advanced Mode keys: Sample, Rate, and Run
7. Setup buttons: Default, Save/Recall, Touch Off, Utility, and Help
8. InstaView (real-time waveform measurement) button

9. Navigation area: Navigation control (turn the control to change the number of parameter that is selected); Home key (takes you to the initial power on screen); Back key (use to switch between AFG, Advanced Mode, ArbBuilder, Help, and Utility); left and right arrow keys (when editing a setting, moves the cursor to the left or the right)
10. Cancel, Bksp (backspace), Delete, and Enter buttons (use with the numeric keypad)
11. Settings edit buttons: G/n, M/ μ , k/m, and x1 buttons (use when editing a setting)
12. Numeric keypad
13. Trigger button, LEDs, and connectors
14. Channel buttons and connectors
15. USB input (Type A connector)

NOTE. Shortcut keys are provided for advanced users. The shortcut keys allow you to select a setting and enter a numeric value using the front-panel controls or the touchscreen.

Shortcut keys (front panel)

The shortcut keys allow you to select a setup parameter and enter a numeric value using the front-panel controls. By using the shortcut buttons, you can toggle between functions and select a waveform setting without using the touchscreen menus.

Shortcut buttons are located below the Basic Mode buttons on the front panel:

- Frequency/Period
- Amplitude/High
- Phase/Delay
- Offset/Low

In the following example, use sine waveform.

To use the Amplitude/High button:

1. Select **Basic** on the touchscreen.
2. Press the **Amplitude/High** shortcut button to activate Amplitude.
3. Press the **Amplitude/High** shortcut button again to activate High.

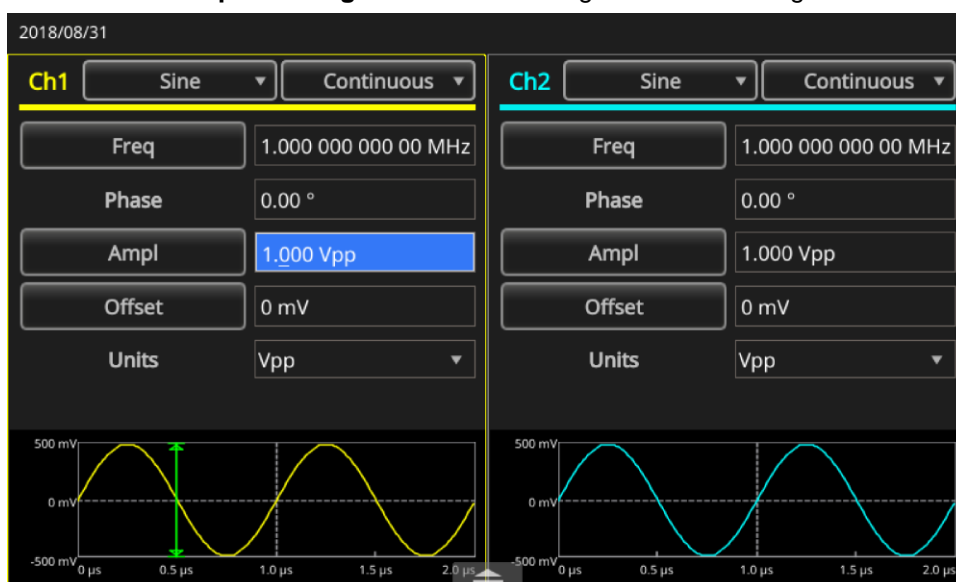

Figure 7: Amplitude button active

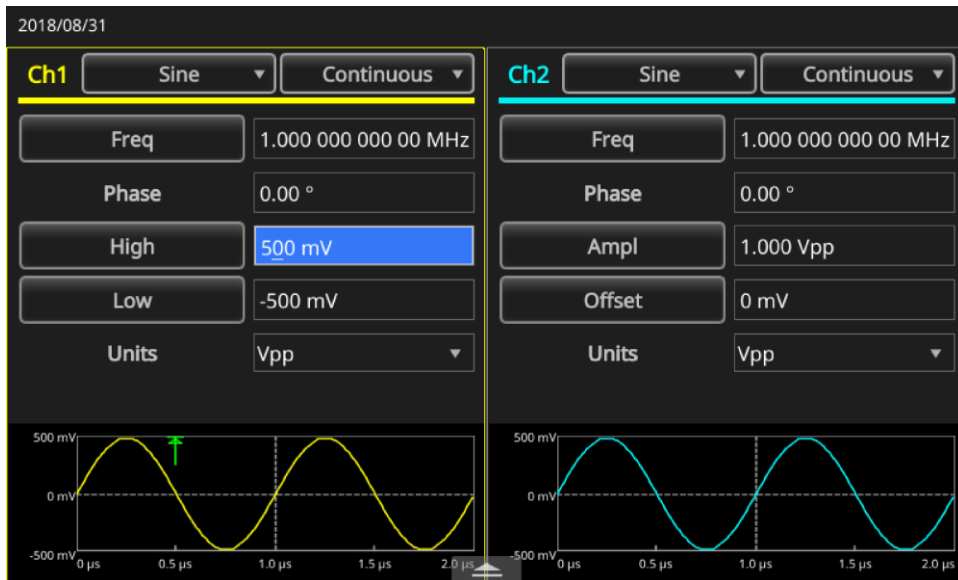

Figure 8: High button active

Default setup

When you want to restore the default instrument settings, press the front-panel **Default** button.

NOTE. The front-panel Default button does not reset the following settings: Language option; power-on settings; system-related settings (display contrast, screen saver, click tone, and beeper); saved setups and arbitrary waveform data; calibration data; GPIB and ethernet settings; and access protection.

To restore the default settings:

1. Press the **Default** button. A confirmation pop-up message is displayed.
2. Press **OK** to recall the default settings, or **Cancel** the recall.

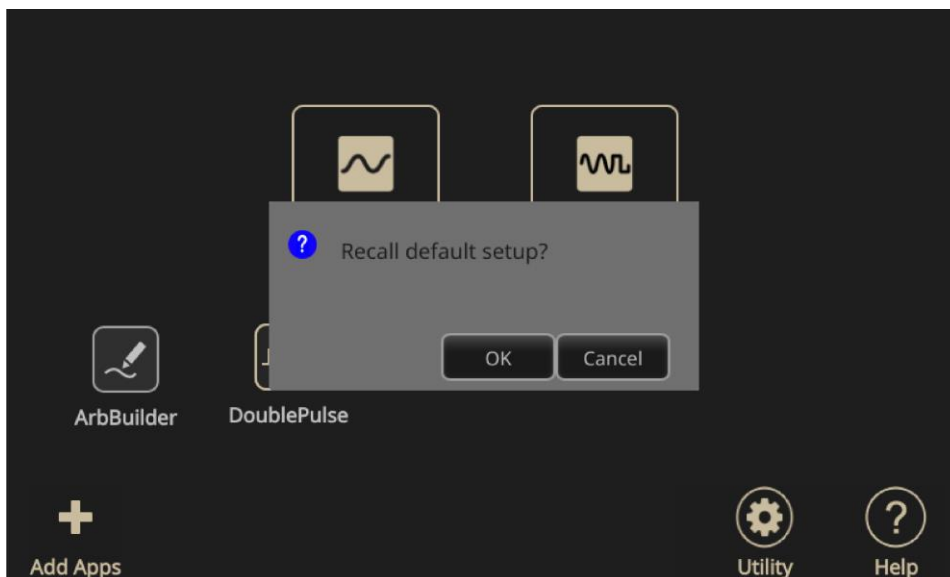

Figure 9: Default button message

Adjust waveform settings

When you power on your instrument, the default output signal is a 1 MHz sine wave with an amplitude of 1 V_{pp}. In the following example, you can change the frequency and amplitude of the original output signal.

To adjust waveform settings:

1. Press the front-panel **Default** button to display the default output signal.
2. When you are prompted with `Recall default setup?`, select **OK** or **Cancel**.
3. Make sure that **Frequency** is selected. If it is not, select **Period** on the CH1 touchscreen and change the parameter to Frequency or press the front-panel **Frequency/Period** shortcut button. Frequency is now active. You can change the value using the keypad or navigation control.
4. Press the **Frequency/Period** shortcut button again to toggle the parameter to **Period**.
5. Next, change the amplitude. Press the **Amplitude/High** shortcut button. Amplitude is now active. You can change the value using the keypad or navigation control.
6. Press the **Amplitude/High** shortcut button again to toggle the parameter to **High Level**. You can change the value using the keypad or navigation control.
7. To change the amplitude units, press the down arrow next to **Units**.

NOTE. The default unit is volts V_{pp}.

The following table shows the relationship between V_{pp}, V_{rms}, and dBm, assuming a sine wave with a 50 Ω load.

Table 5: Relationship between V_{pp}, V_{rms}, and dBm, assuming a 50 Ω load

V _{pp}	V _{rms}	dBm
20.00 V _{pp}	7.07 V _{rms}	+30.00 dBm
10.00 V _{pp}	3.54 V _{rms}	+23.98 dBm
2.828 V _{pp}	1.00 V _{rms}	+13.01 dBm
2.000 V _{pp}	707 V _{rms}	+10.00 dBm
1.414 V _{pp}	500 V _{rms}	+6.99 dBm
632 mV _{pp}	224 mV _{rms}	+0.00 dBm
283 mV _{pp}	100 mV _{rms}	-6.99 dBm
200 mV _{pp}	70.7 mV _{rms}	-10.00 dBm
10.0 mV _{pp}	3.54 mV _{rms}	-36.02 dBm

Select waveform

The instrument provides 12 standard waveforms (Sine, Square, Ramp, Pulse, Sin(x)/x, Noise, DC, Gaussian, Lorentz, Exponential Rise, Exponential Decay, and Haversine). The instrument also stores and recalls user-defined arbitrary waveforms. You can create, edit, and save your custom waveforms (see [ArbBuilder settings](#) (on page 22) for more information).

You can also create modulated waveforms using the Run Mode Modulation menus. The following table shows the combination of modulation type and the shape of the output waveform.

Table 6: Modulation type and output waveform shape.

Run mode	Sine, Square, Ramp, Arb, Sin(x)/x, Gaussian, Lorentz, Exponential rise, Exponential decay, Haversine	Pulse	Noise, DC
Continuous	•	•	•
Modulation			
AM	•		
FM	•		
PM	•		
FSK	•		
PWM		•	
Sweep	•		
Burst	•	•	

NOTE. When the instrument outputs an arbitrary waveform, the volts peak-to-peak (V_{pp}) instrument setup indicates the V_{pp} value of normalized waveform data. When the instrument outputs Sin(x)/x, Gaussian, Lorentz, Exponential Rise, Exponential Decay, or Haversine, V_{pp} is defined as twice the value of 0 to peak value.

To select an output waveform:

1. Select the **Basic** icon. You can directly select one of four standard waveforms on the touchscreen menu or use the front-panel button.

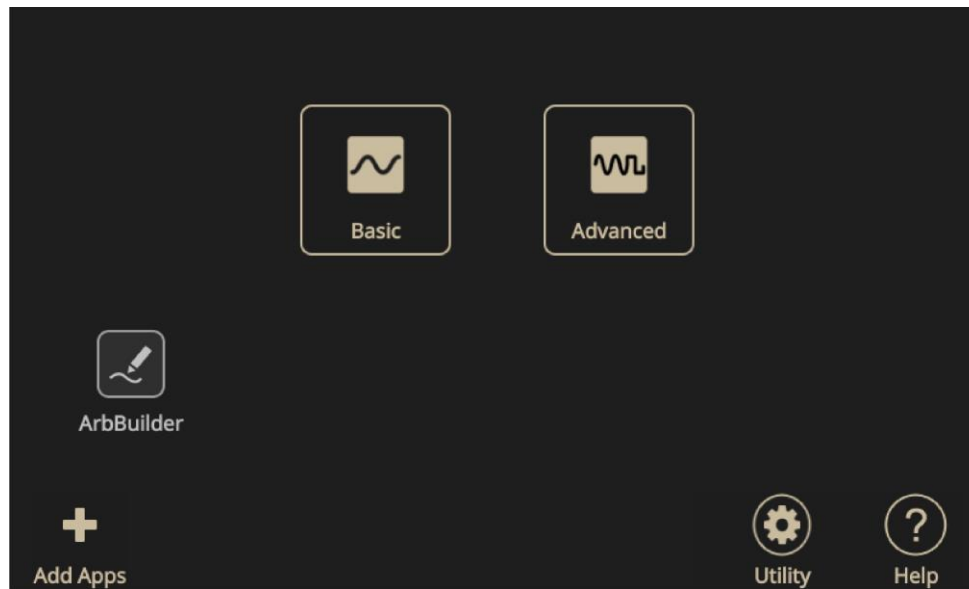

Figure 10: Touchscreen

2. Select the **Continuous** function using the touchscreen menu or the front-panel button.

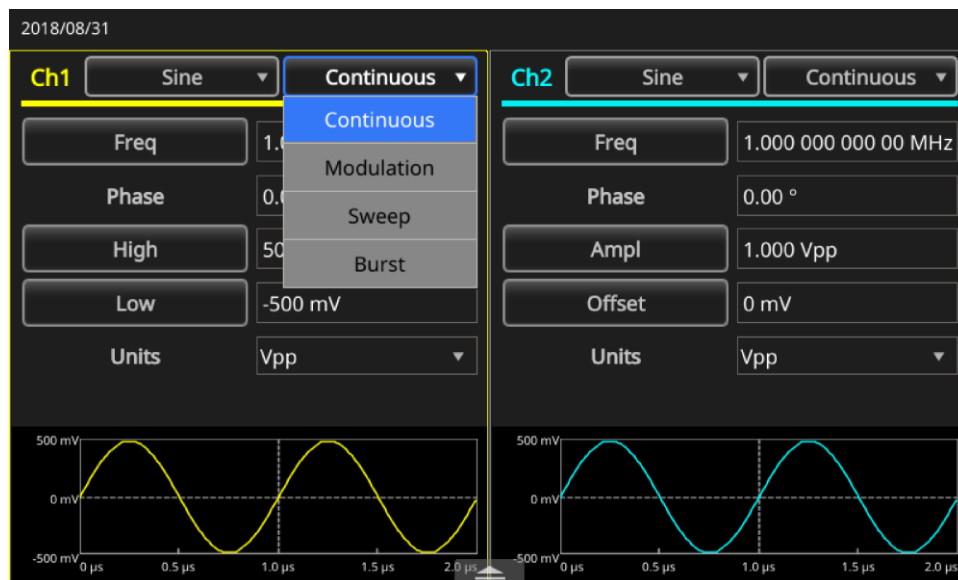

Figure 11: Select continuous function

3. Select the **Sine** waveform using the touchscreen drop-down menu or the front-panel button.

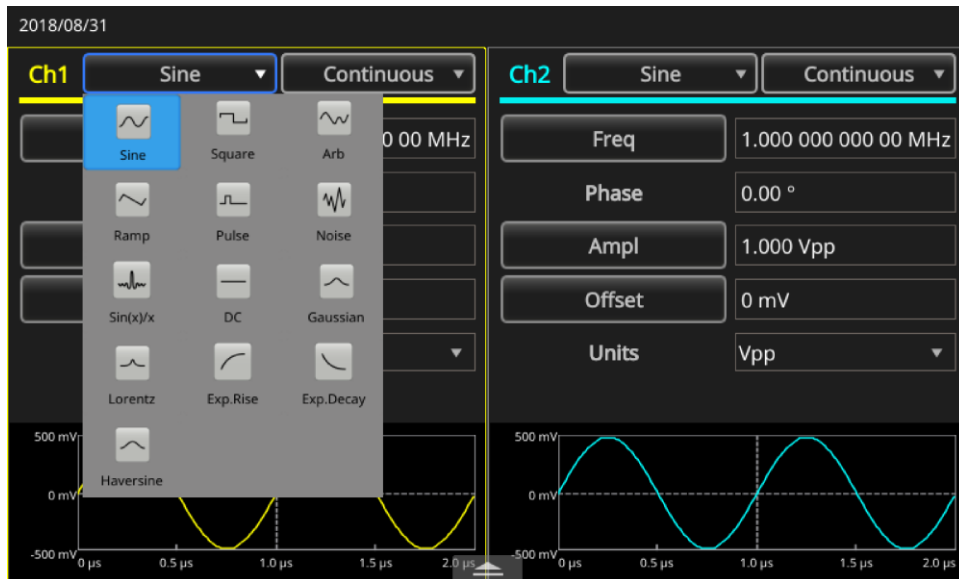

Figure 12: Sine waveform select

4. To change the waveform, select the waveform menu and select **Arb** or use the front-panel button.

To select one of the other waveforms available, such as Sin(x)/x, Noise, DC, or Gaussian, select the waveform drop-down menu and choose a waveform.

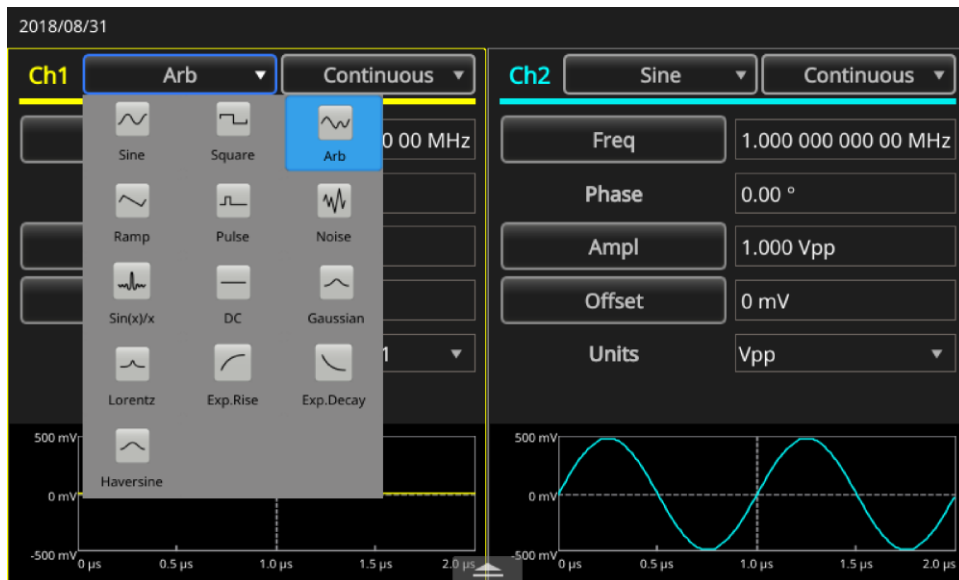

Figure 13: Select Arb waveform

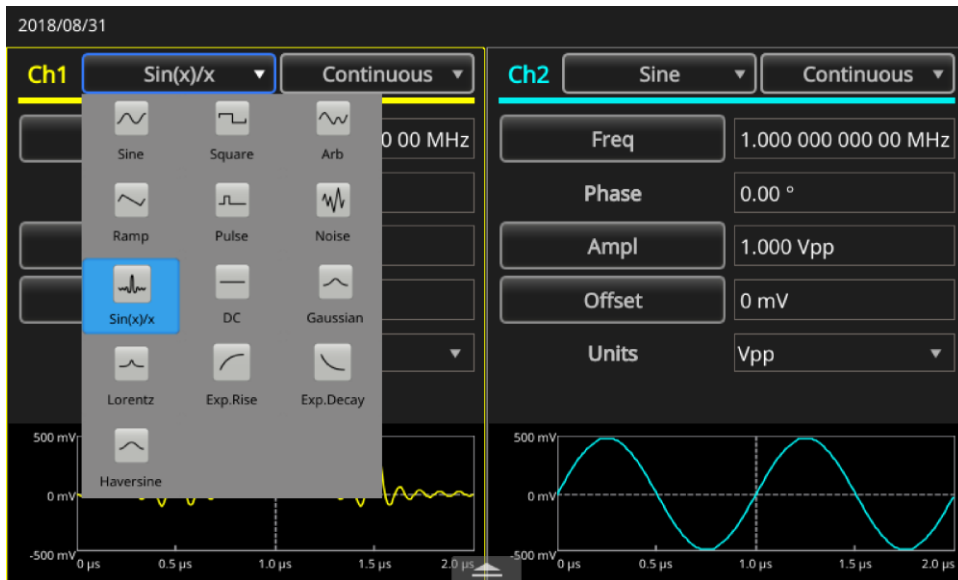

Figure 14: Sin(x)/x waveform select

Basic function modes

The Basic Mode area on the front panel contains the following buttons:

- Continuous
- Modulation
- Sweep
- Burst

You can use these buttons to select the instrument signal output method. See [Select waveform](#) (on page 10) and [Front-panel overview](#) (on page 6) for more information.

Rear panel overview

The following figure shows the connectors for the instrument, and descriptions of the connections follow the figure.

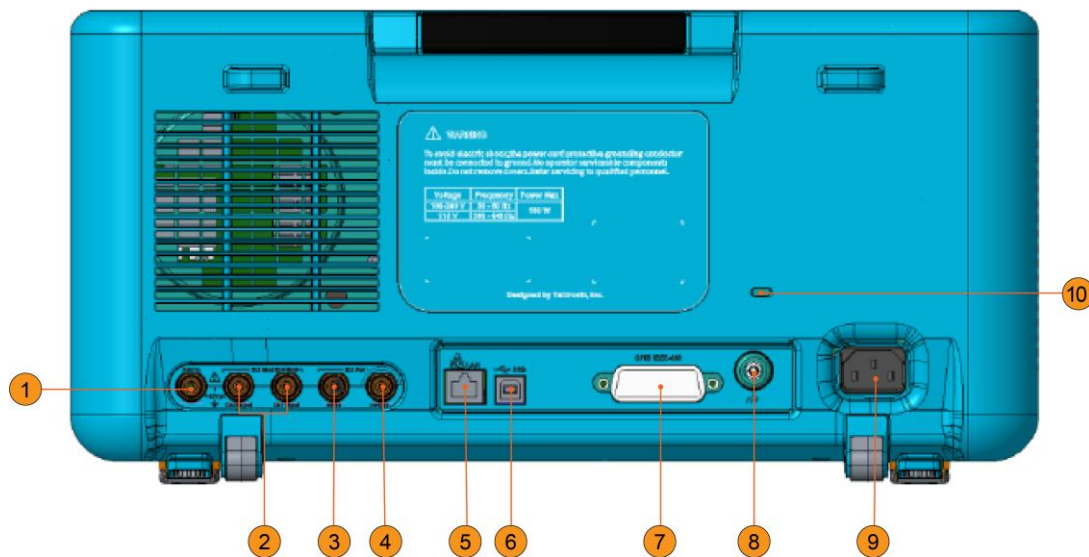

Figure 15: AFG31000 Series rear-panel connectors

1. **Add In:** This is a BNC input connector where you can add an external signal to the CH1 output signal.
2. **Ext Mod Input:** There are two (channel 1 and channel 2) BNC external modulation inputs. The signal input level of these connectors controls modulation settings. The channel 1 and channel 2 inputs are independent.
3. **Ext Ref Input:** This is a BNC external reference input connector. When you want to synchronize multiple arbitrary function generators, or synchronize your AFG31000 Series and another instrument, use the external reference input connector.
4. **Ext Ref Output:** This is a BNC external reference output connector. When you want to synchronize multiple arbitrary function generators, or synchronize your AFG31000 Series and another instrument, use the external reference output connector.
5. **LAN:** Connects the instrument to a network. Connect a 10 BASE-T or 100 BASE-T cable here.
6. **USB (Type B):** Connects to a USB controller.

NOTE. The USB connector on the front panel is a USB Type A connector.

7. **GPIB:** Controls the instrument through GPIB commands.
8. **Chassis ground screw:** The chassis ground screw is used to ground the instrument (#6-32, 6.35 mm (0.25 in.) length or less).
9. **Power receptacle:** This is where you insert the AC power cord that is connected to an AC power source.
10. **Security slot:** Use a standard (Kensington) laptop computer security cable to secure the instrument to your location.

USB interface

You can use a USB cable to connect your instrument to a computer. To connect an instrument to your computer, you will need to use a USB Type A connector connected to the computer and a Type B connector connected to the instrument. This interface allows you to communicate with your instrument.

NOTE. There is a USB Type A connector on the instrument front panel for use with a flash drive; the USB Type B connector is on the rear panel.

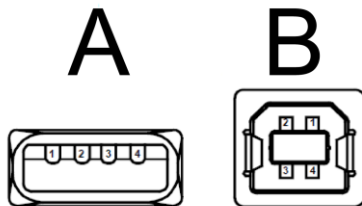

Figure 16: Type A and B USB connectors

Channel selection

Press the front-panel **CH1/CH2** (channel selection) button to control the screen display. You can toggle between the two channels.

Output on and off

For dual-channel models, you can turn on or off the signal output for channel one and channel two independently. You can enable one of the two channels or enable both of the channels at any time.

To enable signal output:

1. Press the front-panel **Ch1 Output** button. The button is illuminated when it is on.
2. For dual-channel models only, press the front-panel **Ch2 Output** button. The button is illuminated when it is on.

NOTE. You can configure the signal with the outputs off. This minimizes the chance of sending a problematic signal to a device under test (DUT).

Remote communications options

There are USB, GPIB, and LAN communications interfaces on the rear panel of the instrument. Use TekVISA, which can be downloaded from www.tek.com to communicate with the instrument. Only one interface can be used at a time. You can use the interface to send remote commands to the instrument.

NOTE. You can find more information and a detailed description of the command list in the AFG31000 Series Arbitrary Function Generator Series *Programmer's Manual* (07714880x).

Here is an example of how you implement a typical remote command. This command locks the front panel and prevents local front-panel operation. It is intended for system integration or mass production customers who typically use a computer to control the instrument.

The remote command to lock the instrument:

```
SYSTem:KLOCK[:STATe]
```

The remote command to unlock the instrument:

```
SYSTem:KUNLOCK[:STATe]
```

To lock the instrument using a remote command:

1. Connect a USB or LAN cable between the AFG31000 Series Arbitrary Function Generator and the computer.
2. Install TekVISA on your computer (you can download it from www.tek.com).
3. Launch OpenChoice Talker Listener after TekVISA is installed and select your instrument. If your instrument is not in the Instruments list, verify the cable connection and check the IP address if you are using LAN.

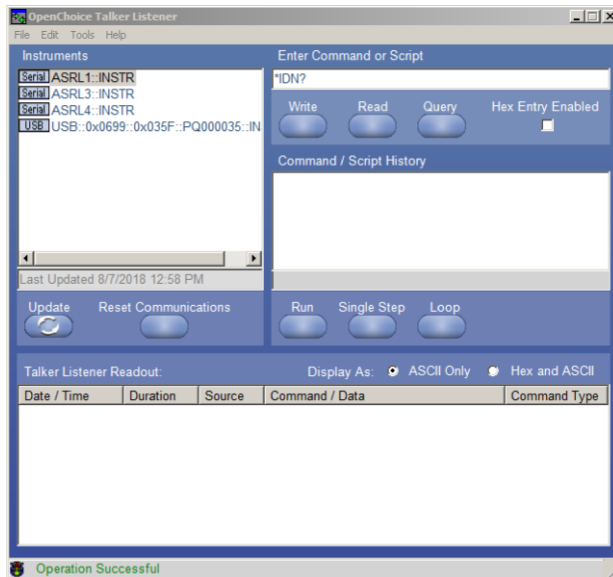

Figure 17: TekVISA instrument selection, Talker Listener

4. Select your instrument from the Instrument list.
5. The command `*IDN?` has already been populated in the command field.
6. Select **Query** to display the result in the Talker Listener Readout area.
7. Input `SYSTem:KLOCK:STATe ON` in the command field.
8. Select **Write**. The command is written to the AFG31000 Series Arbitrary Function Generator.
9. Press any button on the front panel to confirm that the front panel is locked.

Operating basics

Power the instrument

The following procedure shows you how to connect the instrument to power and turn it on and off.

Connect the power cord:

1. Make sure the front-panel power switch is in the off position
2. Connect the female end of the supplied power cord to the AC receptacle on the rear panel.
3. Connect the male end of the power cord to a grounded AC outlet.

To power on the instrument:

Press the front-panel power switch to turn on the instrument.



Figure 18: AFG31000 Series two-channel front view

NOTE. Wait until the front-panel display shows that the instrument has passed all power-on self-tests before using the instrument.

Touchscreen interface

The following figures describe the touchscreen main display.

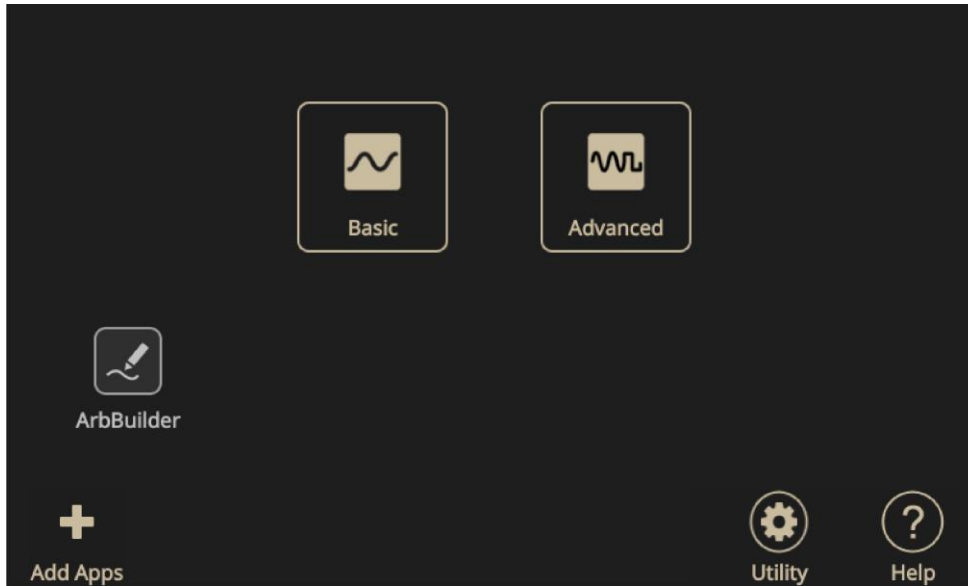

Figure 19: Touchscreen main display

Basic mode default screen

The AFG default screen allows you to change the following parameters:

- Waveform
- Basic function (continuous, modulation, sweep, or burst)
- Frequency
- Voltage limits
- Phase
- Units (V_{pp} , V_{rms} , or dBm)

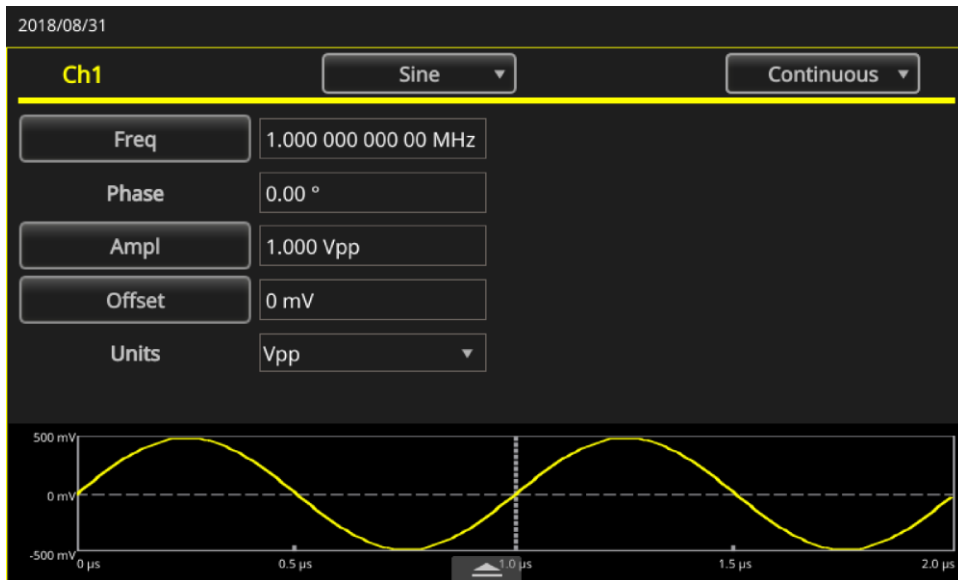

Figure 20: One-channel AFG home screen

Advanced mode default screen

The Advanced mode default screen allows you to:

- Choose from available waveforms.
- Open a saved waveform sequence by selecting **Sequence**. Waveforms can be shown in the Waveform List with waveform name and length. The waveforms can be inserted in the sequence table as one step. Each step can be defined as loop or branch (wait, jump, or go to) triggered by a variety of events. The sequencer can include up to 256 steps, and up to 16 MB of waveforms for each channel (128 MB optional).
- Create a new waveform sequence and save.

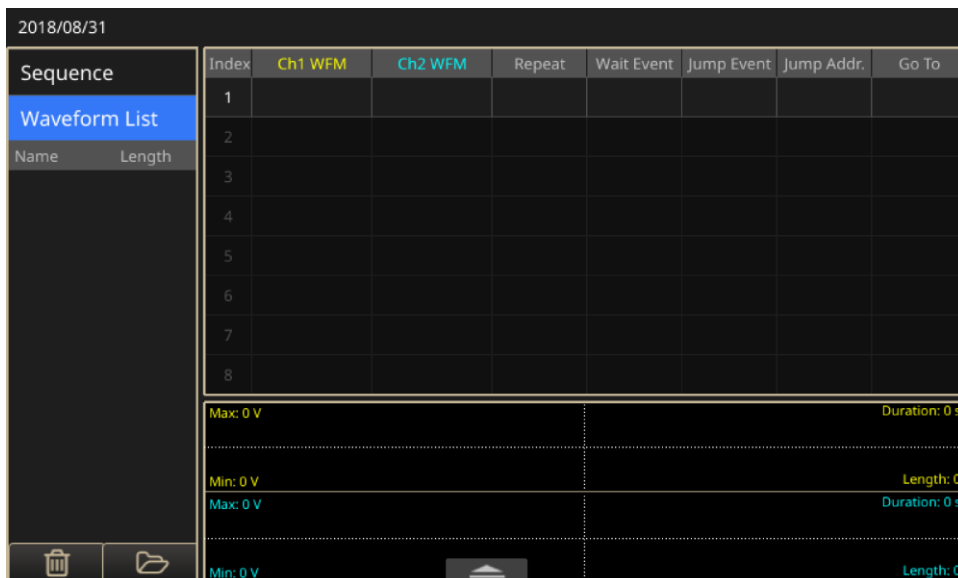

Figure 21: Two-channel advanced mode home screen



Figure 22: One-channel sequence screen

ArbBuilder settings

You can open previously created waveforms or create a new waveform using the ArbBuilder tool. When you select the ArbBuilder icon to open ArbBuilder, the following selections are visible at the bottom of the interface:

- **File:** Open, save, resample, or create a new standard waveform or a new equation.
- **Draw:** Create freehand waveforms, draw horizontally and vertically. You can also draw by points.
- **Edit:** Edit a waveform.
- **Send:** Send to the channel that you want to use.
- **Exit:** Exit ArbBuilder.



Figure 23: ArbBuilder home screen

Add or remove an app

You can install apps (software applications) from a USB flash drive onto the AFG31000 Series. Visit www.tek.com to search or browse apps available for your AFG31000 Series.

To install an app:

1. Download an app from the www.tek.com website.
2. Save the app to a USB flash drive.
3. Insert the flash drive into the USB input on the front panel of the AFG31000 Series. The **Add Apps** icon becomes available.

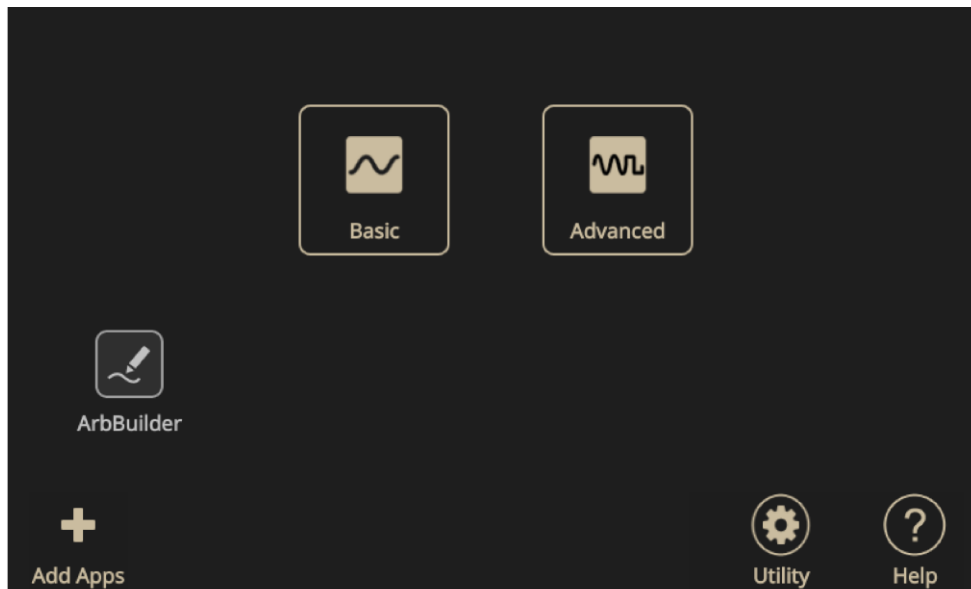

Active Add
Apps icon

Figure 24: Add Apps icon active

4. Select the **Add Apps** icon.
5. Navigate to your downloaded app and select it. Apps have a *.tfa file extension.

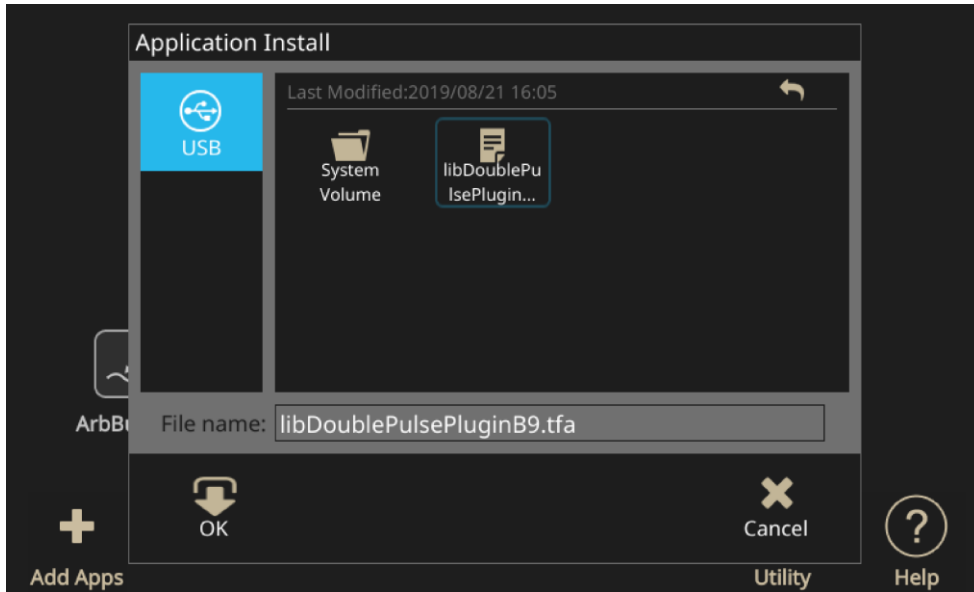

Figure 25: Navigating to the downloaded app

6. Select **OK** to begin installing the app.
7. Power on and then power off the instrument when prompted.
8. The new app is available on the main screen.

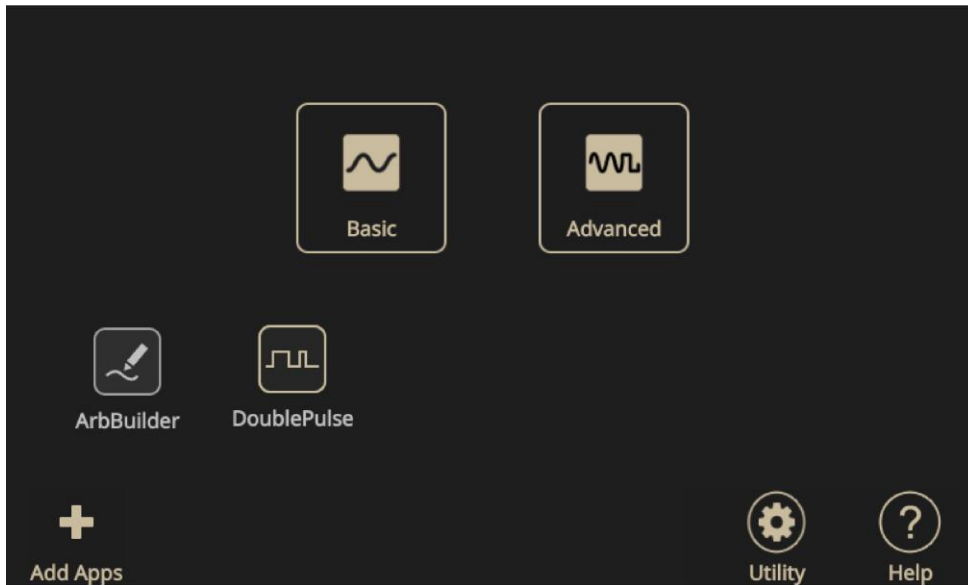

Figure 26: New app available

To remove an app:

1. Select and hold the app icon for two seconds, then release. You are prompted to confirm the removal.
2. Select **OK** to continue or **Cancel**.
3. Power on and then power off the instrument when prompted.

Utility menu

Select the front-panel **Utility** icon (gear) to see the Utility menu on the instrument touchscreen. The Utility menu provides access to the following options:

- System
- Diagnostics/Calibration
- I/O Interface
- Security Menu
- Firmware
- License

See [Utility menu options](#) (on page 84) for more information.

Function introduction

Basic mode

The AFG31000 Series Arbitrary Function Generator provides both Basic and Advanced (Sequence) modes.

- Basic mode has a dedicated user interface similar to a traditional arbitrary function generator. The generating function and arbitrary waveforms are controlled with a minimum number of button clicks and a shallow menu hierarchy. You can switch from one frequency to another without worrying about waveform length and sampling rate. This is particularly valuable when working with analog designs like filter/amplifier frequency response characterization or digital designs where the clock rate needs to change frequently.
- [Advanced mode](#) (on page 67) allows you to generate long waveforms or waveforms with complex timing.

Touchscreen swipe areas

The touchscreen swipe areas are available on multiple screens, including Basic, Advanced, and ArbBuilder.

NOTE. You cannot access the swipe areas while on the Home screen or Utility screen.

See the following figures to see where you can swipe to gain access to additional features and information.

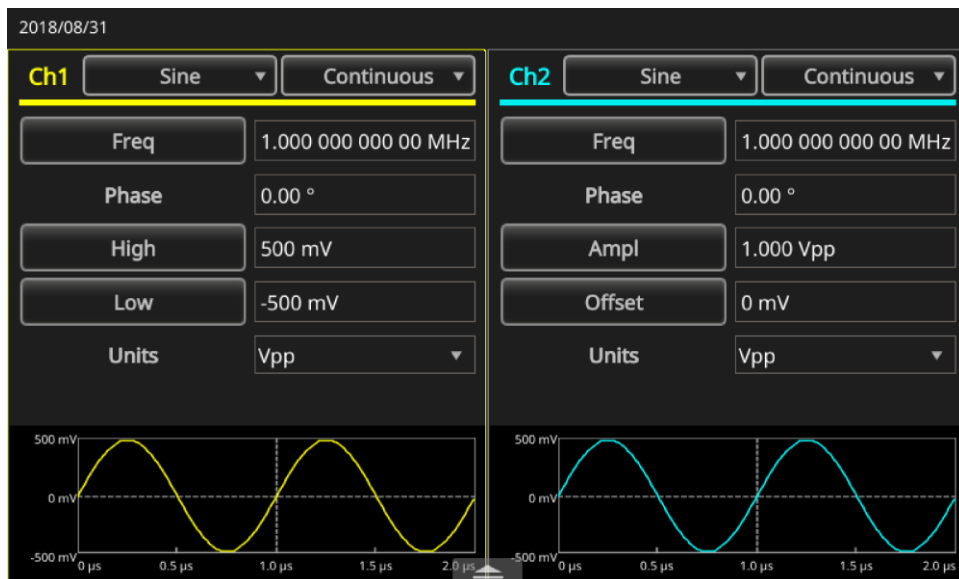

Figure 27: Bottom swipe area

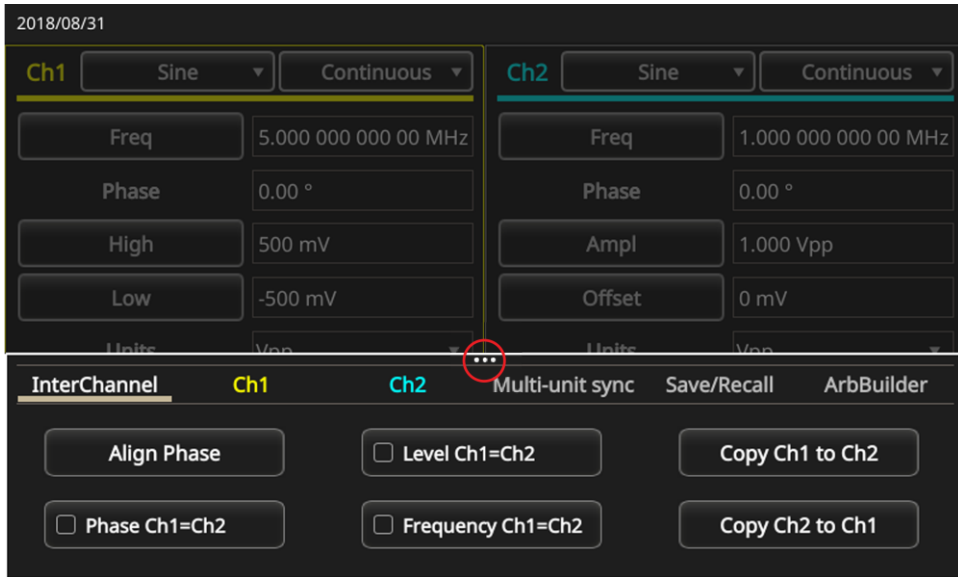

Figure 28: Bottom swipe area tabs

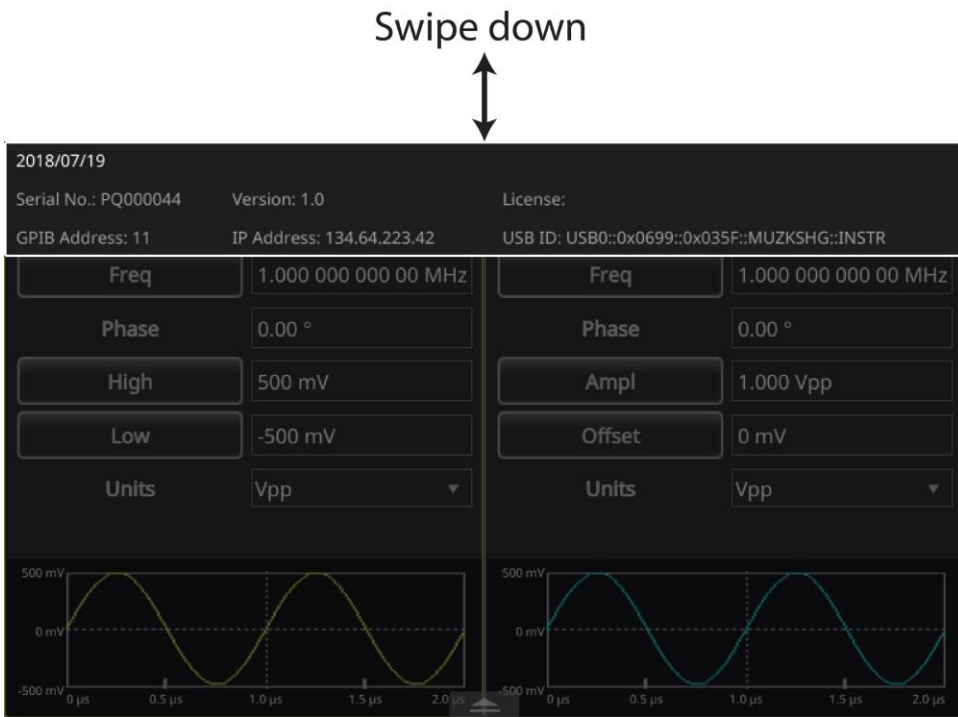

Figure 29: Top swipe area

Create a pulse waveform

To create a pulse waveform:

1. Select **Basic**.
2. Select the drop-down arrow for the waveform options.
3. Select **Pulse**.
4. Select **Frequency** on the touchscreen to toggle between Period and Frequency.
5. On the touchscreen, select **Duty** and enter the settings using the touchscreen keypad.
6. Select **Duty** again to toggle between Duty and Width. Enter the settings for Width.
7. Select **Leading and Trailing** and enter the settings for the leading and trailing edge.

Pulse waveform formulas

The following figure and formula help to explain the correlation between pulse period, duty cycle, pulse width, and the leading and trailing edge times.

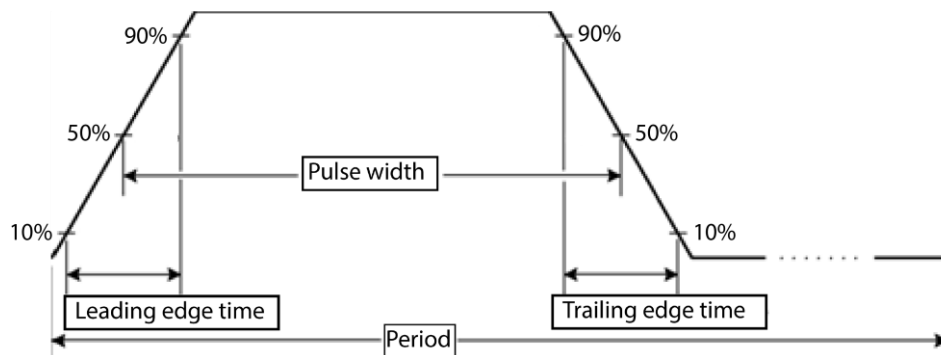

Figure 30: Pulse period width

The following pulse waveform formulas are applied to leading edge time, trailing edge time, pulse period, and pulse width.

$$lEdge = \text{Leading edge time}$$

$$tEdge = \text{Trailing edge time}$$

Maximum leading edge time. This value is the minimum of the three calculations in each instance.

If runMode = Continuous:

$$Temp1 = 0.8 * 2.0 * width - tEdge$$

$$Temp2 = (period - width) * 0.8 * 2.0 - tEdge$$

$$Temp3 = 0.625 * period$$

If runMode is not Continuous:

$$Temp1 = 0.8 * 2.0 * width - tEdge$$

$$Temp2 = (period - leadDelay - width) * 0.8 * 2.0 - tEdge$$

$$Temp3 = 0.625 * period$$

Maximum trailing edge time. This value is the minimum of the three calculations in each instance.

If runMode = Continuous:

$$Temp1 = 0.8 * 2.0 * width - lEdge$$

$$Temp2 = (period - width) * 0.8 * 2.0 - IEdge$$

$$Temp3 = 0.625 * period$$

If runMode is not Continuous:

$$Temp1 = 0.8 * 2.0 * width - IEdge$$

$$Temp2 = (period - leadDelay - width) * 0.8 * 2.0 - IEdge$$

$$Temp3 = 0.625 * period$$

Open or save arbitrary waveforms

You can save arbitrary waveforms in the instrument internal memory or USB memory. If you need to save more waveforms, use a USB flash drive that is inserted in the USB port.

To open a waveform:

1. Select the **Basic** icon on the touchscreen.
2. On the touchscreen, swipe the white arrow at the bottom of the screen up and go to the **ArbBuilder** tab (see [touchscreen swipe areas](#) (on page 27) for more information).

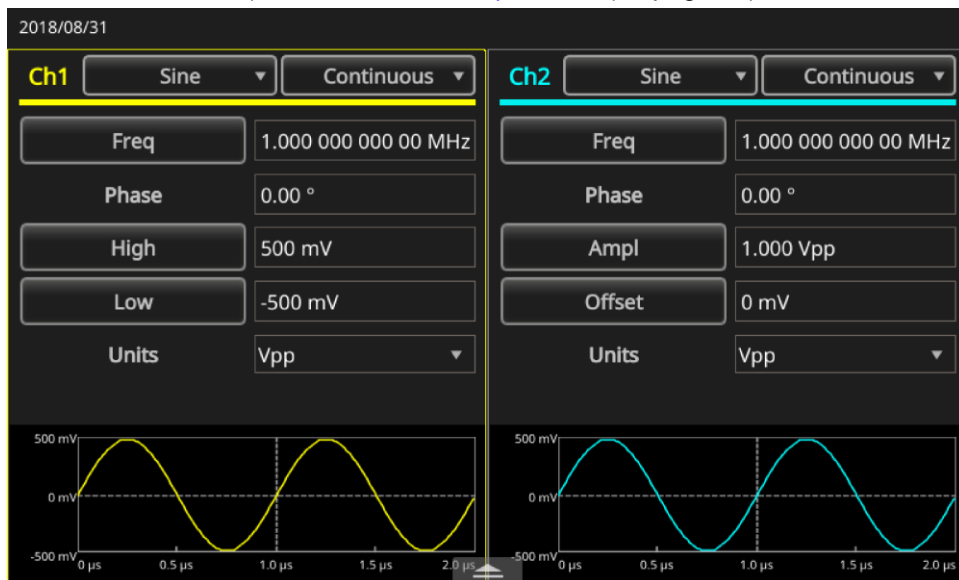

Figure 31: Bottom swipe area

3. Select **Open**.

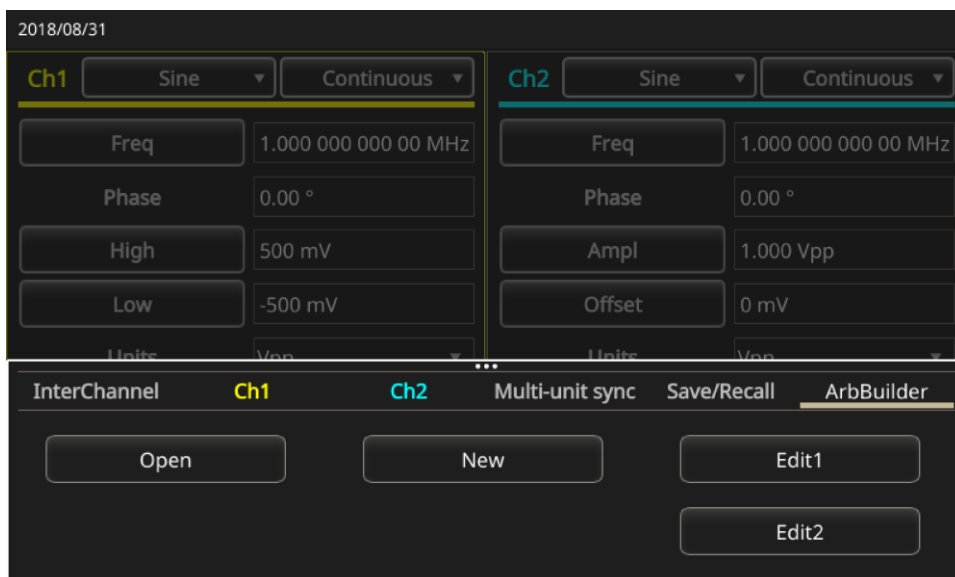

Figure 32: ArbBuilder tab

To save a waveform:

1. When you have a waveform opened, select **File**.
2. If you do not see File on the menu, you will see Save and Save As. Select **Save As** if you want to change the name and location of where the file is saved. If you want to save the file with the same name, select **Save**.

Create noise or DC

To create noise:

1. Select **Basic**.
2. Select the waveform name on the CH1 drop-down menu on the touchscreen.
3. Select **Noise**.

To create a DC waveform:

1. Select **Basic**.
2. Select the waveform name on the CH1 drop-down menu on the touchscreen.
3. Select **DC**.

NOTE. You cannot modulate or sweep noise.

Create a burst waveform

The instrument can output a burst using standard waveforms such as sine, square, ramp, pulse, or arbitrary waveforms. The instrument allows you to use the following types of burst modes.

Create a triggered burst waveform

A specified number (burst count) of waveform cycles are output when the instrument receives a trigger input from the internal trigger source, an external trigger source, a remote command, or the Manual trigger button.

The following example describes how to create a double pulse using the burst mode.

To create a triggered burst waveform:

1. Select **Basic**.
2. Select **Continuous** on the CH1 drop-down menu on the touchscreen.
3. Select **Burst**.
4. For the Mode setting, confirm that **1 Cycle**, **n Cycles**, or **Inf. Cycles** is selected, which means triggered burst mode is enabled.
5. To create a double pulse, set the **Cycle** setting (N-Cycles) to 2. The following figure shows that this waveform is a trigger output signal.



Figure 33: Burst pulse waveform

Create a gated burst waveform

The instrument outputs a continuous waveform when an effective gate signal is applied externally, when the Manual trigger button is pressed, when a remote command is applied, or during 50% of the selected internal trigger interval.

In the gated burst mode, the output is enabled or disabled based on the internal gate signal or an external signal applied to the front-panel trigger input connector. While the gate signal is true or the front-panel Manual trigger button is pushed in, the instrument outputs a continuous waveform.

To create a gated-burst waveform:

1. Select **Basic**.
2. Select **Sine** on the CH1 drop-down menu on the touchscreen.
3. Select **Burst**.
4. Confirm that **Gate** mode is selected, which enables gated-burst mode.

The following figure is an oscilloscope screen. The top waveform is a trigger output signal. The bottom waveform is a gated waveform.

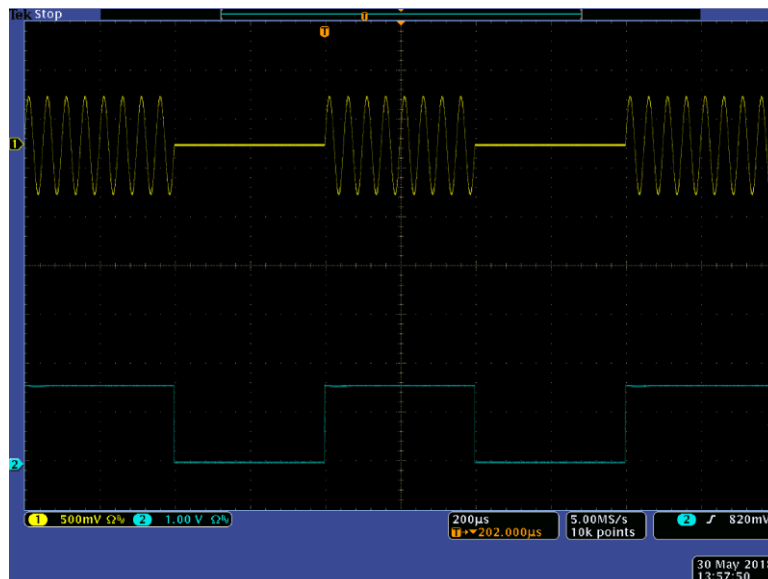

Figure 34: Gated burst waveform

NOTE. The instrument provides the following trigger sources for burst mode: Internal or external trigger signal, manual trigger, or remote command. If you select Gate, burst count settings are ignored.

Sweep a waveform

The sweep outputs a waveform with the output signal frequency varying linearly or logarithmically.

You can set the following settings for Sweep (scroll down to reveal all of the options):

- Start frequency
- Stop frequency
- Amplitude
- Offset
- Units
- Sweep time
- Return time
- Center frequency
- Frequency span
- Hold time

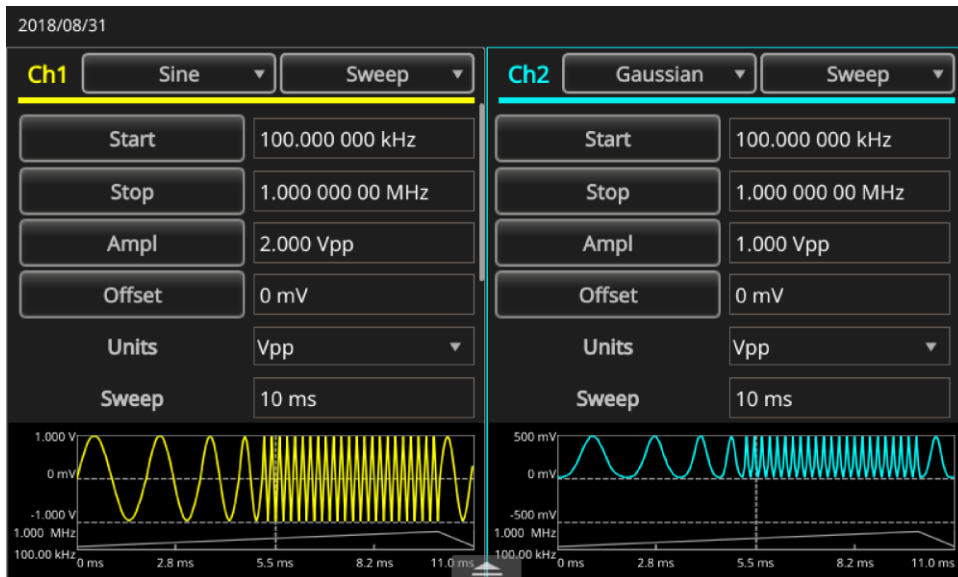

Figure 35: Sweep waveform settings

To sweep a waveform:

1. Select **Basic**.
2. Make sure that **Sine** is selected for CH1 on the touchscreen. For this example, a sine waveform is used as an output waveform (carrier waveform).
3. Select **Continuous** mode on the CH1 drop-down menu on the touchscreen.
4. Select **Sweep**. You can specify the start frequency, stop frequency, sweep time, and return time from the sweep menu. Return Time represents the amount of time from Stop Frequency to Start Frequency.

The following figure is a sample oscilloscope screen. The top waveform is a sample sweep waveform. The bottom waveform is a trigger output signal.

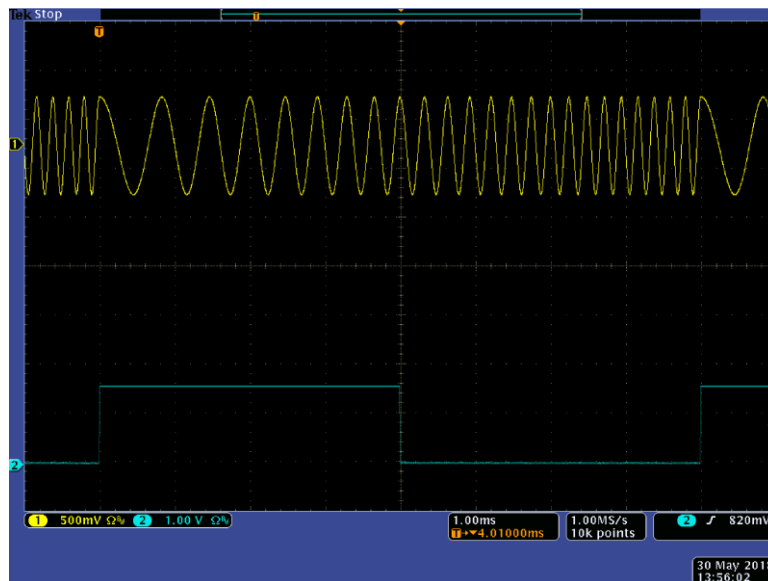

Figure 36: Oscilloscope sweep waveform

NOTE. For frequency sweeps, you can select a sine, square, ramp, or arbitrary waveform. Pulse, DC, and Noise waveforms cannot be selected. Once the sweep is selected, the frequency is swept from the sweep start to the sweep stop frequencies. If a start frequency is lower than a stop frequency, the instrument sweeps from the low frequency to the high frequency. If a start frequency is higher than a stop frequency, the instrument sweeps from the high frequency to the low frequency.

Modulate a waveform

The following example describes how to modulate a waveform using the Modulation button.

To output an AM waveform:

1. Select **Basic**.
2. Make sure that **Sine** is selected for CH1 on the touchscreen. For this example, a sine waveform is used as an output waveform (carrier waveform).
3. Select **Continuous** mode on the CH1 drop-down menu on the touchscreen.
4. Select **Modulation**.
5. Scroll down to find the Mod Type and change it to **AM**.
6. Select **Internal** for the AM Source setting.
7. Scroll down to find the AM Freq setting.
8. Select the **Depth** setting to adjust the depth percentage.

The following figure is an example amplitude modulation waveform displayed on an oscilloscope.

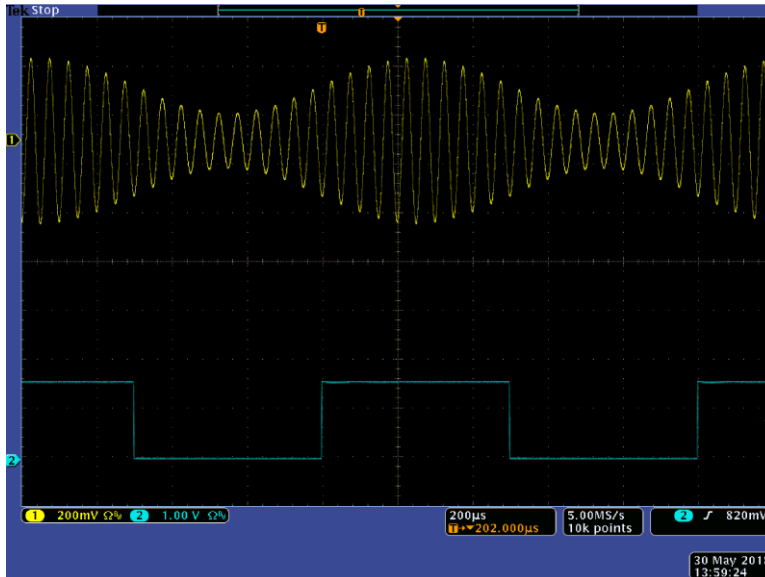

Figure 37: Oscilloscope amplitude modulation waveform

NOTE. You can output frequency modulation or phase modulation waveforms using the same steps above. You cannot choose Pulse, Noise, or DC carrier waveform. You can select an internal or external signal as an AM source. If you select an external source and set the modulation depth to 120%, the output is at the maximum amplitude when a $\pm 1 V_{pp}$ signal is applied to the rear panel EXT MODULATION INPUT connector. You can select a modulation shape from the internal memory or USB flash drive.

The following equations show the output amplitude of AM, FM, and PM modulation (in this example, sine waveform is used for carrier waveform and modulation waveform):

$$\text{AM:Output}(V_{p-p}) = \frac{A}{1.1(1+100)} \frac{M}{\sin(2\pi f_m t)) \sin(2\pi f_m t)) \sin(2\pi f_c t)}$$

$$\text{FM:Output}(V_{p-p}) = A \sin(2\pi(fc + D \sin(2\pi f_m t))t)$$

$$\text{AM:Output}(V_{p-p}) = A \sin(2\pi f_c t + 2\pi \frac{P}{360} \sin(2\pi f_m t))$$

Figure 38: Waveform-modulation equations

The following table indicates what the symbols in the previous equations represent.

Table 7: Output amplitude equation symbols

Carrier amplitude	A (V_{p-p})
Carrier frequency	f_c (Hz)
Modulation frequency	f_m (Hz)
Time	t (sec)
AM modulation depth	m (%)
FM deviation	D (Hz)
PM deviation	P (degree)

The following table indicates the relationships between modulation depth and maximum amplitude for AM modulation waveform (internal modulation source is selected).

Table 8: Depth and maximum amplitude relationships

Depth	Maximum amplitude
120%	A (V_{pp})
100%	A (V_{pp}) * 0.909
50%	A (V_{pp}) * 0.682
0%	A (V_{pp}) * 0.455

FSK waveform

Frequency-shift keying modulation is a modulation technique that shifts the output signal frequency between the carrier frequency and the hop frequency. The following example describes how to output an FSK waveform.

To output an FSK waveform:

1. Select **Basic**.
2. Make sure that **Sine** is selected for CH1 on the touchscreen. For this example, a sine waveform is used as an output waveform (carrier waveform).
3. Select **Continuous** mode on the CH1 drop-down menu on the touchscreen.
4. Select **Modulation**.
5. Scroll down to find the Mod Type and change it to **FSK**.
6. For FSK Source, choose either **Internal** or **External**. If you choose External, the FSK Rate is ignored.
7. Select **Hop Frequency** to adjust its value. Note that the carrier waveform frequency shifts to the hop frequency with the specified FSK rate, and then returns to the original frequency.

NOTE. The AFG31000 Series Arbitrary Function Generator instruments create a phase continuous FSK signal.

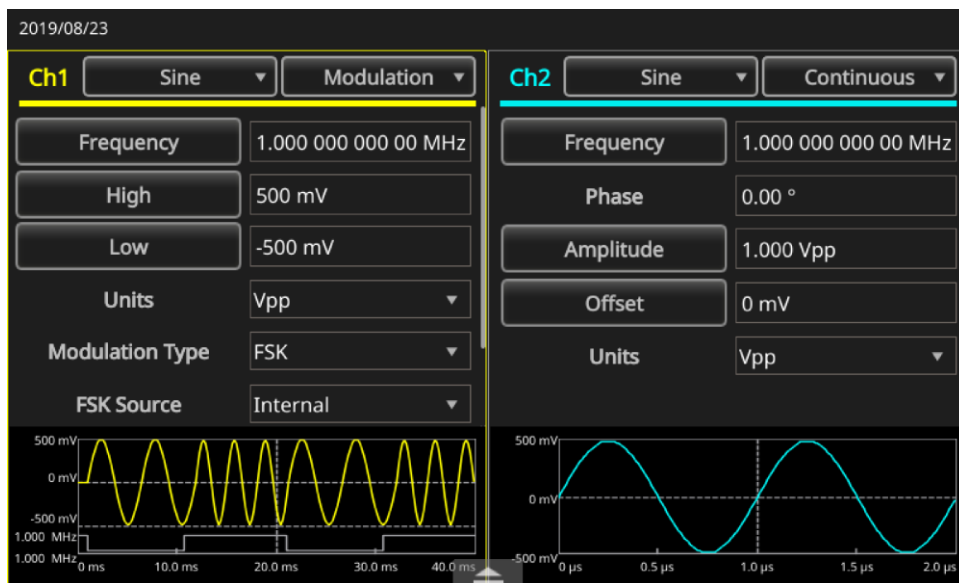

Figure 39: Modulation type

PWM waveform

To output a PWM waveform:

1. Select **Basic**.
2. Select **Pulse** on the CH1 drop-down menu on the touchscreen.

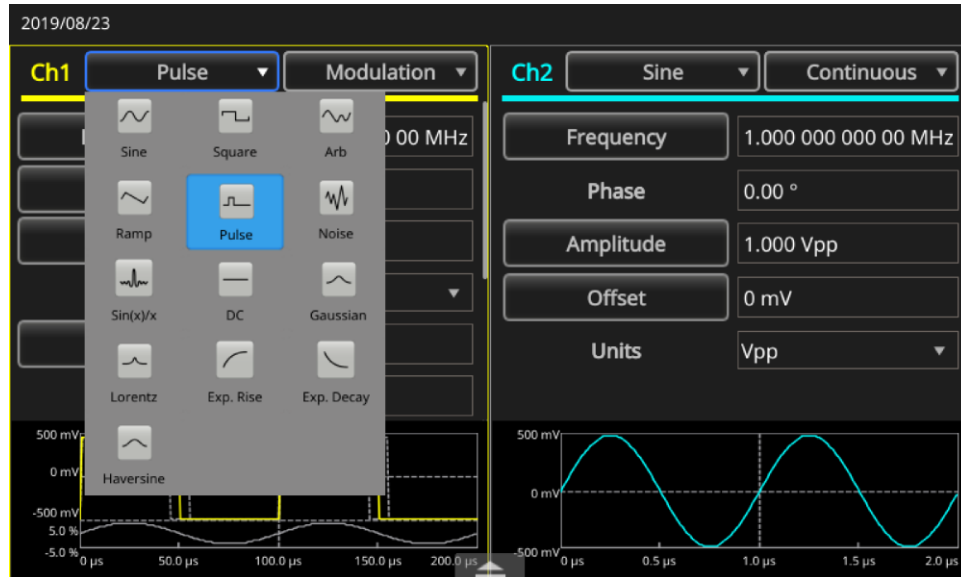

Figure 40: Select pulse

3. Select **Continuous** mode on the CH1 drop-down menu on the touchscreen.
4. Select **Modulation**.



Figure 41: Select modulation

- For the **PWM Source** settings, choose either Internal or External.



Figure 42: PWM source settings

- Select **Deviation** to adjust the deviation percentage (pulse-width deviation).

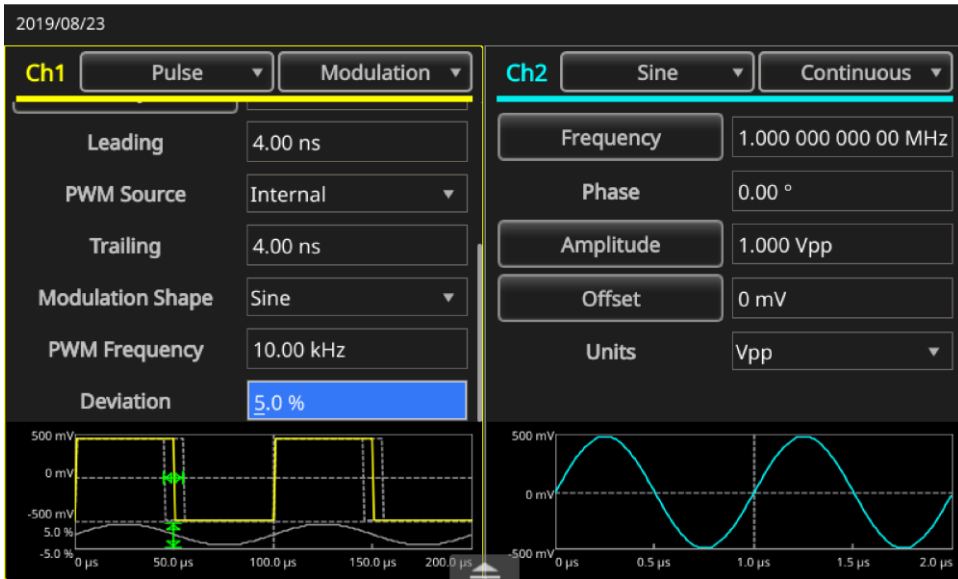

Figure 43: Deviation settings

7. Set the Modulation Shape.

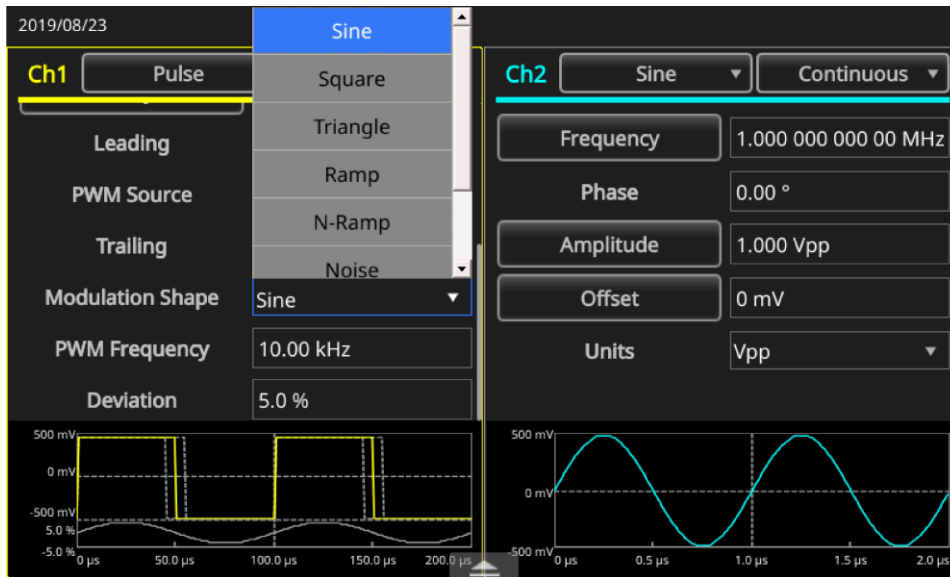

Figure 44: Shape settings

NOTE. For more specific information about this application example, see [Motor speed control by pulse-width modulation](#) (on page 126).

Trigger out

If your instrument is a two-channel model, the trigger output connector and signal of the instrument are linked to the run mode and function selected in CH1.

To set up trigger out:

1. Connect the AFG31000 Series front-panel Ch 1 TRIGGER output connector to the external TRIGGER input connector of the oscilloscopes. The TRIGGER output connector provides the trigger signal for oscilloscopes.
2. Select **Basic**.
3. Select **Continuous** mode on the CH1 drop-down menu on the touchscreen.
4. Select **Square** waveform on the drop-down menu of the touchscreen. The output is a square waveform with the rising edge at the start of each waveform period. When an output frequency is higher than 4.9 MHz, some restrictions are applied.
5. Select **Sweep** mode on the CH1 drop-down menu on the touchscreen. When the Repeat or Trigger sweep mode and internal trigger source are selected, the trigger output is a square waveform with the rising edge at the start of each sweep.
6. Select **Modulation** mode on the CH1 drop-down menu on the touchscreen. When an internal modulation source is selected, the trigger output is a square waveform with the same frequency as the modulating signal. When an external modulation source is selected, the trigger output is disabled.
7. Select **Burst** mode on the CH1 drop-down menu on the touchscreen. When an internal trigger source is selected, the trigger output is a square waveform with the rising edge at the start of each burst period. When an external trigger source is selected, the trigger output is high during the time the trigger input is high.

NOTE. When a frequency setting of an output waveform is higher than 4.9 MHz, a divided frequency that is lower than 4.9 MHz is output from the Trigger Out (see the following table).

Table 9: Set waveform output frequency

Set frequency of output waveform (MHz)	Trigger output frequency (F, in MHz)
~ 4.900 000 000 00	Fs
4.900 000 000 01 to 14.700 000 000 0	Fs/3
14.700 000 000 1 to 24.500 000 000 0	Fs/5
24.500 000 000 1 to 34.300 000 000 0	Fs/7
34.300 000 000 1 to 44.100 000 000 0	Fs/9
44.100 000 000 1 to 50.000 000 000 0	Fs/11
50.000 000 000 1 ~	No signal

NOTE. The Trigger Out signal cannot be output when the instrument outputs a continuous signal higher than 50 MHz. When the instrument outputs a modulation waveform, the Trigger Output signal cannot be output if you select External as the modulation source.

Align two-channel signals

NOTE. This topic applies to two-channel AFG31000 Series instruments.

The AFG31000 Series Arbitrary Function Generator uses a phase continuous method to change frequency. When you change the frequency of a channel, it affects the phase relationship between the two channels.

For example, if the instrument is generating a 5 MHz sine waveform for both CH1 and CH2, the phase is adjusted between the two channels. If you change the CH2 frequency to 10 MHz and then return it to 5 MHz, the CH2 phase does not return to its initial condition. To adjust the phase relationship between the two channels, you must stop and restart signal generation. The instrument provides a function called Align Phase to adjust the phase relationship.

The following example describes how to adjust settings for a two-channel instrument. In this example, a 5 MHz continuous sine waveform is used. Confirm that both phases are set to 0 degrees.

To align settings of two-channel signals:

1. Select **Basic**.
2. On the touchscreen, change the CH1 Freq settings to **10 MHz**, and then to **5 MHz**. Note that the CH2 frequency or phase does not change frequencies.

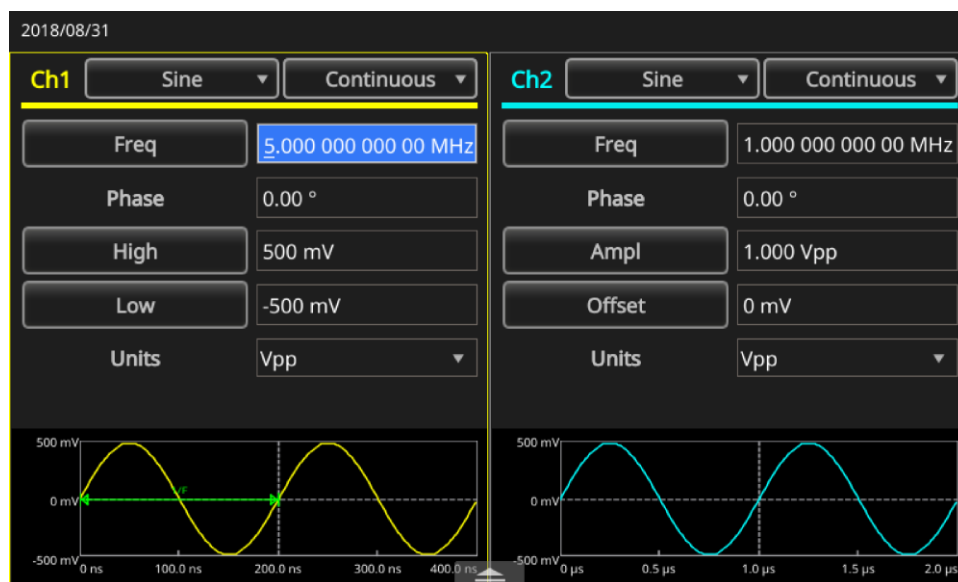

Figure 45: CH1 frequency 5 MHz

3. Swipe the arrow at the bottom of the screen up and select the **InterChannel** tab.
4. To align the phases of CH1 and CH2, select **Align Phase**.

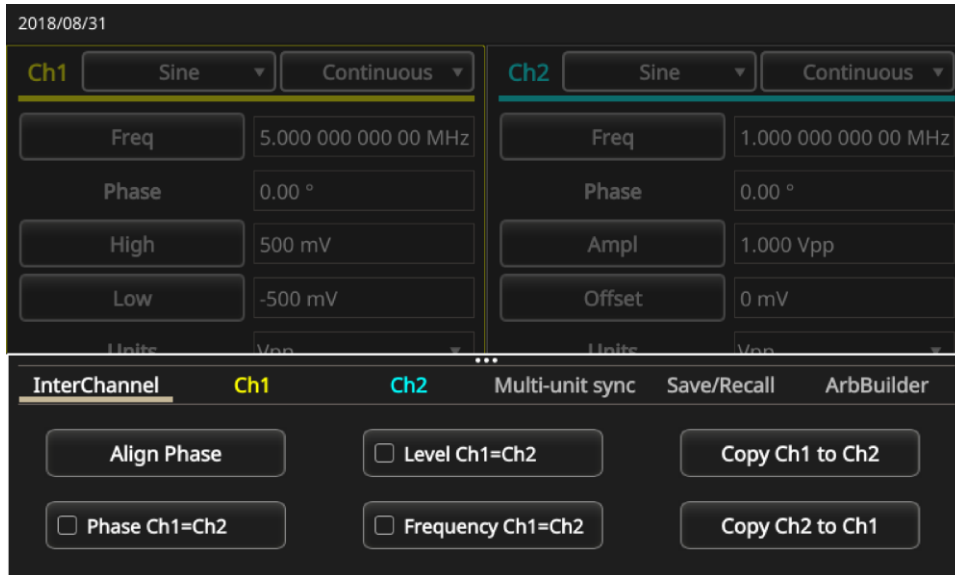

Figure 46: Align Phase CH1 and CH2

When channels one and two are aligned, the instrument stops the signal generation, adjusts the phases of both channels, and automatically restarts the signal generation.

Amplitude

To set the CH1 and CH2 amplitude to the same level, select the **Level CH1=CH2** button.

Frequency/Period

To set the CH1 and CH2 frequency to the same level, select the **Frequency CH1=CH2** button.

Set up load impedance

The output impedance of the AFG31000 Series Arbitrary Function Generator is 50 Ω . If you connect a load with an impedance other than 50 Ω , the displayed Amplitude, Offset, and High/Low values are different from the output voltage. To make the displayed values the same as output voltage, you need to set load impedance. To set the load impedance, use the swipe area on the bottom of the touchscreen.

To set up load impedance:

1. Select **Basic**.
2. Swipe the arrow at the bottom of the screen up and go to the **CH1** tab.
3. Select the **Load** option and choose **Load**, **High Z**, or **50/100**.
4. Set the load impedance to any value from 1 Ω to 50 Ω .

When the load impedance is set to a value other than 50 Ω , the set value is displayed in the output status.

NOTE. The load impedance is applied to the amplitude, offset, and high/low level settings. When dBm is specified for output amplitude units, the amplitude units setting is automatically changed to Vpp if you select high impedance.

Invert waveform polarity

To invert a waveform polarity, use the swipe area on the bottom of the touchscreen. The following example shows how to get a differential signal using the invert function of the two-channel model.

To invert waveform polarity:

1. Select **Basic**.
2. Select **Sine wave**.
3. Select **Continuous** mode on the CH1 drop-down menu on the touchscreen.
4. On the touchscreen, swipe the arrow at the bottom up.
5. On the **InterChannel** tab, select the **Copy CH1 to CH2** button.
6. Select **OK** when prompted to copy the settings.

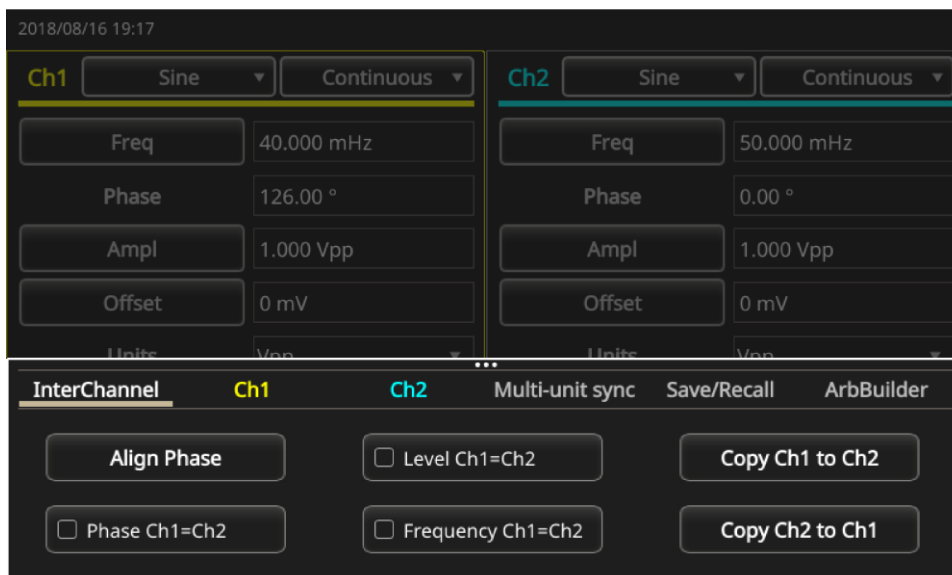

Figure 47: Copy channel 1 to channel 2

- On the **CH2** tab, select **Invert**. Swipe the menu down to view the settings of both channels.

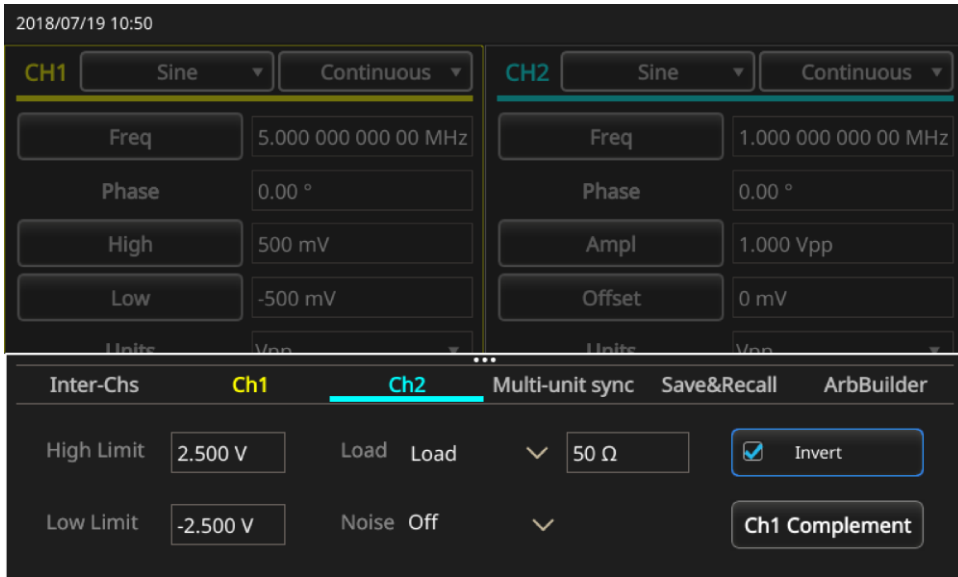

Figure 48: Invert channel 1 and channel 2 wave polarity

Notice that the image at the bottom of CH1 and CH2 shows inverted sine waves. You can accomplish this inversion with all of the waveforms, depending on your requirements.

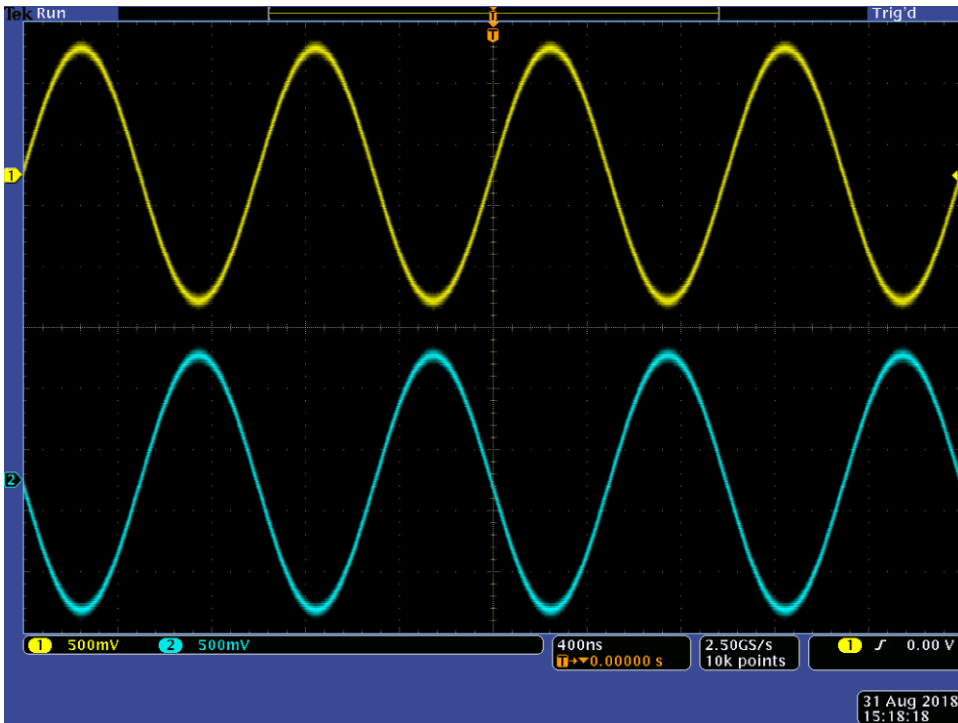

Figure 49: Inverted sine wave

Add noise

To add the internal noise signal to a waveform, use the swipe area on the bottom of the touchscreen.

To add noise:

1. Select **Basic**.
2. Select **Sine wave** on the touchscreen.
3. Select **Continuous** mode on the CH1 drop-down menu on the touchscreen.
4. On the touchscreen, swipe the arrow at the bottom up.
5. On the CH1 tab, select the **On** option for Noise.
6. Select the value next to Noise to adjust the noise level.

The following figure shows a waveform before adding noise.

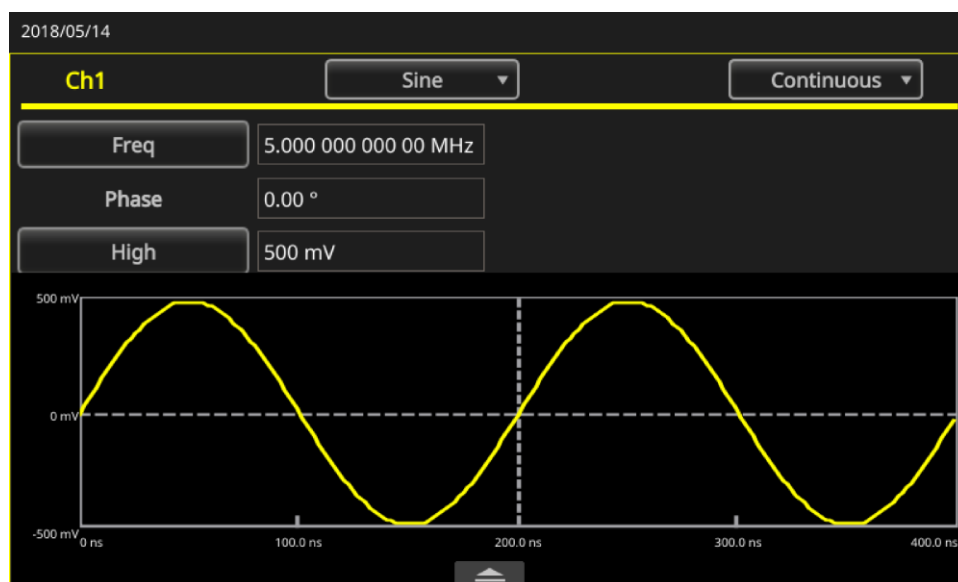

Figure 50: No noise

The following figure shows a waveform after adding noise.

NOTE. To avoid noise overflow, the amplitude of the output signal is automatically halved.

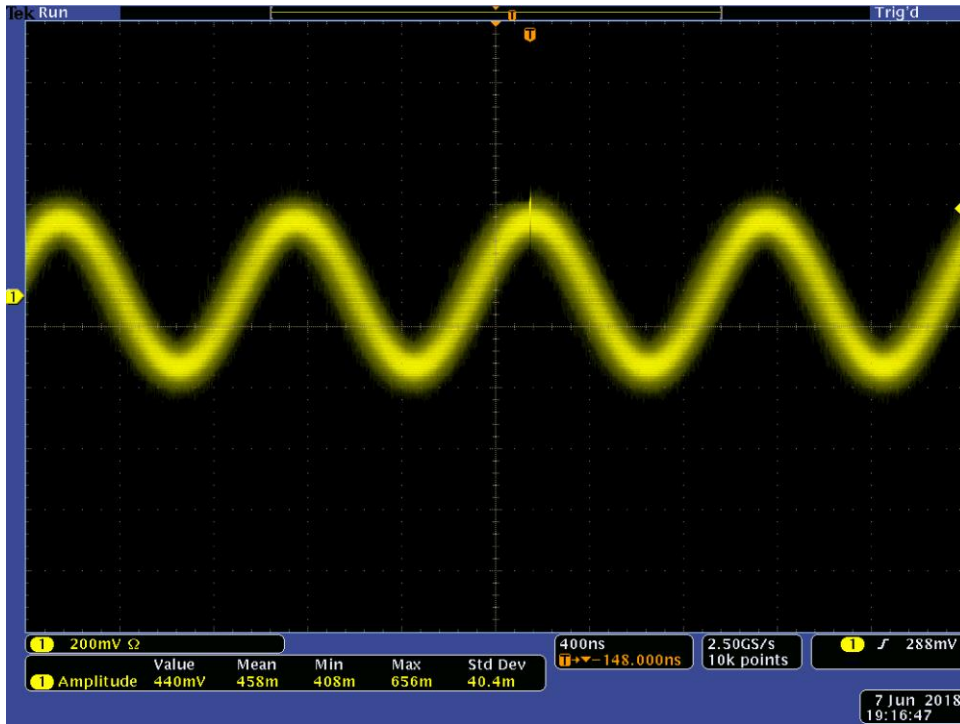

Figure 51: Waveform after noise is added

NOTE. An internal noise generator (digital) is used to add noise. CH1 and CH2 noise signals are non-correlating. The output status is changed from Output Off to Noise when you press the front-panel Channel Output button to enable the output. When the Noise option is set to On, the amplitude of the output signal is reduced to 50%.

Add an external signal

The AFG31000 Series Arbitrary Function Generator instruments have a rear-panel Add In connector that allows you to add an external signal to the CH1 output signal.

To add an external signal:

1. Connect an external signal source to the rear-panel Add In connector.
2. Select **Basic**.
3. On the touchscreen, swipe the arrow at the bottom up.
4. On the CH1 tab, select the **External Add** option.
5. Press the front-panel **CH1 Output** button.

The following figures are examples of external signals before and after noise is added as an external signal. The waveform in the first figure is the external signal. The waveform in the second figure is a square waveform after the external noise was added.

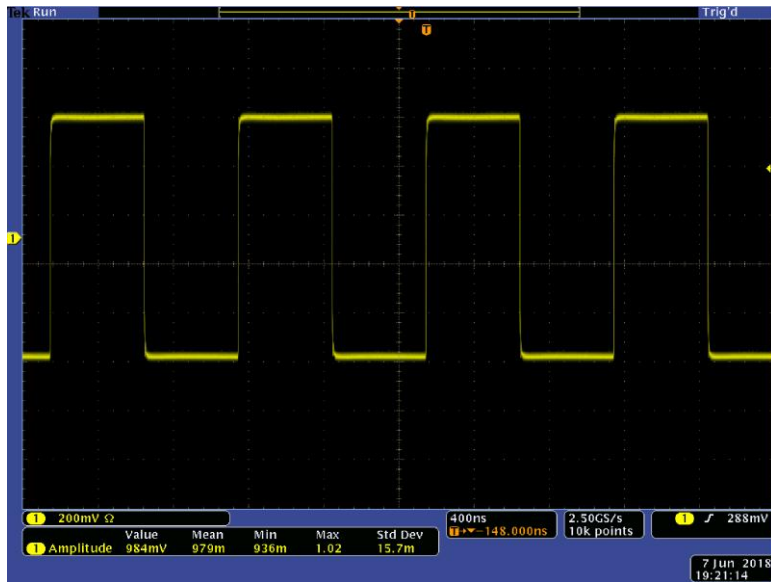

Figure 52: External signal before noise

The following figure shows a square waveform after adding noise.

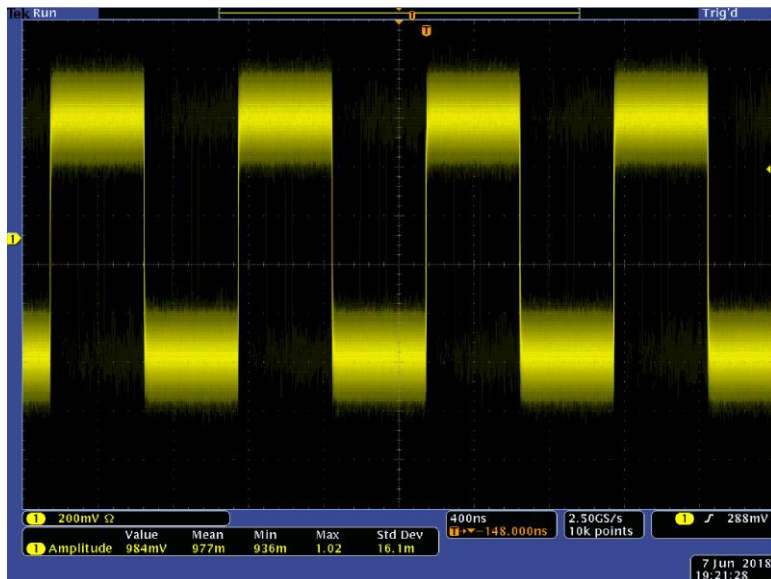

Figure 53: External signal after noise

Create a differential signal

A two-channel instrument can be used to create a differential signal by programming CH2 to output the complement of CH1. The CH2 settings can be configured conveniently using the CH1 Complement function.

To create a differential signal:

1. Select **Basic**.
2. Set your CH1 settings using the touchscreen.
3. Swipe the menu up at the bottom of the touchscreen.

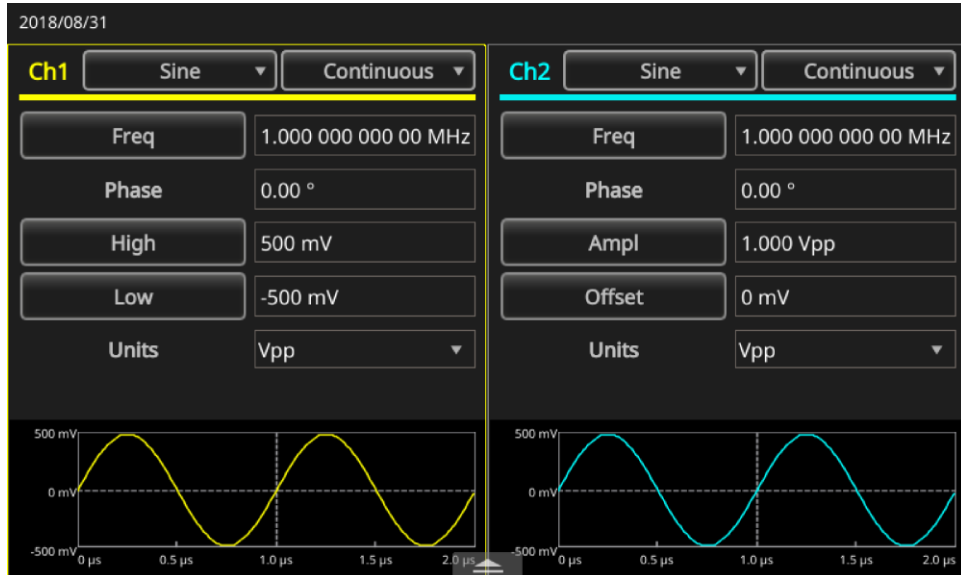

Figure 54: Bottom swipe area

4. Select the **CH2** tab and select the **CH1 Complement** button. The CH2 wave shape and timing settings are copied from CH1, and the CH2 amplitude settings are inverted from CH1.

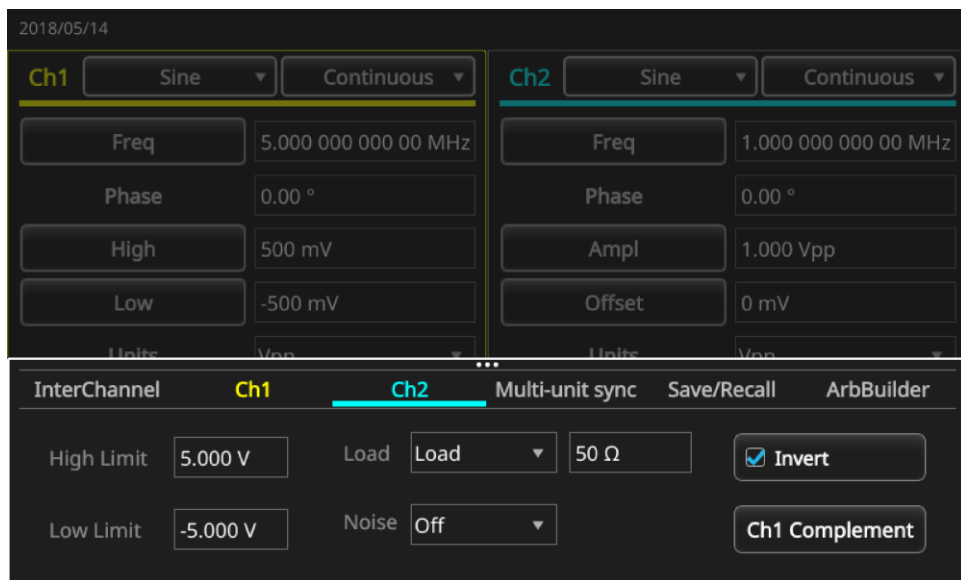

Figure 55: Ch2 tab and CH1 Complement button

External reference clock

The external reference input (EXT REF INPUT) and the external reference output (EXT REF OUTPUT) connectors are on the AFG31000 Series Arbitrary Function Generator rear panel. The instrument can use the internal or external signal as a reference signal.

The external reference input and output connectors are used for synchronizing multiple AFG31000 Series instruments. The instrument can use the internal source or an external source as a reference signal. When the internal reference is activated, a 10 MHz reference signal is output on the rear panel EXT REF OUT connector. This output signal synchronizes other devices to the instrument.

When the external reference input is activated, the rear panel EXT REF INPUT connector is used as the input for an external reference signal. The instrument is synchronized using this external reference signal.

NOTE. The external reference clock must be set to 10 MHz. When external is selected, make sure that you have connected the appropriate cable for the 10 MHz signal. Also, when internal is selected, the internal 10 MHz clock takes effect immediately.

To select a reference signal:

1. Select **Utility**.
2. Select **System**.
3. In the Clock Ref settings, toggle between **Internal** and **External**. If you are using the EXT REF INPUT, make sure your connections are correct.

Synchronize multiple instruments

The AFG31000 Series Arbitrary Function Generator provides the ability to synchronize multiple arbitrary function generators.

In many applications, more than two channels of waveforms are needed to stimulate the DUTs. For example, to simulate the voltage of a 3-phase power line system, three channels are needed. If current on the lines are also needed at the same time, then there will be six channels in total.

The instrument can synchronize multiple instruments to provide this functionality.

NOTE. To synchronize two instruments you must stop running output signals.

To synchronize multiple AFGs:

1. Select **Basic**.
2. Swipe the arrow at the bottom up and select **Multi-unit sync** tab.

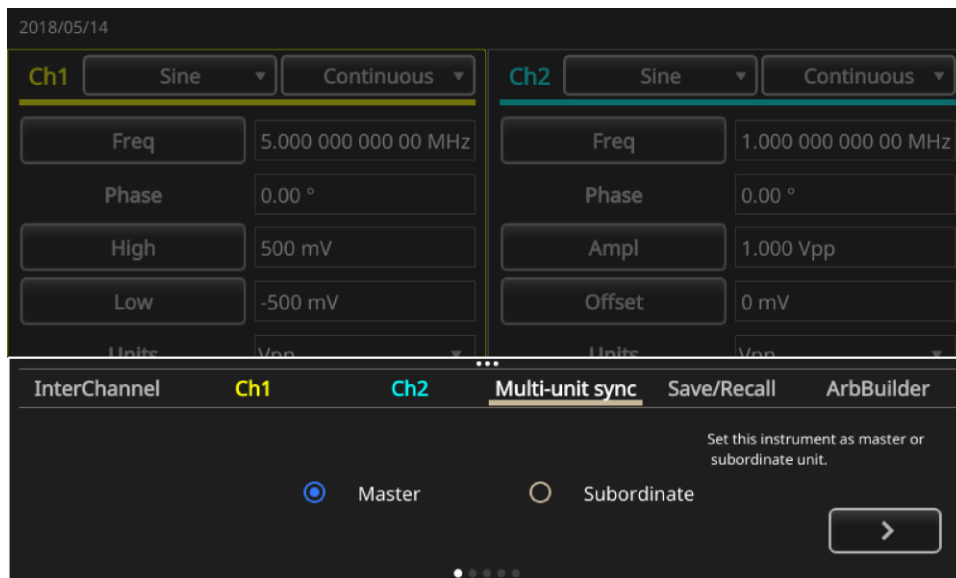

Figure 56: MultiSync instruments tab 1

3. Select **Master** or **Subordinate**.
4. Press the right arrow to go to next page.
5. Connect Trigger Output (master) to Trigger Input (subordinate) with a BNC cable, as seen in the next figure. Press the right arrow to go to the next page.

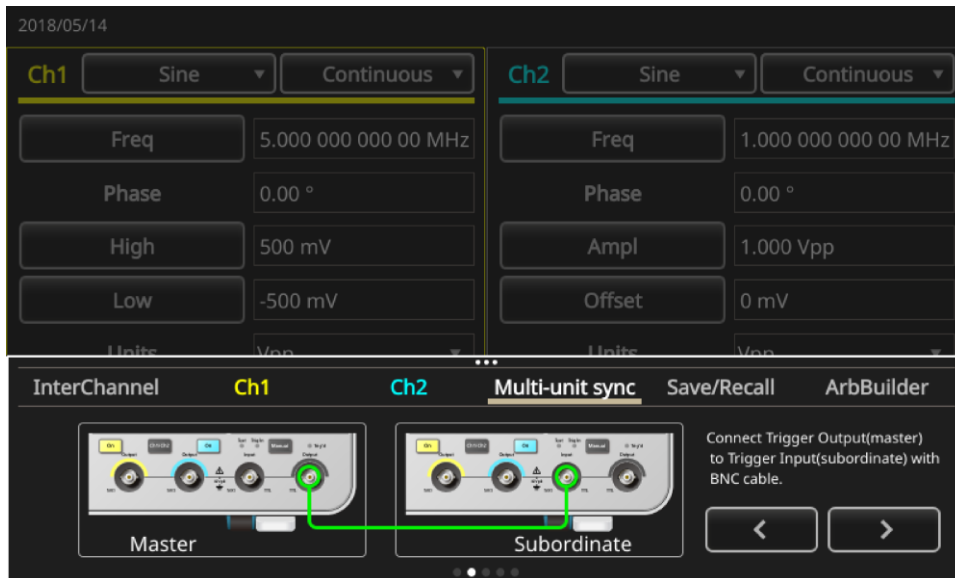

Figure 57: MultiSync instruments tab 2

6. Connect EXT REF OUT (master) and EXT REF IN (subordinate) with a BNC cable according to the following figure.

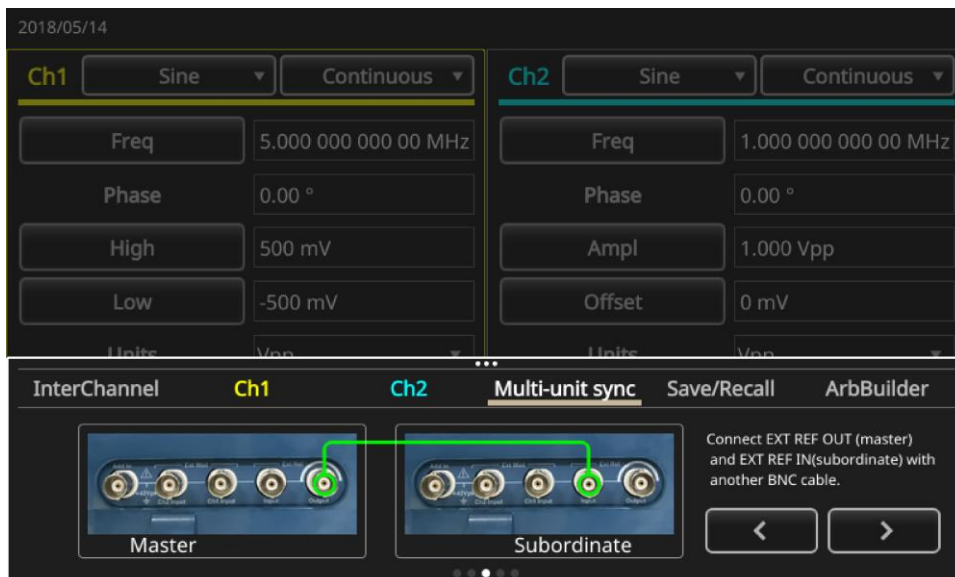

Figure 58: MultiSync Units tab 3

7. Press the right arrow to go to the next page.
8. Set the Trigger delay between master and subordinate.

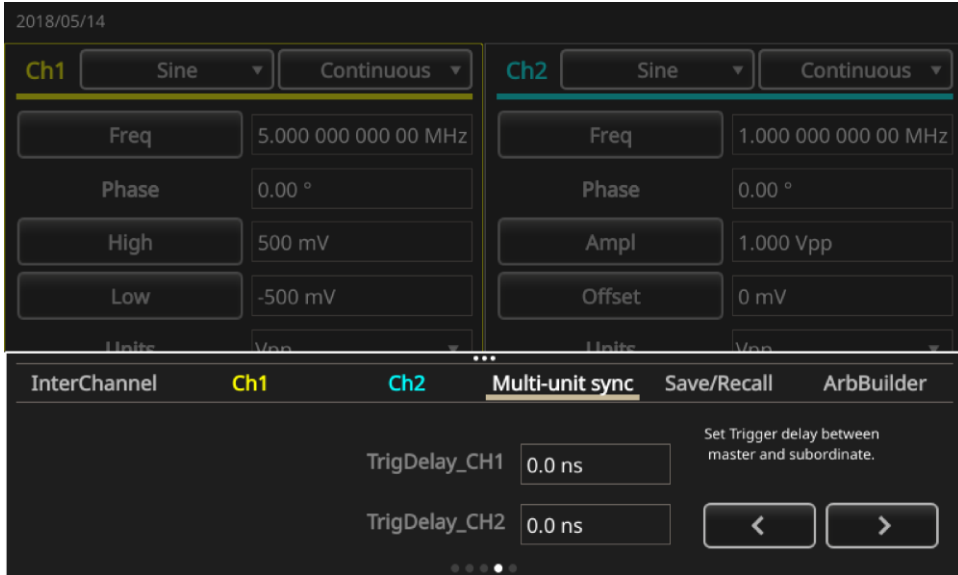

Figure 59: MultiSync instruments tab 4

9. Press the right arrow to go to the next page.
10. Press **Synchronize**.

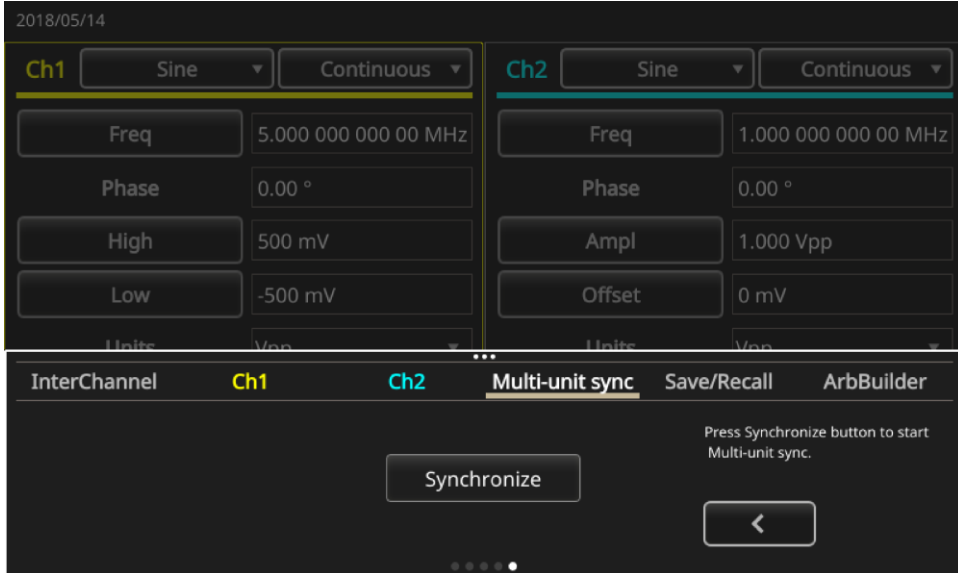

Figure 60: MultiSync instruments tab 5

The following figure shows the master waveform.

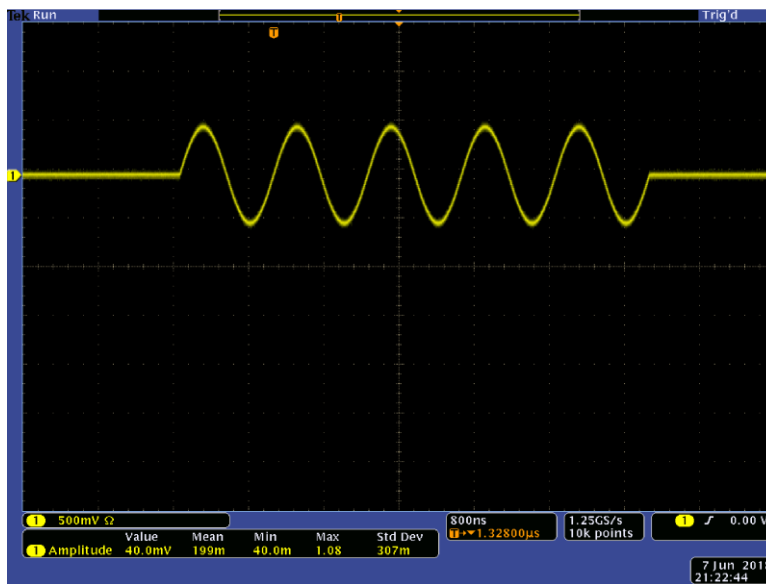

Figure 61: Master instrument waveform

NOTE. If you use cables that are one meter long or longer, the subordinate signal may be delayed as much as 40 ns or longer. We recommend that you set the delay between the master and subordinate to 0 by adjusting the delay of the master unit (see [Using InstaView](#) (on page 59) for more information).

The following figures show waveform outputs before and after they have been synchronized. The top waveform is from the master instrument and the bottom waveform is from the subordinate instrument.

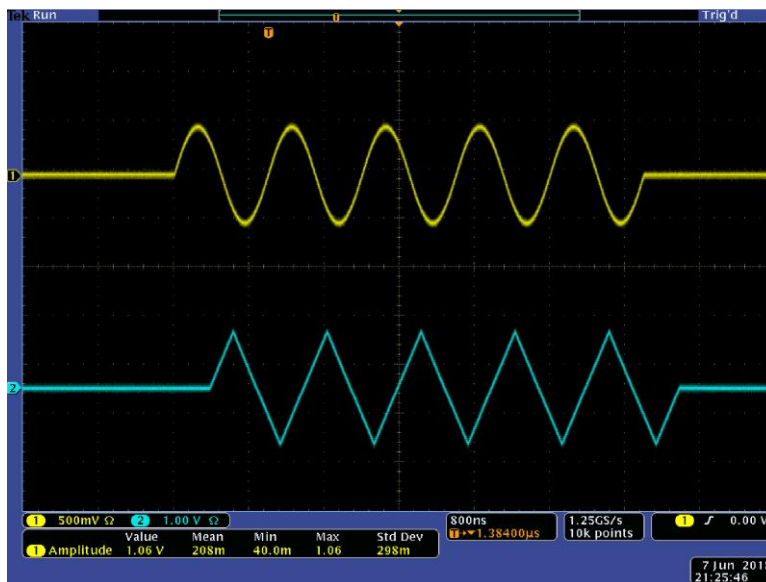

Figure 62: Master and subordinate before sync

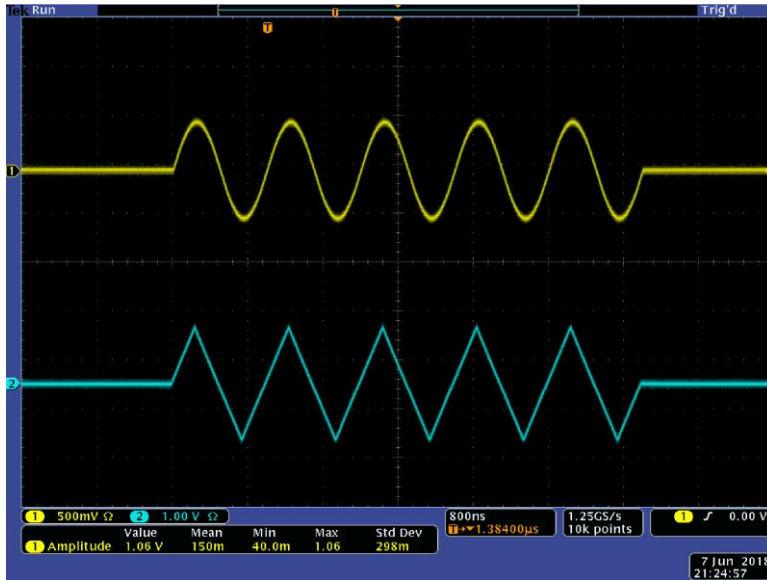

Figure 63: Master and subordinate after sync

NOTE. To output continuous waveforms by synchronous operation, select **Clock Ref External** in the System menu as the trigger source for the master instrument to stop signal generation. In the AFG settings for CH1, under Mode, select **Inf-Cycles** as the burst count for both master and subordinate instruments. If you want to restart the signal generation, change the trigger source of the master instrument to **Internal**.

USB flash drive

A USB port is included on the front panel of the AFG31000 Series Arbitrary Function Generator so that you can perform the following tasks:

- Save or recall user-defined waveforms to and from a USB flash drive
- Save or recall setups to and from files on a USB flash drive
- Update your instrument firmware using a USB flash drive
- Save a screen image to a USB flash drive

NOTE. When you insert a USB flash drive into the instrument, a message appears on the screen. Do not remove the flash drive until the message disappears. If you remove the flash drive while this message is displayed, it may cause damage to the instrument.

For more information about saving or opening waveforms, see [Save or open arbitrary waveforms](#) (on page 30).

For more information about instrument setup, see [Save and recall instrument setup](#) (on page 57).

For more information about updating your instrument, see [Update instrument firmware](#) (on page 95).

Save or recall instrument setup

You can save instrument test settings as files in the internal memory or on an external USB flash drive. You can recall the stored settings from a file in the internal memory or on a USB flash drive.

To save or recall an instrument setup:

1. Select **Basic**.
2. Press the **Save/Recall** button.
3. Go to the **Save & Recall** tab on the touchscreen and select **Save as** or **Recall**.
4. To specify a memory location, select **Memory** or **USB**.
5. Select the file name area to save a file or select a file to open or recall.
6. Select where you want to save the file: **Memory** or **USB**. Use the touchscreen keyboard to enter a file name.
7. To open a file, select one from **Memory** or **USB**.

NOTE. You can save test settings to use for future tests. To avoid an accidental overwrite when your settings are saved, a lock key icon is displayed. To save or open test settings, press the **Save/Recall** button. To delete a file, press the **Delete** button. If you save test settings to a USB flash drive, the file has a `.tfs` extension.

Save a screen image

You can save a screen image of the instrument to a USB flash drive.

To save a screen image:

1. Insert a USB flash drive into the front-panel USB connector.
2. Set the display to show the screen that you want to save; the saved image will be a `.png` image.
3. Simultaneously press and hold the two arrow keys underneath the navigation control on the front panel.
4. Release either arrow key.
5. A message appears on the screen indicating that the image was saved.
6. Select **OK**.

NOTE. Image files are saved in a folder named `TEK` on the USB flash drive. The instrument gives all files created by the instrument the default name `xxx.png`, where the `xxx` is a placeholder for the current date and time.

Tutorials

The following quick tutorials introduce you to using an arbitrary waveform generator (AFG).

Tutorial: How to select a waveform and adjust settings

Use the following steps to select a waveform and adjust waveform settings.

To select a waveform and adjust settings:

1. Connect the power cord.
2. Press the power button on the instrument.
3. Connect a BNC cable from the CH1 output of the arbitrary function generator to an oscilloscope input connector.
4. Select **Basic**.
5. Select a waveform.
6. Press the front-panel **CH1 Output On** button to enable the output.
7. Observe the waveform displayed on the oscilloscope screen.
8. Use the front-panel shortcut buttons on the instrument to select waveform settings.
9. Select **Frequency** as a setting to be changed.
10. Use the keypad to change the frequency value. Press the **Enter** button to complete the entry. You can change the Amplitude, Phase, and Offset value the same way.

You can also change the frequency value using the navigation wheel and the arrow keys. To increase the value, turn the navigation wheel clockwise. To change a specific digit, select it by pressing the arrow keys, then change it by turning the navigation wheel. Set the value by pressing the navigation wheel.

Tutorial: How to create a sine waveform

Use the following the steps to create a continuous sine waveform.

To create a sine waveform:

1. Connect the power cord.
2. Press the power button on the instrument.
3. Connect a BNC cable from the CH1 output of the arbitrary function generator to an oscilloscope input connector.
4. Select **Basic**.
5. Press the front-panel **Sine** button, and then press the **Continuous** button to select a waveform.
6. Press the front-panel **CH1 Output On** button to enable the output.
7. Use the oscilloscope autoscaling function to display the sine waveform on the screen. If the instrument outputs a default sine waveform, you can manually set the oscilloscope as follows:
 - 0.5 $\mu\text{s}/\text{div}$
 - 200 mV/div
8. To change the frequency, press the front-panel **Frequency/Period** shortcut button.
9. The Frequency/Period/Phase Menu is displayed and Freq is selected. You can now change the frequency value.
10. Use the keypad to change the frequency value and press the **Enter** button to complete the entry. You can change the Amplitude, Phase, and Offset value the same way. You can also change the frequency value using the navigation control and the arrow keys. To increase the value, turn the navigation control clockwise. To change a specific digit, select it by pressing the arrow keys, then change it by turning the navigation control.

NOTE. You can use the front-panel shortcut buttons to quickly select a waveform setting. When you specify a waveform setting using the shortcut buttons, the active setting is displayed in green in the graph area.

InstaView overview

InstaView™ technology (real-time waveform monitoring) allows you to see the waveform of the device under test (DUT) in real time, without the need for an oscilloscope and probe. This eliminates the uncertainty caused by unmatched impedance.

To use InstaView:

1. Select **Basic** on the touchscreen.
2. Press the **InstaView** button.

NOTE. The dialog box that opens indicates that there is a cable propagation delay. You can measure the delay using the Auto Measure feature. Also note that every time you change a cable on the instrument, the cable propagation delay must be auto-measured or manually updated.

3. To measure the cable delay between the channel 1 output and trigger input, connect the cable appropriately and select **Auto Measure**. You can measure channel 2 the same way.
 4. Once you have measured the delay, you can turn on InstaView by choosing the channel and selecting **OK**.
-

NOTE. In the InstaView dialog box, you have an option to add Manual Input for the cable propagation delay. Use the Delay input box to indicate the cable delay. This should only be used when you know the amount of time of the delay, otherwise your measurements will not be accurate when using this feature.

Using InstaView

Most waveform generators insert a 50 Ω serial resistor on the output signal path (which requires the output to be connected to a 50 Ω load through a cable with 50 Ω characteristic impedance) to ensure maximum power transmission and minimize the reflection of high-speed signals. This is called impedance matching and the nominal settings shown on the generators are based on the assumption that all stages in the signal path are a perfect 50 Ω .

Many users, however, use devices under test (DUTs) that are not 50 Ω terminated. This impedance mismatch causes the waveform at the DUT to be different from the nominal settings on the generator. For example, if you set a 3.3 V square waveform as a clock to trigger on a TTL circuit, you may get a 6.6 V square waveform at the device end, because a TTL circuit typically has an input impedance of several k Ω . Additionally, if there is parasitic capacitance or inductance, it will lead to distortion of the waveform; it is not a square waveform anymore. The challenge is the screen still shows a 3.3 V square waveform.

With the patented InstaView™ technology, the instrument can measure and show the waveform at the DUT, instead of just the nominal waveform. The displayed waveform changes in real time with settings changes to frequency, amplitude, waveform shape, or impedance changes at the device under test.

Equipment list

- One AFG31000 Series Arbitrary Function Generator
- One oscilloscope (with 50 Ω and 1 M Ω switchable input impedance)
- One BNC to BNC cable
- One BNC T connector (JKJ)
- One demo board

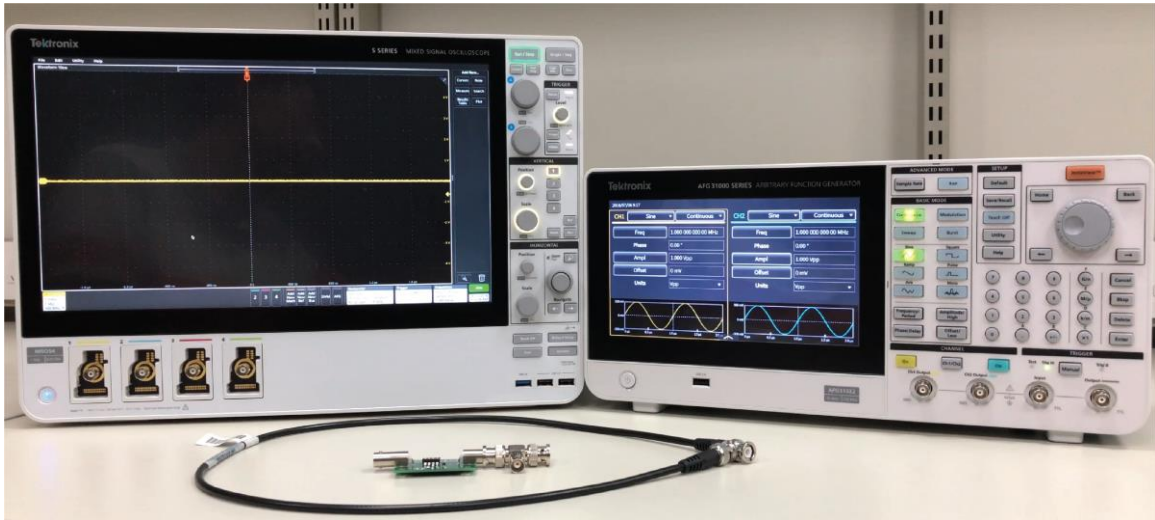

Figure 64: Equipment for InstaView tutorial

Set up AFG31000

1. Select the **Default** button on the front panel and select the **Square** button to switch the output of CH1 from sine to square.
2. Connect the BNC cable between the AFG31000 CH1 output and the oscilloscope CH1 input.
3. Press the **CH1** on button on the AFG31000 to turn on the output.

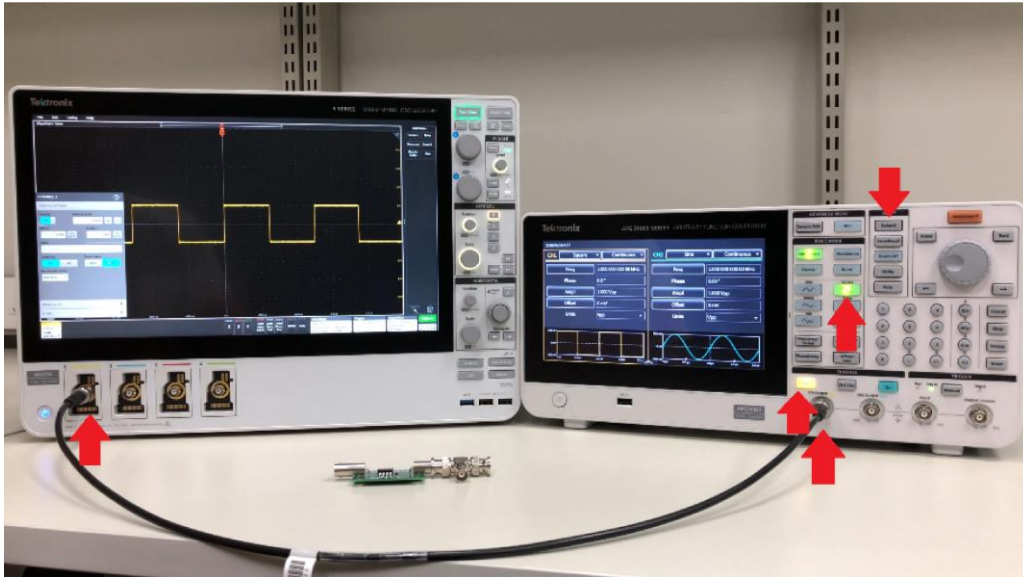

Figure 65: AFG31000 InstaView setup with connections overview

4. Turn on CH1 on the scope and adjust horizontal, vertical, and trigger level settings to see the waveform on the screen.
5. Toggle the scope CH1 input impedance between 50 Ω and 1 M Ω to see the changes of the amplitude.

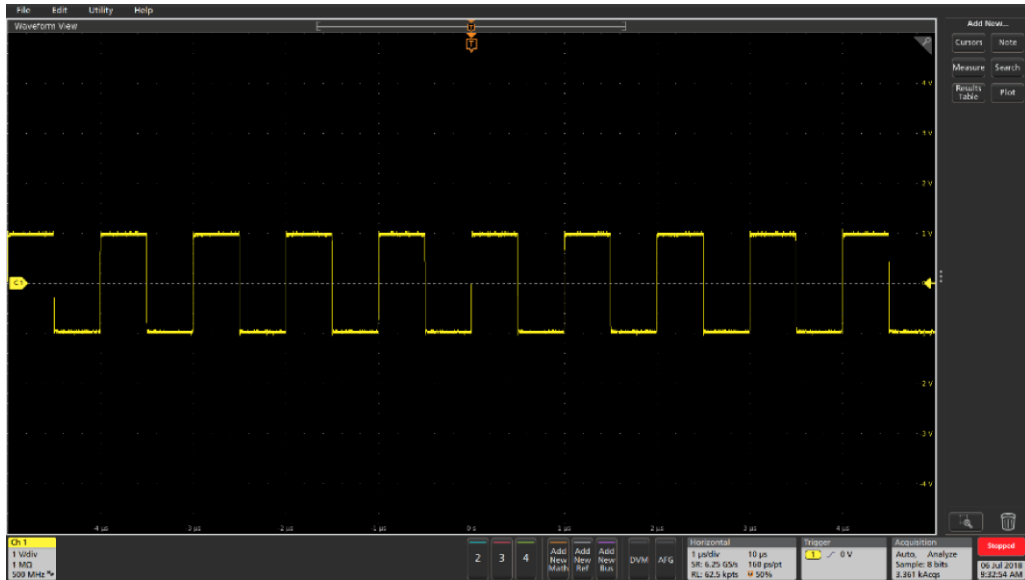

Figure 66: Scope 1 M Ω

6. Disconnect the BNC cable from the scope, and connect the T connector between the demo board, scope CH1 input, and the BNC connector.
7. Make sure the switch on the demo board is set to LCR (complex impedance including resistive, capacitive, and inductive load)
8. Adjust the oscilloscope to observe the waveform.

NOTE. You can see how the input impedance of the DUT impacts the waveform in terms of amplitude (pure resistive load) and shape (capacitive-inductive load), but the waveform shape shown on the instrument is still a perfect square.

Set up InstaView on the AFG31000

1. Press the InstaView™ button on the front panel to open the settings window.

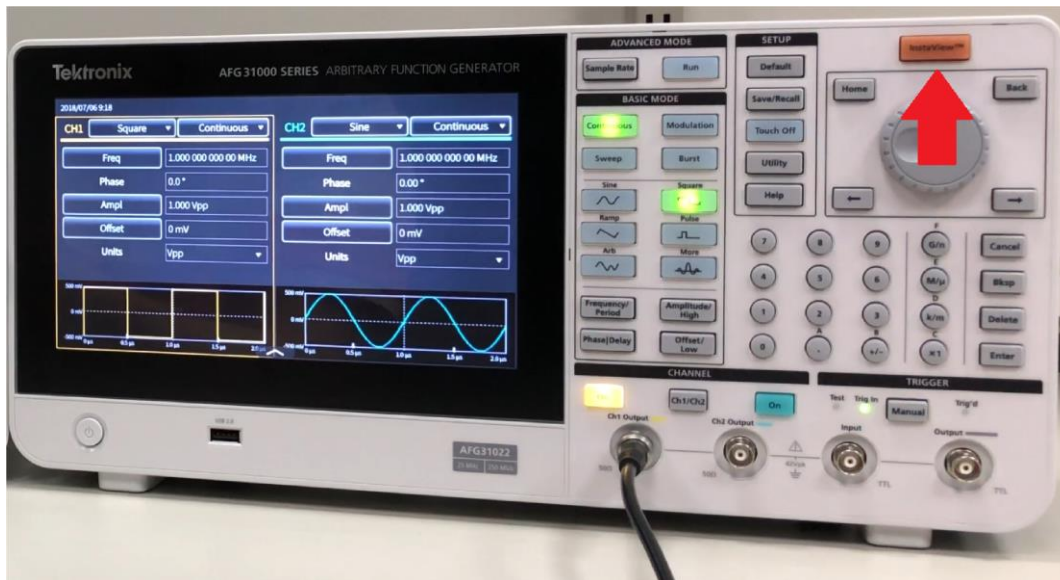

Figure 67: Set up InstaView on the AFG31000 instrument

2. Select **CH1** and then **Run** to automatically measure the cable propagation delay. See the following figure.

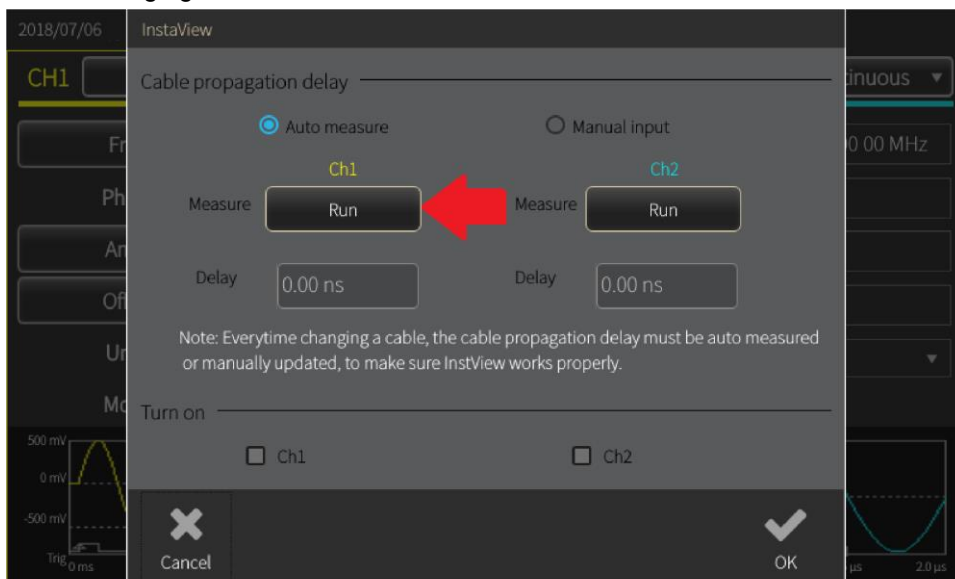

Figure 68: Select channel one

3. Connect the BNC cable between CH1 output and Trigger In, then select **OK**.

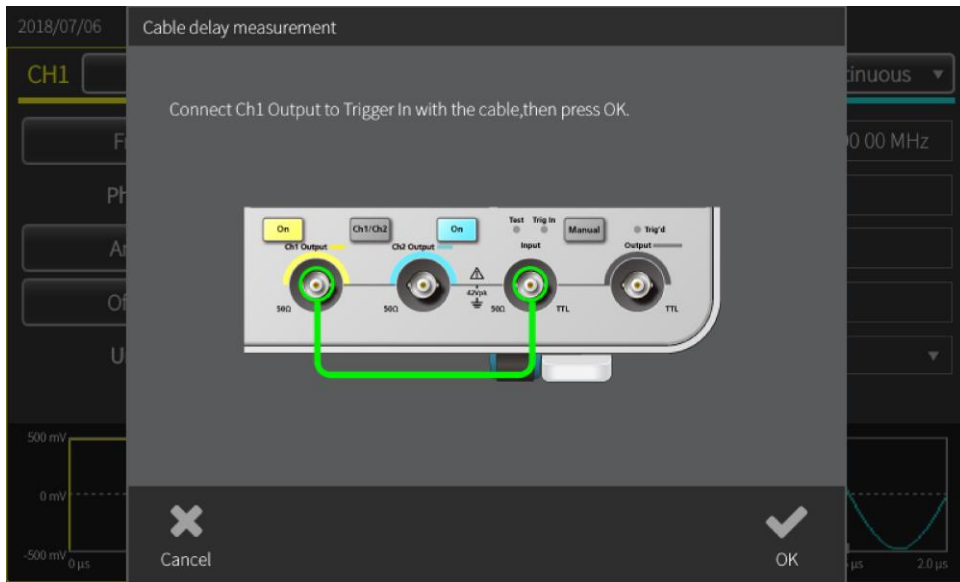

Figure 69: BNC trigger connect - InstaView

- When the measurement is done, the delay is reflected in the dialog box. The propagation delay shows you when the reflection is going to reach the AFG output port. In case of impedance mismatching, the instrument algorithm can separate the incident from the reflection.

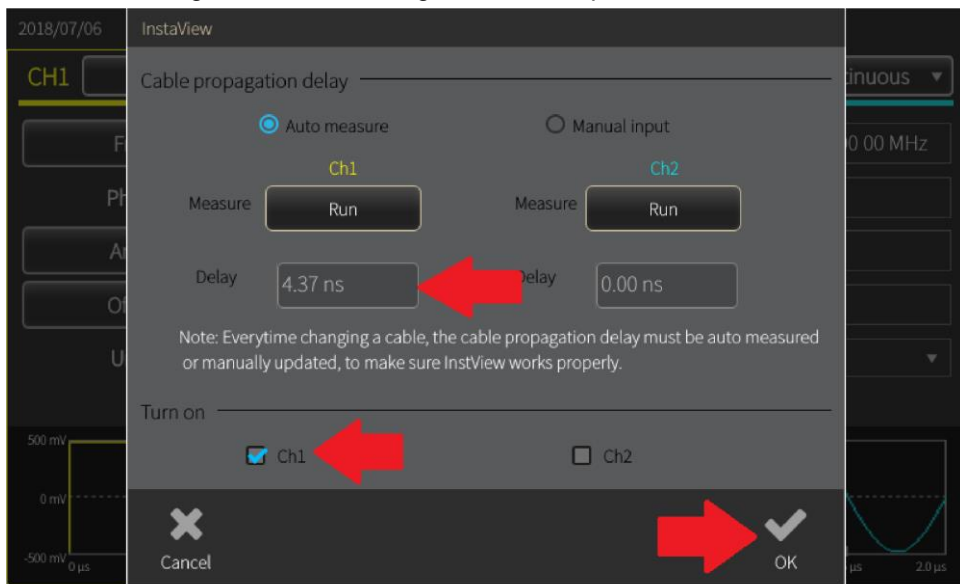

Figure 70: Delay dialog

- Select **CH1** and select **OK** to close the window.
- Connect the BNC cable directly to the oscilloscope CH1 input again.
- Swipe the waveform preview window on the AFG31000 to enlarge it.
- Repeat steps 4 through 8 and observe how the waveform shown on the instrument changes with the load, and the similarity to the captured waveforms. You can see how the waveform shown on the instrument changes along with impedance of the DUT.



Figure 71: CH1 oscilloscope 1 MΩ - InstaView

Change settings

To change the waveform settings:

Change the amplitude and frequency, either independently or together of CH1 to observe how the InstaView waveform changes in real time, and compare it with the oscilloscope-captured waveforms.



Figure 72: Frequency 5 MHz - InstaView



Figure 73: Frequency 5 MHz - scope



Figure 74: Amplitude 2 VPP - Scope InstaView

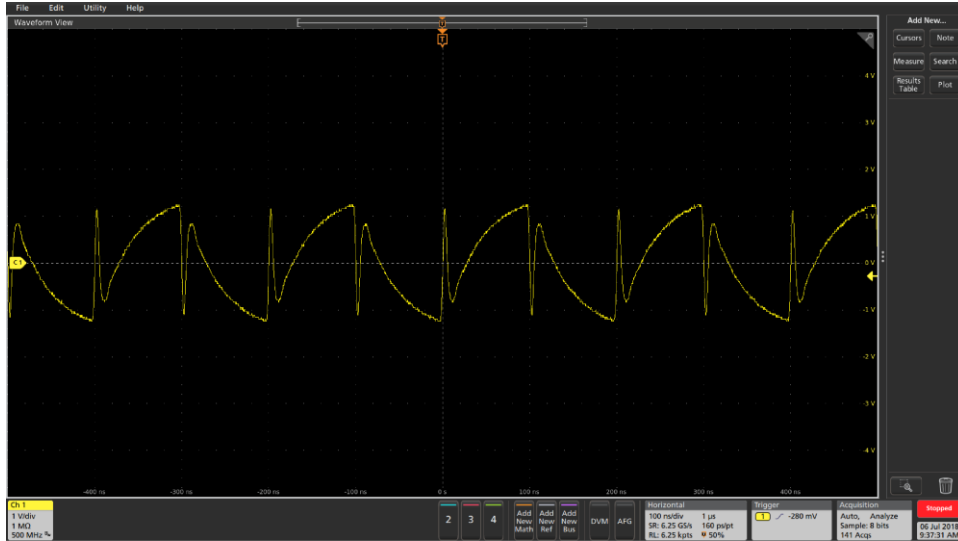

Figure 75: Amplitude 2 Vpp - InstaView

Advanced mode

Advanced mode lets you to generate long waveforms or waveforms with complex timing. One example of this is generating pulse trains or data packets over a serial bus.

You can control how the waveforms in the sequencer are organized, including repeat, wait, jump, go to, or triggering with events including external trigger in, manual trigger, timer, and SCPI commands.

In Advanced mode, every point in an arbitrary waveform is output once each cycle, at the pace of the specified sampling rate, with no skips or repetition. Use advanced mode if your application is sensitive to jitter and phase noise, like serial bus simulation or I/Q modulation, or if you want to simulate narrow anomalies in long waveforms. The details in the waveform are maintained, jitter and phase noise performance is improved, and the number of samples in each cycle are consistent.



Figure 76: Advanced mode default screen

Advanced output modes

Advanced mode has the following output modes:

- **Sequence:** Open a saved waveform sequence by selecting **Sequence**. Provides more flexibility when generating waveforms with complex timing. You can define complex timing with up to 256 steps or a total waveform length of 16 MB per channel (or 128 MB as an option). These steps can be organized in terms of a loop, a go to, or triggered by either jump or wait events.
- **Continuous:** The instrument outputs a one-step waveform sequence repeatedly when running.
- **Triggered:** One cycle of waveform is output when the instrument receives a trigger input. After one cycle, it goes back to its initial state, waiting for another trigger input.
- **Gated:** The instrument outputs a one-step waveform sequence when an effective gate signal is received and stops when another effective gate signal is triggered.

The Advanced mode outputs the waveform according to the sequence table, including loop and conditional jump. The waveform is output as defined by the sequence selected. Multiple waveforms can be output in any order specified.

The advanced output mode screen allows you to:

- Choose from available waveforms.
- Open a saved waveform sequence by selecting **Sequence**.
- Create and save a new waveform.

Advanced sequence list

The advanced sequence list screen allows you to:

- **Open:** Opens an existing waveform sequence.
- **New:** Initiates a new single sequence. If the previous sequence has not been closed, a dialog box will ask you if the previous setting should be saved.
- **Save:** Save a waveform.
- **Save As:** You can save a waveform to a new file name.

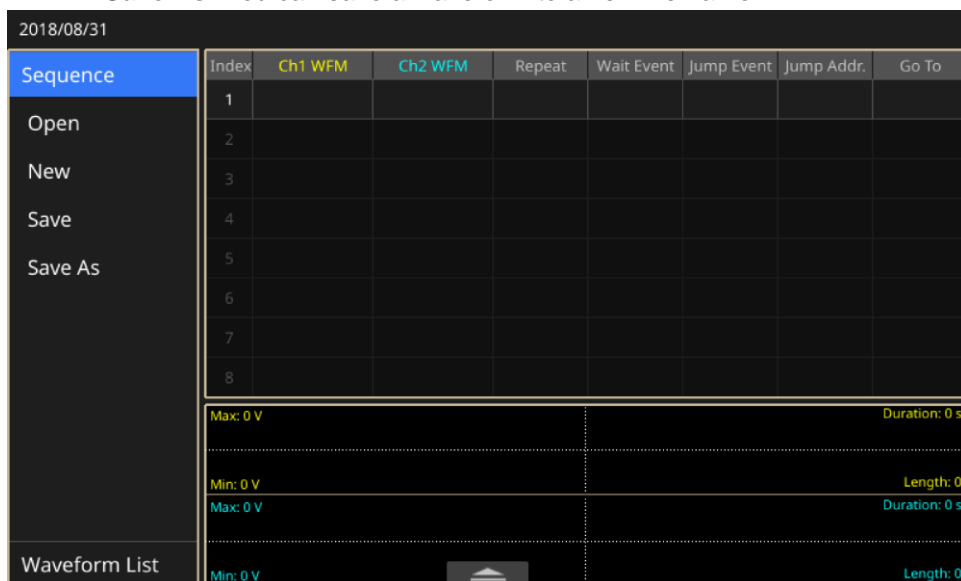

Figure 77: One-channel sequence screen

Advance waveform list

Advanced waveform list

- **Open:** Opens an existing waveform.
- **Memory:** Locates the waveform in the instrument memory.
- **USB:** Locates the waveform on an external USB drive.
- **Predefined:** Locates the waveform in a predefined memory location.
- **Delete:** Deletes one or more existing waveforms from the waveform list.

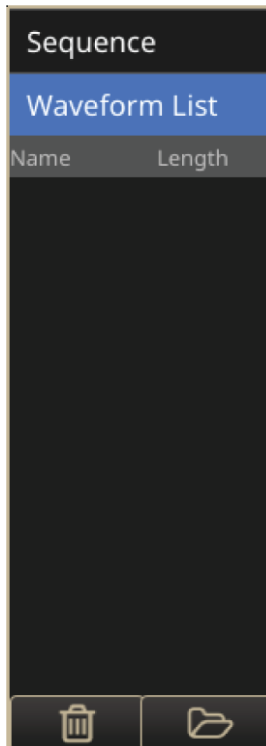

Figure 78: Waveform list

Advanced setting bar

Advanced setting bar

- **Sequence:** Outputs a sequence of waveforms, based on a definition in the sequence table.
- **Continuous:** The instrument outputs a single waveform repeatedly when running.
- **Triggered:** One cycle of waveform is output when the instrument receives a trigger input. After once cycle, the instrument goes back to its initial state, and waits for another trigger input.
- **Gated:** The instrument outputs a single-waveform sequence when an gate signal is received and stops when a second gate signal is received.

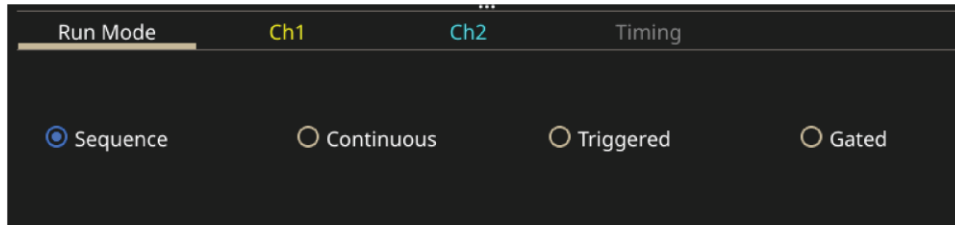

Figure 79: Settings bar

Setting bar, CH1/CH2

- **Scale:** Scale is the amplitude scaling based on offset in a sequence of waveforms on one channel.
- **Offset:** Offset is the average of the maximum and minimum voltage in a sequence of waveforms on a single channel after waveforms are dragged into sequence table. You can change the offset to adjust the average position.

NOTE: Advanced mode supports waveforms with amplitude and offset info. When waveforms are loaded into the table, CH1/CH2 offset may have an initial value. The scale value is calculated based on the offset settings.

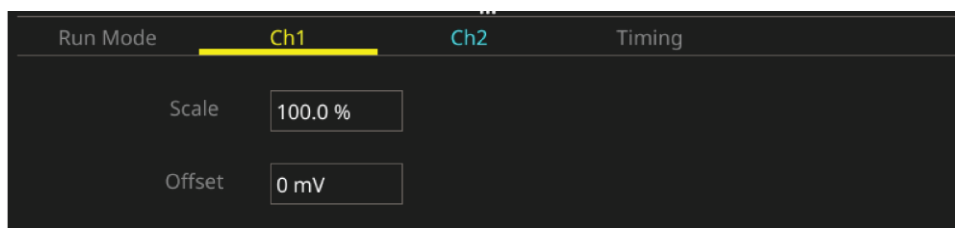

Figure 80: Channel scale and offset

Setting bar, timing

- **Sampling Rate:** Set the sampling rate.
- **Timer:** Set the timing for the signal generating function.

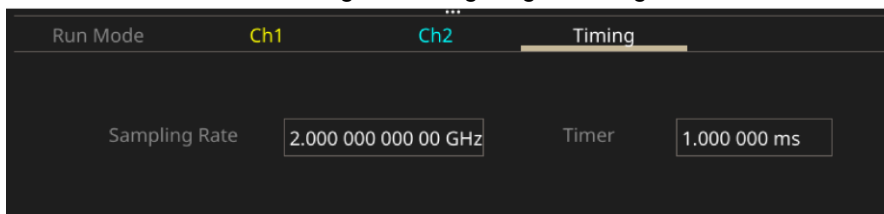

Figure 81: Timing

Setting bar, advanced table

- **Repeat:** Repeats the signal-generation function until a stop instruction.
- **Wait Event:** An event that must occur before the waveform is generated.
- **Jump Event:** Triggers the instrument to go to a different step.
- **Jump Addr:** Sets the jump destination for a jump event.
- **Go to:** Moves to a specific step in the sequence after generating the waveform specified in a sequence element.

Index	Ch1 WFM	Ch2 WFM	Repeat	Wait Event	Jump Event	Jump Addr.	Go To
1	EMPTY	EMPTY	1	OFF	OFF	Next	Next
2							
3							
4							
5							
6							
7							
8							

Figure 82: Sequence table

Sequence table

Sequence table

Sequence mode has the following options:

- **Event selection (for Wait/Jump):** Off or Timer, External trigger, SCPI command, Manual.
- **Wait:** If Wait is On, the waveform output is held until a Wait event happens, then the waveform output starts.
- **Repeat:** Defines how many times the waveform in the entry is repeated, (1 to 1,000,000, or infinite cycles).
- **Jump:** If Jump is On, the current waveform output is interrupted when a Jump event happens and the sequencer jumps to the Jump address immediately.
- **Goto:** Once the current waveform repetition is complete (without being interrupted), the sequencer goes to the Goto address. By default, the address is Next (current entry address + 1).

Index	Ch1 WFM	Ch2 WFM	Repeat	Wait Event	Jump Event	Jump Addr.	Go To
1	EMPTY	EMPTY	1	OFF	OFF	Next	Next
2							
3							
4							
5							
6							
7							
8							

Figure 83: Sequence table

Sequence mode

Sequence mode has the following options:

- **Event selection (for Wait/Jump):** Off or Timer, External trigger, SCPI command, Manual.
- **Wait:** If Wait is On, the waveform output is held until a Wait event happens, then the waveform output starts.
- **Repeat:** Defines how many times the waveform in the entry is repeated, (1 to 1,000,000, or infinite cycles).
- **Jump:** If Jump is On, the current waveform output is interrupted when a Jump event happens and the sequencer jumps to the Jump address immediately.
- **Goto:** Once the current waveform repetition is complete (without being interrupted), the sequencer goes to the Goto address. By default, the address is Next (current entry address + 1).

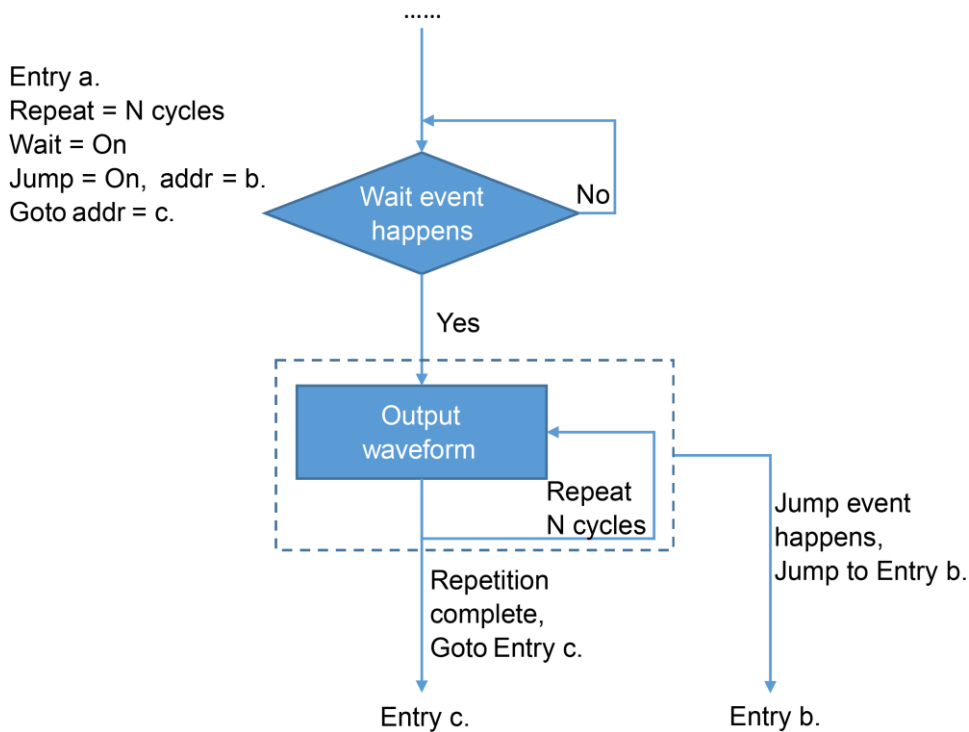

Figure 84: Sequence mode

Continuous mode

There is only one entry (address = 1) in continuous mode; the waveform in the entry is output for infinite cycles. Wait, Jump, and Goto are disabled in this mode.

Entry 1.
 Repeat = Infinite cycles
 Wait disabled
 Jump = disabled
 Gotoaddr = 1.

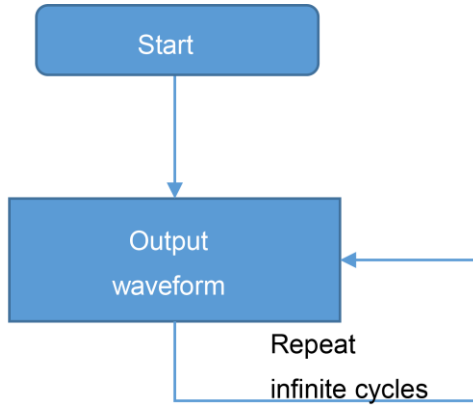

Figure 85: Continuous mode

Triggered mode

There is only one entry (address = 1) in triggered mode. The output is held until the wait event is triggered, then the waveform is output once (1 cycle). Then the instrument returns to the starting point of the sequence, and waits for the next trigger event. Jump is disabled in this mode

Entry 1.
 Repeat = 1 cycle
 Wait = On
 Jump = disabled
 Gotoaddr = 1

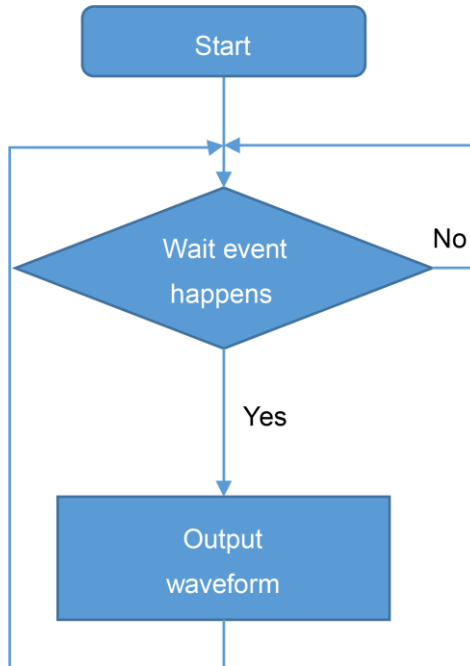

Figure 86: Triggered mode

Gated mode

There is only one entry in gated mode. The output is held until the wait event occurs (gate opened), and stops when the jump event occurs (gate closed). The sequencer will go back to the starting point of the sequence and wait for the next wait event. Goto is disabled in this mode.

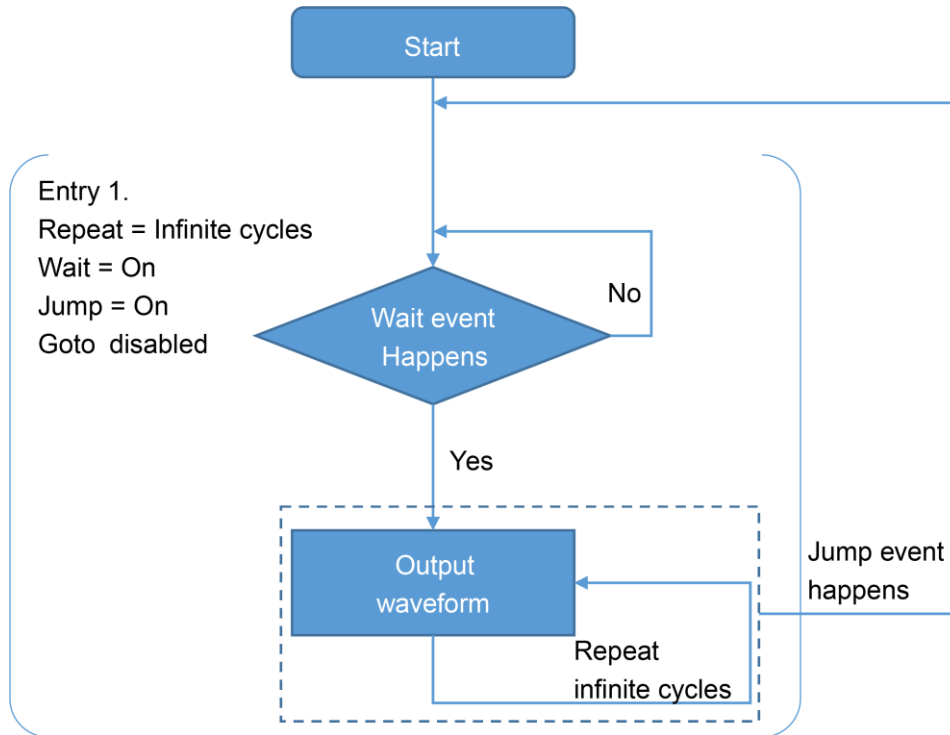

Figure 87: Gated mode

Advanced Thumbnail

This is a small version of the waveform screen.

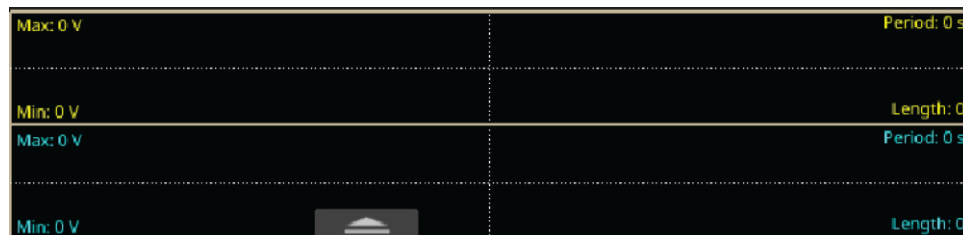

Figure 88: Thumbnail

Tutorial: How to use advanced mode

This example will show you how to use the AFG31000 Series Arbitrary Function Generator to generate long waveforms or waveforms with complex timing. Generating pulse trains or data packets in a serial bus are an example of this type of application.

Advanced mode provides 16MB per channel, with an optional expansion to 128MB, and supports 256 sequencing entries. You control the waveforms in the instrument by branching using repeat, wait, jump, go to, or by triggering with events using external trigger in, manual trigger, timer, and SCPI commands.

This application example shows how to compile a simple sequence with three entries, and how to change how they are displayed on the instrument.

Equipment list

- One AFG31000 Series Arbitrary Function Generator
- One 4-channel Oscilloscope
- Three BNC to BNC cables

Making advanced mode connections

1. Connect CH1 output, CH2 output, and trigger out on the instrument to CH1, CH2, and CH3 on the oscilloscope.
2. Set the trigger source of the oscilloscope to CH3.

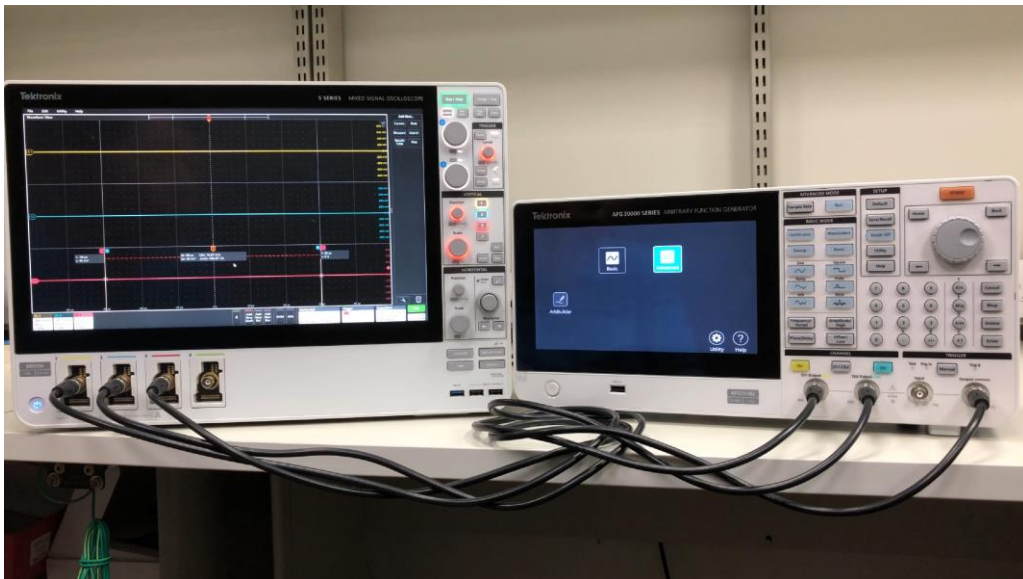

Figure 89: Equipment setup

Using advanced mode

NOTE. If you are not seeing the Home page, press the **Home** button on the front panel.

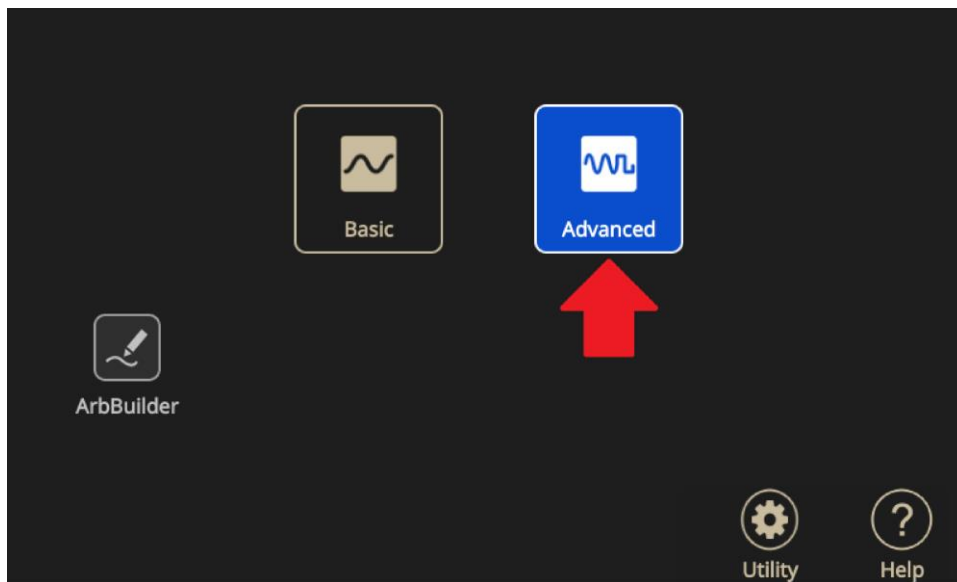

Figure 90: Advanced icon on the Home screen

1. Swipe up from the bottom of the screen to show the setting bar and select **Sequence**.
2. Select **Open** (the file icon) from the Waveform list to add waveforms.



Figure 91: Empty Waveform list

3. Select **Predefined** to view the built-in waveforms. Select them all, then click the **OK** button to add them to the waveform list. The waveforms will be added to the waveform list.

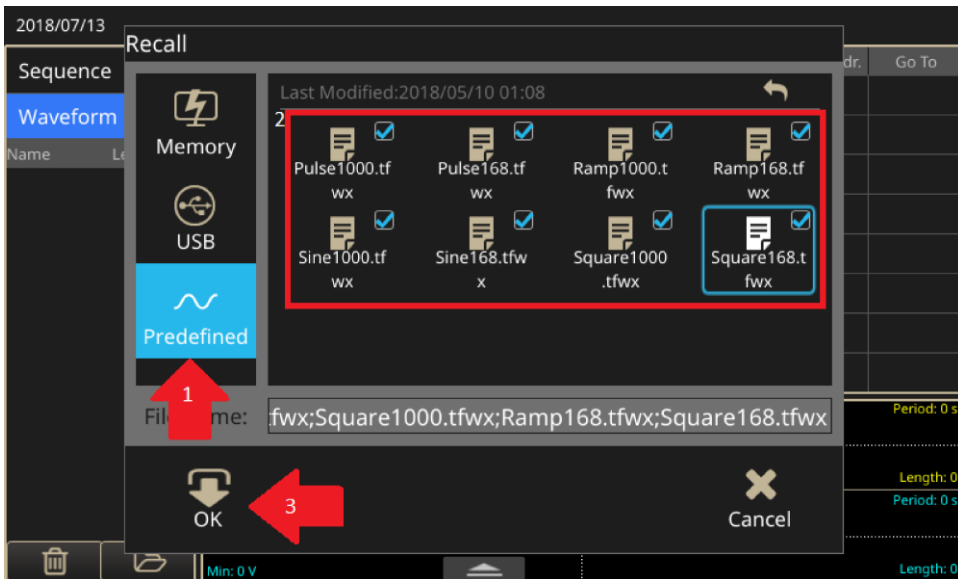

Figure 92: Predefined button



Figure 93: Select from the Waveform List

4. You can drag and drop waveforms from the list to the sequence entries.



Figure 94: Drag and drop waveforms

NOTE. You can add any waveform into the sequence, but the CH1 and CH2 waveforms must be the same length.

5. Click the **Go To** field of the last entry and change it from Next to 1. This lets the sequence return to the first entry when all the waveforms have run and repeats the process infinitely.

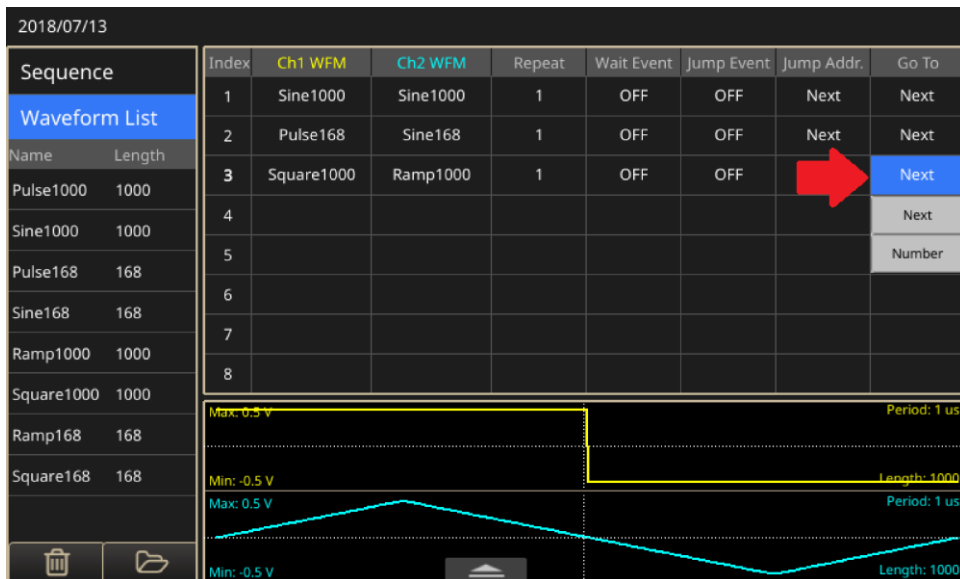

Figure 95: Go To field, change to 1

- Change the repeat times of entry two and three to any number you prefer. Do not set the repeat times to infinite or they will repeat endlessly. Leave the repeat number of entry one as one. In the next step you will set a marker for this entry that triggers the scope.

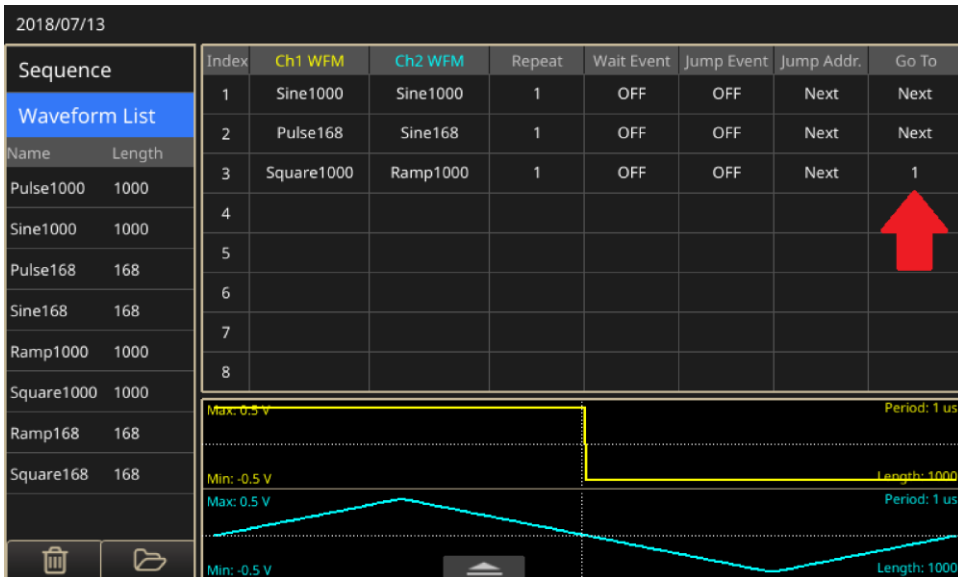

Figure 96: Change to results

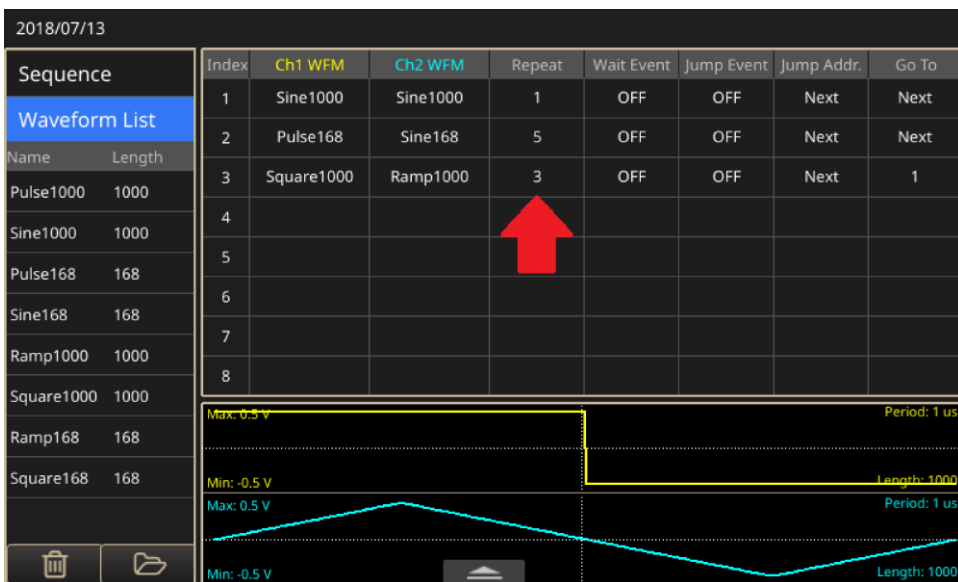

Figure 97: Set repeat function

7. Swipe entry one from left to right to reveal the selection box, then select the box. This generates a 50% duty cycle pulse from the trigger out port on the instrument when that waveform is run.

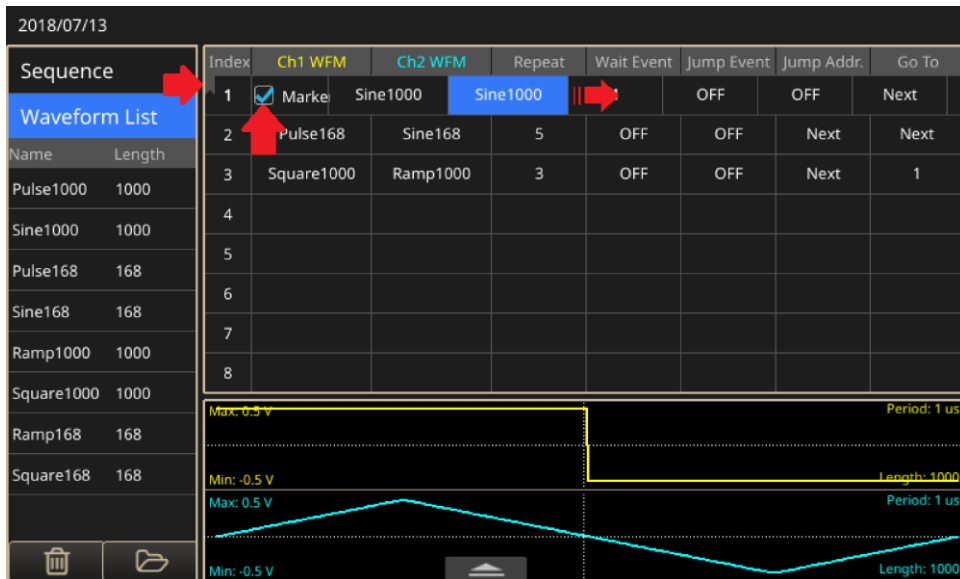

Figure 98: Swipe left-to-right to select the box

8. Select the **On** buttons on the front panel to turn CH1 and CH2 output on, then select **Run** to start the sequence.
9. Adjust the scope to observe the output waveforms on CH1 and CH2. CH3 is the trigger source.
10. Swipe up from the bottom of the screen to reveal the setting bar, choose the CH1 tab and change the scale to 50%. This changes the output amplitude of CH1 to 50% of the original setting.
11. Select the **Timing** tab and change the sampling rate from 1 GHz to 500 MHz. This changes the output frequency to half of the original setting.
12. Select the **Run** button twice on the front panel to stop and rerun the sequence. The sequence needs to be run again for the change in settings to take effect.
13. The oscilloscope shows the change on CH1 in frequency and the amplitude.

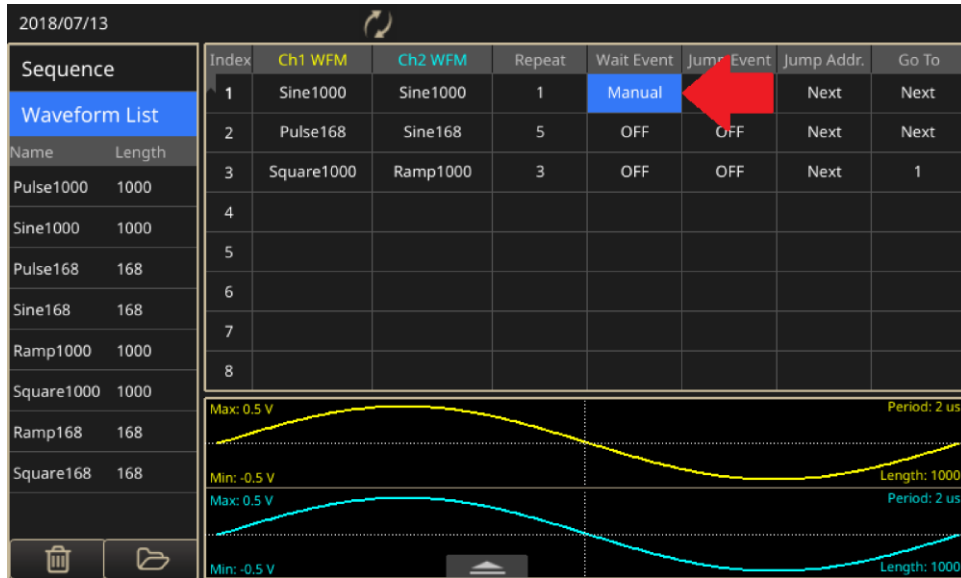

Figure 99: Manual trigger

14. Select the **Wait Event** field of the entry on index 1 and select **Manual** from the menu of triggering events.
15. Select the **Run** button twice on the front panel to stop and restart running. Observe on the scope there is no waveform being shown until you select single trigger mode.
16. Select the manual trigger button on the front panel. The whole sequence will be output once and will wait for the next trigger.

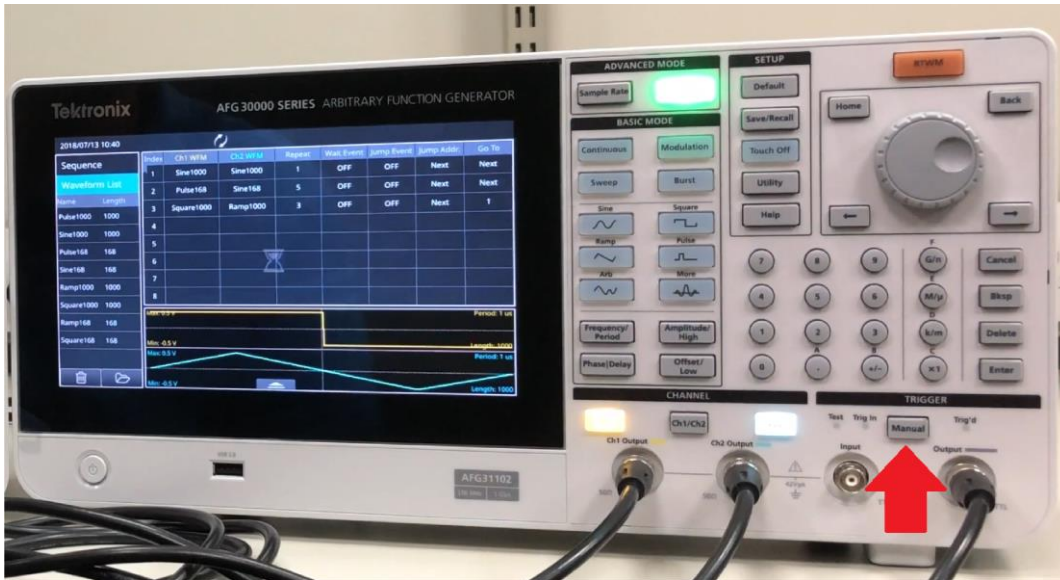

Figure 100: Manual trigger button

17. Single-triggered waveforms are displayed on the oscilloscope.

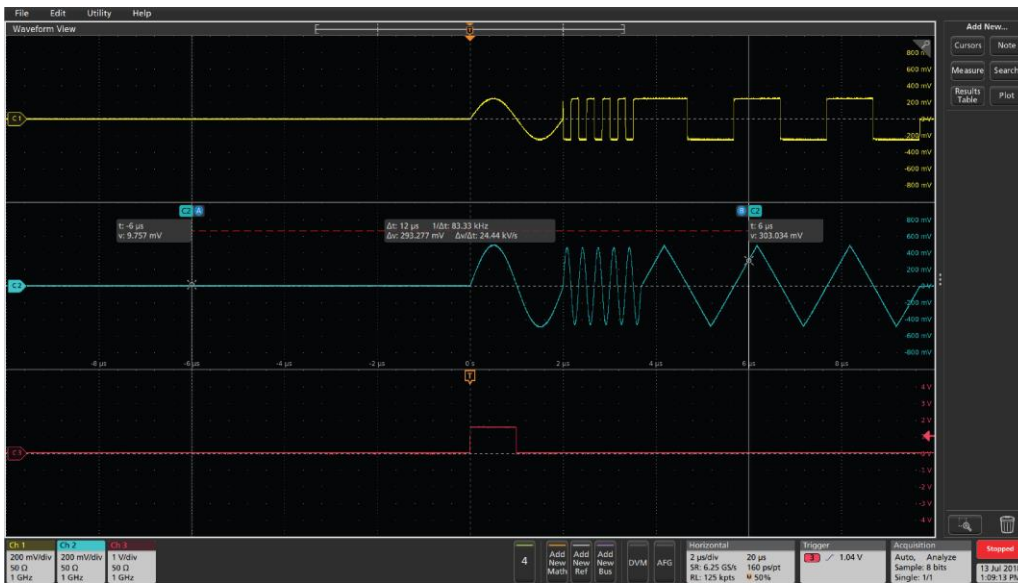

Figure 101: Single triggered waveforms

Utility menu options

Select front-panel **Utility** to see the Utility menu on the instrument touchscreen. The Utility menu provides access to the following options:

- **System:** Settings for Language, Soft Keyboard, Trigger Out, Clock Reference, Power On, Screen Saver, Click Tone, Beeper, Factory Default, and Time Zone.
- **Diagnostics/Calibration:** Settings for Diagnostics, Calibration, Warm Up Timer, and Refresh Relay.
- **I/O Interface:** Settings for Configuration, GPIB Address, DHCP, Default Gateway, Subnet Mask, and IP Address.
- **Security Menu:** Allows you to set Access Protection and Password Management.
- **Firmware:** Allows you to update the firmware if there is an update available.
- **License:** Allows you to update the license for increased memory and capability.

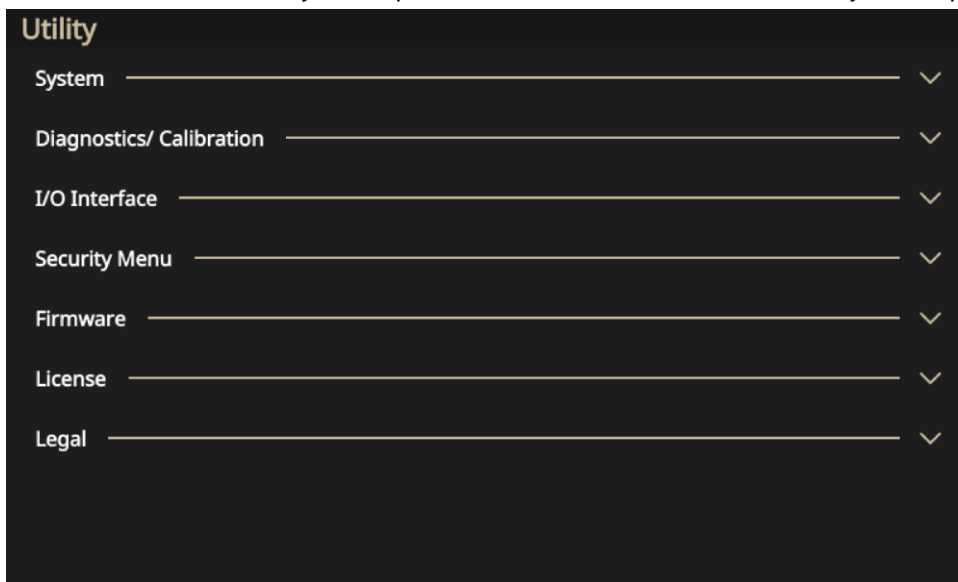

Figure 102: Utility home screen

System menu settings

The System function screen contains the following settings:

- **Language:** Select from the following languages for your instrument: **English, French, German, Japanese, Korean, Simplified Chinese, Traditional Chinese, or Russian.**
- **Soft keyboard:** Select **On** to enable the touchscreen keyboard when you need it. Select **Off** if you do not want to use the touchscreen keyboard.
- **Trigger Out:** Select **Sync** or **Trigger** depending on your need (see [Synchronize multiple instruments](#) (on page 52) and [Trigger Out](#) (on page 42) for more information).
- **Clock Reference:** Set the reference clock to **Internal** or **External**.
- **Power On:** Select **Last** or **Default** when you power on your instrument (see [Change instrument settings](#) (on page 86) for more information).
- **Screen Saver:** Select **On** or **Off**. Choose **On** if you want the screen to become blank if there is not any touchscreen activity for more than five minutes. If you want the screen to stay on continuously, select **Off**.
- **Click Tone:** Select **On** or **Off** depending on your preference. If this option is on, you will hear a tone when using the front panel buttons. If you select **Off**, you will not hear a tone.
- **Beeper:** Select **On** or **Off**. If this option is on, you will hear a beep when a message box appears on your screen. If you select **Off**, you will not hear a beep.
- **Factory Default:** Resets the instrument to factory default settings.
- **Brightness:** Use the brightness slider to adjust the touchscreen brightness.
- **Time Zone:** Set the required time zone.

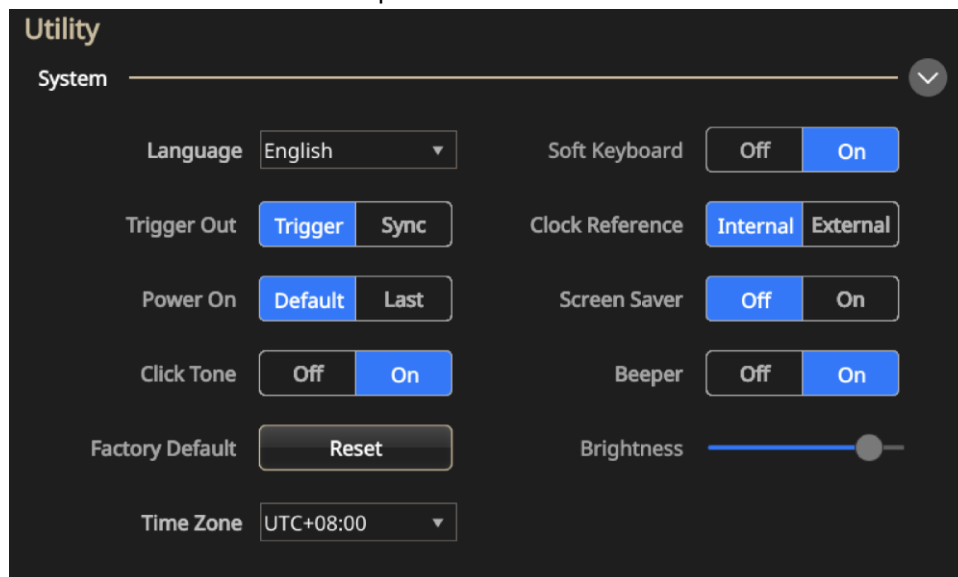

Figure 103: System settings

Change instrument settings

The default settings are restored when you turn on the instrument. You can set the instrument to remember and restore the last used settings next time you turn on the instrument (see [Utility menu options](#) (on page 84) for more information).

To change the Power On settings:

1. Press the front-panel **Utility** button (located in the SETUP area).

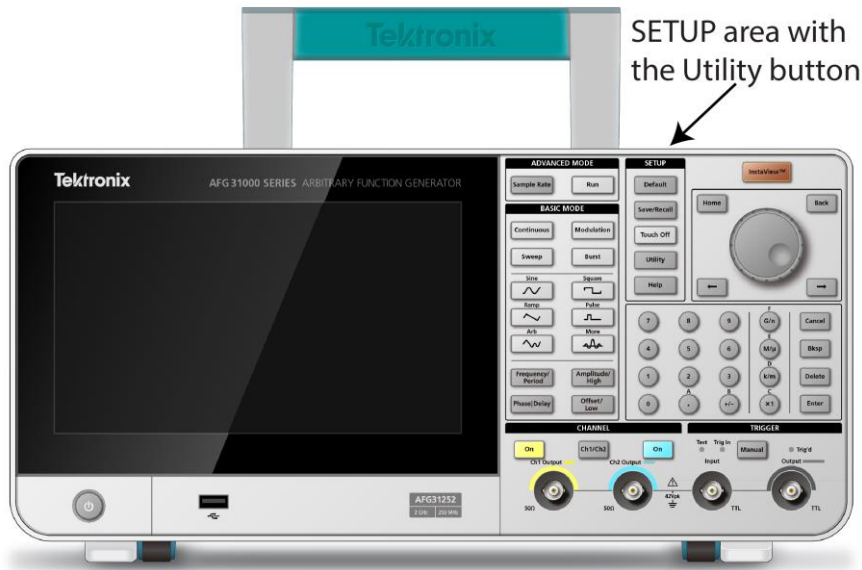

Figure 104: Utility button

2. On the touchscreen, select **System**.
3. From the Power On option, select **Last**.

You can make additional changes in the System menu. For example, you can change:

- Trigger Out to **Sync** or **Trigger**
- Enable or disable the **Click Tone**
- Change the Clock Reference to **External** or **Internal**
- Enable or disable the screen saver by choosing **On** or **Off**
- Enable the beeper by choosing **On** or **Off**
- Adjust the brightness of the touchscreen with the slider bar

Erase instrument setups and waveforms from memory

You can erase all instrument setups and user-defined waveforms from the instrument internal memory using the following procedure.

NOTE. You can restore the instrument to its default settings at any time without erasing memory by pressing the front-panel **Default** button.

To erase instrument setup and waveforms from memory:

1. Press the front-panel **Utility** button (located in the SETUP area).
2. On the touchscreen, select **System**.
3. From the Factory Default option, select **Reset**.
4. When you see the message asking if you want to execute this action, select **OK** (or **Cancel** if you decide not to erase the setup and waveforms).

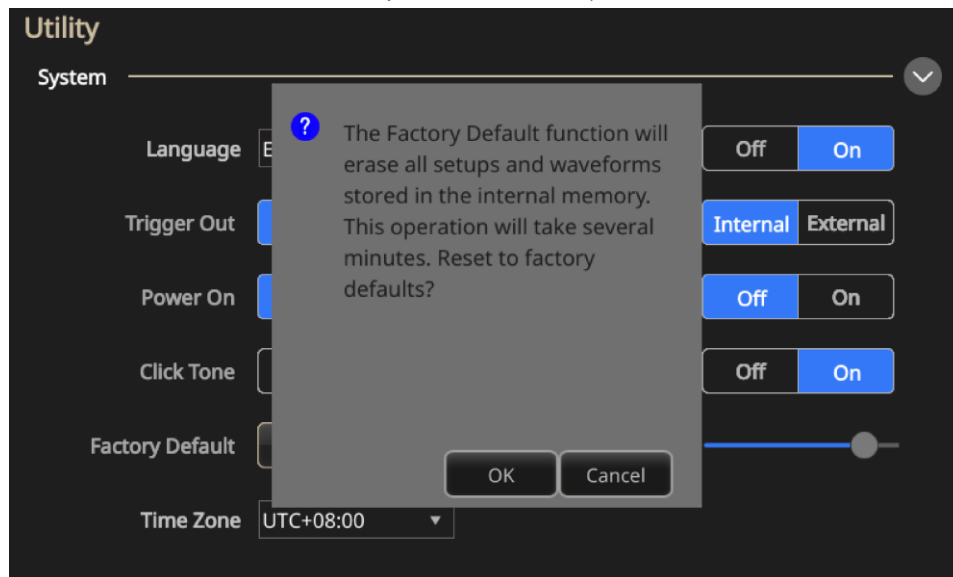

Figure 105: Erase instrument setups and waveforms

Select a local language

You can select the language you want displayed on the instrument screen.

NOTE. When you power on the instrument for the first time, English is selected by default. After you select the language you want, the menu, pop-up messages, and built-in help are displayed in the specified language. You can also use a front-panel overlay that is appropriate to the language that you select.

To select the language:

1. In the SETUP area, press the front-panel **Utility** button.
2. On the touchscreen, select **System**.
3. For the Language option, select the appropriate language (**English**, **French**, **German**, **Japanese**, **Korean**, **Simplified Chinese**, **Traditional Chinese**, or **Russian** (see the following figure)).

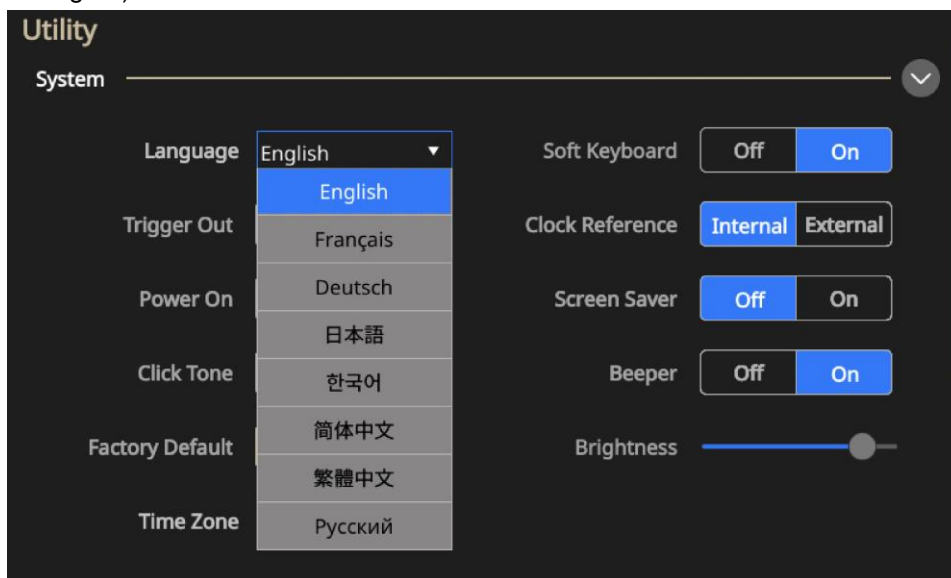

Figure 106: Language selection

Diagnostics and calibration functions

The diagnostics and calibration options in the Utility menu are listed below.

- **Diagnostics:** Select **Run** to perform the self-test to verify that your instrument is operating correctly (see [Perform diagnostics and calibration](#) (on page 90) for more information).
- **Calibration:** Select **Run** to check DC accuracy using the internal calibration routines (see [Perform diagnostics and calibration](#) (on page 90) for more information).
- **Warm Up Time:** Select **Start** to warm up the instrument for 20 minutes before performing diagnostics or calibration.
- **Refresh Relay:** Select **Run** to clear the relay contacts of oxide layers. This takes about two minutes and will switch the relays approximately 1000 times.

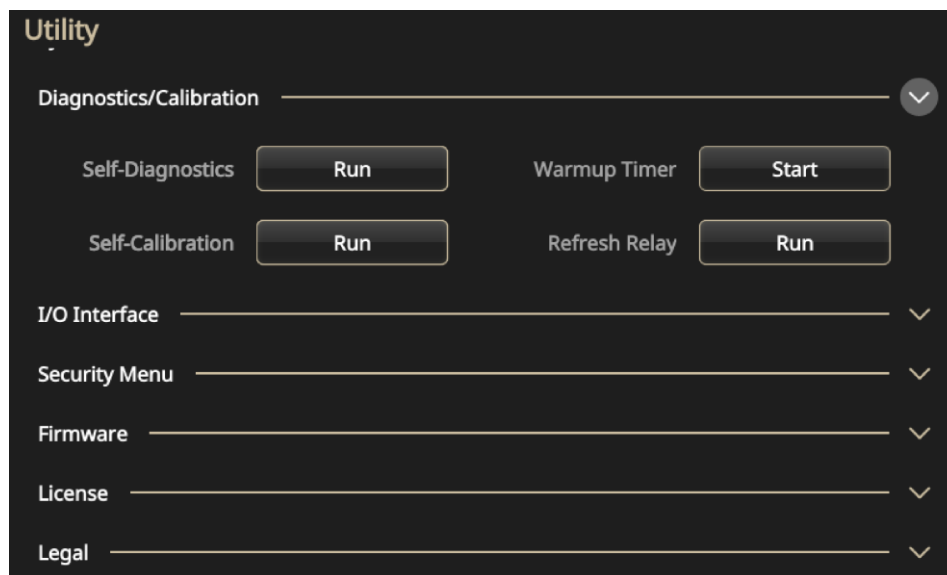

Figure 107: Diagnostics and calibration

Before you run these tests:

- Power on the instrument and allow 20 minutes for the instrument to warm up.
- Make sure the is operating at an ambient temperature between 0 °C and 50 °C.

Perform diagnostics and calibration

The instrument performs a limited set of hardware tests at power-on. You can also run the following manual diagnostics and calibration functions from the Utility menu (see [Utility menu options](#) (on page 84) for more information). This procedure uses internal routines to verify that the instrument is operating correctly.

- **Diagnostics (self-test):** Perform diagnostics to verify that your instrument is operating correctly.
- **Calibration (self-calibration):** The calibration function checks DC accuracy using the internal calibration routines.



Figure 108: Diagnostics and calibration

NOTE. If you need to verify that the instrument meets the warranted specifications, do the complete set of performance verification procedures provided in the *Specifications and Performance Verification Manual*.

To perform diagnostics and calibration:



CAUTION. Do not remove power from the instrument while performing calibration. If the power is turned off during calibration, data stored in the internal memory may be lost.

NOTE. Disconnect all cables from the instrument when you perform diagnostics or calibration (do not remove the power cord).

1. Select the **Utility** icon on the touchscreen.
2. Select **Diagnostics/Calibration** in the menu.
3. To perform Diagnostics, select **Run**.
4. Select **OK** to perform Diagnostics or **Cancel** to exit.

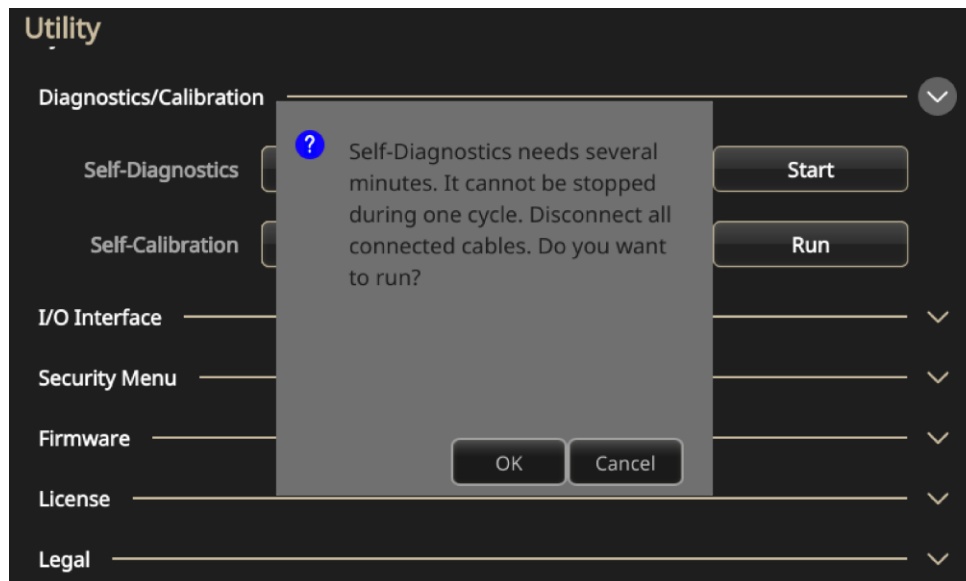

Figure 109: Run system diagnostics

5. Wait until the test is completed. The diagnostics test takes eight minutes to complete.
6. To perform Calibration, select **Run**.
7. Select **OK** to perform calibration or **Cancel** to exit.

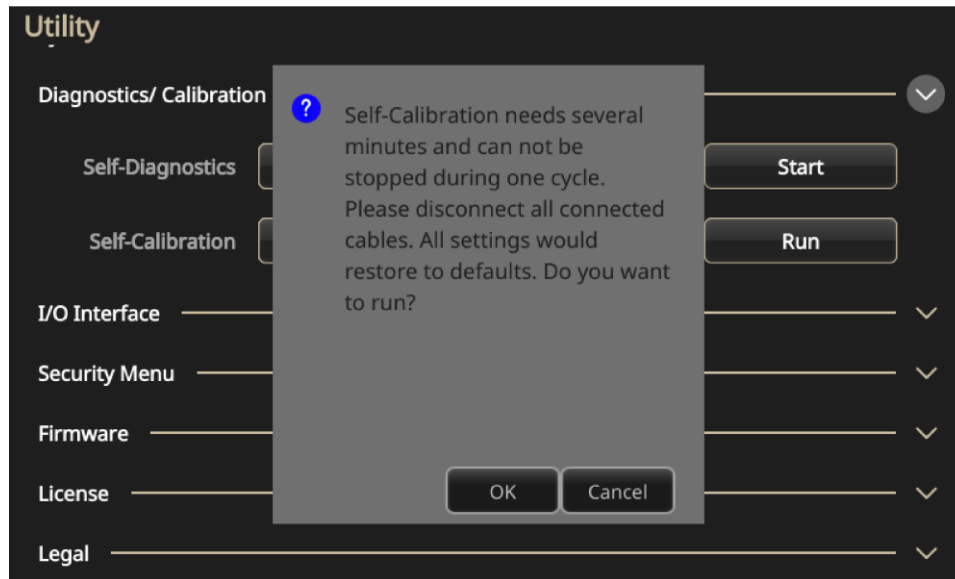

Figure 110: Run self-calibration

8. Wait until the test is completed. The diagnostics test takes eight minutes to complete.
9. Once calibration or diagnostics is executed, a dialog box displays the results including any errors.

Input and output interface

The I/O (input and output) Interface options in the Utility menu are listed below. This feature is used to connect your instrument to a network.

NOTE. You must obtain information from your network administrator to change these settings. The procedure for entering the network settings depends on your network configuration.

- **Configuration:** Select **Off Bus** (to disconnect your instrument from the GPIB bus) or **Talk/Listen** (to remotely control your instrument from an external host computer. See Connect to a network for more information).
- **GPIB Address:** Enter the address of your instrument.
- **DHCP:** Select **On** or **Off** for the dynamic host configuration protocol (this option is network-dependent).
- **Default Gateway:** Select the dialog box and enter the gateway address (your network administrator can provide this information).
- **Subnet Mask:** Enter the subnet mask (your network administrator can provide this information).
- **IP Address:** Enter the correct IP address.

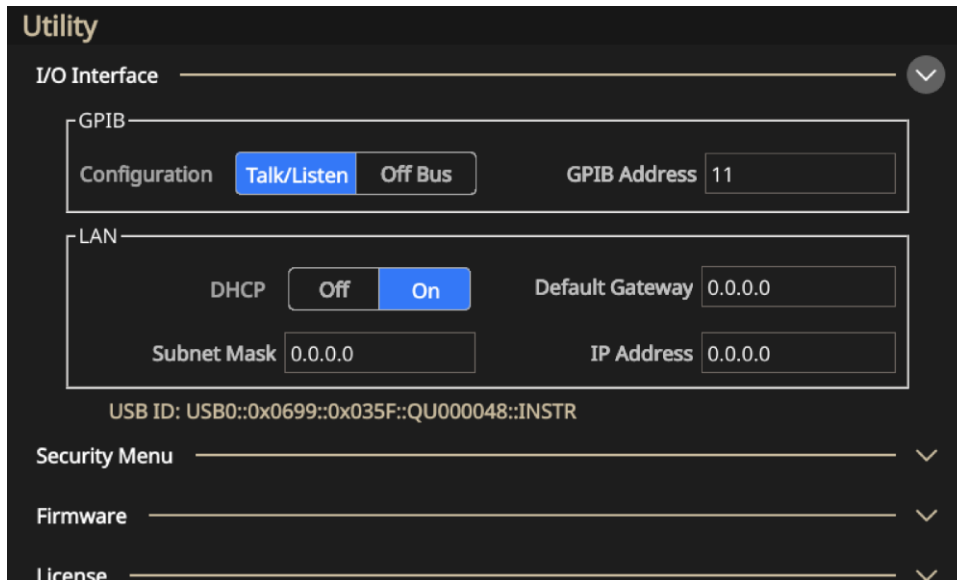

Figure 111: I/O Interface options

Security menu settings

The Security Menu options in the Utility menu are listed below.

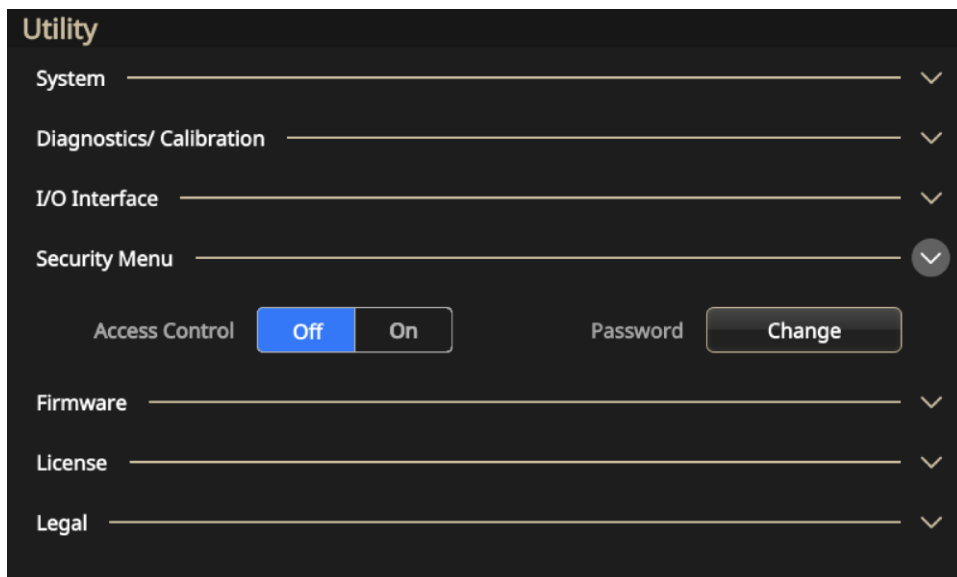

Figure 112: Security menu settings

This menu is used to protect and limit access to the following items.

- **Access Control:** Select **On** or **Off**. If Access Protection is On, you will not be able to update the firmware.

NOTE. Access Protection is set to Off by default. Also, when Access Protection is On, you will not be able to change the password.

- **Change Password:** Select **Change** and follow the instructions on the screen.

NOTE. The default password is `DEFAULT 123456`. If you change your password, it must have at least four characters but no more than 14, and numbers can be zero through 9. If you forget the password, please contact your local Tektronix office, sales partner, or distributor. You can also call the corporate headquarters of Tektronix in North America at 1-800-833-9200. Visit www.tek.com to find contacts in your area.

Firmware menu settings

The update firmware function allows you to update the firmware if there is an update available. See [Update instrument firmware](#) (on page 95) for details.

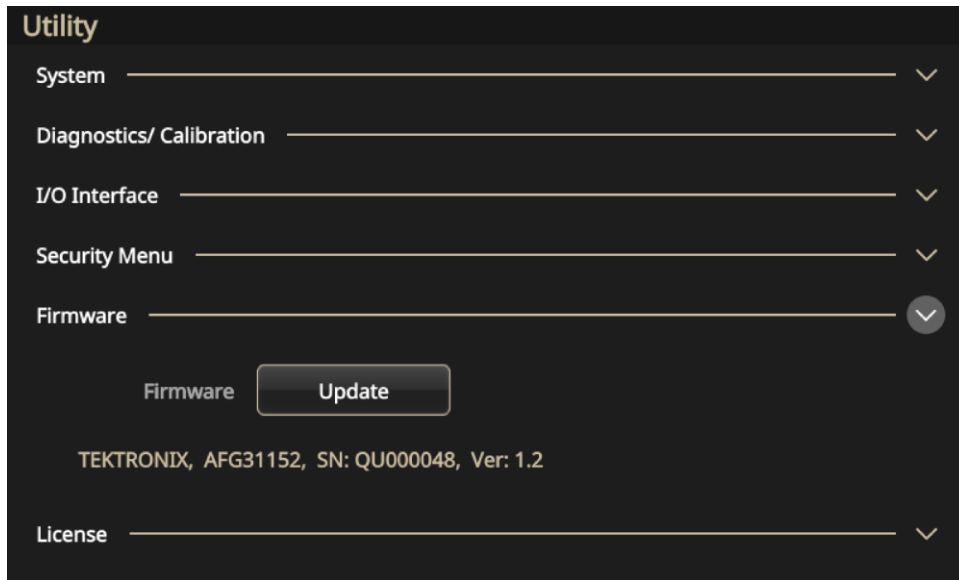

Figure 113: Update firmware menu

Update instrument firmware

You can use the front-panel USB Type A connector to update your instrument firmware using a USB flash drive (see [USB interface](#) (on page 15) for more information). Also, this task is done using the front-panel touchscreen.



CAUTION. Updating your instrument firmware is a sensitive operation; it is critical that you follow the instructions below. If you do not, you may cause damage to your instrument. For example, to prevent damage to the instrument, do not remove the USB flash drive at any time while updating the firmware, and do not power off the instrument during the update process.

To update your instrument firmware:

1. Visit tek.com and search for the Series 31000 firmware.
2. Download the compressed .zip file to your computer.
3. Unzip the downloaded file and copy the .ftb file to the USB flash drive root directory.
4. Insert the USB in the AFG31000 Series instrument front panel.
5. Press the **Utility** button.
6. Select **Firmware > Update**.
7. Select the USB icon.

NOTE. The example screen images may vary based on which instrument you have.

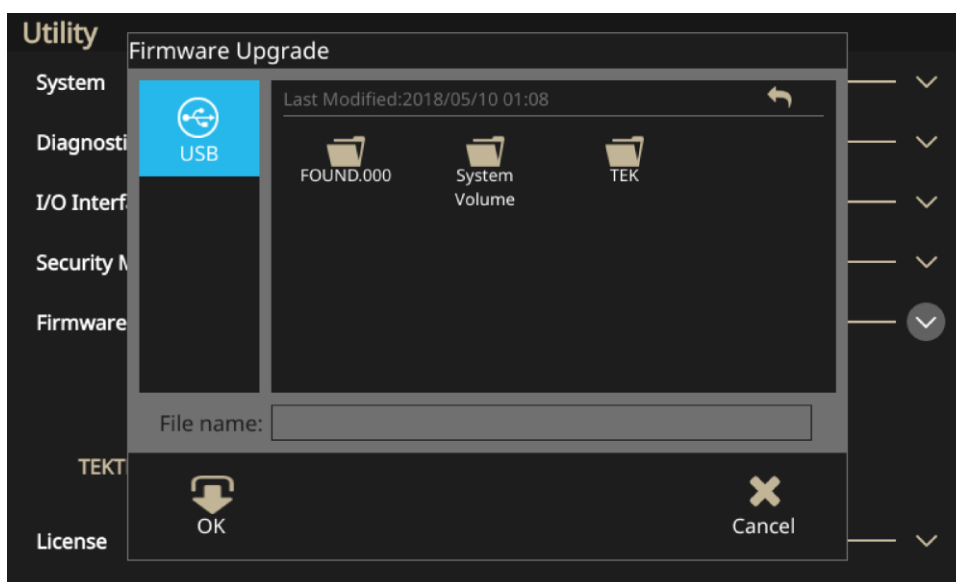

Figure 114: Update firmware

8. Select the file that you are using to update your instrument.
9. Select **Recall** (you will see a message asking to confirm this update).
10. Verify that the instrument powered off and powered on to install the update.
11. Remove the USB drive.

NOTE. You can limit access for firmware updates by going to the Security Menu and choosing **Access Protection** and entering a password.

License

The install license function allows you to update the license for increased memory and capability. Depending on the instrument you have purchased, you will receive a license that determines the size of memory for your instrument. The memory size determines sequence functionality and instrument bandwidth.

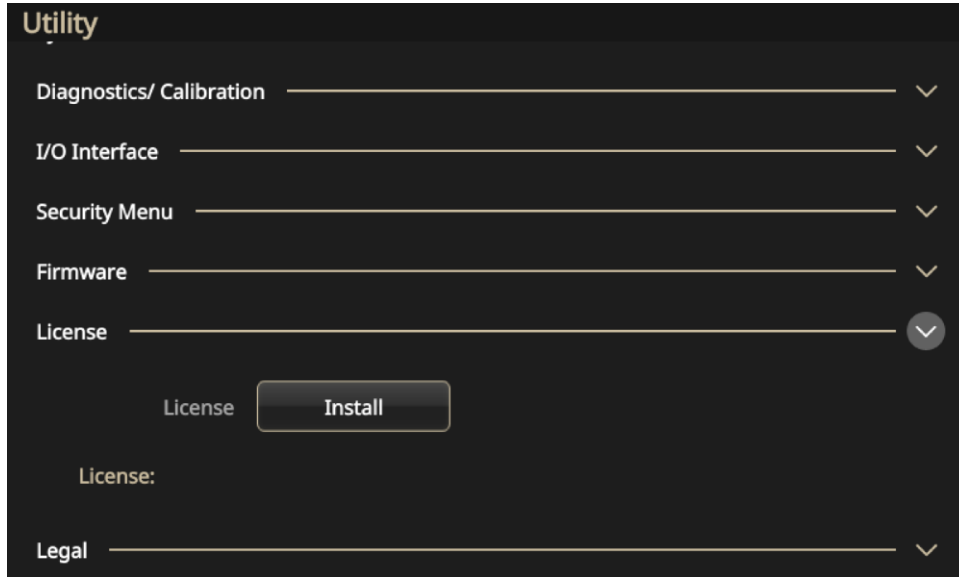

Figure 115: License update

Help

The instrument help system allows you to access information about specific menu items and instrument functions when you need to find specific information. You can access and navigate this help system using the touchscreen. The individual help topics may contain links to other topics, as well. These can be accessed by following the on-screen instructions.

Follow the steps described here to access the instrument help system.

To access Help:

1. Select the **Help** icon on the touchscreen.
2. Use the touchscreen to move the highlight from one link to another.
3. Press the Help icon on the touchscreen to display the Help menu.
4. Turn the navigation control to highlight a help topic in the index or to move from page-to-page within a topic. Press navigation control to display the topic from the index page.

ArbBuilder

The included ArbBuilder software provides arbitrary waveform creation and editing while eliminating the need to connect to a computer or use a USB flash drive to load arbitrary waveforms.

You can open previously created waveforms or create a new waveform using the ArbBuilder tool. When you select the ArbBuilder icon to open ArbBuilder, the following screen is displayed.



Figure 116: ArbBuilder home screen

ArbBuilder is a built-in application that allows you to create and edit arbitrary waveforms on the function generator. You can create an arbitrary waveform or a template of standard waveforms. With a large capacitive touchscreen, you can drag, pinch and zoom, or edit the waveform with your fingertips.

You can replicate waveforms or load data files directly into ArbBuilder using a USB flash drive.

The completed waveform can be sent to hardware for replication; amplitude and offset will be set automatically, without normalization.

Create an arbitrary waveform

The instrument can output an arbitrary waveform that is stored in the internal memory or on a USB flash drive.

To create an arbitrary waveform:

1. Select **Basic** on the touchscreen.
2. Swipe the arrow at the bottom of the touchscreen up and select the **ArbBuilder** tab.
3. Select **New**.
4. Select how you want to create your waveform: **Freehand**, **Horizontal**, **Vertical**, or **Point**.
5. Once you have created your waveform, select **File**.
6. Select **Save As** to change the name and save the waveform.
7. You can also save the file and select **Send** to see the waveform on the channel that you choose.
8. Swipe the ArbBuilder area down and to see the waveform you created on the channel you selected.

NOTE. File names are only in English characters. If you use non-English characters to name a file, the characters are replaced with symbols, for example, #, \$, *, and %. Spaces are not allowed.

Create a standard waveform

You can create a waveform using the ArbBuilder tool. You can create new waveforms by selecting from a list of standard functions, using the Equation Editor ([Create a waveform using equations](#) (on page 99)), or drawing a waveform ([Draw a Waveform with ArbBuilder](#) (on page 108)).

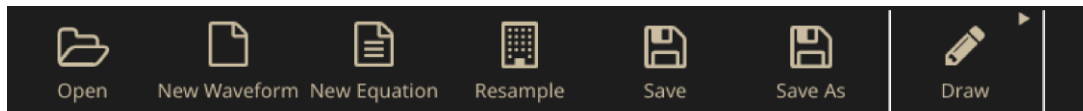

Figure 117: ArbBuilder home tab

To create a standard waveform

1. Select **New Waveform** from the Waveform tab.

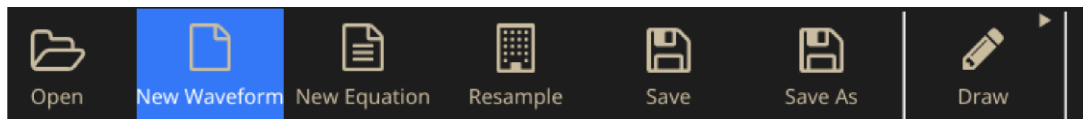

Figure 118: ArbBuilder New Waveform

2. Select a standard waveform from the Function drop down menu. You can choose **Sine**, **Square**, **Triangle**, **Pulse**, **Noise**, **Sin(x)/x**, **DC**, **Sweep**, **Lorentz**, **ExpRise** and **ExpDecay**, waveform.
3. Adjust the vertical and horizontal parameters as desired.
4. Select the **Preview** button to view the waveform.

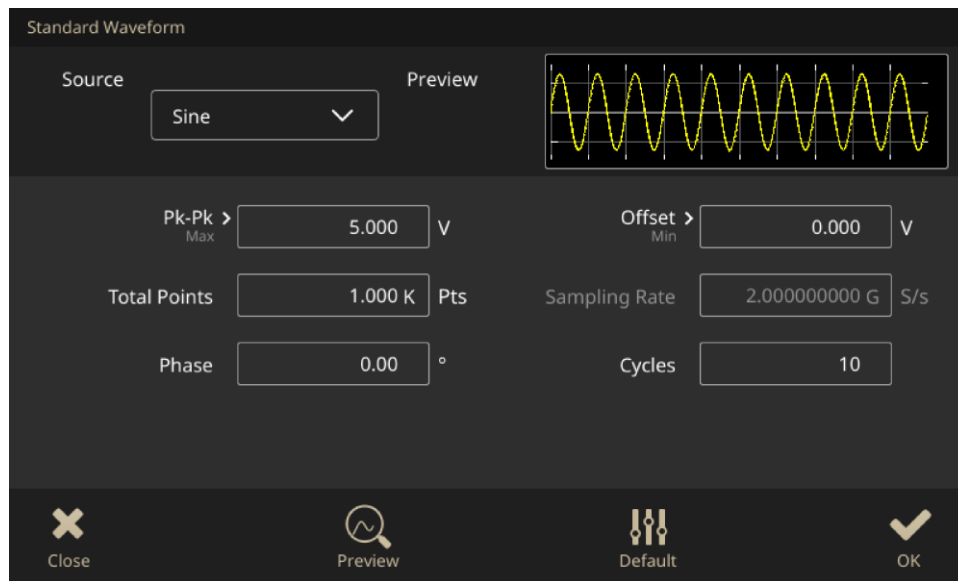

Figure 119: ArbBuilder main screen

5. When prompted select **OK** or **Cancel** to exit the window.
6. Select **Save** or **Save As** to save the waveform, or click **Close** to close the waveform.
7. Select **Send**.
8. Select **To CH1** or **To CH2** under the Send tab to send this waveform to channel 1 or channel 2.

Create a waveform using equations

You can generate a waveform with Equation Editor in ArbBuilder.

NOTE. The Equation editor processes all file inputs and outputs in the current working directory. The current working directory must have read and write access or the equation file will not compile. Compilation may be dependent on the available memory and other resources of the instrument.

The Equation Editor is an ASCII text editor that allows you to create, edit, load, and compile equation waveform definitions into a waveform using the Waveform Programming Language (WPL). Use WPL to generate a waveform from a mathematical function, perform calculations between two or more waveform files, and use loop and conditional branch commands to generate waveform values. Compile the equation file to generate the described waveforms.

An equation file is a text file that you create and edit in the Equation Editor. Select **New Equa** to open the equation editor. A soft keyboard containing equation components is displayed.



Figure 120: ArbBuilder equation file with soft keyboard

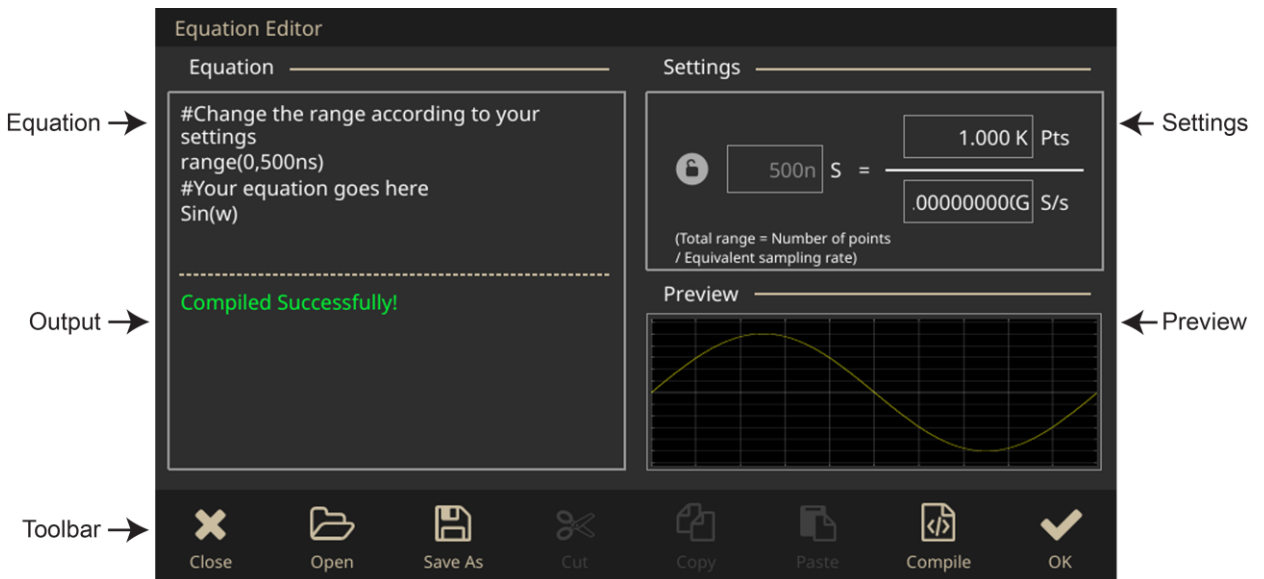

Figure 121: ArbBuilder equation file

The following table describes the screen elements of the equation editor.

Table 10: Equation editor screen elements

Element	Description
Equation	The area where you enter text and equation information.
Output	Displays the status of the compilation. If the compilation fails, the application displays an error message. If the compilation is successful, then the application displays Compiled Successfully.
Settings	Provides controls for adjusting range and points.
Preview	Displays the waveform graph after compilation is complete.
Toolbar	Provides edit operations, such as open, save, cut, copy, and paste.
Open	Opens existing equations.
Save as dialog	The file name to which the equation or text is written, or the name of the file being edited. The instrument appends the default .eqa file extension to all Equation Editor files.
Compile	Compiles the currently loaded or edited equation file. The status of the compilation is displayed in the output window.
OK and Close buttons	OK saves the Equation Editor window; Close exits the Equation Editor window.

The ArbBuilder soft window contains the components used to set the time range, functions, operators, variables, constants, syntax items, and characters.



Figure 122: ArbBuilder soft keyboard

Table 11: Command syntax

Component	Symbol	Meaning
Syntax items	()	Parentheses specify the order of operations. Each opening (left) parenthesis must be paired with a closing (right) parenthesis. When there are multiple arguments (for example, range, max, min) they are separated with a comma (,).
Variables.	t, x, v	The following variables can be used in an equation: t = time from the beginning of the <code>range()</code> statement. x = variable taking on a value from 0.0 to 1.0 within the <code>range ()</code> v = variable showing the current value of the waveform data at that position in the statement
Operators	+, -, *, /	These add, subtract, multiply, or divide the components.
	^	Expresses exponents. Only integers can be raised to a higher power. ^ has the same priority as * and /. Parentheses are required to give priority to multiplication. For example: $\pi * (2^3) * x$ where $2^3 =$ two raised to the third power.
Comment	#	Comments are preceded by a number sign (#). When a number sign is entered, all characters after that are treated as a comment. All of the items in the component menu can be used in a comment.
Characters	a-z, %, \$, &, @, A, _	The characters available in the component menu are the letters of the alphabet (a-z) and several symbols (% , \$, & , @ , A and _). These are used in comments.
	pi	The circumferential ratio.
	e	Exponent (for an implied 10). The range for numbers expressed in this scientific notation is from $ 5.9e-39 $ to $ 3.4e38 $. For example: $1e6=1,000,000$, $1e-3=0.001$
	k	Constants that can be specified in equations (k0-k9). Specifying a new value for the same k# replaces the old value with the new one. If no constant is defined for k, this value will be automatically set to 0.
	=	Equals sign = is used with k constants. For example: $k0=2*\pi$

Component	Symbol	Meaning
		A hard return ends the line for the range or equation; inserting a return () in the middle of the line partitions.
Functions	<code>sin()</code> , <code>cos()</code>	The arguments for these trigonometric functions are in radians. For example: <code>range(0,100_s) cos(2*pi*x)</code> or <code>range(0,100_s) sin(2*pi*1e4*t)</code>
	<code>exp()</code> , <code>log()</code> , <code>ln()</code>	Exponential function, common log function, natural log function. The log and ln arguments must be positive. For example: <code>range(0,50_s) 1-exp(-5*x)</code> <code>range(50_s,100_s) exp(-5*x)</code> Example: <code>range(0,100_s) log(10*(x+0.1))</code> Example: <code>range(0,100_s)</code>
	<code>sqrt()</code>	The square root; the argument must be a positive value.
	<code>abs()</code>	The absolute value. For example: <code>range(0,100_s) abs(sin(2*pi*x))</code>
	<code>int()</code>	Truncates the fraction to obtain the integer. For example: <code>range(0,100_s) int(5*sin(2*pi*x))/5</code>
	<code>round()</code>	Rounds off the fraction to obtain the integer. For example, <code>range(0,100_s) round(5*sin(2*pi*x))/5</code>
	<code>norm()</code>	Normalizes the range specified with <code>range()</code> and scales the amplitude values so that the maximum absolute value is 1.0 (that is, a value of +1.0 or -1.0). The <code>norm()</code> statement comprises an entire line. For example: <code>range(0,100_s) sin(2*pi*x)+rnd()/10</code> <code>norm()</code>
	<code>max()</code> <code>min()</code>	<code>Max()</code> takes the larger of two values. <code>Min()</code> takes the smaller of two values. For example: <code>range(0,100_s) sin(2*pi*x)</code> <code>range(0,50_s) min(v,0.5)</code> <code>range(50_s,100_s) max(v,-0.5)</code>
	<code>range()</code>	The equation must specify the time domain. If the time domain is not defined, this is an error. The time domain is specified with <code>range()</code> . When making a new equation file, <code>range(0)</code> , is input in the first line of equation, then the time is specified. This setting is valid until the next <code>range</code> item is specified. With the first <code>range()</code> specification, any number of lines of equation can be input. Text written after the <code>range()</code> on the same

Component	Symbol	Meaning
		line is invalid. The format for the range (item. range(Equation starting time, Equation ending time)). For example: range(0,1ms) Time range sin(2*pi*x) equation
	rnd (integer from 1 to 16,777,215)	When an argument is specified, generates a random number sequence using that argument as the initial value. If the argument is omitted, 1 is used. For example: range(0,100 _s) rnd(2)/3
	diff()	Differentiates the function over the range specified with range(). Specified with diff(). The diff() comprises an entire line. For example: range(0,33 _s) -0.5 range(33 _s,66 _s) 0.5 range(66 _s,100 _s) -0.5 range(0,100 _s) diff()
	integ()	Integrates the function over the range specified with range(). Specified with integ(). The integ() comprises an entire line. After integ(), specify normalization (norm()) as necessary. For example: range(0,33 _s) -0.5 range(33 _s,66 _s) 0.5 range(66 _s,100 _s) -0.5 range(0,100 _s) integ() norm()
	mark (marker1 or marker2)	Sets the marker for the range set with range() . After compiling, there is no marker display, but the set marker can be verified with the waveform editor. The mark() statement comprises an entire line. For example, when mark(1) is input, nothing else can be input on that line.

Use the Equation Editor Units Menu (accessed through soft keyboard) to specify the units for the parameters or variables used in the equation. The following table lists the units that you can use and their descriptions.

Table 12: Units Menu

Unit	Meaning
m	milli (e-3)
u	micro (e-6)
n	nano (e-9)
p	pico (e-12)
s	second
,	comma separator
K	Kilo (e3)
M	Mega (e6)

Use the soft keyboard to confirm, backspace, or clear the equation. The following table lists the units that you can use and their descriptions.

Table 13: Keyboard text commands

Button	Meaning
Enter	Confirms the selection and moves to the next line of the equation.
BKSP	Backspaces over the last character. Works like the backspace key on the keyboard.
CLR	Clears the entire equation.

Create a waveform using the equation editor

1. Select **ArbBuilder > File** and select the **New Equation** icon to open the equation editor.



Figure 123: ArbBuilder equation editor ribbon

2. In the Equation Editor window, enter text to form a waveform equation. For example, type `Sine(w)` in the equation input box.

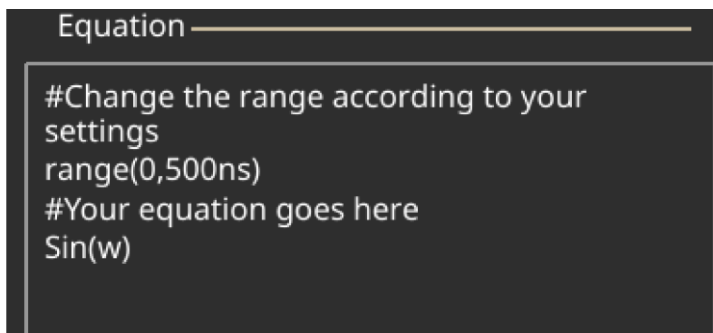

Figure 124: ArbBuilder equation text editor

3. Click **Compile** to generate a waveform in the preview box. You will see **Compiled Successfully** in the Output box and a log waveform will display in the Preview box. If you enter an invalid equation, the Output box will show an error message and the line containing the error in the equation input box will turn red.

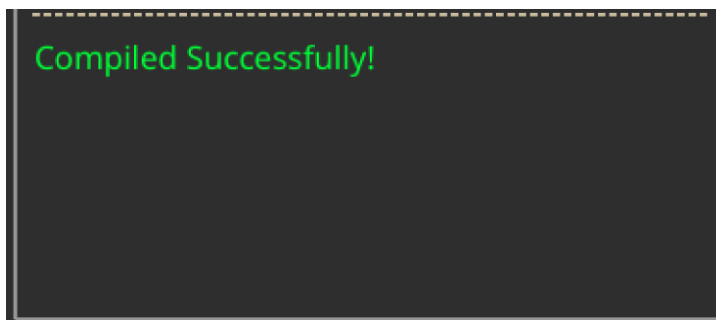

Figure 125: ArbBuilder compile successfully

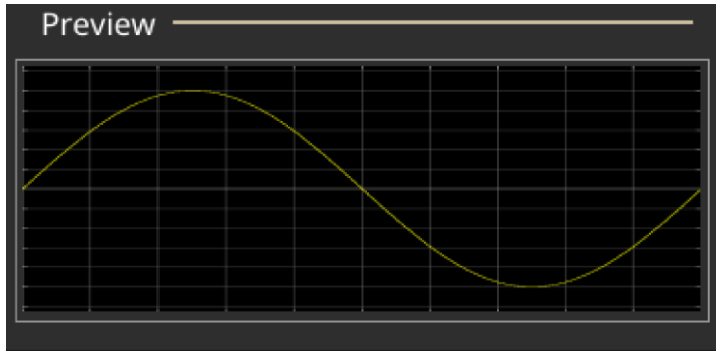

Figure 126: ArbBuilder Preview

4. Click **OK** to display the waveform in editable mode, or click **Cancel** to cancel the operation.
5. You will see a sine waveform. You can edit, save, or send it to channel 1 or 2.



Figure 127: ArbBuilder log waveform

NOTE. The equation editor supports the basic 7-bit ASCII character set. The maximum length of a single string is 256 characters, including spaces. Concatenate strings by entering a colon character (:) at the end of a line. The maximum length (the sum of all the string lengths) is 1000.

Save a waveform equation

1. Create a waveform equation by following steps 1 – 3 in the [Create a waveform using equations](#) (on page 99).
2. A Windows **Save as** dialog box is displayed.

Enter a filename and select **OK** to save. The equation file will be saved in the .eqa format file.

Open an equation file

1. In the Equation Editor window, select the equation editor toolbar.
2. Select an existing waveform equation file and click **Open**.

Edit an equation file

In the Equation Editor window, you can do the following to modify equations:

- Cut. Highlight the part of the equation you want to cut and select **Cut**.
- Copy. Highlight the part of the equation you want to copy and select **Copy**.
- Paste. Highlight the part of the equation you want to paste and select **Paste**
- Directly edit the text using a keyboard or the Command List keypad.

Open a waveform with ArbBuilder

1. Select **Open** from the Waveform tab. The file open dialog box is displayed. Select an existing waveform file. ArbBuilder supports several file formats: `wfm`, `csv`, `tfw`, and `tfwx`.
2. Select **Open in New Tab**.
3. Select **OK** to open the file..

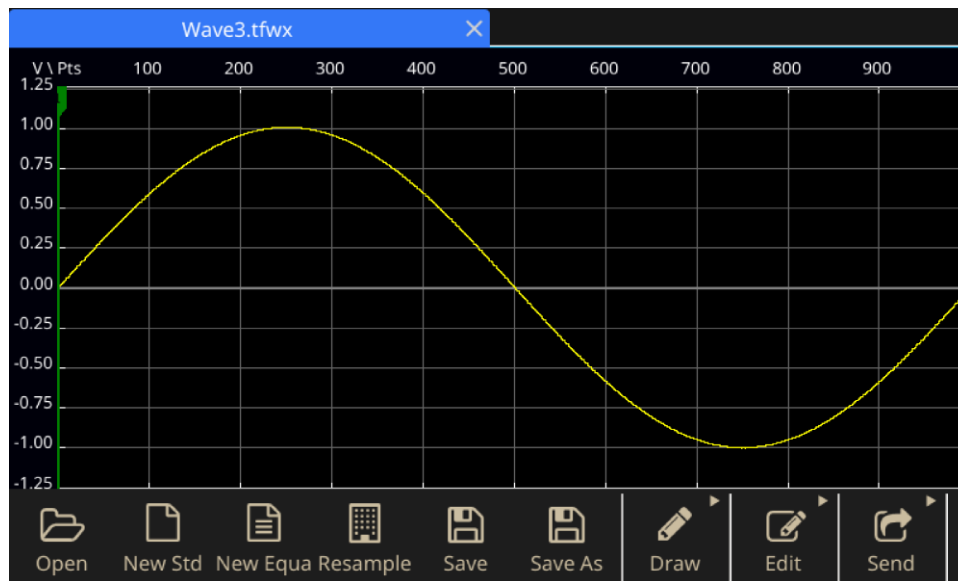

Figure 128: ArbBuilder options

Draw a waveform with ArbBuilder

1. Open a standard waveform. For information on creating a standard waveform (See [Create a Standard Waveform](#) (on page 98).).
2. Click the **Draw** tab.
3. Select the icons in the draw toolbar to create your waveform.
 - **Freehand:** Draw a waveform with both horizontal and vertical points.
 - **Horizontal:** Draw a waveform in a horizontal direction.
 - **Vertical:** Draw a waveform in a vertical direction.
 - **Point:** Draw some points on the waveform screen, then select how the points should be connected (**Linear**, **Smooth**, or **Staircase**). The ArbBuilder software will insert additional points in the pattern to complete the waveform.

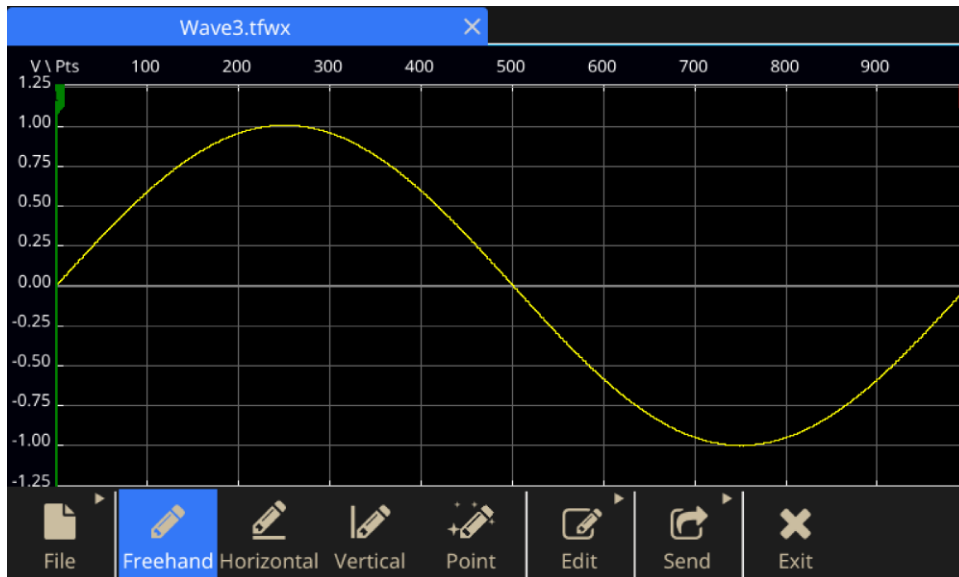

Figure 129: ArbBuilder freehand

4. If you select **Point**, the Point Draw toolbar is displayed. You can click the graph, select points, and then use the functions on the toolbar to edit them.
5. From the Point Draw toolbar you can insert, delete, or clear all the data points.

You can select from the interpolation menu and apply one of the three selections to the waveform.

- **Linear:** Points can be connected with a straight line.
- **Smooth:** Points can be connected with a smooth line.
- **Staircase:** Points can be connected with a staircase.

Edit a waveform with ArbBuilder

1. Open a waveform.

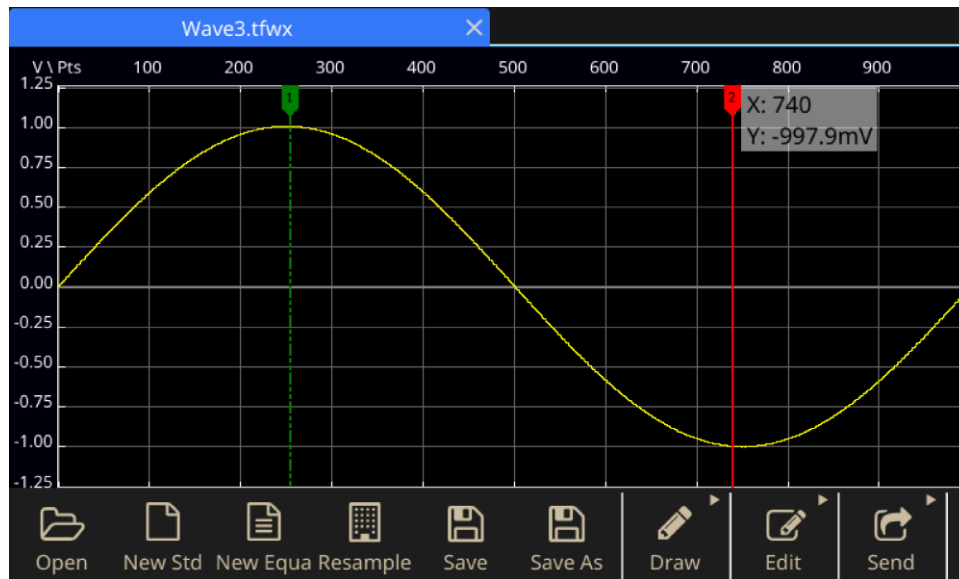

Figure 130: ArbBuilder open a waveform

2. Select **ArbBuilder > Edit**. You will see the edit toolbar.

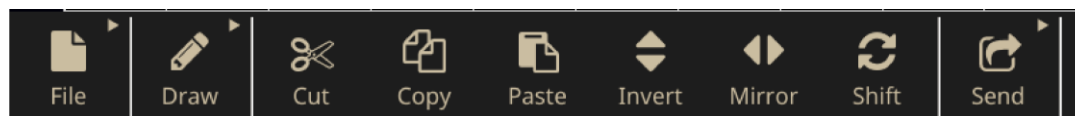

Figure 131: ArbBuilder edit toolbar

3. **Cut** is used to cut a piece of waveform data between the two cursors.



Figure 132: ArbBuilder highlight waveform data to cut

4. Copy. It is used to copy a piece of waveform data between the two cursors. The waveform will not be changed.
5. Paste.

Table 14: Paste functions

Item	Description
Paste at the End	Paste a waveform segment at the end of a waveform
Paste at the Beginning	Paste a waveform segment at the beginning of a waveform
Paste at the Active Cursor	Paste a waveform segment behind an active cursor.
Replace between the Cursors	Replace the waveform between the cursors by a waveform segment

1. Invert. It is used to overturn the waveform between the cursors in the vertical direction.



Figure 133: ArbBuilder invert

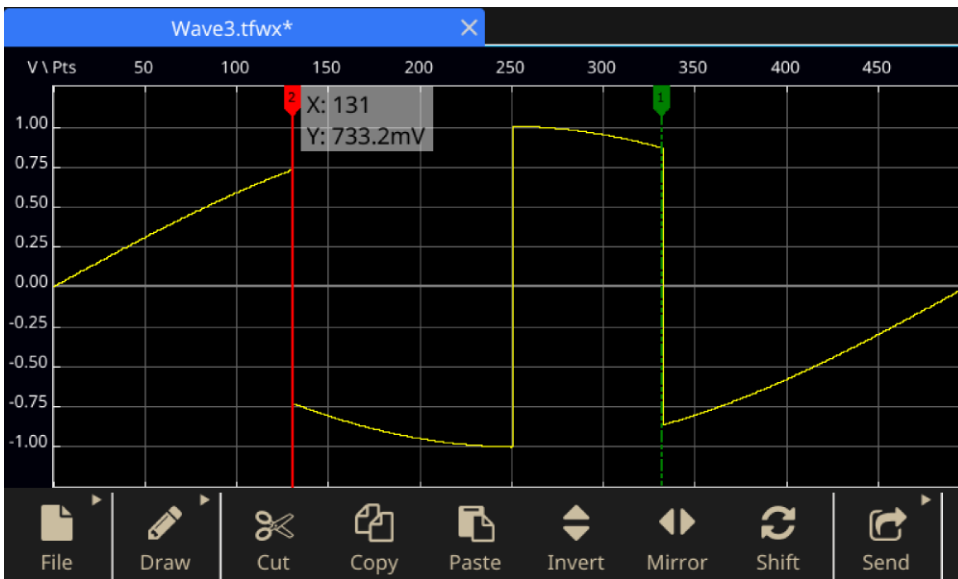

Figure 134: ArbBuilder invert final

2. Mirror. It is used to overturn the waveform between the cursors in the horizontal direction.



Figure 135: ArbBuilder mirror

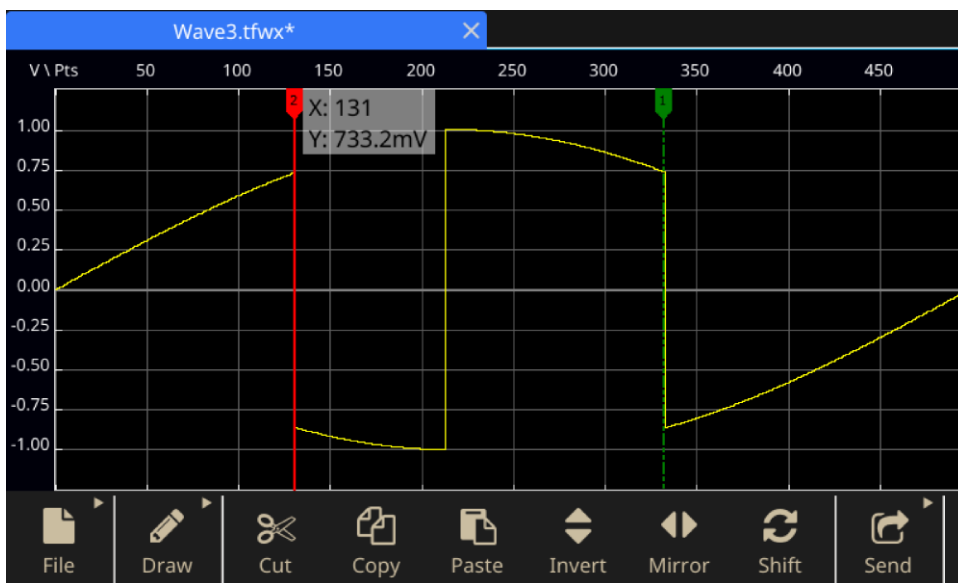

Figure 136: ArbBuilder mirror final

3. Shift/Rotate: When the user clicks the Shift/Rotate button, a panel is pop up in the right of main panel zone.

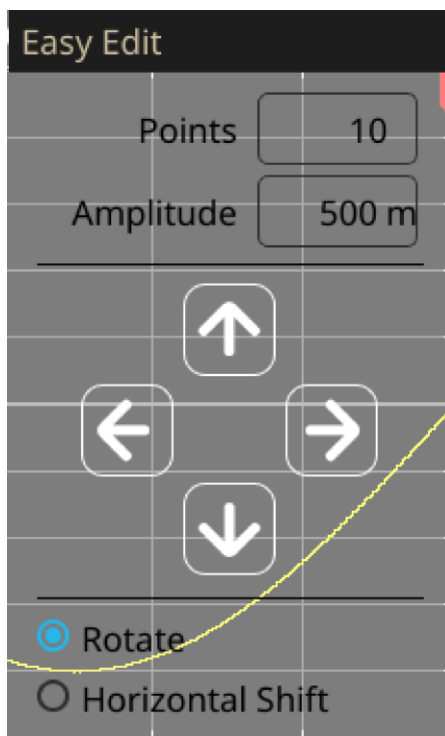

Figure 137: ArbBuilder waveform display zone

Table 15: Controls for modifying a waveform

Item	Description
Points	Set the point number which is moved each time
Amplitude	Set the amplitude which is moved each time
Rotate	Move the waveform periodically
Horizontal Shift	Move the waveform and use zero to fill the data after the waveform

- Shift left is used to move the waveform left.
- Shift right is used to move the waveform right.
- Shift up is used to move the waveform up.
- Shift down is used to move the waveform down.

**Figure 138: ArbBuilder shift rotate**

Send a waveform to CH1/CH2

1. Click **Send** in ArbBuilder.

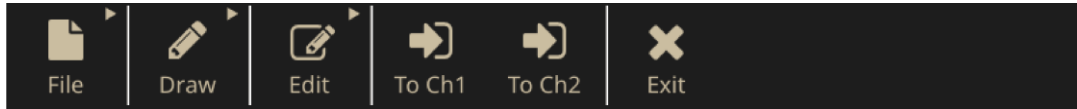

Figure 139: ArbBuilder Waveform to CH1/CH2

2. Click **Send to CH1** or to **CH2**. The waveform is sent to Basic.

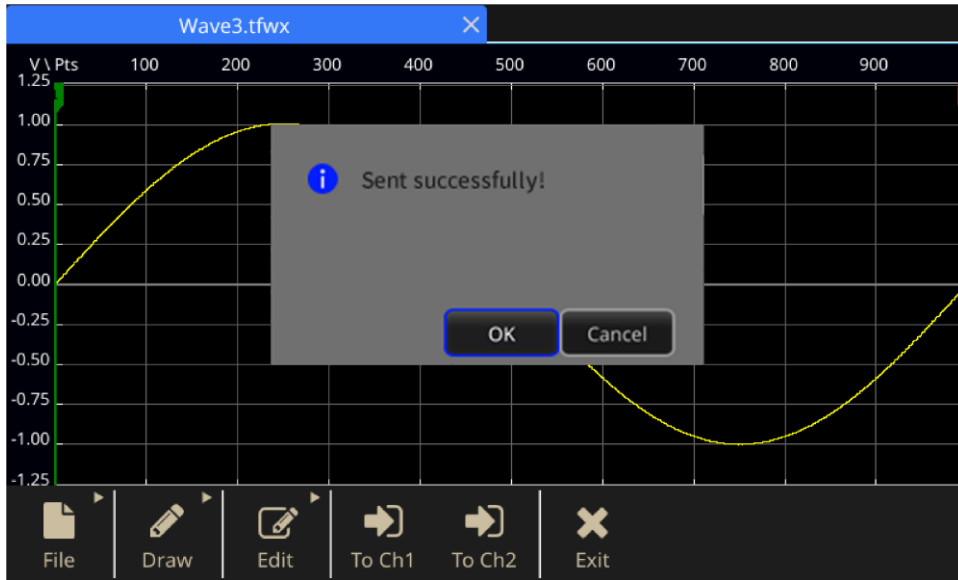

Figure 140: ArbBuilder successfull send message

Modify an arbitrary waveform

The ArbBuilder function supports several waveform edit functions and provides import or storage of edited waveform data. Two-channel model instruments have two edit memories (Edit Memory1 and Edit Memory2). ArbBuilder also supports copying waveform data between these two memories. To modify an arbitrary waveform, use the swipe area on the bottom of the touchscreen.

To modify an arbitrary waveform:

1. Select **Basic** on the touchscreen.
2. On the touchscreen, swipe the arrow up at the bottom of the screen and go to the **ArbBuilder** tab.
3. Select **Open**.
4. Select the file that you want to modify.

ArbExpress information

ArbExpress information

ArbExpress is a Windows-based software for creating and editing waveforms for Tektronix arbitrary waveform generators (AWG) and arbitrary function generators (AFG) instruments. With ArbExpress, you can quickly and conveniently create the desired waveforms and send them to the instrument. The following table and list describes the system requirements and general features.

Table 16: System requirements

System requirements	
operating system supported	Windows XP Professional or Windows 2000 or Windows 98/Me or Windows NT or Windows 7 (32-bit only)
minimum PC requirements	Pentium III 800 MHz and higher 256 MB RAM 300 MB free hard disk Microsoft Internet Explorer 5.01 and higher .NET Framework 1.1 Redistributable 800 x 600 Display resolution
TekVISA	Version 3.3.4.6 and above

- Create waveforms from standard waveform templates
- Modify and transfer waveforms to perform DUT level tests
- Directly import waveforms from Tektronix oscilloscopes
- Send waveforms to AWG/AFG instruments directly from ArbExpress or MATLAB
- Math operations on waveforms

ArbExpress software

NOTE. You can use ArbExpress to transfer waveform data to the instrument. When you transfer waveform data (.t_{fw} file), any part of the waveform outside of allowed limits in the Series 31000 AFG is automatically converted to be within the allowed range.

The following information and instructions are screen captures of the ArbExpress interface. This information shows you the basic operating procedures for using ArbExpress. For more information on ArbExpress, go to [ArbExpress® Signal Generator Software \(tek.com/product-software-series/arbexpress-signal-generator-software\)](http://tek.com/product-software-series/arbexpress-signal-generator-software).

Table 17: Operating ArbExpress

Description	
Menu bar	The menu bar provides access to the application functions. When you select a menu item, the application displays the associated dialog box or the menu selection causes an immediate action.
Toolbar	The toolbar buttons provide instant access to most features without having to navigate through several menus.
Shortcut View	The Shortcut View occupies the left part of the display. Use the Shortcut View to quickly access various functions provided by the application. Refer to the ArbExpress online help for more information.
Status bar	The status bar, located below the waveform and marker display, shows information about the application and the waveform.
Waveform display area	When you create or open a waveform, it is displayed in this area.
Marker area	Marker patterns appear in this area. You can toggle the display of markers by selecting Display > Marker from the menu bar.

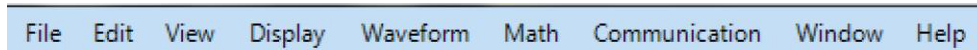

Figure 141: ArbExpress menu bar

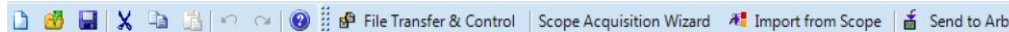

Figure 142: ArbExpress toolbar

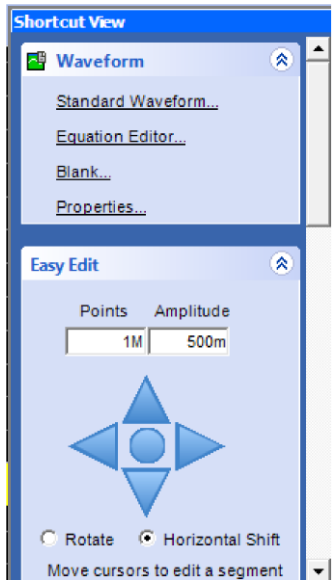

Figure 143: ArbExpress shortcut view



Figure 144: ArbExpress status bar

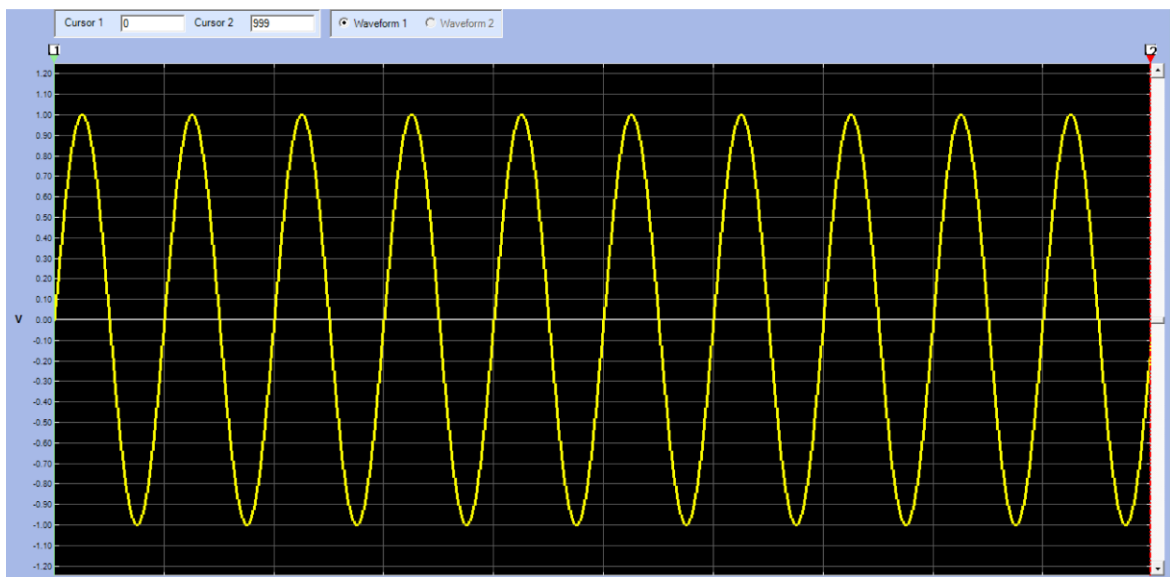

Figure 145: ArbExpress waveform display

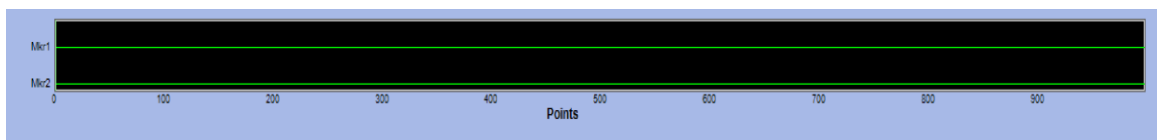

Figure 146: ArbExpress marker area

Basic operations

The following steps explain basic waveform creation and other useful functions that are available with ArbExpress.

To create a new waveform:

1. Use the **File** menu.
2. Select **Blank sheet** (a blank sheet with 1024 points waveform length opens; go to **Properties** to change the number of points).

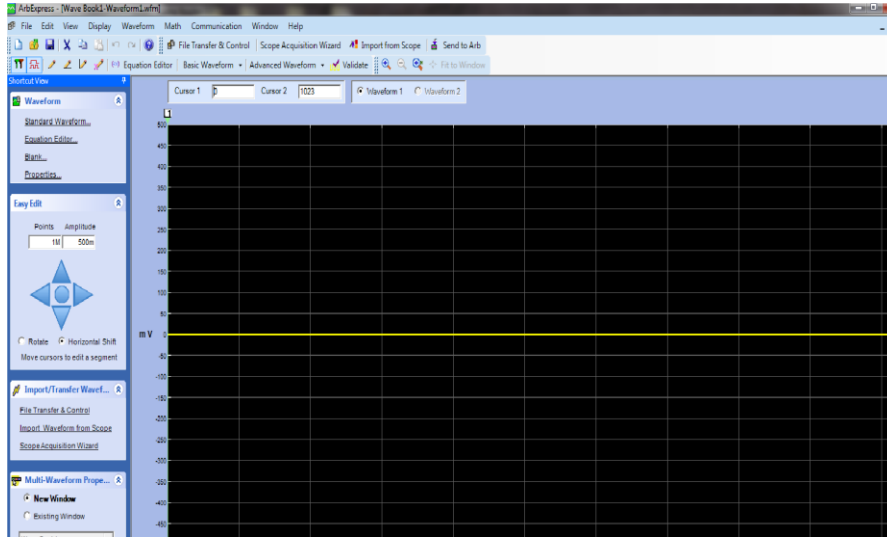

Figure 147: ArbExpress blank sheet

3. In the **Standard Waveform** dialog box, create any of the standard waveforms that are available.
4. Use **Settings** to select a waveform and instrument type.
5. Use **Vertical** to set the waveform vertical settings.
6. Use **Horizontal** to set the waveform horizontal settings.
7. Select **Preview** to view the waveform.

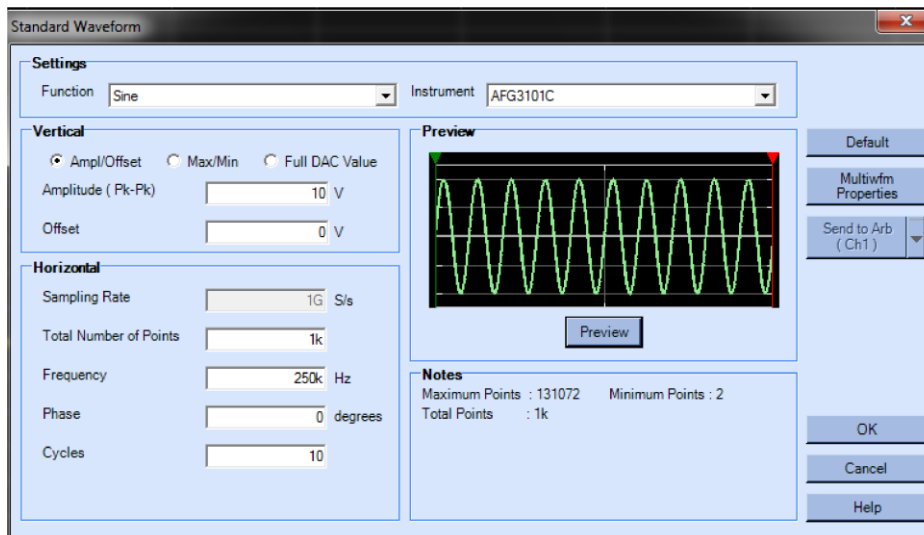
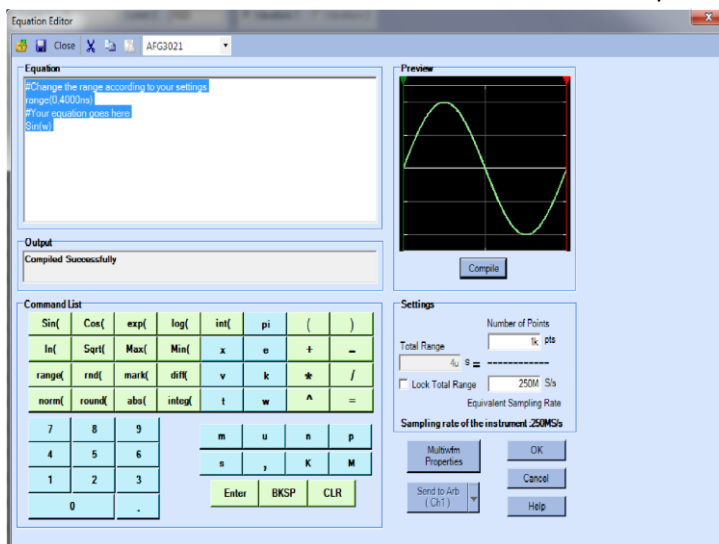

Figure 148: ArbExpress standard waveform

Alternatively, you can use the Equation Editor, Waveform Math, or remotely control an AWG or AFG to create a waveform.

The Equation Editor application provides a set of sample equations that you can directly use or modify.

1. Use the Command List to select the commands, functions, units, and operations.
2. View the waveform in the Preview area once the equation is compiled to verify your equation.

**Figure 149: ArbExpress equation editor**

The Waveform Math application provides a waveform library that you can use.

1. From the **Math** menu, select **Waveform Math** to display the Waveform Math dialog box.
2. Select a math source from Waveform Library. Select **Noise** in this example.

Calculation results are displayed in the Resultant Waveform pane. This is an example of adding noise to a square waveform.

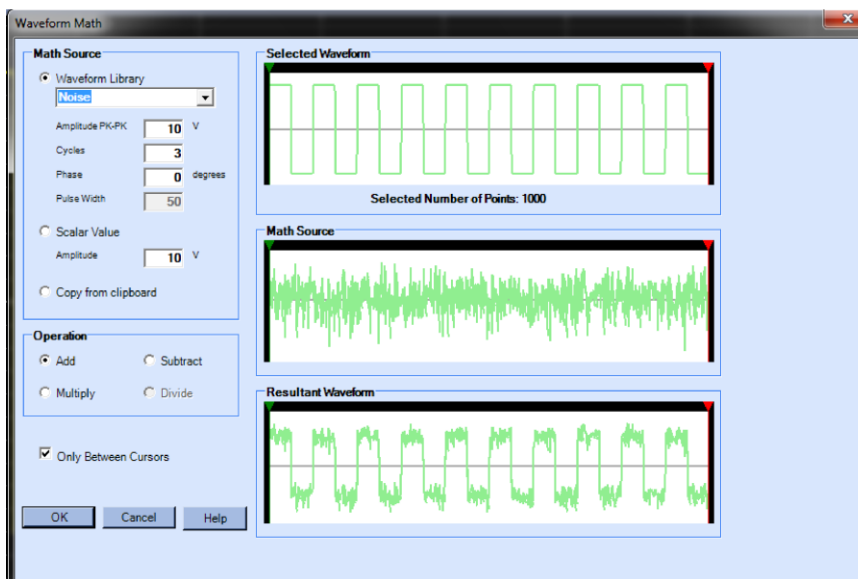
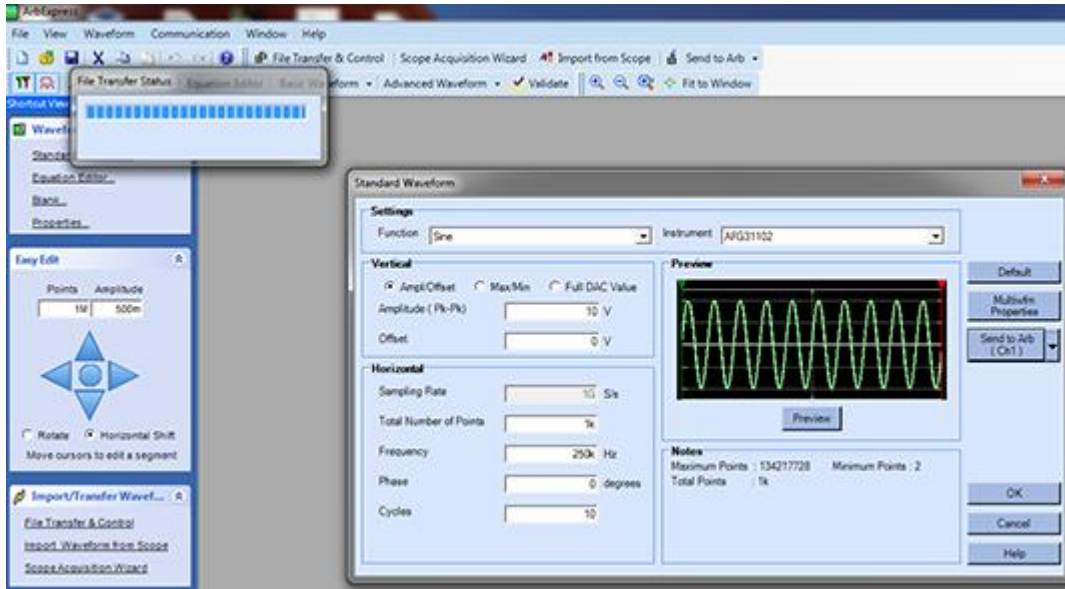

Figure 150: ArbExpress math application

The AWG/AFG File Transfer and Control provides remote control of your instrument. When you open the communication menu you will see the connected instruments in the Arb List.

NOTE. The Instrument Control pane appears only when an instrument is connected; otherwise it is hidden.

1. From the **Communication** menu, select **AWG/AFG File Transfer & Control** to display the dialog box.
2. Make settings changes for each connected instrument.

**Figure 151: ArbExpress Transfer**

Application examples

Application examples

This section contains a series of application examples. These simplified examples highlight the features of the instrument and give you ideas for using it to solve your own test problems.

Lissajous patterns

Use your Series 31000 AFG dual-channel model to create a Lissajous pattern and observe the waveforms with an oscilloscope.

To create a Lissajous pattern:

1. Connect the CH1 and CH2 outputs of the dual-channel instrument and the CH1 and CH2 Inputs of an oscilloscope with BNC cables.
2. Set the waveform parameters as follows:
 - **Function:** Sine
 - **RunMode:** Continuous
 - **Amplitude:** 1 V
 - **CH1 Frequency:** 400 kHz
 - **CH2 Frequency:** 500 kHz

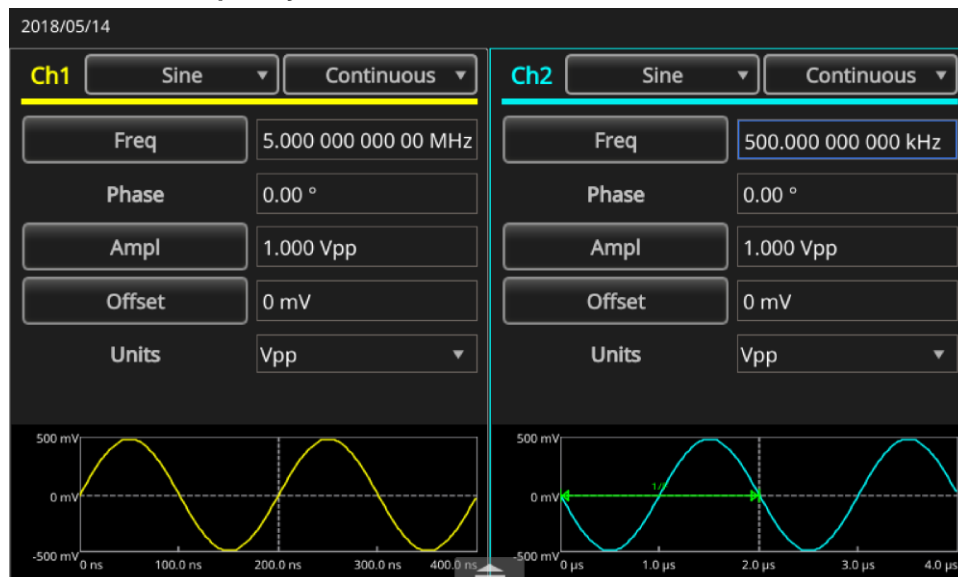

Figure 152: Set the waveform pattern

3. Set the oscilloscope display format to XY.
4. Adjust the amplitude so that the waveform is shown in the graticule. A Lissajous pattern is displayed.

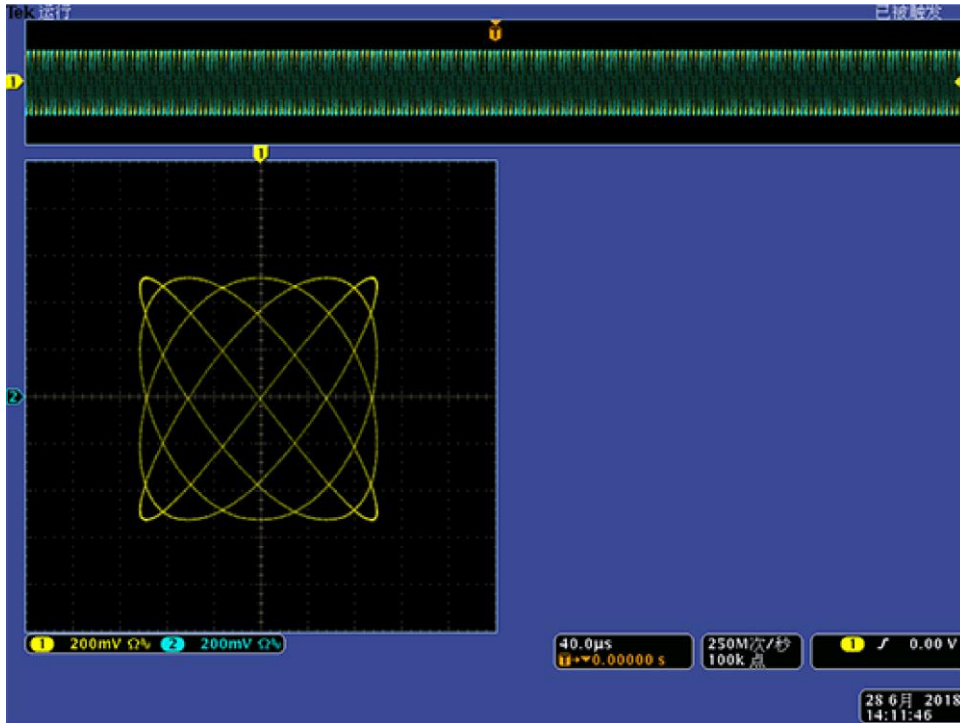

Figure 153: Lissajous Pattern Displayed

5. Change amplitude of AFG31K from 1 Vpp to 0.5 Vpp.

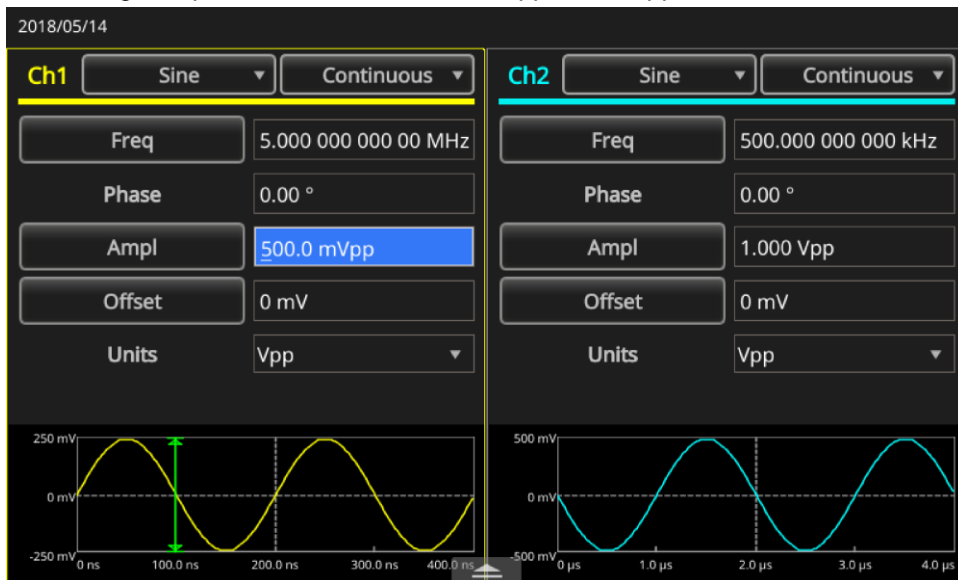

Figure 154: Lissajous pattern change displayed

6. Change the phase of CH1 to -19° .

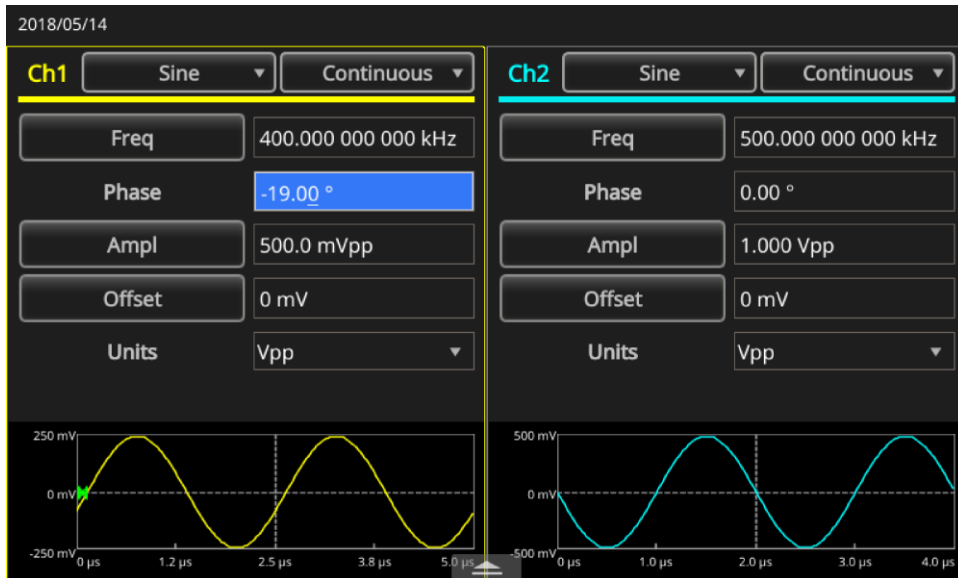

Figure 155: Change the phase CH1 to -19

7. Observe the Lissajous pattern change shape.

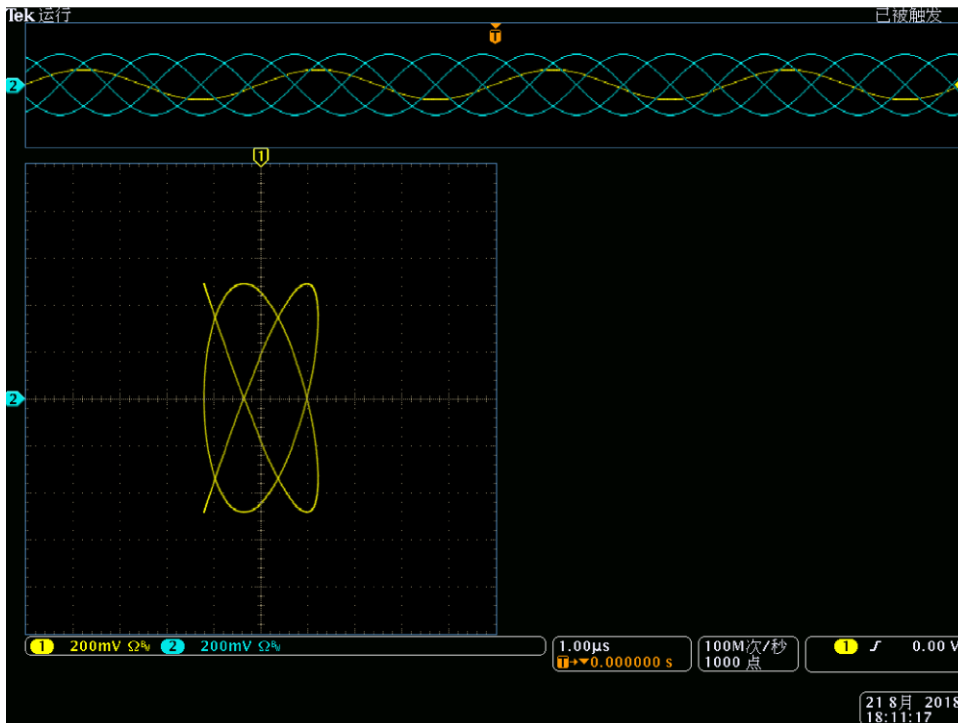

Figure 156: Lissajous pattern changes

Measurement of filter characteristics

Use the instrument sweep function to observe the frequency characteristics of the 50 Ω filter.

To observe frequency characteristics:

1. Connect the CH1 output of the instrument to an oscilloscope CH1 input with a BNC cable.
2. Connect the Trigger Output of the instrument to an external trigger input connector of an oscilloscope.
3. Set the oscilloscope input impedance to **50 Ω** .

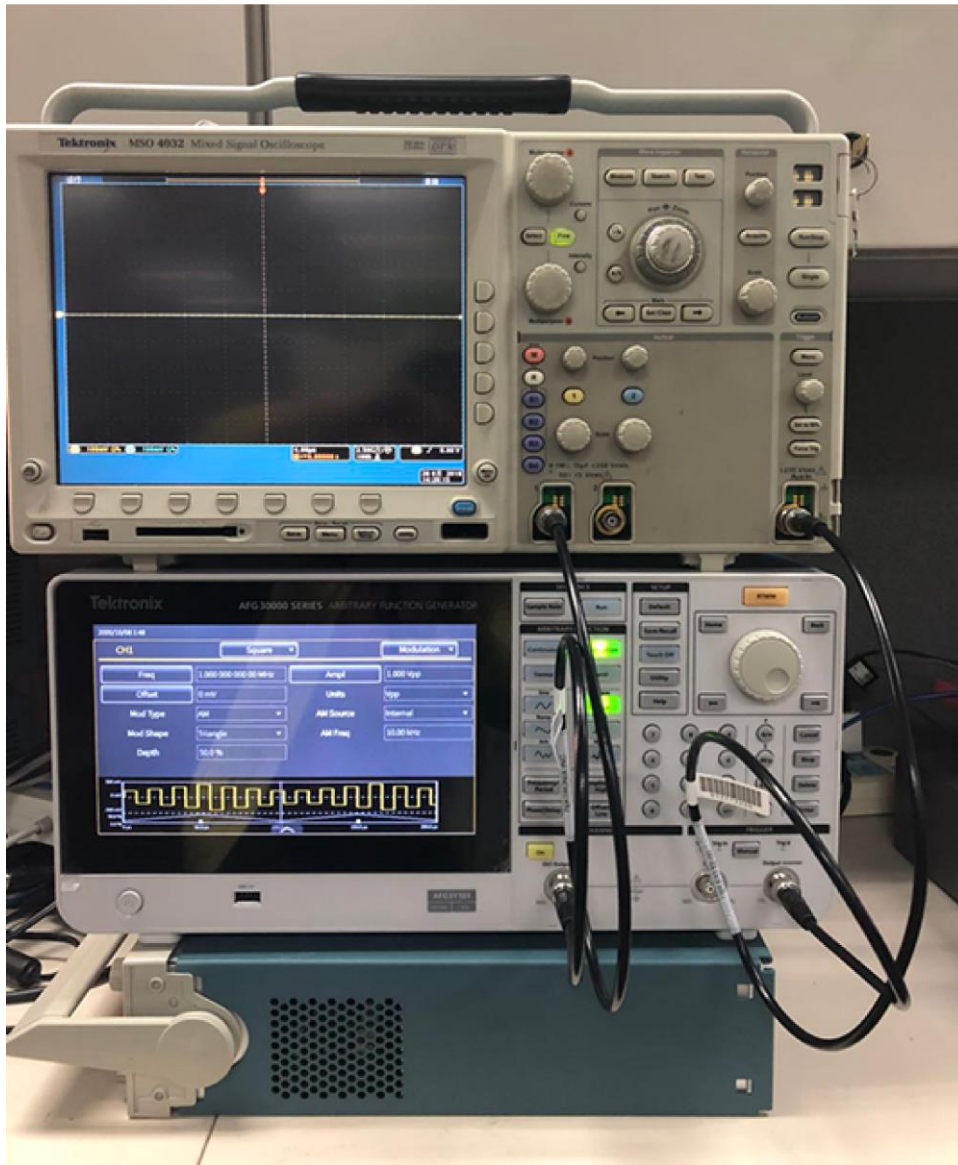

Figure 157: AFG31000 Series connected to an oscilloscope

4. Select **Sweep** from Run Mode area and set the start frequency, stop frequency, and sweep time so that the waveform is shown in the graticule.
5. You can measure the frequency characteristics of the filter by sweep time and the oscilloscope time base.

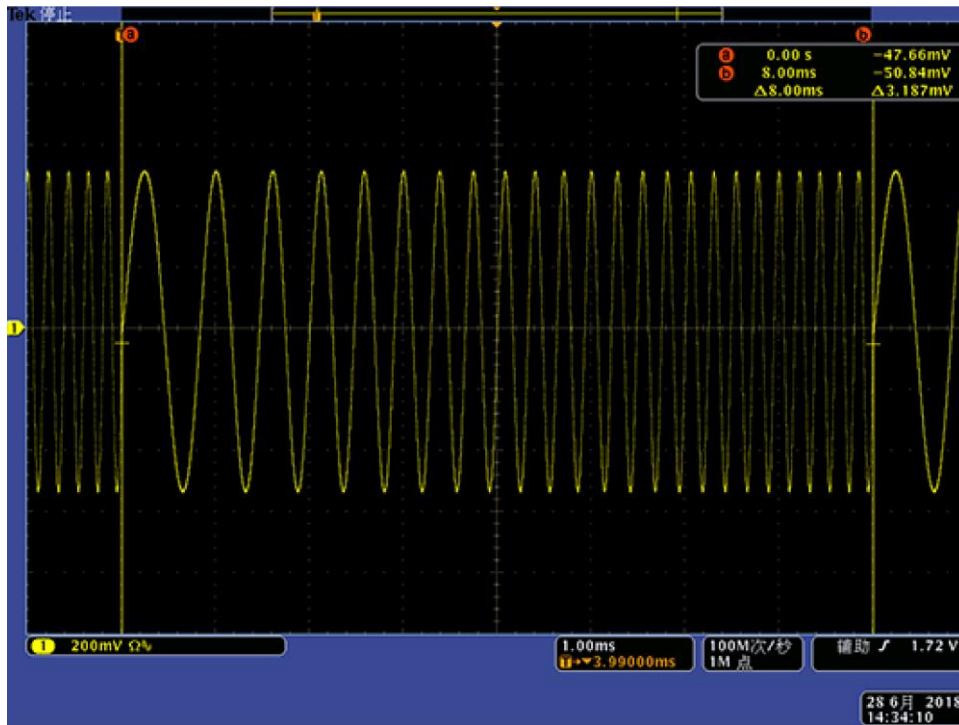

Figure 158: Measure frequency characteristics

Motor speed control by pulse-width modulation

Pulse-width modulation (PWM) is used for controlling the speed of a DC motor or the luminance of an LED (light emitting diode). Use the instrument PWM function to control the DC motor speed.

To control DC motor speed:

1. Connect the instrument output and a device under test (DUT) using a BNC-to-alligator clip adapter.
2. Select Pulse as an output waveform and then select PWM as a modulation type.
3. Set the frequency to 100 kHz.

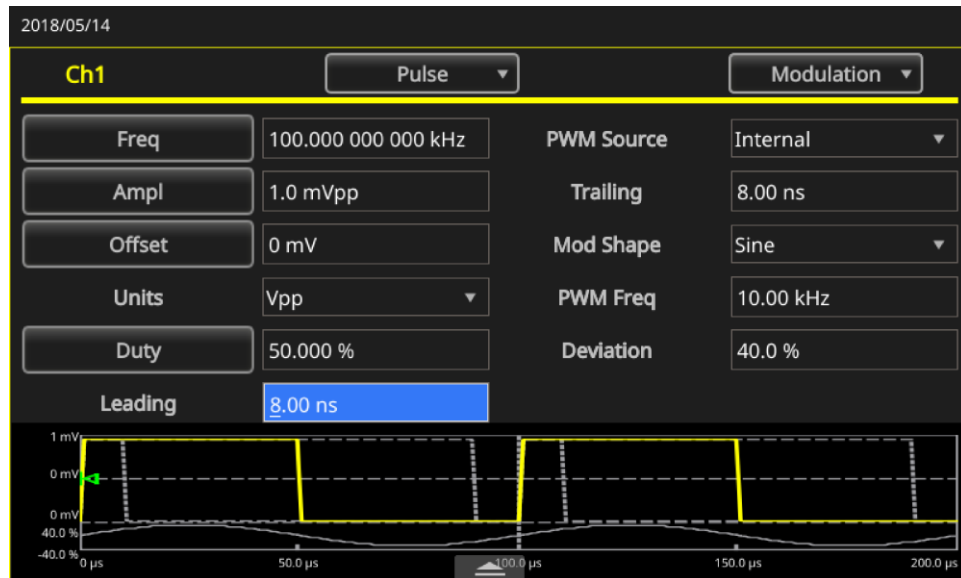

Figure 159: Duty rate changes motor speed

4. Connect the output to an oscilloscope.
5. Confirm that a pulse-width modulation waveform is displayed on the oscilloscope screen.
6. Select **Pulse Duty** and change the duty rate.
7. Observe that the motor speed changes if you change the duty rate.

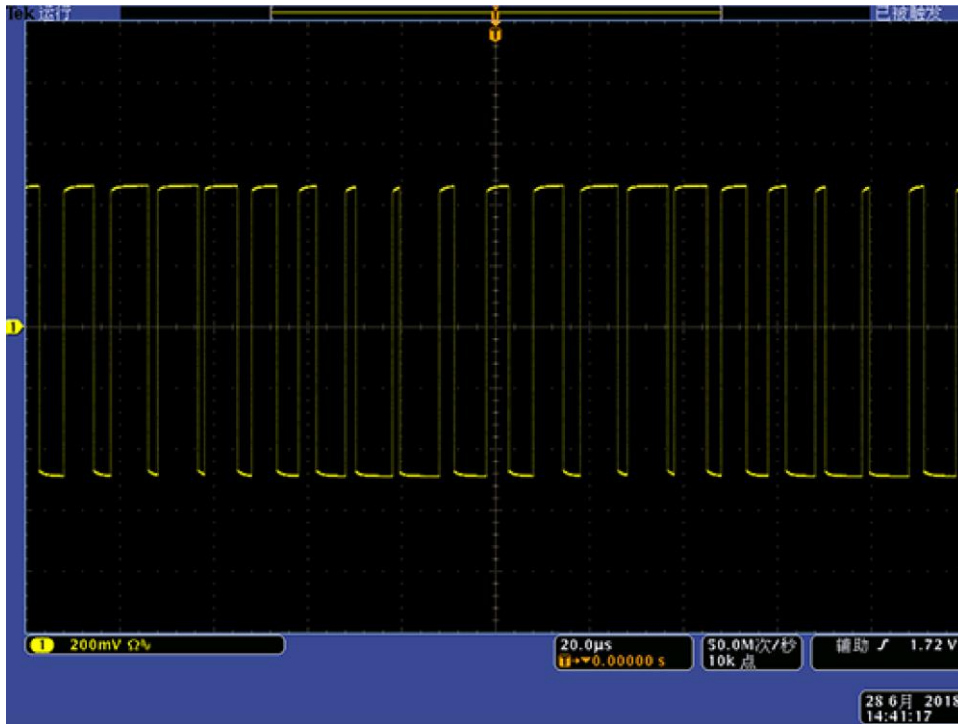

Figure 160: PWM

Carrier null (frequency modulation)

Use the instrument and a spectrum analyzer to observe a carrier waveform of frequency modulation.

To observe a carrier waveform

1. Select **Sine** as the output waveform and **FM** as the modulation type.
2. Set the following waveform parameters:
 - Carrier frequency: **1 MHz**
 - Modulation frequency: **2 kHz**

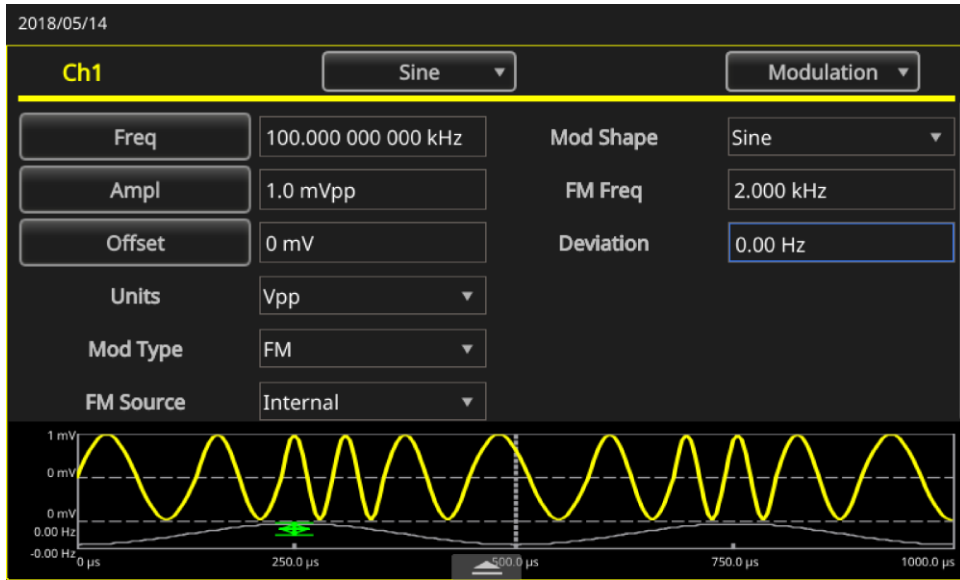

Figure 161: Carrier waveform frequencies

3. Set the deviation to **4.8096 kHz** (this will make the carrier waveform null).
4. Confirm the carrier waveform is null on the spectrum analyzer.

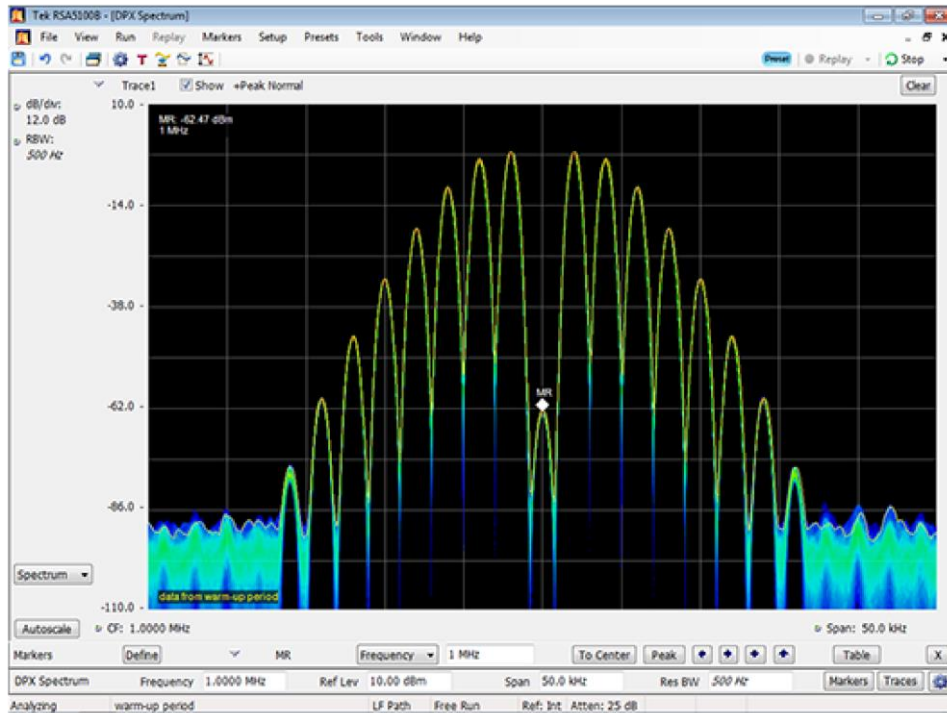

Figure 162: Carrier waveform null

Contact Information:

- Australia*** 1 800 709 465
- Austria** 00800 2255 4835
- Balkans, Israel, South Africa and other ISE Countries** +41 52 675 3777
- Belgium*** 00800 2255 4835
- Brazil** +55 (11) 3759 7627
- Canada** 1 800 833 9200
- Central East Europe / Baltics** +41 52 675 3777
- Central Europe / Greece** +41 52 675 3777
- Denmark** +45 80 88 1401
- Finland** +41 52 675 3777
- France*** 00800 2255 4835
- Germany*** 00800 2255 4835
- Hong Kong** 400 820 5835
- India** 000 800 650 1835
- Indonesia** 007 803 601 5249
- Italy** 00800 2255 4835
- Japan** 81 (3) 6714 3010
- Luxembourg** +41 52 675 3777
- Malaysia** 1 800 22 55835
- Mexico, Central/South America and Caribbean** 52 (55) 56 04 50 90
- Middle East, Asia, and North Africa** +41 52 675 3777
- The Netherlands*** 00800 2255 4835
- New Zealand** 0800 800 238
- Norway** 800 16098
- People's Republic of China** 400 820 5835
- Philippines** 1 800 1601 0077
- Poland** +41 52 675 3777
- Portugal** 80 08 12370
- Republic of Korea** +82 2 6917 5000
- Russia / CIS** +7 (495) 6647564
- Singapore** 800 6011 473
- South Africa** +41 52 675 3777
- Spain*** 00800 2255 4835
- Sweden*** 00800 2255 4835
- Switzerland*** 00800 2255 4835
- Taiwan** 886 (2) 2656 6688
- Thailand** 1 800 011 931
- United Kingdom / Ireland*** 00800 2255 4835
- USA** 1 800 833 9200
- Vietnam** 12060128

* European toll-free number. If not accessible, call: +41 52 675 3777

Find more valuable resources at TEK.COM

