

Models 2450-EC, 2460-EC, and 2461-EC Potentiostats and Galvanostats

User's Manual

077110402 / November 2016



077110402

Models 2450-EC, 2460-EC, and 2461-EC

Potentiostats And Galvanostats

User's Manual

© 2016, Keithley Instruments

Cleveland, Ohio, U.S.A.

All rights reserved.

Any unauthorized reproduction, photocopy, or use of the information herein, in whole or in part, without the prior written approval of Keithley Instruments is strictly prohibited.

All Keithley Instruments product names are trademarks or registered trademarks of Keithley Instruments. Other brand names are trademarks or registered trademarks of their respective holders.

The Lua 5.0 software and associated documentation files are copyright © 1994 - 2015, Lua.org, PUC-Rio. You can access terms of license for the Lua software and associated documentation at the Lua licensing site (<http://www.lua.org/license.html>).

Microsoft, Visual C++, Excel, and Windows are either registered trademarks or trademarks of Microsoft Corporation in the United States and/or other countries.

Document number: 077110402 / November 2016

The following safety precautions should be observed before using this product and any associated instrumentation. Although some instruments and accessories would normally be used with nonhazardous voltages, there are situations where hazardous conditions may be present.

This product is intended for use by qualified personnel who recognize shock hazards and are familiar with the safety precautions required to avoid possible injury. Read and follow all installation, operation, and maintenance information carefully before using the product. Refer to the user documentation for complete product specifications.

If the product is used in a manner not specified, the protection provided by the product warranty may be impaired.

The types of product users are:

Responsible body is the individual or group responsible for the use and maintenance of equipment, for ensuring that the equipment is operated within its specifications and operating limits, and for ensuring that operators are adequately trained.

Operators use the product for its intended function. They must be trained in electrical safety procedures and proper use of the instrument. They must be protected from electric shock and contact with hazardous live circuits.

Maintenance personnel perform routine procedures on the product to keep it operating properly, for example, setting the line voltage or replacing consumable materials. Maintenance procedures are described in the user documentation. The procedures explicitly state if the operator may perform them. Otherwise, they should be performed only by service personnel.

Service personnel are trained to work on live circuits, perform safe installations, and repair products. Only properly trained service personnel may perform installation and service procedures.

Keithley Instruments products are designed for use with electrical signals that are measurement, control, and data I/O connections, with low transient overvoltages, and must not be directly connected to mains voltage or to voltage sources with high transient overvoltages. Measurement Category II (as referenced in IEC 60664) connections require protection for high transient overvoltages often associated with local AC mains connections. Certain Keithley Instruments measuring instruments may be connected to mains. These instruments will be marked as category II or higher.

Unless explicitly allowed in the specifications, operating manual, and instrument labels, do not connect any instrument to mains.

Exercise extreme caution when a shock hazard is present. Lethal voltage may be present on cable connector jacks or test fixtures. The American National Standards Institute (ANSI) states that a shock hazard exists when voltage levels greater than 30 V RMS, 42.4 V peak, or 60 VDC are present. A good safety practice is to expect that hazardous voltage is present in any unknown circuit before measuring.

Operators of this product must be protected from electric shock at all times. The responsible body must ensure that operators are prevented access and/or insulated from every connection point. In some cases, connections must be exposed to potential human contact. Product operators in these circumstances must be trained to protect themselves from the risk of electric shock. If the circuit is capable of operating at or above 1000 V, no conductive part of the circuit may be exposed.

Do not connect switching cards directly to unlimited power circuits. They are intended to be used with impedance-limited sources. NEVER connect switching cards directly to AC mains. When connecting sources to switching cards, install protective devices to limit fault current and voltage to the card.

Before operating an instrument, ensure that the line cord is connected to a properly-grounded power receptacle. Inspect the connecting cables, test leads, and jumpers for possible wear, cracks, or breaks before each use.

When installing equipment where access to the main power cord is restricted, such as rack mounting, a separate main input power disconnect device must be provided in close proximity to the equipment and within easy reach of the operator.

For maximum safety, do not touch the product, test cables, or any other instruments while power is applied to the circuit under test. ALWAYS remove power from the entire test system and discharge any capacitors before: connecting or disconnecting cables or jumpers, installing or removing switching cards, or making internal changes, such as installing or removing jumpers.

Do not touch any object that could provide a current path to the common side of the circuit under test or power line (earth) ground. Always make measurements with dry hands while standing on a dry, insulated surface capable of withstanding the voltage being measured.

For safety, instruments and accessories must be used in accordance with the operating instructions. If the instruments or accessories are used in a manner not specified in the operating instructions, the protection provided by the equipment may be impaired.

Do not exceed the maximum signal levels of the instruments and accessories. Maximum signal levels are defined in the specifications and operating information and shown on the instrument panels, test fixture panels, and switching cards.

When fuses are used in a product, replace with the same type and rating for continued protection against fire hazard.

Chassis connections must only be used as shield connections for measuring circuits, NOT as protective earth (safety ground) connections.

If you are using a test fixture, keep the lid closed while power is applied to the device under test. Safe operation requires the use of a lid interlock.

If a  screw is present, connect it to protective earth (safety ground) using the wire recommended in the user documentation.

The  symbol on an instrument means caution, risk of danger. The user must refer to the operating instructions located in the user documentation in all cases where the symbol is marked on the instrument.

The  symbol on an instrument means caution, risk of electric shock. Use standard safety precautions to avoid personal contact with these voltages.

The  symbol on an instrument shows that the surface may be hot. Avoid personal contact to prevent burns.

The  symbol indicates a connection terminal to the equipment frame.

If this  symbol is on a product, it indicates that mercury is present in the display lamp. Please note that the lamp must be properly disposed of according to federal, state, and local laws.

The **WARNING** heading in the user documentation explains dangers that might result in personal injury or death. Always read the associated information very carefully before performing the indicated procedure.

The **CAUTION** heading in the user documentation explains hazards that could damage the instrument. Such damage may invalidate the warranty.

Instrumentation and accessories shall not be connected to humans.

Before performing any maintenance, disconnect the line cord and all test cables.

To maintain protection from electric shock and fire, replacement components in mains circuits — including the power transformer, test leads, and input jacks — must be purchased from Keithley Instruments. Standard fuses with applicable national safety approvals may be used if the rating and type are the same. The detachable mains power cord provided with the instrument may only be replaced with a similarly rated power cord. Other components that are not safety-related may be purchased from other suppliers as long as they are equivalent to the original component (note that selected parts should be purchased only through Keithley Instruments to maintain accuracy and functionality of the product). If you are unsure about the applicability of a replacement component, call a Keithley Instruments office for information.

Unless otherwise noted in product-specific literature, Keithley Instruments instruments are designed to operate indoors only, in the following environment: Altitude at or below 2,000 m (6,562 ft); temperature 0 °C to 50 °C (32 °F to 122 °F); and pollution degree 1 or 2.

To clean an instrument, use a damp cloth or mild, water-based cleaner. Clean the exterior of the instrument only. Do not apply cleaner directly to the instrument or allow liquids to enter or spill on the instrument. Products that consist of a circuit board with no case or chassis (e.g., a data acquisition board for installation into a computer) should never require cleaning if handled according to instructions. If the board becomes contaminated and operation is affected, the board should be returned to the factory for proper cleaning/servicing.

Safety precaution revision as of March 2016.

Table of Contents

Introduction.....	1-1
Introduction	1-1
Getting started.....	1-2
Configure the SMU Instrument for TSP® scripts.....	1-3
Select the high-impedance, output-off state.....	1-3
Copy a script to the instrument.....	1-4
Cable assembly details	1-5
Connections and usage	1-6
Make the SMU connections	1-6
Make the device connections.....	1-7
Attach the alligator clips	1-8
Prepare the analyte and assemble the test cell.....	1-8
Connect to the DUT	1-8
Home and Menu screen overview.....	1-9
Cyclic Voltammetry.....	2-1
Cyclic Voltammetry	2-1
Test application parameters.....	2-2
Run the Cyclic Voltammetry test application	2-3
Review the Menu controls.....	2-4
Define the potential scan parameters.....	2-5
Define the Scan Settings.....	2-7
Select the Sampling Rate Units, Sampling Rate, and Current Range.....	2-8
Save or load the test parameter data	2-10
Run the test and view the graph.....	2-12
Acquire the open circuit potential (Eoc).....	2-13
Save the test data to the flash drive.....	2-14
View the results saved to the flash drive	2-14
View the test reading table	2-14
View the Event Log	2-15
End the test application.....	2-15
Cyclic Voltammetry theory.....	2-16
Open Circuit Potential	3-1
Open Circuit Potential	3-1
Test application parameters.....	3-2
Run the Open Circuit Potential test application	3-2
Review the Menu controls.....	3-3
Adjust the Measure Settings	3-4
Save or load the test parameter data	3-6
Run the test and view the graph.....	3-7
Save the test data to the flash drive	3-8
View the results saved to the flash drive	3-9
View the Reading Table or measurement Statistics.....	3-9
View the Event Log	3-10
End the test application.....	3-10
Potential Pulse & Square Wave	4-1
Potential Pulse and Square Wave	4-1
Test application parameters.....	4-2

Run the Potential Pulse and Square Wave test application	4-3
Review the Menu controls	4-4
Configure the Pulse Settings.....	4-4
Adjust the End Conditions.....	4-8
Save or load the test parameter data	4-9
Run the test and view the graph.....	4-11
Save the test data to the flash drive	4-12
View the results saved to the flash drive	4-12
View the Reading Table or measurement Statistics.....	4-12
View the Event Log	4-13
End the test application.....	4-13

Current Pulse and Square Wave..... 5-1

Current Pulse and Square Wave	5-1
Test application parameters.....	5-2
Run the Current Pulse and Square Wave test application	5-3
Review the Menu controls.....	5-4
Configure the Pulse Settings.....	5-4
Adjust the End Conditions.....	5-7
Save or load the test parameter data	5-9
Run the test and view the graph.....	5-10
Save the test data to the flash drive	5-11
View the results saved to the flash drive	5-12
View the Reading Table or measurement Statistics.....	5-12
View the Event Log	5-13
End the test application.....	5-13

Chronoamperometry 6-1

Chronoamperometry	6-1
Test application parameters.....	6-2
Run the Chronoamperometry test application.....	6-2
Review the Menu controls.....	6-4
Configure the Step and Measure Settings	6-4
Save or load the test parameter data	6-7
Run the test and view the graph.....	6-9
Save the test data to the flash drive	6-10
View the results saved to the flash drive	6-10
View the Reading Table or measurement Statistics.....	6-10
View the Event Log	6-11
End the test application.....	6-11

Chronopotentiometry 7-1

Chronopotentiometry.....	7-1
Test application parameters.....	7-2
Run the Chronopotentiometry test application	7-2
Review the Menu controls.....	7-4
Configure the Step and Measure Settings	7-4
Save or load the test parameter data	7-7
Run the test and view the graph.....	7-9
Save the test data to the flash drive	7-10
View the results saved to the flash drive	7-10
View the Reading Table or measurement Statistics.....	7-10
View the Event Log	7-11
End the test application.....	7-11

Introduction

In this section:

Introduction	1-1
Getting started.....	1-2
Cable assembly details	1-5
Connections and usage	1-6

Introduction

The Keithley Instruments Models 2450-EC, 2460-EC, and 2461-EC Potentiostat/Galvanostat systems are alternatives to traditional electrochemistry potentiostats and galvanostats. Your instrument features a full-color, high-resolution touchscreen, which lets you configure tests and immediately view results.

The following electrochemistry test applications are loaded in the memory of your instrument:

- **Cyclic Voltammetry:** Potential is swept at a user-programmable scan rate between two to four defined potential vertices, and the resulting current is measured at specified intervals during the sweep.
- **Open Circuit Potential:** Measures the cell potential difference between two electrodes with high input impedance as a function of time.
- **Potential Pulse and Square Wave with Current Measure:** Sources potential at programmable peak and base levels. The resulting current at the pulse peak level is recorded.
- **Current Pulse and Square Wave with Potential Measure:** Sources current at programmable peak and base levels. The resulting potential at the pulse peak level is recorded.
- **Chronoamperometry:** Potential is stepped to a programmed value and the resulting current is measured as a function of time.
- **Chronopotentiometry:** Current is stepped to a programmed value and the resulting potential is measured as a function of time.

WARNING

This kit is not intended to be used with a SMU interlock enabled. To prevent electric shock and possible damage to the test cable assembly or test setup, do not activate the Keithley Instruments 2450, 2460, or 2461 interlock.

When the interlock is not engaged on the 2450, 2460, or 2461 the nominal output is limited to ± 42 V. However, review the "Safety Precautions" section of this document to ensure responsible operation.

Getting started

In addition to your SourceMeter instrument, you should have received the following items:

- One electrochemistry interface cable that connects the instrument to a 2-, 3-, or 4-terminal electrochemical cell
- Four insulated miniature alligator clips
- One flash drive that contains the test applications and supporting documentation.
- Six electrochemistry test applications

Before you can run an electrochemistry test, you will need to configure the instrument and make basic connections. The following topics will explain how to set up and configure your instrument.

NOTE

The 2450-EC or 2460-EC instrument must have firmware version 1.5.0 or later to run the electrochemistry test applications. The 2461-EC must have firmware version 1.6.0 or later.

To view the firmware version, press the **MENU** key, then select **Info/Manage** under System. The firmware version is at the upper-left of your display. The latest firmware is available from the [Keithley Instruments website](http://www.tek.com/keithley) (<http://www.tek.com/keithley>).

The following files are loaded onto the flash drive:

File	Description
CyclicVoltammetry.tsp	Application to perform Cyclic Voltammetry
OpenCircuitPotential.tsp	Application to measure the open circuit potential
Chronoamperometry.tsp	Application to measure the current as a function of time at a constant potential
Chronopotentiometry.tsp	Application to measure the potential as a function of time at a constant current
CurrentPulseAndSquareWave.tsp	Application to output a current pulse or square wave while measuring the potential
PotentialPulseAndSquareWave.tsp	Application to output a current pulse or square wave while measuring the current
EC_Images.tsp	Potentiostat application images.
EC_Framework.tsp	Potentiostat application framework.
07711040x_2450-EC.pdf	Models 2450-EC, 2460-EC, and 2461-EC Potentiostats User's Manual (this document)
07134730x_ECHEM-KIT.pdf	SMU Potentiostats and EC-UPGRADE Kit Quick Start Guide

Configure the SMU Instrument for TSP® scripts

Make sure to select the TSP command set on your SourceMeter Instrument before running test scripts on your instrument. You only need to select the TSP command set once.

To select the TSP command set:

1. Press the **MENU** key.
2. Under System, select **Settings**.
3. Select **Command Set**.
4. Choose **TSP**.
5. At the prompt to reboot, select **Yes**.

Select the high-impedance, output-off state

Before making physical connections from the instrument to the test cell, set the output of the instrument to the high-impedance, output-off state. When the high-impedance output-off state is selected, the output relay opens, disconnecting the instrument from the load.

To set the output of your SMU to the high-impedance, output-off state:

1. Press the **MENU** key.
2. Under Source, select **Settings**.
3. Select **Output Off**.
4. Choose **High Z** (high impedance).

NOTE

You may receive a notification about making measurements with the output turned off. Select **OK** to clear the message, or select **Details** to see more information.

Copy a script to the instrument

Your SMU is shipped with all test applications and supporting scripts loaded into memory.

NOTE

If you accidentally delete a test application or a supporting script (`EC_Framework.tsp` or `EC_Images.tsp`), you can copy the files from the flash drive to your instrument.

If you are upgrading your SMU with the EC-UPGRADE kit, you can run the test applications from the flash drive or copy the files from the flash drive to the instrument. If you choose to copy the applications, you must also copy the support files (`EC_Framework.tsp` and `EC_Images.tsp`) to your SMU.

To copy a script to the SMU:

1. Insert the USB flash drive into the USB port on the front panel.
2. Press the **MENU** key.
3. Under Scripts, select **Manage**. The Manage Scripts menu opens. Your list of Internal Scripts may appear different.

Figure 1: Manage Scripts menu

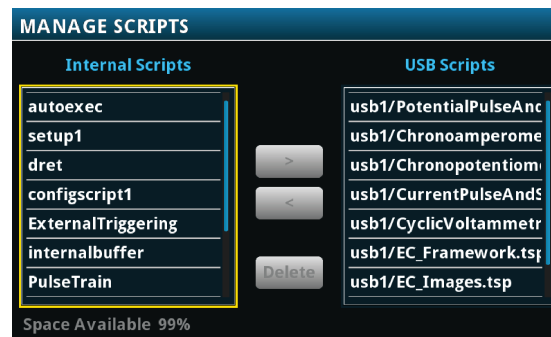

4. In the USB Scripts list, select the test script you want to copy to the SMU. For this example, you will copy the Cyclic Voltammetry test script.

Figure 2: Selecting the test script to be copied

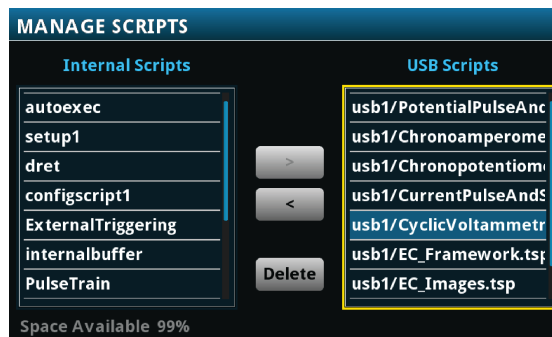

5. Select <. The test script is transferred to the instrument, and the corresponding filename is displayed in the Internal Scripts list.

Figure 3: Copying the file to the instrument

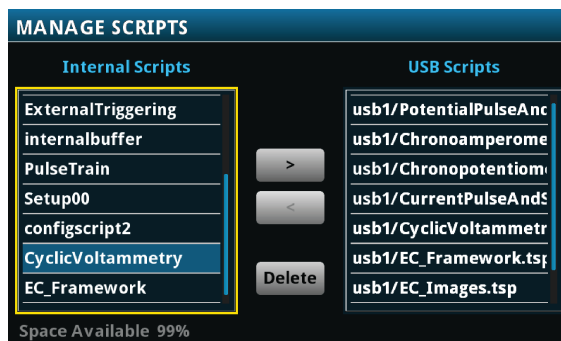

Cable assembly details

The cable is an electrically-shielded 1 m (39.37 in.) assembly with stackable, safety banana plugs on both ends. This cable simplifies the connections between your SMU potentiostat or galvanostat and an electrochemical test cell.

Figure 4: ECHM accessory cable dimensions

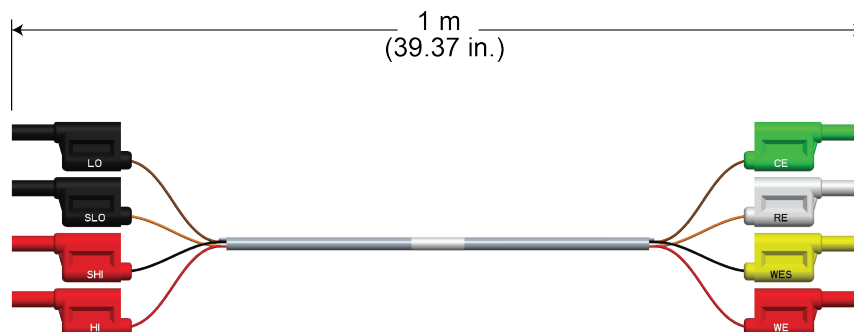

Electrical characteristics

Maximum voltage (assembly):	42 V
Maximum current (assembly):	7 A on HI and LO, less than 1 mA on SHI and SLO

Connections and usage

The cable assembly can be used with Keithley SMUs for electrochemistry applications. Each connector of the assembly is labeled according to its function:

Figure 5: Cable assembly connector labels and definitions



Make the SMU connections

Connect to the instrument (all tests):

The front panel of your SMU has four banana-style input and output jacks. You use the supplied cable to connect your electrochemical cell to these jacks.

The **SENSE** terminals are used to measure voltage at the device under test (DUT). When you use sense leads, the voltage drop across the force leads is eliminated from a measurement. This produces more accurate voltage sourcing and measurement at the DUT. Plug the SHI and SLO connectors into the SENSE terminals.

The **FORCE** terminals are used to source or sink voltage or current to or from a DUT. Plug the HI and LO connectors into the FORCE terminals.

Plug the four SMU-side cable connectors into the front of your SMU instrument as shown in the below graphic.

Figure 6: Connecting SMU-side cable connectors to the SMU front-panel inputs

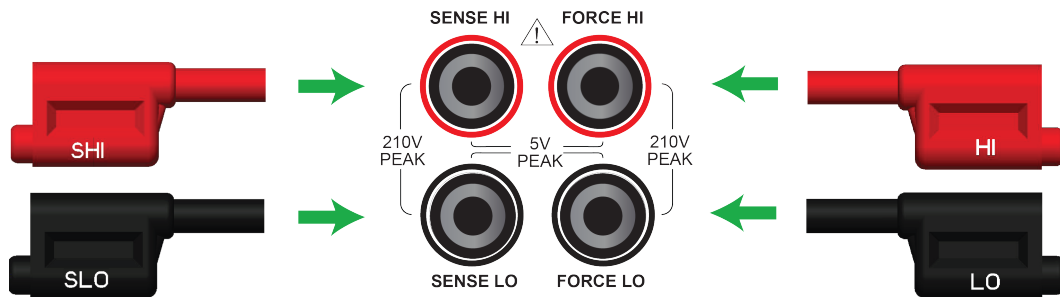

Make the device connections

The test cable lets you make connections to test cells with two, three, or four electrodes.

For two-electrode applications, the device-side cable connectors are used in stacked pairs. Connect the WE and WES pair to the working electrode of your electrochemical cell, and connect the CE and RE pair to the counter electrode of the cell.

Figure 7: Two-electrode cell testing cable connections

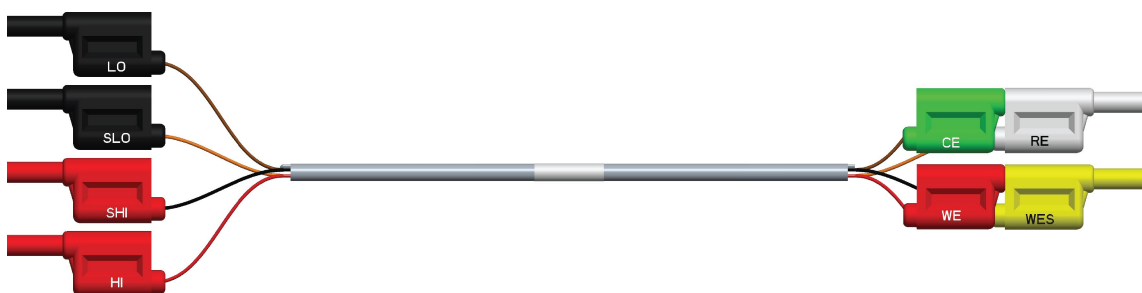

For three-electrode applications, the WE and WES connectors are stacked and attached to the working electrode. The CE and RE connectors connect to the counter electrode and reference electrode, respectively.

Figure 8: Three-electrode cell testing cable connections

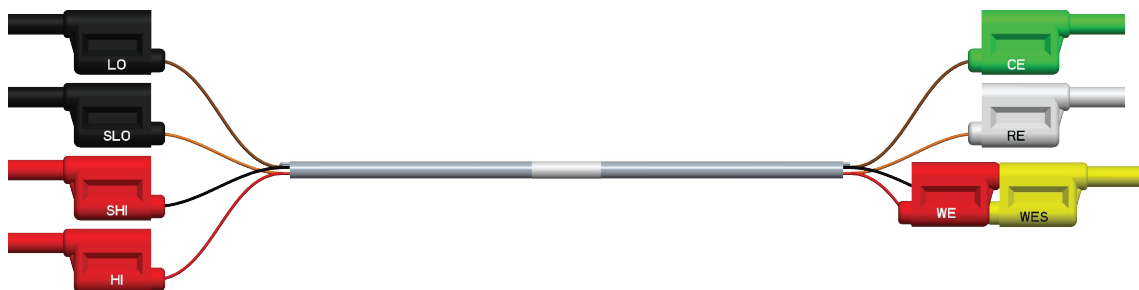

For four-electrode applications, each device-side cable connector is used separately.

Figure 9: Four-electrode cell testing cable connections

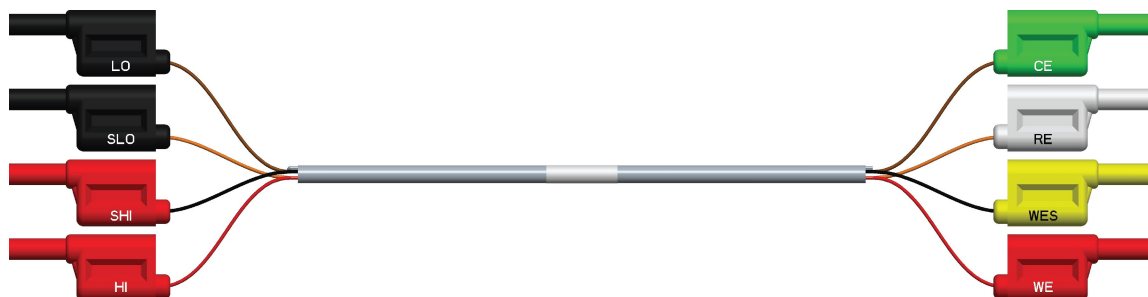

Attach the alligator clips

Four insulated alligator clips are supplied. You can attach these clips to the ends of the device-side connectors, as shown in the following graphic. The clips provide a safe, secure way to connect to your device.

Figure 10: Alligator clip attached to accessory cable connector

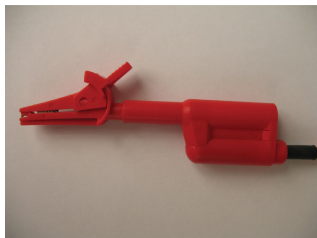

For small cells and electrodes, you can use commercially available banana-to-microclip connectors by plugging them directly into the cable connectors.

Once the appropriate connectors or clips are attached, you are ready to connect to the test cell.

Prepare the analyte and assemble the test cell

Connect to the DUT

The next figure shows the connections from a SMU to a three-electrode test cell.

Figure 11: Front panel connections

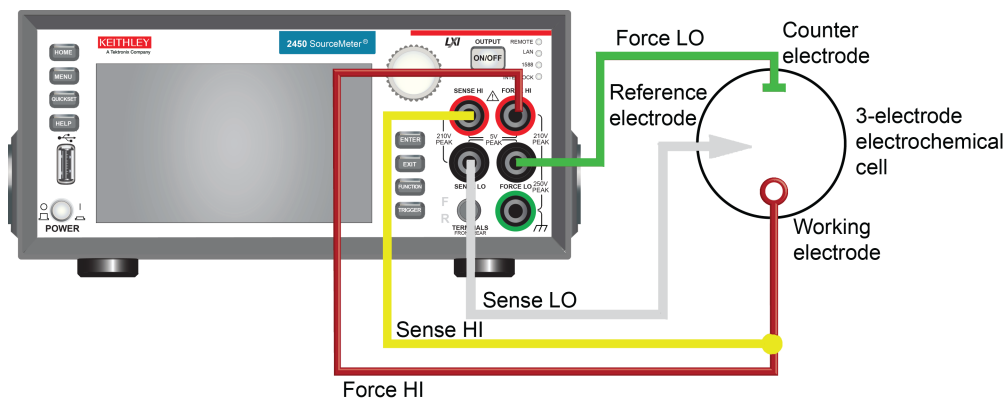

Home and Menu screen overview

Before you run a test application, the default Home and Menu screens of your SourceMeter instrument appear like those in the next graphic. Press the **HOME** or **MENU** keys on your instrument to access these screens.

Figure 12: SMU Home and Menu screens in standard mode



When you run an electrochemistry test application, the default Home and Menu screens are replaced by application-specific Home and Menu screens. These screens vary, depending on the potentiostat or galvanostat test application. You can access these screens with the **HOME** and **MENU** keys. You will see examples of these screens later in this manual.

NOTE

When a test application is running, you must select End App to exit the test and return to normal SMU operation.

For more information on using your SMU, see your *Interactive SourceMeter® Instrument Reference Manual*.

Cyclic Voltammetry

In this section:

[Cyclic Voltammetry](#) 2-1

Cyclic Voltammetry

Cyclic Voltammetry, a type of potential sweep method, is the most commonly-used measurement electrochemical technique.

In a Cyclic Voltammetry experiment, the working electrode potential is ramped linearly versus time. The current that flows through the circuit is measured. The resulting I-V data provides important electrochemical properties about the analyte under investigation.

You can make Cyclic Voltammetry measurements from the front panel of the instrument using the Cyclic Voltammetry test application.

The Cyclic Voltammetry test application has adjustable parameter settings and enables real-time graphing of a voltammogram on the display of the SMU potentiostat without using a computer. Test parameters are input at source and measure setting screens that the user selects from an application-specific menu. After the test executes, the data can be stored on a flash drive inserted in the USB port on the front panel of the instrument.

The following topics describe how to set up and run the `CyclicVoltammetry.tsp` test application.

NOTE

To ensure proper instrument operation, the potential difference between the reference electrode (RE) and counter electrode (CE) terminals and between the working electrode (WE) and working electrode sense (WES) terminals should not exceed 5 V.

Test application parameters

CAUTION

You must enter test parameters that are consistent with the following values. Otherwise, you may receive unsettled and inaccurate measurements.

The Cyclic Voltammetry test application parameters are listed below.

Model 2450-EC

- Potential range: $-20\text{ V} \leq E \leq +20\text{ V}$
- Current measure ranges: 10 μA , 100 μA , 1 mA, 10 mA, 100 mA, 1 A
- Source limit (compliance): 100 % of selected current range
- Scan rate: 0.1 mV per second to 3500 mV per second
- Potential step size during scanning:
 - 100 μV ($0.1\text{ mV per second} \leq \text{scan rate} < 35\text{ mV per second}$)
 - 1 mV ($35\text{ mV per second} \leq \text{scan rate} < 350\text{ mV per second}$)
 - 10 mV ($350\text{ mV per second} \leq \text{scan rate} \leq 3500\text{ mV per second}$)
- Number of cycles: 1 to 100
- User-selectable sampling intervals:
 - Points per test (10 to 10,000)
 - Points per cycle (10 to 10,000)
 - Seconds per point (.01 to 100)
 - Points per second (.01 to 100)
- Maximum total number of samples: 100,000

Models 2460-EC and 2461-EC

- Potential range: $-20\text{ V} \leq E \leq +20\text{ V}$
- Current measure ranges: 1 mA, 10 mA, 100 mA, 1 A, 4 A, 5 A, 7 A
- Source limit (compliance): 100 % of selected current range
- Scan rate: 0.1 mV per second to 3500 mV per second
- Potential step size during scanning:
 - 100 μV ($0.1\text{ mV per second} \leq \text{scan rate} < 35\text{ mV per second}$)
 - 1 mV ($35\text{ mV per second} \leq \text{scan rate} < 350\text{ mV per second}$)
 - 10 mV ($350\text{ mV per second} \leq \text{scan rate} \leq 3500\text{ mV per second}$)
- Number of cycles: 1 to 100
- User-selectable sampling intervals:
 - Points per test (10 to 10000)
 - Points per cycle (10 to 10000)
 - Seconds per point (.01 to 100)
 - Points per second (.01 to 100)
- Maximum total number of samples: 100,000

Run the Cyclic Voltammetry test application

To run the test application:

1. Press the **HOME** key.
2. Select the active script indicator at the top of your home screen. If there is no script activity, the indicator displays "No Script."

Figure 13: Active script indicator

No Script

3. Select the preloaded Cyclic Voltammetry test script (potentiostats and galvanostats only) or connect the supplied USB drive to your SMU instrument to locate the included Cyclic Voltammetry test. If you connect the USB drive, scripts on the drive are displayed with `usb1/` before the script file name.

Figure 14: Selecting the Cyclic Voltammetry test application

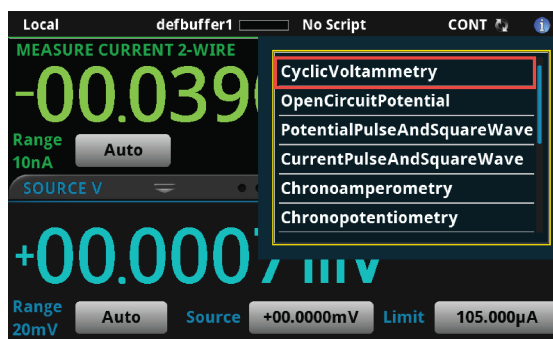

4. Select **CyclicVoltammetry**. The test application begins to run immediately and the Cyclic Voltammetry Home screen is displayed.

Figure 15: Cyclic Voltammetry Home screen

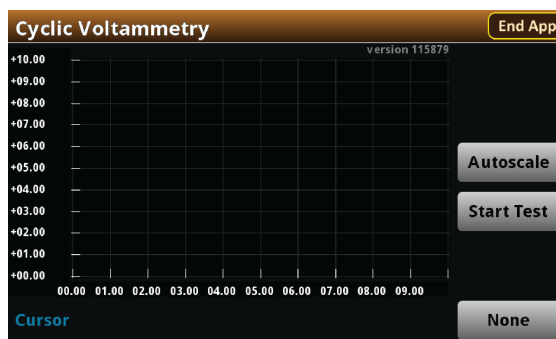

The test home screen controls include:

End App	Select this control to immediately stop the test and return to normal SMU operation.
Autoscale	Select this control to define the graph based upon the plotted data. This is useful for constraining all of the data to the screen's viewing size.
Start Test	Select this control to immediately begin the test. This option becomes Stop Test when the test runs.
Save Data	Select this control to save the test data to a .csv file on a flash drive. This option is only visible after the test runs.
Cursor	Select this control to cycle through the available cursor placements: None, Vertical, Horizontal, and Both.

Review the Menu controls

You have different options in the Menu screen, depending on the application. The following graphic shows the Cyclic Voltammetry main Menu. You will learn the function for each option later in this section.

Figure 16: Cyclic Voltammetry main Menu

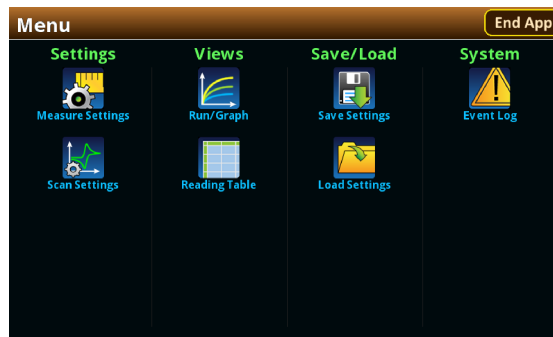

Define the potential scan parameters

You will define the potential scan parameters: Number of Vertices, vertex potentials, potential reference, scan rate, and number of cycles.

An example of a potential scan performed during a Cyclic Voltammetry test is shown in the next figure.

You can select up to four voltage potential vertices, which are defined as E1 (or E initial), E2, E3, and E4 in the next figure. The slope of the lines is determined by the the scan rate that you use. You will set the scan rate later in this step of the test.

Figure 17: Potential sweep versus time of Cyclic Voltammetry example

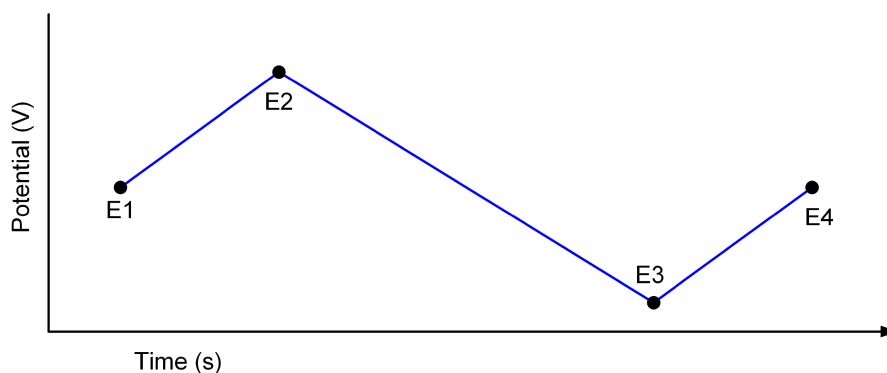

For this step, you will set the Number of Vertices, define their potentials, and specify the potential reference.

To select the Number of Vertices:

1. Press the **MENU** key, then select **Scan Settings**.
2. Select **Number of Vertices**.

Figure 18: Scan Settings menu

The Scan Settings menu is displayed with the following parameters:

Parameter	Value
Number of Vertices	4
Reference	Eref
Scan Rate	25
Number of Cycles	3
Vertex 1	1.00000V
Vertex 2	2.00000V
Vertex 3	3.00000V
Vertex 4	4.00000V

3. Enter the number of potential vertices. You can define two, three, or four vertices.
4. The vertex selections will change based on the number of vertices you choose. Select each vertex to enter its potential. For this example, you will define four vertices.

Figure 19: Scan Settings menu, defining four vertices

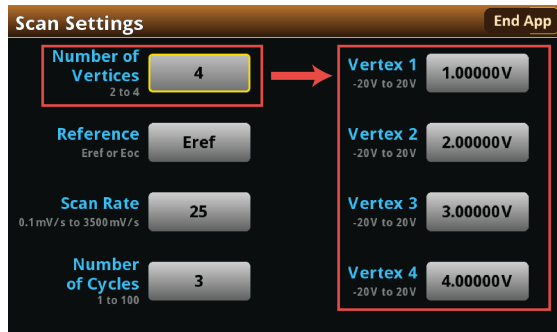

5. Enter each vertex value in the range of ± 20 V.

After you define the vertices, select the potential reference: Eref or Eoc. If you select Eref, the applied potential is relative to the potential at the reference electrode. If you select Eoc, the applied potential is relative to the open circuit potential of the cell (Eoc), which is measured immediately before the scan begins.

To select the potential reference:

1. From the Scan Settings menu, select **Reference**.

Figure 20: Scan Settings menu, selecting Reference



2. Select **Eref** or **Eoc**.

Define the Scan Settings

You can specify the scan rate in units of millivolts per second. The scan rate, defined as the change of the potential as a function of time ($\Delta E/\Delta t$), determines the rate at which the potential is linearly scanned during the experiment. You can select a scan rate of 0.1 mV per second to 3500 mV per second.

To select the Scan Rate:

1. From the Scan Settings menu, select **Scan Rate**

Figure 21: Scan Settings menu, selecting the Scan Rate

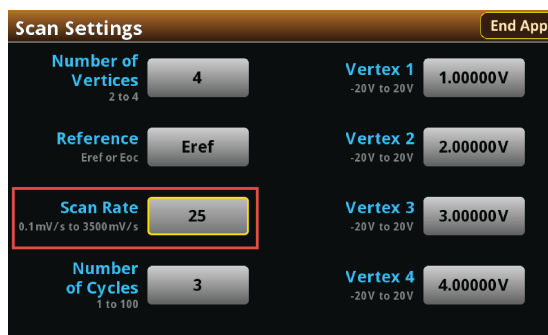

2. Enter a value.
3. Select **OK**.

After entering the scan rate, you will choose the number of cycles, from 1 to 100. The number of cycles determines how many times each scan is repeated.

To select the number of scan cycles:

1. From the Scan Settings screen, select **Number of Cycles**.

Figure 22: Scan Settings menu, selecting the Number of Cycles

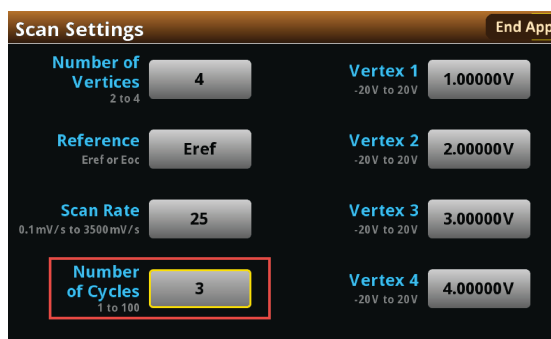

2. Enter a value.
3. Select **OK**.

The following figure shows an example of a potential versus time graph showing three cycles of a three-vertex voltage sweep.

Figure 23: Example potential versus time graph

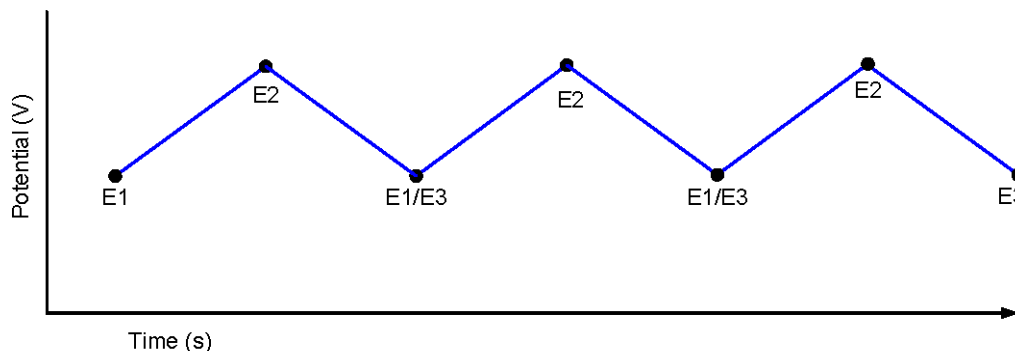

Select the Sampling Rate Units, Sampling Rate, and Current Range

Specify how often to make measurements during the scan by selecting one of the sampling rate units shown in the following table and setting a value for the sampling rate. The acquired measurements are stored in the active buffer of the instrument, `cvBuffer`. The buffer can hold a maximum of 100,000 readings.

The following table describes the available interval units and accompanying range of values.

Sampling rate unit	Description	Sampling rate range of values
points/test	The number of points acquired during a test, regardless of how many cycles	10 to 10,000
points/cycle	The number of points acquired in each cycle	10 to 10,000
s/point	The number of seconds per each point	0.01 to 100
points/s	The number of points taken per second	0.01 to 100

To select the Sampling Rate Units:

1. From the Menu screen, select **Measure Settings**.
2. Select **Sampling Rate Units**.

Figure 24: Measure Settings menu, selecting the Sampling Rate Units

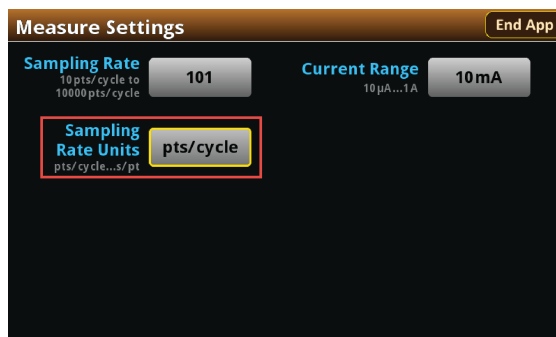

3. Select the units you want to use for the test. You can now set a sampling rate.

To set the Sampling Rate:

1. From the Measure Settings screen, select **Sampling Rate**.
2. Enter a value.
3. Select **OK**.

Now, you will select the Current Range to measure the current from the scan. Choose the range based upon the largest current magnitude you expect during the test.

To select the current measurement range:

1. From the Measure Settings screen, select **Current Range**.

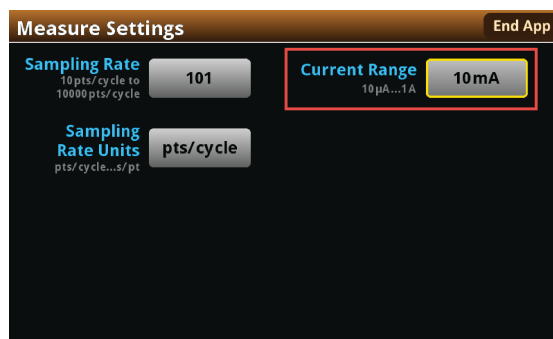
Figure 25: Measure Settings menu, selecting the Current Range**NOTE**

When the test runs, your potentiostat will limit the magnitude of the maximum current that can flow in the test circuit to 100 percent of the selected current range. This could affect your experiment results. If your expected current is near the full scale of a range, select the next highest current range to minimize the influence of your potentiostat on the test

2. Choose a value. Note that the choices are different depending on your potentiostat model.

Figure 26: Selecting the Current Range

2450-EC

2460-EC / 2461-EC

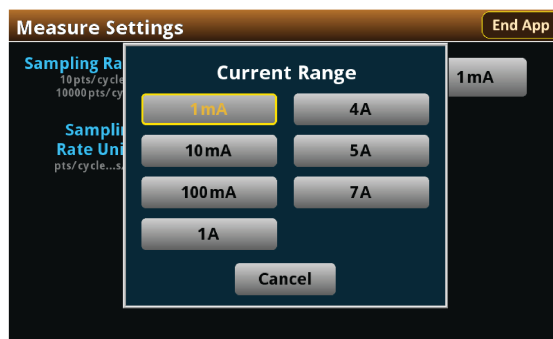
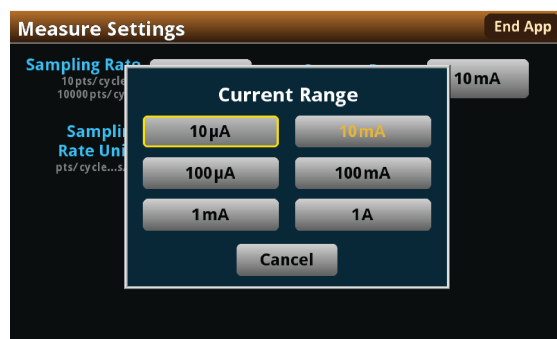

Save or load the test parameter data

You can save your test parameters to the front-panel flash drive at any time. Up to five test parameter configurations can be stored.

To save the test parameters:

1. From the Menu screen, select **Save Settings**.

NOTE

If you have saved a settings file previously with the same File Selection number, you will be prompted to overwrite it.

Figure 27: Selecting Save Settings

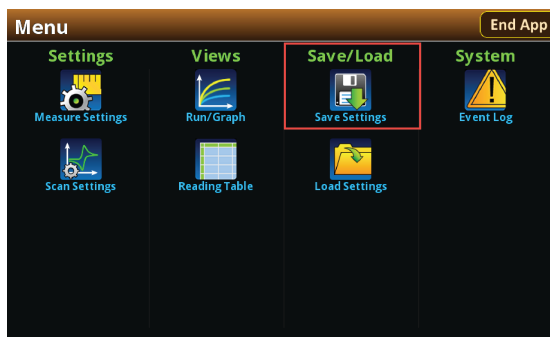

2. Select a file number and then select Save Settings. You are notified when the save is complete, as shown in the next figure. Select **OK** to clear the prompt.

Figure 28: Successful file save

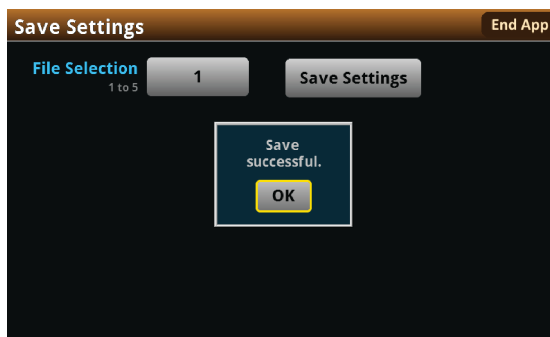

To load saved test parameters:

NOTE

Test parameters can only be loaded to the same instrument model on which they were created and saved. For example, you cannot load test parameter settings created with a 2450-EC to a 2460-EC.

1. From the Menu screen, select **Load Settings**.

Figure 29: Selecting Load Settings

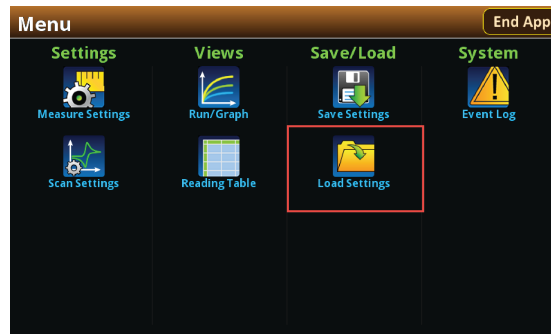

2. Select a file by choosing **File Selection** and then a file number.

Figure 30: Choosing a file to load

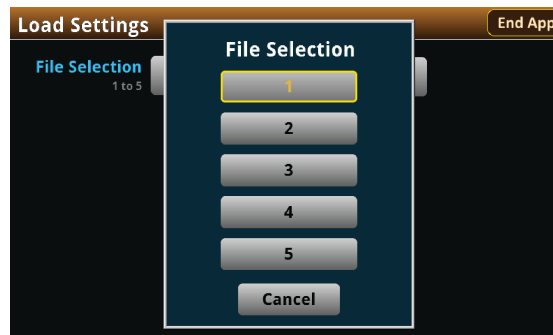

3. Select **Load Settings**. You are notified when the load completes. Select **OK** to clear the prompt.

Run the test and view the graph

To run the test and view the graph:

1. Press the **HOME** key.
2. Select **Start Test**. The output turns on automatically, and the display shows the current measurements plotting in real time, along with a progress bar at the bottom of the screen. The Start Test control also changes to Stop Test for the duration of the test.

The output turns off when the test completes. The following graphic shows the test Home screen during the test. You can return to this Home screen at any time when the test is running by selecting the Run / Graph option from the Menu screen.

Figure 31: Cyclic Voltammetry test results graph

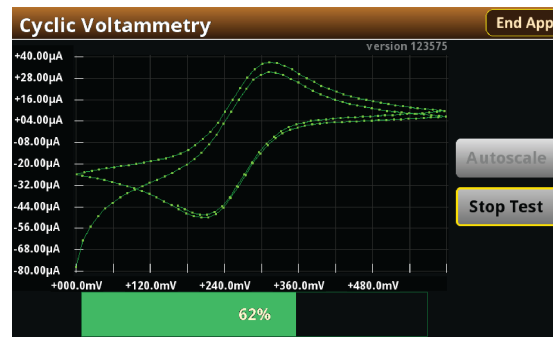

NOTE

You can use the touchscreen to manipulate the graph or add cursors. See your *Interactive SourceMeter® Instrument Reference Manual* for more information.

You can save a screen capture to a flash drive inserted into the USB port of the potentiostat by simultaneously pressing the **HOME** key and the **ENTER** key. The file name has the format `imgmdd_xxxxxx.png`, where `mdd` represents the instrument month and day and `xxxxxx` is a system-generated number.

NOTE

To end the test before the run completes, select **Stop Test** at any time. This stops the test and turns off the potentiostat output. You can then select **End App** to exit the test and return to normal SMU operation. If there is a long interval between consecutive samples, there may be a long delay between selecting Stop Test and when the test stops, as the current operation must complete.

⚠ WARNING

Make sure to select Stop Test before selecting End App. Stop Test turns off the instrument's output.

Hazardous voltages may be present on all output and guard terminals. To prevent electrical shock that could cause injury or death, never make or break connections to the instrument while the power is turned on. Turn off the equipment from the front panel or disconnect the main power cord from the rear of the instrument before handling cables. Putting the equipment into an output-off state does not guarantee that the outputs are powered off if a hardware or software fault occurs.

Acquire the open circuit potential (Eoc)

If you selected Eoc as the potential reference for the scan, then the open circuit potential will be measured immediately after starting the test. You are prompted by the test application, as shown in the next figure.

Figure 32: Prompt for Eoc measurement

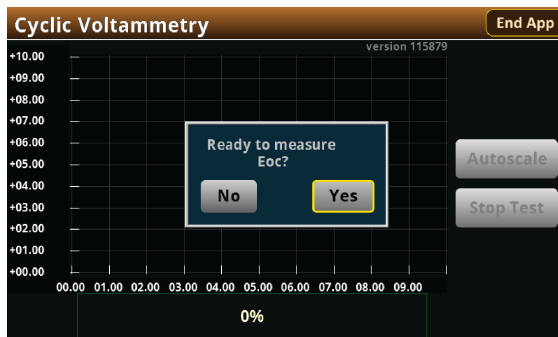

If you select **Yes**, the instrument measures the open circuit potential (Eoc) of your electrochemical cell. If you select **No**, the test stops. After the Eoc is measured, the value is displayed in a prompt, as shown in the next figure.

Figure 33: Eoc measurement displayed

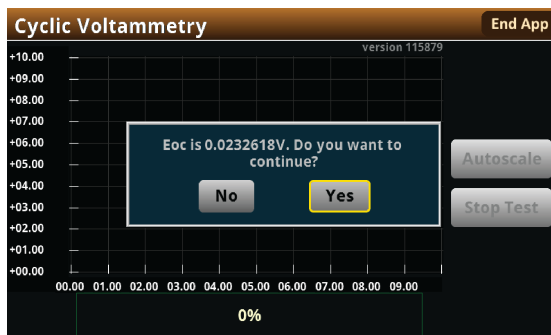

If this value is acceptable, then select **Yes** to start the scan. If you select **No**, the test will stop. The measured Eoc value is saved in the `eocBuffer` internal buffer of the instrument.

Save the test data to the flash drive

You can save the data generated from the test to the front-panel flash drive. The data is stored in a .csv file that also includes instrument information and parameter settings.

If there are more than 10,000 measurements stored, the process of saving the data may take several minutes.

To save the test data to the flash drive:

1. Make sure your flash drive is inserted into the front panel USB port.
2. From the test application home screen, select **Save Data**.
3. Specify a file name, then select **OK**.
4. Select **OK** on the confirmation message.

Figure 34: Test results saved successfully

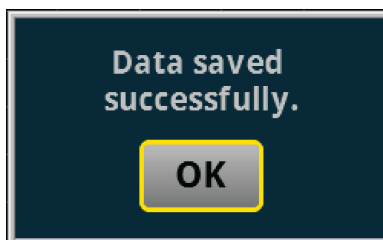

View the results saved to the flash drive

To view the test results, open the saved file in a spreadsheet program on a computer. Current, voltage, time, and general parameters for the test are included in the file.

View the test reading table

You can view the individual data points by selecting **Reading Table** from the Menu screen. See the next figure.

Figure 35: Viewing the Reading Table

READING TABLE			
Buffer	Active (cvBuffer) 		
Buffer Index	Time	Reading	Source
1	10/25 13:35:32.968686	-0.07454 mA	+0.000000 V
2	10/25 13:35:33.229296	-0.06051 mA	+0.012000 V
3	10/25 13:35:33.469267	-0.05294 mA	+0.024000 V
4	10/25 13:35:33.709260	-0.04764 mA	+0.036000 V
5	10/25 13:35:33.949270	-0.04370 mA	+0.048000 V
6	10/25 13:35:34.209295	-0.04034 mA	+0.061000 V
7	10/25 13:35:34.449267	-0.03782 mA	+0.073000 V
8	10/25 13:35:34.689266	-0.03567 mA	+0.085000 V
9	10/25 13:35:34.929289	-0.03377 mA	+0.097000 V
10	10/25 13:35:35.189288	-0.03191 mA	+0.110000 V

View the Event Log

From the main Menu, you can select **Event Log**. The event log records events, which can be errors, warnings, and information reported by your instrument. Through the Event Log menu, you can view these events. You can also specify which events are shown in the event log, which ones are logged, and which ones generate popup messages.

Figure 36: Viewing the Event Log

System Events		Log Settings
Time	Code	Description
11/09 15:04	4917	Reading buffer defbuffer1 is 0% filled
11/09 15:04	4917	Reading buffer defbuffer2 is 0% filled
11/09 15:05	5084	Continuous readings unavailable with output off in resistanc

See your Keithley Instruments 2450, 2460, or 2461 *Interactive SourceMeter® Instrument Reference Manual* for further details on the Event Log.

End the test application

When you are finished making measurements, select **End App** to exit the test and return to normal SMU operation.

CAUTION

Make sure to always select **Stop Test** before selecting **End App**. **Stop Test** turns off the instrument's output.

Cyclic Voltammetry theory

A typical electrochemical measurement circuit, which consists of an electrochemical cell, an adjustable voltage source (V_s), an ammeter (A_M), and a voltmeter (V_M), is shown in the following figure.

Figure 37: Simplified measurement circuit for performing Cyclic Voltammetry

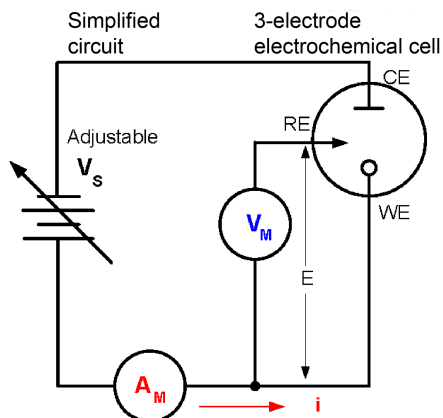

The three electrodes of the electrochemical cell are the working electrode (WE), reference electrode (RE), and the counter, or auxiliary, electrode (CE). The voltage source (V_s) for the potential scan is applied between the working electrode and the counter electrode. The potential (E) between the reference electrode and the working electrode is measured with the voltmeter (V_M). The overall voltage (V_s) is adjusted to maintain the targeted potential at the working electrode with respect to the reference electrode. The resulting current (i) flowing to the working electrode is measured with the ammeter (A_M). This process is usually repeated for a range of E .

An example procedure to make a measurement for each point in the scan (E_i):

1. Select a potential (E) for RE with respect to WE.
2. Adjust the voltage across the entire cell (CE to WE) to get desired E (closed loop control).
3. Measure i .
4. Step to a new E and repeat the procedure until the scan is finished. The procedure can be a single sweep between two potentials (Linear Sweep Voltammetry) or one in which the sweep is inverted when a certain potential is reached (Cyclic Voltammetry). This cycle may be repeated multiple times during an experiment.
5. Plot the results and derive parameters of interest from the data.

Once the experiment is finished, the measured current is plotted as a function of the potential in a graph known as a voltammogram. The example voltammogram in the following figure shows four voltage vertices:

- E1 (initial potential)
- E2 (second, switching potential)
- E3 (third, switching potential)
- E4 (final potential)

The voltage peaks in the waveform are the anodic (E_{pa}) and the cathodic (E_{pc}) peak potentials.

Figure 38: Example voltammogram generated by a 2450-EC

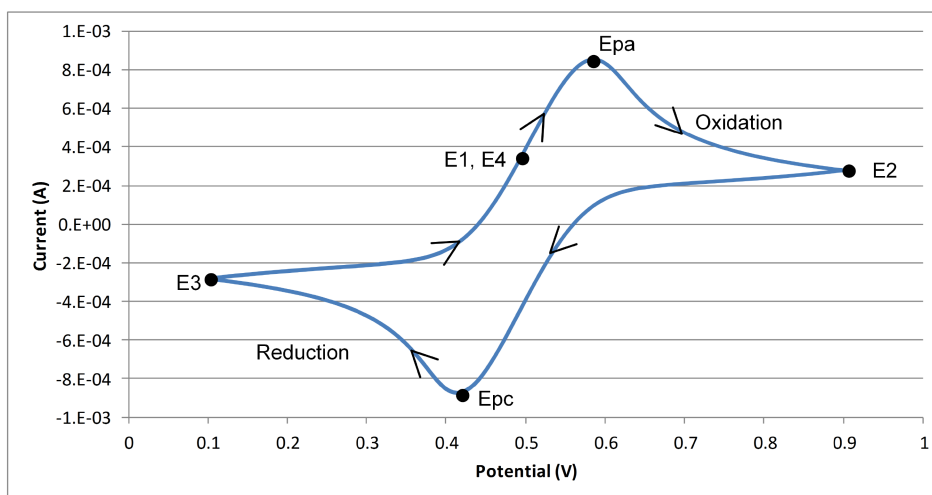

In this example, the scan begins at E1 and the potential becomes more positive, causing the anodic current (to rise rapidly and peak at the anodic peak potential (E_{pa})).

At E2, the scan direction switches to negative for the reverse scan. As the current becomes more negative, cathodic current flows as the electrode process is reduced. A cathodic peak potential occurs at E_{pc} .

At E3, the direction reverses again and the voltage is swept until it reaches E4. From the potential sweep, important information about the experiment can be derived and analyzed.

Keithley galvanostat scan theory

The 2450-EC, 2460-EC, and 2461-EC digital potentiostats do not output a truly linear voltage; they output very small, digitized steps from 0.1 mV to 10 mV for a specified time (dt), depending upon the scan rate. See the next figure. While this will not cause significant errors in normal geometry cells (such as 10 mL analytic and most galvanic cells), there might be errors when using micro and ultramicro electrodes. The voltage step sizes used are calculated during scanning based on the user set scan rate:

- 100 μ V (0.1 mV per second \leq scan rate < 35 mV per second)
- 1 mV (35 mV per second \leq scan rate < 350 mV per second)
- 10 mV (350 mV per second \leq scan rate \leq 3500 mV per second)

Figure 39: Potential scan

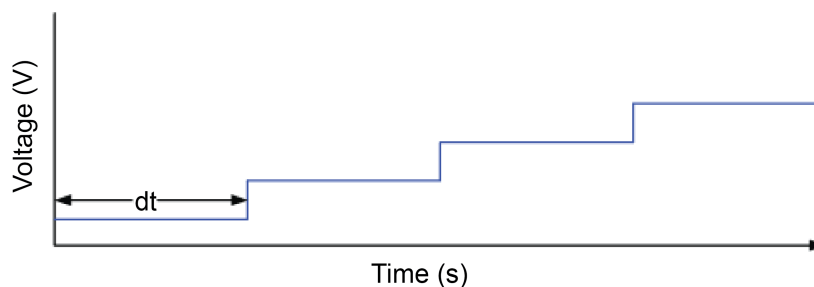

Analog integration current method

To measure the resulting current at each step, many digital potentiostats make a single current measurement at a fixed point (t) for each discrete voltage step, which may not be at the same time for each step. See the following figure.

Figure 40: Voltage step measurements

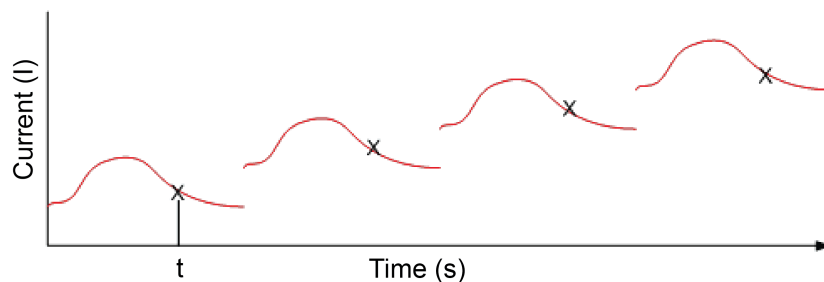

Conversely, the 2450-EC, 2460-EC, and 2461-EC use an internal analog integrator to integrate current over most of the voltage step and report the average current over the aperture time (dt) of the voltage step. See the following figure. This average current is used in the generation of the voltammogram.

Figure 41: Current integration

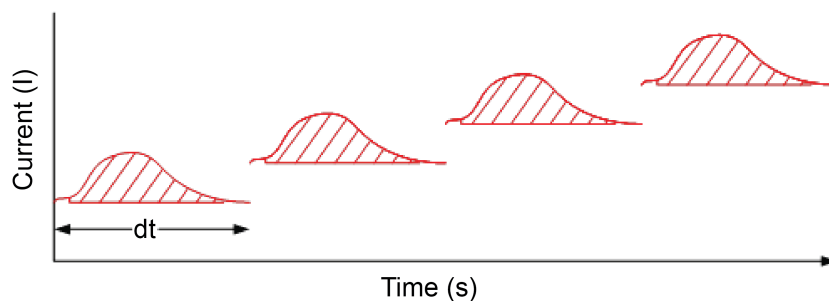

Open circuit potential theory

When the open circuit potential is measured, no current or voltage is applied to the cell. This voltage measurement is made using the galvanostat to source current and measure voltage (see the next figure). The instrument sources 0 A on the 1e-6 range using a 4-wire configuration.

Figure 42: Measuring open circuit potential of an electrochemistry cell

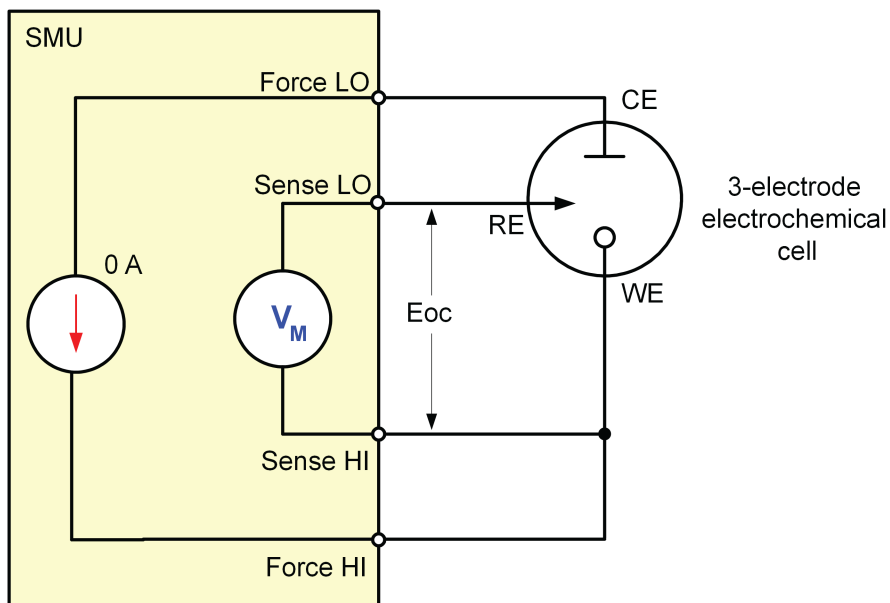

You can use this potential measurement as the zero measurement when defining the voltage vertices. When you do this, the E_{oc} measurement gets added to the voltage.

Open Circuit Potential

In this section:

Open Circuit Potential 3-1

Open Circuit Potential

The Open Circuit Potential (OCP) of an electrochemical cell is the voltage between the reference and working electrodes. When the open circuit potential is measured, a voltmeter with high impedance is used to measure the voltage with no current or voltage applied to the cell.

Because of its high input impedance, your galvanostat can be used to make OCP measurements when configured for 4-wire measurements, as shown in the next figure. In this setup, the instrument is configured to source 0 A and measure voltage.

If you measure the OCP before performing any test, you do not have to change any test leads between measurements, because your potentiostat or galvanostat can automatically change functions.

Figure 43: Measuring the Open Circuit Potential

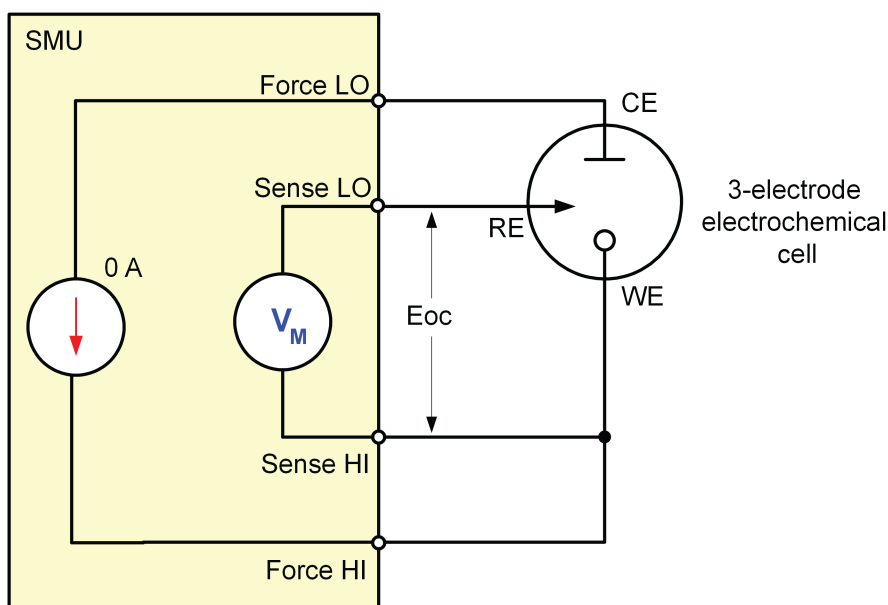

NOTE

To ensure proper instrument operation, the potential difference between the reference electrode (RE) and counter electrode (CE) terminals and between the working electrode (WE) and working electrode sense (WES) terminals should not exceed 5 V.

Test application parameters

⚠ CAUTION

You must enter test parameters that are consistent with the following values. Otherwise, you may receive unsettled and inaccurate measurements.

The Open Circuit Potential test application parameters are listed below.

Model 2450-EC

- Potential measure ranges: 20 mV, 200 mV, 2 V, 20 V
- Sample interval: $0.75 \text{ s} \leq \text{sample interval} \leq 100 \text{ s}$
- Number of samples: 1 to 100,000

Models 2460-EC and 2461-EC

- Potential measure ranges: 200 mV, 2 V, 7 V, 10 V, 20 V
- Sample interval: $0.75 \text{ s} \leq \text{sample interval} \leq 100 \text{ s}$
- Number of samples: 1 to 100,000

Run the Open Circuit Potential test application

To run the test application:

1. Press the **HOME** key.
2. Select the active script indicator at the top of your home screen. If there is no script activity, the indicator displays "No Script."

Figure 44: Active script indicator

No Script

3. Select the preloaded OCP test script (potentiostats and galvanostats only) or connect the supplied USB drive to your SMU instrument to locate the included OCP test. If you connect the USB drive, scripts on the drive are displayed with `usb1/` before the script file name.

Figure 45: Selecting the Open Circuit Potential test application

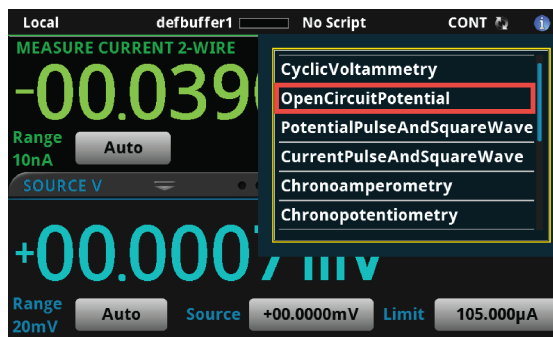

4. Select `OpenCircuitPotential`. The test application begins to run immediately and the OCP Home screen is displayed.

Figure 46: Open Circuit Potential test home screen

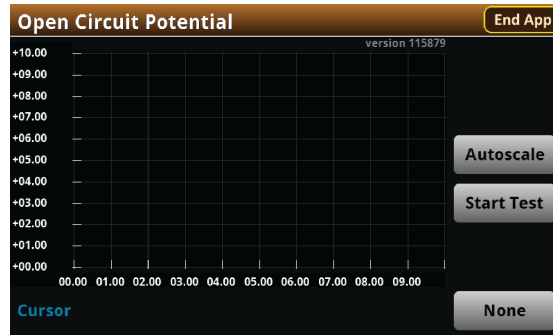

The test home screen controls include:

End App	Select this control to immediately stop the test and return to normal SMU operation.
Autoscale	Select this control to define the graph based upon the plotted data. This is useful for constraining all of the data to the screen's viewing size.
Start Test	Select this control to immediately begin the test. This option becomes Stop Test when the test runs.
Save Data	Select this control to save the test data to a <code>.csv</code> file on a flash drive. This option is only visible after the test runs.
Cursor	Select this control to cycle through the available cursor placements: None, Vertical, Horizontal, and Both.

Review the Menu controls

You have different options in the Menu screen, depending on the application. The following graphic shows the Open Circuit Potential main Menu. You will learn the function for each option later in this section.

Figure 47: Open Circuit Potential main Menu

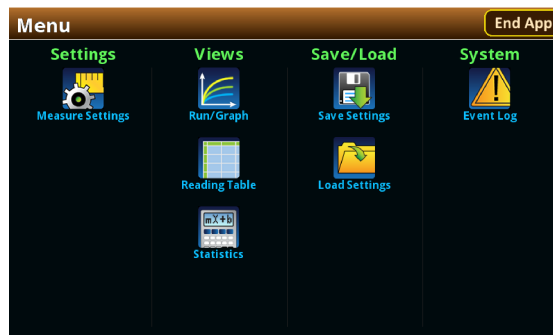

Adjust the Measure Settings

When you run the test application, you must define the parameters for the open circuit potential measurements. These parameters are the Potential range, Sample Count, and the Sample Interval.

To select the Potential Range:

1. Press the **MENU** key, then select **Measure Settings**.
2. Select **Potential Range**.

Figure 48: Measure Settings menu, selecting Potential Range

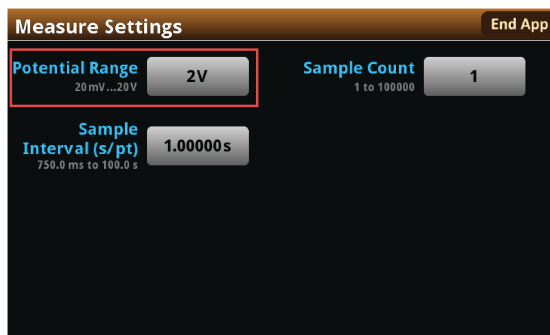

3. Choose a value. Note that the choices are different depending on your galvanostat.

Figure 49: Selecting the Potential Range

2450-EC

2460-EC / 2461-EC

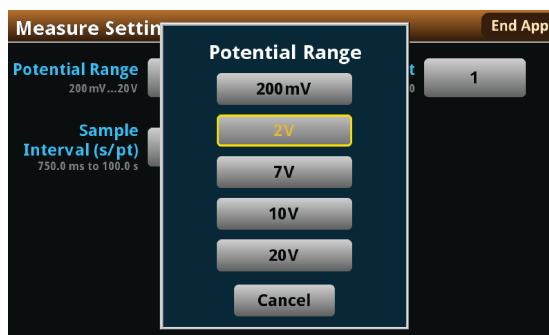
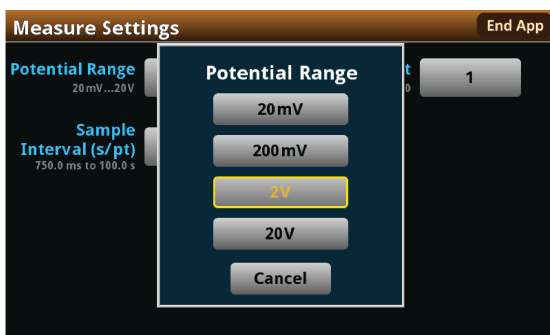

Next, specify the number of Open Circuit Potential measurements to make. This is called the Sample Count. You can set the Sample Count from 1 to 100,000.

To set the number of samples:

1. From the Measure Settings screen, select **Sample Count**.

Figure 50: Measure Settings menu, selecting Sample Count

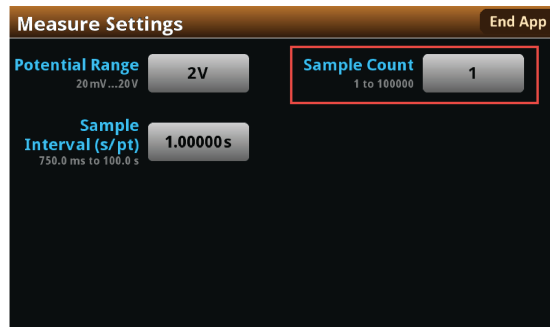

2. Enter a value.

Now you will specify the sample interval time in seconds per point. The sample interval time is illustrated in the next figure. You can choose an interval from 0.75 to 100 seconds per point.

Figure 51: Sample Interval time, graphic description

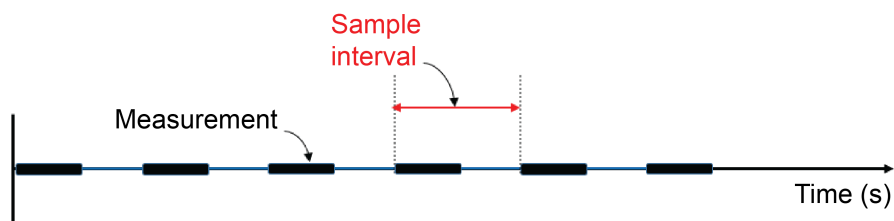

To specify the Sample Interval:

1. From the Measure Settings screen, select **Sample Interval (s/pt)**.
2. Enter a value.

Figure 52: Entering the Measurement Interval

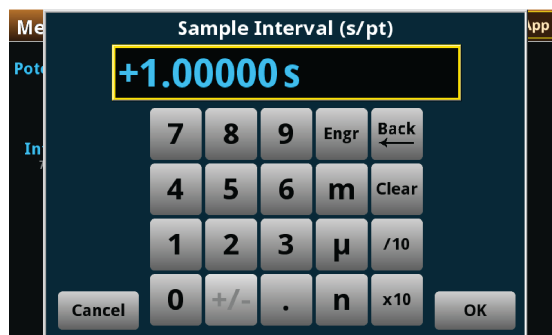

Save or load the test parameter data

You can save your test parameters to the front-panel flash drive at any time. Up to five test parameter configurations can be stored.

To save the test parameters:

1. From the Menu screen, select **Save Settings**. Note that your Menu screen options are different depending on the test you are running.

NOTE

If you have saved a settings file previously with the same File Selection number, you will be prompted to overwrite it.

Figure 53: Selecting Save Settings

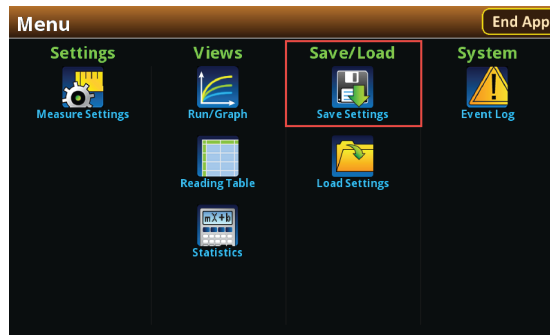

2. You are notified when the save is complete. Select **OK** to clear the prompt.

Figure 54: Successful file save

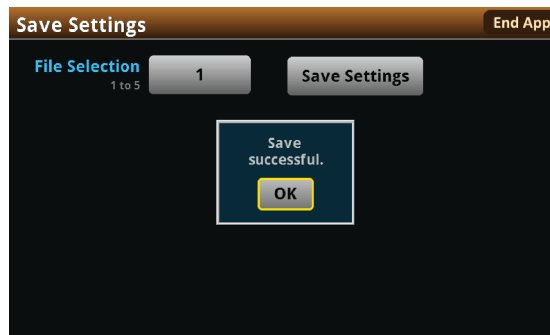

To load saved test parameters:

NOTE

Test parameters can only be loaded to the same instrument model on which they were created and saved. For example, you cannot load test parameter settings created with a 2450-EC to a 2460-EC.

1. From the Menu screen, select **Load Settings**.
2. Select a file by choosing **File Selection** and then a file number.

Figure 55: Choosing a file to load

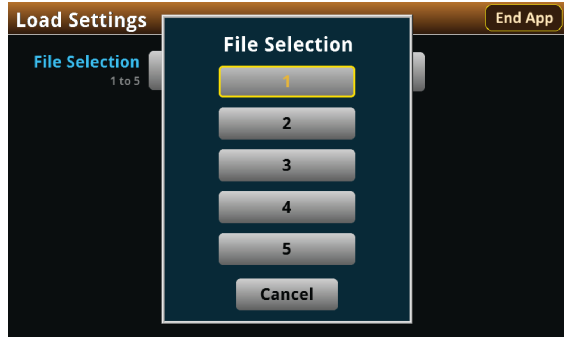

3. Select **Load Settings**. You are notified when the load completes.
4. Select **OK** to clear the prompt.

Run the test and view the graph

To start the experiment and view the graph or data:

1. Press the **HOME** key.
2. Select **Start Test**. The output turns on and the display automatically shows the potential measurements plotting in real time, along with a progress bar at the bottom of the screen. The Start Test control also changes to Stop Test for the duration of the test.

The output turns off when the test completes. The following graphic shows the Home screen after the test finishes. You can return to this Home screen at any time when the test is running by selecting the Run / Graph option from the Menu screen.

Figure 56: Open Circuit Potential test results graph

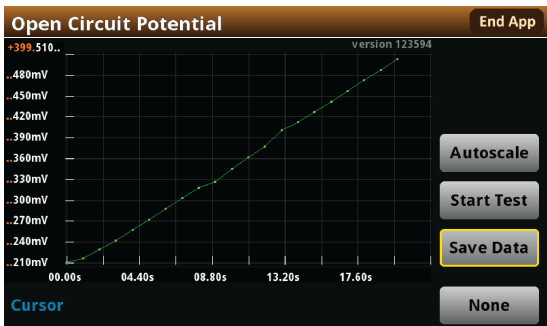

NOTE

You can use the touchscreen to manipulate the graph or add cursors. See your *Interactive SourceMeter® Instrument Reference Manual* for more information.

You can save a screen capture to a flash drive inserted into the USB port of the galvanostat by simultaneously pressing the **HOME** key and the **ENTER** key. The file name has the format `imgmmdd_XXXXXX.png`, where `mmdd` represents the instrument month and day and `XXXXXX` is a system-generated number.

NOTE

To end the test before the run completes, select **Stop Test** at any time. This stops the test and turns off the the galvanostat output. You can then select **End App** to exit the test and return to normal SMU operation. If there is a long interval between consecutive samples, there may be a long delay between selecting Stop Test and when the test stops, as the current operation must complete.

! WARNING

Make sure to select Stop Test before selecting End App. Stop Test turns off the instrument's output.

Hazardous voltages may be present on all output and guard terminals. To prevent electrical shock that could cause injury or death, never make or break connections to the instrument while the power is turned on. Turn off the equipment from the front panel or disconnect the main power cord from the rear of the instrument before handling cables. Putting the equipment into an output-off state does not guarantee that the outputs are powered off if a hardware or software fault occurs.

Save the test data to the flash drive

You can save the data generated from the test to the front-panel flash drive. The data is stored in a `.csv` file that also includes instrument information and parameter settings.

If there are more than 10,000 measurements stored, the process of saving the data may take several minutes.

To save the test data to the flash drive:

1. Make sure your flash drive is inserted into the front panel USB port.
2. From the test application home screen, select **Save Data**.
3. Specify a file name, then select **OK**.
4. Select **OK** on the confirmation message.

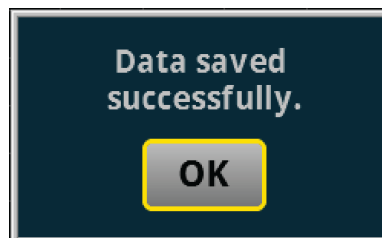
Figure 57: Test results saved successfully

View the results saved to the flash drive

To view the test results, open the saved file in a spreadsheet program on a computer. Current, voltage, time, and general parameters for the test are included in the file.

View the Reading Table or measurement Statistics

When the test completes, you can view the individual data points on the instrument by selecting **Reading Table** from the Menu screen.

Figure 58: Viewing the Reading Table

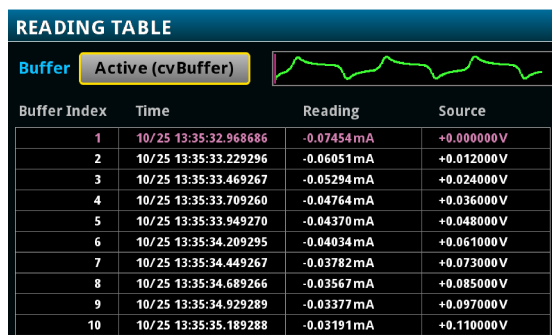

You can also view the measurement statistics. Select **Statistics** from the Menu screen.

Figure 59: Viewing measurement Statistics



View the Event Log

From the main Menu, you can select **Event Log**. The event log records events, which can be errors, warnings, and information reported by your instrument. Through the Event Log menu, you can view these events. You can also specify which events are shown in the event log, which ones are logged, and which ones generate popup messages.

Figure 60: Viewing the Event Log

System Events		Log Settings
Time	Code	Description
11/09 15:04	4917	Reading buffer defbuffer1 is 0% filled
11/09 15:04	4917	Reading buffer defbuffer2 is 0% filled
11/09 15:05	5084	Continuous readings unavailable with output off in resistanc

See your Keithley Instruments 2450, 2460, or 2461 *Interactive SourceMeter® Instrument Reference Manual* for further details on the Event Log.

End the test application

When you are finished making measurements, select **End App** to exit the test and return to normal SMU operation.

CAUTION

Make sure to always select **Stop Test** before selecting **End App**. **Stop Test** turns off the instrument's output.

Potential Pulse & Square Wave

In this section:

Potential Pulse and Square Wave..... 4-1

Potential Pulse and Square Wave

In the Potential Pulse and Square Wave test, the SMU potentiostat supplies a series of up to 100,000 potential pulses. At the end of each pulse, the SourceMeter measures the resulting current. You can select both the peak and base levels of the pulses, as well as the period, pulse width, and sample time.

Various parameters of the pulse wave are displayed in the figure below. Though not pictured, there is also a brief latency period between the end of the measurement and the end of the pulse to allow the instrument's analog-to-digital converter to finish processing the reading.

Figure 61: Potential versus Time

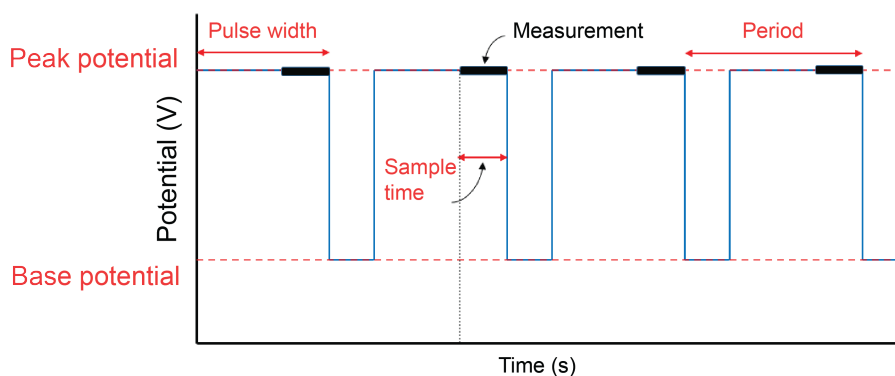

NOTE

To ensure proper instrument operation, the potential difference between the reference electrode (RE) and counter electrode (CE) terminals and between the working electrode (WE) and working electrode sense (WES) terminals should not exceed 5 V.

Test application parameters

CAUTION

You must enter test parameters that are consistent with the following values. Otherwise, you may receive unsettled and inaccurate measurements.

The Potential Pulse and Square Wave test application parameters are listed below:

Model 2450-EC

- Peak potential: $-20\text{ V} \leq E_{\text{peak}} \leq +20\text{ V}$
- Base potential: $-20\text{ V} \leq E_{\text{base}} \leq +20\text{ V}$
- Current measure ranges: 1 μA , 10 μA , 100 μA , 1 mA, 10 mA, 100 mA, 1 A
- Source limit (compliance): 105 % of selected current range
- Pulse period and width:
 - Current measure range = 1 μA
 - $200\text{ ms} \leq \text{period} \leq 3600\text{ s}$
 - $100\text{ ms} \leq \text{pulse width} \leq (0.99 \times \text{period})$
 - Current measure range > 1 μA
 - $4\text{ ms} \leq \text{period} \leq 3600\text{ s}$
 - $2\text{ ms} \leq \text{pulse width} \leq (0.99 \times \text{period})$
- Sample time:
 - Minimum is 166.667 μs
 - Maximum is lesser of 166.667 ms and (pulse width - 1 ms)
- Number of cycles: 1 to 100,000
- Program time: $(1 \times \text{period}) \leq \text{program time} \leq (100,000 \times \text{period})$

Models 2460-EC and 2461-EC

- Peak potential: $-20\text{ V} \leq E_{\text{peak}} \leq +20\text{ V}$
- Base potential: $-20\text{ V} \leq E_{\text{base}} \leq +20\text{ V}$
- Current measure ranges: 1 μA , 10 μA , 100 μA , 1 mA, 10 mA, 100 mA, 1 A, 4 A, 5 A, 7 A
- Source limit (compliance): 105 % of selected current range
- Pulse period and width:
 - Current measure range $\leq 100\text{ }\mu\text{A}$
 - $80\text{ ms} \leq \text{period} \leq 3600\text{ s}$
 - $40\text{ ms} \leq \text{pulse width} \leq (0.99 \times \text{period})$
 - Current measure range > 100 μA
 - $10\text{ ms} \leq \text{period} \leq 3600\text{ s}$
 - $5\text{ ms} \leq \text{pulse width} \leq (0.99 \times \text{period})$
- Sample time:
 - Minimum is 166.667 μs
 - Maximum is lesser of 166.667 ms and (pulse width - 1 ms)
- Number of cycles: 1 to 100,000
- Program time: $(1 \times \text{period}) \leq \text{program time} \leq (100,000 \times \text{period})$

Run the Potential Pulse and Square Wave test application

To run the test application:

1. Press the **HOME** key.
2. Select the active script indicator at the top of your home screen. If there is no script activity, the indicator displays "No Script."

Figure 62: Active script indicator

No Script

3. Select the preloaded Potential Pulse and Square Wave test script (potentiostats and galvanostats only) or connect the supplied USB drive to your SMU instrument to locate the included Potential Pulse and Square Wave test. If you connect the USB drive, scripts on the drive are displayed with usb1/ before the script file name.

Figure 63: Selecting the Potential Pulse and Square Wave test application

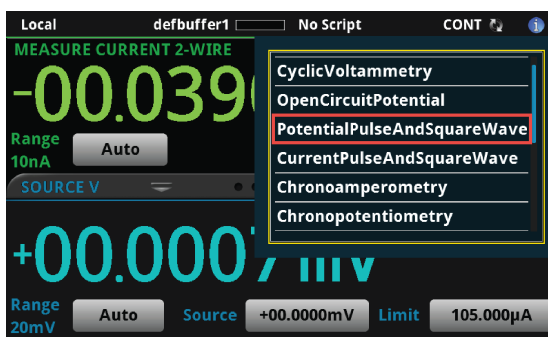

4. Select `PotentialPulseAndSquareWave`. The test application begins to run immediately and the Potential Pulse and Square Wave Home screen is displayed.

Figure 64: Potential Pulse and Square Wave test home screen

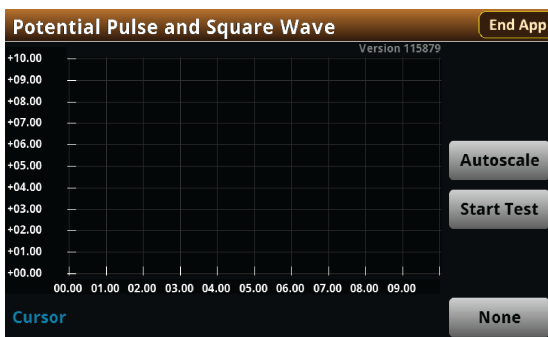

The test home screen controls include:

End App	Select this control to immediately stop the test and return to normal SMU operation.
Autoscale	Select this control to define the graph based upon the plotted data. This is useful for constraining all of the data to the screen's viewing size.
Start Test	Select this control to immediately begin the test. This option becomes Stop Test when the test runs.
Save Data	Select this control to save the test data to a .CSV file on a flash drive. This option is only visible after the test runs.
Cursor	Select this control to cycle through the available cursor placements: None, Vertical, Horizontal, and Both.

Review the Menu controls

You have different options in the Menu screen, depending on the application. The following graphic shows the Potential Pulse and Square Wave main Menu. You will learn the function for each option later in this section.

Figure 65: Potential Pulse and Square wave main Menu

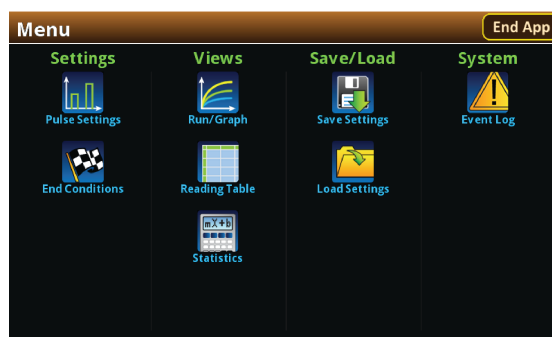

Configure the Pulse Settings

Select **Pulse Settings** from the main menu to adjust the Base Potential, Peak Potential, Current measure Range, Pulse Period, Pulse Width, and Sample Time.

To adjust the Pulse Settings:

1. Press the **MENU** key, then select **Pulse Settings**.

Figure 66: Pulse Settings menu

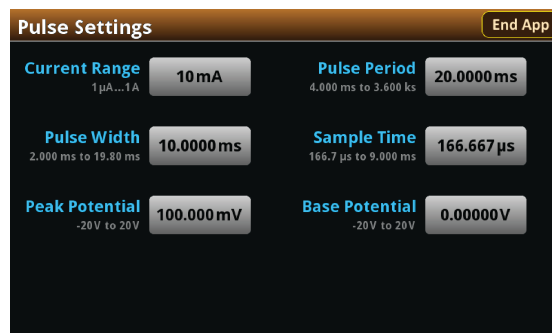

To adjust the Base Potential:

1. From the Pulse Settings screen, select **Base Potential**.
2. Enter a value.

Figure 67: Entering a Base Potential

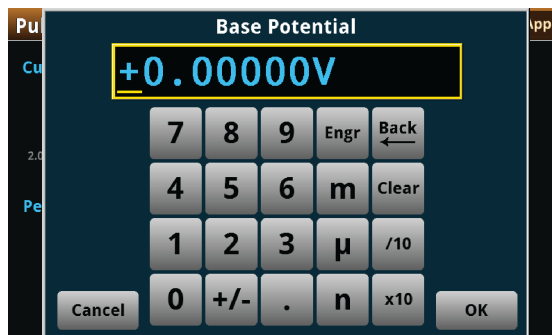

3. Select **OK**.

Next, you will adjust the Peak Potential. This setting allows you to adjust the maximum potential that the instrument will attempt to force, given that the generated current is within the programmed current limit.

To adjust the Peak Potential:

1. From the Pulse Settings screen, select **Peak Potential**.
2. Enter a value.

Figure 68: Entering the Peak Potential

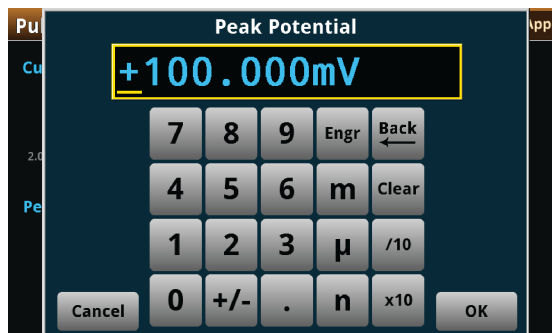

3. Select **OK**.

To set the Current Range:

1. Select **Current Range**.
2. Choose a value. Note that the choices are different depending on your potentiostat.

Figure 69: Selecting the Current measure Range

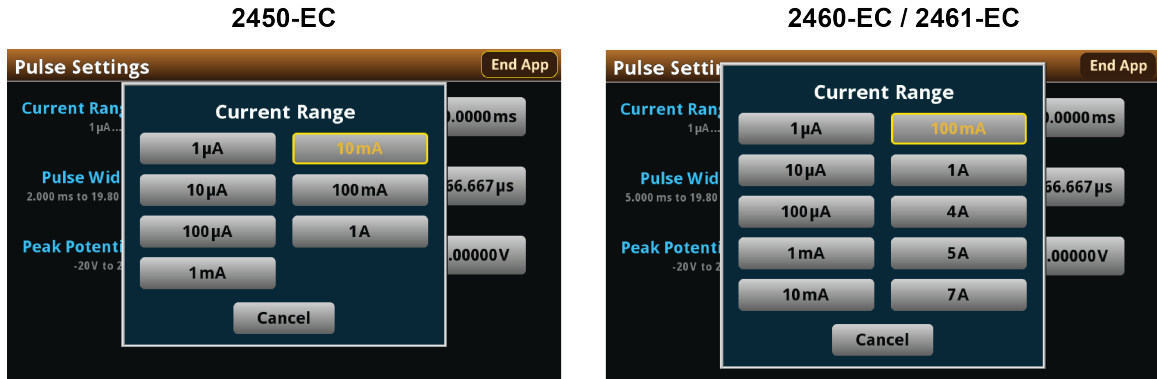

NOTE

The current measure range constrains the maximum current that will flow through the device under test (DUT). Make sure to choose a range higher than your expected maximum current. Setting the current range also sets a current limit, which can be used to stop the test or otherwise protect your DUT. Your potentiostat will limit the current to 105 percent of the selected range.

Now you will adjust the Period. This setting lets you specify the duration of one cycle of the pulse wave. The Period and Pulse Width settings are related. You cannot set the Pulse Width to a value more than 99 percent of the Period. Adjusting the Period may also change the Pulse Width setting automatically.

To adjust the Period:

1. From the Pulse Settings screen, select **Period**.
2. Enter a value.

Figure 70: Entering the pulse Period

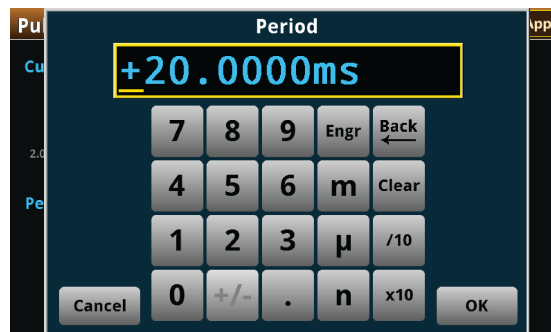

3. Select **OK**.

To adjust the Pulse Width:

1. From the Pulse Settings screen, select **Pulse Width**.
2. Enter a value. The Pulse Width can be no more than 99 percent of the Period setting.

Figure 71: Entering the Pulse Width



3. Select **OK**.

The Sample Time is the length of time over which the actual measurement is taken. The Sample Time cannot exceed the Pulse Width minus 1 ms (PW - 1 ms).

The measurement is taken at the end of the pulse. A brief latency period between the end of the measurement and the end of the pulse allows the analog-to-digital converter in your potentiostat to complete the measurement.

To adjust the Sample Time:

1. From the Pulse Settings screen, select **Sample Time**.
2. Enter a value.

Figure 72: Entering a Sample Time

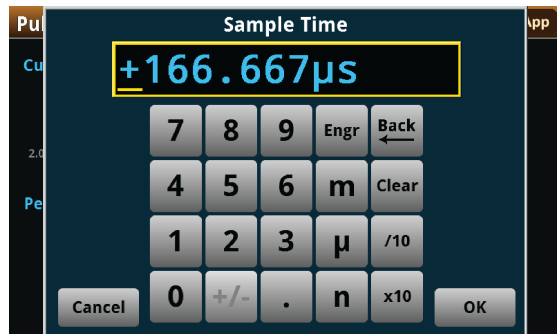

3. Select **OK**.

Adjust the End Conditions

The End Conditions menu lets you choose the conditions that stop the pulse wave. You can enable or disable each condition. See the next graphic.

Figure 73: End Conditions menu enable or disable option

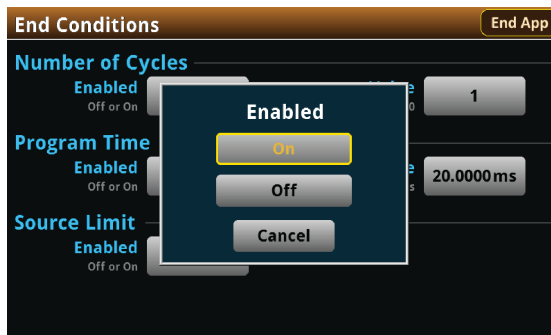

If you enable the Number of Cycles, the Program Time is disabled. Conversely, if you enable the Program Time, the Number of Cycles condition is disabled. The Source Limit setting is independent of the other two settings.

Use the Number of Cycles end condition to stop generating the waveform after the specified number of cycles.

To configure the Number of Cycles end condition:

1. Press the **MENU** key, then select **End Conditions**.

Figure 74: End Conditions menu

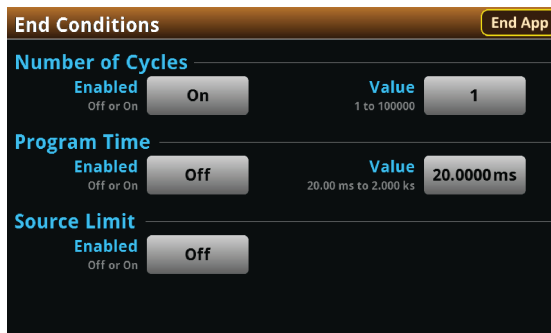

2. Select the Number of Cycles Enabled control.
3. Select **On**.
4. Select the Number of Cycles Value control
5. Enter a value, then select **OK**.

Use the Program Time end condition to stop generating the waveform after a specified time interval. The pulse wave stops at the nearest half-cycle after the time interval elapses.

To configure the Program Time end condition:

1. Press the **MENU** key, then select **End Conditions**.
2. Select the Program Time Enabled control.
3. Select **On**.
4. Select the Program Time Value control.
5. Enter a value, then select **OK**.

Use the Source Limit end condition to stop generating the waveform if the current level reaches the programmed source, or compliance, limit. The source limit is set to 105 percent of the selected current measure range.

To enable the Source Limit end condition:

1. Press the **MENU** key, then select **End Conditions**.
2. Select the Source Limit Enabled control.
3. Select **On**.

Save or load the test parameter data

You can save your test parameters to the front-panel flash drive at any time. Up to five test parameter configurations can be stored.

To save the test parameters:

1. From the Menu screen, select **Save Settings**. Note that your Menu screen options are different depending on the test you are running.

NOTE

If you have saved a settings file previously with the same File Selection number, you will be prompted to overwrite it.

Figure 75: Selecting Save Settings

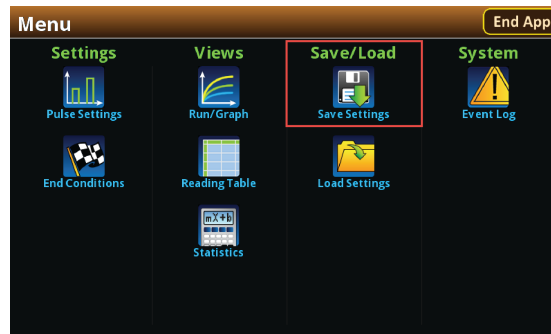

2. You are notified when the save is complete. Select **OK** to clear the prompt.

Figure 76: Successful file save

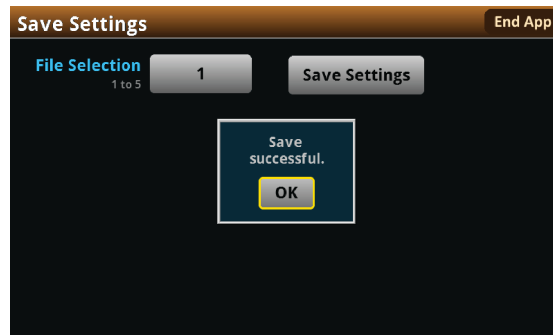

To load saved test parameters:

NOTE

Test parameters can only be loaded to the same instrument model on which they were created and saved. For example, you cannot load test parameter settings created with a 2450-EC to a 2460-EC.

1. From the Menu screen, select **Load Settings**.
2. Select a file by choosing **File Selection** and then a file number.

Figure 77: Choosing a file to load



3. Select **Load Settings**. You are notified when the load completes.
4. Select **OK** to clear the prompt.

Run the test and view the graph

To run the test and view the graph:

1. Press the **HOME** key.
2. Select **Start Test**. The output turns on and the display automatically shows the current measurements plotting in real time, along with a progress bar at the bottom of the screen. The Start Test control also changes to Stop Test for the duration of the test.

The output turns off when the test completes. The following graphic shows the test Home screen after the test finishes. You can return to this Home screen at any time when the test is running by selecting the Run / Graph option from the Menu screen.

Figure 78: Potential Pulse and Square Wave test results graph

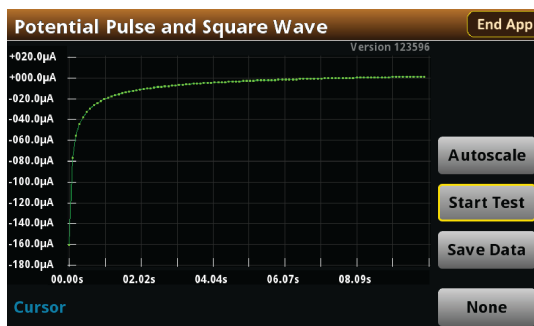

NOTE

You can use the touchscreen to manipulate the graph or add cursors. See your *Interactive SourceMeter® Instrument Reference Manual* for more information.

You can save a screen capture to a flash drive inserted into the USB port of the potentiostat by simultaneously pressing the **HOME** key and the **ENTER** key. The file name has the format `imgmdd_XXXXXX.png`, where `mdd` represents the instrument month and day and `XXXXXX` is a system-generated number.

NOTE

To end the test before the run completes, select **Stop Test** at any time. This stops the test and turns off the the potentiostat output. You can then select **End App** to exit the test and return to normal SMU operation. If there is a long interval between consecutive samples, there may be a long delay between selecting Stop Test and when the test stops, as the current operation must complete.

⚠ WARNING

Make sure to select Stop Test before selecting End App. Stop Test turns off the instrument's output.

Hazardous voltages may be present on all output and guard terminals. To prevent electrical shock that could cause injury or death, never make or break connections to the instrument while the power is turned on. Turn off the equipment from the front panel or disconnect the main power cord from the rear of the instrument before handling cables. Putting the equipment into an output-off state does not guarantee that the outputs are powered off if a hardware or software fault occurs.

Save the test data to the flash drive

You can save the data generated from the test to the front-panel flash drive. The data is stored in a .csv file that also includes instrument information and parameter settings.

If there are more than 10,000 measurements stored, the process of saving the data may take several minutes.

To save the test data to the flash drive:

1. Make sure your flash drive is inserted into the front panel USB port.
2. From the test application home screen, select **Save Data**.
3. Specify a file name, then select **OK**.
4. Select **OK** on the confirmation message.

Figure 79: Test results saved successfully

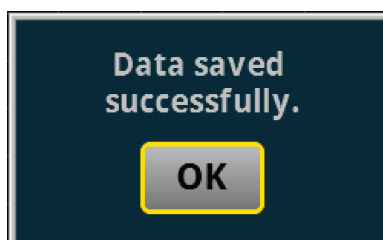

View the results saved to the flash drive

To view the test results, open the saved file in a spreadsheet program on a computer. Current, voltage, time, and general parameters for the test are included in the file.

View the Reading Table or measurement Statistics

When the test completes, you can view the individual data points on the instrument by selecting **Reading Table** from the Menu screen.

Figure 80: Viewing the Reading Table

READING TABLE			
Buffer	Active (cvBuffer)		
Buffer Index	Time	Reading	Source
1	10/25 13:35:32.968686	-0.07454 mA	+0.000000 V
2	10/25 13:35:33.229296	-0.06051 mA	+0.012000 V
3	10/25 13:35:33.469267	-0.05294 mA	+0.024000 V
4	10/25 13:35:33.709260	-0.04764 mA	+0.036000 V
5	10/25 13:35:33.949270	-0.04370 mA	+0.048000 V
6	10/25 13:35:34.209295	-0.04034 mA	+0.061000 V
7	10/25 13:35:34.449267	-0.03782 mA	+0.073000 V
8	10/25 13:35:34.689266	-0.03567 mA	+0.085000 V
9	10/25 13:35:34.929289	-0.03377 mA	+0.097000 V
10	10/25 13:35:35.189288	-0.03191 mA	+0.110000 V

You can also view the measurement statistics. Select **Statistics** from the Menu screen.

Figure 81: Viewing measurement Statistics

The screenshot shows a 'Statistics' screen with a dark background and a table of measurement data. The table has two columns: the first column lists statistical metrics, and the second column shows their corresponding values. An 'End App' button is visible in the top right corner.

Time	5.01972 s
Points	5
Minimum	-195.578 nA
Maximum	-59.6046 nA
Median	-128.523 nA
Average	-128.150 nA
Stddev	43.0009 nA

View the Event Log

From the main Menu, you can select **Event Log**. The event log records events, which can be errors, warnings, and information reported by your instrument. Through the Event Log menu, you can view these events. You can also specify which events are shown in the event log, which ones are logged, and which ones generate popup messages.

Figure 82: Viewing the Event Log

The screenshot shows the 'System Events' screen with a table of event logs. The table has three columns: 'Time', 'Code', and 'Description'. The first three rows contain event data, while the rest are empty. The first row is highlighted in blue.

Time	Code	Description
11/09 15:04	4917	Reading buffer defbuffer1 is 0% filled
11/09 15:04	4917	Reading buffer defbuffer2 is 0% filled
11/09 15:05	5084	Continuous readings unavailable with output off in resistanc

See your Keithley Instruments 2450, 2460, or 2461 *Interactive SourceMeter® Instrument Reference Manual* for further details on the Event Log.

End the test application

When you are finished making measurements, select **End App** to exit the test and return to normal SMU operation.

CAUTION

Make sure to always select **Stop Test** before selecting **End App**. **Stop Test** turns off the instrument's output.

Current Pulse and Square Wave

In this section:

Current Pulse and Square Wave..... 5-1

Current Pulse and Square Wave

In the Current Pulse and Square Wave test, the SMU galvanostat supplies a series of up to 100,000 current pulses. At the end of each pulse, the SourceMeter measures the resulting potential. You can select both the peak and base levels of the pulses, as well as the period, pulse width, and sample time.

Various parameters of the pulse wave are displayed in the figure below. Though not pictured, there is also a brief latency period between the end of the measurement and the end of the pulse to allow the instrument's analog-to-digital converter to finish processing the reading.

Figure 83: Current versus Time

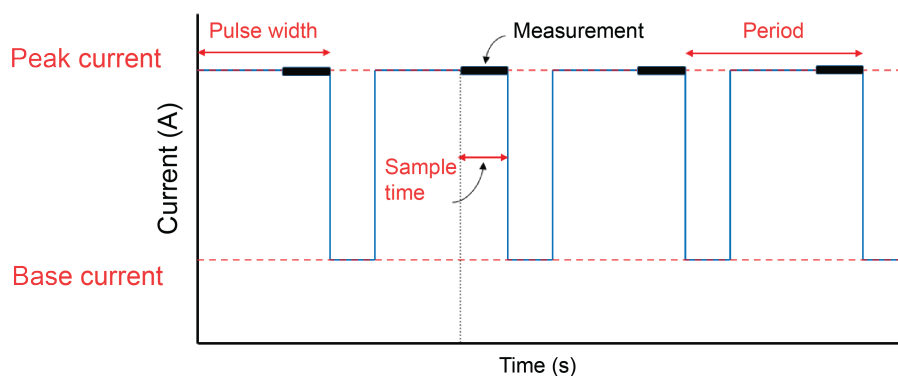

NOTE

To ensure proper instrument operation, the potential difference between the reference electrode (RE) and counter electrode (CE) terminals and between the working electrode (WE) and working electrode sense (WES) terminals should not exceed 5 V.

Test application parameters

CAUTION

You must enter test parameters that are consistent with the following values. Otherwise, you may receive unsettled and inaccurate measurements.

The Current Pulse and Square Wave test application parameters are listed below:

Model 2450-EC

- Peak current: $-1.05 \text{ A} \leq I_{\text{peak}} \leq +1.05 \text{ A}$
- Base current: $-1.05 \text{ A} \leq I_{\text{base}} \leq +1.05 \text{ A}$
- Potential measure ranges: 20 mV, 200 mV, 2 V, 20 V
- Source limit (compliance): 105 % of selected potential range
- Pulse period and width:
 - $|I_{\text{peak}}|$ and $|I_{\text{base}}| \leq 1.05 \mu\text{A}$
 - $200 \text{ ms} \leq \text{period} \leq 3600 \text{ s}$
 - $100 \text{ ms} \leq \text{pulse width} \leq (0.99 \times \text{period})$
 - $|I_{\text{peak}}|$ or $|I_{\text{base}}| > 1.05 \mu\text{A}$
 - $4 \text{ ms} \leq \text{period} \leq 3600 \text{ s}$
 - $2 \text{ ms} \leq \text{pulse width} \leq (0.99 \times \text{period})$
- Sample time:
 - Minimum is 166.667 μs
 - Maximum is lesser of 166.667 ms and (pulse width - 1 ms)
- Number of cycles: 1 to 100,000
- Program time: $(1 \times \text{period}) \leq \text{program time} \leq (100,000 \times \text{period})$

Models 2460-EC and 2461-EC

- Peak current: $-7.35 \text{ A} \leq I_{\text{peak}} \leq +7.35 \text{ A}$
- Base current: $-7.35 \text{ A} \leq I_{\text{base}} \leq +7.35 \text{ A}$
- Potential measure ranges: 200 mV, 2 V, 7 V, 10 V, 20 V
- Source limit (compliance): 105 % of selected potential range
- Pulse period and width:
 - $|I_{\text{peak}}|$ and $|I_{\text{base}}| \leq 105 \mu\text{A}$
 - $80 \text{ ms} \leq \text{period} \leq 3600 \text{ s}$
 - $40 \text{ ms} \leq \text{pulse width} \leq (0.99 \times \text{period})$
 - $|I_{\text{peak}}|$ or $|I_{\text{base}}| > 105 \mu\text{A}$
 - $10 \text{ ms} \leq \text{period} \leq 3600 \text{ s}$
 - $5 \text{ ms} \leq \text{pulse width} \leq (0.99 \times \text{period})$
- Sample time:
 - Minimum is 166.667 μs
 - Maximum is lesser of 166.667 ms and (pulse width - 1 ms)
- Number of cycles: 1 to 100,000
- Program time: $(1 \times \text{period}) \leq \text{program time} \leq (100,000 \times \text{period})$

Run the Current Pulse and Square Wave test application

To run the test application:

1. Press the **HOME** key.
2. Select the active script indicator at the top of your home screen. If there is no script activity, the indicator displays "No Script."

Figure 84: Active script indicator

No Script

3. Select the preloaded Current Pulse and Square Wave test script (potentiostats and galvanostats only) or connect the supplied USB drive to your SMU instrument to locate the included Current Pulse and Square Wave test. If you connect the USB drive, scripts on the drive are displayed with usb1/ before the script file name.

Figure 85: Selecting the Current Pulse and Square Wave test application

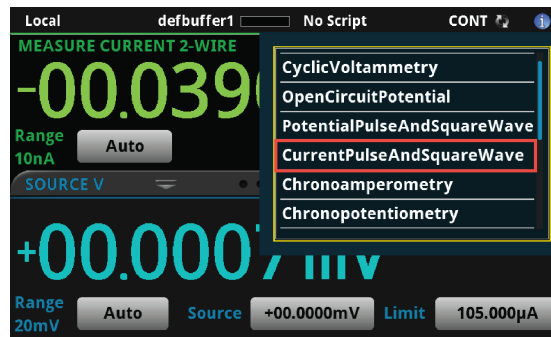

4. Select `CurrentPulseAndSquareWave`. The test application begins to run immediately and the Current Pulse and Square Wave Home screen is displayed.

Figure 86: Current Pulse and Square Wave test Home screen

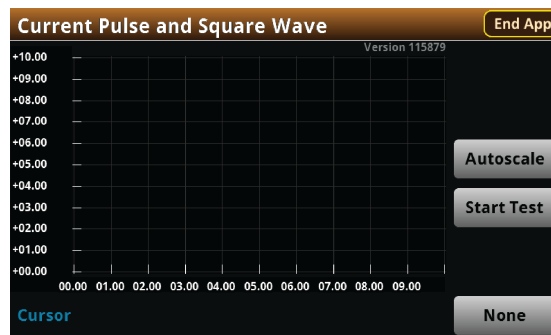

The test home screen controls include:

End App	Select this control to immediately stop the test and return to normal SMU operation.
Autoscale	Select this control to define the graph based upon the plotted data. This is useful for constraining all of the data to the screen's viewing size.
Start Test	Select this control to immediately begin the test. This option becomes Stop Test when the test runs.
Save Data	Select this control to save the test data to a .csv file on a flash drive. This option is only visible after the test runs.
Cursor	Select this control to cycle through the available cursor placements: None, Vertical, Horizontal, and Both.

Review the Menu controls

You have different options in the Menu screen, depending on the application. The following graphic shows the Current Pulse and Square Wave main Menu. You will learn the function for each option later in this section.

Figure 87: Current Pulse and Square Wave main Menu

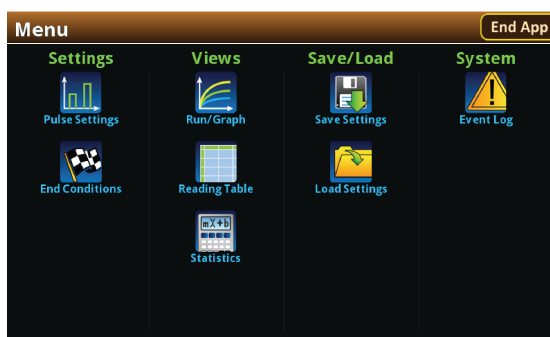

Configure the Pulse Settings

You can select **Pulse Settings** from the main Menu to adjust the Base Current, Peak Current, Potential Range, Period, Pulse Width, and Sample time.

To adjust the Pulse Settings:

1. Press the **MENU** key, then select **Pulse Settings**.

Figure 88: Pulse Settings menu

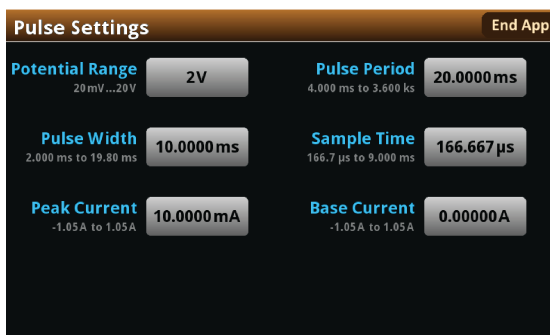

To adjust the Base Current:

1. From the Pulse Settings screen, select **Base Current**.
2. Enter a value.

Figure 89: Entering the Base Current

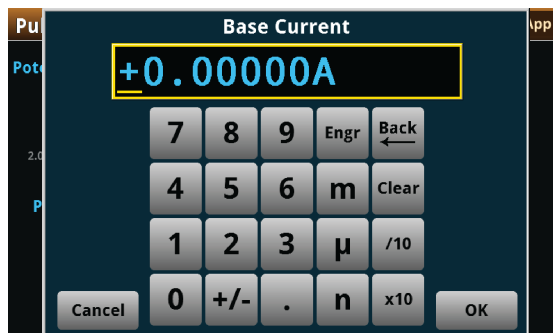

3. Select **OK**.

To adjust the Peak Current:

1. From the Pulse Settings screen, select **Peak Current**.
2. Enter a value.

Figure 90: Entering the Peak Current

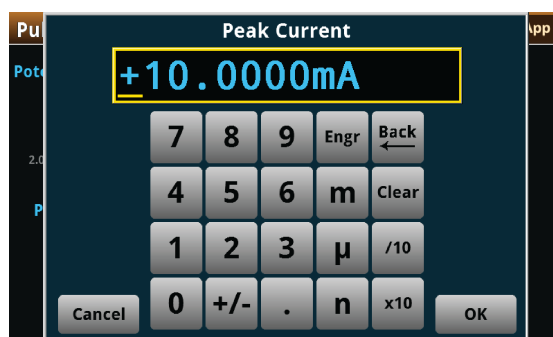

3. Select **OK**.

To set the Potential Range:

1. From the Pulse Settings screen, select **Potential Range**.
2. Choose a value. Note that the choices are different depending on your galvanostat.

Figure 91: Selecting a Potential measure Range

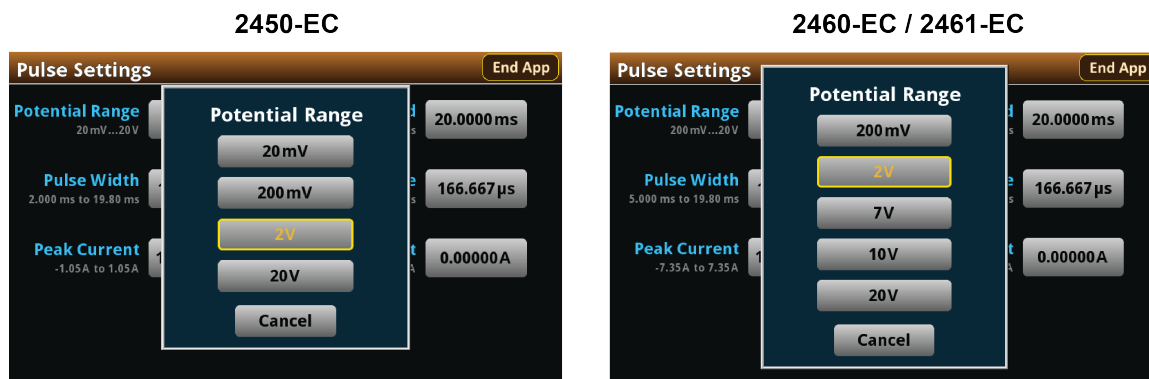

NOTE

The potential range constrains the potential that can develop across the device under test (DUT). Make sure to choose a range higher than your expected maximum potential. Setting the potential range also sets a potential limit, which can be used to stop the test or otherwise protect your DUT. Your galvanostat will limit the potential to 105 percent of the selected range.

Now you will adjust the Period. This setting lets you specify the duration of one cycle of the pulse wave. The Period and Pulse Width settings are related. You cannot set the Pulse Width to a value more than 99 percent of the Period. Adjusting the Period may also change the Pulse Width setting automatically.

To adjust the Period:

1. From the Pulse Settings screen, select **Period**.
2. Enter a value.

Figure 92: Entering the pulse Period

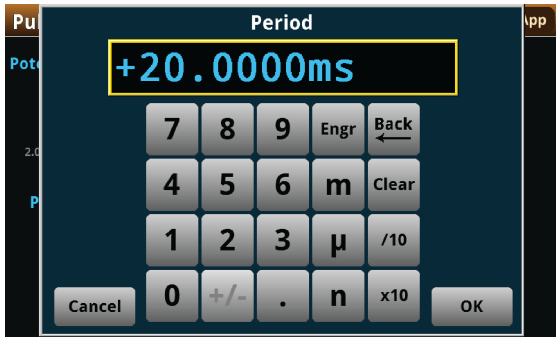

3. Select **OK**.

To adjust the Pulse Width:

1. From the Pulse Settings screen, select **Pulse Width**.
2. Enter a value. The Pulse Width can be no more than 99 percent of the Period setting.

Figure 93: Selecting the pulse Width

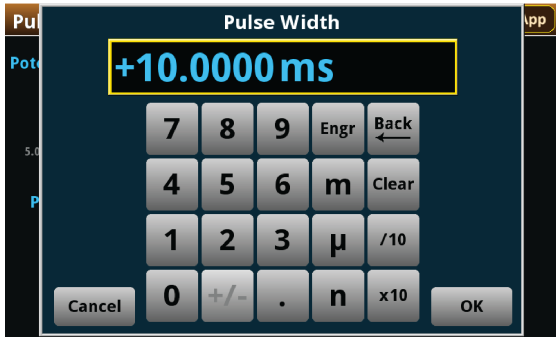

3. Select **OK**.

The Sample Time is the length of time over which the actual measurement is taken. The sample time cannot exceed the Pulse Width minus 1 ms (PW - 1 ms).

The measurement is taken at the end of the pulse. A brief latency period between the end of the measurement and the end of the pulse allows the analog-to-digital converter in your galvanostat to complete the measurement.

To adjust the Sample Time:

1. From the Pulse Settings screen, select **Sample Time**.
2. Enter a value.



3. Select **OK**.

Adjust the End Conditions

The End Conditions menu lets you choose the conditions that stop the pulse wave. You can enable or disable each condition. See the next graphic.

Figure 94: End Conditions menu enable or disable option

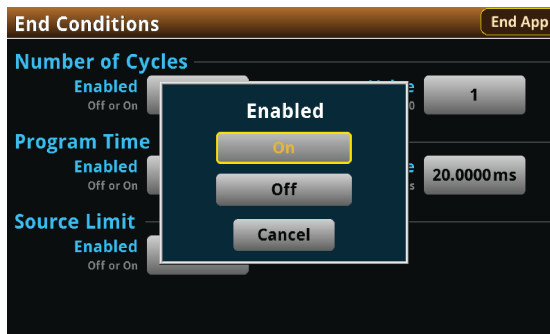

If you enable the Number of Cycles, the Program Time is disabled, Conversely, if you enable the Program Time, the Number of Cycles condition is disabled. The Source Limit setting is independent of the other two settings.

Use the Number of Cycles end condition to stop generating the waveform after the specified number of cycles.

To adjust the Number of Cycles end condition:

1. Press the **MENU** key, then select **End Conditions**.

Figure 95: End Conditions menu

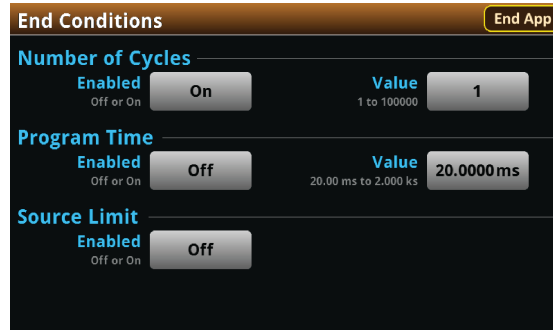

2. Select the Number of Cycles Enabled control
3. Select **On**.
4. Select the Number of Cycles Value control.
5. Enter a value, then select **OK**.

Use the Program Time end condition to stop generating the waveform after a specified time interval. The pulse wave stops at the nearest half-cycle after the time interval elapses.

To configure the Program Time end condition:

1. Press the **MENU** key, then select **End Conditions**.
2. Select the Program Time Enabled control.
3. Select **On**.
4. Select the Program Time Value control.
5. Enter a value, then select **OK**.

Use the Source Limit end condition to stop generating the waveform if the potential level reaches the programmed source, or compliance, limit. The source limit is set to 105 percent of the selected potential measure range.

To enable the Source Limit end condition:

1. Press the **MENU** key, then select **End Conditions**.
2. Select the Source Limit Enabled control.
3. Select **On**.

Save or load the test parameter data

You can save your test parameters to the front-panel flash drive at any time. Up to five test parameter configurations can be stored.

To save the test parameters:

1. From the Menu screen, select **Save Settings**. Note that your Menu screen options are different depending on the test you are running.

NOTE

If you have saved a settings file previously with the same File Selection number, you will be prompted to overwrite it.

Figure 96: Selecting Save Settings

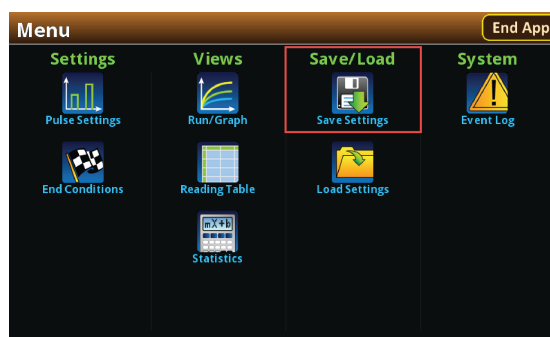

2. You are notified when the save is complete. Select **OK** to clear the prompt.

Figure 97: Successful file save

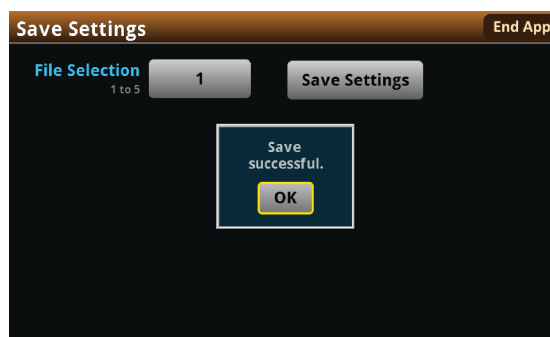

To load saved test parameters:

NOTE

Test parameters can only be loaded to the same instrument model on which they were created and saved. For example, you cannot load test parameter settings created with a 2450-EC to a 2460-EC.

1. From the Menu screen, select **Load Settings**.
2. Choose a file by selecting **File Selection** and then a file number.

Figure 98: Choosing a file to load



3. Select **Load Settings**. You will be notified when the load completes.
4. Select **OK** to clear the prompt.

Run the test and view the graph

To run the test and view the graph:

1. Press the **HOME** key.
2. Select **Start Test**. The output turns on and the display automatically shows the current measurements plotting in real time, along with a progress bar at the bottom of the screen. The Start Test control also changes to Stop Test for the duration of the test.

The output turns off when the test completes. The following graphic shows the test Home screen after the test finishes. You can return to this Home screen at any time when the test is running by selecting the Run / Graph option from the Menu screen.

Figure 99: Current Pulse and Square Wave test results graph

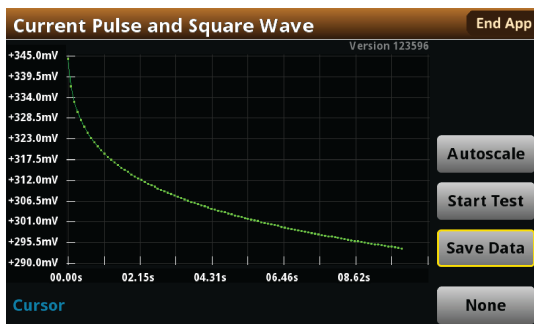

NOTE

You can use the touchscreen to manipulate the graph or add cursors. See your *Interactive SourceMeter® Instrument Reference Manual* for more information.

You can save a screen capture to a flash drive inserted into the USB port of the galvanostat by simultaneously pressing the **HOME** key and the **ENTER** key. The file name has the format `imgmmdd_XXXXXX.png`, where `mmdd` represents the instrument month and day and `XXXXXX` is a system-generated number.

NOTE

To end the test before the run completes, select **Stop Test** at any time. This stops the test and turns off the the galvanostat output. You can then select **End App** to exit the test and return to normal SMU operation. If there is a long interval between consecutive samples, there may be a long delay between selecting Stop Test and when the test stops, as the current operation must complete.

⚠ WARNING

Make sure to select Stop Test before selecting End App. Stop Test turns off the instrument's output.

Hazardous voltages may be present on all output and guard terminals. To prevent electrical shock that could cause injury or death, never make or break connections to the instrument while the power is turned on. Turn off the equipment from the front panel or disconnect the main power cord from the rear of the instrument before handling cables. Putting the equipment into an output-off state does not guarantee that the outputs are powered off if a hardware or software fault occurs.

Save the test data to the flash drive

You can save the data generated from the test to the front-panel flash drive. The data is stored in a `.csv` file that also includes instrument information and parameter settings.

If there are more than 10,000 measurements stored, the process of saving the data may take several minutes.

To save the test data to the flash drive:

1. Make sure your flash drive is inserted into the front panel USB port.
2. From the test application home screen, select **Save Data**.
3. Specify a file name, then select **OK**.
4. Select **OK** on the confirmation message.

Figure 100: Test results saved successfully

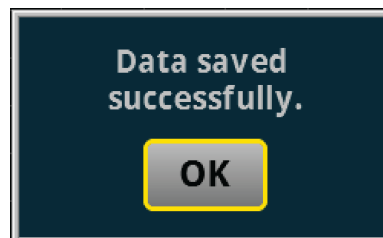

View the results saved to the flash drive

To view the test results, open the saved file in a spreadsheet program on a computer. Current, voltage, time, and general parameters for the test are included in the file.

View the Reading Table or measurement Statistics

When the test completes, you can view the individual data points on the instrument by selecting **Reading Table** from the Menu screen.

Figure 101: Viewing the Reading Table

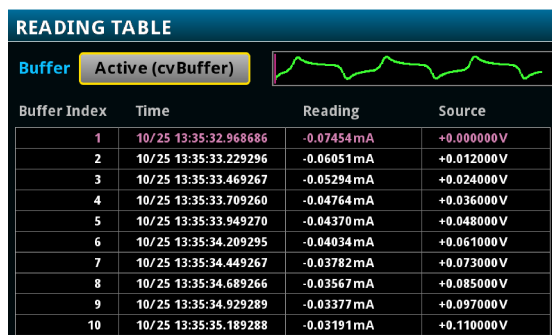

You can also view the measurement statistics. Select **Statistics** from the Menu screen.

Figure 102: Viewing measurement Statistics



View the Event Log

From the main Menu, you can select **Event Log**. The event log records events, which can be errors, warnings, and information reported by your instrument. Through the Event Log menu, you can view these events. You can also specify which events are shown in the event log, which ones are logged, and which ones generate popup messages.

Figure 103: Viewing the Event Log

System Events		Log Settings
Time	Code	Description
11/09 15:04	4917	Reading buffer defbuffer1 is 0% filled
11/09 15:04	4917	Reading buffer defbuffer2 is 0% filled
11/09 15:05	5084	Continuous readings unavailable with output off in resistanc

See your Keithley Instruments 2450, 2460, or 2461 *Interactive SourceMeter® Instrument Reference Manual* for further details on the Event Log.

End the test application

When you are finished making measurements, select **End App** to exit the test and return to normal SMU operation.

CAUTION

Make sure to always select **Stop Test** before selecting **End App**. **Stop Test** turns off the instrument's output.

Chronoamperometry

In this section:

Chronoamperometry 6-1

Chronoamperometry

In the Chronoamperometry test, your SMU potentiostat steps the potential to a user-defined value where it is held constant for a specified period. As this potential is held, the instrument measures the resulting current at user-defined time intervals. The SMU potentiostat can repeat this process for up to ten defined steps.

Key timing parameters are shown in the figure below. Note that there is always a measurement at the beginning of each step.

Figure 104: Example double-step Chronoamperometry (DSCA) plot

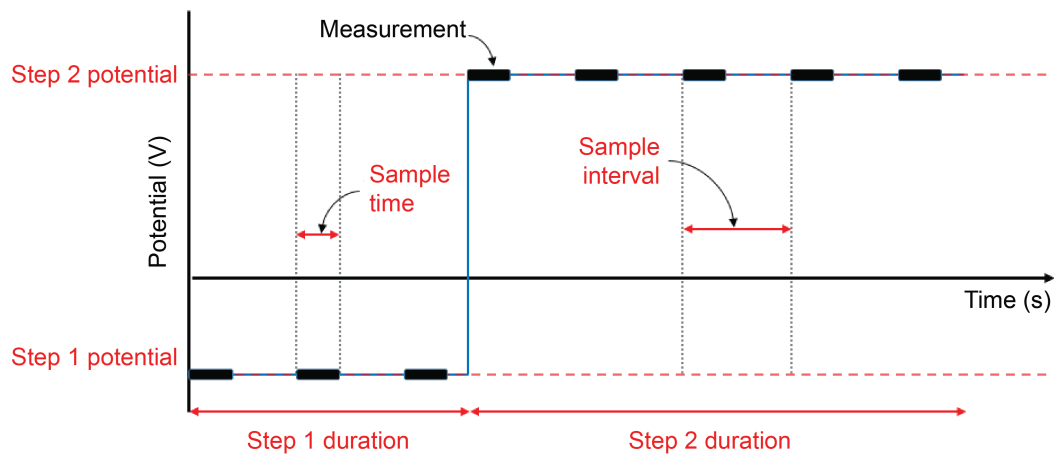

NOTE

To ensure proper instrument operation, the potential difference between the reference electrode (RE) and counter electrode (CE) terminals and between the working electrode (WE) and working electrode sense (WES) terminals should not exceed 5 V.

Test application parameters

CAUTION

You must enter test parameters that are consistent with the following values. Otherwise, you may receive unsettled and inaccurate measurements.

The Chronoamperometry test application parameters are listed below:

Model 2450-EC

- Step potential: $-20\text{ V} \leq \text{Estep} \leq +20\text{ V}$
- Current measure ranges: 10 nA, 100 nA, 1 μA , 10 μA , 100 μA , 1 mA, 10 mA, 100 mA, 1 A
- Source limit (compliance): 100 % of selected current range
- Number of steps: 1 to 10
- Step duration: $10\text{ ms} \leq \text{step duration} \leq 99,999\text{ s}$
- Sample interval: $10\text{ ms} \leq \text{sample interval} \leq 100\text{ s}$
- Sample time:
 - Minimum is 166.667 μs
 - Maximum is lesser of 166.667 ms and (sample interval - 5 ms) and (step duration - 5 ms)
- Maximum number of samples: 100,000 total for all steps

Models 2460-EC and 2461-EC

- Step potential: $-20\text{ V} \leq \text{Estep} \leq +20\text{ V}$
- Current measure ranges: 1 μA , 10 μA , 100 μA , 1 mA, 10 mA, 100 mA, 1 A, 4 A, 5 A, 7 A
- Source limit (compliance): 100 % of selected current range
- Number of steps: 1 to 10
- Step duration: $10\text{ ms} \leq \text{step duration} \leq 99,999\text{ s}$
- Sample interval: $10\text{ ms} \leq \text{sample interval} \leq 100\text{ s}$
- Sample time:
 - Minimum is 166.667 μs
 - Maximum is lesser of 166.667 ms and (sample interval - 5 ms) and (step duration - 5 ms)
- Maximum number of samples: 100,000 total for all steps

Run the Chronoamperometry test application

To run the test application:

1. Press the **HOME** key.
2. Select the active script indicator at the top of your home screen. If there is no script activity, the indicator displays "No Script."

Figure 105: Active script indicator

No Script

3. Select the preloaded Chronoamperometry test script (potentiostats and galvanostats only) or connect the supplied USB drive to your SMU instrument to locate the included Chronoamperometry test. If you connect the USB drive, scripts on the drive are displayed with usb1/ before the script file name.

Figure 106: Selecting the Chronoamperometry test application

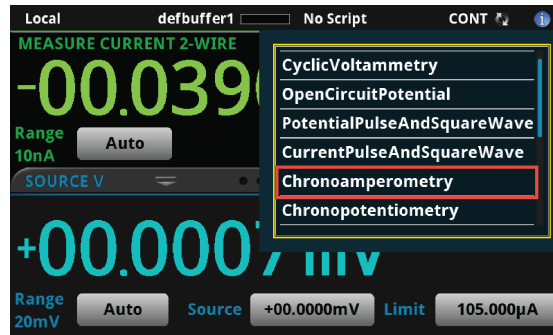

4. Select Chronoamperometry. The test application begins to run immediately and the following screen is displayed.

Figure 107: Chronoamperometry test home screen

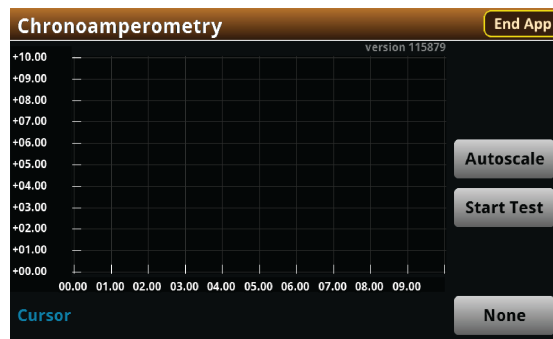

The test home screen controls include:

End App	Select this control to immediately stop the test and return to normal SMU operation.
Autoscale	Select this control to define the graph based upon the plotted data. This is useful for constraining all of the data to the screen's viewing size.
Start Test	Select this control to immediately begin the test. This option becomes Stop Test when the test runs.
Save Data	Select this control to save the test data to a .csv file on a flash drive. This option is only visible after the test runs.
Cursor	Select this control to cycle through the available cursor placements: None, Vertical, Horizontal, and Both.

Review the Menu controls

You have different options in the Menu screen, depending on the application. The following graphic shows the Chronoamperometry main Menu. You will learn the function for each option later in this section.

Figure 108: Chronoamperometry main Menu

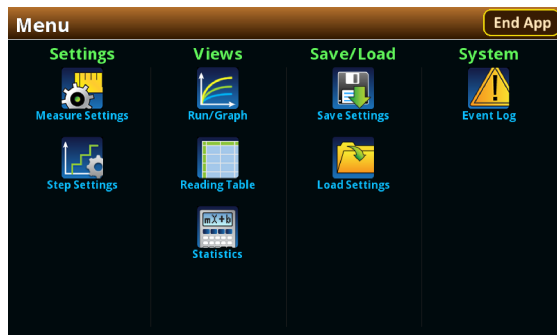

Configure the Step and Measure Settings

Select **Step Settings** to specify the number, level, and duration of potential steps to be sequentially executed.

Figure 109: Step Settings menu

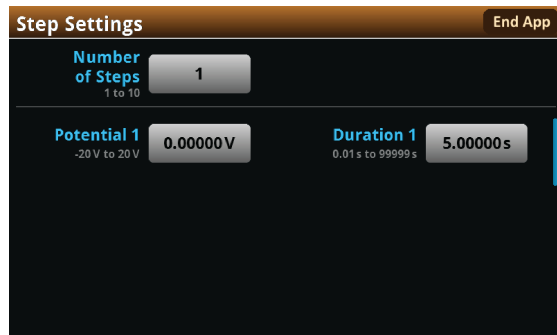

The Chronoamperometry test application allows you to add up to ten steps, though such multi-step procedures are not common. The most common protocols for Chronoamperometry tests use a single step.

To define the Number of Steps:

1. Press the **MENU** key, then select **Step Settings**.
2. Select **Number of Steps**.
3. Enter a value, then select **OK**. The next figure shows three steps defined.

Figure 110: Step Settings menu

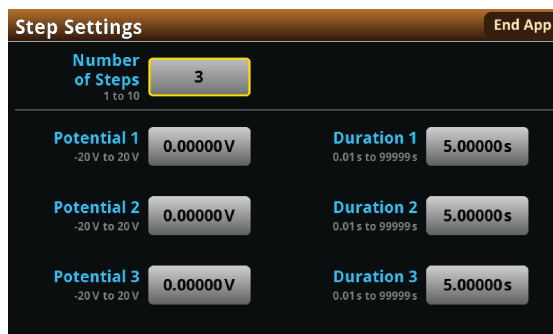

Next, you must define the **Potential** and **Duration** for each step.

To define the Potential and Duration:

1. From the Step Settings menu, select a step Potential.
2. Enter a step Potential value, then select **OK**.
3. Select a step Duration.
4. Enter a step Duration value, then select **OK**.

Now, you will define the measurement setting parameters of Current Range, Sample Time, and Sample Interval.

Figure 111: Measure Settings menu

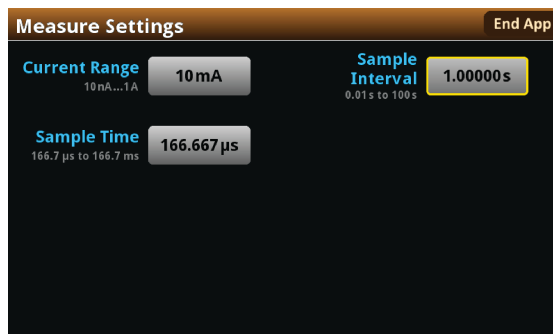

To select the Current Range:

1. From the Measure Settings window, select **Current Range**.
2. Choose a range greater than the highest current you expect to measure.

The available current ranges for the 2450-EC and 2460-EC / 2461-EC are shown in the next figure.

Figure 112: Selecting the Current Range

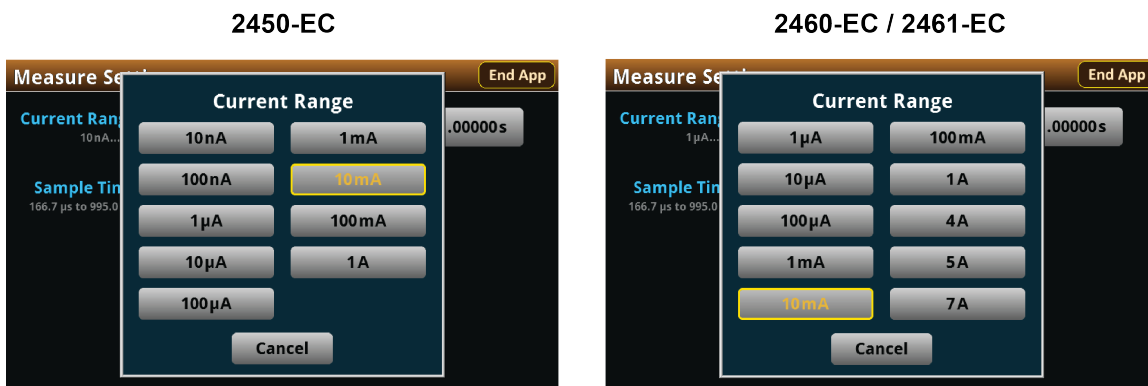

Your instrument will integrate and average the current over the Sample Time duration. Longer sample times will reduce the effect of noise on the measurement.

NOTE

The Current measure Range constrains the currents that will flow through the device under test (DUT). Make sure to choose a range higher than your expected maximum current. Setting the current range also sets a current limit, which can be used to stop the test or otherwise protect your DUT. Your potentiostat will limit the current to 105 percent of the selected range.

Now, you will specify the timing of consecutive measurements. This value is the time from the start of one measurement to the beginning of the next measurement during a particular potential step. The sample interval and sample time settings are related. The sample time can be no more than the sample interval minus 5 ms (SI - 5 ms). Adjusting the sample interval may also change the sample time setting automatically.

To specify the Sample Interval:

1. From the Measure Settings window, select **Sample Interval**.
2. Enter a value, then select **OK**.

Figure 113: Entering the Sample Interval

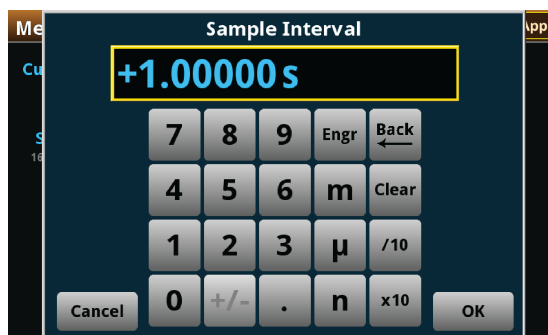

To select the Sample Time:

1. From the Measure Settings window, select **Sample Time**.
2. Enter a value, then select **OK**.

Figure 114: Entering the Sample Time**Save or load the test parameter data**

You can save your test parameters to the front-panel flash drive at any time. Up to five test parameter configurations can be stored.

To save the test parameters:

1. From the Menu screen, select **Save Settings**. Note that your Menu screen options are different depending on the test you are running.

NOTE

If you have saved a settings file previously with the same File Selection number, you will be prompted to overwrite it.

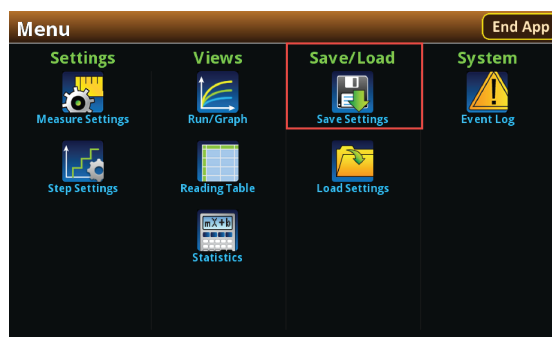
Figure 115: Selecting Save Settings

2. You are notified when the save is complete. Select **OK** to clear the prompt.

Figure 116: Successful file save

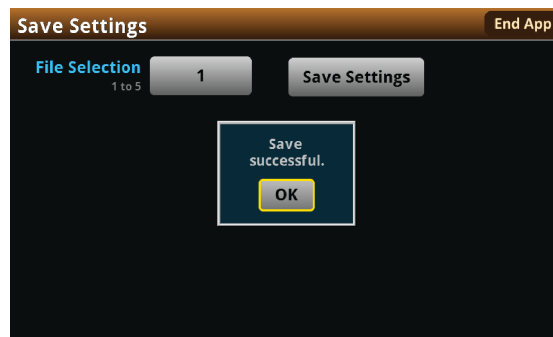

To load saved test parameters:

NOTE

Test parameters can only be loaded to the same instrument model on which they were created and saved. For example, you cannot load test parameter settings created with a 2450-EC to a 2460-EC.

1. From the Menu screen, select **Load Settings**.
2. Select a file by choosing **File Selection** and then a file number.

Figure 117: Choosing a file to load

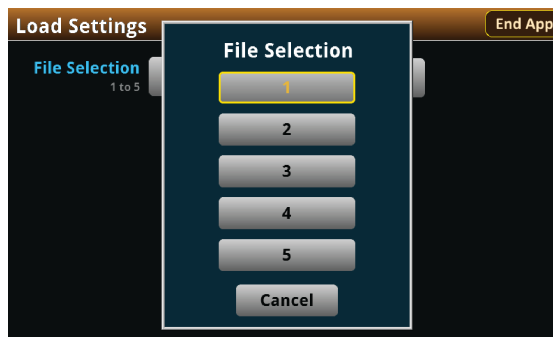

3. Select **Load Settings**. You are notified when the load completes.
4. Select **OK** to clear the prompt.

Run the test and view the graph

To start the experiment and view the graph:

1. Press the **HOME** key.
2. Select **Start Test**. The output turns on and the display automatically shows the current measurements plotting in real time, along with a progress bar at the bottom of the screen. The Start Test control also changes to Stop Test for the duration of the test.

The output turns off when the test completes. The following graphic shows the Home screen after the test finishes. You can return to this Home screen at any time when the test is running by selecting the Run / Graph option from the Menu screen.

Figure 118: Chronoamperometry test results graph

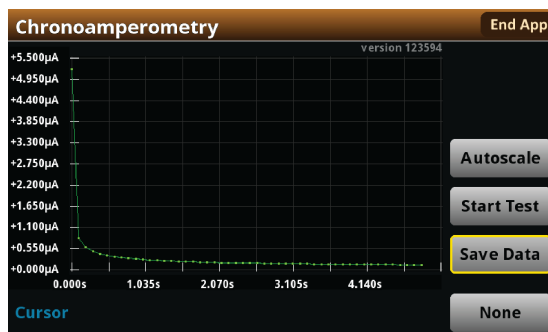

NOTE

You can use the touchscreen to manipulate the graph or add cursors. See your *Interactive SourceMeter® Instrument Reference Manual* for more information.

You can save a screen capture to a flash drive inserted into the USB port of the potentiostat by simultaneously pressing the **HOME** key and the **ENTER** key. The file name has the format `imgmmdd_XXXXXX.png`, where `mmdd` represents the instrument month and day and `XXXXXX` is a system-generated number.

NOTE

To end the test before the run completes, select **Stop Test** at any time. This stops the test and turns off the the potentiostat output. You can then select **End App** to exit the test and return to normal SMU operation. If there is a long interval between consecutive samples, there may be a long delay between selecting Stop Test and when the test stops, as the current operation must complete.

WARNING

Make sure to select Stop Test before selecting End App. Stop Test turns off the instrument's output.

Hazardous voltages may be present on all output and guard terminals. To prevent electrical shock that could cause injury or death, never make or break connections to the instrument while the power is turned on. Turn off the equipment from the front panel or disconnect the main power cord from the rear of the instrument before handling cables. Putting the equipment into an output-off state does not guarantee that the outputs are powered off if a hardware or software fault occurs.

Save the test data to the flash drive

You can save the data generated from the test to the front-panel flash drive. The data is stored in a .csv file that also includes instrument information and parameter settings.

If there are more than 10,000 measurements stored, the process of saving the data may take several minutes.

To save the test data to the flash drive:

1. Make sure your flash drive is inserted into the front panel USB port.
2. From the test application home screen, select **Save Data**.
3. Specify a file name, then select **OK**.
4. Select **OK** on the confirmation message.

Figure 119: Test results saved successfully

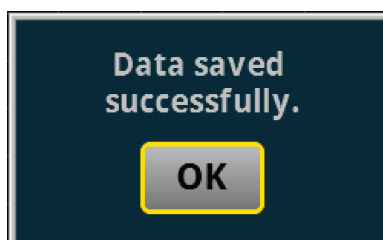

View the results saved to the flash drive

To view the test results, open the saved file in a spreadsheet program on a computer. Current, voltage, time, and general parameters for the test are included in the file.

View the Reading Table or measurement Statistics

When the test completes, you can view the individual data points on the instrument by selecting **Reading Table** from the Menu screen.

Figure 120: Viewing the Reading Table

READING TABLE			
Buffer	Active (cvBuffer) 		
Buffer Index	Time	Reading	Source
1	10/25 13:35:32.968686	-0.07454 mA	+0.000000 V
2	10/25 13:35:33.229296	-0.06051 mA	+0.012000 V
3	10/25 13:35:33.469267	-0.05294 mA	+0.024000 V
4	10/25 13:35:33.709260	-0.04764 mA	+0.036000 V
5	10/25 13:35:33.949270	-0.04370 mA	+0.048000 V
6	10/25 13:35:34.209295	-0.04034 mA	+0.061000 V
7	10/25 13:35:34.449267	-0.03782 mA	+0.073000 V
8	10/25 13:35:34.689266	-0.03567 mA	+0.085000 V
9	10/25 13:35:34.929289	-0.03377 mA	+0.097000 V
10	10/25 13:35:35.189288	-0.03191 mA	+0.110000 V

You can also view the measurement statistics. Select **Statistics** from the Menu screen.

Figure 121: Viewing measurement Statistics



Statistics		End App
Time	5.01972 s	
Points	5	
Minimum	-195.578 nA	
Maximum	-59.6046 nA	
Median	-128.523 nA	
Average	-128.150 nA	
Stddev	43.0009 nA	

View the Event Log

From the main Menu, you can select **Event Log**. The event log records events, which can be errors, warnings, and information reported by your instrument. Through the Event Log menu, you can view these events. You can also specify which events are shown in the event log, which ones are logged, and which ones generate popup messages.

Figure 122: Viewing the Event Log

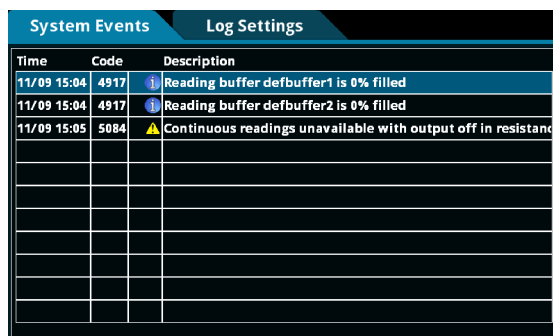

System Events		Log Settings
Time	Code	Description
11/09 15:04	4917	Reading buffer defbuffer1 is 0% filled
11/09 15:04	4917	Reading buffer defbuffer2 is 0% filled
11/09 15:05	5084	Continuous readings unavailable with output off in resistanc

See your Keithley Instruments 2450, 2460, or 2461 *Interactive SourceMeter® Instrument Reference Manual* for further details on the Event Log.

End the test application

When you are finished making measurements, select **End App** to exit the test and return to normal SMU operation.

CAUTION

Make sure to always select **Stop Test** before selecting **End App**. **Stop Test** turns off the instrument's output.

Chronopotentiometry

In this section:

Chronopotentiometry..... 7-1

Chronopotentiometry

In the Chronopotentiometry test, your SMU steps the supplied current to a user-defined value where it is held constant for a specified period. As this current is held, the instrument measures the resulting potential at user-defined time intervals. The SMU galvanostat can repeat this process for up to ten defined steps.

Key timing parameters are displayed in the figure below. Note that there is always a measurement at the beginning of each step.

Figure 123: Possible double-step Chronopotentiometry (DSCP) plot

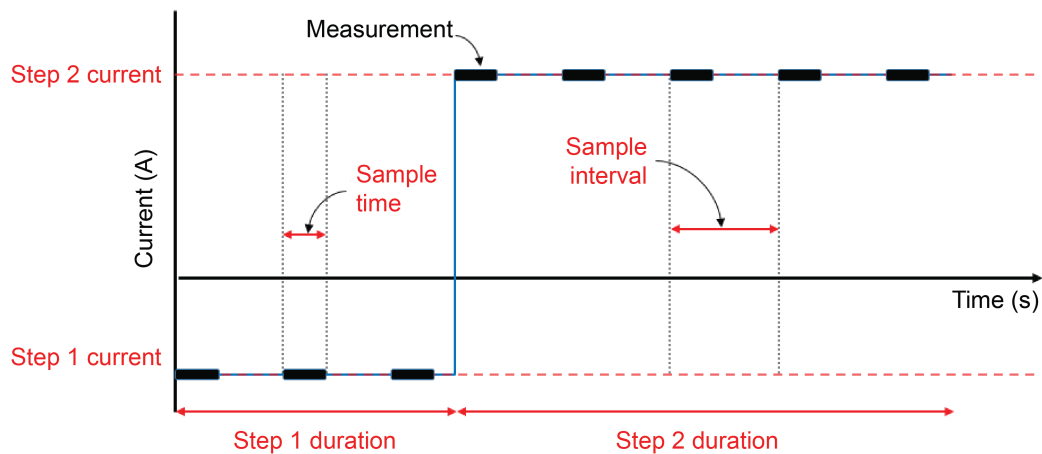

NOTE

To ensure proper instrument operation, the potential difference between the reference electrode (RE) and counter electrode (CE) terminals and between the working electrode (WE) and working electrode sense (WES) terminals should not exceed 5 V.

Test application parameters

CAUTION

You must enter test parameters that are consistent with the following values. Otherwise, you may receive unsettled and inaccurate measurements.

The Chronopotentiometry test application parameters are listed below:

Model 2450-EC

- Step current: $-1.05 \text{ A} \leq I_{\text{step}} \leq +1.05 \text{ A}$
- Potential measure ranges: 20 mV, 200 mV, 2 V, 20 V
- Source limit (compliance): 100 % of selected potential range
- Number of steps: 1 to 10
- Step duration: $10 \text{ ms} \leq \text{step duration} \leq 99,999 \text{ s}$
- Sample interval: $10 \text{ ms} \leq \text{sample interval} \leq 100 \text{ s}$
- Sample time:
 - Minimum is 166.667 μs
 - Maximum is lesser of 166.667ms and (sample interval - 5 ms) and (step duration - 5 ms)
- Maximum number of samples: 100,000 total for all steps

Models 2460-EC and 2461-EC

- Step current: $-7.35 \text{ A} \leq I_{\text{step}} \leq +7.35 \text{ A}$
- Potential measure ranges: 200 mV, 2 V, 7 V, 10 V, 20 V
- Source limit (compliance): 100 % of selected potential range
- Number of steps: 1 to 10
- Step duration: $10 \text{ ms} \leq \text{step duration} \leq 99,999 \text{ s}$
- Sample interval: $10 \text{ ms} \leq \text{sample interval} \leq 100 \text{ s}$
- Sample time:
 - Minimum is 166.667 μs
 - Maximum is lesser of 166.667 ms and (sample interval - 5 ms) and (step duration - 5 ms)
- Maximum number of samples: 100,000 total for all steps

Run the Chronopotentiometry test application

To run the test application:

1. Press the **HOME** key.
2. Select the active script indicator at the top of your home screen. If there is no script activity, the indicator displays "No Script."

Figure 124: Active script indicator

No Script

3. Select the preloaded Chronopotentiometry test script (potentiostats and galvanostats only) or connect the supplied USB drive to your SMU instrument to locate the included Chronopotentiometry test. If you connect the USB drive, test scripts on the drive are displayed with `usb1/` before the script file name.

Figure 125: Selecting the Chronopotentiometry test application

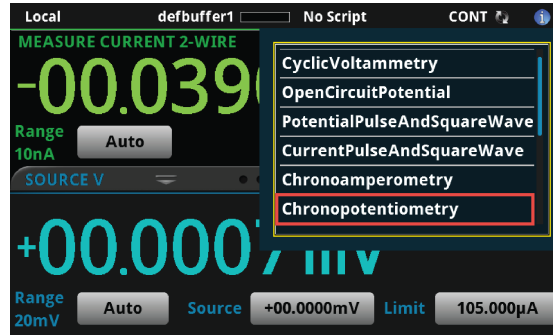

4. Select Chronopotentiometry. The test application begins to run immediately and the following screen is displayed.

Figure 126: Chronopotentiometry test home screen

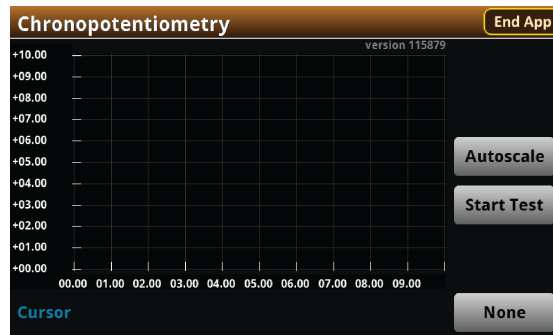

The test home screen controls include:

End App	Select this control to immediately stop the test and return to normal SMU operation.
Autoscale	Select this control to define the graph based upon the plotted data. This is useful for constraining all of the data to the screen's viewing size.
Start Test	Select this control to immediately begin the test. This option becomes Stop Test when the test runs.
Save Data	Select this control to save the test data to a <code>.csv</code> file on a flash drive. This option is only visible after the test runs.
Cursor	Select this control to cycle through the available cursor placements: None, Vertical, Horizontal, and Both.

Review the Menu controls

You have different options in the Menu screen, depending on the application. The following graphic shows the Chronopotentiometry main Menu. You will learn the function for each option later in this section.

Figure 127: Chronopotentiometry main Menu

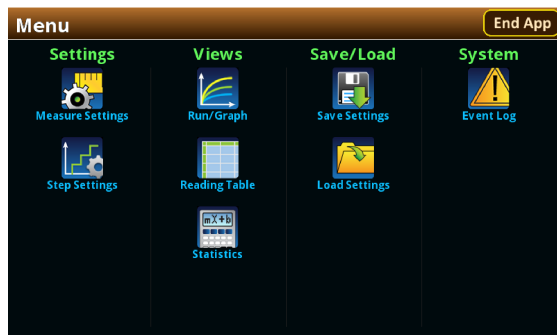

Configure the Step and Measure Settings

Select **Step Settings** to specify the number, level, and duration of current steps to be sequentially executed.

Figure 128: Step Settings menu

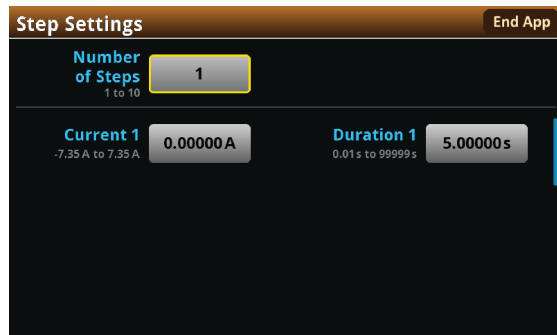

The Chronopotentiometry test application allows you to add up to ten steps, though such multi-step procedures are not common. The most common protocols for Chronopotentiometry tests use a single step.

Figure 129: Step Settings menu

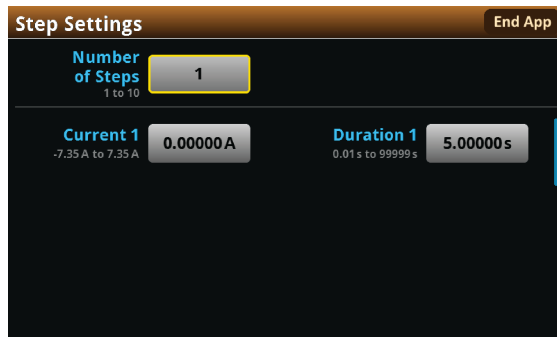

To define the Number of Steps:

1. Press the **MENU** key, then select **Step Settings**.
2. Select **Number of Steps**.
3. Enter a value, then select OK. The next figure shows three steps defined.

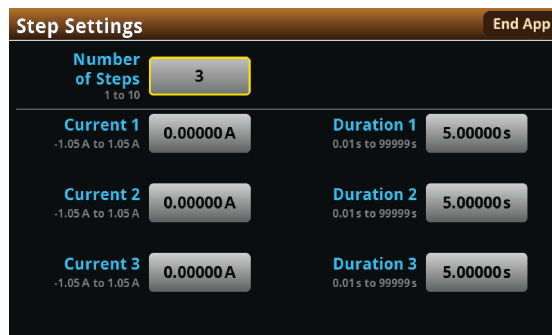
Figure 130: Step Settings menu

Next, you must define the **Current** and **Duration** for each step.

To define the Current and Duration:

1. From the Measure Settings menu, select a step Current.
2. Enter step Current value, then select **OK**.
3. Select a step Duration.
4. Enter a step Duration value, then select **OK**.

Now, you will define the Measure Settings parameters of Potential Range, Sample Time, and Sample Interval.

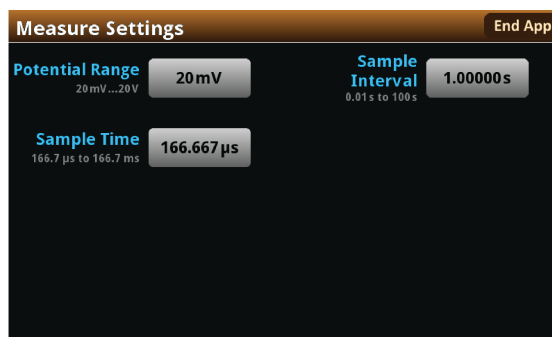
Figure 131: Measure Settings menu

To select the Potential Range:

1. From the Measure Settings window, select **Potential Range**.
2. Choose a range greater than the highest voltage you expect to measure.

The available potential ranges for the 2450-EC and 2460-EC / 2461-EC are shown in the next figure.

Figure 132: Selecting the Voltage Range

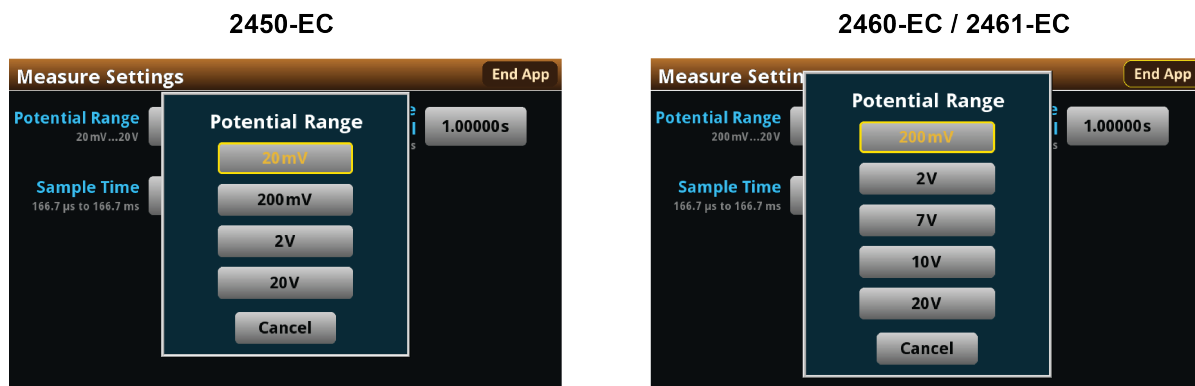

Your instrument will integrate and average the measurement over the Sample Time duration. Longer sample times will reduce the effect of noise on the measurement.

NOTE

The Potential measure Range constrains the potential that can develop across the device under test (DUT). Make sure to choose a range higher than your expected maximum potential. Setting the Potential Range also sets a potential limit, which can be used to stop the test or otherwise protect your DUT. Your galvanostat will limit the potential to 105 percent of the selected range.

Now, you will specify the timing of consecutive measurements. This value is the time from the start of one measurement to the beginning of the next measurement during a particular current step. The sample interval and sample time settings are related. The sample time can be no more than the sample interval minus 5 ms (SI - 5 ms). Adjusting the sample interval may also change the sample time setting automatically.

To set the Sample Interval:

1. From the Measure Settings window, select **Sample Interval**.
2. Enter a value, then select **OK**.

Figure 133: Entering the Sample Interval

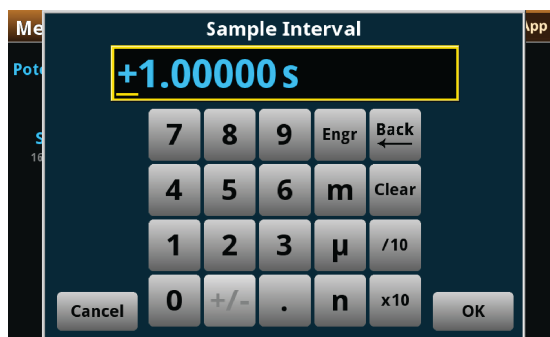

To select the Sample Time:

1. From the Measure Settings window, select **Sample Time**.
2. Enter a value, then select **OK**.

Figure 134: Entering the Sample Time**Save or load the test parameter data**

You can save your test parameters to the front-panel flash drive at any time. Up to five test parameter configurations can be stored.

To save the test parameters:

1. From the Menu screen, select **Save Settings**. Note that your Menu screen options are different depending on the test you are running.

NOTE

If you have saved a settings file previously with the same File Selection number, you will be prompted to overwrite it.

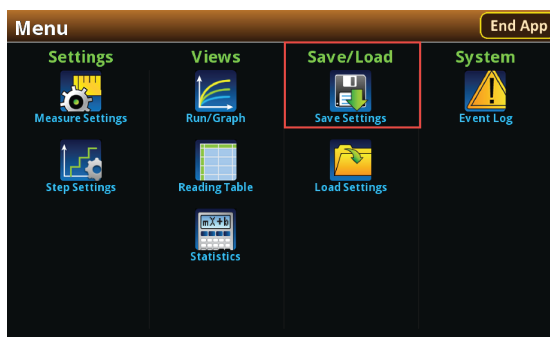
Figure 135: Selecting Save Settings

2. You are notified when the save is complete. Select **OK** to clear the prompt.

Figure 136: Successful file save

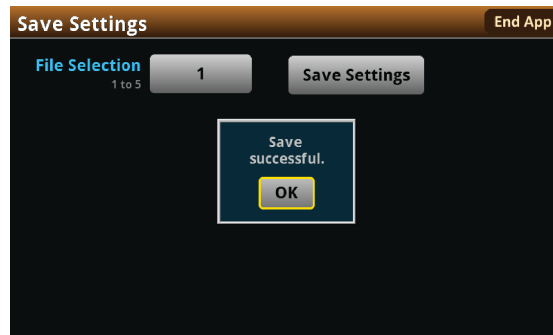

To load saved test parameters:

NOTE

Test parameters can only be loaded to the same instrument model on which they were created and saved. For example, you cannot load test parameter settings created with a 2450-EC to a 2460-EC.

1. From the Menu screen, select **Load Settings**.
2. Select a file by choosing **File Selection** and then a file number.

Figure 137: Choosing a file to load



3. Select **Load Settings**. You are notified when the load completes..
4. Select **OK** to clear the prompt.

Run the test and view the graph

To start the experiment and view the graph:

1. Press the **HOME** key.
2. Select **Start Test**. The output turns on and the display automatically shows the potential measurements plotting in real time, along with a progress bar at the bottom of the screen. The Start Test control also changes to Stop Test for the duration of the test.

The output turns off when the test completes. The following graphic shows the Home screen after the test finishes. You can return to this Home screen at any time when the test is running by selecting the Run / Graph option from the Menu screen.

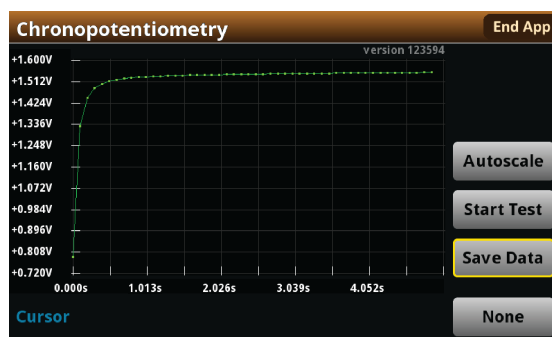

NOTE

You can use the touchscreen to manipulate the graph or add cursors. See your *Interactive SourceMeter® Instrument Reference Manual* for more information.

You can save a screen capture to a flash drive inserted into the USB port of the galvanostat by simultaneously pressing the **HOME** key and the **ENTER** key. The file name has the format `imgmdd_XXXXXX.png`, where `mdd` represents the instrument month and day and `XXXXXX` is a system-generated number.

NOTE

To end the test before the run completes, select **Stop Test** at any time. This stops the test and turns off the the galvanostat output. You can then select **End App** to exit the test and return to normal SMU operation. If there is a long interval between consecutive samples, there may be a long delay between selecting Stop Test and when the test stops, as the current operation must complete.

⚠ WARNING

Make sure to select Stop Test before selecting End App. Stop Test turns off the instrument's output.

Hazardous voltages may be present on all output and guard terminals. To prevent electrical shock that could cause injury or death, never make or break connections to the instrument while the power is turned on. Turn off the equipment from the front panel or disconnect the main power cord from the rear of the instrument before handling cables. Putting the equipment into an output-off state does not guarantee that the outputs are powered off if a hardware or software fault occurs.

Save the test data to the flash drive

You can save the data generated from the test to the front-panel flash drive. The data is stored in a .csv file that also includes instrument information and parameter settings.

If there are more than 10,000 measurements stored, the process of saving the data may take several minutes.

To save the test data to the flash drive:

1. Make sure your flash drive is inserted into the front panel USB port.
2. From the test application home screen, select **Save Data**.
3. Specify a file name, then select **OK**.
4. Select **OK** on the confirmation message.

Figure 138: Test results saved successfully

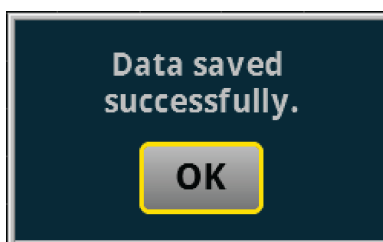

View the results saved to the flash drive

To view the test results, open the saved file in a spreadsheet program on a computer. Current, voltage, time, and general parameters for the test are included in the file.

View the Reading Table or measurement Statistics

When the test completes, you can view the individual data points on the instrument by selecting **Reading Table** from the Menu screen.

Figure 139: Viewing the Reading Table

READING TABLE			
Buffer	Active (cvBuffer)		
Buffer Index	Time	Reading	Source
1	10/25 13:35:32.968686	-0.07454 mA	+0.000000 V
2	10/25 13:35:33.229296	-0.06051 mA	+0.012000 V
3	10/25 13:35:33.469267	-0.05294 mA	+0.024000 V
4	10/25 13:35:33.709260	-0.04764 mA	+0.036000 V
5	10/25 13:35:33.949270	-0.04370 mA	+0.048000 V
6	10/25 13:35:34.209295	-0.04034 mA	+0.061000 V
7	10/25 13:35:34.449267	-0.03782 mA	+0.073000 V
8	10/25 13:35:34.689266	-0.03567 mA	+0.085000 V
9	10/25 13:35:34.929289	-0.03377 mA	+0.097000 V
10	10/25 13:35:35.189288	-0.03191 mA	+0.110000 V

You can also view the measurement statistics. Select **Statistics** from the Menu screen.

Figure 140: Viewing measurement Statistics

The screenshot shows a 'Statistics' screen with a dark background and a table of measurement data. The table has two columns: the first column lists statistical metrics, and the second column shows their corresponding values. An 'End App' button is visible in the top right corner.

Time	5.01972 s
Points	5
Minimum	-195.578 nA
Maximum	-59.6046 nA
Median	-128.523 nA
Average	-128.150 nA
Stddev	43.0009 nA

View the Event Log

From the main Menu, you can select **Event Log**. The event log records events, which can be errors, warnings, and information reported by your instrument. Through the Event Log menu, you can view these events. You can also specify which events are shown in the event log, which ones are logged, and which ones generate popup messages.

Figure 141: Viewing the Event Log

The screenshot shows the 'System Events' screen with a table of logged events. The table has three columns: 'Time', 'Code', and 'Description'. The first three rows contain event data, while the rest are empty.

Time	Code	Description
11/09 15:04	4917	Reading buffer defbuffer1 is 0% filled
11/09 15:04	4917	Reading buffer defbuffer2 is 0% filled
11/09 15:05	5084	Continuous readings unavailable with output off in resistanc

See your Keithley Instruments 2450, 2460, or 2461 *Interactive SourceMeter® Instrument Reference Manual* for further details on the Event Log.

End the test application

When you are finished making measurements, select **End App** to exit the test and return to normal SMU operation.

CAUTION

Make sure to always select **Stop Test** before selecting **End App**. **Stop Test** turns off the instrument's output.

Specifications are subject to change without notice.
All Keithley trademarks and trade names are the property of Keithley Instruments.
All other trademarks and trade names are the property of their respective companies.

Keithley Instruments
Corporate Headquarters • 28775 Aurora Road • Cleveland, Ohio 44139 • 440-248-0400 • Fax: 440-248-6168 • 1-800-935-5595 • www.tek.com/keithley



A Greater Measure of Confidence