

# Series 2260B Multi-Range Programmable DC Power Supplies

## Verification and Adjustment Manual

077104802 / November 2016



077104802

**Series 2260B**

**Programmable Power Supplies**

**Verification and Adjustment Manual**

© 2016, Keithley Instruments

Cleveland, Ohio, U.S.A.

All rights reserved.

Any unauthorized reproduction, photocopy, or use of the information herein, in whole or in part, without the prior written approval of Keithley Instruments is strictly prohibited.

All Keithley Instruments product names are trademarks or registered trademarks of Keithley Instruments. Other brand names are trademarks or registered trademarks of their respective holders.

Microsoft, Visual C++, Excel, and Windows are either registered trademarks or trademarks of Microsoft Corporation in the United States and/or other countries.

Document number: 077104802 / November 2016

The following safety precautions should be observed before using this product and any associated instrumentation. Although some instruments and accessories would normally be used with nonhazardous voltages, there are situations where hazardous conditions may be present.

This product is intended for use by qualified personnel who recognize shock hazards and are familiar with the safety precautions required to avoid possible injury. Read and follow all installation, operation, and maintenance information carefully before using the product. Refer to the user documentation for complete product specifications.

If the product is used in a manner not specified, the protection provided by the product warranty may be impaired.

The types of product users are:

**Responsible body** is the individual or group responsible for the use and maintenance of equipment, for ensuring that the equipment is operated within its specifications and operating limits, and for ensuring that operators are adequately trained.

**Operators** use the product for its intended function. They must be trained in electrical safety procedures and proper use of the instrument. They must be protected from electric shock and contact with hazardous live circuits.

**Maintenance personnel** perform routine procedures on the product to keep it operating properly, for example, setting the line voltage or replacing consumable materials. Maintenance procedures are described in the user documentation. The procedures explicitly state if the operator may perform them. Otherwise, they should be performed only by service personnel.

**Service personnel** are trained to work on live circuits, perform safe installations, and repair products. Only properly trained service personnel may perform installation and service procedures.

Keithley Instruments products are designed for use with electrical signals that are measurement, control, and data I/O connections, with low transient overvoltages, and must not be directly connected to mains voltage or to voltage sources with high transient overvoltages. Measurement Category II (as referenced in IEC 60664) connections require protection for high transient overvoltages often associated with local AC mains connections. Certain Keithley Instruments measuring instruments may be connected to mains. These instruments will be marked as category II or higher.

Unless explicitly allowed in the specifications, operating manual, and instrument labels, do not connect any instrument to mains.

Exercise extreme caution when a shock hazard is present. Lethal voltage may be present on cable connector jacks or test fixtures. The American National Standards Institute (ANSI) states that a shock hazard exists when voltage levels greater than 30 V RMS, 42.4 V peak, or 60 VDC are present. A good safety practice is to expect that hazardous voltage is present in any unknown circuit before measuring.

Operators of this product must be protected from electric shock at all times. The responsible body must ensure that operators are prevented access and/or insulated from every connection point. In some cases, connections must be exposed to potential human contact. Product operators in these circumstances must be trained to protect themselves from the risk of electric shock. If the circuit is capable of operating at or above 1000 V, no conductive part of the circuit may be exposed.

Do not connect switching cards directly to unlimited power circuits. They are intended to be used with impedance-limited sources. NEVER connect switching cards directly to AC mains. When connecting sources to switching cards, install protective devices to limit fault current and voltage to the card.

Before operating an instrument, ensure that the line cord is connected to a properly-grounded power receptacle. Inspect the connecting cables, test leads, and jumpers for possible wear, cracks, or breaks before each use.

When installing equipment where access to the main power cord is restricted, such as rack mounting, a separate main input power disconnect device must be provided in close proximity to the equipment and within easy reach of the operator.

For maximum safety, do not touch the product, test cables, or any other instruments while power is applied to the circuit under test. ALWAYS remove power from the entire test system and discharge any capacitors before: connecting or disconnecting cables or jumpers, installing or removing switching cards, or making internal changes, such as installing or removing jumpers.

Do not touch any object that could provide a current path to the common side of the circuit under test or power line (earth) ground. Always make measurements with dry hands while standing on a dry, insulated surface capable of withstanding the voltage being measured.

For safety, instruments and accessories must be used in accordance with the operating instructions. If the instruments or accessories are used in a manner not specified in the operating instructions, the protection provided by the equipment may be impaired.

Do not exceed the maximum signal levels of the instruments and accessories. Maximum signal levels are defined in the specifications and operating information and shown on the instrument panels, test fixture panels, and switching cards.

When fuses are used in a product, replace with the same type and rating for continued protection against fire hazard.

Chassis connections must only be used as shield connections for measuring circuits, NOT as protective earth (safety ground) connections.

If you are using a test fixture, keep the lid closed while power is applied to the device under test. Safe operation requires the use of a lid interlock.

If a  screw is present, connect it to protective earth (safety ground) using the wire recommended in the user documentation.

The  symbol on an instrument means caution, risk of danger. The user must refer to the operating instructions located in the user documentation in all cases where the symbol is marked on the instrument.

The  symbol on an instrument means caution, risk of electric shock. Use standard safety precautions to avoid personal contact with these voltages.

The  symbol on an instrument shows that the surface may be hot. Avoid personal contact to prevent burns.

The  symbol indicates a connection terminal to the equipment frame.

If this  symbol is on a product, it indicates that mercury is present in the display lamp. Please note that the lamp must be properly disposed of according to federal, state, and local laws.

The **WARNING** heading in the user documentation explains dangers that might result in personal injury or death. Always read the associated information very carefully before performing the indicated procedure.

The **CAUTION** heading in the user documentation explains hazards that could damage the instrument. Such damage may invalidate the warranty.

Instrumentation and accessories shall not be connected to humans.

Before performing any maintenance, disconnect the line cord and all test cables.

To maintain protection from electric shock and fire, replacement components in mains circuits — including the power transformer, test leads, and input jacks — must be purchased from Keithley Instruments. Standard fuses with applicable national safety approvals may be used if the rating and type are the same. The detachable mains power cord provided with the instrument may only be replaced with a similarly rated power cord. Other components that are not safety-related may be purchased from other suppliers as long as they are equivalent to the original component (note that selected parts should be purchased only through Keithley Instruments to maintain accuracy and functionality of the product). If you are unsure about the applicability of a replacement component, call a Keithley Instruments office for information.

Unless otherwise noted in product-specific literature, Keithley Instruments instruments are designed to operate indoors only, in the following environment: Altitude at or below 2,000 m (6,562 ft); temperature 0 °C to 50 °C (32 °F to 122 °F); and pollution degree 1 or 2.

To clean an instrument, use a damp cloth or mild, water-based cleaner. Clean the exterior of the instrument only. Do not apply cleaner directly to the instrument or allow liquids to enter or spill on the instrument. Products that consist of a circuit board with no case or chassis (e.g., a data acquisition board for installation into a computer) should never require cleaning if handled according to instructions. If the board becomes contaminated and operation is affected, the board should be returned to the factory for proper cleaning/servicing.

Safety precaution revision as of March 2016.

# Table of Contents

---

<b>Introduction.....</b>	<b>1-1</b>
Welcome .....	1-1
Extended warranty .....	1-1
Contact information .....	1-1
Series 2260B available models.....	1-2
<b>Verification preparation.....</b>	<b>2-1</b>
Verification information.....	2-1
Verification equipment.....	2-2
<b>Constant voltage verification .....</b>	<b>3-1</b>
Constant voltage (CV) verification tests .....	3-1
Voltage programming and measurement accuracy verification.....	3-1
Constant voltage load regulation verification.....	3-2
Constant voltage line regulation verification.....	3-3
Constant voltage ripple and noise verification .....	3-5
<b>Constant current verification .....</b>	<b>4-1</b>
Constant current (CC) verification tests .....	4-1
Current programming and measurement accuracy verification .....	4-1
Constant current load regulation verification .....	4-3
Constant current line regulation verification .....	4-4
Constant current noise verification .....	4-6
<b>Verification test record forms .....</b>	<b>5-1</b>
30 Volt verification test record.....	5-2
80 Volt verification test record.....	5-4
250 Volt verification record .....	5-6
800 Volt verification record .....	5-8
<b>2260B Adjustment equipment.....</b>	<b>6-1</b>
Adjustment equipment .....	6-1
<b>Analog interface adjustment.....</b>	<b>7-1</b>
Remove top cover .....	7-1
Confirm location of adjustment points.....	7-2
Analog interface adjustment procedure .....	7-3

<b>Constant voltage adjustment</b> .....	<b>8-1</b>
Connect device equipment .....	8-1
Constant voltage adjustment procedure .....	8-2
<b>Constant current adjustment</b> .....	<b>9-1</b>
Connect device equipment .....	9-1
Constant current adjustment procedure .....	9-2
<b>Adjustment code glossary</b> .....	<b>10-1</b>
Adjustment codes .....	10-2
<b>Index</b> .....	<b>1</b>

---

## Introduction

### In this section:

---

Welcome .....	1-1
Extended warranty .....	1-1
Contact information .....	1-1
Series 2260B available models .....	1-1

## Welcome

Thank you for choosing a Keithley Instruments product. The Series 2260B Programmable DC Power Supplies is designed for use in the laboratory and for test applications. It also has excellent regulation and low output voltage ripple. The digital displays provide accurate readings of voltage and current and also provide for easy, precise setting of output values using digital entry of current and voltage values. Output voltage can be set from the front panel, using a remote analog voltage or resistance, or over any of the digital interfaces: LAN, USB, GPIB, or RS-485. Voltage and current analog outputs are also available for remote monitoring and analog control.

## Extended warranty

Additional years of warranty coverage are available on many products. These valuable contracts protect you from unbudgeted service expenses and provide additional years of protection at a fraction of the price of a repair. Extended warranties are available on new and existing products. Contact your local Keithley Instruments representative for details.

## Contact information

If you have any questions after you review the information in this documentation, please contact your local Keithley Instruments office, sales partner, or distributor. You can also call the corporate headquarters of Keithley Instruments (toll-free inside the U.S. and Canada only) at 1-800-935-5595, or from outside the U.S. at +1-440-248-0400. For worldwide contact numbers, visit the [Keithley Instruments website](http://www.tek.com/keithley) (<http://www.tek.com/keithley>).

## Series 2260B available models

The 2260B series consists of 12 models, divided into three different model types covering four power capacities: 360 watt models, 720 watt models, and 1080 watt models.

Model number	Output voltage	Output current	Power
2260B-30-36	0 V to 30 V	0 A to 36 A	360 W
2260B-30-72	0 V to 30 V	0 A to 72 A	720 W
2260B-30-108	0 V to 30 V	0 A to 108 A	1080 W
2260B-80-13	0 V to 80 V	0 A to 13.5 A	360 W
2260B-80-27	0 V to 80 V	0 A to 27 A	720 W
2260B-80-40	0 V to 80 V	0 A to 40.5 A	1080 W
2260B-250-4	0 V to 250 V	0 A to 4.5 A	360 W
2260B-250-9	0 V to 250 V	0 A to 9 A	720 W
2260B-250-13	0 V to 250 V	0 A to 13.5 A	1080 W
2260B-800-1	0 V to 800 V	0 A to 1.44 A	360 W
2260B-800-2	0 V to 800 V	0 A to 2.88 A	720 W
2260B-800-4	0 V to 800 V	0 A to 4.32 A	1080 W



---

## Verification preparation

### In this section:

---

Verification information.....	2-1
Verification equipment.....	2-1

## Verification information

In order to ensure that the power supply is working properly and performance accuracy, we recommend that you use the equipment listed for verifying your equipment. Also, note the following conditions and parameters that you should follow when performing verification procedures.

It is recommended that you verify instrument specifications when:

- Using the power supply in a new environment.
- Removing the cover for any reason.

The following are the environmental conditions that are required when performing verification and adjustment:

- Indoor location only; no direct sunlight; dust free area
- Relative humidity <80%
- Temperature +18 to 28 °C (64 to 82 °F)
- Warm-up time  $\geq$ 30 minutes

If the verification fails:

- You will need to perform the adjustment procedure.
- If the adjustment does not accomplish the desired result you will have to send the instrument to your local Keithley Instruments office, sales partner, or distributor for repair (see [Contact Information](#) (on page 1-1).

## Verification equipment

Here is a list of the recommended equipment used for verifying the specifications of the programmable DC power supplies:

Type	Specifications	Recommended instrument
Precision current shunt	3 A (0.1 $\Omega$ ) 0.02% TC = 10 ppm / °C 30 A (0.01 $\Omega$ ) 0.02% TC = 10 ppm / °C 300 A (0.001 $\Omega$ ) 0.02% TC = 10 ppm / °C	GW Instek PCS-1000 or equivalent
Electronic loads	60 V, 240 A minimum with transient capability and a slew rate of 1 A/ $\mu$ s or better. 500 V, 60 A minimum with transient capability and a slew rate of 0.4 A/ $\mu$ s or better. 1000 V, 12 A minimum with transient capability and a slew rate of 0.2 A/ $\mu$ s or better.	Various manufacturers of programmable DC power supply for electronic loads
AC power supply	Adjustable to highest rated input voltage range Power: 3000 VA	Ametek 3001i or equivalent
Oscilloscope	Sensitivity: 1 mV Bandwidth limit: 20 MHz Probe: 1:1 with JEITA RC-9131B	Tektronix DPO4014B or equivalent
Digital multimeter	Voltage resolution: 0.1 mV Accuracy: <0.01% mV of reading	Keithley DMM 7510 or equivalent

Note that the following sections will indicate how to set up the equipment based on the type of verification that you are performing.

## Constant voltage verification

### In this section:

Constant voltage (CV) verification tests ..... 3-1

### Constant voltage (CV) verification tests

There are four verification tests in this series. These tests verify display panel accuracy, verify programmed voltage, measure output voltage changes based on load or no load, measure output voltage based on AC line voltage changes, and measure ripple and noise.

### Voltage programming and measurement accuracy verification

This test verifies that the voltage programming and measurement functions are within specifications.

#### ⚠ WARNING

*Hazardous voltages may be present on all output and guard terminals. To prevent electrical shock that could cause injury or death, never make or break connections to any of the instruments used for this verification test while instruments are powered on. Turn off the 2260B instrument from the front panel or disconnect the main power cord from the rear of the instrument before handling cables. Putting the equipment into an output-off state does not guarantee that the outputs are powered off if a hardware or software fault occurs. Precautions must be taken to prevent a shock hazard by surrounding the test device and any unprotected leads (wiring) with double insulation for up to 800 volts depending on the power supply that you have, Category I.*

Figure 1: 2260B Voltage adjustment devices

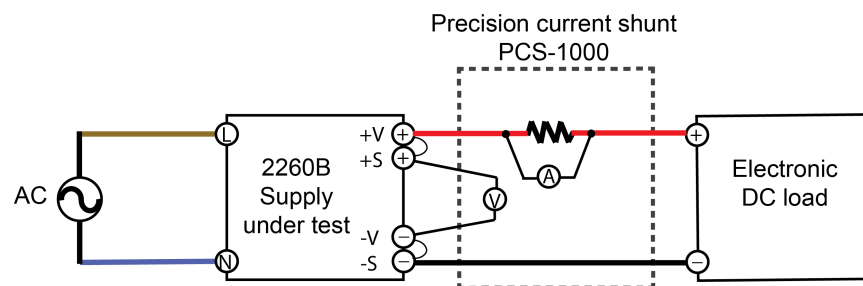

Before proceeding, make sure that the 2260B instrument is off.

**To perform voltage programming and measurement accuracy:**

1. Connect the AC power supply to the 2260B.
2. Connect the DMM on the PCS-1000 directly across the +S and -S terminals to an electronic DC load, as shown in the previous figure.
3. Turn on the 2260B and, if necessary, all of the other instruments.
4. Press the **Set** button on your 2260B and program the output voltage to 0.1 and the output current to its maximum value with the load off (see [Series 2260B available models](#) (on page 1-1)).
5. On the 2260B press the **Output** button. Note that CV is displayed on the 2260B front panel and the output current reading on the PCS-1000 should be approximately zero.
6. Record the DMM output voltage reading and the voltage indicated on the 2260B. The readings should be within the limits specified in the test record form for the appropriate model (see [Verification test record forms](#) (on page 5-1) for the appropriate model, under Voltage Programming and Measurement).
7. Program the output voltage to its maximum rated value (see [Series 2260B available models](#) (on page 1-1)).
8. Record the DMM output voltage reading and the voltage indicated on the 2260B.

The readings should be within the limits specified in the test record form for the appropriate model (see [Verification test record forms](#) (on page 5-1) for the appropriate model, under Voltage Programming and Measurement).

Verifying voltage programming and measurement accuracy is complete.

## Constant voltage load regulation verification

This test measures the change in output voltage resulting from a change from full load to no load.

### ⚠ WARNING

*Hazardous voltages may be present on all output and guard terminals. To prevent electrical shock that could cause injury or death, never make or break connections to any of the instruments used for this verification test while instruments are powered on. Turn off the 2260B instrument from the front panel or disconnect the main power cord from the rear of the instrument before handling cables. Putting the equipment into an output-off state does not guarantee that the outputs are powered off if a hardware or software fault occurs.*

*Precautions must be taken to prevent a shock hazard by surrounding the test device and any unprotected leads (wiring) with double insulation for up to 800 volts depending on the power supply that you have, Category I.*

Figure 2: 2260B Constant voltage load regulation

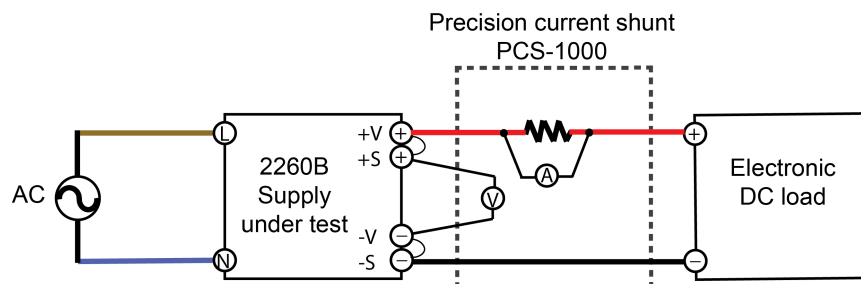

Before proceeding, make sure that the 2260B instrument is off.

**To perform CV load regulation verification:**

1. Connect the AC power supply to the 2260B.
2. Connect the DMM on the PCS-1000 directly across the +S and -S terminals to an electronic DC load, as shown in the previous figure.
3. Turn on the 2260B and, if necessary, all of the other instruments.
4. Press the **Set** button on your 2260B and program the output current to its maximum value and the output voltage to the maximum rated value (see [Series 2260B available models](#) (on page 1-1)).
5. On the 2260B press the **Output** button.
6. On the electronic DC load instrument, set the output load to 1 A. Note that CV is displayed on the 2260B front panel. If CV is not displayed, adjust the load so that the output current drops and CV is displayed.
7. Record the DMM output voltage reading.
8. Open the load and record the DMM voltage reading.

The difference between the DMM readings in steps 7 and 8 is the load effect, which should not exceed the value listed in the test record form (see [Verification test record forms](#) (on page 5-1) for the appropriate model, under CV load regulation).

Verifying CV load regulation is complete.

## Constant voltage line regulation verification

This test measures the change in output voltage resulting from a change in AC line voltage from the minimum to maximum value within the line voltage specifications.

### ⚠ WARNING

*Hazardous voltages may be present on all output and guard terminals. To prevent electrical shock that could cause injury or death, never make or break connections to any of the instruments used for this verification test while instruments are powered on. Turn off the 2260B instrument from the front panel or disconnect the main power cord from the rear of the instrument before handling cables. Putting the equipment into an output-off state does not guarantee that the outputs are powered off if a hardware or software fault occurs. Precautions must be taken to prevent a shock hazard by surrounding the test device and any unprotected leads (wiring) with double insulation for up to 800 volts depending on the power supply that you have, Category I.*

Figure 3: 2260B Constant voltage line regulation

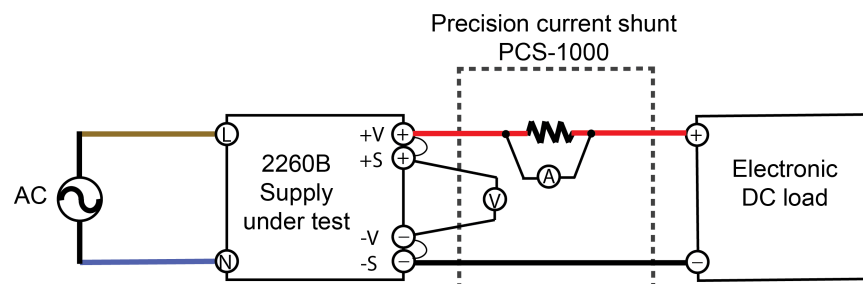

Before proceeding, make sure that the 2260B instrument is off.

**To perform CV line regulation verification:**

1. Connect the AC power supply to the 2260B.
2. Connect the DMM on the PCS-1000 directly across the +S and -S terminals to an electronic DC load, as shown in the previous figure.
3. Turn on the 2260B and, if necessary, all of the other instruments.
4. Set the variable AC voltage to nominal line voltage.
5. Press the **Set** button on the 2260B and program the output current to its maximum value and the output voltage to its maximum rated value (see [Series 2260B available models](#) (on page 1-1)).
6. On the 2260B press the **Output** button.
7. On the electronic DC load instrument, set the electronic output load to 1 A. Note that CV is displayed on the 2260B front panel. If CV is not displayed, adjust the load so that the output current drops and CV is displayed.
8. Adjust the AC power source to the low-line voltage (85 VAC for 100/120 nominal line; 170 VAC for 200/240 nominal line).
9. Record the DMM output voltage reading.
10. Adjust the AC power source to the high-line voltage (132 VAC for 100/120 nominal line; 265 VAC for 200/240 nominal line).
11. Record the DMM output voltage reading.

The difference between the DMM reading in steps 9 and 11 is the source effect, which should not exceed the value listed in the test record form (see [Verification test record forms](#) (on page 5-1) for the appropriate model, under CV line regulation).

Verifying CV line regulation is complete.

## Constant voltage ripple and noise verification

This test measures the DC output voltage with the (10:1) 50  $\Omega$  probe.

### **⚠ WARNING**

*Hazardous voltages may be present on all output and guard terminals. To prevent electrical shock that could cause injury or death, never make or break connections to any of the instruments used for this verification test while instruments are powered on. Turn off the 2260B instrument from the front panel or disconnect the main power cord from the rear of the instrument before handling cables. Putting the equipment into an output-off state does not guarantee that the outputs are powered off if a hardware or software fault occurs. Precautions must be taken to prevent a shock hazard by surrounding the test device and any unprotected leads (wiring) with double insulation for up to 800 volts depending on the power supply that you have, Category I.*

Figure 4: 2260B Constant voltage ripple noise verification

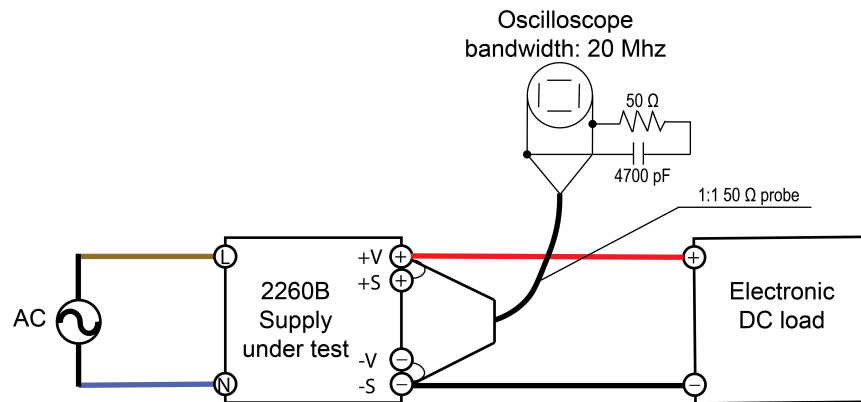

Before proceeding, make sure that the 2260B instrument is off.

**To perform CV ripple and noise verification:**

1. Connect the AC power supply to the 2260B.
2. Connect the DMM on the PCS-1000 directly across the +S and -S terminals to an electronic DC load, as shown in the previous figure.
3. Turn on the 2260B and, if necessary, all of the other instruments.
4. On the oscilloscope, set the AC coupling to 20 MHz bandwidth, the scale to 10 mV Sampling mode to average, and the measurement to peak-to-peak.
5. Press the **Set** button on your 2260B and program the power supply to output current to its maximum value and the output voltage to its maximum rated value (see [Series 2260B available models](#) (on page 1-1)).
6. On the 2260B press the **Output** button. Let the oscilloscope run for 20 seconds in order to generate enough measurement points. The result should not exceed the peak-to-peak limits in the test record form.
7. Use the DMM to measure the RMS noise voltage using AC voltage (see next figure).

The result should not exceed the RMS limits in the test record form (see [Verification test record forms](#) (on page 5-1) for the appropriate model, under CV ripple and noise - RMS).

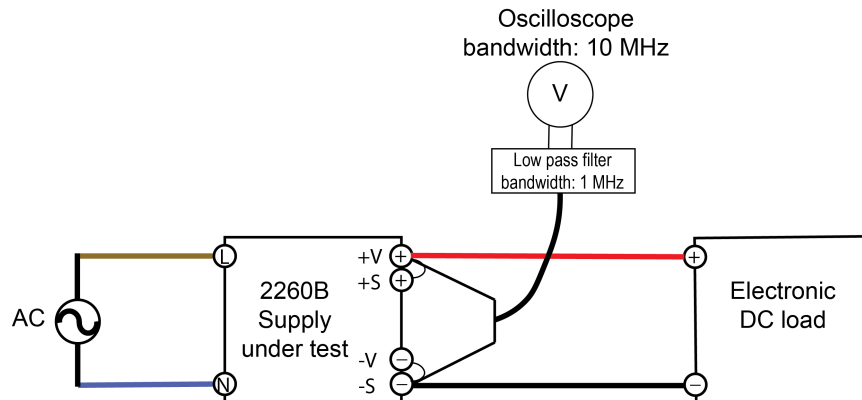

Verifying CV ripple and noise is complete.



## Constant current verification

### In this section:

Constant current verification tests ..... 4-1

### Constant current (CC) verification tests

There are four verification tests in this series. These tests verify display panel accuracy, verify programmed voltage, measure output voltage changes based on load or no load, measure output voltage based AC line voltage changes, and measure output noise.

### Current programming and measurement accuracy verification

This test verifies that the current programming and measurement functions are within specifications.

#### **⚠ WARNING**

*Hazardous voltages may be present on all output and guard terminals. To prevent electrical shock that could cause injury or death, never make or break connections to any of the instruments used for this verification test while instruments are powered on. Turn off the 2260B instrument from the front panel or disconnect the main power cord from the rear of the instrument before handling cables. Putting the equipment into an output-off state does not guarantee that the outputs are powered off if a hardware or software fault occurs. Precautions must be taken to prevent a shock hazard by surrounding the test device and any unprotected leads (wiring) with double insulation for up to 800 volts depending on the power supply that you have, Category I.*

Figure 5: 2260B Current analog adjustment devices

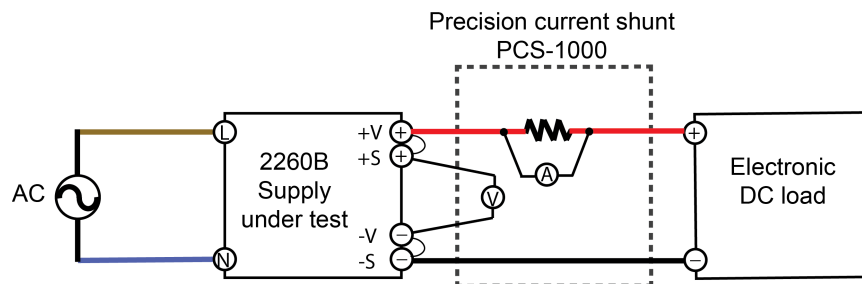

Before proceeding, make sure that the 2260B instrument is off.

**To perform current programming and measurement accuracy:**

1. Connect the AC power supply.
2. Connect the current input on the PCS-1000 across the +S and -S terminals through an electronic DC load, as shown in the previous figure.
3. Turn on the 2260B and, if necessary, all of the other instruments.
4. Press the **Set** button on the 2260B, program the output voltage to 15 volts and set the output current to zero (see [Series 2260B available models](#) (on page 1-1), if needed).
5. Set the electronic load to a short and on the 2260B press the **Output** button. Note that CC is displayed on the 2260B front panel.
6. Record the precision current shunt (PCS-1000) input current readings and the current indicated on the 2260B. The readings should be within the limits specified in the test record form for the appropriate model (see [Verification test record forms](#) (on page 5-1) for the appropriate model, under Current Programming and Measurement, if needed).
7. Program the output current to its maximum rated value (see [Series 2260B available models](#) (on page 1-1), if needed).
8. Set the electronic load to a short.
9. Record the precision current shunt (PCS-1000) input current readings and the current indicated on the 2260B.

The readings should be within the limits specified in the test record form for the appropriate model (see [Verification test record forms](#) (on page 5-1) for the appropriate model, under Current Programming and Measurement, if needed).

Verifying Current Programming and Measurement Accuracy is complete.

## Constant current load regulation verification

This test measures the change in output current resulting from a change from full scale to short circuit.

### ⚠ WARNING

*Hazardous voltages may be present on all output and guard terminals. To prevent electrical shock that could cause injury or death, never make or break connections to any of the instruments used for this verification test while instruments are powered on. Turn off the 2260B instrument from the front panel or disconnect the main power cord from the rear of the instrument before handling cables. Putting the equipment into an output-off state does not guarantee that the outputs are powered off if a hardware or software fault occurs. Precautions must be taken to prevent a shock hazard by surrounding the test device and any unprotected leads (wiring) with double insulation for up to 800 volts depending on the power supply that you have, Category I.*

Figure 6: 2260B Constant current load regulation

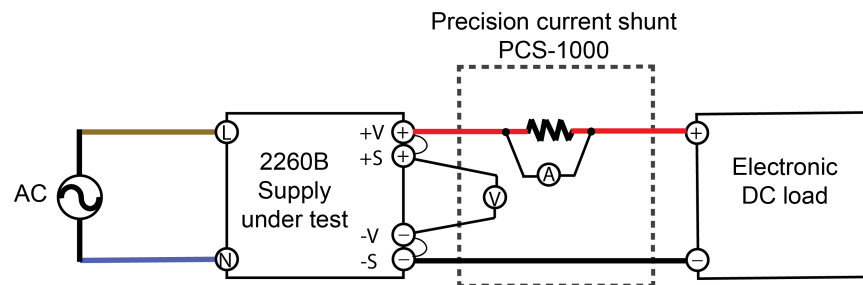

Before proceeding, make sure that the 2260B instrument is off.

#### To perform CC load regulation verification:

1. Connect the AC power supply.
2. Connect the current input on the PCS-1000 across the +S and -S terminals through an electronic DC load, as shown in the previous figure.
3. Turn on the 2260B and, if necessary, all of the other instruments.
4. With the electronic load in CR mode, press the **Set** button and program the 2260B output voltage to 15 volts.
5. Press the **Output** button on your 2260B.
6. Using the electronic load, set the output current to the maximum rated output. Note that CC is displayed on the 2260B front panel. If CC is not displayed, adjust the load so that the voltage drops and CC is displayed.
7. Record the PCS-1000 input current reading.
8. Short the electronic load and record the indicated current reading on the PCS-1000.

The difference in the current readings in steps 7 and 8 is the load effect, which should not exceed the value listed in the test record form for the appropriate model (see [Verification test record forms](#) (on page 5-1) for the appropriate model, under CC load regulation, if needed).

Verifying CC load regulation is complete.

## Constant current line regulation verification

This test measures the change in output current that results from a change in AC line voltage from the minimum to maximum value within the line voltage specifications.

### ⚠ WARNING

*Hazardous voltages may be present on all output and guard terminals. To prevent electrical shock that could cause injury or death, never make or break connections to any of the instruments used for this verification test while instruments are powered on. Turn off the 2260B instrument from the front panel or disconnect the main power cord from the rear of the instrument before handling cables. Putting the equipment into an output-off state does not guarantee that the outputs are powered off if a hardware or software fault occurs. Precautions must be taken to prevent a shock hazard by surrounding the test device and any unprotected leads (wiring) with double insulation for up to 800 volts depending on the power supply that you have, Category I.*

Figure 7: 2260B Constant current line regulation

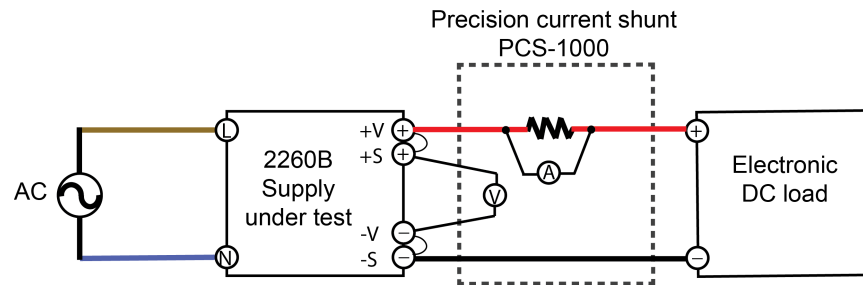

Before proceeding, make sure that the 2260B instrument is off.

**To perform CC line regulation verification:**

1. Connect the AC power supply.
2. Connect the PCS-1000 current input across the +S and -S terminals through an electronic DC load, as shown in the previous figure.
3. Turn on the 2260B and, if necessary, all of the other instruments.
4. Set the variable AC voltage to nominal line voltage.
5. On your 2260B press the **Set** button and program the output current to its maximum rated value (see [Series 2260B available models](#) (on page 1-1), if needed).
6. Press the **Output** button on your 2260B.
7. With the electronic load in CR mode short the load and program the 2260B output voltage to 15 volts. Note that CC is displayed on the 2260B front panel. If CC is not displayed, adjust the load so that the voltage drops and CC is displayed.
8. Adjust the AC power source to the low-line voltage (85 VAC for 100/120 nominal line; 170 VAC for 200/240 nominal line).
9. Record the PCS-1000 input current reading.
10. Adjust the AC power source to the high-line voltage (132 VAC for 100/120 nominal line; 265 VAC for 200/240 nominal line).
11. Record the PCS-1000 input current reading.

The difference between the PCS-1000 reading in steps 9 and 11 is the source effect, which should not exceed the value listed in the test record form (see [Verification test record forms](#) (on page 5-1) for the appropriate model, under CV line regulation, if needed).

Verifying CC line regulation is complete.

## Constant current noise verification

This test measures the AC output voltage with the PCS-1000 and DMM.

### ⚠ WARNING

*Hazardous voltages may be present on all output and guard terminals. To prevent electrical shock that could cause injury or death, never make or break connections to any of the instruments used for this verification test while instruments are powered on. Turn off the 2260B instrument from the front panel or disconnect the main power cord from the rear of the instrument before handling cables. Putting the equipment into an output-off state does not guarantee that the outputs are powered off if a hardware or software fault occurs. Precautions must be taken to prevent a shock hazard by surrounding the test device and any unprotected leads (wiring) with double insulation for up to 800 volts depending on the power supply that you have, Category I.*

Figure 8: 2260B Constant current noise verification

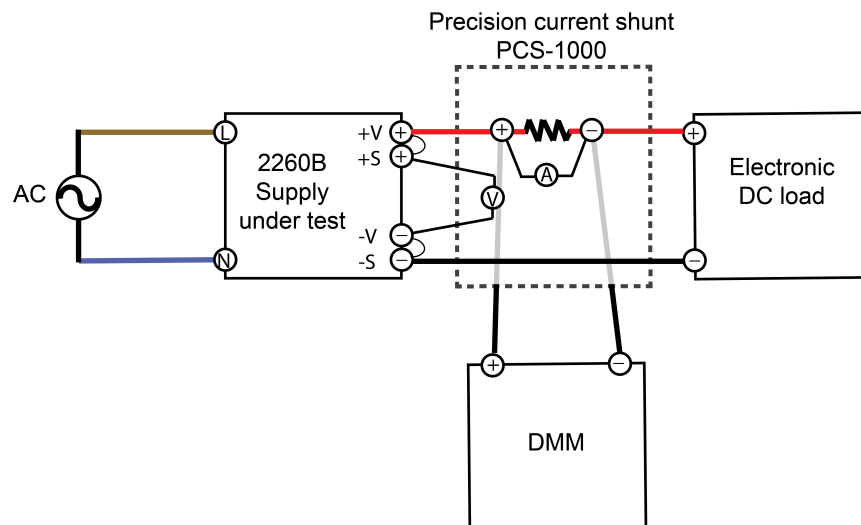

Before proceeding, make sure that the 2260B instrument is off.

#### To perform CC noise verification:

1. Connect the AC power supply.
2. Connect the PCS-1000 current input across the +S and -S terminals through an electronic DC load (see previous figure).
3. Turn on the 2260B and, if necessary, all of the other instruments.
4. Press the **Set** button on your 2260B and program the power supply output current to its maximum value and the output voltage to 15 volts (see [Series 2260B available models](#) (on page 1-1), if needed).
5. On the 2260B press the **Output** button.
6. Use the DMM to measure the RMS noise voltage using AC voltage (see previous figure).

The result should not exceed the RMS limits in the test record form (see [Verification test record forms](#) (on page 5-1) for the appropriate model, under CV ripple and noise - RMS, if needed).

Verifying CC ripple and noise is complete.

---

## Verification test record forms

**In this section:**

---

30 Volt verification test record .....	5-1
80 Volt verification test record .....	5-4
250 Volt verification record.....	5-6
800 Volt verification record.....	5-8

### 30 Volt verification test record

Print this page and record your verification results that can be used for reference in the future. Make sure to keep this record with your power supply.

Model	<input type="checkbox"/> 2260B-30-36	<input type="checkbox"/> 2260B-30-72	<input type="checkbox"/> 2260B-30-108
Serial number:	_____		
Verified by	Name: _____		
	Company/contact: _____		
	Year: _____	Month: _____	Day: _____
Environment	Temperature: _____	Humidity: _____	

**Constant voltage tests:**

Voltage programming and measurement	Model	Minimum specifications	Results	Maximum specifications
Minimum voltage out	All	-10.1 mV		+10.1 mV
Measurement accuracy	All	-20.1 mV		+20.1 mV
Rated voltage out	All	29.960 V		30.040 V
Measurement accuracy	All	29.95 V		30.5 V

CV load regulation	Model	Minimum specifications	Results	Maximum specifications
	All	-20 mV		+20 mV

CV line regulation	Model	Minimum specifications	Results	Maximum specifications
	All	-18 mV		+18 mV

CV ripple and noise	Model	Minimum specifications	Results	Maximum specifications
Peak-to-peak	30-36	N/A		60 mV
	30-72	N/A		80 mV
	30-108	N/A		100 mV
RMS	30-36	N/A		7 mV
	30-72	N/A		11 mV
	30-108	N/A		14 mV



**Constant current tests:**

<b>Current programming and measurement</b>	<b>Model</b>	<b>Minimum specifications</b>	<b>Results</b>	<b>Maximum specifications</b>
Minimum current out	30-36	-30 mA		+30 mA
	30-72	-60 mA		+60 mA
	30-108	-100 mA		+100 mA
Measurement accuracy	30-36	-40 mA		+40 mA
	30-72	-70 mA		+70 mA
	30-108	-100 mA		+100 mA
Rated current out	30-36	35.934 A		36.066 A
	30-72	71.898 A		72.102 A
	30-108	107.862 A		108.138 A
Measurement accuracy	30-36	35.924 A		36.076 A
	30-72	71.858 A		72.142 A
	30-108	107.79 A		108.21 A

<b>CC load regulation</b>	<b>Model</b>	<b>Minimum specifications</b>	<b>Results</b>	<b>Maximum specifications</b>
	30-36	-41 mA		+41 mA
	30-72	-77 mA		+77mA
	30-108	-113 mA		+113 mA

<b>CC line regulation</b>	<b>Model</b>	<b>Minimum specifications</b>	<b>Results</b>	<b>Maximum specifications</b>
	30-36	-41 mA		+41 mA
	30-72	-77 mA		+77mA
	30-108	-113 mA		+113 mA

## 80 Volt verification test record

Print this page and record your verification results that can be used for reference in the future. Make sure to keep this record with your power supply.

Model	<input type="checkbox"/> 2260B-80-13	<input type="checkbox"/> 2260B-80-27	<input type="checkbox"/> 2260B-80-40
Serial number:			
Verified by	Name:		
	Company/contact:		
	Year:	Month:	Day:
Environment	Temperature:	Humidity:	

### Constant voltage tests:

Voltage programming and measurement	Model	Minimum specifications	Results	Maximum specifications
Minimum voltage out	All	-10.1 mV		+10.1 mV
Measurement accuracy	All	-20.1 mV		+20.1 mV
Rated voltage out	All	79.91 V		80.090 V
Measurement accuracy	All	79.9 V		80.1 V

CV load regulation	Model	Minimum specifications	Results	Maximum specifications
	All	-45 mV		+45 mV

CV line regulation	Model	Minimum specifications	Results	Maximum specifications
	All	-43 mV		+43 mV

CV ripple and noise	Model	Minimum specifications	Results	Maximum specifications
Peak-to-peak	80-13	N/A		60 mV
	80-27	N/A		80 mV
	80-40	N/A		100 mV
RMS	80-13	N/A		7 mV
	80-27	N/A		11 mV
	80-40	N/A		14 mV

**Constant current tests:**

<b>Current programming and measurement</b>	<b>Model</b>	<b>Minimum specifications</b>	<b>Results</b>	<b>Maximum specifications</b>
Minimum current out	80-13	-10 mA		+10 mA
	80-27	-30 mA		+30 mA
	80-40	-40 mA		+40 mA
Measurement accuracy	80-13	-20 mA		+20 mA
	80-27	-40 mA		+40 mA
	80-40	-50 mA		+50 mA
Rated current out	80-13	12.87 A		13.13 A
	80-27	26.943 A		27.057 A
	80-40	39.92 A		40.080 A
Measurement accuracy	80-13	12.967 A		13.033 A
	80-27	26.933 A		27.067 A
	80-40	39.91 A		30.09 A

<b>CC load regulation</b>	<b>Model</b>	<b>Minimum specifications</b>	<b>Results</b>	<b>Maximum specifications</b>
	80-13	-18 mA		+18 mA
	80-27	-32 mA		+32 mA
	80-40	-45 mA		+45 mA

<b>CC line regulation</b>	<b>Model</b>	<b>Minimum specifications</b>	<b>Results</b>	<b>Maximum specifications</b>
	80-13	-18 mA		+18 mA
	80-27	-32 mA		+32 mA
	80-40	-45 mA		+45 mA

## 250 Volt verification record

Print this page and record your verification results that can be used for reference in the future. Make sure to keep this record with your power supply.

Model	<input type="checkbox"/> 2260B-250-4	<input type="checkbox"/> 2260B-250-9	<input type="checkbox"/> 2260B-250-13
Serial number:			
Verified by	Name:		
	Company/contact:		
	Year:	Month:	Day:
Environment	Temperature:	Humidity:	

### Constant voltage tests:

Voltage programming and measurement	Model	Minimum specifications	Results	Maximum specifications
Minimum voltage out	All	-200 mV		+200 mV
Measurement accuracy	All	-200 mV		+200 mV
Rated voltage out	All	249.47 V		250.53 V
Measurement accuracy	All	249.47 V		250.53 V

CV load regulation	Model	Minimum specifications	Results	Maximum specifications
	All	-130 mV		+130 mV

CV line regulation	Model	Minimum specifications	Results	Maximum specifications
	All	-128 mV		+128 mV

CV ripple and noise	Model	Minimum specifications	Results	Maximum specifications
Peak-to-peak	250-4	N/A		80 mV
	250-9	N/A		100 mV
	250-13	N/A		120 mV
RMS	250-4	N/A		15 mV
	250-9	N/A		15 mV
	250-13	N/A		15 mV

**Constant current tests:**

<b>Current programming and measurement</b>	<b>Model</b>	<b>Minimum specifications</b>	<b>Results</b>	<b>Maximum specifications</b>
Minimum current out	250-4	-5 mA		+5 mA
	250-9	-10 mA		+10 mA
	250-13	-15 mA		+15 mA
Measurement accuracy	250-4	-5 mA		+5 mA
	250-9	-10 mA		+10 mA
	250-13	-20 mA		+20 mA
Rated current out	250-4	3.991 A		4.001 A
	250-9	8.9810 A		9.0190 A
	250-13	12.972 A		13.028 A
Measurement accuracy	250-4	3.991 mA		4.001 mA
	250-9	8.981 A		9.019 A
	250-13	12.967 A		13.033 A

<b>CC load regulation</b>	<b>Model</b>	<b>Minimum specifications</b>	<b>Results</b>	<b>Maximum specifications</b>
	250-4	-9.000 mA		+9.000 mA
	250-9	-14.000 mA		+14.000 mA
	250-13	-18.00 mA		+18.00 mA

<b>CC line regulation</b>	<b>Model</b>	<b>Minimum specifications</b>	<b>Results</b>	<b>Maximum specifications</b>
	250-4	-9.5 mA		+9.5 mA
	250-9	-14 mA		+14 mA
	250-13	-18.5 mA		+18.5 mA

## 800 Volt verification record

Print this page and record your verification results that can be used for reference in the future. Make sure to keep this record with your power supply.

Model	<input type="checkbox"/> 2260B-800-1	<input type="checkbox"/> 2260B-800-2	<input type="checkbox"/> 2260B-800-4
Serial number:			
Verified by	Name:		
	Company/contact:		
	Year:	Month:	Day:
Environment	Temperature:	Humidity:	

### Constant voltage tests:

Voltage programming and measurement	Model	Minimum specifications	Results	Maximum specifications
Minimum voltage out	All	-400 mV		+400 mV
Measurement accuracy	All	-400 mV		+400 mV
Rated voltage out	All	798.8 V		801.2 V
Measurement accuracy	All	798.8 V		801.2 V

CV load regulation	Model	Minimum specifications	Results	Maximum specifications
	All	-405 mV		+405 mV

CV line regulation	Model	Minimum specifications	Results	Maximum specifications
	All	-403 mV		+403 mV

CV ripple and noise	Model	Minimum specifications	Results	Maximum specifications
Peak-to-peak	800-1	N/A		150 mV
	800-2	N/A		200 mV
	800-4	N/A		200 mV
RMS	800-1	N/A		30 mV
	800-2	N/A		30 mV
	800-4	N/A		30 mV

**Constant current tests:**

<b>Current programming and measurement</b>	<b>Model</b>	<b>Minimum specifications</b>	<b>Results</b>	<b>Maximum specifications</b>
Minimum current out	800-1	-2 mA		+2 mA
	800-2	-4 mA		+4 mA
	800-4	-6 mA		+6 mA
Measurement accuracy	800-1	-2 mA		+2 mA
	800-2	-4 mA		+4 mA
	800-4	-6 mA		+6 mA
Rated current out	800-1	0.997 A		1.003 A
	800-2	1.994 A		2.006 A
	800-4	3.936 A		4.064 A
Measurement accuracy	800-1	0.997 A		1.003 A
	800-2	1.994 A		2.006 A
	800-4	3.936 A		4.064 A

<b>CC load regulation</b>	<b>Model</b>	<b>Minimum specifications</b>	<b>Results</b>	<b>Maximum specifications</b>
	800-1	-6.00 mA		+6.00 mA
	800-2	-7.00 mA		+7.00 mA
	800-4	-9.00 mA		+9.00 mA

<b>CC line regulation</b>	<b>Model</b>	<b>Minimum specifications</b>	<b>Results</b>	<b>Maximum specifications</b>
	800-1	-6.00 mA		+6.00 mA
	800-2	-7.00 mA		+7.00 mA
	800-4	-9.00 mA		+9.00 mA

## 2260B Adjustment equipment

### In this section:

Adjustment equipment ..... 6-1

### Adjustment equipment

Here is a list of the recommended equipment used for calibrating the programmable DC power supplies:

Type	Specifications	Recommended instrument
Precision current shunt	3 A (0.1 $\Omega$ ) 0.01% TC = 3 ppm / °C 30 A (0.01 $\Omega$ ) 0.01% TC = 10 ppm / °C 300 A (0.001 $\Omega$ ) 0.02% TC = 10 ppm / °C	GW Instek PCS-1000 or equivalent
Electronic loads	80 V, 280 A minimum with transient capability and a slew rate of 2.8 A/ $\mu$ s or better. 500 V, 40 A minimum with transient capability and a slew rate of 0.4 A/ $\mu$ s or better. 850 V, 40 A minimum with transient capability and a slew rate of 0.4 A/ $\mu$ s or better.	Various manufacturers of programmable DC electronic loads
DC power supply	Voltage resolution: 1 mV Accuracy: <0.05% mV of reading	Keithley programmable dual-channel DC power supply 2220-30-01
Digital multimeter	Voltage resolution: 0.1 mV Accuracy: <0.01% mV of reading	Keithley DMM 7510 or equivalent



---

## Analog interface adjustment

### In this section:

---

Remove top cover.....	7-1
Confirm location of adjustment points .....	7-2
Analog interface adjustment procedure.....	7-3

### Remove top cover

#### **WARNING**

*Hazardous voltages may be present on all output and guard terminals. To prevent electrical shock that could cause injury or death, never make or break connections to any of the instruments used for this adjustment while instruments are powered on. Turn off all of the instruments from the front panel or disconnect the main power cord from the rear of the instrument before handling cables. Putting the equipment into an output-off state does not guarantee that the outputs are powered off if a hardware or software fault occurs. Precautions must be taken to prevent a shock hazard by surrounding the test device and any unprotected leads (wiring) with double insulation for up to 800 volts depending on the power supply that you have, Category I.*

Before you can make adjustments on the instrument, you will need to remove the 2260B top cover.

On the 360 watt models (2260B-30-36, 2260B-80-13, 2260B-250-4, and 2260B-800-01), note that there are nine screws that you will need to remove in order to remove the top cover (see next figure).

## NOTE

The next figure only shows seven screws.

On the 720 watt models (2260B-30-72, 2260B-80-27, 2260B-250-9, 2260B-800-2), there are ten screws that you will need to remove.

On the 1080 watt models (2260B-30-108, 2260B-80-40, 2260B-250-13, 2260B-800-4), there are eleven screws that you will need to remove.

**Figure 9: 2260B Top cover**

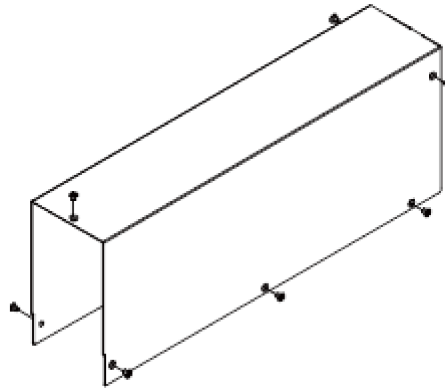

## Confirm location of adjustment points

The location of the adjustment points on the 2260B circuit board (VR400 and VR401) are shown in the next figure:

**Figure 10: 2260B circuit board**

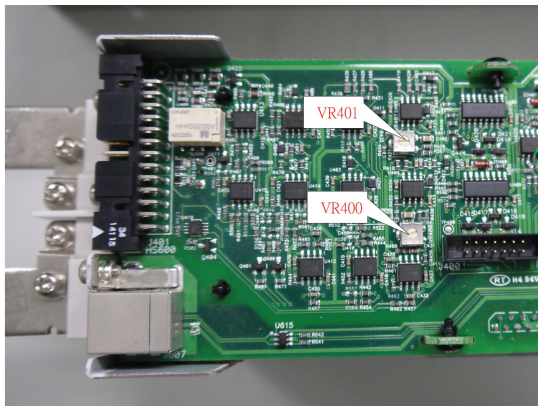

Make sure that you connect the following devices as indicated in the next figure. Also, make sure that you set the Model 2220-30-1 DC power supply, channel one and channel two to 10.00 V.

**Figure 11: Analog adjustment devices**

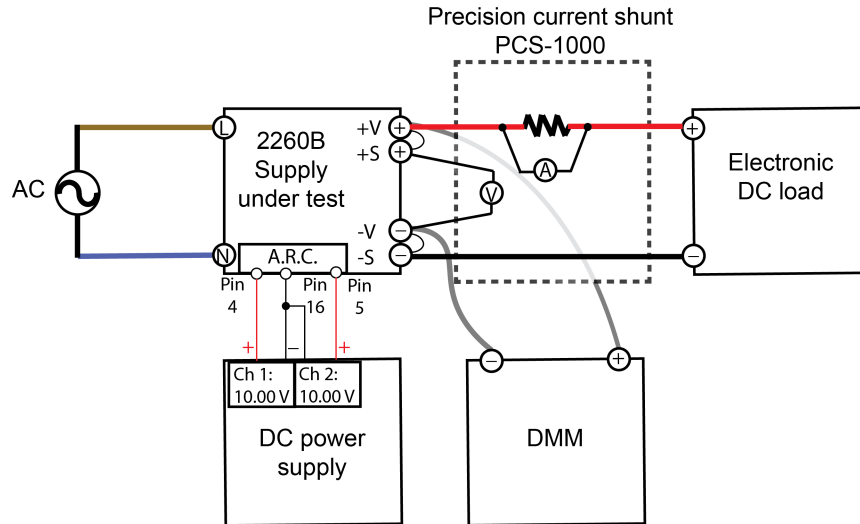

## Analog interface adjustment procedure

*To start the adjustment procedure:*

1. Turn on the programmable DC power supply (Series 2260B) by pressing the Function key.

### NOTE

The Function key lights up, the display indicates "F - 01." Additionally, note that the "x" in the diagram below indicates that the value is not fixed.

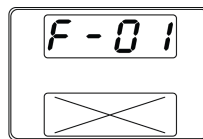

2. Rotate the Voltage knob until the display indicates "F - 00".



3. Press the Current knob to select the numeric indicator.

4. Use the Current knob to select the appropriate password for the model that you are calibrating. Here's the list of models and passwords:

Model number	Password
2260B-30-36	3036
2260B-30-72	3072
2260B-30-108	3010
2260B-80-13	8013
2260B-80-27	8027
2260B-80-40	8040
2260B-250-4	2545
2260B-250-9	2509
2260B-250-13	2515
2260B-800-1	8014
2260B-800-2	8028
2260B-800-4	8043

5. Press the Current knob to enter the password (note that the highlighted numeral is the one that you are changing).
6. Once the number needed is highlighted, press the Current knob to move to the next numeric position.
7. Press the Voltage knob to enter the password.

## NOTE

The display will indicate "C000".



8. Turn on the external power supply (the 2220-30-01) and set the output to 10.000 V  $\pm$ 0.001 V, for both channel 1 and 2.
9. Press the Voltage knob to prepare to execute the external output voltage adjustment (C010).

## NOTE

Make sure that the DC electronic load instrument is turned off.



10. Press the Voltage knob (C011 is displayed); the 2260B instrument Output button illuminates and CV is displayed.

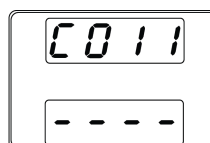

**NOTE**

Make sure that the reading on the DMM is within the specified voltage range. If not, adjust the voltage resistor (VR401) on the 2260B instrument (see [Confirm location of adjustment points](#) (on page 7-2)).

Here's the list of models with adjustment ranges for point VR401:

Model number	minimum volts	maximum volts
2260B-30-36	29.994	30.006
2260B-30-72	29.994	30.006
2260B-30-108	29.994	30.006
2260B-80-13	79.984	80.016
2260B-80-27	79.984	80.016
2260B-80-40	79.984	80.016
2260B-250-4	249.950	250.050
2260B-250-9	249.950	250.050
2260B-250-13	249.950	250.050
2260B-800-1	799.840	800.160
2260B-800-2	799.840	800.160
2260B-800-4	799.840	800.160

11. Press the Voltage knob to return to external voltage adjustment (C010).

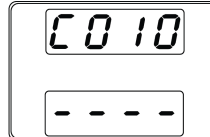

12. Rotate the Voltage knob until it indicates C020, in order to prepare to execute the external output current adjustment.

**NOTE**

Make sure that the load key and short key on the DC electronic load instrument are turned on.

13. Press the Voltage knob (C021 is displayed); the 2260B Output button illuminates and CC is displayed.

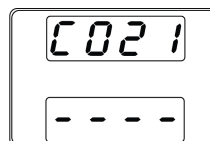

## NOTE

Make sure that the reading on the PCS-1000 current meter is within the specified current range. If not, adjust the current resistor (VR400) on the 2260B instrument (see [Confirm location of adjustment points](#) (on page 7-2)).

Here's the list of models with adjustment ranges for point VR401:

Model number	minimum current	maximum current
2260B-30-36	35.9928	36.0072
2260B-30-72	71.9856	72.0144
2260B-30-108	107.9784	108.0216
2260B-80-13	13.4973	13.5027
2260B-80-27	26.9946	27.0054
2260B-80-40	40.4919	40.5081
2260B-250-4	4.4991	4.5009
2260B-250-9	8.9982	9.0018
2260B-250-13	13.4973	13.5027
2260B-800-1	1.4397	1.4403
2260B-800-2	2.8794	2.8806
2260B-800-4	4.3191	4.3209

14. Press the Voltage knob to return to the external current adjustment (C020).

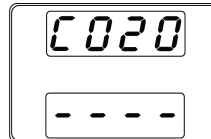

15. Rotate the Voltage knob to exit the external current adjustment display (C030 is displayed).

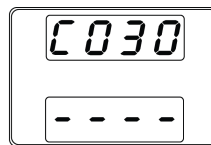

16. Press the Voltage knob to return to the main adjustment display.



17. Rotate the Current knob to exit adjustment mode (C000:2).

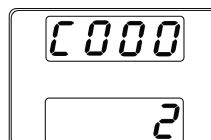

18. Press the Voltage knob to exit adjustment mode.

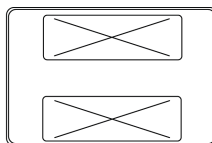

## NOTE

The "x" in the diagram above indicates that the value is not fixed.

19. Turn off the 2600B instrument and put the top cover back on.

Analog interface adjustment is complete.

## Constant voltage adjustment

### In this section:

Connect device equipment.....	8-1
Constant voltage adjustment procedure.....	8-2

### Connect device equipment

#### ⚠ WARNING

*Hazardous voltages may be present on all output and guard terminals. To prevent electrical shock that could cause injury or death, never make or break connections to any of the instruments used for this adjustment while instruments are powered on. Turn off all of the instruments from the front panel or disconnect the main power cord from the rear of the instrument before handling cables. Putting the equipment into an output-off state does not guarantee that the outputs are powered off if a hardware or software fault occurs. Precautions must be taken to prevent a shock hazard by surrounding the test device and any unprotected leads (wiring) with double insulation for up to 800 volts depending on the power supply that you have, Category I.*

Make sure that you connect the following devices as indicated in the next figure.

**Figure 12: 2260B Constant voltage adjustment devices**

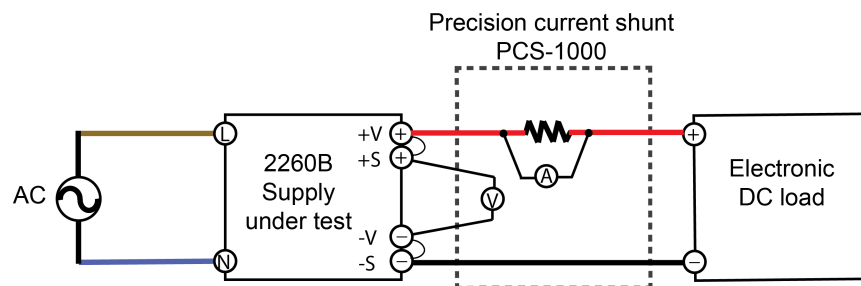



## Constant voltage (CV) adjustment procedure

*To start the adjustment procedure:*

1. Turn on the programmable DC power supply (Series 2260B) by pressing the Function key.

### NOTE

The function key lights up, the display indicates "F - 01." Additionally, note that the "x" in the diagram below indicates that the value is not fixed.

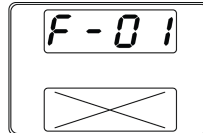

2. Rotate the voltage knob until it indicates "F - 00".



3. Use the Current knob to select the appropriate password for the model that you are calibrating. Here's the list of models and passwords:

Model number	Password
2260B-30-36	3036
2260B-30-72	3072
2260B-30-108	3010
2260B-80-13	8013
2260B-80-27	8027
2260B-80-40	8040
2260B-250-4	2545
2260B-250-9	2509
2260B-250-13	2515
2260B-800-1	8014
2260B-800-2	8028
2260B-800-4	8043

4. Press the voltage knob to enter the password.

### NOTE

The display will indicate "C000".

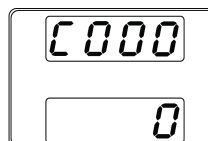

- Use the current knob to enter "constant voltage" adjustment mode. To enter adjustment mode, rotate the current knob until "1" is displayed on the bottom display (C000:1).

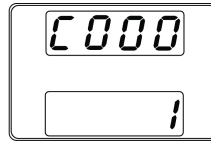

- Press the voltage knob to enter voltage adjustment (C110).

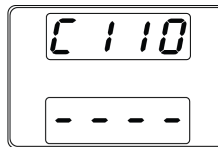

- Press the voltage knob two times to enter the voltage offset adjustment (C111).

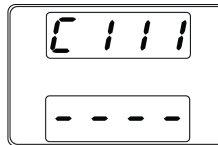

- Press the voltage knob to set the offset voltage value (C112).

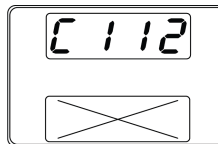

## NOTE

The "x" in the diagram above indicates that the value is not fixed.

- Rotate the current knob to set the offset value on the 2260B display so that it is the same as the reading on the PCS-1000 voltmeter.
- Press the voltage knob to enter the output voltage middle adjustment (C113).

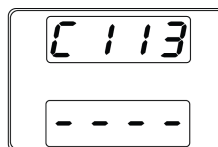

- Press the voltage knob to set the middle voltage value.

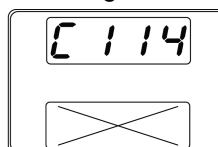

**NOTE**

The "x" in the diagram above indicates that the value is not fixed.

- 12. Rotate the current knob to set the middle voltage value on the 2260B display so that it is the same as the reading on the PCS-1000 voltmeter.
- 13. Press the voltage knob to enter the output voltage full-scale adjustment (C115).

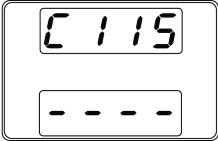

- 14. Press the voltage knob to set the full-scale voltage value (C116).

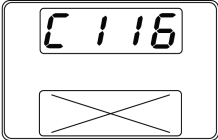

**NOTE**

The "x" in the diagram above indicates that the value is not fixed.

- 15. Rotate the current knob to set the full-scale voltage value on the 2260B display so that it is the same as the reading on the PCS-1000 voltmeter.
- 16. Press the voltage knob to enter the OVP (overvoltage protection) adjustment (C117).

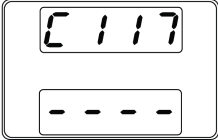

- 17. Press the voltage knob to start the automatic OVP adjustment (C118).

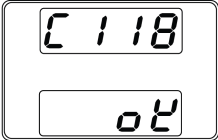

**NOTE**

The display will indicate "OK" when the adjustment is complete for approximately five seconds. Additionally, the output turns on and the CV indicator is lit. Also, the instrument automatically returns to C110 after the automatic OVP adjustment ends.

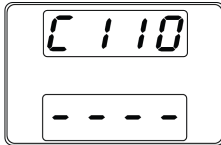

18. Rotate the voltage knob to go to save mode (C130).

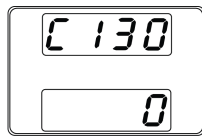

19. Rotate the current knob until "1" is shown on the bottom display (C130:1)

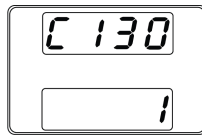

20. Press the voltage knob to save the adjustment results.

**NOTE**

The display will indicate "OK" and the instrument will automatically return to "C000" when the adjustment value is saved.

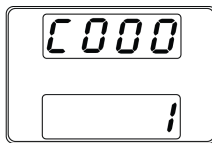

21. Rotate the current knob to go to "exit adjustment" mode (C000:2).

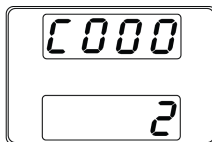

22. Press the voltage knob to exit adjustment mode.

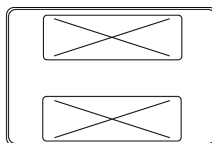

## NOTE

The "x" in the diagram above indicates that the value is not fixed.

Constant voltage adjustment is complete.

## Constant current adjustment

### In this section:

Connect device equipment.....	9-1
Constant current adjustment procedure .....	9-2

### Connect device equipment

#### ⚠ WARNING

*Hazardous voltages may be present on all output and guard terminals. To prevent electrical shock that could cause injury or death, never make or break connections to any of the instruments used for this adjustment while instruments are powered on. Turn off all of the instruments from the front panel or disconnect the main power cord from the rear of the instrument before handling cables. Putting the equipment into an output-off state does not guarantee that the outputs are powered off if a hardware or software fault occurs. Precautions must be taken to prevent a shock hazard by surrounding the test device and any unprotected leads (wiring) with double insulation for up to 800 volts depending on the power supply that you have, Category I.*

Make sure that you connect the following devices as indicated in the next figure.

**Figure 13: Constant current adjustment devices**

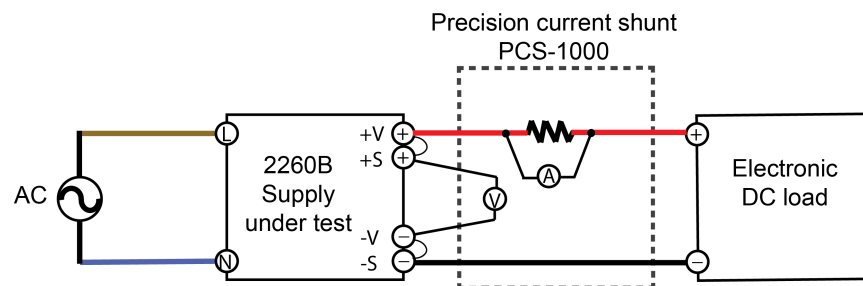

## Constant current (CC) adjustment procedure

*To start the adjustment procedure:*

1. Turn on the programmable DC power supply (Series 2260B) by pressing the Function key.

### NOTE

The function key lights up, the display indicates "F - 01." Additionally, note that the "x" in the diagram below indicates that the value is not fixed.

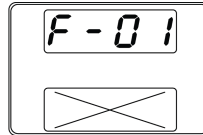

2. Rotate the voltage knob until it indicates "F - 00".



3. Use the Current knob to select the appropriate password for the model that you are calibrating. Here's the list of models and passwords:

Model number	Password
2260B-30-36	3036
2260B-30-72	3072
2260B-30-108	3010
2260B-80-13	8013
2260B-80-27	8027
2260B-80-40	8040
2260B-250-4	2545
2260B-250-9	2509
2260B-250-13	2515
2260B-800-1	8014
2260B-800-2	8028
2260B-800-4	8043

4. Press the voltage knob to enter analog interface adjustment.

### NOTE

The display will indicate "C000" when completed.



- Use the current knob to enter "constant voltage" adjustment mode. To enter the adjustment mode, rotate the current knob until "1" is displayed on the bottom display (C000:1).

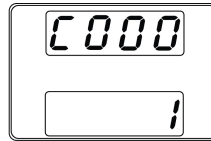

- Press the voltage knob to enter voltage adjustment (C110).

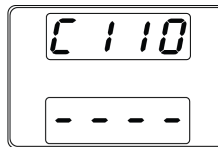

- Rotate the voltage knob to go to current adjustment (C120).

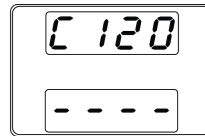

- Press the voltage knob to enter the output current offset adjustment (C121).

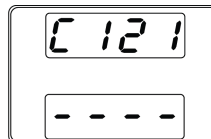

- Press the voltage knob to set the offset value.

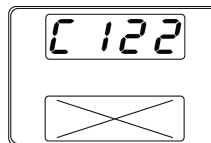

## NOTE

The "x" in the diagram above indicates that the value is not fixed.

- Rotate the current knob to set the offset value on the 2260B display so that it is the same as the reading on the PCS-1000 current meter.
- Press the voltage knob to enter the output current half-scale adjustment (C123).

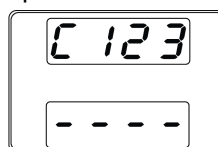



12. Press the voltage knob to set the half-scale current value (C124).

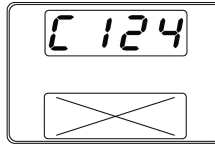

### NOTE

The "x" in the diagram above indicates that the value is not fixed.

13. Rotate the current knob to set the half-scale current value on the 2260B display so that it is the same as the reading on the PCS-1000 current meter.
14. Press the voltage knob to enter the output current full-scale adjustment (C125).

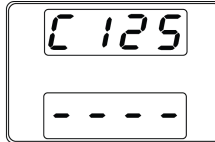

15. Press the voltage knob to set the full-scale value (C126).

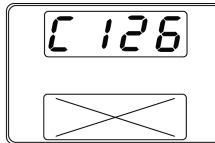

### NOTE

The "x" in the diagram above indicates that the value is not fixed.

1. Rotate the current knob to set the full-scale value on the 2260B display so that it is the same as the reading on the PCS-1000 current meter.
2. Press the voltage knob to enter the OCP (overcurrent protection) adjustment (C127).

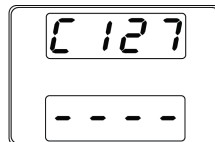

3. Press the voltage knob to start the automatic OCP adjustment (C128).

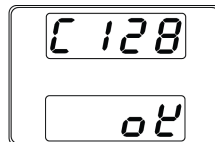

**NOTE**

The display will indicate "OK" when the adjustment is complete. Additionally, the output turns on and the CC indicator is lit. Also, the instrument automatically returns to C120 after the automatic OCP adjustment ends.

- 4. Rotate the voltage knob to go to save mode (C130).

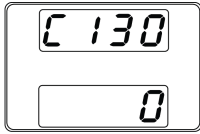

- 5. Rotate the current knob until "1" is shown on the bottom display (C130:1)

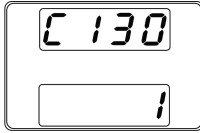

- 6. Press the voltage knob to save the adjustment results.

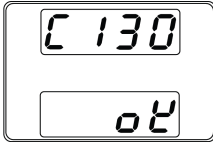

**NOTE**

The display will indicate "OK" and the instrument will automatically return to "C000" when the adjustment value is saved.

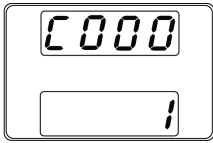

- 7. Rotate the current knob to go to "exit adjustment" mode (C000:2).

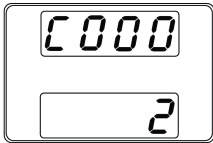

- 8. Press the voltage knob to exit adjustment mode.

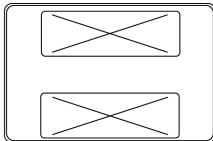

## NOTE

The "x" in the diagram above indicates that the value is not fixed.

Constant current adjustment is complete.

---

## Adjustment code glossary

### **In this section:**

---

Adjustment codes.....	10-2
-----------------------	------

## Adjustment codes

Voltage display	Current display	Description
F-01	X	Power applied; Function key lights up
F-00	0000	Enter adjustment mode
C000	0	Password entered; instrument ready for adjustment
C000	1	Enter constant voltage adjustment mode
C000	2	Exit adjustment mode
C010	----	Standby to execute external voltage adjustment
C011	----	Output button illuminates and CV is displayed
C020	----	Standby to execute external current adjustment
C021	----	Output button illuminates and CC is displayed
C030	----	Exit external current adjustment
C110	----	Enter voltage adjustment mode
C111	----	Standby adjustment offset voltage value
C112	X	Adjustment offset voltage value
C113	----	Standby adjustment half-scale voltage value
C114	X	Adjustment full-scale voltage value
C115	----	Standby adjustment full-scale voltage value
C116	X	Adjustment full-scale voltage value
C117	----	Standby OVP adjustment
C118	ok	OVP adjustment
C120	----	Enter current adjustment mode
C121	----	Standby adjustment half-scale current value
C122	X	Adjustment offset current value
C123	----	Standby adjustment half-scale current value
C124	X	Adjustment half-scale current value
C125	----	Adjustment full-scale current value
C126	X	Set the full-scale value
C127	----	Standby OCP adjustment
C128	ok	OCP adjustment
C130	0	Save mode
C130	1	Save adjustment results
C130	ok	Indicates adjustment results saved
X	X	Exit adjustment mode

### NOTE

The "x" in the previous table indicates that the value is not fixed.

---

# Index

## 2

2260B Adjustment equipment • 6-1  
250 Volt verification record • 5-6

## 3

30 Volt verification test record • 5-2

## 8

80 Volt verification test record • 5-4  
800 Volt verification record • 5-8

## A

Adjustment code glossary • 10-1  
Adjustment codes • 10-2  
Adjustment equipment • 6-1  
Analog interface adjustment • 7-1  
Analog interface adjustment procedure • 7-3

## C

Confirm location of adjustment points • 7-2, 7-5, 7-6  
Connect device equipment • 8-1, 9-1  
Constant current adjustment • 9-1  
Constant current adjustment procedure • 9-2  
Constant current line regulation verification • 4-4  
Constant current load regulation verification • 4-3  
Constant current noise verification • 4-6  
Constant current verification • 4-1  
Constant current verification tests • 4-1  
Constant voltage (CV) verification tests • 3-1  
Constant voltage adjustment • 8-1  
Constant voltage adjustment procedure • 8-2  
Constant voltage line regulation verification • 3-3  
Constant voltage load regulation verification • 3-2  
Constant voltage ripple and noise verification • 3-5  
Constant voltage verification • 3-1  
Contact information • 1-1, 2-1  
Current programming and measurement accuracy verification • 4-1

## E

Extended warranty • 1-1

## I

Introduction • 1-1

## R

Remove top cover • 7-1

## S

Series 2260B available models • 1-2, 3-2, 3-3, 3-4,  
3-6, 4-2, 4-5, 4-6

## V

Verification equipment • 2-2  
Verification information • 2-1  
Verification preparation • 2-1  
Verification test record forms • 3-2, 3-3, 3-4, 3-6, 4-2,  
4-3, 4-5, 4-6, 5-1  
Voltage programming and measurement accuracy  
verification • 3-1

## W

Welcome • 1-1

Specifications are subject to change without notice.  
All Keithley trademarks and trade names are the property of Keithley Instruments.  
All other trademarks and trade names are the property of their respective companies.

Keithley Instruments  
Corporate Headquarters • 28775 Aurora Road • Cleveland, Ohio 44139 • 440-248-0400 • Fax: 440-248-6168 • 1-800-935-5595 • [www.tek.com/keithley](http://www.tek.com/keithley)

---



A Greater Measure of Confidence